

Series 2280 Precision Measurement DC Power Supplies

Reference Manual

077085503 / March 2019



077085503

Series 2280
Precision DC Power Supply
Reference Manual

© 2019, Keithley Instruments, LLC

Cleveland, Ohio, U.S.A.

All rights reserved.

Any unauthorized reproduction, photocopy, or use of the information herein, in whole or in part, without the prior written approval of Keithley Instruments, LLC, is strictly prohibited.

These are the original instructions in English.

All Keithley Instruments product names are trademarks or registered trademarks of Keithley Instruments, LLC. Other brand names are trademarks or registered trademarks of their respective holders.

Microsoft, Visual C++, Excel, and Windows are either registered trademarks or trademarks of Microsoft Corporation in the United States and/or other countries.

Document number: 077085503 / March 2019

The following safety precautions should be observed before using this product and any associated instrumentation. Although some instruments and accessories would normally be used with nonhazardous voltages, there are situations where hazardous conditions may be present.

This product is intended for use by personnel who recognize shock hazards and are familiar with the safety precautions required to avoid possible injury. Read and follow all installation, operation, and maintenance information carefully before using the product. Refer to the user documentation for complete product specifications.

If the product is used in a manner not specified, the protection provided by the product warranty may be impaired.

The types of product users are:

Responsible body is the individual or group responsible for the use and maintenance of equipment, for ensuring that the equipment is operated within its specifications and operating limits, and for ensuring that operators are adequately trained.

Operators use the product for its intended function. They must be trained in electrical safety procedures and proper use of the instrument. They must be protected from electric shock and contact with hazardous live circuits.

Maintenance personnel perform routine procedures on the product to keep it operating properly, for example, setting the line voltage or replacing consumable materials. Maintenance procedures are described in the user documentation. The procedures explicitly state if the operator may perform them. Otherwise, they should be performed only by service personnel.

Service personnel are trained to work on live circuits, perform safe installations, and repair products. Only properly trained service personnel may perform installation and service procedures.

Keithley products are designed for use with electrical signals that are measurement, control, and data I/O connections, with low transient overvoltages, and must not be directly connected to mains voltage or to voltage sources with high transient overvoltages. Measurement Category II (as referenced in IEC 60664) connections require protection for high transient overvoltages often associated with local AC mains connections. Certain Keithley measuring instruments may be connected to mains. These instruments will be marked as category II or higher.

Unless explicitly allowed in the specifications, operating manual, and instrument labels, do not connect any instrument to mains.

Exercise extreme caution when a shock hazard is present. Lethal voltage may be present on cable connector jacks or test fixtures. The American National Standards Institute (ANSI) states that a shock hazard exists when voltage levels greater than 30 V RMS, 42.4 V peak, or 60 VDC are present. A good safety practice is to expect that hazardous voltage is present in any unknown circuit before measuring.

Operators of this product must be protected from electric shock at all times. The responsible body must ensure that operators are prevented access and/or insulated from every connection point. In some cases, connections must be exposed to potential human contact. Product operators in these circumstances must be trained to protect themselves from the risk of electric shock. If the circuit is capable of operating at or above 1000 V, no conductive part of the circuit may be exposed.

Do not connect switching cards directly to unlimited power circuits. They are intended to be used with impedance-limited sources. NEVER connect switching cards directly to AC mains. When connecting sources to switching cards, install protective devices to limit fault current and voltage to the card.

Before operating an instrument, ensure that the line cord is connected to a properly-grounded power receptacle. Inspect the connecting cables, test leads, and jumpers for possible wear, cracks, or breaks before each use.

When installing equipment where access to the main power cord is restricted, such as rack mounting, a separate main input power disconnect device must be provided in close proximity to the equipment and within easy reach of the operator.

For maximum safety, do not touch the product, test cables, or any other instruments while power is applied to the circuit under test. ALWAYS remove power from the entire test system and discharge any capacitors before: connecting or disconnecting cables or jumpers, installing or removing switching cards, or making internal changes, such as installing or removing jumpers.

Do not touch any object that could provide a current path to the common side of the circuit under test or power line (earth) ground. Always make measurements with dry hands while standing on a dry, insulated surface capable of withstanding the voltage being measured.

For safety, instruments and accessories must be used in accordance with the operating instructions. If the instruments or accessories are used in a manner not specified in the operating instructions, the protection provided by the equipment may be impaired.

Do not exceed the maximum signal levels of the instruments and accessories. Maximum signal levels are defined in the specifications and operating information and shown on the instrument panels, test fixture panels, and switching cards.

When fuses are used in a product, replace with the same type and rating for continued protection against fire hazard.

Chassis connections must only be used as shield connections for measuring circuits, NOT as protective earth (safety ground) connections.

If you are using a test fixture, keep the lid closed while power is applied to the device under test. Safe operation requires the use of a lid interlock.

If a  screw is present, connect it to protective earth (safety ground) using the wire recommended in the user documentation.

The  symbol on an instrument means caution, risk of hazard. The user must refer to the operating instructions located in the user documentation in all cases where the symbol is marked on the instrument.

The  symbol on an instrument means warning, risk of electric shock. Use standard safety precautions to avoid personal contact with these voltages.

The  symbol on an instrument shows that the surface may be hot. Avoid personal contact to prevent burns.

The  symbol indicates a connection terminal to the equipment frame.

If this  symbol is on a product, it indicates that mercury is present in the display lamp. Please note that the lamp must be properly disposed of according to federal, state, and local laws.

The **WARNING** heading in the user documentation explains hazards that might result in personal injury or death. Always read the associated information very carefully before performing the indicated procedure.

The **CAUTION** heading in the user documentation explains hazards that could damage the instrument. Such damage may invalidate the warranty.

The **CAUTION** heading with the  symbol in the user documentation explains hazards that could result in moderate or minor injury or damage the instrument. Always read the associated information very carefully before performing the indicated procedure. Damage to the instrument may invalidate the warranty.

Instrumentation and accessories shall not be connected to humans.

Before performing any maintenance, disconnect the line cord and all test cables.

To maintain protection from electric shock and fire, replacement components in mains circuits — including the power transformer, test leads, and input jacks — must be purchased from Keithley. Standard fuses with applicable national safety approvals may be used if the rating and type are the same. The detachable mains power cord provided with the instrument may only be replaced with a similarly rated power cord. Other components that are not safety-related may be purchased from other suppliers as long as they are equivalent to the original component (note that selected parts should be purchased only through Keithley to maintain accuracy and functionality of the product). If you are unsure about the applicability of a replacement component, call a Keithley office for information.

Unless otherwise noted in product-specific literature, Keithley instruments are designed to operate indoors only, in the following environment: Altitude at or below 2,000 m (6,562 ft); temperature 0 °C to 50 °C (32 °F to 122 °F); and pollution degree 1 or 2.

To clean an instrument, use a cloth dampened with deionized water or mild, water-based cleaner. Clean the exterior of the instrument only. Do not apply cleaner directly to the instrument or allow liquids to enter or spill on the instrument. Products that consist of a circuit board with no case or chassis (e.g., a data acquisition board for installation into a computer) should never require cleaning if handled according to instructions. If the board becomes contaminated and operation is affected, the board should be returned to the factory for proper cleaning/servicing.

Safety precaution revision as of June 2017.

Table of contents

Introduction	1-1
Welcome	1-1
Extended warranty	1-1
Contact information	1-1
Product documentation and drivers	1-2
Organization of manual sections	1-2
Key features	1-3
Standard accessories	1-4
Optional accessories	1-4
Available services	1-5
General ratings	1-5
General operation	2-1
Front-panel overview	2-1
Rear-panel overview	2-3
Front-panel user interface	2-4
Home screen	2-4
Menu overview	2-14
Adjusting the backlight brightness and timer	2-27
Installing the system	2-28
Bumpers	2-28
Dimensions	2-29
Power the instrument on and off	2-34
Test connections	2-37
Front-panel connector	2-38
Rear-panel output mating connector	2-39
Two-wire local sense connection	2-39
Four-wire sense connection	2-40
Open leads detection	2-42
Reversed sense leads	2-43
Remote communications interfaces	2-44
Supported remote interfaces	2-45
GPIB communications	2-45
LAN communications	2-48
USB communications	2-64
How to install the Keithley I/O Layer	2-70
Set voltage and current limit	2-71
Constant voltage (CV) and constant current (CC) mode	2-72
Select a measurement function	2-74
Select a specific measurement range	2-75
Selecting a specific measurement range	2-75
Using autoranging for current measurements	2-77
Protection	2-78

Overvoltage protection	2-78
Overcurrent protection	2-79
Overtemperature protection	2-80
Overprotection error	2-81
Maximum voltage limits	2-82
Saving setups	2-83
Save a user setup	2-83
Recall a user setup	2-84
Specify a default setup	2-85
Using the event log	2-85
Information provided for each event log entry	2-85
Save the event log to an external flash drive	2-86
Clear the event log	2-86
System information	2-86
Instrument sounds	2-87
Resets	2-87
Reset the instrument	2-88
Reset default values	2-88

Functions and features..... 3-1

Instrument access	3-1
Changing the instrument access mode	3-1
Changing the password	3-2
Graph	3-2
Changing the window position and zoom	3-3
Adjusting the scale and offset of the Y-axis	3-4
Output delay, slew rate, and source delay	3-5
Output delay	3-6
Slew rate	3-6
Source delay	3-7
Data buffer	3-8
Effects of reset and power cycle on buffer	3-8
Buffer fill status	3-9
Setting reading buffer size and buffer mode	3-9
Viewing and saving buffer content	3-12
Clearing the buffer	3-18
Digital I/O	3-19
Digital I/O port	3-19
Configuring digital I/O lines	3-23
Trigger model	3-25
Idle and initiate	3-26
Arm layer	3-26
Trigger layer	3-26
Source, source delay, and measure actions	3-27
Counter	3-27
Meter complete	3-27
Running the trigger model	3-28
Level trigger	3-30
Configuring a voltage level trigger	3-30
Configuring a current level trigger	3-32

List operation.....	3-34
Configuring a list	3-35
Importing a list from an external USB flash drive	3-37
Exporting a list to an external USB flash drive	3-38
Configuring and running a list.....	3-38
Aborting a list	3-49
Sink operation	3-50
Measurement optimization	4-1
Introduction	4-1
Optimizing either measurement accuracy or speed	4-1
Resolution	4-2
NPLC	4-3
Autozero measurements	4-5
Displayed digits	4-6
Filtering measurement data.....	4-7
Math calculations that you can apply to measurements	4-11
mx+b	4-11
Setting mx+b math operations	4-12
Relative offset	4-13
Establishing a relative offset value	4-13
Displayed measurements.....	4-15
Select the source of readings.....	4-17
Application examples	5-1
Simple voltage output and current measurement	5-1
Equipment required.....	5-1
Set up remote communications.....	5-1
Device connections	5-2
Set the voltage and current limit.....	5-2
Configure and execute a 10-step linear list sweep	5-4
Equipment required.....	5-4
Set up remote communications.....	5-4
Device connections	5-4
Configure a 10-step linear list sweep	5-5
Execute a 10-step linear list sweep	5-6
Perform a fast current load measurement	5-7
Equipment required.....	5-7
Set up remote communications.....	5-7
Device connections	5-8
Measure the fast current load changes	5-10
Introduction to SCPI commands	6-1
Introduction to SCPI	6-1
Command messages	6-1
Command execution rules.....	6-2
SCPI command programming notes	6-2
SCPI command formatting	6-2
Using the SCPI command reference.....	6-5

SCPI command reference	7-1
Common commands.....	7-1
*CLS.....	7-2
*ESE.....	7-3
*ESR?.....	7-4
*IDN?.....	7-4
*OPC.....	7-5
*LANG?.....	7-6
*RCL.....	7-6
*RST.....	7-7
*SAV.....	7-7
*SRE.....	7-8
*STB?.....	7-8
*TRG.....	7-9
*TST?.....	7-10
*WAI.....	7-10
:ABORt[n].....	7-11
:CONFigure[n]:<function>.....	7-12
:FETCh[n]?.....	7-13
:FORMat:ELEMents.....	7-14
:FORCe:TRIGger.....	7-15
:MEASure[n]:<function>?.....	7-16
:READ[n]?.....	7-18
ARM subsystem.....	7-19
:ARM[:SEQuence[n]]:COUNT.....	7-19
:ARM[:SEQuence[n]]:SOURce.....	7-20
CALCulate subsystem.....	7-21
:CALCulate[1]:<function>:FORMat.....	7-21
:CALCulate[1]:<function>:KMATH:MBFactor.....	7-22
:CALCulate[1]:<function>:KMATH:MMFactor.....	7-23
:CALCulate[1]:<function>:KMATH:MUNits.....	7-25
:CALCulate[1]:<function>:STATe.....	7-26
:CALCulate2:DATA?.....	7-27
:CALCulate2:FORMat.....	7-28
:CALCulate2:FORMat:ELEMents.....	7-30
:CALCulate2:FUNction.....	7-31
:CALCulate2:IMMediate.....	7-32
:CALCulate2:STATe.....	7-34
CALibration subsystem.....	7-35
:CALibration:PROTeCted:CANCel.....	7-35
:CALibration:PROTeCted:CODE.....	7-36
:CALibration:PROTeCted:COUNT?.....	7-36
:CALibration:PROTeCted:DATA?.....	7-37
:CALibration:PROTeCted:DATE.....	7-38
:CALibration:PROTeCted[:DC[n]]:STEP<step>.....	7-39
:CALibration:PROTeCted[:DC[n]]:STEP<step>:DATA.....	7-41
:CALibration:PROTeCted:SAVE.....	7-43
:CALibration:PROTeCted:STATe.....	7-44
Digital subsystem.....	7-45
:DIGital:LINE<n>:FUNction.....	7-45
:DIGital:LINE<n>:MANual:INPut:DATA?.....	7-46
DISPlay subsystem.....	7-47
:DISPlay:BRIGhtness.....	7-47
:DISPlay:CLEAr.....	7-48

:DISPlay:SCREen	7-49
:DISPlay:USER:TEXT[:DATA].....	7-50
INITiate subsystem	7-51
:INITiate[n]:CONTinuous	7-51
:INITiate[n][:IMMediate].....	7-52
MMEMory subsystem.....	7-52
:MMEMory:LOAD:SETup	7-52
:MMEMory:SAVE:SETup	7-53
OUTPut subsystem	7-54
:OUTPut:DELAy:FALLing	7-54
:OUTPut:DELAy:RISing.....	7-55
:OUTPut:DELAy:STATe	7-56
:OUTPut:PROTEction:CLEar.....	7-57
:OUTPut:PROTEction:TRIPped?[:<channel>].....	7-58
:OUTPut[:STATe].....	7-59
SENSe subsystem	7-60
:SENSe[n]:FUNCTion.....	7-60
:SENSe[n]:<function>:AVERAge:COUNT	7-61
:SENSe[n]:<function>:AVERAge[:STATe].....	7-62
:SENSe[n]:<function>:AVERAge:TCONtrol	7-63
:SENSe[n]:<function>:AVERAge:WINDow	7-64
:SENSe[n]:<function>:DIGits	7-65
:SENSe[n]:<function>:NPLCycles	7-66
:SENSe[n]:<function>:RANGE	7-67
:SENSe[n]:<function>:RANGE:AUTO	7-69
:SENSe[n]:<function>:REFerence.....	7-70
:SENSe[n]:<function>:REFerence:ACQuire.....	7-71
:SENSe[n]:<function>:REFerence:STATe	7-72
:SENSe[n]:<function>:RESolution.....	7-73
SOURce subsystem.....	7-74
[:SOURce[n]]:DELAy	7-74
[:SOURce[n]]:DELAy:STATe	7-75
[:SOURce[n]]:<function>:PROTEction[:LEVel]	7-76
[:SOURce[n]]:<function>[:LEVel][:IMMediate][:AMPLitude].....	7-77
[:SOURce[n]]:VOLTAge:LIMit[:AMPLitude]	7-78
[:SOURce[n]]:VOLTAge:SLEW:RISing	7-79
[:SOURce[n]]:VOLTAge:SLEW:FALLing	7-80
[:SOURce[n]]:LIST<listNumber>:<element>	7-81
[:SOURce[n]]:LIST<listNumber>:<element>:APPend	7-82
[:SOURce[n]]:LIST<listNumber>:<element>:POINts?	7-83
[:SOURce[n]]:LIST:END:ZERO	7-84
[:SOURce[n]]:LIST:HTIME.....	7-84
[:SOURce[n]]:LIST:LOAD:USB	7-85
[:SOURce[n]]:LIST:MCOMplete	7-86
[:SOURce[n]]:LIST:RCL	7-87
[:SOURce[n]]:LIST:SAVE:INTernal	7-90
[:SOURce[n]]:LIST:SAVE:USB.....	7-90
[:SOURce[n]]:LIST:STATe	7-91
STATus subsystem	7-95
:STATus:MEASurement[:EVENT]?	7-95
:STATus:MEASurement:ENABLE	7-95
:STATus:MEASurement:INSTrument[:EVENT]?	7-96
:STATus:MEASurement:INSTrument:ENABLE	7-97
:STATus:MEASurement:INSTrument:ISUMmary[:EVENT]?	7-98
:STATus:MEASurement:INSTrument:ISUMmary:ENABLE	7-99
:STATus:MEASurement:INSTrument:ISUMmary:CONDition?	7-100

:STATus:OPERation[:EVENT]?	7-100
:STATus:OPERation:ENABLE	7-101
:STATus:OPERation:INSTrument[:EVENT]?	7-101
:STATus:OPERation:INSTrument:ENABLE	7-102
:STATus:OPERation:INSTrument:ISUMmary[:EVENT]?	7-103
:STATus:OPERation:INSTrument:ISUMmary:ENABLE	7-104
:STATus:OPERation:INSTrument:ISUMmary:CONDition?	7-105
:STATus:PRESet	7-105
:STATus:QUEStionable[:EVENT]?	7-106
:STATus:QUEStionable:ENABLE	7-107
:STATus:QUEStionable:INSTrument[:EVENT]?	7-107
:STATus:QUEStionable:INSTrument:ENABLE	7-108
:STATus:QUEStionable:INSTrument:ISUMmary[:EVENT]?	7-109
:STATus:QUEStionable:INSTrument:ISUMmary:ENABLE	7-109
:STATus:QUEStionable:INSTrument:ISUMmary:CONDition?	7-110
SYSTem subsystem	7-111
:SYSTem:AZERo[n][:STATe]	7-111
:SYSTem:BEEPer:ERRor[:STATe]	7-112
:SYSTem:COMMunication:ABORT	7-113
:SYSTem:COMMunication:LAN:CONFigure	7-114
:SYSTem:COMMunication:LAN:MACaddress?	7-115
:SYSTem:DATE	7-115
:SYSTem:ERRor?	7-116
:SYSTem:ERRor:CLEar	7-116
:SYSTem:ERRor:CODE?	7-117
:SYSTem:ERRor:COUNT?	7-117
:SYSTem:EVENTlog:SAVE	7-118
:SYSTem:GPIB:ADDRess	7-118
:SYSTem:KCLick	7-119
:SYSTem:LOCal	7-120
:SYSTem:LFRequency?	7-121
:SYSTem:PASSword:LOCK	7-121
:SYSTem:PASSword:MODE	7-122
:SYSTem:PASSword:NEW	7-122
:SYSTem:PASSword:UNLock	7-123
:SYSTem:POSetup:STATe	7-124
:SYSTem:PRESet	7-124
:SYSTem:RWLock	7-125
:SYSTem:TIME	7-126
:SYSTem:VERSIon?	7-126
TRACe subsystem	7-127
:DATA[n]:CLEar	7-127
:DATA[n]:CLEar:AUTO	7-127
:DATA[n]:DATA?	7-128
:DATA[n]:DATA:SELected?	7-130
:DATA[n]:FEED	7-132
:DATA[n]:FEED:CONTRol	7-133
:DATA[n]:POINts	7-134
:DATA[n]:POINts:ACTual?	7-134
:TRACe[n]:CLEar	7-135
:TRACe[n]:CLEar:AUTO	7-135
:TRACe[n]:DATA?	7-136
:TRACe[n]:DATA:SELected?	7-138
:TRACe[n]:FEED	7-140
:TRACe[n]:FEED:CONTRol	7-141
:TRACe[n]:POINts	7-142
:TRACe[n]:POINts:ACTual?	7-142
:TRACe[n]:SAVE	7-143
:TRACe[n]:TRIGger:CURRent:DIRection	7-144

:TRACe[n]:TRIGger:CURREnt[:LEVel]	7-144
:TRACe[n]:TRIGger:CURREnt:STATe	7-145
:TRACe[n]:TRIGger:OCCur?	7-146
:TRACe[n]:TRIGger:OFFSet	7-146
:TRACe[n]:TRIGger:VOLTage:DIRectIon	7-147
:TRACe[n]:TRIGger:VOLTage[:LEVel]	7-147
:TRACe[n]:TRIGger:VOLTage:STATe	7-148
TRIGger subsystem	7-149
:TRIGger[:SEQuence[n]]:COUNT	7-149
:TRIGger[:SEQuence[n]]:SAMPle:COUNT	7-150
:TRIGger[:SEQuence[n]]:SOURce	7-151
Troubleshooting guide	8-1
Introduction	8-1
Contacting support	8-1
What to do if the power supply does not turn on	8-2
LAN troubleshooting suggestions	8-3
Error summary	8-4
Next steps	9-1
Additional Series 2280 information	9-1
Maintenance	A-1
Introduction	A-1
Line fuse replacement	A-1
Upgrading the firmware	A-2
From the front panel	A-3
Perform DIN VDE 701 test	A-4
Cleaning the front-panel display	A-4
Verification	B-1
Overview	B-1
Test record	B-2
DC voltage setting accuracy with remote sense	B-3
DC voltage setting accuracy without remote sense	B-4
DC voltage readback accuracy with remote sense	B-5
DC voltage readback accuracy without remote sense	B-6
DC voltage load regulation	B-7
DC overvoltage protection	B-8
DC current accuracy	B-9
DC current readback accuracy	B-10
DC voltage line regulation	B-13
DC current line regulation	B-14
DC current load regulation	B-14
DC overcurrent protection	B-15
Voltage noise at 20 MHz	B-16

Current noise at 20 MHz, 1 Ω load	B-16
Performance verification procedures	B-17
Performance verification conditions	B-17
Required equipment.....	B-18
Check DC voltage setting readback accuracy with remote sense.....	B-18
Check DC voltage setting accuracy with remote sense	B-21
Check DC voltage readback accuracy without remote sense	B-23
Check DC voltage line regulation	B-25
Check DC voltage load regulation.....	B-27
Check DC overvoltage protection.....	B-28
Check DC current accuracy	B-29
Check DC current readback accuracy (10 A and 1 A ranges).....	B-31
Check DC current readback accuracy (100 mA and 10 mA ranges).....	B-33
Check DC current line regulation	B-35
Check DC current load regulation	B-37
Check overcurrent protection	B-38
Check voltage noise (20 MHz)	B-39
Check current noise (20 MHz).....	B-41
Calibration and adjustment	C-1
Overview	C-1
Environmental conditions	C-1
Warmup period.....	C-2
Line power.....	C-2
Calibration considerations.....	C-2
Calibration cycle.....	C-2
Required equipment.....	C-3
Characterization shunts	C-4
Calibration connection.....	C-6
Voltage calibration connections.....	C-7
Current calibration connections.....	C-8
Front-panel calibration procedure	C-10
Voltage calibration.....	C-11
Low-current calibration	C-12
High-current calibration	C-13
Saving calibration constants from the front panel.....	C-15
Remote calibration procedure	C-16
Remote voltage calibration.....	C-17
Remote low-current calibration.....	C-18
Remote high-current calibration	C-20
Saving calibration constants using SCPI commands	C-23
Configure the calibration date	C-23
Exit the calibration procedure using SCPI commands	C-24
Change the calibration password.....	C-24
Calibration constants.....	C-25
Status model	D-1
Overview	D-1
Programming and reading registers.....	D-5
Programming enable registers	D-5

Reading the registers	D-6
Clearing the registers	D-6
Status byte and service request.....	D-7
Status Byte Register	D-7
Service Request Enable Register	D-9
Status register sets	D-9
Register bit descriptions	D-9
Event registers	D-20
Event enable registers	D-20
Condition registers	D-20
Queues.....	D-20
Output queue	D-21
Error queue	D-21
Serial polling and SRQ.....	D-21
Status model programming examples	D-22
SRQ when reading buffer becomes full.....	D-22
SRQ when trigger model is finished	D-23

Introduction

In this section:

Welcome	1-1
Extended warranty	1-1
Contact information	1-1
Product documentation and drivers	1-2
Organization of manual sections	1-2
Key features	1-3
Standard accessories	1-4
Optional accessories	1-4
Available services	1-5
General ratings	1-5

Welcome

Thank you for choosing a Keithley Instruments product. The Series 2280 Precision DC Power Supply is a high-sensitivity, low-noise, programmable instruments that source low noise, stable voltage, and can monitor load currents over a wide dynamic range, from amperes to nanoamperes.

With a high-resolution, 4.3-inch TFT color display, numerous parameters describing the state of the instrument are displayed to enable you to get the most information from your measurements.

Extended warranty

Additional years of warranty coverage are available on many products. These valuable contracts protect you from unbudgeted service expenses and provide additional years of protection at a fraction of the price of a repair. Extended warranties are available on new and existing products. Contact your local Keithley Instruments office, sales partner, or distributor for details.

Contact information

If you have any questions after you review the information in this documentation, please contact your local Keithley Instruments office, sales partner, or distributor. You can also call the corporate headquarters of Keithley Instruments (toll-free inside the U.S. and Canada only) at 1-800-935-5595, or from outside the U.S. at +1-440-248-0400. For worldwide contact numbers, visit the [Keithley Instruments website](http://www.keithley.com) (tek.com/keithley).

Product documentation and drivers

The following documentation and drivers for the Series 2280 are available for download from the [Keithley Instruments support website \(tek.com/support\)](http://tek.com/support).

- **Quick Start Guide:** Provides unpacking instructions, describes basic connections, reviews basic operation information, and provides a quick test procedure to ensure the instrument is operational.
- **Reference Manual:** Includes advanced operation topics, maintenance information, troubleshooting procedures, and in-depth descriptions of programming commands.
- **Accessories information:** Documentation for accessories that are available for the Series 2280.
- **Drivers and release notes:** IVI Instrument Driver, National Instruments LabVIEW™ driver, and related release notes.

Organization of manual sections

The information in this manual is organized into the following major categories:

- **General operation:** Describes the components of the instrument and basic operation.
- **Functions and features:** Describes features and functions, such as measure operations, list mode, reading buffers, triggering, the digital I/O port, graph function, output delay, and slew rate.
- **Measurement optimization:** Describes best practices and recommended procedures that can increase measurement speed, accuracy, and sensitivity.
- **Application examples:** Provides set-ups for applications, such as for low-current measurements, and list mode operations.
- **Introduction to SCPI commands:** Describes how to control the instrument using SCPI commands.
- **SCPI command reference:** Contains programming notes and an alphabetical listing of all SCPI commands available for the Series 2280.
- **Troubleshooting guide:** Describes the event log and basic LAN troubleshooting.
- **Next steps:** Contains sources of additional information.
- **Maintenance:** Contains information about instrument maintenance, including line fuse replacement and firmware upgrades.
- **Verification:** Contains performance verification procedures.
- **Calibration and adjustment:** Contains information about instrument calibration from the front panel and using SCPI commands.
- **Status model:** Describes the Series 2280 status model.

Key features

The Series 2280 has the following features:

- High current resolution and sensitivity to measure a wide range of load currents
- 6½-digit measurement resolution to enable a wide range of measurements while on one current range
- Fast current measurements to test or study load current pulses as narrow as 100 µs
- Linear mode, low noise output
- Color TFT display with icon-based and soft key user interface
- Data logging and analysis with graphical display and statistics for trend analysis
- Up to nine groups of user-definable lists with up to 99 steps for each list
- GPIB, USB-TMC, and LAN LXI interfaces for automated test development
- Filtering to reduce noise on load current readings
- Digital I/O for rich trigger functions
- Direct parameter entry using the numeric keypad, soft keys, or the navigation wheel
- Front-panel USB-A connector for flash-drive support
- Front and rear inputs with remote sense connections on the rear panel connector
- Overcurrent, overvoltage, and over temperature protection
- Compact, 2U, half rack, stackable form factor fits easily in a test rack

Model	Description
2280S-32-6	Precision measurement DC power supply. 32 V, 6 A
2280S-60-3	Precision measurement DC power supply. 60 V, 3.2 A

Standard accessories

Accessory	Part number
Model 2280-001 Output Mating Connector	2280-001
Standard LAN crossover cable	N/A
Quick start guide	For details, see the following table.
Certification of Calibration	Varies

You will get one of the following quick start guides.

Languages	Part number
English	0713190xx*
Simplified Chinese	0713260xx*
Traditional Chinese	0713261xx*
French	0713254xx*
Spanish	0713257xx*
Italian	0713255xx*
German	0713256xx*
Japanese	0713258xx*
Portuguese	0713259xx*
Korean	0713262xx*
Russian	0713263xx*

* Where xx represents the revision number.

Optional accessories

Optional accessory	Part number
Model 2280-001 Output Mating Connector	2280-001
USB Cable Type A to B, 1 m (3.3 ft)	USB-B-1
Standard LAN crossover cable	N/A
IEEE-488.2 Interface Board for the PCI Bus	KPCI-488LPA
Double Shielded Premium IEEE-488 Interface Cables, 0.5m (1.6 ft)	7007-05
Double Shielded Premium IEEE-488 Interface Cables, 1m (3.2 ft)	7007-1
Double Shielded Premium IEEE-488 Interface Cables, 2m (6.5 ft)	7007-2
Double Shielded Premium IEEE-488 Interface Cables, 3m (10 ft)	7007-3
Double Shielded Premium IEEE-488 Interface Cables, 4m (13 ft)	7007-4
Dual Fixed Rack-Mount Kit for 2280S and 2281S instruments	4299-14
Model 2450-TLINK Trigger Link Cable	131909200

Available services

For the current list of available services and accessories, upgrades, and options for your instrument, visit tek.com/keithley.

Service	Model Number
1 additional year of factory warranty beyond the 3-Year factory warranty (total of 4 years)	2280S-32-6-EW 2280S-60-3-EW
2 additional years of factory warranty beyond the 3-Year factory warranty (total of 5 years)	2280S-32-6-5Y-EW 2280S-60-3-5Y-EW
KeithleyCare® 3 Year Standard Calibration Plan	C/2280S-32-6-3Y-STD C/2280S-60-3-3Y-STD
KeithleyCare 3 Year Calibration w/Data Plan	C/2280S-32-6-3Y-DATA C/2280S-60-3-3Y-DATA
KeithleyCare 5 Year Standard Calibration Plan	C/2280S-32-6-5Y-STD C/2280S-60-3-5Y-STD
KeithleyCare 5 Year Calibration w/Data Plan	C/2280S-32-6-5Y-DATA C/2280S-60-3-5Y-DATA
KeithleyCare 3 Year ISO 17025 Calibration Plan	C/2280S-32-6-3Y-1702 C/2280S-60-3-3Y-1702
KeithleyCare 5 Year ISO 17025 Calibration Plan	C/2280S-32-6-5Y-1702 C/2280S-60-3-5Y-1702

General ratings

The Series 2280 instrument's general ratings and connections are listed in the following table.

Category	Specification
Supply voltage range	Four ranges: 100 V, 120 V, 220 V, 240 V and each range capable of $\pm 10\%$ tolerance, 50 Hz or 60 Hz. Selectable by the line-voltage selector switch on the rear panel.
Output connections	See Test connections (on page 2-37).
Environmental conditions	For indoor use only. Altitude: Maximum 2000 meters (6562 feet) above sea level. Operating: 0 °C to 40 °C, full accuracy to 80% relative humidity at up to 35 °C, noncondensing. Storage: -20 °C to 70 °C, 5% to 95% relative humidity at up to 40 °C and 5% to 60% relative humidity above 40 °C up to 70 °C. Pollution degree: 2.

Line fuse characteristics are shown in the following table.

Model	100 VAC/120 VAC source	220 VAC/240 VAC source
2280S-32-6	250 V, 5 A, Time delay	250 V, 2.5 A, Time delay
2280S-60-3	250 V, 5 A, Time delay	250 V, 2.5 A, Time delay

General operation

In this section:

Front-panel overview	2-1
Rear-panel overview	2-3
Front-panel user interface	2-4
Installing the system	2-28
Test connections	2-37
Remote communications interfaces	2-44
Set voltage and current limit	2-71
Select a measurement function	2-74
Select a specific measurement range	2-75
Protection	2-78
Saving setups	2-82
Using the event log	2-85
System information	2-86
Instrument sounds	2-87
Resets	2-87

Front-panel overview

The front panel of Series 2280 is shown below. Descriptions of the controls on the front panel follow the figure.



Figure 1: Series 2280 front panel



POWER switch



Turns the instrument on or off. To turn the instrument on, press the power switch so that it is in the on position (I). To turn it off, press the power switch so that it is in the off position (O).

HOME key		Returns the display to the home screen.
MENU key		Opens the main menu. Select the icons using the navigation control and pressing the ENTER key to open source, measure, views, trigger, and system screens. For details, see Menu overview (on page 2-14).
USB port		Saves reading buffer data to a USB flash drive. You can also store and retrieve scripts to and from a USB flash drive. The flash drive must be formatted as a FAT or FAT32 drive.
LCD screen		The Series 2280 has a high-resolution, 4.3-inch color TFT LCD display. You can access additional interactive screens by pressing the front-panel MENU key.
Navigation control		Turning the navigation control: Moves the cursor to the left or the right to highlight a listed value or menu item so that you can select it.
ENTER key		Selects the highlighted choice or allows you to edit the selected field.
EXIT key		Returns to the previous screen or closes a dialog box. For example, press the EXIT key when the main menu is displayed to return to the home screen. When you are viewing a subscreen (for example, the Event Log screen), press the EXIT key to return to the main menu screen.
TRIGGER key		Accesses trigger-related settings and operations. The action of the TRIGGER key depends on the instrument state.
Soft keys		There are five soft keys located under the display. They provide access to additional settings on multiple screens. For example, press the first soft key when the main menu screen is displayed to move the cursor to the left.
OUTPUT ON/OFF switch		Turns the output source on or off. The switch illuminates when the source output is on.

REMOTE LED indicator



Illuminates when the instrument is controlled through a remote interface.

LAN LED indicator



Illuminates when the instrument is connected to a local area network (LAN).

Front-panel binding posts



Positive, negative, and ground output binding posts for output connections.

Rear-panel overview

The rear panel of the Series 2280 is shown below; descriptions follow the figure.

Figure 2: Series 2280 rear panel



LAN port



Supports full connectivity on a 10 Mbps or 100 Mbps network. The Series 2280 is a version 1.4 Core 2011 compliant instrument that supports TCP/IP and complies with IEEE Std 802.3 (ethernet LAN). See [LAN communications](#) (on page 2-48).

USB port



USB-B connection for communication, control, and data transfer. For details, see [USB communications](#) (on page 2-64).

Power module

The power module contains the AC line receptacle, the power line fuse, and the line voltage selector switch. For safety precautions and other details, see [Line fuse replacement](#) (on page A-1) and [Power the instrument on and off](#) (on page 2-34).

Digital I/O port

A digital input/output port that detects and outputs digital signals. The port provides six digital I/O lines. Each output is set high (+5 V) or low (0 V) and can read high or low logic levels. Each digital I/O line is an open-drain signal. Refer to [Digital I/O](#) (on page 3-19) for information.

IEEE-488 port

GPIB connection; the default setting for the Series 2280 is 5. Refer to [GPIB communication](#) (on page 2-45).

Rear output terminals

Connections for the source outputs and the sense inputs.

Front-panel user interface

The front-panel user interface gives you quick access to source settings, measure settings, system configuration, instrument status, reading buffer information, and other instrument functionality.

The following topics describe the features of the user interface in more detail.

Home screen

The default screen that you see whenever you turn the Series 2280 on is the main home screen. The following figure shows the home screen with the different areas of the screen numbered. Descriptions of the screen areas are in the table following the figure.

Figure 3: Power supply home screen



#	Screen element	Description
1	System status and event indicators	Located at the top of the home screen, these indicators provide information about the present state of the instrument. Some of the indicators open up a dialog box with more information or a settings menu when selected. For details, see Status and error indicators (on page 2-5).
2	OUTPUT view area	The green part of the home screen; displays the value of the present outputs and status indicators.
3	Setting area	Located in the lower left corner of the OUTPUT view area. Shows the presently set measure range, voltage, and current limit.
4	Soft-key area	The soft-key area is on the bottom of the home screen. There are three soft-key areas that show the present setting values. You can change these values by pressing the buttons below the screen. To see the additional soft-key areas, select Next at the bottom right of the screen. For more information, see Soft-key area (on page 2-10).

Status and error indicators

The indicators across the top of the home screen contain information about the following instrument settings and states. Highlight an indicator by turning the navigation control and then pressing **ENTER** to get more information about the present state of the instrument.

Communication settings status indicator

Move the focus to the communication indicator using the navigation control and press the **ENTER** key to see a list of present communications settings.

Figure 4: Series 2280 communication status indicator

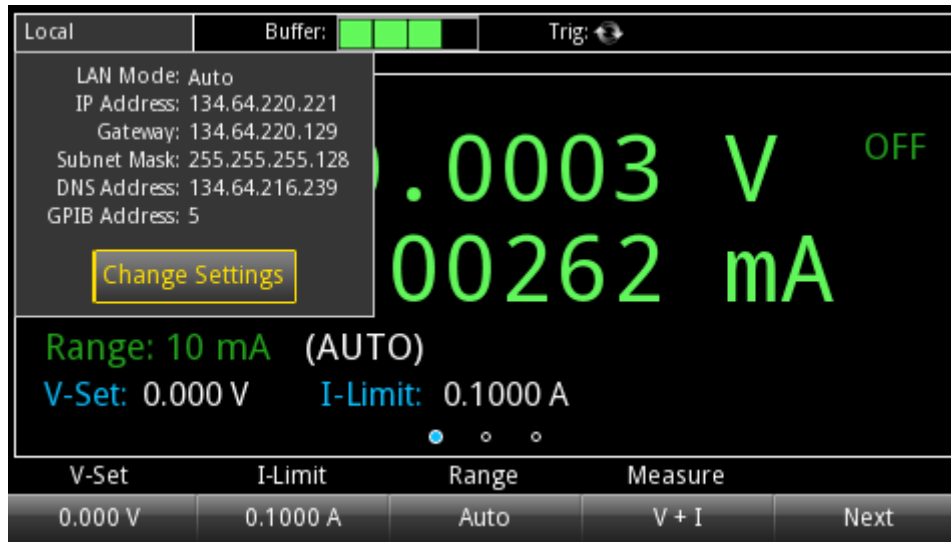

Indicator	Meaning
Local	Instrument is controlled from the front panel.
GPIB	Instrument is communicating through a GPIB interface.
VXI-11	Instrument is communicating using VXI-11.
USBTMC	Instrument is communicating through a USB interface (firmware version 1.05 and earlier, port number raw socket 5050; firmware version 1.06 and later, port number raw socket 5025).
WebPage	Instrument is communicating through a web page.

Instrument communication activity indicator

The activity indicator is located to the right of the communication settings status indicator. When the instrument is communicating with a remote interface, the up and down arrows flash.

Figure 5: Instrument communication activity indicator



If a service request has been generated, SRQ is displayed to the right of the up and down arrows. You can configure the instrument to generate a service request (SRQ) when one or more errors or conditions occur. This indicator stays on until the serial poll byte is read or all the conditions that caused SRQ are cleared.

Level trigger enabled indicator

When a voltage level trigger or current level trigger is enabled, a solid white square indicator is visible to the left of the Buffer indicator.

Figure 6: Level trigger enabled indicator



When a level trigger is enabled, data is logged to the buffer when the triggering condition is met.

Buffer indicator

The bar next to Buffer indicates how full the buffer is.

Green bar	Buffer status
	Empty
	Less than one-quarter full
	Less than half full, more than one-quarter full
	Less than three-quarter full, more than half full
	More than three-quarter full

Trigger mode settings indicator

This indicator shows the status of the trigger operation.

Figure 7: Trigger indicator



List and recall settings indicator

This indicator shows the specified list number or recall settings.

Figure 8: List and recall settings indicator



Error and event indicator

Move the focus to the error and event indicator using navigation control and press the **ENTER** key to see the present error and event messages. With the focus on the Event Log button, press **ENTER** to see the Error and Event Log.

Figure 9: Error and event indicator



This indicator has a different appearance based on the type of event that has been logged.

Icon	Description
	A serious error has occurred. These major errors are: <ul style="list-style-type: none"> ▪ Overprotection error (overvoltage, overcurrent, or overtemperature protection). ▪ Reverse sense leads.
	A normal error has occurred. All the errors except the serious errors listed above are normal errors, such as SCPI command errors and data overflow errors.
	No new error or event messages have been logged since you last viewed the error log.

OUTPUT view area

This area displays the values for the present measurements and instrument status indicators.

The following table lists the indicators shown on the right of the OUTPUT view area.

Indicator	Status description
Output status	The instrument always has one of the following indicators visible: <ul style="list-style-type: none"> ▪ OFF: The output is turned off. ▪ CV: The output is turned on and the power supply is in constant voltage (CV) mode. ▪ CC: The output is turned on and the power supply is in constant current (CC) mode. ▪ DISABLE: The output is turned off and pressing the OUTPUT switch does not turn on the output.
Fault status	The fault status indicator means that an error occurred: <ul style="list-style-type: none"> ▪ OVP: Overvoltage protection. ▪ OCP: Overcurrent protection. ▪ OTP: Overtemperature protection. ▪ RVS: Reversed sense leads on rear panel.
Calculation status	CALC : If either math or filter operation is enabled, the CALC indicator is displayed in the OUTPUT view area. If none of them are enabled, the CALC indicator is cleared.
Relative offset status	REL : If relative offset is enabled, the REL indicator is displayed.
Remote status	RWLOCK : All of the front-panel keys are disabled. The instrument can only be controlled using a remote interface.

Soft key area

The Series 2280 display has multiple soft-key areas that you can access by pressing the **NEXT** soft key. The soft-key areas give you front-panel access to some instrument settings so that you can change, enable, or disable them quickly. The following topics describe each of these screens.

Soft key area 1

Soft-key area 1 contains the settings shown in the following figure and explained in the table. To change a setting, press the soft key to open a setting window. After configuration, close the window by pressing the **ENTER** or **EXIT** key.

Figure 10: Soft key area 1 for power supply

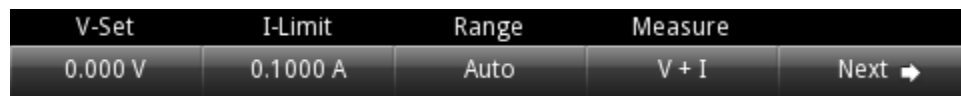

Setting	Description	
V-Set	Configure the voltage setting using the numerical keys, soft keys, and navigation control.	
I-Limit	Configure the current setting using the numerical keys, soft keys, and navigation control.	
Range	Press the up arrow to move up a range; press the down arrow to move down a range. Press AUTO to set autorange.	
Measure	Configure the measurement function.	
	V + I	Press soft key 1 to change the measurement function to concurrent.
	V	Press soft key 2 to change the measurement function to voltage.
	I	Press soft key 3 to change the measurement function to current.
Next	Switch to home screen 2.	

NOTE

If you use the navigation control to adjust the voltage and current settings, the values are applied to the instrument immediately when output is on.

Soft key area 2

Soft key area 2 contains the settings shown in the following figure and explained in the table.

Figure 11: Soft key area 2 for power supply

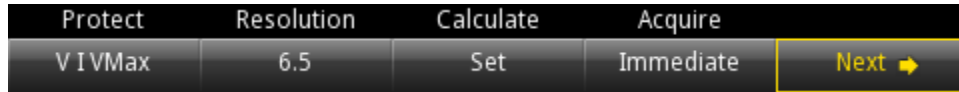

Setting	Description	
Protect	Configure the safety settings using the numerical keys, soft keys, and navigation control.	
	OVP	Edit the voltage threshold for overvoltage protection.
	OCP	Edit the current threshold for overcurrent protection.
	VMAX	Edit the maximum voltage setting value.
Resolution	Specify the measurement resolution for the selected measurement function.	
Calculate	Specify the calculate functions including relative, math, and filter.	
	Rel	Enable or disable the relative function, and set the current value as the reference value.
	Math	Enable or disable the math function.
	Filter	Enable or disable the filter function.
Acquire	Configure the source trigger mode.	
	Immediate	Set the source to immediate triggering.
	External	Set the source to external triggering.
	Manual	Set the source to manual triggering.
Next	Switch to home screen 3.	

Soft key area 3

Soft key area 3 contains the settings shown in the following figure and explained in the table. To change a setting, press the soft key to open a settings window. After configuration, close the window by pressing the **ENTER** or **EXIT** key.

Figure 12: Soft key area 3

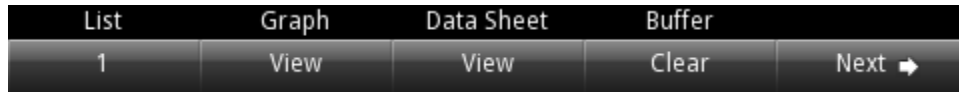

Setting		Description
List		Configure the list function.
	Enable	Run a specified list.
	Number	Specify the list number. The default setting for list number is Demo. You can run a predefined list. For more information about Demo, see System Information menu (on page 2-27).
	Hold Time	Set the list running time as Point or Time .
	End Zero	Enable or disable setting the voltage to 0 V after the list operation has ended.
	Mode	Select a list mode and specify the list cycle.
Graph		View the data plot.
Data Sheet		View the data sheet.
Buffer		Clear the data buffer.
Next		Switch to home screen 1.

Menu overview

To access the main menu, press the **MENU** key on the Series 2280 front panel. The organization of the main menu is shown in the figure below.

Figure 13: Power supply main menu



The main menu is organized into five submenus, which are labeled in green across the top of the display. The icons in each column open interactive screens.

Source menu

The menus organized under Source in the main menu allow you to select, configure, and perform source and list operations from the Series 2280 front panel. The following topics describe the settings that are available on these interactive screens.

Source Settings menu

You can change the following settings by pressing the **MENU** key, moving focus to the Source Settings icon, and pressing the **Enter** key.

Setting	Description
V-Set	Configure the voltage setting using the numerical keys, soft keys, and navigation control.
I-Limit	Configure the current setting using the numerical keys, soft keys, and navigation control.
Output	Turn the output on or off. You can also disable the output. Once output is disabled, the output is off and the OUTPUT switch is ignored.
Output Delay	Enable or disable output delay.
Slew Rise	Set the rising rate for voltage source.
Slew Fall	Set the falling rate for voltage source.
Delay Rise	Set the delay time that the instrument waits before turning on the output.
Delay Fall	Set the delay time that the instrument waits before turning off the output.

Source Protect menu

This menu allows you to configure the protection settings.

Setting	Description
Overvoltage Protection	Set the overvoltage protection limit of the source output to restrict the maximum voltage level that the instrument can source.
Overcurrent Protection	Set the overcurrent protection limit of the source output to restrict the maximum current level that the instrument can source.
Maximum Voltage	Set the maximum voltage that can be set. This influences the voltage setting range.

Source List menu

This menu allows you to set up a source configuration list.

Setting	Description
List	Select a list from nonvolatile memory; import a list from an external USB flash drive; save a list to an external USB flash drive.
Save	Save the present list to nonvolatile memory.
Delete	Delete the specified points from the list.
Insert	Insert one point with default settings before each specified point. The default settings are: 0.000 V, 0.1000 A, 0.100 s.
Copy	Copy the selected settings of the point and insert a new point with the same settings before each point.
Points	Displays the number of points in the list (read only).
List table	This table shows all the setting values in the list. You can edit them by moving focus and pressing the ENTER key.

Source Delay menu

This menu allows you to set a delay for the source. For details, refer to [Source delay](#) (on page 3-7).

Setting	Description
Source Delay	Configure the delay time using the numerical keys, navigation wheel, and soft keys.
State	Enable or disable the delay that occurs when the source is turned on.

Measure menu

The menus organized under Measure in the main menu allow you to select, configure, and perform measure operations from the Series 2280 front panel. The following topics describe the settings that are available on these interactive screens.

Measure Settings menu

This menu contains settings for the presently selected measurement function, which is identified by the **Type** indicator in the upper right corner of the menu. The line frequency is also shown here.

Setting	Description
Function	Select which type of measurement is active: <ul style="list-style-type: none"> ▪ V + I: Concurrent measurement function. The instrument measures voltage and current at the same time. ▪ V: Voltage measurement function. The instrument only measures voltage. ▪ I: Current measurement function. The instrument only measures current.
Range	Set the measurement range for the selected measurement function or select Auto to have the instrument select the range automatically.
Digits	Select the display digits: 6½, 5½, or 4½ digits.
Auto Zero	Set Auto Zero to On so that the instrument periodically gets new measurements of its internal ground and voltage reference. This setting increases measurement accuracy, but may slow measurement time.
NPLC	Set the amount of time that the input signal is measured. A lower number of power line cycles (NPLCs) results in faster reading rates, but increased noise. A higher number of NPLCs results in lower reading noise, but slower reading rates.
Power Line Freq	Read only; shows the present power line frequency setting.

Measure Rel/Filter menu

This menu contains settings that specify the way measurement information is returned.

Setting	Description
Function	Displays the presently selected function.
Rel State	Use the relative offset feature to subtract a set value or a baseline reading from measurement readings. When you enable relative offset, all subsequent measurements are displayed as the difference between the actual measured value and the relative offset value.
Rel Acquire	Acquire the present reading as a relative value.
Reference	Configure the offset value. You can use Rel Acquire to set the present reading as the relative offset value. You can also specify the relative offset using the numerical keys, navigation control, and soft keys. The default value is 0.
Type	The Series 2280 only supports moving average filtering. This filter continuously adds measurements to the stack on a first-in, first-out basis, replacing the oldest measurement in the stack with a new measurement.
Filter State	Enable or disable filtering of measurements.
Count	Sets the number of measurements that are averaged when filtering is enabled. The number of measurements can be 2 through 100.
Window	Filtering uses a window to control filter threshold. When the input signal remains within the selected window, measurements continue to be placed in the stack. If the input signal changes to a value outside the window, the filter resets and starts processing again, starting with new measurements.

Measure Math menu

This menu contains settings that configure the math function.

Setting	Description
Type	When the Math State is set to On, the mx+b math operation is performed on measurements. mx+b : Manipulate normal display readings by adjusting the m and b factors.
State	When the state is set to On, any math operations specified for the present measurement function are performed before completing the measurement.
m(Gain)	Specify the scale factor for mx+b math operation. The valid range is $-1e6$ to $+1e6$.
b(Offset)	Specify the offset for mx+b math operation. The valid range is $-1e6$ to $+1e6$.
Function	Displays the presently selected function.
Units	Specify the units suffix name for mx+b operation. You can only select one capital letter for the name from the front panel.
Buffer Data Type	Select Reading to store measurements to the buffer without performing math operations on them. Select CALC to store measurements to the buffer after performing specified math operations.

Measure Data Buffers menu

From this screen you can save, resize, and clear buffers. You also can set buffer fill mode and statistics functions.

Setting	Description
Size	Set the maximum number of readings the buffer can store (2 to 2,500). Note that when you resize a buffer, the readings contained in that buffer are cleared.
Mode	Select Always to have the buffer fill continuously, overwriting old data when the buffer is filled. Select Next to have the buffer stop collecting data when it is filled (no data is overwritten). Select Never to have the buffer stop collecting data.
Statistics	Select statistics to apply to the readings in the buffer. Available statistics: <ul style="list-style-type: none"> ▪ Minimum: Minimum value ▪ Maximum: Maximum value ▪ Peak-Peak: Maximum value - minimum value ▪ Mean: Average ▪ Std Dev: Standard deviation
Statistics Function	Select whether to apply statistics calculations to current or voltage readings. You can only specify one of them at a time.
Auto Clear	Enable or disable autoclear for the buffer. When autoclear is enabled, the buffer will automatically clear when the storage process starts.
Statistics Format	Select the data elements to be shown on the graph and data sheet screen. Available data elements: <ul style="list-style-type: none"> ▪ Value: Voltage and current reading ▪ Time: The timestamp for the data point ▪ Number: Reading number ▪ All: Voltage and current reading, timestamp for the data point, and reading number
Export To USB	Save the buffer to a <code>.csv</code> file, which can be opened by a spreadsheet program.
Clear Buffer	Clear all the data in the buffer.

Views menu

The menus organized under View in the main menu allow you to view the data plot, sheet, and statistics results on the Series 2280 front panel. The following topics describe the settings that are available on these interactive screens.

Views Graph menu

Selecting the Graph menu opens a screen that allows you set up and see the measurements in a graphical format.

Setting	Description
Graph	View the readings in a graphical representation.
Statistics	Turn the statistics function on or off. You can view statistics results on the graph screen when this function is on.
Window	Fine-tune the output on the graph view screen.
	Position
	Set the center point of the graph for buffer data. For example, if the buffer size is 100, a position of 30% means the 30th reading in the buffer is at the middle point in the plot.
	Zoom
	Specify the number of readings that are displayed on the screen.
Y-Axis	Select the data that is plotted on the Y-axis. You can select Current , Voltage , or Both .
I Auto Adjust	Enable or disable the automatic adjustment of the current scale and offset of the Y-axis. When automatic adjustment is disabled, you can adjust the scale and offset manually.
V Auto Adjust	Enable or disable the automatic adjustment of the voltage scale and offset of the Y-axis. When automatic adjustment is disabled, you can adjust the scale and offset manually.
I Manual Adjust	Manually adjust the current scale and offset of the Y-axis. <ul style="list-style-type: none"> ▪ Scale is the volts/division, or amps/division. A plot has 7 divisions. ▪ Offset is the value of the lowest division displayed.
V Manual Adjust	Manually adjust the voltage scale and offset of the Y-axis. <ul style="list-style-type: none"> ▪ Scale is the volts/division, or amps/division. A plot has 7 divisions. ▪ Offset is the value of the lowest division displayed.

Views Sheet menu

This menu allows you to view data in the selected reading buffer.

Setting	Description
Data Sheet	Show the data in the reading buffer.
Statistics	Turn on or off the statistics function. You can view statistics results in the data sheet when this function is on.

Trigger menu

This menu allows you to configure triggering operations from the Series 2280 front panel. The following topics describe the settings that are available on these interactive screens.

Trigger Configure menu

This menu allows you to configure the triggering operations. The Series 2280 has two trigger layers: Arm layer and trigger layer.

Setting	Description
List type	Displays the list type when the list function is enabled. The Series 2280 supports the following types of lists: <ul style="list-style-type: none"> ▪ Step: One trigger signal will output one list step. ▪ Sweep: One trigger signal will output the entire list. ▪ Disable: The list is disabled.
Idle	<ul style="list-style-type: none"> ▪ Cont:On: Continuous trigger is on. ▪ Cont:Off: Continuous trigger is off and no readings are taken.
Arm Source	Select the control source for the arm layer.
Arm Count	Set the number of times to repeat the arm event.
Trigger Source	Select the control source for the trigger layer.
Trigger Count	Set the number of times to repeat the trigger event.
Reset Configuration	Reset the trigger settings to factory default, including trigger source and trigger count.
Sample Count	Set the number of measurements to be performed when a measurement is requested.

Trigger Digital In/Out menu

This menu allows you to configure the mode for each digital I/O line. The Series 2280 has 6 digital I/O lines (line 1 to line 6). For details, refer to [Digital I/O](#) (on page 3-19).

Setting	Description
Line 1	Specify one of the following line modes for digital I/O line 1: <ul style="list-style-type: none"> ▪ Trigger In ▪ Output HI ▪ Output LO ▪ Manual In
Line 2	Specify one of the following line modes for digital I/O line 2: <ul style="list-style-type: none"> ▪ Meter Out ▪ Output HI ▪ Output LO ▪ Manual In
Line 3	Specify one of the following line modes for digital I/O line 3: <ul style="list-style-type: none"> ▪ Fault Out ▪ Output HI ▪ Output LO ▪ Manual In
Line 4	Specify one of the following line modes for digital I/O line 4 to line 6: <ul style="list-style-type: none"> ▪ Output HI ▪ Output LO ▪ Manual In
Line 5	
Line 6	

Level Trigger menu

This menu allows you to configure a triggering condition to start to log the data in the data buffer during the test. You can set the triggering point based on the voltage or current. The triggering condition is based on whether the current or voltage rises or falls.

Setting	Description
Voltage	<ul style="list-style-type: none"> ▪ If you set this as On, the triggering point is based on the value of voltage. ▪ If you set this as Off, the triggering point is not based on the value of voltage.
Current	<ul style="list-style-type: none"> ▪ If you set this as On, the triggering point is based on the value of current. ▪ If you set this as Off, the triggering point is not based on the value of current.
Voltage Level	Set the value of the voltage that will trigger the data logging in the data buffer.
Current Level	Set the value of the current that will trigger the data logging in the data buffer.
Voltage Direction	<ul style="list-style-type: none"> ▪ If you set this as Rise, the trigger will be activated when the voltage rises above the triggering point. ▪ If you set this as Fall, the trigger will be activated when the voltage falls below the triggering point.
Current Direction	<ul style="list-style-type: none"> ▪ If you set this as Rise, the trigger will be activated when the current rises above the triggering point. ▪ If you set this as Fall, the trigger will be activated when the current falls below the triggering point.
Offset	Set how many points will be saved before the trigger is activated.

NOTE

When the level trigger function is enabled, it clears all the data in the buffer and the buffer mode is set to Always.

When the level trigger is activated, it clears the data in the buffer (except the points set by the Offset parameter) and the buffer mode is set to Next.

When the level trigger is enabled, a solid white rectangle is visible at the top of the display screen, as shown in the following figure.

Figure 14: Level trigger enabled indicator



You can use the following SCPI commands to configure the level trigger:

```
:TRACe[n]:TRIGger:VOLTage:STATe
:TRACe[n]:TRIGger:VOLTage[:LEVel]
:TRACe[n]:TRIGger:VOLTage:DIRectioN
:TRACe[n]:TRIGger:CURRent:STATe
:TRACe[n]:TRIGger:CURRent[:LEVel]
:TRACe[n]:TRIGger:CURRent:DIRectioN
:TRACe[n]:TRIGger:OFFSet
```

In addition, you can query whether any level trigger has been activated using the following SCPI command:

```
:TRACe[n]:TRIGger:OCCUR?
```

System menu

The menus under System in the main menu allow you to configure general instrument settings from the Series 2280 front panel. Among these settings are the event log, communications, error beeper, key clicks, backlight brightness and timer, time and date, calibration, and system and calibration passwords and settings.

The following topics describe the settings that are available on these interactive screens.

System Save/Recall menu

This menu allows you to save the present settings and any source or measure configuration lists to internal memory or an external USB flash drive. You can also run a setup from internal memory or a USB flash drive.

Setting	Description
Save	Save the present instrument settings as a user-saved setup. The Series 2280 supports up to five setups.
Recall	Return the instrument to the specified setup.
Auto Load Setup 1	<ul style="list-style-type: none"> ▪ If you choose On, the instrument will load <code>setup1</code> after it is powered on. ▪ If you choose Off, the instrument will not load <code>setup1</code> after it is powered on.

System Settings menu

This menu contains general instrument settings.

Communication settings

This menu allows you to configure GPIB, LAN, and USB communications settings.

To access the System Communication settings screen:

1. Move focus to the communication indicator at the top left of the home screen and press the **ENTER** key. A dialog box opens that shows current communication settings.
2. Select **Change Settings**. The System Communication screen is displayed.
3. Select an interface by moving focus to the **Interface** button and pressing the **ENTER** key.

You can also access this menu through the main menu by selecting **Settings** (under System) > **Communications**.

GPIB settings	Description
Address	The default GPIB address is 5. You can set the address to any address from 1 to 30, if it is unique in the system. This address cannot conflict with an address that is assigned to another instrument or to the GPIB controller.
LXI LCI	Reset the LAN configuration

LAN settings*	Description
TCP/IP Mode	Select Manual to manually set the Local IP, gateway, and subnet mask values. Select Auto to set the instrument to automatically obtain an IP address.
Gateway	When TCP/IP Mode is set to Manual, you can see the present gateway address. To change the address, select the button next to Gateway and enter a new address.
IP Address	When TCP/IP Mode is set to Manual, you can see the present local IP address. To change the address, select the button next to Local IP and enter a new address.
Subnet	When TCP/IP Mode is set to Manual, you can see the present subnet mask address. To change the address, select the button next to Subnet and enter a new address.
MAC Address	Read-only text that shows the present MAC address of the instrument.
Apply Settings	To save any changes you made on the LAN tab, select Apply Settings .

* You must select Apply Settings after changing any of the settings on this tab to save your settings.

There are no settings for the USB interface.

NOTE

The Series 2280 powers up using the last remote interface used.

Other system settings

Setting		Description
Key Click		Turn the instrument key-click sound on or off from this menu.
Backlight Timer		You can set the front-panel display to dim after a period of time, or you can set it so that it will never dim.
Backlight Brightness		You can adjust the brightness of the front-panel display. Selecting this setting opens a sliding adjustment scale that adjusts the brightness as a percent of total brightness.
Time and Date		Set the instrument month, day, year, and time from this menu.
Error Beeper		Turn the error beeper on or off.
System Password		Change the remote connection or calibration passwords. You need the remote connection password to open the LXI virtual front panel and send SCPI commands. You need the calibration password before you can calibrate the Series 2280.
Reset	System Reset	Selecting this option resets many of the instrument commands to their default values. For more information about what commands get reset, see Reset default values (on page 2-88).
	Password Reset	Selecting this option reverts the passwords to their default values.

System Event Log menu

The System Event Log menu allows you to view, save, and clear the event log. The event log entries are error messages, which may indicate that a command was sent incorrectly.

Settings	Description
Export to USB	Saves the event log to a <code>.csv</code> file on the USB flash drive. The file name is <code>eventlog.csv</code> .
Clear Event Log	Clears all entries from the event log.

System Information menu

The System Information menu shows the serial number, firmware version, and the calibration adjust date and count. It also allows you to upgrade the firmware and calibrate the instrument.

Setting	Description				
Demo	When you select Demo mode, you can choose List Mode or Pulse .				
Upgrade	Selecting this option initiates a firmware upgrade from a file on a USB flash drive (the flash drive must be less than or equal to 2 GB and formatted in the FAT file format). For details, see Upgrading the firmware (on page A-2).				
	<table border="1"> <tr> <td>New</td> <td>Update the firmware to the latest version. During the upgrade process, the instrument verifies that the version you are loading is newer than what is on the instrument. If the version is older or at the same revision level, no changes are made.</td> </tr> <tr> <td>Previous</td> <td>Selecting this option returns the Series 2280 to a previous version of the firmware from a file on a USB flash drive. When you return to a previous version, the instrument verifies that the version you are loading is earlier than what is on the instrument. If there are several versions on the USB flash drive that are older than what is on the instrument, the newest one is selected.</td> </tr> </table>	New	Update the firmware to the latest version. During the upgrade process, the instrument verifies that the version you are loading is newer than what is on the instrument. If the version is older or at the same revision level, no changes are made.	Previous	Selecting this option returns the Series 2280 to a previous version of the firmware from a file on a USB flash drive. When you return to a previous version, the instrument verifies that the version you are loading is earlier than what is on the instrument. If there are several versions on the USB flash drive that are older than what is on the instrument, the newest one is selected.
New	Update the firmware to the latest version. During the upgrade process, the instrument verifies that the version you are loading is newer than what is on the instrument. If the version is older or at the same revision level, no changes are made.				
Previous	Selecting this option returns the Series 2280 to a previous version of the firmware from a file on a USB flash drive. When you return to a previous version, the instrument verifies that the version you are loading is earlier than what is on the instrument. If there are several versions on the USB flash drive that are older than what is on the instrument, the newest one is selected.				
Calibrate	Start to calibrate the instrument.				

Adjusting the backlight brightness and timer

You can adjust the brightness of the Series 2280 display from the front panel or over a remote interface. You can also set the backlight to dim after a specified period of time has passed with no front-panel activity (available for the front-panel display only). The backlight settings are not affected by reset.

NOTE

Screen life is affected by how long the screen is on at full brightness. The higher the brightness setting and the longer the screen is bright, the shorter the screen life.

To adjust the backlight brightness from the front panel:

1. Press the **MENU** key.
2. Under System, select **Settings**.
3. Highlight the button next to **Backlight Brightness** and press **ENTER**. The Backlight Brightness dialog box opens.
4. Enter a value and press **ENTER**.

To set the backlight timer from the front panel:

1. Press the **MENU** key.
2. Under System, select **Settings**.
3. Select the button next to Backlight Timer and press **ENTER**. The Backlight Timer dialog box opens.
4. Select a timer setting and press **ENTER**.

To adjust the brightness using the SCPI remote interface:

Send the following command:

```
:DISPlay:BRIGhtness <brightness>
```

Where <brightness> is from 1 to 100. For example, 75 represents 75 percent brightness and 100 represents full brightness.

Installing the system

This section contains information on how to install your Series 2280 power supply.

Bumpers

The Series 2280 has front and rear bumpers for using the instrument on a benchtop.

Removing bumpers

You can remove the bumpers on the Series 2280 if you want to mount the instrument in a rack.

NOTE

If you remove the bumpers, be sure to store them for future benchtop use.

To remove the bumpers:

1. Grasp the front bumper on each side of the Series 2280 and gently pull it toward you until the bumper comes off of the instrument.

Figure 15: Removing the front bumper

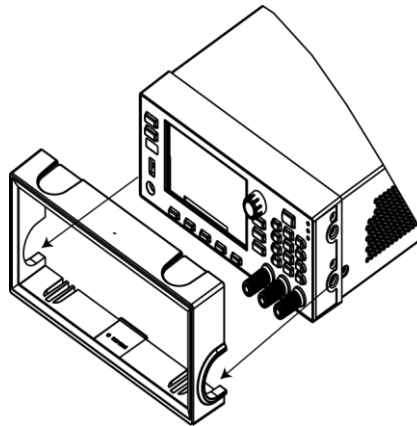

NOTE

Remove all connections to the rear panel of the Series 2280 before removing the rear bumper.

2. To remove the rear bumper, repeat the procedure in step 1.

Dimensions

The following figures show the mounting screw locations and the dimensions of the instrument with and without the bumpers.

The instrument weighs 10.67 kg (23.53 lb) with the bumpers and 10.40 kg (22.95 lb) without them.

The following figure shows the mounting screw locations and dimensions. Mounting screws must be #6-32 with a maximum screw length of 11.13 mm (0.438 in.). The dimensions shown are typical for both sides of the instrument.

Figure 16: Series 2280 mounting screw locations and dimensions

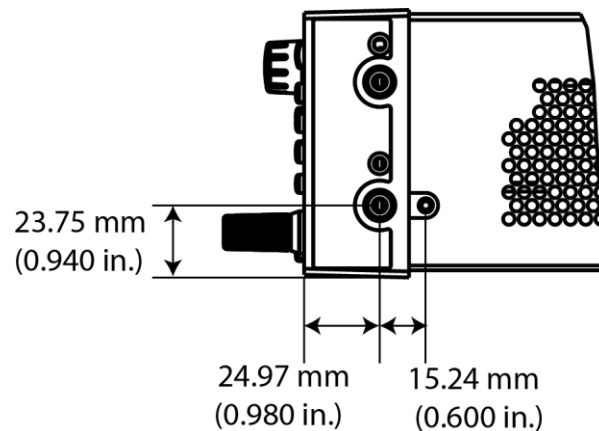

The following figures show the dimensions when the bumpers are installed.

Figure 17: Series 2280 front and rear panel dimensions with bumpers

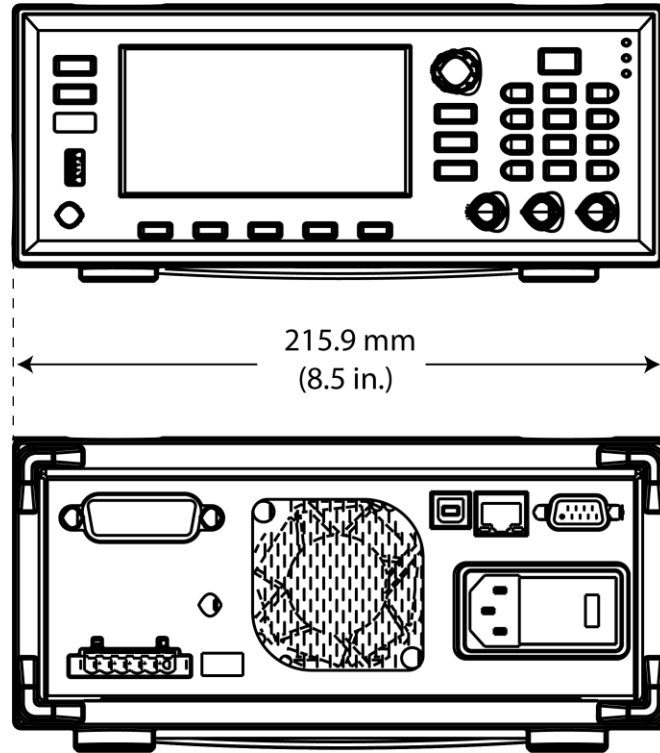
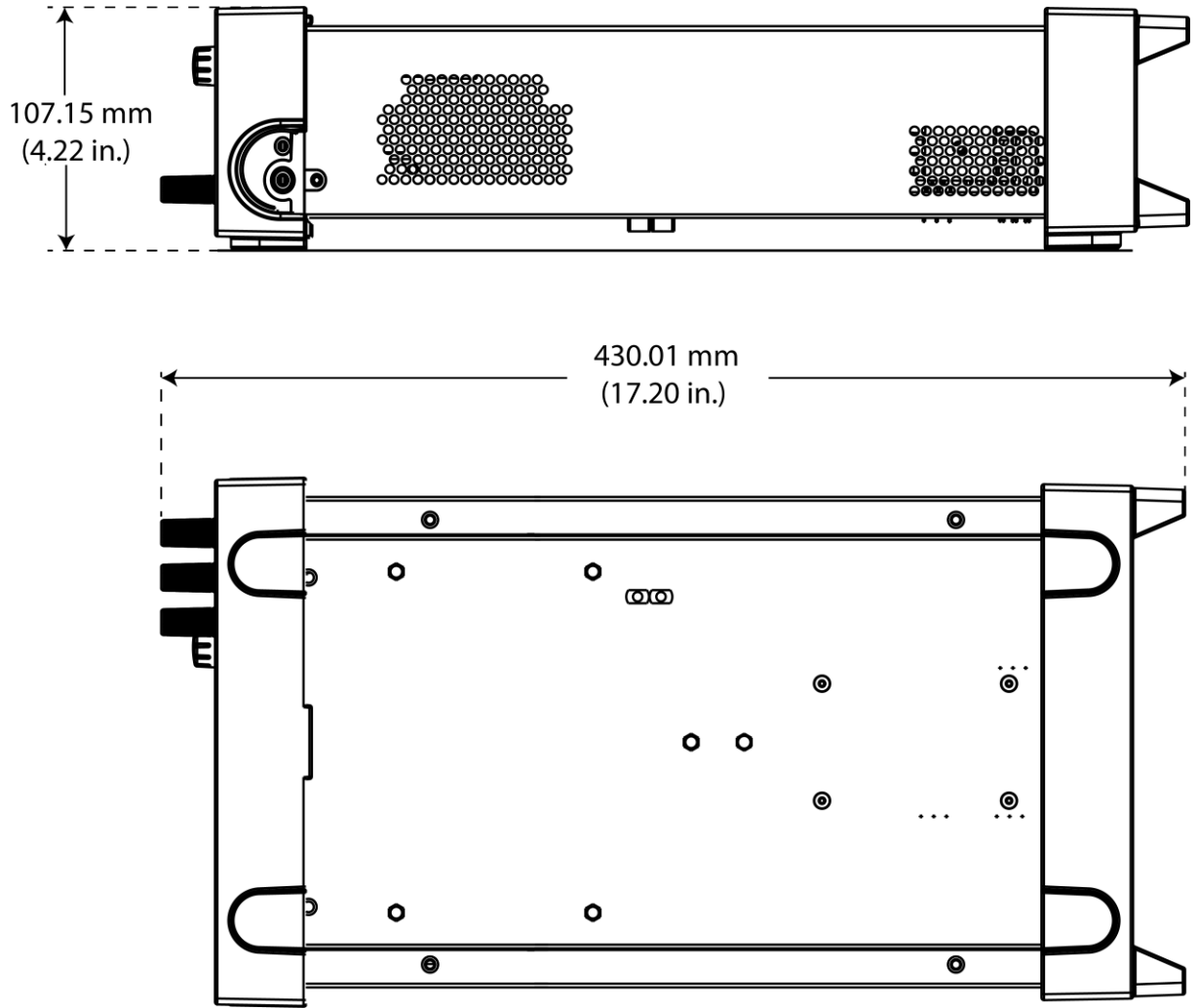

Figure 18: Series 2280 top and side dimensions with bumpers



The following figures show the dimensions when the bumpers have been removed.

Figure 19: Series 2280 front and rear panel dimensions with bumpers removed

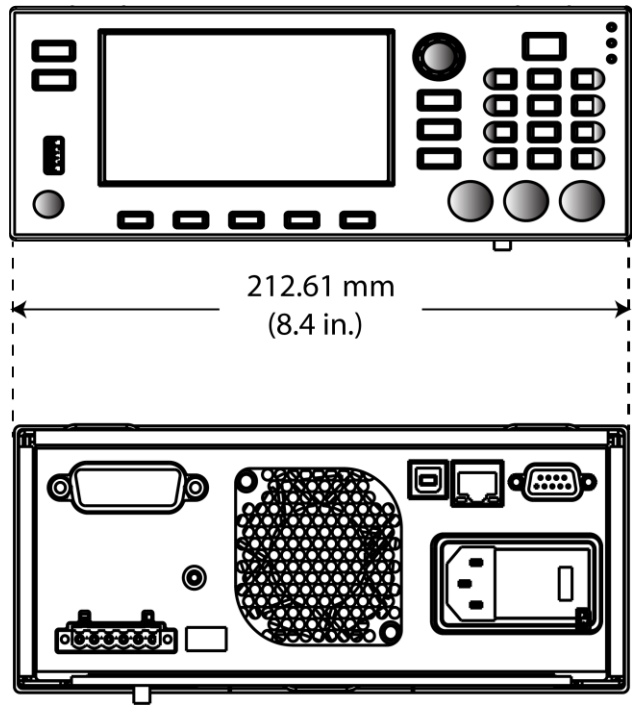
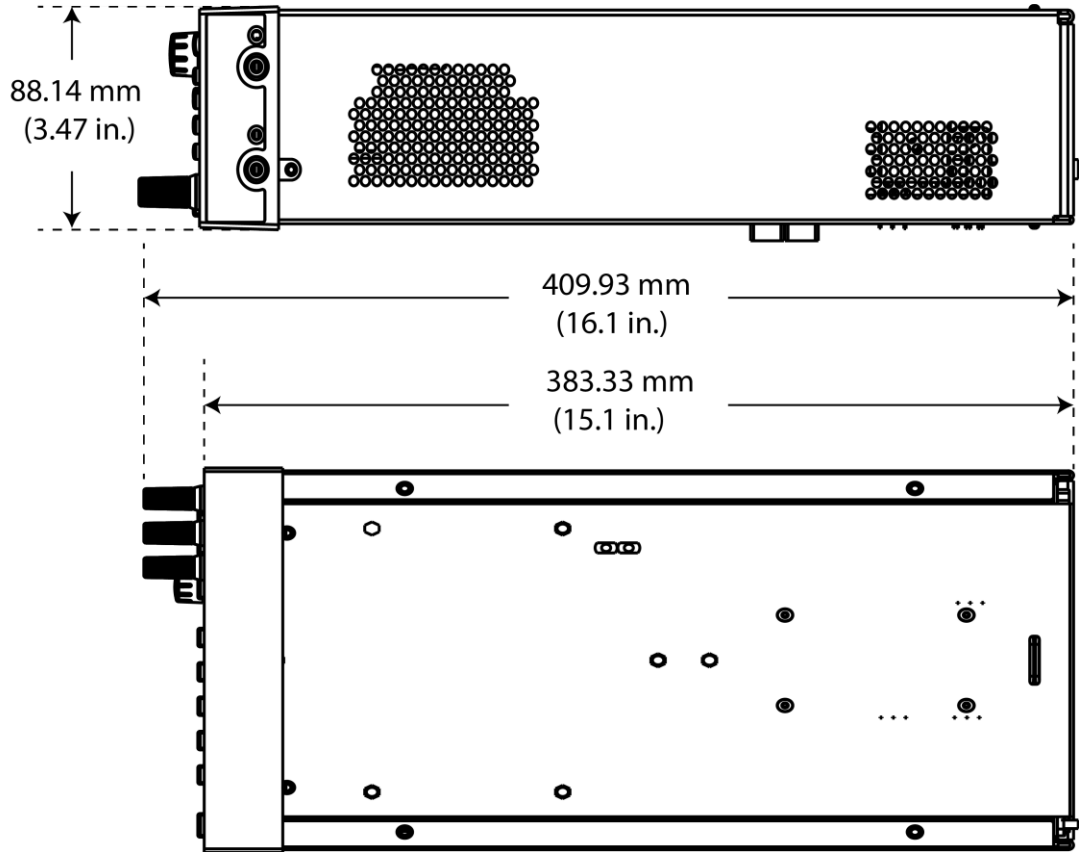

Figure 20: Series 2280 top and side dimensions with bumpers removed



Power the instrument on and off

Follow the procedure below to connect the Series 2280 to line power and turn on the instrument. The Series 2280 operates on the following ranges: 100 V, 120 V, 220 V, or 240 V at a frequency of 50 Hz or 60 Hz. You need to select the line voltage and frequency on the rear panel. Make sure the line voltage setting is compatible with the line voltage in your area.

The Series 2280 must be turned on and allowed to warm up for at least one hour to achieve rated accuracies.

⚠ WARNING

The power cord supplied with the Series 2280 contains a separate protective earth (safety ground) wire for use with grounded outlets. When proper connections are made, the instrument chassis is connected to power-line ground through the ground wire in the power cord. In addition, a redundant protective earth connection is provided through a screw on the rear panel. This terminal should be connected to a known protective earth. In the event of a failure, not using a properly grounded protective earth and grounded outlet may result in personal injury or death due to electric shock.

Do not replace detachable mains supply cords with inadequately rated cords. Failure to use properly rated cords may result in personal injury or death due to electric shock.

CAUTION

Operating the instrument on an incorrect line voltage may cause damage to the instrument, possibly voiding the warranty.

Figure 21: Series 2280 rear panel



To connect the power cord:

1. Make sure that the front panel POWER switch is in the off (O) position.
2. Properly set the 100 V/120 V or 220 V/240 V selector switch located on the rear panel.
3. Connect the female end of the supplied power cord to the AC receptacle on the rear panel.
4. Connect the other end of the power cord to a grounded AC outlet.

To turn a Series 2280 on and off:

CAUTION

On some sensitive or easily damaged devices under test (DUTs), the instrument power-up sequence can apply transient signals to the DUT that may affect or damage it. When testing this type of DUT, do not make final connections to it until the instrument has completed its power-up sequence and is in a known operating state.

1. Disconnect any devices under test (DUTs) from the Series 2280 before turning the instrument on.
2. To turn your instrument on, press the front-panel **POWER** switch to place it in the on (I) position. A status bar is displayed as the instrument powers up. The home screen is displayed when power up is complete.
3. To turn your instrument off, press the front-panel **POWER** switch to place it in the off (O) position.

CAUTION

On some sensitive or easily damaged devices under test (DUTs), the instrument power-down sequence can apply transient signals to the DUT that may affect or damage it. When testing this type of DUT, disconnect it from the instrument before turning the instrument off.

Turning the Series 2280 output on

You can turn the Series 2280 output on from the front panel or by sending remote commands.

To turn the output on using the front panel:

Press the **OUTPUT** switch. The instrument is in the output-on state when the switch is illuminated. The instrument is in the output-off state when the switch is not illuminated.

NOTE

For the power supply function only, you can also turn on the output from the Source Setting screen. Select the button next to **Output** and press the **State** soft key. The output state screen is displayed. You can enable the output by pressing the **On** soft key.

To turn the output on using a SCPI command:

```
:OUTPut:STATe ON
```

NOTE

When you are using a remote interface to control the instrument and the output is turned off, pressing the **OUTPUT** switch cannot turn the output on. However, if the output is turned on, you can press the **OUTPUT** switch to turn the output off.

Turning the Series 2280 output off

WARNING

Turning the Series 2280 output off does not place the instrument in a safe state.

Hazardous voltages may be present on all output and guard terminals. To prevent electrical shock that could cause injury or death, never make or break connections to the Series 2280 while the instrument is powered on. Turn off the equipment from the front panel or disconnect the main power cord from the rear of the Series 2280 before handling cables. Putting the equipment into an output-off state does not guarantee that the outputs are powered off if a hardware or software fault occurs.

Using the front panel:

Press the **OUTPUT** switch. The instrument is in the output-on state when the switch is illuminated. The instrument is in the output-off state when the switch is not illuminated.

NOTE

You can also turn off the output from the Source Setting screen. Select the button next to **Output** and press the **State** soft key. The output state screen is displayed. You can turn off the output by pressing the **Off** soft key.

Using SCPI commands:

To turn the output off, send the command:

```
:OUTPut [:STATe] OFF
```

Disable the Series 2280 output

You can disable the Series 2280 output from the front panel and by sending remote commands. If disabled, pressing the **OUTPUT** switch on the front panel does not turn on the output.

Using the front panel:

1. From the home screen, press **MENU**.
2. Under Source, select **Settings**.
3. Select the button next to **Output** and press **ENTER**. The Output window is displayed.
4. Select **Status**. The Status window is displayed.
5. Select the box below **Disable**.

Using a SCPI command:

To disable the output, send the command:

```
:OUTPut[:STATe] DISable
```

Test connections

You can use either the front-panel or rear-panel terminals to make connections to the device under test (DUT). You must use either the front or rear terminals. You cannot use connections to both the front panel and rear panel for the same test setup; you must choose one or the other.

WARNING

Hazardous voltages may be present on all output and guard terminals. To prevent electrical shock that could cause injury or death, never make or break connections to the Series 2280 while output is on.

To prevent electric shock, test connections must be configured such that the user cannot come in contact with conductors or any device under test (DUT) that is in contact with the conductors. It is good practice to disconnect DUTs from the instrument before powering the instrument. Safe installation requires proper shields, barriers, and grounding to prevent contact with conductors.

The basic connection configurations for the Series 2280 include:

- Two-wire sense connection
- Four-wire remote sense connection

Front-panel connector

Front-panel connectors are available to connect load wires for bench operation. A chassis ground binding post is also provided on the front panel.

Figure 22: Front-panel binding post

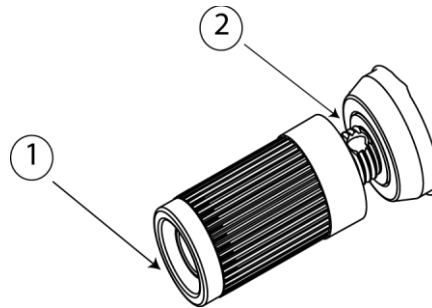

There are two locations on the binding post to connect the wire. See the picture above. You can use one of the methods below to connect the outputs from the front panel:

- Insert standard banana plugs into the front connectors as shown in location 1.
- Insert safety test leads into the front connectors as shown in location 1. For details, see the following figure.
- Insert the wires into the hole as shown in location 2, and fasten the wires by hand-tightening the binding posts. The wire size should be from American wire gage (AWG) 20 to AWG 12.

Figure 23: Safety test lead connection

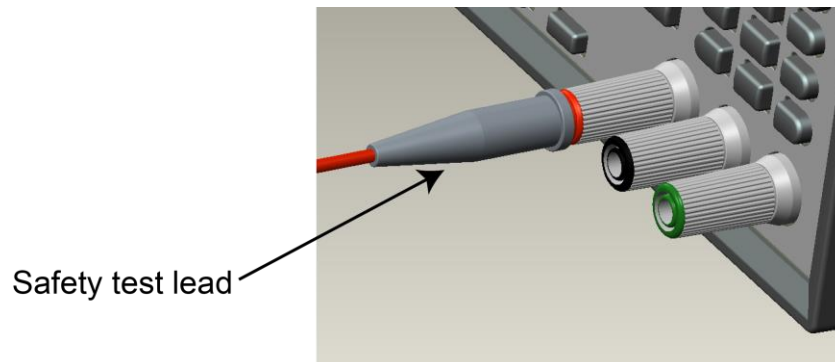

⚠ WARNING

The wire must be heavy enough not to overheat while carrying the short-circuit output current of the unit. You must meet the wiring requirements described above. Make sure the wire you use is enclosed inside a safety cover.

Rear-panel output mating connector

Available connections on the rear output mating connector include the output high (+), output low (-), sense high (+), and sense low (-) terminals. The rear output terminals accept wire sizes from AWG 20 to AWG 12.

Two-wire local sense connection

You can connect a device to the instrument in a two-wire sense connection as shown in the following figure.

Figure 24: Two-wire connection

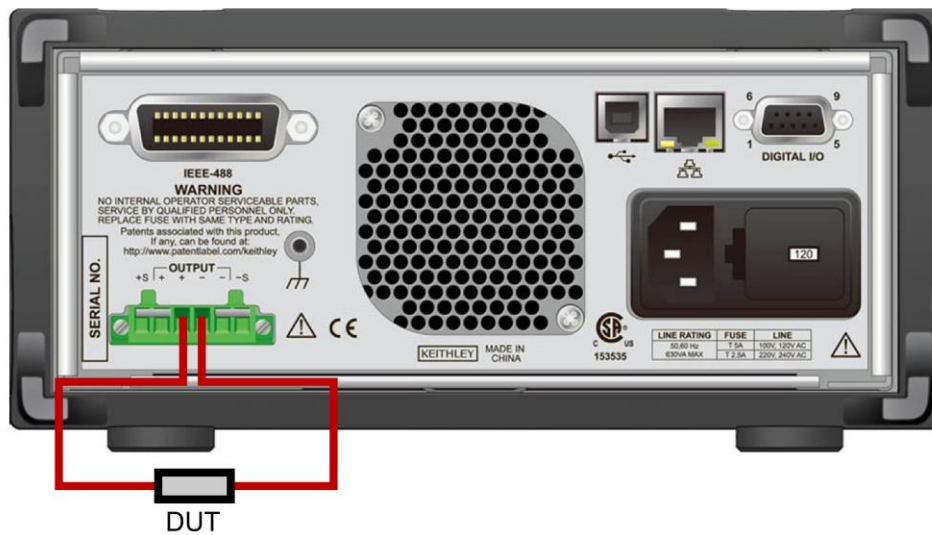

If you use a two-wire sense connection, you can use the offset function of Series 2280 to cancel out the wire resistance. For details, refer to [Relative offset](#) (on page 4-12).

Four-wire sense connection

Using four-wire remote sensing connections ensures that the programmed voltage is applied to the load and compensates for the voltage drop in the leads between the power supply and the load. The maximum voltage drop is 1 V per lead.

As shipped, the sense terminals are connected to the output terminals by shorting jumpers. Before connecting the wire, make sure the shorting jumpers have been removed. When you connect the power supply for remote sensing, the overvoltage protection (OVP) circuit senses the voltage at the sensing points (load) and not the output terminals.

Figure 25: Four-wire (remote sensing) DUT connection to rear panel

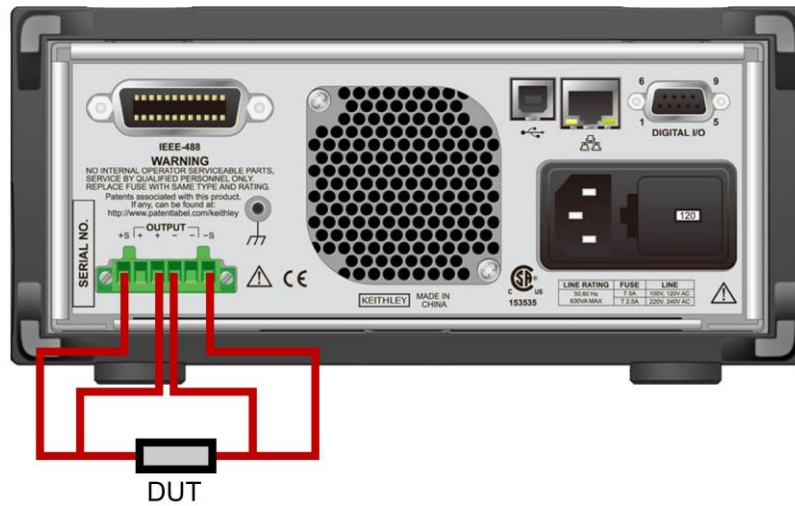

NOTE

To reduce the environmental noise, load wires and sense wires must be twisted. For more information, refer to the following figure.

Figure 26: Four-wire connection with twisted-pair wires

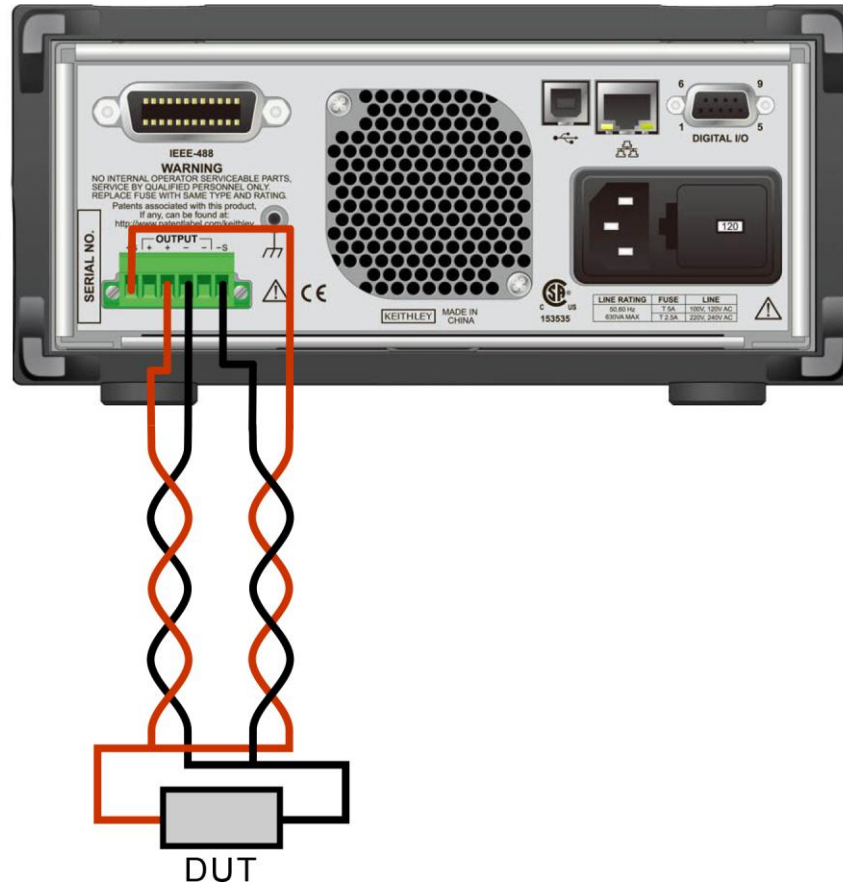

CAUTION

Make sure you make the connections correctly. Incorrect connections between output and sense terminals will result in a serious error and may damage the device under test (DUT). For more information, see [Open leads detection](#) (on page 2-42) and [Reverse sense leads](#) (on page 2-43).

Open leads detection

When using four-wire sense connections, a missing or faulty connection with Sense HI, Sense LO, Output HI, or Output LO results in improperly regulated voltage and inaccurate voltage measurements. The voltage readback shown on the front panel is not equal to the real output voltage. The open leads clamp circuit can limit the output voltage between Output HI and Output LO to less than V_{total} .

$$V_{total} = V_{set} + V_{clamp}$$

Where V_{set} is the voltage setting.

V_{clamp} is introduced from a clamp circuit, typically less than 7 V. Without the clamp circuit, the instrument could output its maximum voltage when the open lead occurs.

Example

1. Connect a 300 Ω resistor to the rear-panel mating connector. For details, refer to [Four-wire sense connections](#) (on page 2-40).
2. Set the voltage to 3 V and current limit to 1 A.
3. Turn on the output.

The following figure shows the voltage readback and output voltage when you make a correct four-wire sense connection.

Figure 27: Correct four-wire connections

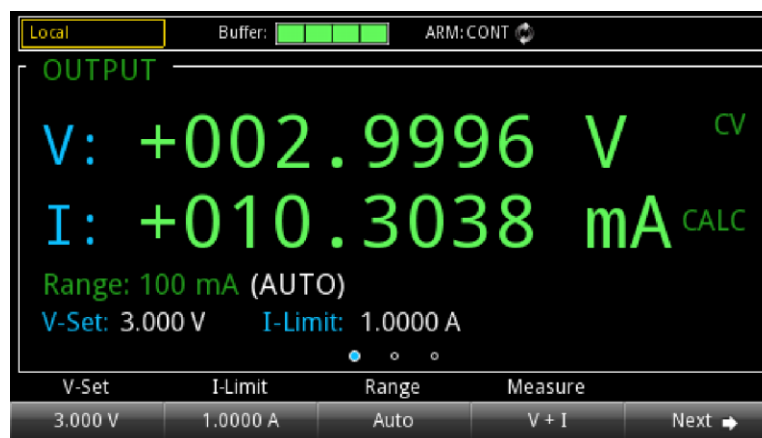

4. Power off the instrument and remove one of the test leads.

CAUTION

To avoid damage to the device under test (DUT), you must power off the instrument before making any changes on the connections. Otherwise, it may damage the device under test (DUT).

5. Power on the instrument and repeat steps 1 through 3.
The following figure shows the error that is displayed on the front panel.

Figure 28: Open lead error

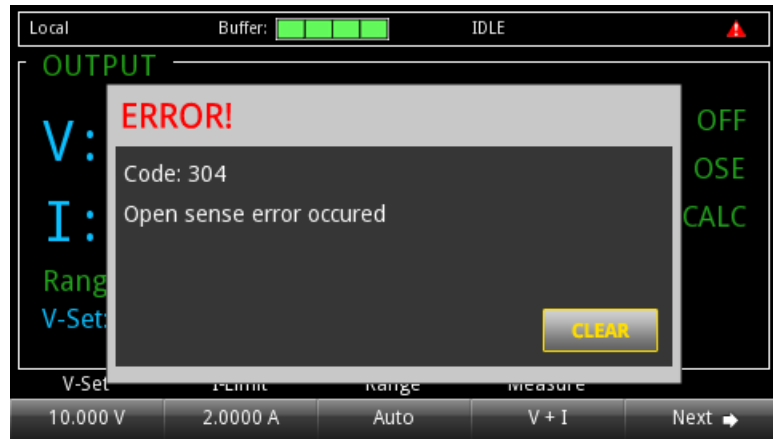

You can retrieve the error number and message through a remote interface by sending the `:SYSTEM:ERROR?` command.

Reversed sense leads

When the following connections occur, the instrument generates a reversed sense leads error.

- Sense HI is connected to Output LO
- Sense HI is connected to Sense LO
- Sense LO is connected to Output HI

When a reverse sense leads error occurs, the instrument:

- Generates an overprotection error message.
- Displays an error dialog box on the screen.
- Turns off the output.
- Resets the voltage setting value and current limit to defaults.
- Sets the digital I/O line 3 to logic high.

Figure 29: Reversed sense leads error



To clear the error, you need to clear the Questionable Instrument Summary Event Register bit and initiate the trigger model using the front panel or SCPI commands. For more information on registers, refer to [Questionable Instrument Summary Event Register](#) (on page D-16).

To clear an overprotection error using the front panel:

When the overprotection error dialog box is displayed, you can press the **ENTER** key to initiate the trigger model.

To clear an overprotection error using a SCPI command:

When an overprotection error occurs, send the following command to clear the register and initiate the trigger model:

```
:OUTPut:PROtection:CLEar
```

Remote communications interfaces

You can choose from one of several communication interfaces to send commands to and receive responses from the Series 2280.

The Series 2280 can be controlled from only one communication interface at a time. The first interface from which it receives a message takes control of the instrument. To remove control from the present interface, send the following command:

```
:SYSTem:COMMunication:ABORt
```

The Series 2280 powers up using the last remote interface used.

Supported remote interfaces

The Series 2280 supports the following remote interfaces:

- **GPIB:** IEEE-488 instrumentation general purpose interface bus
- **USB:** Type B USB connection
- **Ethernet:** Local area network ethernet communications

GPIB communications

This topic contains information about GPIB standards, bus connections, and primary address selection.

The Series 2280 GPIB interface is IEEE Std 488.1 compliant and supports IEEE Std 488.2 common commands and status model topology.

You can have up to 15 devices connected to a GPIB interface, including the controller. The maximum cable length is the lesser of either:

- The number of devices multiplied by 2 m (6.5 ft)
- 20 m (65.6 ft)

You may see erratic bus operation if you ignore these limits.

Install the GPIB driver software

Check the documentation for your GPIB controller for information about where to acquire drivers. Keithley Instruments also recommends that you check the vendor's website for the latest version of drivers or software.

It is important that you install the drivers before you connect the hardware to prevent associating the incorrect driver with the hardware.

Connect the GPIB cables to your instrument

To connect a Series 2280 to the GPIB interface, use a cable equipped with standard GPIB connectors, as shown below.

Figure 30: GPIB connector

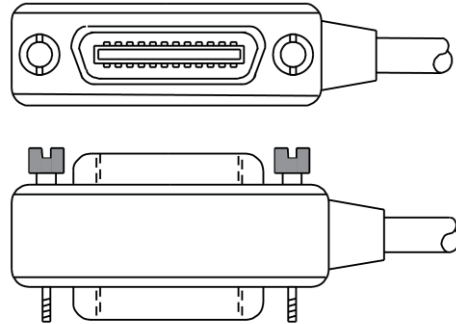

To allow many parallel connections to one instrument, stack the connectors. Each connector has two screws on it to ensure that connections remain secure. The figure below shows a typical connection diagram for a test system with multiple instruments.

CAUTION

To avoid possible mechanical damage, stack no more than three connectors on any one instrument. To minimize interference caused by electromagnetic radiation, use only shielded GPIB cables. Contact Keithley Instruments for shielded cables.

Figure 31: IEEE-488 connections example

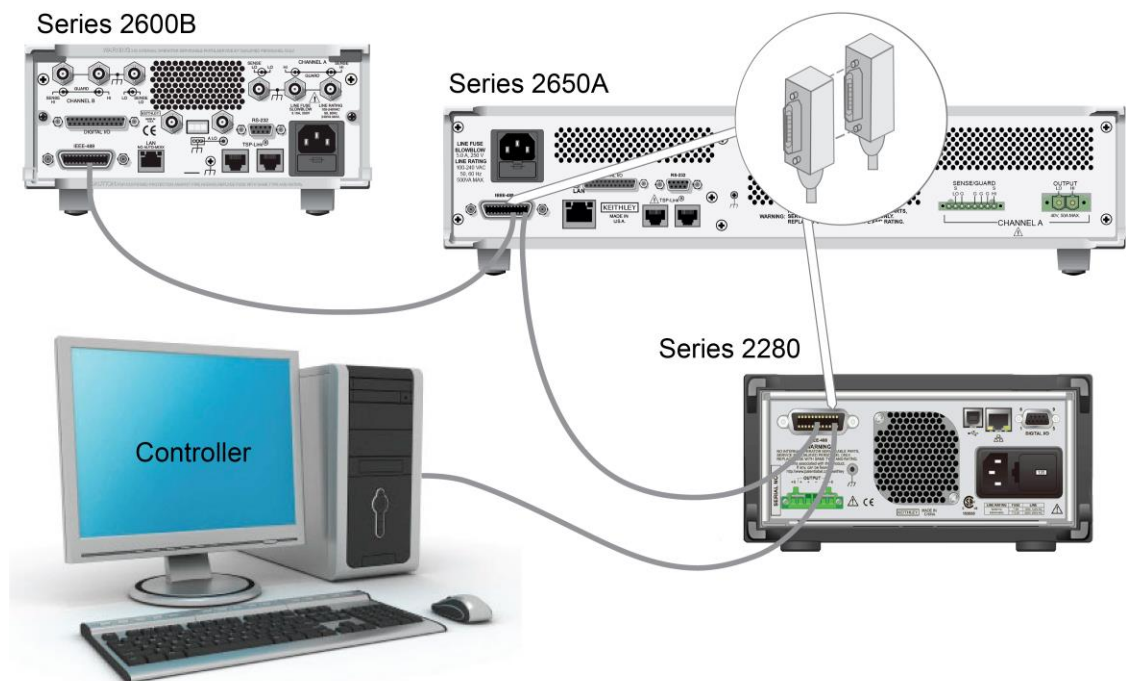

To connect the instrument to the GPIB:

1. Align the cable connector with the connector on the Series 2280 rear panel. The location of the connector is shown in the following figure.
2. Attach the connector. Tighten the screws securely but do not overtighten them.

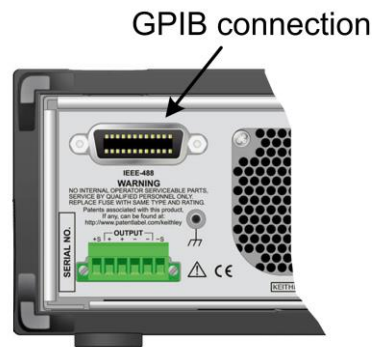
Figure 32: GPIB interface on rear panel

3. Connect any additional connectors from other instruments, as required for your application.
4. Make sure the other end of the cable is properly connected to the controller.

Set the GPIB address

The default GPIB address is 5. You can set the address to any number from 1 to 30 if it is unique in the system. This address cannot conflict with an address that is assigned to another instrument or to the GPIB controller.

NOTE

GPIB controllers are usually set to 0 or 21. To be safe, do not configure any instrument to have an address of 21. To change the controller address, see the documentation for the controller.

The address is saved in nonvolatile memory, so it does not change when a reset is done or when the instrument power is turned off and then turned on again.

To set the GPIB address from the front panel:

1. Press the **MENU** key.
2. Under System, select **Communication**. The SYSTEM COMMUNICATION window opens.
3. Select the **GPIB** interface.
4. Next to Address, select the number. The Set GPIB Address dialog box is displayed.
5. Enter the address.
6. Select **OK**.

NOTE

If you are using a Series 2280 with no front panel, you can set the GPIB address with the SCPI command :SYSTem:GPIB:ADDRess.

LAN communications

The Series 2280 comes with one standard LAN crossover cable for LAN communication. However, you can use any standard LAN crossover cable (RJ-45, male-to-male) or straight-through cable to connect your equipment. The instrument automatically senses which cable you have connected.

The following figure shows the location of the LAN connection on the rear panel of the instrument. Connect the LAN cable between this connection and the LAN connector on the computer.

Figure 33: Series 2280 LAN connection

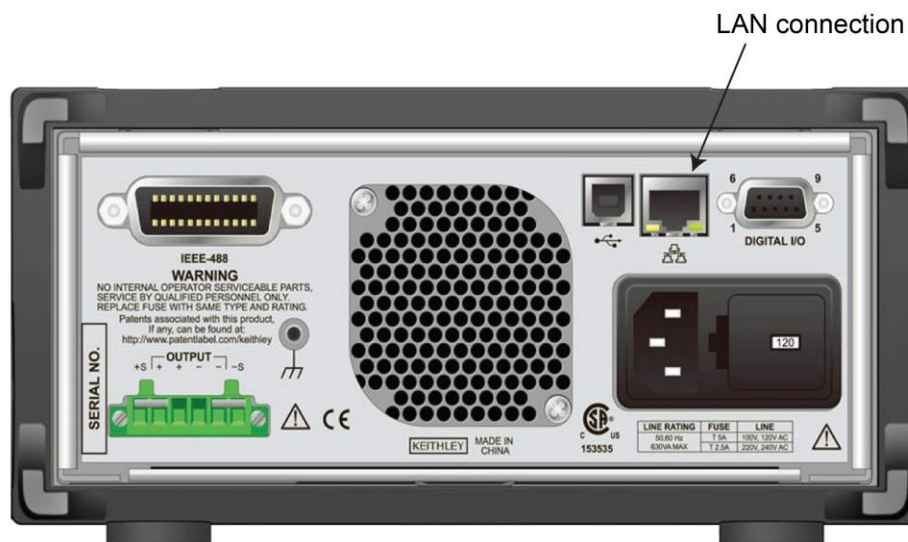

You can connect the instrument to the LAN in a one-to-one, one-to-many, two-network card, or enterprise configuration, as described in the following topics.

One-to-one connection

With most instruments, a one-to-one connection is done only when you are connecting a single instrument to a single network interface card.

A one-to-one connection using a network crossover cable connection is similar to a typical RS-232 hookup using a null modem cable. The crossover cable has its receive (RX) and transmit (TX) lines crossed to allow the receive line input to be connected to the transmit line output on the network interfaces.

Figure 34: One-to-one connection with a crossover cable

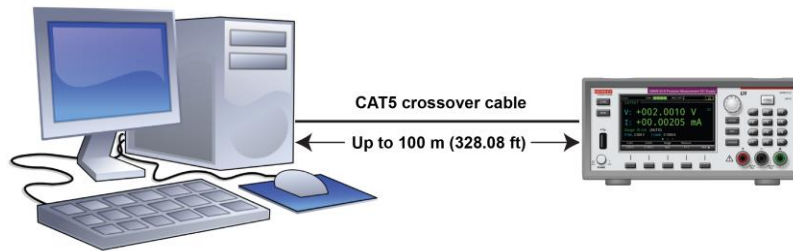

One-to-many connection

With a LAN hub, a single network interface card can be connected to as many instruments as the hub can support. This requires straight-through network (not crossover) cables for hub connections.

The advantage of this method is easy expansion of measurement channels when the test requirements exceed the capacity of a single instrument. With only the instruments connected to the hub, this is an isolated instrumentation network. However, with a corporate network attached to the hub, the instruments become part of the larger network.

Figure 35: One-to-many connection using a network hub or switch

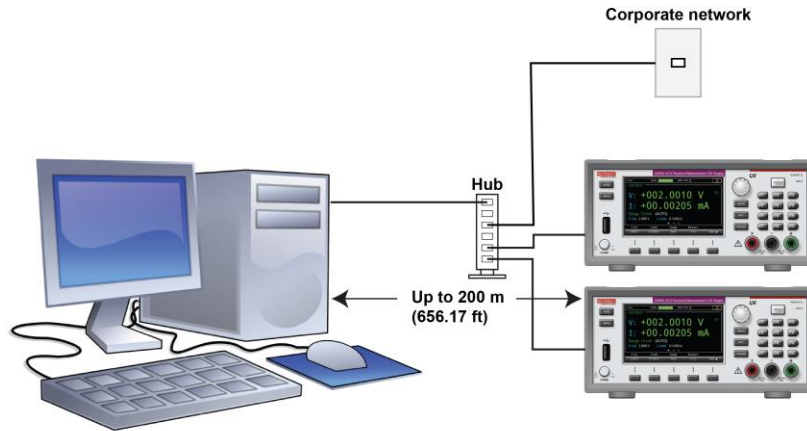

Two network card connection

If you need to connect independent corporate and instrumentation networks, two network interface cards are required in the computer controller. Though the two networks are independent, stations on the corporate network can access the instruments, and the instruments can access the corporate network, using the same computer.

This configuration resembles a GPIB setup in which the computer is connected to a corporate network, but also has a GPIB card in the computer to communicate with instruments.

Figure 36: Two network card connection

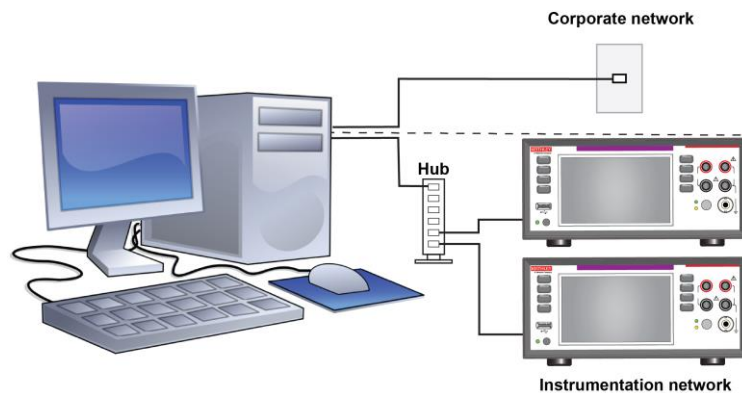

Instrumentation connection to enterprise routers or servers

This connection uses an existing network infrastructure to connect instruments to the computer controller. In this case, you must get the network resources from the network administrator.

Usually, the instruments are kept inside the corporate firewall, but the network administrator can assign resources that allow them to be outside the firewall. This allows instruments to be connected to the Internet using appropriate security methods. Data collection and distribution can be controlled from virtually any location.

Figure 37: Instrumentation connection to enterprise routers or servers

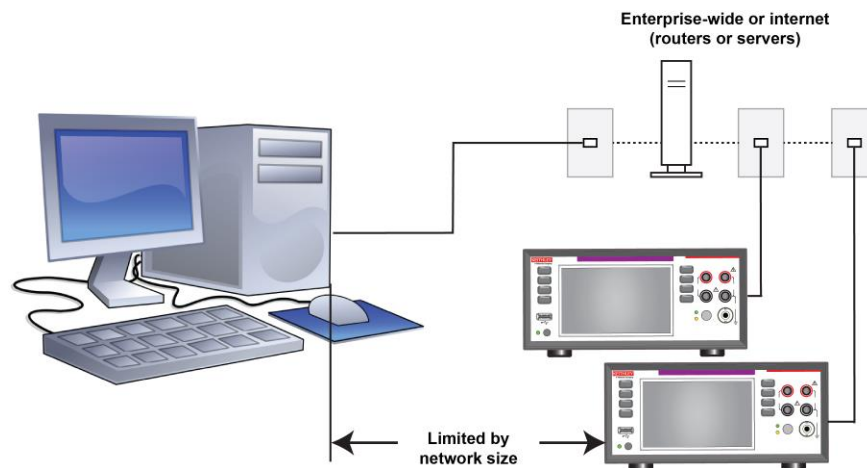

Raw socket connection

All Keithley instruments with LAN connections support raw socket communication. This means that you can connect your computer to the TCP/IP port on the instrument and send and receive commands. A programmer can easily communicate with the instrument using the Winsock API on computers with the Microsoft® Windows® operating system or using the Berkeley Sockets API on Linux® or Apple® computers.

NOTE

Beginning with firmware version 1.06 and later, the raw socket port number changed to 5025. For firmware versions 1.06 and earlier, the raw socket port number is 5050.

Set up LAN communications on the instrument

This section describes how to set up manual or automatic LAN communications on the instrument.

Check communication settings

Before setting up the LAN configuration, you can check the communication settings on the instrument without making any changes.

To check communication settings on the instrument:

1. Press the **MENU** key.
2. Under System, select **SETTINGS**. The SYSTEM SETTINGS window opens.
3. Select **COMMUNICATION**. The SYSTEM COMMUNICATION window opens.
4. Select one of the three interfaces (**GPIB** , **USB** , or **LAN**) to see the settings for that interface.
5. Press the **EXIT** key to leave the SYSTEM COMMUNICATION window without making any changes.

NOTE

You can also check the settings with the SCPI command:

```
:SYSTem:COMMunication:LAN:CONFigure
```

The Series 2280 powers up using the last remote interface used.

Set up automatic LAN configuration

If you are connecting to a LAN that has a DHCP server or if you have a direct connection between the instrument and a host computer, you can use automatic IP address selection.

If you select Auto, the instrument attempts to get an IP address from a DHCP server. If this fails, it reverts to an IP address in the range of 169.254.1.0 through 169.254.254.255.

NOTE

Both the host computer and the instrument should be set to use automatic LAN configuration. Though it is possible to have one set to manual configuration, it is more complicated to set up.

To set up automatic IP address selection using the front panel:

1. From the home screen, press **MENU**.
2. Under System, select **SETTINGS**. Then select **COMMUNICATION**.
3. Select the **LAN** interface.
4. For TCP/IP Mode, select **Auto**.
5. Select **Apply Settings** to save your settings.

NOTE

If you are using a Series 2280 with no front panel, you can configure the LAN using SCPI commands. For details, see the SCPI command [:SYSTem:COMMunication:LAN:CONFigure](#) (on page 7-114).

Set up manual LAN configuration

If necessary, you can set the IP address on the instrument manually.

You can also enable or disable the DNS settings and assign a host name to the DNS server.

NOTE

Contact your corporate information technology (IT) department to secure a valid IP address for the instrument when placing the instrument on a corporate network.

The instrument IP address has leading zeros, but the computer IP address does not.

To set up manual IP address selection on the instrument:

1. From the home screen, press **MENU**.
2. Under System, select **SETTINGS**. Then select **COMMUNICATION**.
3. Select the **LAN** interface.
4. For TCP/IP Mode, select **Manual**.
5. Select the button next to IP Address and enter the LAN IP address using the numerical or soft keys.
6. Select the button next to Gateway and enter the gateway address.
7. Select the button next to Subnet and enter the subnet mask.
8. Select **Apply Settings** to save your settings.

NOTE

If you are using a Series 2280 with no front panel, you can configure the LAN using SCPI commands. For details, see the SCPI command [:SYSTem:COMMunication:LAN:CONFigure](#) (on page 7-114).

Set up LAN communications on the computer

This section describes how to set up the LAN communications on your computer.

NOTE

Do not change your IP address without consulting your system administrator. Entering an incorrect IP address can prevent your computer from connecting to your corporate network.

Record all network configurations before modifying any existing network configuration information on the network interface card. Once the network configuration settings are updated, the previous information is lost. This may cause a problem reconnecting the host computer to a corporate network, particularly if DHCP is disabled.

Be sure to return all settings to their original configuration before reconnecting the host computer to a corporate network. Contact your system administrator for more information.

LAN status indicator

When the LAN status indicator on the front panel of the instrument turns solid green, it confirms that the instrument has been assigned an IP address. Note that it may take several minutes for the computer and instrument to establish a connection.

Use the LXI Discovery Tool

To find the IP address of the Series 2280, use the LXI Discovery Tool, a utility that is available from the Resources tab of the [LXI Consortium website \(lxistandard.org/\)](http://lxistandard.org/).

LAN status LEDs

The figure below illustrates the two status light emitting diodes (LEDs) that are located at the bottom of the LAN port of the instrument. The table below the figure provides explanations of the LED states.

Figure 38: LAN status LEDs

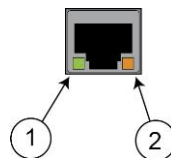

1	When lit, indicates that the LAN port is connected to a 100 Mbps network.
2	When blinking, indicates that the port is receiving or sending information.

If neither LED is lit, the network is not connected.

Web interface

When the LAN and instrument establish a connection, you can open a web page for the instrument.

To access the web interface:

1. Open a web browser on the host computer.
2. Enter the IP address of the instrument in the address box of the web browser. For example, if the instrument IP address is 169.254.152.168, enter 169.254.152.168 in the browser address box.
3. Press **Enter** on the computer keyboard to open the instrument web page.
4. If a dialog box is displayed, enter a user name and password. The default is `admin` for both.

NOTE

If the web page does not open in the browser, see [LAN troubleshooting suggestions](#) (on page 8-3).

Web interface welcome page

Figure 39: Series 2280 web interface welcome page

LXI - Welcome	
Instrument Model:	2280S-32-6
Manufacturer:	Keithley Instruments
Firmware Revision:	01.08rc01
Serial Number:	CQ00017
Description:	2280S-32
LXI Version:	1.4 LXI Core 2011
LXI Extended Functions:	
MAC Address:	08:00:11:1C:88:75
TCP/IP Address:	134.63.75.175
Gateway:	134.63.75.129
Subnet Mask:	255.255.255.128
Lan Connection:	100M_FULLL
Host Name (FQDN):	Tek-VGPP.local
DNS Servers:	134.63.75.12 129.196.193.39 128.181.2.171
Ports:	DST: 5030 Raw Socket: 5025 VXI-11 Core: 111
VISA Resource String:	TCPIP::134.63.75.175::INSTR GPIB0::5::INSTR USB0::0x05E6::0x2280::CQ00017::INSTR
Calibration Date:	4/8/2014

The welcome page of the web interface gives you basic information about the instrument, including:

- The instrument model, manufacturer, serial number, firmware revision, and the last LXI message
- An ID button to help you locate the instrument
- Links to the instrument web options, including administrative options and LXI information

Identify the instrument

If you have a bank of instruments, you can select the ID button to determine which one you are communicating with.

Before trying to identify the instrument, make sure you have a remote connection to the instrument.

To identify the instrument:

1. On the home page, select the **ID** button. The button turns green and the LAN status indicator on the instrument blinks.
2. Select the **ID** button again to return the button to its original color and return the LAN status indicator to steady on.

Change the IP configuration through the web interface

The LAN settings, such as IP address, subnet mask, gateway, and DNS address, can be changed through the web page of the instrument.

If you change the IP address through the web page, the web page will try to redirect to the IP address that gets configured in the instrument. In some cases, this may fail. This generally happens if you switch from static IP address assignment to IP address assignment using a DHCP server. If this happens, you need to revert to either using the front panel to set the IP address or use an automatic discovery tool to determine the new IP address.

NOTE

You can also change the IP configuration through the front panel or with SCPI commands. See [Set up LAN communications on the instrument](#) (on page 2-51) for information.

To change the IP configuration using the instrument web page:

1. Access the internal web page as described in the previous topic.
2. From the navigation bar on the left, in the LXI home menu, select **IP Configuration**.
3. Select **Modify**. The Modify IP Configuration page is displayed.

Figure 40: Modify IP configuration**LXI - Modify IP Configuration**

TCP/IP Configuration Mode:	<input checked="" type="radio"/> Automatic <input type="radio"/> Manual
Static IP Address:	<input type="text" value="134.64.222.35"/>
Subnet Mask:	<input type="text" value="255.255.255.128"/>
Default Gateway:	<input type="text" value="134.64.222.1"/>
DNS Servers:	<input type="text" value="134.64.216.239"/> <input type="text" value="128.181.3.1"/> <input type="text" value="129.196.132.135"/>
Host Name:	<input type="text" value="VGPP-Tek2280S"/>
Description:	<input type="text" value="Keithley-Tek2280S"/>
Domain Name:	<input type="text" value="global.tektronix.net"/>

Submit

4. Change the values.
5. Select **Submit**. The instrument reconfigures its settings, which may take a few seconds.

NOTE

You may lose your connection with the web interface after selecting **Submit**. This is normal and does not indicate an error or failure of the operation. If this occurs, find the correct IP address and reopen the web page of the instrument to continue.

Change the web interface password

You can change the instrument password from the web interface.

To change the password:

1. From the web interface home page, select **Set Password**.
2. In the **Current password** box, enter the presently used password.
3. In the **New password** and **Confirm new password** boxes, enter the new password.
4. Select **Submit**.

NOTE

The default password is `admin`.

Take a snapshot and fetch data in the virtual front panel

You can take a snapshot of the Series 2280 LCD display and fetch buffered test data on the web page.

To take a snapshot:

1. From the navigation bar of the web interface home page, select **Virtual Front Panel**.
2. If you are prompted for a password, enter it and select **Submit**. The default password is `admin`.
3. In the left upper corner of the virtual front panel, select **Operation**. The Snapshot and Fetch Data options are displayed.

Figure 41: Series 2280 Virtual Front Panel

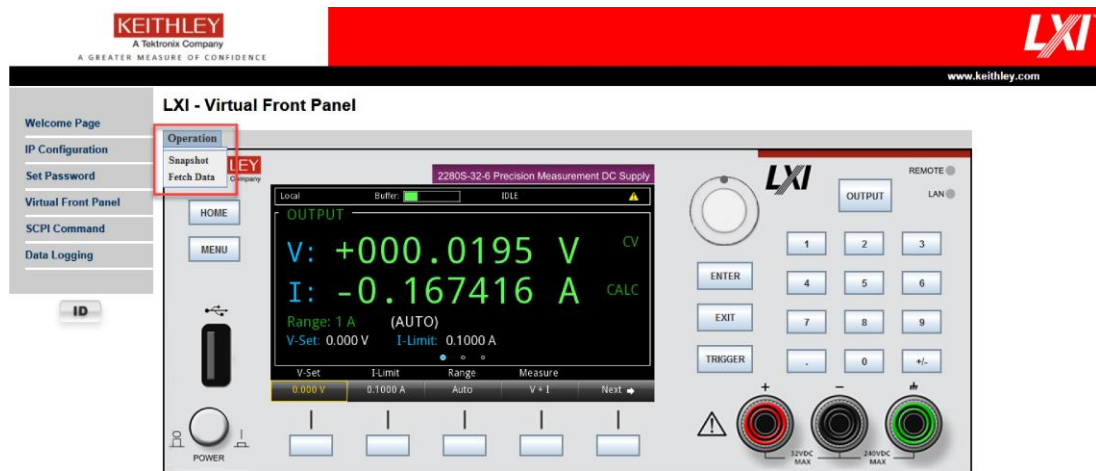

4. Select **Snapshot**. A dialog box indicating Screen Snapshot copied to clipboard is displayed.
5. Select **OK**.
6. Paste the snapshot into your report.

To get buffered data:

1. From the navigation bar of the web interface home page, select **Virtual Front Panel**.
2. If you are prompted for a password, enter it and select **Submit**. The default password is `admin`.
3. In the left upper corner of the virtual front panel, select **Operation**. The Snapshot and Fetch Data options are displayed.

Figure 42: Series 2280 Virtual Front Panel

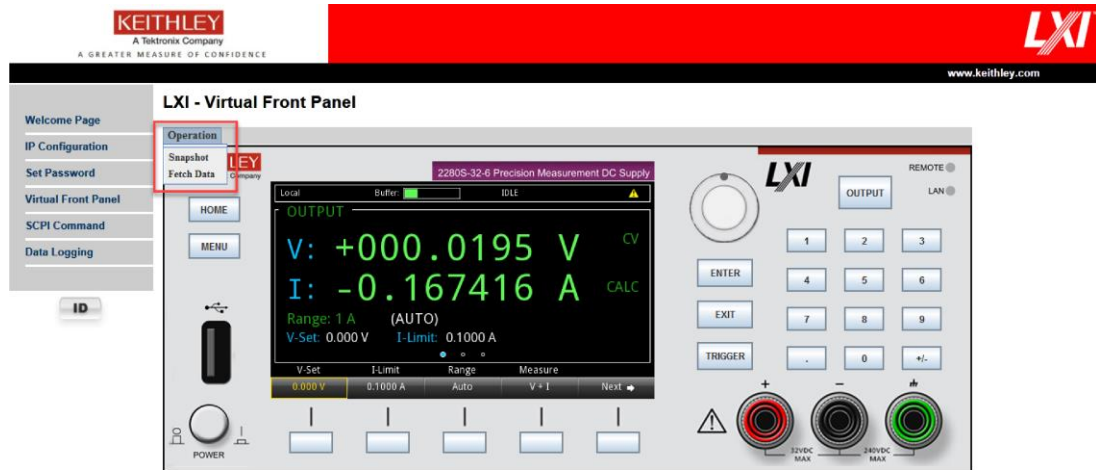

4. Select **Fetch Data**. A dialog box indicating `Copying completed: 100%` is displayed.
5. Select **OK**.
6. Paste the data into your report.

Control the instrument through the virtual front-panel web page

You can operate the instrument using the virtual front panel shown in the figure below.

Figure 43: Series 2280 LXI virtual front panel

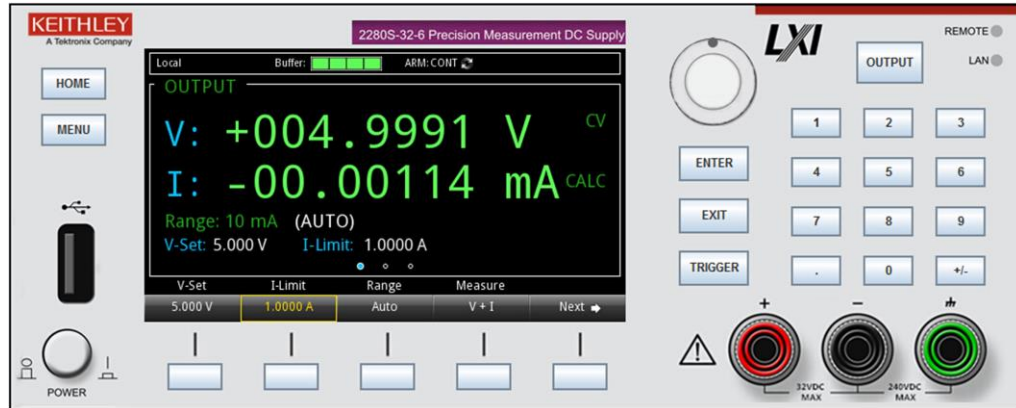

For more information about using the virtual front panel, refer to [Front-panel user interface](#) (on page 2-4).

NOTE

The Series 2280 only allows fewer than three clients to open the virtual front panel web page at the same time. Only the first successfully connected client can operate the instrument. Other clients can only view the virtual front panel.

Send SCPI commands through the web interface

You can send SCPI commands from the web interface.

To send SCPI commands using the web page:

1. From the navigation bar on the left, select **SCPI command**. The web page is displayed as follows.

Figure 44: SCPI command web page

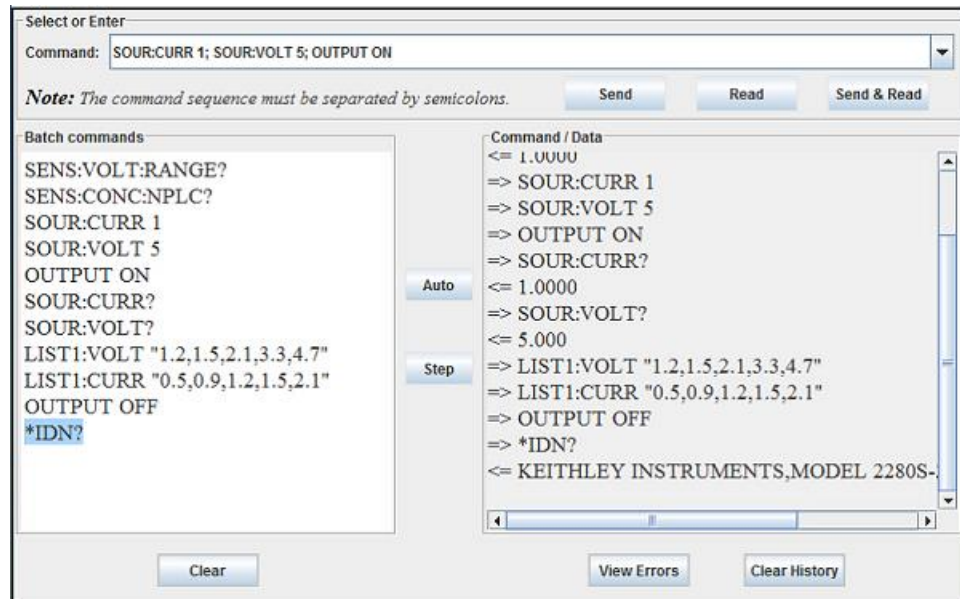

2. In the **Command** box, enter the SCPI command. You can enter a single command or batch commands, as shown in the figure.
3. Select **Send** to send the command to the instrument.
4. Select **Read** to get the returned value for a query command.
5. Select **Send & Read** to send a command and read the response from the instrument.
6. Select **View Errors** to get the oldest error in the event log and remove it.
7. Select **Clear** to clear all the history information shown on the web page.

NOTE

If you enter batch commands in the command box and select **Auto**, you will run the batch commands automatically, one-by-one. Select **Step** to stop the automatic run of the batch commands.

If you select **Step**, you will run the batch commands manually, one at a time. You can select any command from the left panel to start running the batch. You can edit the commands that are displayed in the left panel.

Data logging

You can save test data on the web interface to expand the data buffering. This function is useful when you monitor the device under test (DUT) for a long period.

To log data on the web interface:

1. From the navigation bar of the web interface home page, select **Data Logging**. The following screen is displayed.

Figure 45: Data logging web page

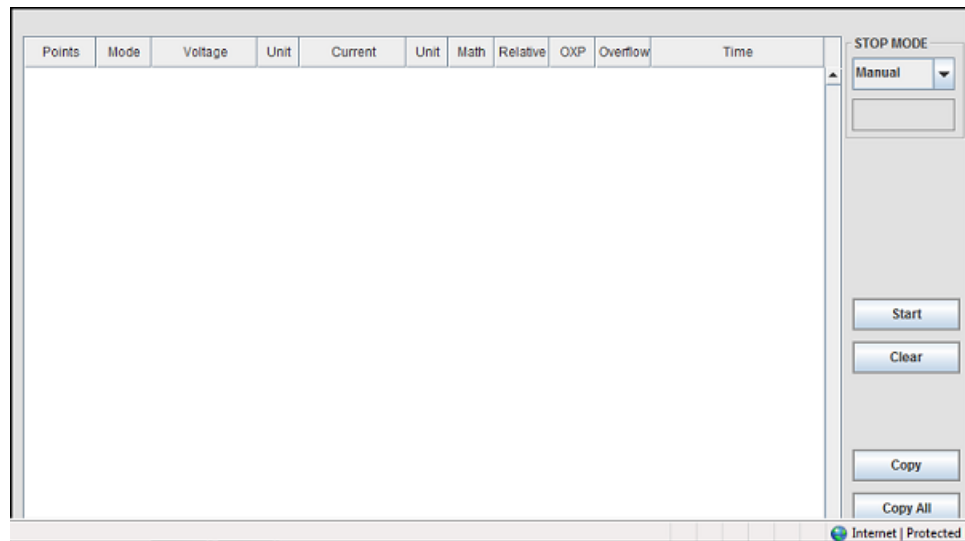

NOTE

There are three ways to log data on the web page:

- There is a **STOP MODE** box in the upper right corner of the screen. If you choose **Manual**, you start and stop the data logging manually.
- If you choose **Time (ms)**, the data logging stops at the preset time limit.
- If you choose **Points**, the data logging stops at the preset point limit.

2. Select **Start** on the right side of the screen to start logging test data on the web page.

3. If the data logging mode is set to Manual, select **Stop** on the right side of the screen to stop logging test data. If the mode is set to Time or Point, the logging will stop automatically when the time or point limit is reached. The data is logged as shown in the following figure:

Figure 46: Data logged on web page

LXI - Data Logging

Points	Mode	Voltage	Unit	Current	Unit	Math	Relative	OXP	Overflow	Time
1	CV	5.000022	V	-2.707075E-6	A	0	0	0	0	2013-06-30 20:44:50.1589
2	CV	5.000038	V	-2.706401E-6	A	0	0	0	0	2013-06-30 20:44:50.2853
3	CV	4.999992	V	-2.702974E-6	A	0	0	0	0	2013-06-30 20:44:50.4118
4	CV	5.0001044	V	-2.703817E-6	A	0	0	0	0	2013-06-30 20:44:50.5382
5	CV	4.99997	V	-2.7193792E-6	A	0	0	0	0	2013-06-30 20:44:50.6646
6	CV	5.0000443	V	-2.7096035E-6	A	0	0	0	0	2013-06-30 20:44:50.7911
7	CV	5.000008	V	-2.72039E-6	A	0	0	0	0	2013-06-30 20:44:50.9175

STOP MODE: Manual

Start

Clear

Copy

Copy All

Vmax V Imax A

Vmin V Imin A Electric Charge mAh

Vavg V Iavg A

Some of the fields in this pane are explained in the following table. Math, Relative, OXP, and Overflow settings visible in the table are saved in the instrument setup. You can save and recall special setups before using the data logging function; see [Saving setups](#) (on page 2-82) for more information.

Name	Description
Math	If you set a function to calculate the logged data, 1 will be displayed in the cell in this column. 0 means the data will not be calculated in a function. For more information about this function, refer to Math calculations that you can apply to measurements (on page 4-11).
Relative	In this column, 1 means the deviation caused by the line resistor is cancelled; 0 means the deviation is not cancelled. For more details about this setting, refer to Relative offset (on page 4-12).
OXF	In this column, 1 means any kind of protection is enabled; 0 means that no protection is enabled. For more details about this setting, refer to Protection (on page 2-78).
Overflow	In this column, 1 means the current has exceeded the preset current range; 0 means the current is within the range. For more details about this setting, refer to Setting overcurrent protection limits (on page 2-80).
Clear	If you select this button, all the data logged will be cleared.
Copy	If you select some rows in the logged data table and select Copy , you can then paste the data into your report.
Copy all	If you select Copy all , you can paste all the logged data into your report.

USB communications

To use the rear-panel USB port, you must have the Virtual Instrument Software Architecture (VISA) layer on the host computer. See [How to install the Keithley I/O Layer](#) (on page 2-69) for more information.

VISA contains a USB-class driver for the USB Test and Measurement Class (USBTMC) protocol that, once installed, allows the Microsoft Windows operating system to recognize the instrument.

When you connect a USB device that implements the USBTMC or USBTMC-USB488 protocol to the computer, the VISA driver automatically detects the device. Note that the VISA driver only automatically recognizes USBTMC and USBTMC-USB488 devices. It does not recognize other USB devices, such as printers, scanners, and storage devices.

In this section, "USB instruments" refers to devices that implement the USBTMC or USBTMC-USB488 protocol.

Using USB

To communicate from a computer to the instrument you need a USB cable with a USB Type B connector end and a USB type A connector end. You need a separate USB cable for each instrument you plan to connect to the computer at the same time using the USB interface.

To connect an instrument to a computer using USB:

1. Connect the Type A end of the cable to the computer.
2. Connect the Type B end of the cable to the instrument.
3. Turn on the instrument power. When the computer detects the new USB connection, the Found New Hardware Wizard starts.
4. If the "Can Windows connect to Windows Update to search for software?" dialog box opens, select **No**, and then select **Next**.
5. On the "USB Test and Measurement device" dialog box, select **Next**, and then select **Finish**.

Communicate with the instrument

For the instrument to communicate with the USB device, you must use NI-VISA™. VISA requires a resource string in the following format to connect to the correct USB instrument:

```
USB0::0x05E6::0x2280::[serial number]::INSTR
```

Where:

0x05e6 = The Keithley Instruments vendor ID

0x2280 = The instrument model number

[serial number] = The serial number of the instrument (the serial number is also on the rear panel)

INSTR = Use the USBTMC protocol

To determine these parameters, you can run the Keithley Configuration Panel, which automatically detects all instruments connected to the computer.

If you installed the Keithley I/O Layer, you can access the Keithley Configuration Panel through the Microsoft® Windows® Start menu.

To use the Keithley Configuration Panel to determine the VISA resource string:

1. Select **Start > Programs > Keithley Instruments > Keithley Configuration Panel**. The Select Operation dialog box is displayed.
2. Select **Add**.

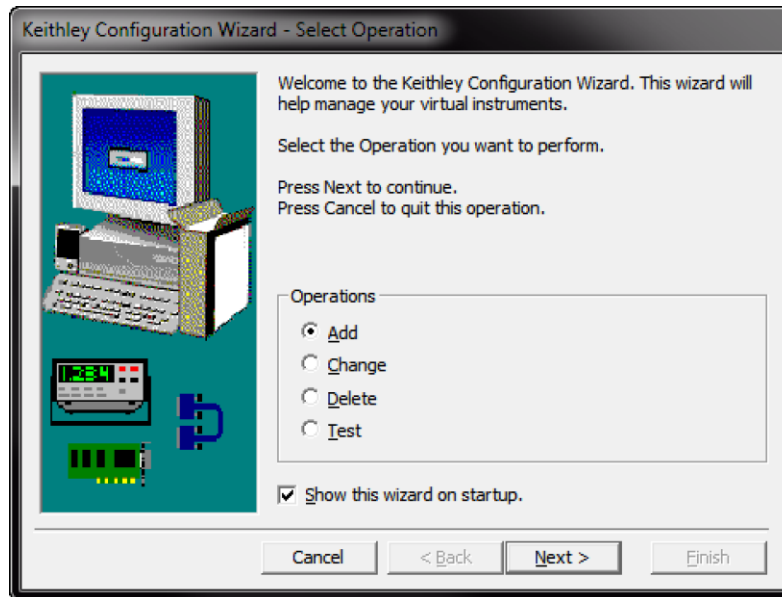

3. Select **Next**. The Select Communication Bus dialog box is displayed.

Figure 47: Select Communication Bus dialog box

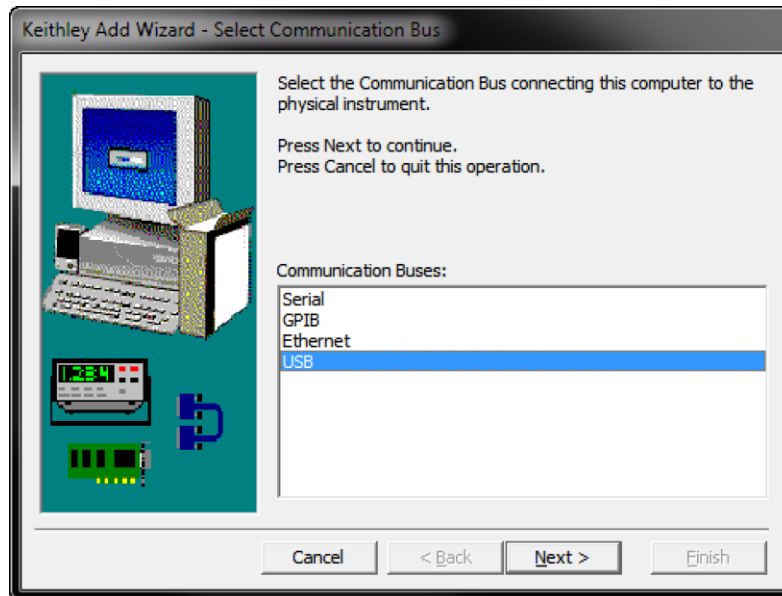

4. Select **USB**.
5. Select **Next**. The Select Instrument Driver dialog box is displayed.

Figure 48: Select Instrument Driver dialog box

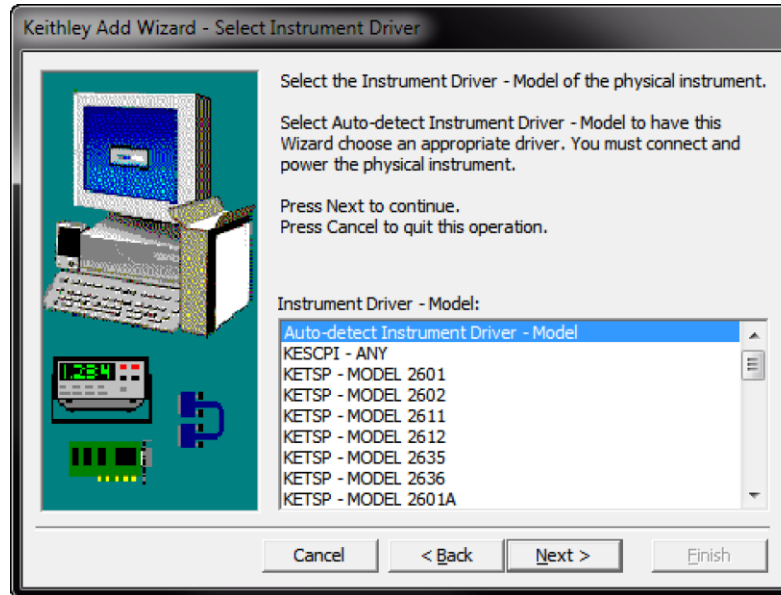

6. Select **Auto-detect Instrument Driver - Model**.
7. Select **Next**. The Configure USB Instrument dialog box is displayed with the detected instrument VISA resource string visible.

8. Select **Next**. The Name Virtual Instrument dialog box is displayed.

Figure 49: Name Virtual Instrument dialog box

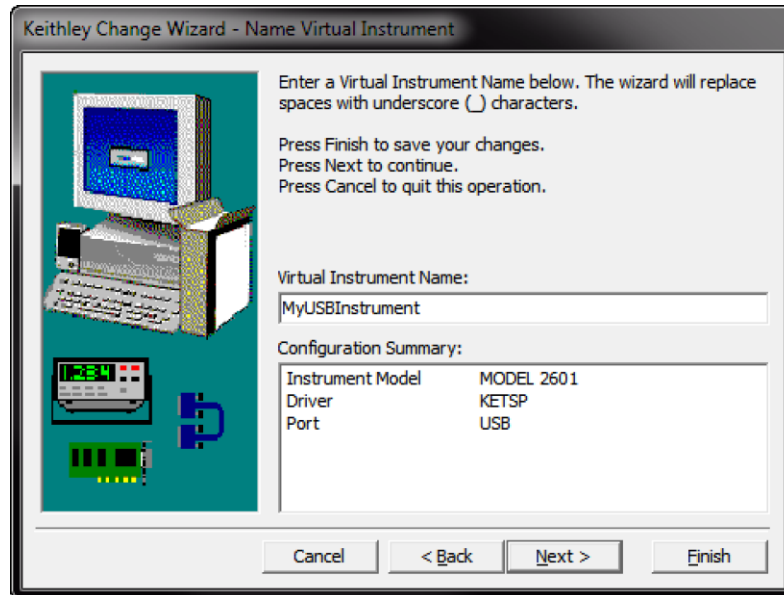

9. In the Virtual Instrument Name box, enter a name that you want to use to refer to the instrument.
10. Select **Finish**.
11. Select **Cancel** to close the Wizard.
12. Save the configuration. From the Configuration Utility, select **File > Save**.
13. In the Keithley Communicator, select **File > Open Instrument** to open the instrument you just named.

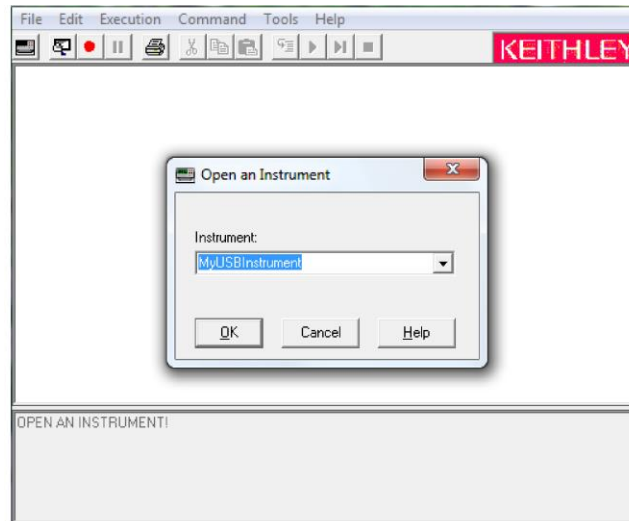
Figure 50: Keithley Communicator Open an Instrument

14. Select **OK**.
15. Send a command to the instrument and see if it responds.

NOTE

If you have a full version of NI-VISA on your system, you can run NI-MAX or the VISA Interactive Control utility. See the National Instruments (NI™) documentation for information.

If you have a full version of TEK-VISA on your system, you can run Openchoice Instrument Manager. See the Tektronix documentation for information.

If you have the Keysight IO Libraries Suite on your system, you can run Keysight Connection Expert to check your USB instruments. See the Keysight documentation for information.

How to install the Keithley I/O Layer

NOTE

Before installing, it is a good practice to check the [Product Support web page \(tek.com/product-support\)](http://tek.com/product-support) to see if a later version of the Keithley I/O Layer is available. Search for Keithley I/O Layer.

You can download the Keithley I/O Layer from the Keithley website.

The software installs the following components:

- Microsoft® .NET Framework
- NI™ IVI Compliance Package
- NI-VISA™ Run-Time Engine
- Keithley SCPI-based Instrument IVI-C driver
- Keithley I/O Layer

To install the Keithley I/O Layer from the Keithley website:

1. Download the Keithley I/O Layer Software from the [Product Support web page \(tek.com/product-support\)](http://tek.com/product-support), as described above. The software is a single compressed file and should be downloaded to a temporary directory.
2. Run the downloaded file from the temporary directory.
3. Follow the instructions on the screen to install the software.
4. Reboot your computer to complete the installation.

Set voltage and current limit

Before you source voltage and current, you should specify a voltage and current limit.

To configure the limit using the front-panel home screen:

1. Press the **HOME** key. The home screen is displayed.
2. Press the **Voltage** or **I-Limit** soft key. The editing window is displayed at the bottom of the screen.

Enter a value using the numerical keys on the right side of the front panel. Also, you can change the value using the arrows or navigation control.

NOTE

When the output is turned on, changing the value using the navigation control will change the source voltage and current instantly. Make sure that the output does not damage your device under test (DUT).

To configure the limit from the front-panel Source Settings screen:

1. Press the **Menu** key.
2. Under Source, select **Settings**.
3. For voltage, select the button next to **Voltage** and enter a value.
4. For current, select the button next to **I-Limit** and enter a value.

NOTE

If the limit setting is out of range, a warning message is displayed in the editing window.

To set voltage and current limit separately, send the following commands:

```
VOLTage 10  
CURRent 2
```

Constant voltage (CV) and constant current (CC) mode

The Series 2280 power supplies feature a constant voltage and constant current automatic crossover. This feature permits continuous operation in the transition from constant-voltage mode to constant-current mode as the load changes. Where the current setting (I_{set}) and the voltage setting (V_{set}) intersect is known as the crossover point (see the following figure).

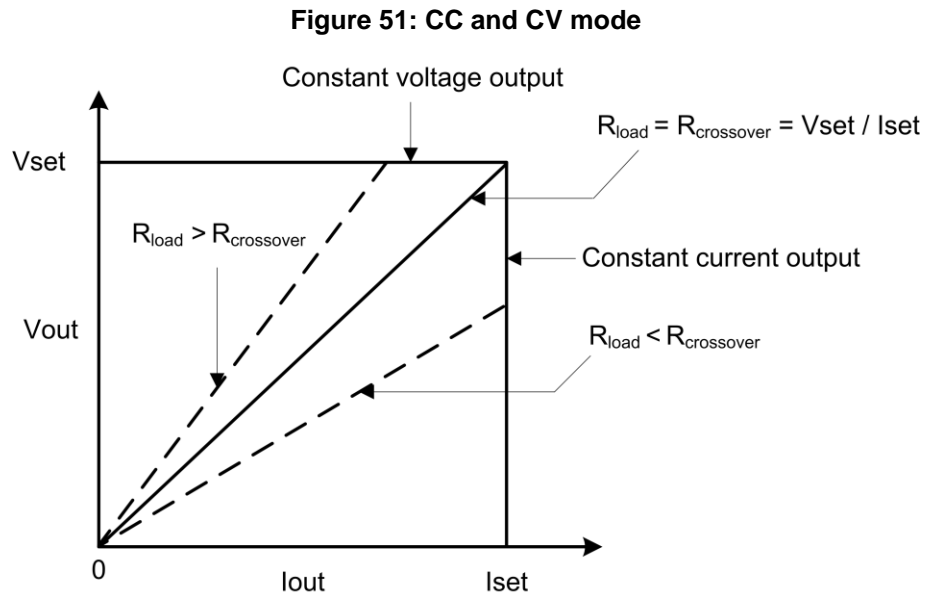

For example, if the resistive load is such that the power supply is operating in constant-voltage mode, the power supply provides a regulated output voltage. As the load increases, the output voltage remains constant until the preset current limit is reached. Then the crossover occurs.

Once the crossover occurs, the voltage drops in proportion to further load increases as the output current becomes constant. The front panel will indicate the state of constant current or constant voltage by indicating CC or CV. If CC is shown, the instrument is operating in constant-current mode. If CV is shown, the instrument is operating in constant-voltage mode.

For this example, connect a $5\ \Omega$ resistor to the binding posts on the front panel, set the voltage to 5 V and current limit to 2.5 A, and turn on the output. The power supply is operating in CV mode. For details, refer to the following figure.

Figure 52: Constant voltage mode

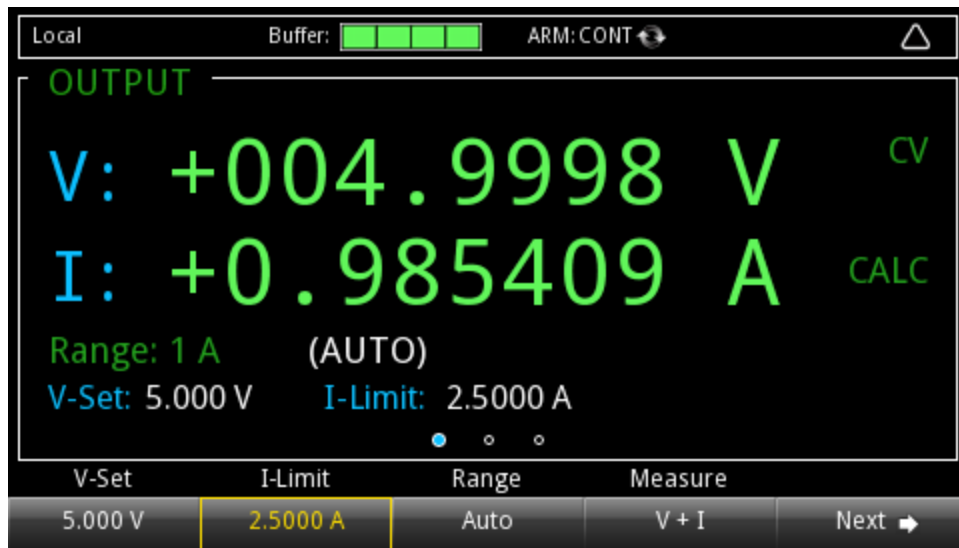

Crossover from the constant-voltage mode to the constant-current mode also occurs automatically in response to an increase in load. For example, connect a 5 Ω resistor to the binding posts on the front panel, set the voltage to 25 V and current limit to 1.0 A, and turn on the output. The power supply is operating in CC mode. For details, refer to the following figure.

Figure 53: Constant current mode

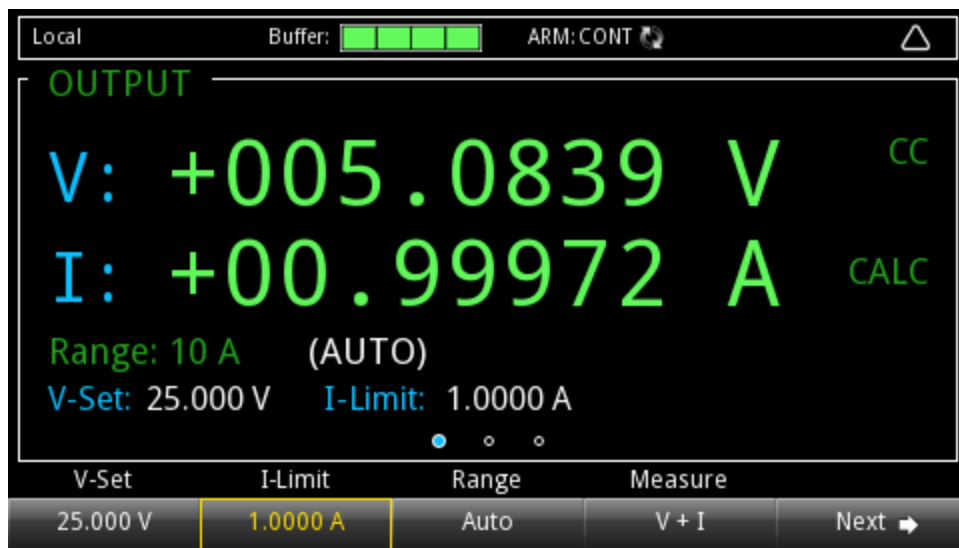

You can use the `:FORMat:ELEMents` SCPI command to set the constant current or constant voltage mode.

To set the constant current mode, send:

```
:FORMat:ELEMents "MODE, CC"
```

To set the constant voltage mode, send:

```
:FORMat:ELEMents "MODE, CV"
```

To turn off the constant current or constant voltage mode, send:

```
:FORMat:ELEMents "MODE, OFF"
```

For additional information about the `:FORMat:ELEMents` command, see [:FORMat:ELEMents](#) (on page 7-14).

Select a measurement function

The Series 2280 allows you to perform the following measurement functions.

Measurement functions	What the instrument measures
Concurrent (V + I)	Measure voltage and current at the same time
Voltage (V)	Only measure voltage
Current (I)	Only measure current

To select the function from the front-panel:

1. Press the **Menu** key.
2. Under Measure, select **Settings**.
3. Select the button next to **Function** and press the **ENTER** key. The selection window is displayed.
4. Select a measurement function.

NOTE

You can also select the measurement function from home screen 1. In soft key area 1, press the **Measure** soft key. The selection window is displayed. Select a measurement function.

To configure the measurement function using SCPI commands:

To measure voltage only, send the command:

```
SENSe:FUNctIon "VOLTage"
```

Select a specific measurement range

You can set specific measurement ranges or allow the instrument to choose the ranges automatically.

The measurement range determines the full-scale input for the measurement. The measurement range also affects the accuracy of the measurements and the maximum signal that can be measured.

NOTE

Selecting a lower measurement range can increase measurement accuracy, but the measurement must not exceed the range. If the measurement exceeds the range, an "Overflow" error will occur.

The Series 2280 has multiple current measurement ranges and one voltage range. These ranges are listed in the following table.

Model	Current measurement range	Voltage measurement range
2280S-32-6	10 A	32 V
	1 A	
	100 mA	
	10 mA	
2280S-60-3	10 A	60 V
	1 A	
	100 mA	
	10 mA	

Selecting a specific measurement range

NOTE

You must set the measurement function before you can set the measurement range. If you set the measurement range to a specific value, measurement autoranging is disabled.

To ensure the best accuracy and resolution when selecting a measurement range, use the lowest range possible that does not cause an overflow error.

To select a measurement range using the front-panel home screen:

1. Press the **HOME** key and select the **Range** key. The Range dialog box is displayed.
2. Use the up and down arrows to select the range. The home page is displayed again with the selected value.

To select a measurement range using the front-panel Measure Settings screen:

1. Press the **MENU** key.
2. Under Measure, select **Settings**.
3. Select the button next to **Range**. The Range dialog box is displayed.
4. Select the range.

If the instrument displays an overflow message, select a higher range.

NOTE

You can set specific measurement ranges or allow the instrument to choose the ranges automatically.

For a current measurement, send the command:

```
SENSe:CURRent:RANGe <n>
```

Where <n> is the positive full-scale value of the measurement range.

To set the range for a concurrent measurement, send the command:

```
SENSe:CONCurent:RANGe <n>
```

For voltage measurements, the instrument supports only one range.

NOTE

You can set specific measurement ranges or allow the instrument to choose the ranges automatically.

Using autoranging for current measurements

When measurement autoranging is selected, the instrument automatically selects the best range to measure the signal. If the measurement reaches 120 percent of the present range (except for the 10 A range), the instrument changes the measurement range to the next higher range. If the measurement reaches 80 percent to 90 percent of the next lower range, the instrument changes the range to the next lower range.

If you enable measurement autoranging, the measurement range is changed when a measurement is made.

To read the measurement range that the instrument chose, you must query the range after a measurement is made.

NOTE

You must set the measurement function before the measurement range can be set.

If you set the measurement range manually for a function, measurement autoranging is automatically turned off for that function and remains off until you enable it again.

To select measurement autoranging using the front-panel home screen:

1. Press the **HOME** key.
2. Press the soft key under Range. The Range dialog box is displayed.
3. Select **AUTO**. The home screen is displayed with autoranging enabled.

To select measurement autoranging using the front-panel Measure Settings screen:

1. Press the **MENU** key.
2. Under Measure, select **Settings**.
3. Select the button next to **Range**. The Range dialog box is displayed.
4. Select **AUTO**.

NOTE

You can set specific measurement ranges or allow the instrument to choose the ranges automatically.

To set the current measurement range, send the command:

```
:SENSe:CURRent:RANGe:AUTO ON
```

To set the concurrent measurement range, send the command:

```
:SENSe:CONCurent:RANGe:AUTO ON
```

NOTE

You can set specific measurement ranges or allow the instrument to choose the ranges automatically.

Protection

The Series 2280 provides several methods for ensuring that the source remains within certain values. This helps to protect the device under test (DUT) from damage.

The protection settings that affect the source are:

- [Overvoltage protection](#) (on page 2-78). This is the voltage at the instrument terminals.
- [Overcurrent protection](#) (on page 2-79). This is the current at the instrument terminals.
- [Maximum voltage limits](#) (on page 2-82). This is the sourced voltage value at the device.

The Series 2280 also provides overtemperature protection to prevent damaging heat build-up.

Overvoltage protection

Overvoltage protection restricts the maximum voltage level that the instrument can source. This protects the device under test (DUT) from high voltage levels.

For example, if a sense lead is disconnected or broken during a 4-wire sense measurement, the instrument can interpret the missing sense lead as a decrease in voltage and respond by increasing the source output. If overvoltage protection is set, the sourced output is not allowed to exceed the overvoltage protection limit.

When overvoltage protection is set and the sourced voltage exceeds the setting:

- The output is turned off.
- On the home screen, an indicator to the right of the voltage displays *OVP*.
- An error is generated. For more information, refer to [Overprotection error](#) (on page 2-81).

When overvoltage protection is used in a test sequence, it should be set before turning the source on.

WARNING

Even with the overvoltage protection set to the lowest value, never touch anything connected to the terminals of the Series 2280 when the output is on. Always assume that a hazardous voltage (greater than 30 V RMS) is present when the output is on. To prevent damage to the DUT or external circuitry, do not set the voltage source to levels that exceed the value that is set for overvoltage protection.

Setting overvoltage protection limits

Overvoltage protection has a default value of the maximum output.

To set overvoltage protection using the front panel:

1. Press the **MENU** key.
2. Under Source, select **Protect**.
3. Select **OVP** and set the limit.
4. Select **HOME** to return to the operating display.

To set overvoltage protection using SCPI commands:

To set the overvoltage limit for the voltage source to 20 V, send the command:

```
:VOLTage:PROTection 20
```

See the command description for [\[:SOURce\[n\]\]:<function>:PROTection\[:LEVel\]](#) (on page 7-76) for the full list of options.

Overcurrent protection

Overcurrent protection restricts the maximum current level that the instrument can source. This protects the device under test (DUT) from high current levels.

For example, if a sense lead is disconnected or broken during a 4-wire sense measurement, the instrument can interpret the missing sense lead as a decrease in voltage and respond by increasing the source output. If overcurrent protection is set, the sourced output is not allowed to exceed the overcurrent protection limit.

When overcurrent protection is set and the sourced voltage exceeds the setting:

- The output is turned off.
- On the front panel, an indicator to the right of the voltage displays **OCP**.
- An error is generated. For more information, refer to [Overprotection error](#) (on page 2-81).

When overcurrent protection is used in a test sequence, it should be set before turning the source on.

WARNING

Even with the overcurrent protection set to the lowest value, never touch anything connected to the terminals of the Series 2280 when the output is on. Always assume that a hazardous voltage (greater than 30 V RMS) is present when the output is on. To prevent damage to the DUT or external circuitry, do not set the current source to levels that exceed the value that is set for overcurrent protection.

Setting overcurrent protection limits

To set overcurrent protection using the front panel:

1. Press the **MENU** key.
2. Under Source, select **Protect**.
3. Select **OCP** and set the limit.
4. Select **HOME** to return to the operating display.

To set overcurrent protection using SCPI commands:

To set the overcurrent limit for the current source to 4 A, send the command:

```
:CURRent:PROTection 4
```

See the command description for [\[:SOURce\[n\]\]:<function>:PROTection\[:LEVel\]](#) (on page 7-76) for the full list of options.

Overtemperature protection

To prevent damaging heat build-up and ensure specified performance, make sure there is adequate ventilation and air flow around the instrument to ensure proper cooling. Do not cover the ventilation holes on the top, sides, or bottom of the instrument.

Even with proper ventilation, the instrument can overheat in the following situations:

- If the ambient temperature is too high.
- If you use the instrument as a power sink for long periods.

If the instrument overheats, the output is turned off and an event message is displayed.

CAUTION

If an overtemperature condition occurs, turn off the instrument and allow it to cool for 30 minutes. You cannot turn the output on until the instrument cools down. Verify that there is adequate ventilation. When you return power to the instrument, verify that the cooling fan is running. If not, contact Keithley Instruments. Leaving the instrument turned on with the failure message displayed or with an inoperative cooling fan may result in damage to the instrument.

Overprotection error

When an overcurrent, overvoltage, or overtemperature protection error occurs, the instrument:

- Generates an overprotection error message.
- Displays an error dialog box is displayed.
- Turns off the output.
- Resets the voltage setting value and current limit to defaults.
- Sets the digital I/O line 3 to logic high.

To clear the error, you need to clear the Questionable Instrument Summary Event Register bit and initiate the trigger model using the front panel or SCPI commands. For more information on registers, refer to [Questionable Instrument Summary Event Register](#) (on page D-16).

Figure 54: Overprotection error dialog box

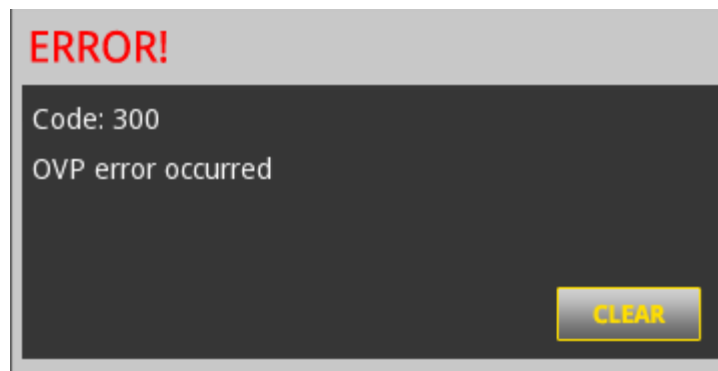

To clear an overprotection error using the front panel:

When the overprotection error dialog box is displayed, you can press the **ENTER** key to initiate the trigger model.

To clear an overprotection error using a SCPI command:

When an overprotection error occurs, send the following command to clear the register and initiate the trigger model:

```
:OUTPut:PROTection:CLEar
```

Maximum voltage limits

The maximum voltage limits prevent the instrument from sourcing a voltage over a maximum voltage limit. This helps prevent damage to the device under test (DUT).

You cannot specify a voltage setting over the maximum voltage limit. If you set a maximum voltage limit that is smaller than the voltage source value, the source value is automatically changed to the maximum voltage limit.

Setting maximum voltage limits

To set the maximum voltage limit using the front panel:

1. Press the **MENU** key.
2. Under Source, select **Protect**.
3. Select **VMax** and set the limit.
4. Select **HOME** to return to the operating display.

To set the maximum voltage limit using SCPI commands:

Send the `:SOURce:VOLTage:LIMit` command with the value of the limit. For example, to set the voltage limit for the current source to 25 V, send the command:

```
:VOLTage:LIMit 25
```

See the command description for [\[:SOURce\[n\]\]:<function>;PROTection\[:LEVel\]](#) (on page 7-76) for the full list of options.

Saving setups

You can save the present settings that you have defined for the Series 2280 to internal memory.

After the settings are saved, you can recall the settings. You can also set them to be the default settings on power up.

Save a user setup

You can save a user setup to internal nonvolatile memory or an external USB flash drive.

To save a user setup to internal nonvolatile memory using the front panel:

1. Configure the Series 2280 to the settings that you want to save.
2. Press the **MENU** key.
3. Under System, select **Save/Recall**.
4. Select the button next to **Save** and press the **ENTER** key. The Save/Recall Location window is displayed.
5. Select a location to save the setup and press **ENTER**. A keyboard is displayed.
6. Use the keyboard to enter the name of the setup.
7. Press the **ENTER** key. The setup is added to internal memory.

To save a user setup to external USB flash drive using the front panel:

1. Press the **MENU** key.
2. Under System, select **Save/Recall**.
3. Select the button next to **Save** and press the **ENTER** key. The Save/Recall Location window is displayed.
4. Select **Save to USB** and press the **ENTER** key. A keyboard is displayed.
5. Use the keyboard to enter the name of the setup.
6. Press the **ENTER** key. The setup is saved to external USB flash drive.

To save a user setup to internal nonvolatile memory using SCPI commands:

Configure the instrument to the settings that you want to save. To save the setup, send the command:

```
*SAV <n>
```

Where <n> is an integer between 1 and 5.

NOTE

The setup saved through the *SAV command have the name `SETUPx`, where *x* is the value you set for <n>.

To save a user setup to external USB flash drive using SCPI commands:

Send the command:

```
:MMEMory:SAVE:SETup "mysetup"
```

Save the present setup to the external USB flash drive as `mysetup`.

Recall a user setup

You can recall setups from internal nonvolatile memory or external USB flash drive. When you recall a setup, the instrument returns to the settings that are saved in memory.

To recall a saved setup from internal nonvolatile memory using the front panel:

1. Press the **MENU** key.
2. Under System, select **Save/Recall**.
3. Select the button next to **Recall** and press the **ENTER** key. The Save/Recall Location window is displayed.
4. Select a saved setup in the pop-up window.
5. Press the **ENTER** key. The selected setup is applied to the instrument.

To recall a saved setup from external USB flash drive using the front panel:

1. Press the **MENU** key.
2. Under System, select **Save/Recall**.
3. Select the button next to **Recall** and press the **ENTER** key. The Save/Recall Location window is displayed.
4. Select **Recall From USB** and press the **ENTER** key. The Save/Recall Location window is displayed.
5. Select a saved setup in the pop-up window.
6. Press the **ENTER** key. The selected setup is applied to the instrument.

To recall a user setup from internal memory using SCPI commands:

```
*RCL <n>
```

Where `<n>` is an integer between 1 and 5 that represents the saved setup.

To recall a user setup from external USB flash drive using SCPI commands:

```
:MMEMory:LOAD:SETup "mysetup"
```

Recall the setup named `mysetup` in the external USB flash drive to the instrument.

Specify a default setup

You can specify a default setup that is applied immediately after the instrument is powered on.

To save a default setup to internal nonvolatile memory from the front panel:

1. Press the **MENU** key.
2. Under System, select **Save/Recall**.
3. Select the button next to **Auto Load Setup1** and press the **ENTER** key.
4. Select **On** and press **ENTER**.

NOTE

You must save your configuration under setup 1, or it will not be applied when the instrument power is turned on.

You can also enable the default setup by sending the SCPI command:

```
:SYSTem:POSetup:STATe
```

Using the event log

The event log records errors that are reported by the instrument. The event log can hold up to 64 errors. When more than 64 errors are in the event log, the oldest error is removed when a new event is received.

Information provided for each event log entry

Each event log entry includes the following information:

- The time when the event occurred; this includes the date for the first entry after power up.
- The code number of the event; this number can be used with the status model to map events to bits in the event registers.
- The description of the event.

To access the event log listing from the front panel:

1. Press the **MENU** key.
2. Under System, select **Event Log**. A list of errors is displayed.
3. If the errors fill the page, you can scroll down to see additional errors.

Save the event log to an external flash drive

To save the event log to a USB flash drive from the front panel:

1. Press the **MENU** key.
2. Under System, select **Event log**.
3. Select the **Export to USB** button and press the **ENTER** key. The saving dialog box is displayed.
4. Press the **Yes** soft key. The event log is saved as `eventlog.csv` on the USB flash drive.

To save the event log to a USB flash drive using SCPI commands:

Configure the instrument to the settings that you want to save. To save the setup with the name `myerror.csv`, send the command:

```
:SYSTem:EVENTlog:SAVE "myerror"
```

Clear the event log

To clear the event log from the front panel:

1. Press the **MENU** key.
2. Under System, select **Event log**.
3. Select the **Clear Event Log** button and press the **ENTER** key. The clear dialog box is displayed.
4. Press the **Yes** soft key. The instrument clears all errors stored in the internal memory.

To clear the event log using SCPI commands:

```
SYSTem:ERRor:CLear
```

System information

To view system information from the front panel:

1. Press the **MENU** key.
2. Under System, select **Information**. The system information displays.
3. To return to the home page, press the **HOME** key.

To view system information using SCPI commands:

To retrieve the manufacturer, model number, serial number, and firmware version, send the command:

```
*IDN?
```

To read the line frequency, send the command:

```
SYSTem:LFRequency?
```

The firmware build, memory available, and calibration date are not available when using SCPI commands.

Instrument sounds

The instrument emits a short beep when a front-panel key is pressed.

To turn the error beeper on or off from the front panel:

1. Press the **MENU** key.
2. Under System, select **Settings**.
3. Next to Beeper, select **On** or **Off**.

To turn the error beeper on or off using SCPI commands:

```
SYSTem:BEEPer:ERRor ON  
SYSTem:BEEPer:ERRor OFF
```

To turn the key clicks on or off from the front panel:

1. From the home page, press the **MENU** key.
2. Under System, select **Settings**.
3. Next to Key Click, select **On** or **Off**.

To turn the key clicks on or off using SCPI commands:

```
SYSTem:KCLick ON  
SYSTem:KCLick OFF
```

Resets

There are several types of resets in the Series 2280.

In general, the terms "reset," "instrument reset," and "system reset" refer to the reset that is performed when you send the `*RST` or `:SYSTem:PRESet` command, or when you select **MENU > System > Settings > Reset** from the front panel. For more information about the settings that get reset, refer to [Reset default values](#) (on page 2-88). For more information about system reset, refer to the topic [Reset the instrument](#) (on page 2-88).

The instrument also responds to other types of resets. These resets include:

- **Password reset:** This resets the instrument password to its default value. You can reset the password by pressing the **MENU** key and under System, selecting **Settings > System Password**. The default password is `admin`. For more information, see [Instrument access](#) (on page 3-1).
- **LAN reset:** This resets the LAN settings and the instrument password to the system default values. You can reset the password by pressing the **MENU** key, selecting Communication (under System), selecting LXI LCI, and pressing the **ENTER** key.
- **Status preset:** This resets all bits in the status model. If you are using the SCPI command set, refer to [:STATus:PRESet](#) (on page 7-105).

Reset the instrument

You can reset many of the instrument settings to their default values. For details about what gets reset, see [Reset default values](#) (on page 2-88). Default values are also listed in the individual command descriptions.

To reset the instrument using the front panel:

1. Press the **MENU** key.
2. Under system, select **Manage**.
3. Select **System Reset**.
4. The commands are reset and a confirmation message is displayed.

To reset the instrument using SCPI commands:

Send the command:

```
:SYSTem:PRESet
```

Reset default values

When you turn instrument power on and off or send a reset command, many of the settings in the instrument are reset to their default values.

The settings that are affected are listed in the following tables. The tables show SCPI and front-panel values for each setting. They are grouped by function and sorted alphabetically in each group by the name of the SCPI command.

Math and statistics reset values

Setting*	Default value reset from MENU > System > Settings > Reset	Default value reset by the *RST (on page 7-7) command or :SYSTem:PRESet (on page 7-124) command
MENU > Measure > Math > Type :CALCulate[1]:<function>:FORMat (on page 7-21)	mx+b	MXB
MENU > Measure > Math > b (Offset) :CALCulate[1]:<function>:KMATH:MBFactor (on page 7-22)	+0.000e+0	0.0
MENU > Measure > Math > m (Gain) :CALCulate[1]:<function>:KMATH:MMFactor (on page 7-23)	+1.000e+0	+1.000000e+00
MENU > Measure > Math > Units :CALCulate[1]:<function>:KMATH:MUNits (on page 7-25)	X	"X"
MENU > Measure > Math > State :CALCulate[1]:<function>:STATe (on page 7-26)	Off	0 (Off)
MENU > Measure > Data Buffers > Statistics Format :CALCulate2:FORMat:ELEMents (on page 7-30)	All	"READ, UNIT"
MENU > Measure > Data Buffers > Statistics Function :CALCulate2:FUNCTion (on page 7-31)	Current	CURR
MENU > Measure > Data Buffers > Statistics :CALCulate2:FORMat (on page 7-28)	Minimum On Maximum On Peak-Peak On Mean On Std Dev On	MIN, MAX, MEAN, SDEV, PKPK
MENU > Measure > Data Buffers > Size :TRACe[n]:POINTs or :DATA[n]:POINTs (on page 7-142)	100	100
MENU > Measure > Data Buffers > Autoclear :TRACe[n]:CLEar:AUTO or :DATA[n]:CLEar:AUTO (on page 7-135)	On	1 (On)
MENU > Measure > Data Buffers > Mode :TRACe[n]:FEED:CONTrol or :DATA[n]:FEED:CONTrol (on page 7-141)	Always	ALW (Always)
MENU > Views > Sheet > Statistics :CALCulate2:STATe (on page 7-34)	Off	0 (Off)

* Some of the options listed in this table are only available for specific functions. If you do not see the option listed here on the menu, it may not be available for the function you are using.

Calibration reset values

Setting*	Default value reset from MENU > System > Settings > Reset	Default value reset by the *RST (on page 7-7) command or :SYSTem:PRESet (on page 7-124) command
Not available from front panel :CALibration:PROTeCted:STATe (on page 7-44)	Off	OFF
MENU > System > Settings > System Password > Calibration :CALibration:PROTeCted:CODE (on page 7-36)	"KI002280"	Not applicable

* Some of the options listed in this table are only available for specific functions. If you do not see the option listed here on the menu, it may not be available for the function you are using.

Digital I/O reset values

Setting*	Default value reset from MENU > System > Settings > Reset	Default value reset by the *RST (on page 7-7) command or :SYSTem:PRESet (on page 7-124) command
MENU > Trigger > Digital In/Out :DIGital:LINE<n>:FUNCTion (on page 7-45)	Line 1: Trigger In Line 2: Meter Out Line 3: Fault Out Line 4: Manual In Line 5: Manual In Line 6: Manual In	1: AUTO 2: AUTO 3: AUTO 4: MINP 5: MINP 6: MINP

* Some of the options listed in this table are only available for specific functions. If you do not see the option listed here on the menu, it may not be available for the function you are using.

Display reset values

Setting*	Default value reset from MENU > System > Settings > Reset	Default value reset by the *RST (on page 7-7) command or :SYSTem:PRESet (on page 7-124) command
MENU > System > Settings > Backlight Brightness :DISPlay:BRIGhtness (on page 7-47)	50	50
Not available from front panel :DISPlay:SCREen (on page 7-49)	Not applicable	HOME

* Some of the options listed in this table are only available for specific functions. If you do not see the option listed here on the menu, it may not be available for the function you are using.

Format reset values

Setting*	Default value reset from MENU > System > Settings > Reset	Default value reset by the *RST (on page 7-7) command or :SYSTem:PRESet (on page 7-124) command
Not available from front panel :FORMat:ELEMents (on page 7-14)	Not applicable	"READ, SOUR, UNIT, REL"

* Some of the options listed in this table are only available for specific functions. If you do not see the option listed here on the menu, it may not be available for the function you are using.

Output reset values

Setting*	Default value reset from MENU > System > Settings > Reset	Default value reset by the *RST (on page 7-7) command or :SYSTem:PRESet (on page 7-124) command
MENU > Source > Settings > Output :OUTPut:STATe (on page 7-59)	Off	0 (Off)
MENU > Source > Settings > Output Delay :OUTPut:DELAy:STATe (on page 7-56)	Off	0 (Off)
MENU > Source > Settings > Slew Rise :OUTPut:DELAy:RISing (on page 7-55)	100.0 V/s	0.0
MENU > Source > Settings > Slew Fall :OUTPut:DELAy:FALLing (on page 7-54)	100.0 V/s	0.0

* Some of the options listed in this table are only available for specific functions. If you do not see the option listed here on the menu, it may not be available for the function you are using.

Measurement reset values

Setting*	Default value reset from MENU > System > Settings > Reset	Default value reset by the *RST (on page 7-7) command or :SYSTem:PRESet (on page 7-124) command
MENU > Measure > Settings > Function :SENSe[n]:FUNCTION (on page 7-60)	V + I	"CONC:DC"
MENU > Measure > Settings > Range and HOME > Range :SENSe[n]:<function>:RANGe (on page 7- 67)	Concurrent: Auto (10 mA) Current: Auto (10 mA) Voltage: 20 V	Concurrent: 0.0100 Current: 0.0100 Voltage: 20.0000
MENU > Measure > Settings > Range HOME > Range :SENSe[n]:<function>:RANGe:AUTO (on page 7-69)	Concurrent: On Current: On Voltage: Off	Concurrent: 1 (On) Current: 1 (On) Voltage: Not applicable
MENU > Measure > Settings > Digits :SENSe[n]:<function>:DIGits (on page 7-65)	6.5	6
MENU > Measure > Settings > NPLC :SENSe[n]:<function>:NPLCycles (on page 7-66)	1.000	1.0000
MENU > Measure > Settings > Auto Zero :SYSTem:AZERo[n]:STATe] (on page 7- 111)	On	1 (On)
HOME > Resolution :SENSe[n]:<function>:RESolution (on page 7-73)	6.5	6
MENU > Measure > Rel/Filter > Type :SENSe[n]:<function>:AVERAge:TCOnTrol (on page 7-63)	Moving	MOV
MENU > Measure > Rel/Filter > Count :SENSe[n]:<function>:AVERAge:COUnT (on page 7-61)	10	10
MENU > Measure > Rel/Filter > Window :SENSe[n]:<function>:AVERAge:WINDow (on page 7-64)	1%	1.0000
MENU > Measure > Rel/Filter > Filter State :SENSe[n]:<function>:AVERAge[:STATe] (on page 7-62)	On	1 (On)
MENU > Measure > Rel/Filter > Reference :SENSe[n]:<function>:REFerence	+0.00000 A	0.0
MENU > Measure > Rel/Filter > Rel State :SENSe[n]:<function>:REFerence:STATe (on page 7-72)	Off	0 (Off)

* Some of the options listed in this table are only available for specific functions. If you do not see the option listed here on the menu, it may not be available for the function you are using.

Source reset values

Setting*	Default value reset from MENU > System > Settings > Reset	Default value reset by the *RST (on page 7-7) command or :SYSTEM:PRESet (on page 7-124) command
MENU > Source > Settings> I-Limit [:SOURce[n]]:<function>[:LEVel][:IMMEDIATE][:AMPLitude] (on page 7-77)	0.1000 A	0.1000
MENU > Source > Settings > V-Set [:SOURce[n]]:<function>[:LEVel][:IMMEDIATE][:AMPLitude]	0.000 V	0.0
MENU > Source > Settings > Slew Rise [:SOURce[n]]:VOLTage:SLEW:RISing (on page 7-79)	100.0 V/s	100.0000
MENU > Source > Settings > Slew Fall [:SOURce[n]]:VOLTage:SLEW:FALLing (on page 7-80)	100.0 V/s	100.0000
MENU > Source > Protect > Overcurrent Protection [:SOURce[n]]:<function>:PROTection[:LEVel] (on page 7-76)	6.10 A	6.10
MENU > Source > Protect > Overvoltage Protection [:SOURce[n]]:<function>:PROTection[:LEVel] (on page 7-76)	21.0 V	21.0
MENU > Source > Protect > Maximum Voltage [:SOURce[n]]:VOLTage:LIMit[:AMPLitude]	20.000 V	20.000
MENU > Source > Delay > Source Delay [:SOURce[n]]:DELay (on page 7-74)	0.00100 s	0.00100
MENU > Source > Delay > State [:SOURce[n]]:DELay:STATe (on page 7-75)	Off	0 (Off)
HOME > List > Mode [:SOURce[n]]:LIST:MCOMPLete (on page 7-86)	Sweep	SWEEP
HOME > List > Enable [:SOURce[n]]:LIST:STATe (on page 7-91)	Off	0 (Off)
HOME > List > Hold Time [:SOURce[n]]:LIST:HTIME (on page 7-84)	Point	POINT
HOME > List > End Zero [:SOURce[n]]:LIST:END:ZERO (on page 7-84)	Off	0 (Off)

* Some of the options listed in this table are only available for specific functions. If you do not see the option listed here on the menu, it may not be available for the function you are using.

Status model reset values

Setting*	Default value reset from MENU > System > Settings > Reset	Default value reset by the *RST (on page 7-7) command or :SYSTem:PRESet (on page 7-124) command
Not available from front panel :STATus:QUEStionable:ENABLE (on page 7-107)	—	0
Not available from front panel :STATus:QUEStionable:INSTrument:ENABLE (on page 7-108)	—	0
Not available from front panel :STATus:QUEStionable:INSTrument:ISUMmary:ENABLe (on page 7-109)	—	0
Not available from front panel :STATus:OPERation:ENABLE (on page 7-101)	—	0
Not available from front panel :STATus:OPERation:INSTrument:ENABLE (on page 7-102)	—	0
Not available from front panel :STATus:OPERation:INSTrument:ISUMmary:ENABLE (on page 7-104)	—	0
Not available from front panel :STATus:MEASurement:ENABLE (on page 7-95)	—	0
Not available from front panel :STATus:MEASurement:INSTrument:ENABLE (on page 7-97)	—	0
Not available from front panel :STATus:MEASurement:INSTrument:ISUMmary:ENABLe (on page 7-99)	—	0

* Some of the options listed in this table are only available for specific functions. If you do not see the option listed here on the menu, it may not be available for the function you are using.

Trigger reset values

Setting*	Default value reset from MENU > System > Settings > Reset	Default value reset by the *RST (on page 7-7) command or :SYSTem:PRESet (on page 7-124) command
MENU > Trigger Configure > Idle : INITiate[n]:CONTinuous (on page 7-51)	Cont:Off	0 (Off)
MENU > Trigger Configure > Arm Count : ARM]:SEQuence[n]]:COUNt (on page 7-19)	1	1
MENU > Trigger Configure > Arm Source : ARM]:SEQuence[n]]:SOURce (on page 7-20)	Immediate	IMM
MENU > Trigger Configure > Trigger Count : TRIGger]:SEQuence[n]]:COUNt (on page 7-149)	1	1
MENU > Trigger Configure > Trigger Source : TRIGger]:SEQuence[n]]:SOURce (on page 7-151)	Immediate	IMM
MENU > Trigger Configure > Sample Count : TRIGger]:SEQuence[n]]:SAMPlE:COUNt (on page 7-150)	1	1

* Some of the options listed in this table are only available for specific functions. If you do not see the option listed here on the menu, it may not be available for the function you are using.

Buffer reset values

Setting*	Default value reset from MENU > System > Settings > Reset	Default value reset by the *RST (on page 7-7) command or :SYSTem:PRESet (on page 7-124) command
MENU > Trigger > Configure > Idle : TRACe[n]:CLEar:AUTO or : DATA[n]:CLEar:AUTO (on page 7-135)	Cont:On	Cont:Off
MENU > Trigger > Configure > Arm Count : TRACe[n]:POINts or :DATA[n]:POINts (on page 7-142)	1	100
MENU > Trigger > Configure > Arm Source : TRACe[n]:FEED or :DATA[n]:FEED (on page 7-140)	Immediate	SENS
MENU > Trigger > Configure > Trigger Count : TRACe[n]:FEED:CONTRol or : DATA[n]:FEED:CONTRol (on page 7-141)	1	ALW

* Some of the options listed in this table are only available for specific functions. If you do not see the option listed here on the menu, it may not be available for the function you are using.

Functions and features

In this section:

Instrument access	3-1
Graph	3-2
Output delay, slew rate, and source delay	3-5
Data buffer	3-8
Digital I/O	3-19
Trigger model	3-25
Level trigger	3-29
List operation	3-34
Sink operation	3-50

Instrument access

You can specify that the control interfaces request access before taking control of the instrument. There are several modes of access.

You can set one of the following levels of access to the instrument:

- **None:** Allows access by one remote interface at a time with logins required from other interfaces
- **All:** Allows access by one remote interface at a time with passwords required on all interfaces

NOTE

The front-panel is read-only when you are using a remote interface. You can view the home, graph, or data sheet screen by sending `:DISPlay:SCREen` command.

When you set access to `None`, you need to send a `:SYSTem:COMMunication:ABORt` command using this interface to use another interface. You do not need a password with this access.

All access is similar to `None` access, except that you must send a `:SYSTem:PASSword:UNLock` command with the password before sending the `:SYSTem:COMMunication:ABORt` command.

Changing the instrument access mode

To change the access mode Using SCPI commands:

```
:SYST:PASS:MODE NONE
:SYST:PASS:MODE ALL
```

Changing the password

If the instrument is set to the access mode of `All`, you must enter a password to change to a new control interface. You can set the password, as described below.

The default password is `admin`.

To change the remote-control password from the front panel:

1. Press the **MENU** key.
2. Under System, select **Settings**.
3. Select the button next to System Password and press **ENTER**. The System Password screen is displayed.
4. Select **Remote** and press **ENTER**. The Input Original Password screen is displayed.
5. Enter the original password.
6. Select the **OK** button on the displayed keyboard. An Input New Password screen is displayed.
7. Enter the new password.
8. Select the **OK** button on the displayed keyboard. A verification screen is displayed.
9. Enter the new password again.
10. Select the **OK** button on the displayed keyboard. The password is reset.

NOTE

You can reset the password by pressing the **MENU** key, selecting **Settings** (under System), and selecting **Reset**. When you do this, the remote control password and calibration password return to the default setting.

To change the remote control password using a SCPI command:

```
:SYSTem:PASSword:NEW <string1>, <string2>
```

Where `<string1>` is a string that contains the present password, and `<string2>` is a string that contains a new password.

Graph

You can configure the following settings that affect how readings appear on the Graph screen.

- **Window position and zoom:** Specify the readings that are displayed on the screen.
- **Current and voltage auto adjustment:** Automatically adjust the scale and offset of the Y-axis.
- **Current and voltage manual adjustment:** Manually adjust the scale and offset of the Y-axis.

Changing the window position and zoom

You can use window position and zoom to specify how the readings are displayed on the screen. Use window position to set the center point of graph. Use window zoom to specify the number of readings that can be displayed. For example, set the buffer size to 100. A position of 25 percent means the 25th reading in the buffer is the middle of the point in the plot. A zoom of 50 percent specifies 50 readings shown on the screen. For detail, see the following figure.

Figure 55: Window position and zoom

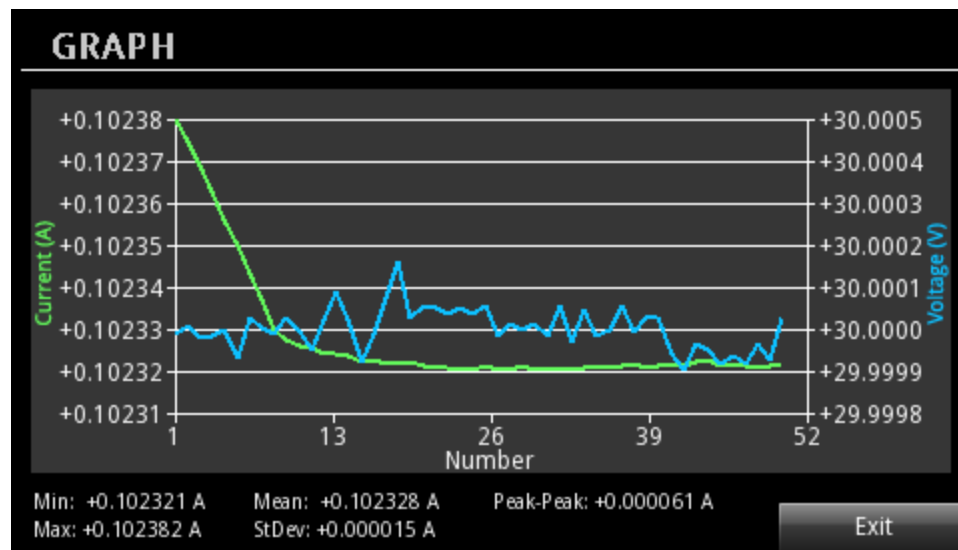

To change the window position and zoom on the front panel:

1. Press the **MENU** key.
2. Under Views, select **Graph**.
3. Select the button next to **Window** and press **ENTER**. The window setting screen is displayed.
4. Press the **Position** soft key. The position edit screen is displayed.
5. Enter a value from 0 to 100 %.
6. Press the **Zoom** soft key. The zoom edit screen is displayed.
7. Enter a value from 0 to 100 %.

NOTE

Only when buffer is in never mode, you can configure position and zoom to specify the readings that are displayed on the screen. Otherwise, if buffer is in next or always mode, the customized position and zoom settings cannot be applied to graph.

Adjusting the scale and offset of the Y-axis

You can adjust the scale and offset of Y-axis automatically or manually. When auto adjustment is enabled, the instrument automatically changes the scale and offset of Y-axis according to current and voltage measurements.

To set the auto adjustment on the front panel:

1. Press the **MENU** key.
2. Under Views, select **Graph**.
3. Select the button next to **I Auto Adjust** or **V Auto Adjust** and press **ENTER**.
4. Select **On** to enable auto adjustment.

The following figure shows an example with the auto adjustment enabled. In this example, a 300 Ω resistor is connected to the front bonding posts, and the voltage is set to 30 V and current limit is set to 3 A.

Figure 56: Graph auto adjustment

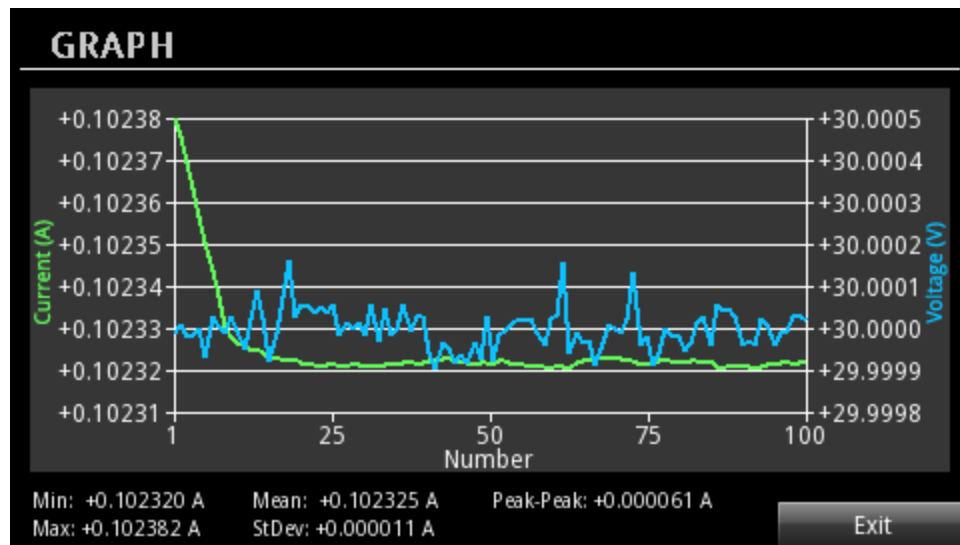

To set the manual adjustment on the front panel:

1. Press the **MENU** key.
2. Under Views, select **Graph**.
3. Select the button next to **I Manual Adjust** or **V Manual Adjust** and press **ENTER**.
4. Press the **Scale** soft key. The scale screen is displayed.
5. Enter a value for scale. There are seven divisions on the Y-axis. The minimum value for current scale is 10 μ A. The minimum value for voltage scale is 100 μ V.
6. Press the **Offset** soft key. The offset screen is displayed.
7. Enter a value for offset. For details, refer to the following table.

Model number	Current offset	Voltage offset
2280S-32-6	-6.1 A to 6.1 A	-32 V to 32 V
2280S-60-3	-3.3 A to 3.3 A	-60 V to 60 V

NOTE

Before configuring the scale or offset, make sure the auto adjustment is disabled. Otherwise, you cannot change these settings.

Output delay, slew rate, and source delay

The following delays occur when you turn on the output and source a specified voltage and current to device under test (DUT):

- **Output delay:** The delay that the instrument waits before enabling and disabling the specified output.
- **Slew rate:** The rate of change of output voltage per unit of time.
- **Source delay:** The delay between when the source reaches the V_{set} value and when the measurement is made.

Figure 57: Series 2280 output delay, slew rate, and source delay

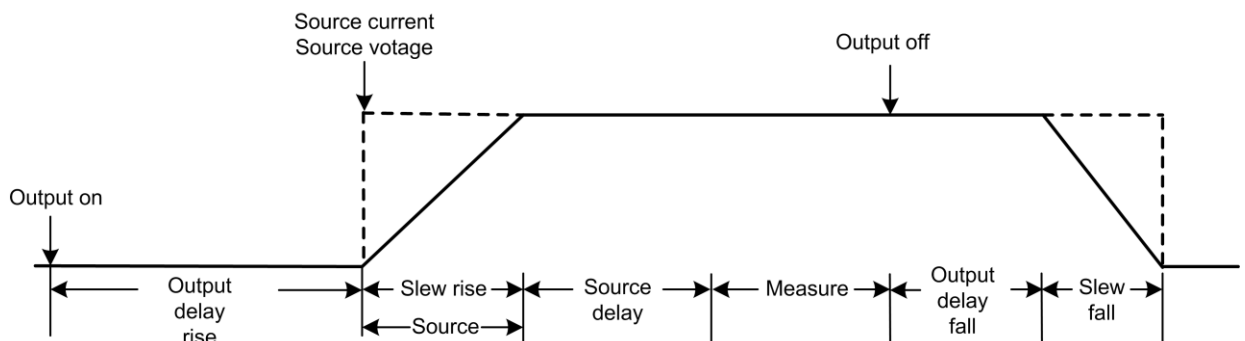

Output delay

You can set a delay before turning on the output or turning off the output. The delay can range from 0.001 s to 10 s.

Using the front panel:

1. Press the **MENU** key.
2. Under Source, select **Settings**.
3. Select the button next to **Output Delay**. The delay window is displayed.
4. Select **On** to enable the output delay.
5. Select the button next to **Delay Rise** and enter a value.
6. Select the button next to **Delay Fall** and enter a value.

Using SCPI commands:

To set output on and off delays, send the following commands:

```
OUTP:DEL:RIS 2  
OUTP:DEL:FALL 3
```

To enable the output delay, send the command:

```
OUTP:DEL:STATe ON
```

Slew rate

The slew rate determines the rate at which the voltage changes to a new programmed setting. You can specify the rising rate and falling rate for the voltage changes.

Using the front panel:

1. Press the **MENU** key.
2. Under Source, select **Settings**.
3. Select the button next to **Slew Rise** and enter a value
4. Select the button next to **Slew Fall** and enter a value.

Using SCPI commands:

To specify the rising rate for the voltage source, send the command:

```
:VOLT:SLEW:RIS 100
```

To specify the falling rate for the voltage source, send the command:

```
:VOLT:SLEW:FALL 100
```

NOTE

The slew rate ranges from 10 V per second to 1000 V per second.

The slew rate setting works properly if the instrument operates below 5 V and 6 A. If it operates above these values, the instrument sources with a noise value of 50 Hz.

Source delay

When the power supply is used to source and measure, the supply outputs a voltage and then measures output current and output voltage. There is always some small delay between the internal process of setting the output voltage and beginning a measurement.

A programmable source delay can be set to extend the time between the internal setting of the output voltage and the beginning of the first reading. This is a source-delay-measure (SDM) cycle. During each SDM cycle, the following occurs:

1. The supply sets the output level.
2. A delay timer starts (if a source delay time has been set).
3. The measurements begin after the delay timer expires.

The default value for the source delay is 1 ms. The source delay can be set from 0 s to 99 s with 10 μ s resolution. Using source delay allows for output settling time when output values are changed.

NOTE

If you change the resolution to 5.5 or 6.5, the instrument enables source delay and sets the delay time to 1 ms. For details about resolution, refer to [Resolution](#) (on page 4-2).

Setting the source delay

Using the front panel:

1. Press the **MENU** key.
2. Under Source, select **Delay**.
3. Select the button next to **Source Delay** and enter a value.
4. Select the button next to **State** and turn on the source delay.

Using SCPI commands:

To set the source delay, set the command to a value. For example, to set the delay to 5 s, send:

```
:DEL 5
```

To enable a source delay, send the command:

```
:DEL:STAT ON
```

Data buffer

The data buffer captures measurements, instrument status, and the output state of the instrument. The Series 2280 has only one buffer.

The data buffer provides the following statistics:

- Average
- Minimum
- Maximum
- Peak-to-peak
- Standard deviation

You can perform the following operations on the data buffer from the front panel or the remote interface:

- Configure, store, and recall a reading buffer.
- View reading buffer content.
- Save reading buffer content to a USB flash drive.
- Set reading buffer to next, always, or never fill mode.
- Change the capacity of a reading buffer.
- Clear a reading buffer manually or automatically.

Effects of reset and power cycle on buffer

The instrument clears the reading buffer when the instrument power is turned off and then on again.

Buffer fill status

You can determine buffer fill status from the front panel. As shown in the following figure, the active buffer indicator displays buffer fill status.

Figure 58: Buffer indicator



Setting reading buffer size and buffer mode

To configure the buffer, configure the following settings:

- Set the buffer size
- Set the buffer fill mode

Buffer size

The initial buffer capacity is 100 readings for the power supply function.

The initial buffer capacity is 2500 readings for the battery test and battery simulation functions.

You can resize the default buffer (power supply function only).

NOTE

Stored readings and statistics are deleted when you change the capacity of a buffer.

Buffer mode

The buffer mode setting for the reading buffer controls how the incoming data is managed as the buffer fills. The options are:

- **Never:** The buffer stops accepting data.
- **Next:** The buffer stops accepting data once it fills to capacity and no new data is stored in the buffer. Once the buffer fills to capacity, the instrument switches to Never mode automatically.
- **Always:** Data fills the buffer normally until the end of the buffer is reached. When the end is reached, the data returns to the beginning of the buffer and overwrites the oldest readings. This is a traditional circular buffer. In this case, the buffer never technically fills.

NOTE

The buffer mode is only configurable in the power supply function. The nonconfigurable buffer mode in the battery test and battery simulation function is Always.

NOTE

When autoclear is enabled, the buffer is cleared automatically when the storage process starts. This means that changing the buffer mode to Next or Always always clears the buffer.

The following topics provide information about using the front panel to configure the buffer and provide an introduction to using remote commands to configure the buffer.

For additional information about using remote commands for buffer operations, see [TRACe subsystem](#) (on page 7-127).

Using the front panel to set buffer capacity:

NOTE

Resizing a reading buffer also clears the data in the buffer.

1. Press the **MENU** key.
2. Under Measure, select **Data Buffers**.
3. Select the button next to **Size**. The Size screen is displayed.
4. Enter the new size for the buffer. For example, enter 600 and press the **ENTER** key.
5. Press the **HOME** key to return to the operating display.

Using the front panel to set fill mode:

1. Press the **MENU** key.
2. Under Measure, select **Data Buffers**.
3. Select the button next to **Mode**. The Mode screen is displayed.
4. Select the buffer Mode. For example, press the button next to **Always**.
5. Press the **HOME** key to return to the home screen.

To set the reading buffer mode to overwrite old readings when the buffer is full, send the following command:

```
:TRACe:FEED:CONTRol ALWays
```

To set the reading buffer mode to start but not overwrite old readings, send the following command:

```
:TRACe:FEED:CONTRol NEXT
```

To set the reading buffer mode so that no readings are saved in the buffer, send the following command:

```
:TRACe:FEED:CONTRol NEVer
```

To set the reading buffer to hold 300 readings, send the following command:

```
:TRACe:POINTs 300
```

Viewing and saving buffer content

You can view the content of the buffer from the front panel. However, the front panel may not be flexible enough for your particular type of data analysis. For further analysis, save the contents of the reading buffer to a USB flash drive. The stored file can be loaded directly into Microsoft® Excel® or another tool. The file contains all the information the instrument records about each data point in the reading buffer.

All readings are saved in the comma-separated value (.csv) file format. This format stores tabular data (numbers and text) in plain-text form. You can import the .csv file into a spreadsheet. See the following figures for an example of a buffer .csv file imported into a spreadsheet.

Figure 59: Example of spreadsheet with reading buffer content

Fill Mode	Always								
Capacity	2500								
Count	10								
Index	Current	Unit	Voltage	Unit	Math	Output	Date	Time	Fractional
1	0.10227	A	29.9998	V	F	CV	06/03/2014	16:17:20	0.3286
2	0.10227	A	29.9999	V	F	CV	06/03/2014	16:17:20	0.4521
3	0.10226	A		30 V	F	CV	06/03/2014	16:17:20	0.5754
4	0.10225	A	29.9999	V	F	CV	06/03/2014	16:17:20	0.6988
5	0.10224	A	29.9999	V	F	CV	06/03/2014	16:17:20	0.8222
6	0.10224	A	29.9999	V	F	CV	06/03/2014	16:17:20	0.9456
7	0.10223	A	29.9999	V	F	CV	06/03/2014	16:17:21	0.0689
8	0.10221	A	29.9999	V	F	CV	06/03/2014	16:17:21	0.1923
9	0.1022	A	29.9999	V	F	CV	06/03/2014	16:17:21	0.3157
10	0.10219	A	29.9998	V	F	CV	06/03/2014	16:17:21	0.4391

The following table describes the information that is stored in each column of the spreadsheet.

Heading	Description
Index	Provides an identifier for each reading.
Current	The value saved in the buffer depends on the measurement function. For more information, see the following table.
Unit	Indicates the unit of measure for the current reading; value is A (amperes).
Voltage	The value saved in the buffer depends on the measurement function. For more information, see the following table.
Unit	Indicates the unit of measure for the voltage reading; value is V (volts).
Math	T when Math is on; F when Math is off.
Output	CC (constant current), CV (constant voltage), or OFF. For details, see Constant voltage (CV) and constant current (CC) mode (on page 2-72).
Date	Date the readings were made.
Time	Time the readings were made.
Fractional	Fractional portion of the timestamp (in seconds) when each reading was made. Fractional seconds are the fractional part of an absolute timestamp. For example, the fractional part of the 16:17:21.1923 timestamp is .1923.

The current and voltage values in the buffer are different for the measurement function.

Measurement function	Current	Voltage
Concurrent (V + I)	Measured value for each current reading	Measured value for each voltage reading
Voltage (V)	Current setting value	Measured value for each voltage reading
Current (I)	Measured value for each current reading	Voltage setting value

To use the front panel to view the contents of the reading buffer:

1. Press the **MENU** key.
2. Under Views, select **Sheet**.
3. Select the button next to Data Sheet. The data is displayed.
4. If you want to view the statistics, select the button next to **Statistics**. The Statistics screen is displayed.
5. Press the button next to **On**. The statistics results are displayed below the data table. To configure the statistics function, see [Configuring the statistics applied to data in the buffer](#) (on page 3-15).

Figure 60: Data sheet in power supply function

DATA SHEET			
Points	Time	Voltage	Current
1	12/03 17:09	+012.0010 V	+00.00000 A
2	17:09:7.57	+012.0010 V	+00.00000 A
3	17:09:7.67	+012.0009 V	+00.00000 A
4	17:09:7.78	+012.0010 V	+00.00000 A
5	17:09:7.88	+012.0010 V	+00.00000 A
6	17:09:7.98	+012.0010 V	+00.00000 A
7	17:09:8.08	+012.0010 V	+00.00000 A
Min: 0.0015 mA		Mean: 0.0035 mA	Peak-Peak: 0.0054 mA
Max: 0.0069 mA		StDev: 0.0000 mA	
← → ↑ ↓ Exit			

6. Press the **HOME** key to return to the home screen.

NOTE

Go to home screen 3. Press the **Data Sheet** soft key to view the buffer.

Using the front panel to save buffer content to files

To use the front panel to save or append buffer content to files:

1. Insert a USB flash drive into the USB port.
2. Press the **MENU** key.
3. Under Measure, select **Data Buffers**.
4. Select the **Export To USB** button. A keyboard is displayed.
5. Enter the name of the file in which to save the readings.

NOTE

You only have to enter the name of the file you want to save. It is not necessary to enter the file extension. All files are saved as `.CSV` files.

6. Select **Yes** to confirm saving the file. When the **DATA BUFFERS** window is displayed again, the file is saved.
7. Press the **HOME** key to return to the home screen.

Configuring the statistics applied to data in the buffer

The data buffer provides the following statistics:

- Average
- Minimum
- Maximum
- Peak-to-peak
- Standard deviation.

Specifying the statistics applied to the data in the buffer

Using the front panel:

1. Press the **MENU** key.
2. Under Measure, select **Data Buffers**.
3. Select the **Statistics** button. The Statistics window is displayed.
4. Enable the statistics you want to calculate.

Using the SCPI commands:

```
:CALCulate2:FORMat <name>
```

Where <name> can be any of the following options separated by commas:

- MINimum
- MAXimum
- MEAN
- SDEViation
- PKPK

For example, you could enable minimum and maximum calculations by sending:

```
:CALCulate2:FORMat MIN, MAX
```

Specifying the data in the buffer to perform with statistics

You must select either the voltage or current value in the buffer to perform statistics calculations. When you configure these settings, it affects the Graph and Data Sheet screen and the outputs of the following commands:

- :CALCulate2:IMMEDIATE?
- :CALCulate2:DATA?

Using the front panel:

1. Press the **MENU** key.
2. Under Measure, select **Data Buffers**.
3. Select the button next to **Statistics Function** and press the **ENTER** key. The function selection window is displayed.
4. Select **Voltage** or **Current**.
5. Press the **Exit** key to leave the selection window.

For example, if you select Current as the statistics function and switch the screen to the Graph screen, a graph screen similar to the following is shown.

Figure 61: Graph screen with statistics

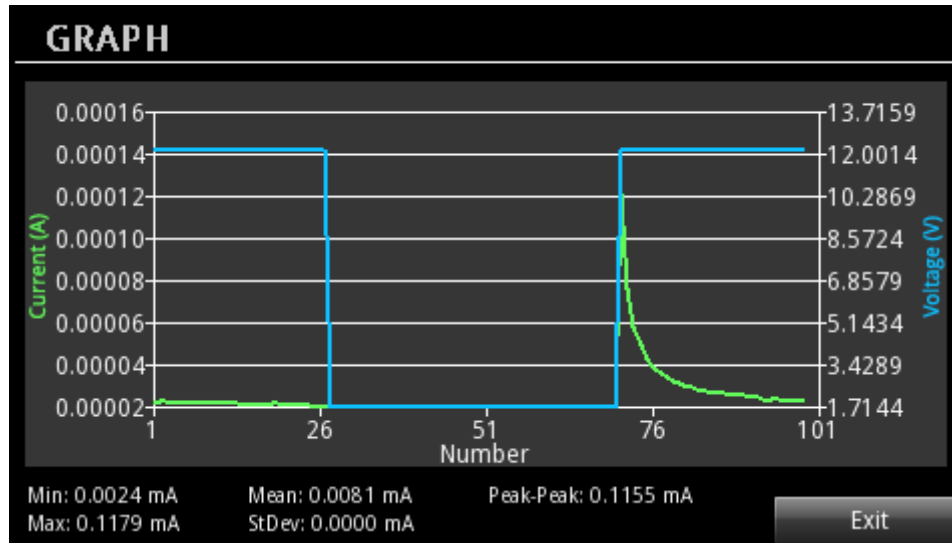

To specify the statistics function using SCPI commands:

```
:CALCulate2:FUNCTION CURRent
:CALCulate2:FUNCTION VOLTage
```

Formatting the statistical results

You can specify the returned data elements for statistical calculations. The elements include value, reading number, unit, and time. You can specify one or more parameters.

NOTE

This only applies to minimum and maximum calculations. For other statistics, you can view value and unit from the front panel, and value using SCPI commands.

Using the front panel:

1. Press the **MENU** key.
2. Under Measure, select **Data Buffers**.
3. Select the button next to **Statistics Format**. The selection window is displayed.
4. Select the parameters you want to show on statistics. If you select **All**, the value, reading number, unit, and time are returned.

You can view the statistics from the Data Sheet and Graph screen.

Using the SCPI commands:

```
:CALCulate2:FORMat:ELEMents <item list>
```

Where <item list> includes the following items:

- READing
- UNIT
- RNUMber
- TSTamp

For example, select READ and TSTamp as returned elements by sending:

```
:CALCulate2:FORMat:ELEMents "READING,TSTamp"
```

Using SCPI commands to save buffer content to files

Before using any of these commands, insert a USB flash drive into the USB port.

To save readings and default timestamps from the buffer to a file named `my_data.csv` on a USB flash drive, send the following command:

```
:TRACe:SAVE "my_data"
```

To save readings from 1 through 100 and relative timestamps to a file named `test_data.csv` on a USB flash drive, send the following command:

```
:TRACe:SAVE "test_data",REL,1,100
```

For more information, refer to [:TRACe\[n\]:SAVE](#) (on page 7-143) or [:DATA\[n\]:SAVE](#).

Clearing the buffer

You can clear all readings and statistics from the buffer. The following topics provide information about using the front panel or remote commands to clear a buffer.

To use the front panel to clear a reading buffer:

1. Press the **MENU** key.
2. Under Measure, select **Data Buffers**.
3. Select **Clear Buffer** to clear the buffer.
4. When the `Are you sure you want to clear buffer` prompt is displayed, press **Yes** to confirm.

To clear the buffer, send the following command:

```
:TRACe:CLEAr
```

Automatically clearing a buffer

When using the power supply function, you can enable the autoclear function for the buffer. With autoclear enabled, the buffer is automatically cleared when the storage process starts.

Using the front panel:

1. Press the **MENU** key.
2. Under Measure, select **Data Buffers**.
3. Select the button next to **Auto Clear**. The selection window is displayed.
4. Select **On** to enable the autoclear function.

Using the SCPI commands:

```
:TRACe:CLEAr:AUTO ON  
:TRACe:CLEAr:AUTO OFF
```

Digital I/O

You can use the Series 2280 digital input/output with the trigger model to control an external digital circuit, such as a device handler that is used to perform binning operations.

To control or configure any of the six digital input/output lines, send commands to the Series 2280 over a remote interface.

The following topics contain more information about the digital input/output port. For more information the trigger model, see [Trigger model](#) (on page 3-25).

Digital I/O port

The digital I/O port uses a standard female DB-9 connector, which is located on the rear panel of the Series 2280. You can connect to the Series 2280 digital I/O using a standard male DB-9 connector. The port provides a connection point to each of the six digital I/O lines and other connections as shown in the following table.

Figure 62: Digital I/O port

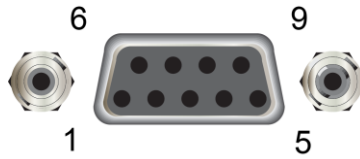

Series 2280 digital I/O port pinouts	
Pin	Description
1	I/O line 1
2	I/O line 2
3	I/O line 3
4	I/O line 4
5	V _{ext} line (relay flyback diode protection)
6	I/O line 5
7*	+5 V line
8	I/O line 6
9	Ground

* Use this pin to drive external logic circuitry. Maximum current output is 500 mA. This line is protected by a self-resetting fuse.

The following figure shows the basic configuration of the digital I/O port.

Figure 63: Digital I/O port configuration

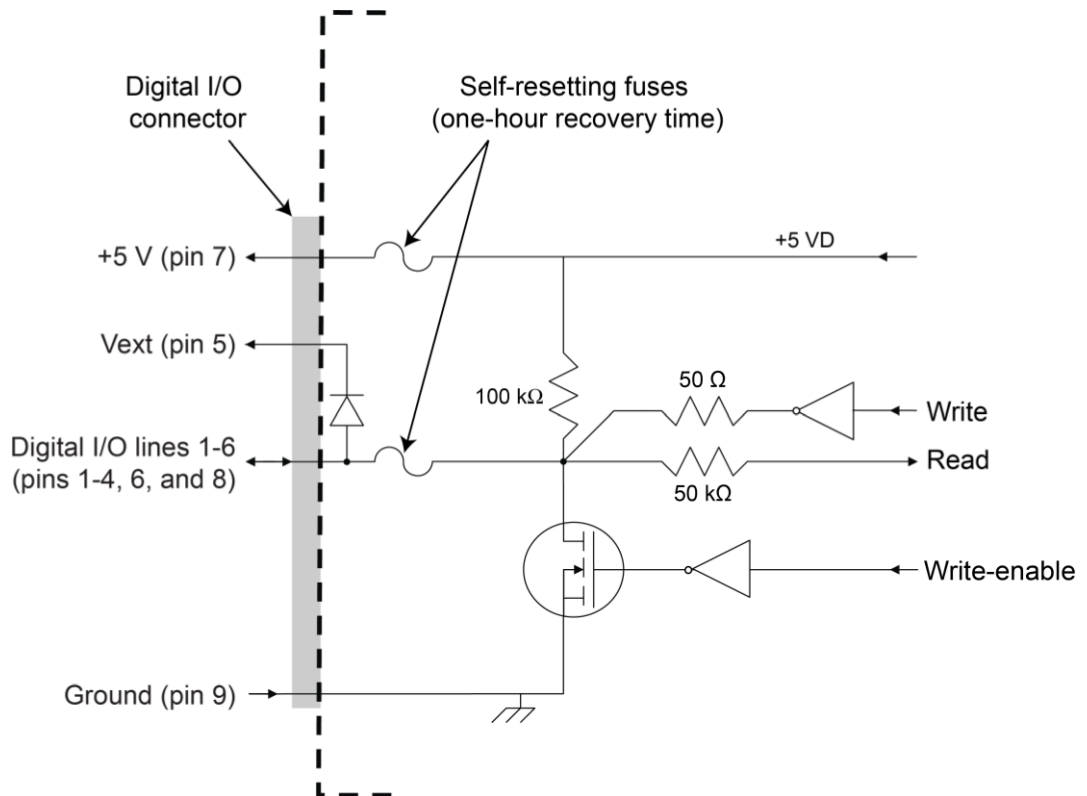

Digital I/O lines

The following table describes the possible pin configurations for the digital line function and action.

Line mode	Available configurable lines
Trigger in	Line 1
Meter complete output	Line 2
Fault output	Line 3
Manual output high	Line 1 through 6
Manual output low	Line 1 through 6
Manual input	Line 1 through 6

When you place a line in the trigger-in function, you can detect a pulse on this line. The trigger latency is 5 μ s. The minimum pulse width is 4 μ s. The falling edge of the pulse generates a trigger-in event.

When you place a line in the meter complete function, the line is pulled up to logic high (+5 V). When a measurement is completed, the instrument generates a low pulse with the duration of 10 μ s to 30 μ s.

When you place a line in the fault output function, the line is pulled up to logic high (+5 V). When an overprotection error or a reverse-sense-leads error occurs, the line is set to logic low (0 V). After you clear the error from the front panel or using SCPI commands, the line is set to logic high. For more information, refer to [Overprotection error](#) (on page 2-81).

When you place a line in the manual output high state, the line is set to logic high (+5 V). Each output line can source up to 2 mA.

When you place a line in the manual output low state, the line is set to logic low (0 V). Each output line can sink up to 50 mA.

When you place a line in manual input function, the line is floating. You can read the line status by sending the following command:

```
:DIGital:LINE<n>:MANual:INPut:DATA?
```

Where <n> is the digital I/O line. In the return, 1 represents logic high (+5 V), 0 represents logic low (0 V).

Vext line

The digital I/O allows connection to an external voltage through a line (V_{ext}) with a flyback diode clamp. You can connect to the V_{ext} line through the V_{ext} pin (pin 5) and the specified digital I/O line. Use this connection to drive relay coils, a low power solenoid, or similar external inductive circuitry. The externally supplied voltage can be up to +33 V.

CAUTION

Do not apply more than 50 mA (maximum current) or exceed +33 V (maximum voltage) on the digital I/O port. Applying current or voltage exceeding these limits may damage the instrument.

Refer to the following figure for a simplified schematic of a sample control circuit for a relay. You can externally power a different device by replacing the relay coil with the other device. When using the V_{ext} pin to control externally powered devices, make sure to configure the corresponding digital output lines. In the low state (0 V), the output transistor sinks current through the external device. In the high state, the output transistor is off (transistor switch is open). This interrupts current flow through the external device. This type of application typically uses an active-low signal (set the bit to 0) to turn the relay on (ON = 0 V).

For example, if you configure line 4 as the digital output line, you can send the following command to sink relay current:

```
:DIG:LINE4:FUNC:MOUTL
```

To stop relay current, sent the following command

```
:DIG:LINE4:FUNC:MOUTH
```

Figure 64: Digital I/O Vext (example external circuit)

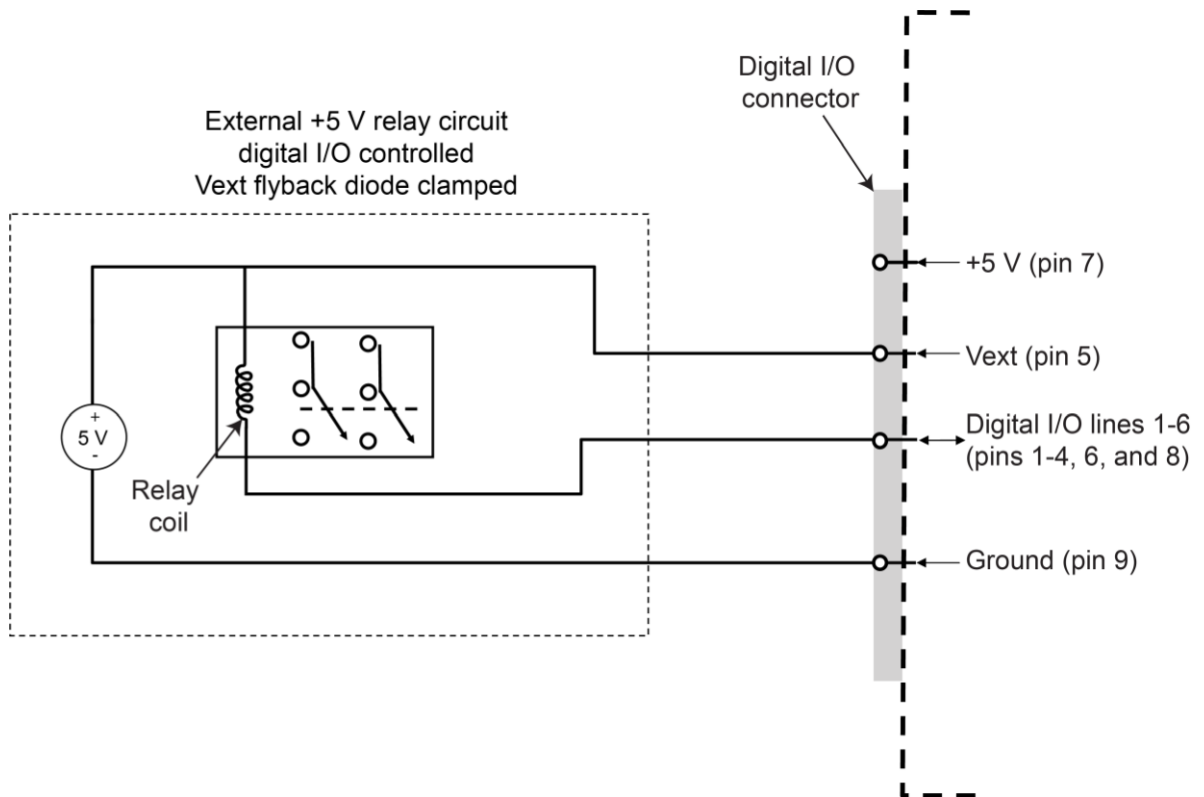

+5 V line

The digital I/O port provides a +5 V output. You can use this line to drive external logic circuitry. The maximum current output for this line is 500 mA (≥ 4.6 V).

Configuring digital I/O lines

You can use front panel or a remote interface to set up and control the digital I/O lines. See [Remote communications interfaces](#) (on page 2-44) for information on setting up a remote interface.

Using the front panel to configure digital I/O lines

Using the front panel to configure digital I/O lines:

1. Press the **MENU** key.
2. Under Trigger, select **Digital In/Out**.
3. Select the button next to the specified digital I/O line. The line mode window is displayed.
4. Select the mode for the specified digital I/O line. For details, see the following table.

Digital I/O line	Supported line mode
1	Trigger In, Output HI, Output LO, and Manual In
2	Meter Out, Output HI, Output LO, and Manual In
3	Fault Out, Output HI, Output LO, and Manual In
4	Output HI, Output LO, and Manual In
5	Output HI, Output LO, and Manual In
6	Output HI, Output LO, and Manual In

NOTE

When you set the arm source or trigger source to external, digital I/O line 1 will be set to Trigger In automatically.

Using SCPI commands to configure digital I/O lines

Using SCPI commands to configure digital I/O lines:

To set the line mode to the specified line, send the following command:

```
:DIGital:LINE<n>:FUNction <function>
```

Where <n> is the digital line and <function> is line mode. For details, see the following table.

Line mode	Description
AUTO	When applied each line with AUTO mode, it represents: <ul style="list-style-type: none"> ▪ Line 1: Trigger in ▪ Line 2: Meter complete output ▪ Line 3: Fault output ▪ Line 4 to line 6: Not available.
MOUTH	Manual output high
MOUtl	Manual output low
MINPut	Manual input

NOTE

If you apply AUTO to digital I/O line from 4 to 6, it results an error 507, "Pins 4 to 6 don't support function AUTO for single channel instrument."

You can also read the digital I/O line by sending the command:

```
:DIGital:line<n>:MANual:INPut:DATA?
```

Where <n> is the digital line.

NOTE

Only when the digital I/O line is set to manual input, sending this query command will return the value. Otherwise, the instrument generates an error 508, "Querying manual input data of the line which is not set as Manual Input line."

Trigger model

The trigger model controls the sequence in which measurements occur. It consists of two layers (Arm Layer and Trigger Layer) to provide versatility.

Programmable counters allow operations to be repeated, and various input and output trigger options are available to provide source-measure synchronization.

Figure 65: Trigger model

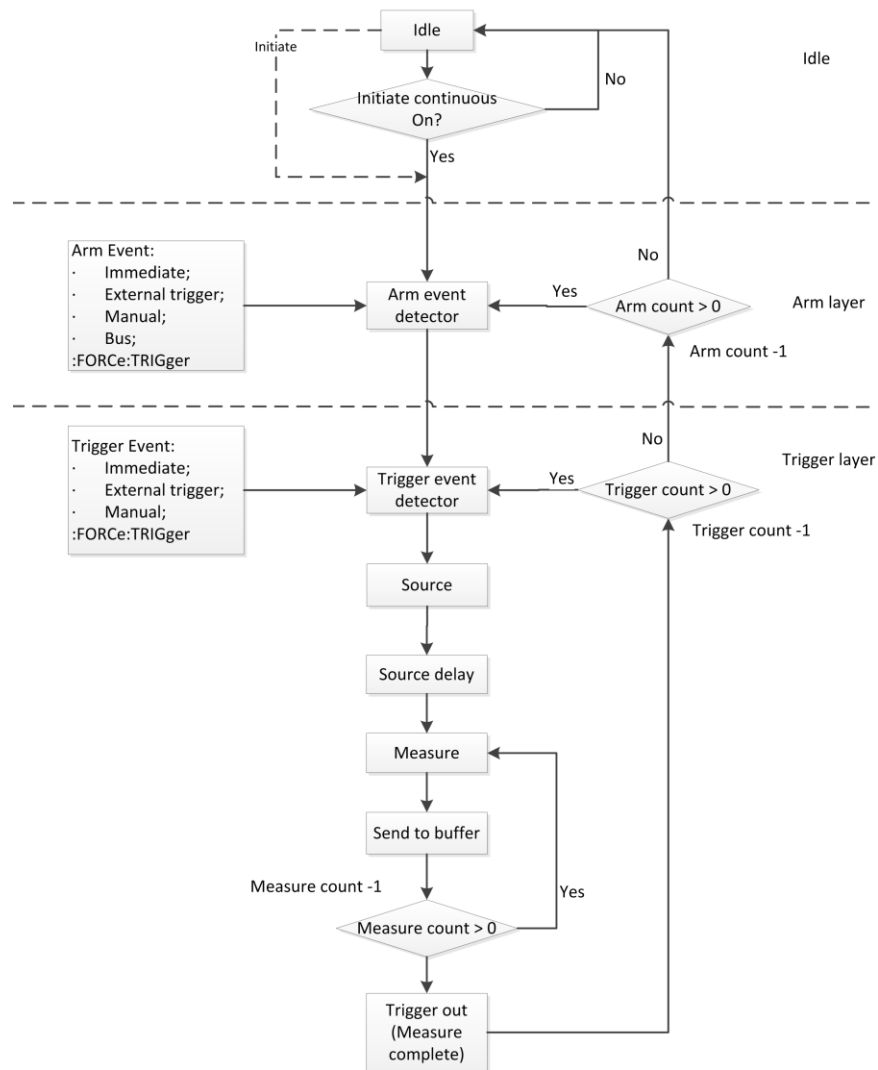

Idle and initiate

The instrument is in the idle state when it is not operating in the arm layer or trigger layer of the trigger model. When in the idle state, the instrument cannot perform any measurements. You can send the following commands to initiate the trigger model:

- `:INITiate`
- `:INITiate:CONTinuous`
- `:READ?`
- `:MEASure:<function>?`

Arm layer

The programmable arm events for the arm layer are described as follows:

- **Immediate:** Event detection occurs immediately, allowing operation to continue.
- **Bus:** Event detection occurs when a bus trigger (`*TRG`) is received.
- **External Trigger:** Event detection occurs when an input trigger is sent through the Digital IO port.
- **Manual:** Event detection occurs when the TRIGGER key is pressed.

Trigger layer

The programmable sources for trigger layer are described as follows:

- **Immediate:** Event detection occurs immediately, allowing operation to continue. Operation proceeds through the trigger layer to perform the source, delay, AND MEASURE actions.
- **External Trigger:** Event detection occurs when an input trigger is sent through the digital I/O port. For details, see [Digital I/O](#) (on page 3-19).
- **Manual:** Event detection occurs when the TRIGGER key is pressed.

Source, source delay, and measure actions

The source-delay-measure (SDM) cycle consists of the following actions:

- **Source:** Programmed output current or voltage level changes are performed. It also performs the programmed slew rate during the level changes when the slew function is enabled.
- **Delay:** This programmable delay is used to allow the source to settle before a measurement is performed. It can be manually set from 0.0000 s to 99.9999 s.
- **Measure:** During this phase of the SDM cycle, the measurement process takes place. It makes the voltage or current measurements as determined by different measurement functions. For details about the measurement function, refer to [Select a measurement function](#) (on page 2-74).

Counter

Programmable counters are used to repeat operations within the trigger model layers. For example, if using a 10-point list, the trigger counter is set to 10 and measure counter to 1. Operation stays in the Trigger Layer until the 10 source-delay-measure points of the list are completed.

If you wanted to repeat the list three times, set the arm counter to three. Three 10-point sweeps can then be performed for a total of 30 source-delay-measure actions.

Meter complete

The instrument can be programmed to output a trigger through the rear-panel digital I/O line after the measurement completes. An output trigger can be used to trigger another instrument to perform an operation.

You can specify one pin to generate the meter complete output pulse. For details, see [Digital I/O](#) (on page 3-19).

Figure 66: Meter complete output signal

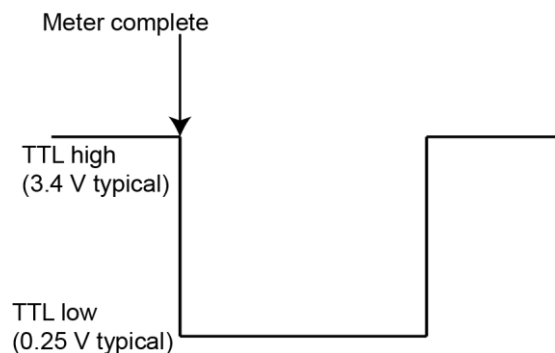

Running the trigger model

You can run the trigger model when the instrument is controlled either locally or remotely. If the instrument is being controlled locally, you can quickly configure the trigger model without setting up trigger source and trigger count in the trigger layer. Trigger source is set to immediate triggering and trigger count is set to 1.

To set up trigger model from the front panel:

1. Press the **Menu** Key.
2. Under Trigger, highlight the **Configure** icon and press **ENTER**. The trigger configure screen is displayed.
3. Select the button next to **Idle**. Press the **ENTER** key to enable the continuous initiation.

NOTE

With continuous initiation enabled (`INIT:CONT ON`), the instrument continuously performs measurements. With continuous initiation disabled (`INIT:CONT OFF`), the instrument returns to the idle state after all measurements are complete (based on the product of arm count, trigger count and sample count). When the instrument is in the idle state, pressing the **TRIGGER** key initiates the trigger model.

-
4. Select the button next to **Arm Source** and press **ENTER**. The arm source selection screen is displayed.

NOTE

You can select immediate, external, and manual triggering from the front panel. Bus triggering is only supported using SCPI commands. You can also quickly set up the arm source by pressing **HOME > Acquire**. If you set the arm source to External, digital I/O line 1 is forced to be Trigger In and is used as the external source. For details, refer to [Digital I/O](#) (on page 3-19).

-
5. Select the button next to **Sample Count** and press **ENTER**. The sample count editing screen is displayed. The maximum sample count is 2500.

If the instrument is controlled remotely, you can configure any of the parameters discussed above. If you change from remote to local control, the trigger model measurement method remains selected until you change it. The following table lists the commands related to the trigger model.

SCPI command	Description
:ARM[:SEQuence[n]]:COUNt (on page 7-19)	Set the number of times to repeat the arm event.
:ARM[:SEQuence[n]]:SOURce (on page 7-20)	Select the control source for the arm layer. The available control sources are: <ul style="list-style-type: none"> ▪ Immediate triggering ▪ External triggering ▪ Manual triggering ▪ Bus triggering
:TRIGger[:SEQuence[n]]:SOURce (on page 7-151)	Select the control source for the arm layer. The available control sources are: <ul style="list-style-type: none"> ▪ Immediate triggering ▪ External triggering ▪ Manual triggering; for details, see the example Perform a fast current load measurement (on page 5-7)
:TRIGger[:SEQuence[n]]:COUNt (on page 7-149)	Set the number of times to repeat the trigger event
:TRIGger[:SEQuence[n]]:SAMPle:COUNt (on page 7-150)	Set the number of measurements per trigger event
:FORCe:TRIGger (on page 7-15)	Bypass the control source (Arm layer or Trigger layer) when you do not want to wait for the programmed event to occur
:INITiate[n]:IMMediate (on page 7-52)	Start the trigger model
:INITiate[n]:CONTinuous (on page 7-51)	Enable and disable continuous triggering
:ABORT[n] (on page 7-11)	Stop all trigger model commands on the instrument

For more examples of using the trigger model, refer to [Perform a fast current load measurement](#) (on page 5-7).

Level trigger

You can configure a triggering condition to start logging data in the data buffer during the test. You can specify that the trigger execute when the voltage or current rises above or falls below a specified level.

Configuring a voltage level trigger

To configure a voltage level trigger from the front panel:

1. Press the **Menu** key.
2. Under **Trigger**, select **Level** and press the **ENTER** key. The **LEVEL TRIGGER** screen is displayed.
3. Select the button next to **Voltage** and press the **ENTER** key.
4. Select **On**.
5. Select the button next to **Voltage Level** and press the **ENTER** key.
6. Set the threshold voltage value for the trigger.
7. Select the button next to **Voltage Direction** and press the **ENTER** key.
8. Choose the direction for the trigger.
9. Select the button next to **Offset** and press the **ENTER** key.
10. Set how many points will be saved before the level trigger is activated.

To configure a voltage level trigger, send the following SCPI commands:

```
:TRACe[n]:TRIGger:VOLTage:STATe  
:TRACe[n]:TRIGger:VOLTage[:LEVel]  
:TRACe[n]:TRIGger:VOLTage:DIRectiOn  
:TRACe[n]:TRIGger:OFFSet
```

NOTE

When the level trigger is activated, it clears the data in the buffer except the points specified by the Offset setting.

The following figure illustrates how the level trigger is activated when the voltage rises.

Figure 67: Voltage level trigger (rise)

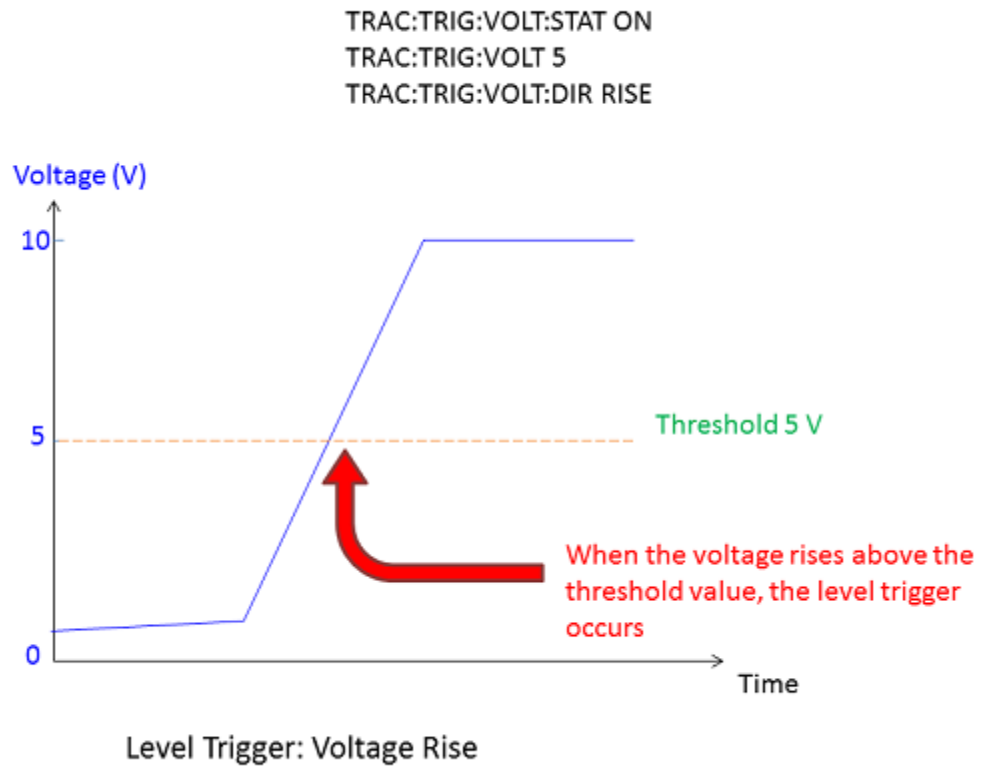

The following figure illustrates how the level trigger is activated when the voltage falls.

Figure 68: Voltage level trigger (fall)

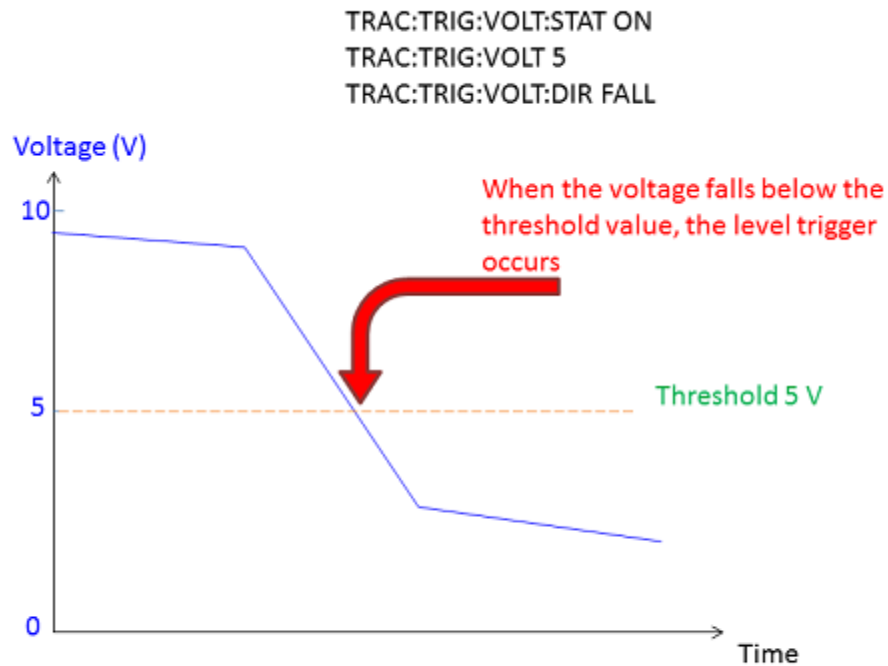

Level Trigger: Voltage Fall

Configuring a current level trigger

To configure a current level trigger from the front panel:

1. Press the **Menu** key.
2. Under **Trigger**, select **Level** and press the **ENTER** key. The **LEVEL TRIGGER** screen is displayed.
3. Select the button next to **Current** and press the **ENTER** key.
4. Select **On**.
5. Select the button next to **Current Level** and press the **ENTER** key.
6. Set the threshold current value for the trigger.

7. Select the button next to **Current Direction** and press the **ENTER** key.
8. Choose the direction for the trigger.
9. Select the button next to **Offset** and press the **ENTER** key.
10. Set how many points to save before activating the level trigger.

To configure a current level trigger, send the following SCPI commands:

```
:TRACe[n]:TRIGger:CURRent:STATe  
:TRACe[n]:TRIGger:CURRent[:LEVel]  
:TRACe[n]:TRIGger:CURRent:DIRectioN  
:TRACe[n]:TRIGger:OFFSet
```

NOTE

When the level trigger is activated, data in the buffer is cleared (except the points specified by the Offset setting).

The following figure illustrates how the level trigger is activated when the current rises.

Figure 69: Current level trigger (rise)

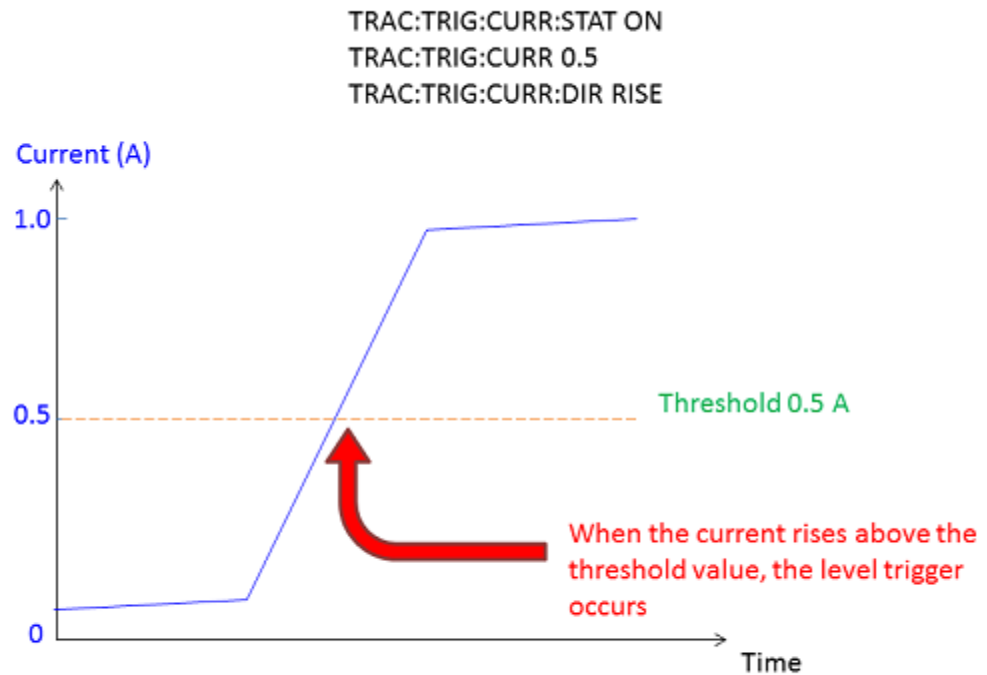

Level Trigger: Current Rise

The following figure illustrates how the level trigger is activated when the current falls.

Figure 70: Current level trigger (fall)

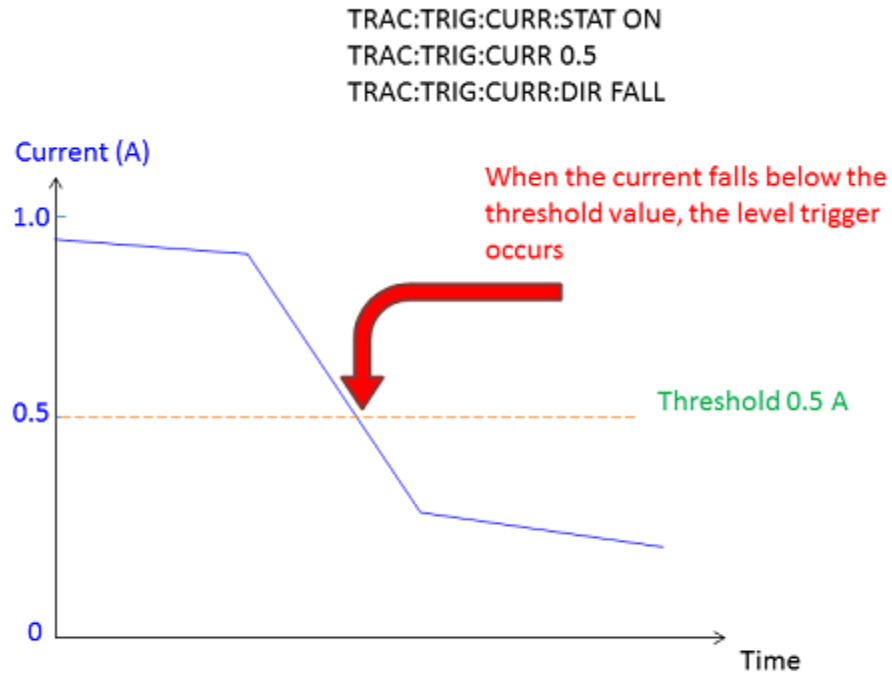

Level Trigger: Current Fall

List operation

You can use lists to set up the instrument to source specific voltage and current values to a device under test (DUT). You can specify up to 99-step points of voltage and current limit. You can also specify a different dwell time for each step.

When you run a list, the instrument uses the trigger model that contains the settings you selected for the list.

To start a list, press **HOME** > **List** > **Enable**. You can also use an initiate command over the remote interface.

Configuring a list

To set up a list from the front panel, select options from the SOURCE LIST screen.

To configure a list on the front panel:

1. Press the **Menu** key.
2. Under Source, highlight the **List** icon using either the navigation control or the soft keys.
3. Press the **ENTER** key. The SOURCE LIST screen is displayed.

Figure 71: Source List screen

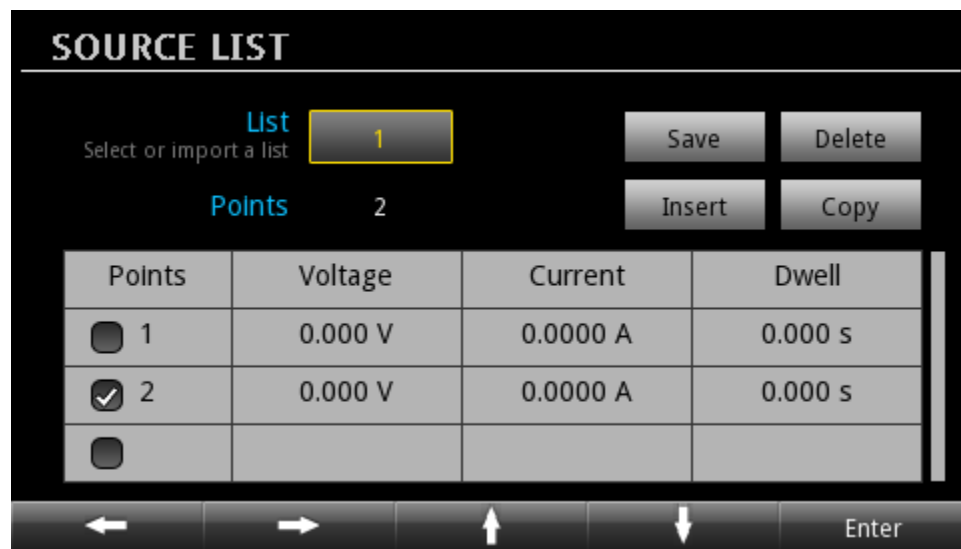

4. Select the button next to **List** and press the **ENTER** key. The List Location screen is displayed.
5. Select a list location where you want to save the list and press the **ENTER** key. The Series 2280 supports up to 9 list locations. You can also import a predefined list from an external USB flash drive. For details, refer to [Importing a list from an external USB flash drive](#) (on page 3-37).
6. Use the **Insert** or **Copy** button to increase the points in the list. For details, refer to [Inserting or copying points from the front panel](#) (on page 3-36). Use the **Delete** button to delete the points. For details, refer to [Deleting points from the front panel](#) (on page 3-36).

NOTE

You can use the **Insert** button to add one point with default settings before each specified point. The default settings are: 0.000 V, 0.100 A, 0.100 s. You can also use the **Copy** button to copy the selected settings for the point and insert a new point with the same settings before each point.

For an empty list, you can add the first point by selecting point 1 and pressing the **ENTER** key. The first point is configured to the default settings.

7. After adding points to the list, select the Voltage box, Current box or Dwell box in the specified point row. Press the **ENTER** key. The editing window is displayed. You can use the numerical keys or the navigation control to change the value.
8. Select the **Save** button to store the list in memory location.
9. Enter a name for the list on the displayed keyboard and press **ENTER**.

To configure a list using SCPI commands:

To set up list 1 with 6 points listed in the following table, send these commands:

```
:LIST1:CURR "1,1,1"
:LIST1:VOLT "5,10,15"
:LIST1:DWEL "2,2,2"
:LIST1:CURR:APPE "2,2,2"
:LIST1:VOLT:APPE "5,10,15"
:LIST1:DWEL:APPE "3,3,3"
:LIST:SAVE:INTE 1
```

Points	Voltage (V)	Current (A)	Dwell (s)
1	5	1	2
2	10	1	2
3	15	1	2
4	5	2	3
5	10	2	3
6	15	2	3

Inserting or copying points from the front panel

To insert or copy one or more points from the front panel:

1. Highlight the Points cell of the row you want to insert.
2. Press **ENTER** to select the cell row. You can repeat steps 1 and 2 to select multiple points.
3. Select **Insert** or **Copy** and press **ENTER**.

Deleting points from the front panel

To delete one or more points from the front panel:

1. Highlight the Points cell of the row you want to delete.
2. Press **ENTER** to select the cell row. You can repeat steps 1 and 2 to select multiple points.
3. Select **Delete** and press **ENTER**.

Importing a list from an external USB flash drive

If you have created or saved a list file (.csv file), you can import the list from external USB flash drive. See the following figure for an example of a list .csv file.

Figure 72: Example of a list sheet

2281-20-6		
Voltage	Current	Dwell
1	2	3
2	2	3
3	2	3
4	2	3
5	2	3
6	2	3
7	2	3
8	2	3
9	2	3
10	2	3

NOTE

Before importing a list, make sure the external USB flash drive is connected to the instrument.

To import a list from USB flash drive on the front panel:

1. Press the **Menu** key.
2. Under Source, highlight the **List** icon using either the navigation control or the soft keys. Press the **ENTER** key. The Source List screen is displayed.
3. Select **Import** and press the **ENTER** key. The list file selection screen is displayed.
4. Select a list that you want to import to the instrument and press **ENTER**. The list location selection screen is displayed.
5. Enter a list location where you want to save the list and press **ENTER**.

NOTE

When you import a .csv file, make sure the filename is less than 8 characters. If the filename is more than 8 characters, the file is not imported to the instrument and a warning screen is displayed.

To import a list from the external USB flash drive using SCPI commands:

```
:LIST:LOAD:USB <list number>,<filename>
```

Where <list number> is the list number from 1 to 9 and <filename> is the filename that contains a name of the imported list. The maximum number of characters is 8.

Exporting a list to an external USB flash drive

After you have configured the list, you can export it to an external USB flash drive.

To export a list to USB flash drive using the front panel:

1. Press the **Menu** key.
2. Under Source, highlight the **List** icon and press the **ENTER** key. The Source List screen is displayed.
3. Select **Export** and press the **ENTER** key. The list number selection screen is displayed.
4. Enter the list number you want to export to the USB flash drive and press **ENTER**. The specified list is saved to a `.csv` file on the USB flash drive. The filename is the same as the list name.

To export a list to USB flash drive using SCPI commands:

```
:LIST:SAVE:USB <list number>,<filename>
```

Where <list number> is the list number from 1 to 9 and <filename> is the filename that contains a name for the saved list. The maximum number of characters is 8.

Configuring and running a list

Before running a list, set up the instrument for the test you will run. Typical settings you can set for a list include:

- **Source settings:** Source delay, slew rate, voltage and current protection limits, and output delay
- **Measure settings:** Measurement function and range
- **Trigger model**

NOTE

When you choose V mode in the Measure menu on the front panel to run a list, the I value is displayed in gray dashes in constant current (CC) mode.

When you choose I mode in the Measure menu on the front panel to run a list, the V value is displayed in gray dashes in constant voltage (CV) mode.

When you run a list, you cannot change the following settings from front panel or using SCPI commands. Sending the following commands causes an error 210, "Not permitted with list enabled."

Source settings that cause an error

Setting	Front-panel operations	SCPI commands
V-Set	<ul style="list-style-type: none"> ▪ MENU > Source Settings > V-Set ▪ HOME > V-Set 	[:SOURce[n]]:<function>[:LEVel][:IMMediate][:AMPLitude] (on page 7-77)
I-Limit	<ul style="list-style-type: none"> ▪ MENU > Source Settings > I-Limit ▪ HOME > I-Limit 	[:SOURce[n]]:<function>[:LEVel][:IMMediate][:AMPLitude] (on page 7-77)
Output delay	<ul style="list-style-type: none"> ▪ MENU > Source Settings > Output Delay ▪ MENU > Source Settings > Delay Rise ▪ MENU > Source Settings > Delay Fall 	<ul style="list-style-type: none"> ▪ :OUTPut:DELAy:STATe (on page 7-56) ▪ :OUTPut:DELAy:RISing (on page 7-55) ▪ :OUTPut:DELAy:FALLing (on page 7-54)
Slew rise/fall	<ul style="list-style-type: none"> ▪ MENU > Source Settings > Slew Rise ▪ MENU > Source Settings > Slew Fall 	<ul style="list-style-type: none"> ▪ [:SOURce[n]]:VOLTage:SLEW:RISing (on page 7-79) ▪ [:SOURce[n]]:VOLTage:SLEW:FALLing (on page 7-80)
OVP/OCP/VMax	<ul style="list-style-type: none"> ▪ MENU > Source Protect > Over Voltage Protection ▪ MENU > Source Protect > Over Current Protection ▪ MENU > Source Protect > Maximum Voltage ▪ HOME > Protect > OVP ▪ HOME > Protect > OCP ▪ HOME > Protect > VMax 	<ul style="list-style-type: none"> ▪ [:SOURce[n]]:<function>:PROTEction[:LEVel] (on page 7-76) ▪ [:SOURce[n]]:VOLTage:LIMit[:AMPLitude] (on page 7-78)
Source delay	<ul style="list-style-type: none"> ▪ MENU > Source Delay > Source Delay ▪ MENU > Source Delay > State 	<ul style="list-style-type: none"> ▪ [:SOURce[n]]:DELAy (on page 7-74) ▪ [:SOURce[n]]:DELAy:STATe (on page 7-75)

Measure settings that cause an error

Setting	Front-panel operations	SCPI commands
Measurement function	<ul style="list-style-type: none"> ▪ MENU > Measure Settings > Function ▪ HOME > Measure 	:SENSe[n]:FUNCTION (on page 7-60)
Range	<ul style="list-style-type: none"> ▪ MENU > Measure Settings > Range ▪ HOME > Range 	<ul style="list-style-type: none"> ▪ :SENSe[n]:<function>:RANGe (on page 7-67) ▪ :SENSe[n]:<function>:RANGe:AUTO (on page 7-69)
Digits	MENU > Measure Settings > Digits	:SENSe[n]:<function>:DIGits (on page 7-65)
Auto Zero	MENU > Measure Settings > Auto Zero	:SYSTem:AZER0[n]:STATe (on page 7-111)
NPLC	MENU > Measure Settings > NPLC	:SENSe[n]:<function>:NPLCycles (on page 7-66)
Resolution	HOME > Resolution	:SENSe[n]:<function>:RESolution (on page 7-73)
Relative	<ul style="list-style-type: none"> ▪ MENU > Rel/Filter Settings > Rel State ▪ MENU > Rel/Filter Settings > Rel Acquire ▪ MENU > Rel/Filter Settings > Reference ▪ HOME > Calculate > Rel 	<ul style="list-style-type: none"> ▪ :SENSe[n]:<function>:REFerence:STATe (on page 7-72) ▪ :SENSe[n]:<function>:REFerence ▪ :SENSe[n]:<function>:REFerence:ACQuire (on page 7-71)
Filter	<ul style="list-style-type: none"> ▪ MENU > Rel/Filter Settings > Filter State ▪ MENU > Rel/Filter Settings > Count ▪ MENU > Rel/Filter Settings > Window ▪ HOME > Calculate > Filter 	<ul style="list-style-type: none"> ▪ :SENSe[n]:<function>:AVERAge:STATe (on page 7-62) ▪ :SENSe[n]:<function>:AVERAge:COUNt (on page 7-61) ▪ :SENSe[n]:<function>:AVERAge:TCONtrol (on page 7-63) ▪ :SENSe[n]:<function>:AVERAge:WINDow (on page 7-64)
Math	<ul style="list-style-type: none"> ▪ MENU > Math Settings > State ▪ MENU > Math Settings > m (Gain) ▪ MENU > Math Settings > b (Offset) ▪ MENU > Math Settings > Units ▪ MENU > Math Settings > Buffer Data Type ▪ HOME > Calculate > Math 	<ul style="list-style-type: none"> ▪ :CALCulate[1]:<function>:FORMat (on page 7-21) ▪ :CALCulate[1]:<function>:KMATH:MBFactor (on page 7-22) ▪ :CALCulate[1]:<function>:KMATH:MMFactor (on page 7-23) ▪ :CALCulate[1]:<function>:KMATH:MUNits (on page 7-25) ▪ :CALCulate[1]:<function>:STATe (on page 7-26)

Data buffer settings that cause an error

Setting	Front-panel operations	SCPI commands
Buffer	<ul style="list-style-type: none"> ▪ MENU > Data Buffers > Size ▪ MENU > Data Buffers > Mode ▪ MENU > Data Buffers > Auto Clear ▪ MENU > Data Buffers > Units 	<ul style="list-style-type: none"> ▪ :TRACe[n]:CLEar:AUTO or :DATA[n]:CLEar:AUTO (on page 7-135) ▪ :TRACe[n]:FEED or :DATA[n]:FEED (on page 7-140) ▪ :TRACe[n]:CLEar or :DATA[n]:CLEar (on page 7-135) ▪ :TRACe[n]:FEED:CONTrol or :DATA[n]:FEED:CONTrol (on page 7-141)

Trigger settings that cause an error

Setting	Front-panel operations	SCPI commands
Trigger	<ul style="list-style-type: none"> ▪ MENU > Trigger Configure > List Type ▪ MENU > Trigger Configure > Idle ▪ MENU > Trigger Configure > Arm Source ▪ MENU > Trigger Configure > Arm Count ▪ MENU > Trigger Configure > Trigger Source ▪ MENU > Trigger Configure > Trigger Count ▪ MENU > Trigger Configure > Sample Count ▪ HOME > Acquire 	<ul style="list-style-type: none"> ▪ :TRIGger[:SEQuence[n]]:SOURce (on page 7-151) ▪ :TRIGger[:SEQuence[n]]:COUNT (on page 7-149) ▪ :TRIGger[:SEQuence[n]]:SAMPle:COUNT (on page 7-150) ▪ :ARM[:SEQuence[n]]:COUNT (on page 7-19) ▪ :ARM[:SEQuence[n]]:SOURce (on page 7-20) ▪ :INITiate[n]:CONTinuous (on page 7-51)

System settings that cause an error

Setting	Front-panel operations	SCPI commands
Recall	MENU > System Save/Recall > Recall	*RCL (on page 7-6)
Product Demo	MENU > System Information > Demo	Not applicable
Calibration	MENU > System Information > Calibrate	CALibration subsystem (on page 7-34)

Running a list

After configuring a list, you can run the list from the front panel.

To run a list from the front panel:

1. Press the **HOME** key.
2. Press the **Next** soft key twice to navigate to the third home screen.
3. Press the **List** soft key. The list settings screen is displayed.
4. Make selections appropriate to your list. See the table below for options.
5. Press the **Enable** soft key to run the list.

Front-panel list options

Option	Description
Number	Specify the list you want to execute (number 1 through 9). The default setting for the list number is Demo; you can run a predefined list. For details, see System Information menu (on page 2-27).
Hold Time	Select one of the following hold time modes for the test: <ul style="list-style-type: none"> ▪ Time: If you choose this mode, one list step runs until the dwell time. To set up the dwell time, refer to Configuring a list (on page 3-35). ▪ Point: If you choose this mode, one list step runs until the preset number of points is reached. To set up the number of points (sample count), refer to Running the trigger model (on page 3-28). You can also set the list running time by using the SCPI command: <code>[:SOURce [n]] :LIST:HTIME</code> (on page 7-84)
End Zero	The voltage and current source level at which the list stops: <ul style="list-style-type: none"> ▪ On: The list ends at 0 V with current limit 0.1 A. ▪ Off: The list ends at the last source values.
Mode	You can select the following list modes: <ul style="list-style-type: none"> ▪ Step: When a trigger occurs, the instrument only outputs one list step. After each list step, the instrument generates a measure complete signal. ▪ Sweep: When a trigger occurs, the instrument outputs all the list steps. After each list cycle, the instrument generates a measure complete pulse. For details, refer to List triggering (on page 3-43).
Cycle	How many times the list should repeat. You can set a specific number of times to repeat.

NOTE

When you run a list, turning the output off by pressing the **OUTPUT** switch aborts the list automatically.

List triggering

You must configure list triggering before running a list. List triggering is similar to common triggering. However, list triggering introduces dwell time to control the source-delay-measure cycle. For more information about the common triggering, refer to [Trigger model](#) (on page 3-25).

When running a list from the front panel, you only need to configure the arm source and a sample count for the trigger model. For other parameters, the instrument changes the settings according to the list configuration.

Parameters	Value
Trigger source	Immediate
Trigger count	List point
Arm count	List cycle
Initiate continuous state	Off

NOTE

Once the instrument finishes the list, it goes to idle mode. You can press the **TRIGGER** key to run the list again.

When executing a list using SCPI commands, you need to set up the trigger model to match the list configuration. For details, refer to [Configure and execute a 10-step linear list sweep](#) (on page 5-3).

List running time

Depending on the hold time you select in the front-panel list options, there are two types of device actions during list running, shown in the following figures.

Figure 73: Device action in time mode

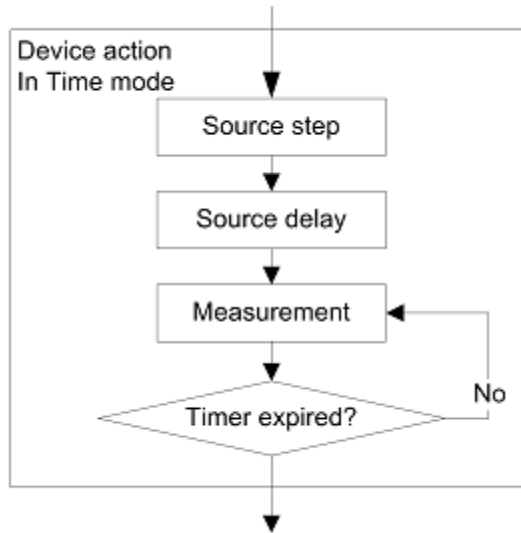

For list-running time in Time mode:

$$\text{Measurement time} = \text{Dwell} - \text{Source Delay}$$

$$\text{Sample Count} = \text{Measurement Time} / \text{Sample Speed}$$

Figure 74: Device action in point mode

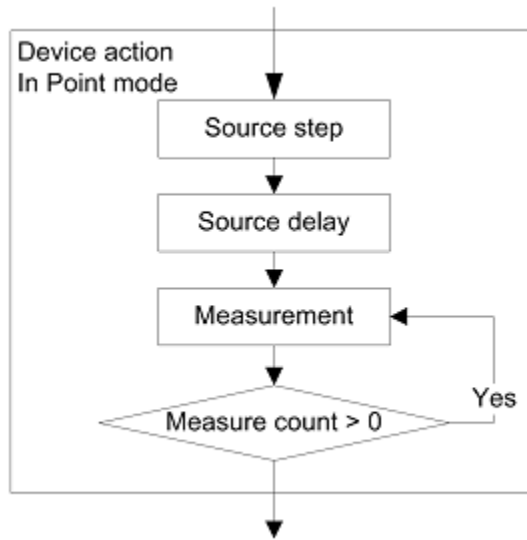

For list-running time in Point mode:

$$\text{Measurement Time} = \text{Sample Count} * \text{Sample Speed}$$

The set dwell time is ignored.

Step mode triggering

In step mode, the instrument generates a measure complete signal after each list step. You can detect this signal in digital I/O line 2. For details, refer to [Digital I/O](#) (on page 3-19).

Figure 75: Step mode triggering

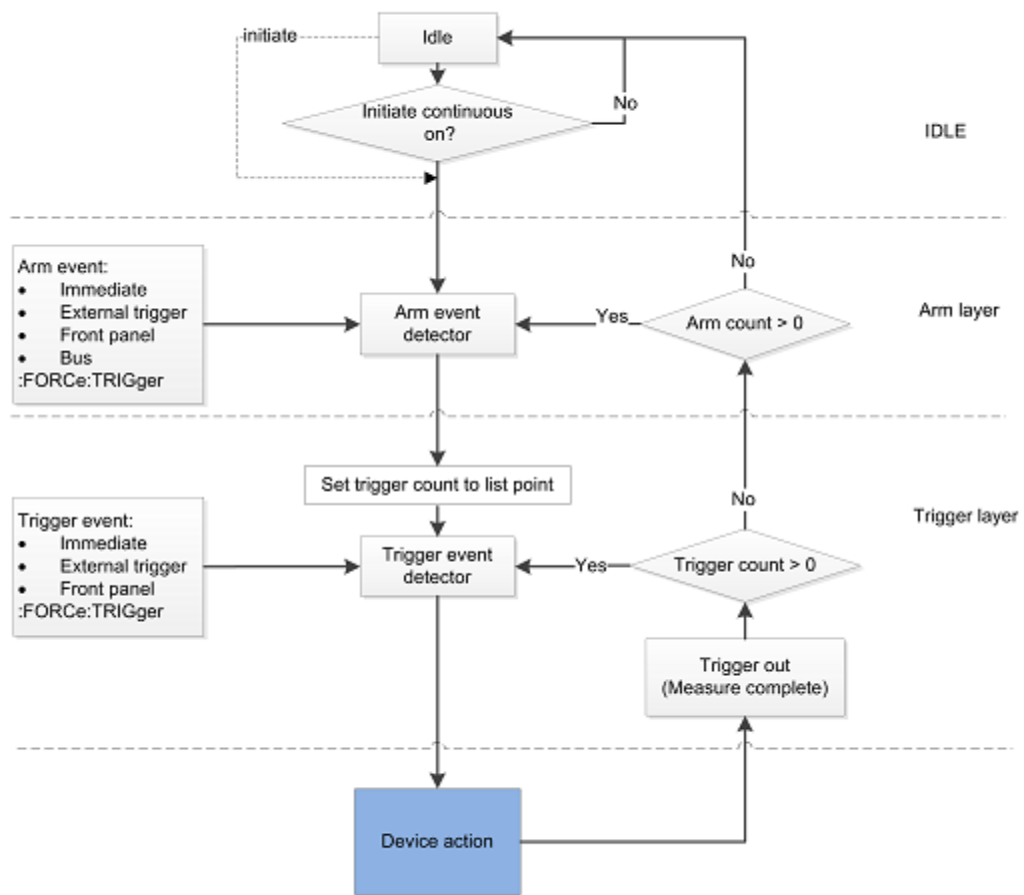

As shown in the previous figure, the device action can be any mode described in [List running time](#) (on page 3-44). The measurement time is set accordingly.

The following figure illustrates the process of measurement for step mode.

Figure 76: Step mode measurement time

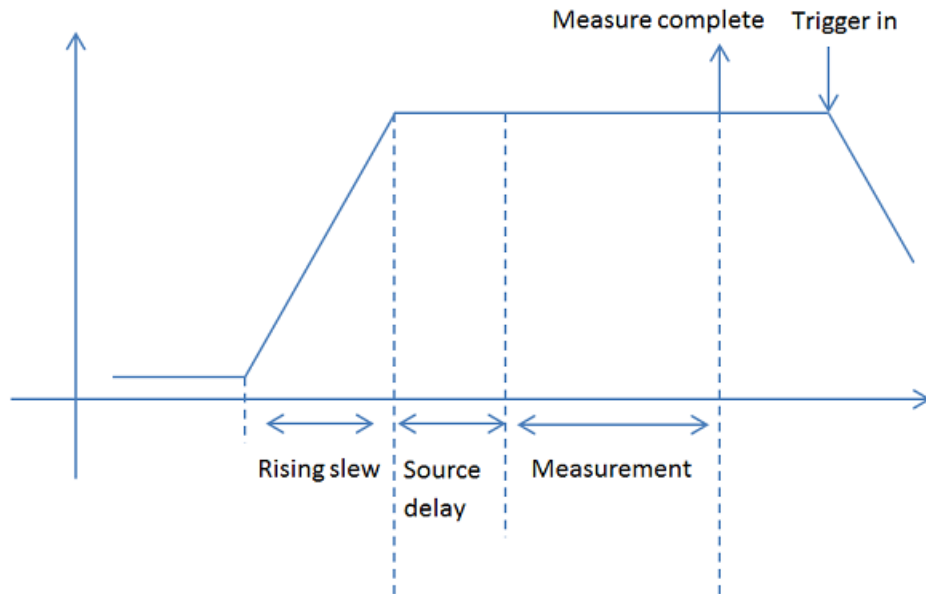

NOTE

When using immediate triggering, the instrument runs the next list step after sending the measure complete signal. However, when using external, bus, or manual triggering, the instrument moves on to the next list step until a measure complete signal is generated and a trigger-in signal is received. If a trigger signal is received when the instrument is in a source-delay-measure cycle or dwell period, the trigger signal is ignored.

Sweep mode triggering

In sweep mode, the instrument generates a measure complete signal after each list cycle. You can detect this signal in digital I/O line 2. For details, refer to [Digital I/O](#) (on page 3-19).

Figure 77: Sweep mode triggering

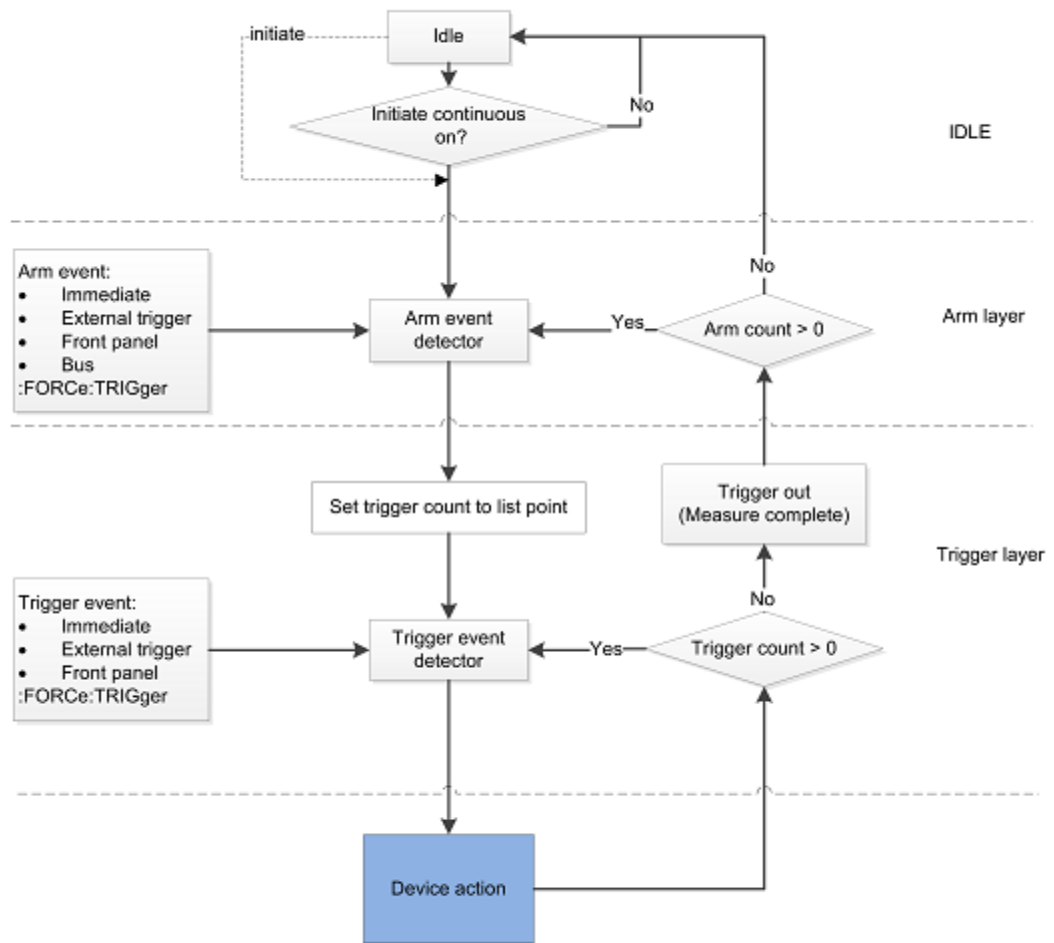

As shown in the previous figure, the device action can be any mode described in [List running time](#) (on page 3-44). The measurement time is set accordingly.

The following figure illustrates the process of measurement for sweep mode.

Figure 78: Sweep mode measurement time

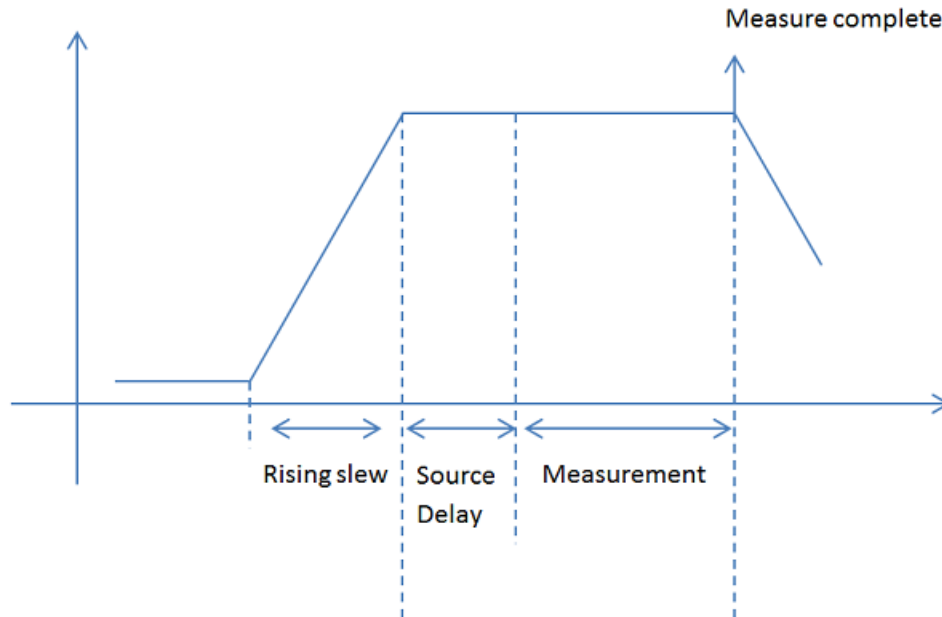

Increasing the speed of a list

To increase the speed of a list:

- Reduce the NPLC.
- Turn autozero off. If autozero is on, the instrument takes new reference and zero values for every reading. This can slow down sweep operation. Be aware that if you disable autozero, measurements may drift and become erroneous. For more information on the autozero options, see [Autozero measurements](#) (on page 4-5).

Aborting a list

A list can be stopped for the following reasons:

- The limit set by the abort on limit setting was exceeded
- The trigger model is aborted

You can stop the list while it is in progress. When you stop the list, all list commands in the trigger model are terminated.

Using the front panel:

Press the **HOME** > **List** > **Enable** to stop the list.

Using SCPI commands:

```
:ABORT
```

Sink operation

When the Series 2280 is operating as a sink, current has opposite polarities and the instrument is dissipating power rather than sourcing it. The instrument can be forced into sink operation by an external source, such as a battery, or an energy storage device, such as a capacitor. For detail on the sink region, see the following figure. The sink current is nonprogrammable and the maximum sink current is $0.45\text{ A} \pm 10\%$.

Figure 79: Series 2280 operating boundaries

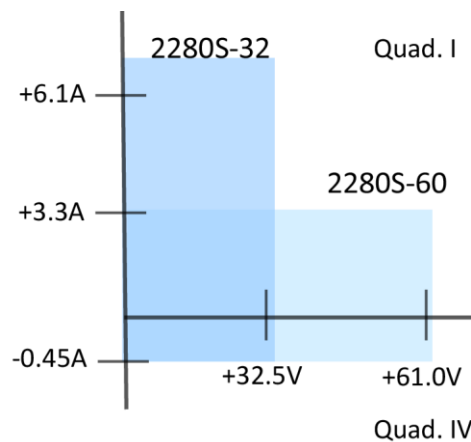

For example, if a 12 V battery is connected to the voltage source (HI to battery high) that is programmed for +10 V, sink operation occurs in the quadrant IV (source +V and measure -I).

Measurement optimization

In this section:

Introduction	4-1
Optimizing either measurement accuracy or speed	4-1
Math calculations that you can apply to measurements.....	4-11
Relative offset	4-12
Displayed measurements.....	4-15

Introduction

This section contains information that will help you get more useful measurement data and better instrument performance.

Optimizing either measurement accuracy or speed

You can use resolution, NPLC, autozero, and filter to optimize measurement accuracy and speed.

You can configure the following parameters to optimize for either measurement accuracy or measurement speed.

- **Measurement resolution:** Number of digits displayed
- **Integration time:** Number of power line cycles (NPLC)
- **Autozero:** Minimizing measurement drift
- **Filtering:** A type of averaging

NOTE

Changing the resolution automatically adjusts some of these parameters.

Resolution

You can specify a resolution to adjust the measurement accuracy and speed. Changing resolution affects NPLC, autozero, display digits, and average filter. For details, see the following table.

Resolution	NPLC	Autozero state/ source delay	Display digits	Average filter	Benefit	Limitation
6.5	1.0	Autozero state: On Source delay: 0.001 s Source delay state: On	6.5	Filter count: 10 Filter window: 0.01% State: On	Low noise readings Compensate for temperature gain and offset changes Maximum display resolution	Low reading speeds
5.5	0.1	Autozero state: Off Source delay: 0.001 s Source delay state: On	5.5	Filter count: 10 Filter window: 0.01% State: Off	Moderate reading rates	Environmental 50/60 Hz ambient noise can impact readings Reduced display resolution
4.5	0.002	Autozero state: Off Source delay: 0 s Source delay state: Off	4.5	Filter count: 10 Filter window: 0.01% State: Off	Best reading rate speeds. Capture 50 μ s pulsed current measurements	Environmental 50/60 Hz ambient noise can impact readings Lowest display resolution

NOTE

Resolution controls the best possible combination of reading speed, accuracy, and front-panel display digits.

You can independently adjust the front-panel digits using front panel or remote commands. The setting of front-panel digits will not impact reading speed or accuracy. For details, refer to [Displayed digits](#) (on page 4-6).

If you change the resolution to 5.5 or 6.5, the instrument enables source delay and sets the delay time to 1 ms.

Setting resolution

To set the resolution from the front panel:

1. Select the measurement function. The resolution setting will be applied to this function. For more information, you can refer to [Select a measurement function](#) (on page 2-74).
2. Press the **HOME** key.
3. Press the **Next** soft key to switch to home screen 2.
4. Press the **Resolution** soft key.
5. Select one of the resolution values.

To set the resolution for the current, voltage, or concurrent function using SCPI commands:

```
SENse:CURRent:RESolution <n>  
SENse:VOLTagE:RESolution <n>  
SENse:CONCurent:RESolution <n>
```

Where <n> is:

- 4 = 4.5 digit resolution
- 5 = 5.5 digit resolution
- 6 = 6.5 digit resolution

NPLC

You can adjust the amount of time that the input signal is measured. Adjustments to the amount of time affect the usable measurement resolution, the amount of reading noise, and the reading rate of the instrument.

The amount of time is specified in parameters that are based on the number of power line cycles (NPLCs). Each power line cycle for 60 Hz is 16.67 ms (1/60); for 50 Hz, it is 20 ms (1/50).

The shortest amount of time (0.002 PLCs) results in the fastest reading rate, but increases reading noise and decreases the number of usable digits.

The longest amount of time (12 PLCs for 60 Hz and 15 PLCs for 50 Hz) provides the lowest reading noise and more resolution, but has the slowest reading rate.

Settings between the fastest and slowest NPLCs are a compromise between speed and noise.

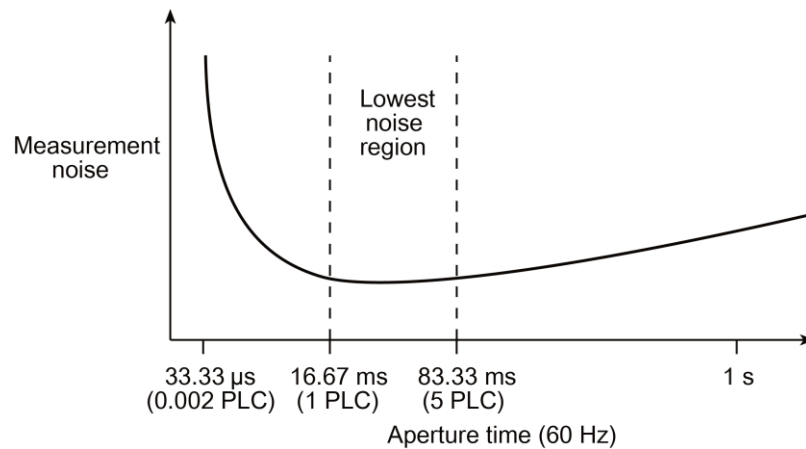
Figure 80: Speed vs. noise characteristic

NOTE

After adjusting the speed, you may want to adjust the number of digits that are displayed for measurements. See [Displayed digits](#) (on page 4-6).

To set the number of power line cycles (NPLCs) using the front panel:

1. Select the measurement function. The NPLC settings will be applied to this function. For more information, you can refer to [Select a measurement function](#) (on page 2-74).
2. Press the **MENU** key.
3. Under Measure, select **Settings**.
4. Next to NPLC, select the number. The NPLC window is displayed.
5. Enter the value and press the **ENTER** key.

Setting speed using SCPI commands

To set the NPLCs for current measurements, send the command:

```
:SENSe:CURRent:NPLCycles <n>
```

To set the NPLCs for concurrent measurements, send the command:

```
:SENSe:CONCurent:NPLCycles <n>
```

To set the NPLCs for voltage measurements, send the command:

```
:SENSe:VOLTag:e:NPLCycles <n>
```

Where <n> is a value from 0.002 to 15 for 60 Hz and from 0.002 to 12 for 50 Hz. A value of 0.002 results in the fastest reading rates, and a value of 12 or 15 results in the lowest reading noise.

For example, to set the NPLCs for voltage measurements to 0.5, send the command:

```
SENSe:VOLTag:e:NPLCycles 0.5
```

Autozero measurements

To ensure the reading accuracy, the instrument must measure internal references corresponding to the zero low and gain high references. The time interval between reference updates is determined by the integration aperture that is used for each user and internal reference analog-to-digital converter (ADC) measurement.

By default, the instrument automatically checks the references for each triggered reading. This can result in a longer expected time interval. This additional time can cause problems in the test sequences in which measurement timing is critical. To eliminate the extra time, the automatic internal reference ADC measurements can be disabled, allowing the instrument to measure only the user portion of the reading.

When automatic reference measurements are disabled, the instrument speed per reading increases. However, the instrument may gradually drift out of specification.

Measurement function	With autozero enabled, the number of customer and internal reference ADC measurements per reading	With autozero disabled, the number of customer and internal reference ADC measurements per reading
Concurrent (V + I)	5	2
Current (I)	4	1
Voltage (V)	3	1

For example, when autozero is enabled, making 100 readings in the concurrent function with 1 NPLC takes a total measurement time is (50 Hz power line frequency):

$$\text{Total time} = 5 * \text{reading number} * \text{NPLC} * (1/50) = 5 * 100 * 1 * (1/50) = 10 \text{ s}$$

When autozero is disabled, making 100 readings in concurrent function with 1 NPLC takes a total measurement time is (50 Hz power line frequency):

$$\text{Total time} = 2 * \text{reading number} * \text{NPLC} * (1/50) = 2 * 100 * 1 * (1/50) = 4 \text{ s}$$

Setting autozero

You can enable or disable automatic referencing. The reference setting is stored with the measure function.

To set autozero using the front panel:

1. Press the **MENU** key.
2. Under Measure, select **Settings**.
3. Next to **Auto Zero**, select **On** or **Off**.
4. Select **HOME** to return to the operating display.

To set autozero on or off using SCPI commands:

```
:SYSTem:AZERo[:STATe] ON  
:SYSTem:AZERo[:STATe] OFF
```

NOTE

If autozero is enabled, all functions make internal reference measurements. If disabled, no functions make internal reference measurements.

When you perform a fast low-current measurement, you can disable the autozero for better measurement speed. However, if you perform a high-current measurement, enable autozero to reduce the effect of temperature on the readings.

Displayed digits

You can set the number of digits that are displayed for measurement readings on the front panel. You can display 4.5, 5.5, or 6.5 digits. The default is 6.5.

The number of displayed digits does not affect accuracy or speed. It also does not affect the format of readings that are returned from a remote command.

Setting the displayed digits using the front panel

From the front panel:

1. Select the measurement function. The display digits will be applied to this function. For more information, you can refer to [Select a measurement function](#) (on page 2-74).
2. Press the **MENU** key.
3. Under Measure, select **Settings**.
4. Select the button next to **Digits**. The Digits setting window is displayed.
5. Select the digits to display.

This setting takes effect the next time you make measurements.

Setting the displayed digits using SCPI commands

To set the number of displayed digits using SCPI commands:

```
SENSe:VOLTage:DIGits <n>  
SENSe:CURRent:DIGits <n>  
SENSe:CONCurent:DIGits <n>
```

Where <n> is:

- 4 = 4.5 digit resolution
- 5 = 5.5 digit resolution
- 6 = 6.5 digit resolution

Filtering measurement data

Filters allow you to compute an average from a number of measurements. Averaging can reduce measurement fluctuations due to noise levels. This can help you produce more accurate measurements.

The Series 2280 provides a moving average filter function. Note that the greater the number of measurements that are averaged, the slower the averaged sample rate, but the lower the noise error. Trade-offs between speed and noise are normally required to tailor the instrument settings to your measurement application.

If you create test algorithms and you are using the averaging filters, make sure the algorithms clear the filter memory stacks at appropriate times to avoid averaging an inappropriate set of measurements.

Moving average filter

When the moving average filter is selected, the measurements are added to the stack continuously on a first-in, first-out basis. As each measurement is made, the oldest measurement is removed from the stack. A new averaged sample is produced using the new measurement and the data that is now in the stack.

Note that when the moving average filter is first selected, the stack is empty. When the first measurement is made, it is copied into all the stack locations to fill the stack. A true average is not produced until the stack is filled with new measurements.

For example, if the filter size is four, the first measurement is copied to all four-stack locations. Therefore, $(\text{Reading1} + \text{Reading1} + \text{Reading1} + \text{Reading1})/4$. The display and remote interface update after first reading. With each additional measurement, the average updates:

$$(\text{Reading2} + \text{Reading1} + \text{Reading1} + \text{Reading1})/4$$

$$(\text{Reading3} + \text{Reading2} + \text{Reading1} + \text{Reading1})/4$$

$$(\text{Reading4} + \text{Reading3} + \text{Reading2} + \text{Reading1})/4$$

Details on digital filter characteristics are provided in the following paragraphs.

- **Filter count:** The filter count specifies the number of measurements to be made for each averaged measurement sample. It can be set from 2 to 100.
- **Filter window:** The digital filter uses a window to control filter threshold. When the reading value remains within the selected window, the measurements continue to be placed in the stack. If the reading changes to a value outside the window, the filter resets and starts processing again with a new initial measurement.

The filter window, which is expressed as a percentage of range, allows a faster response time to large signal step changes. A reading conversion outside the plus or minus window fills the filter stack immediately.

If the reading value does not exceed the selected window, the reading is based on the average of the reading conversions. If the reading value does exceed the selected window, the reading is a single reading conversion and new averaging starts from this point.

The five window selections from the front panel are 0.01%, 0.1%, 1%, 10%, and 100%. Note that the 100% setting means that no limit is applied and all readings are included in the averaging. For voltage and current, the actual filter limit is expressed as a percent of range.

For example, on the 10 mA range, a 10% window means that the filter is ± 1 mA.

Figure 81: Filter window

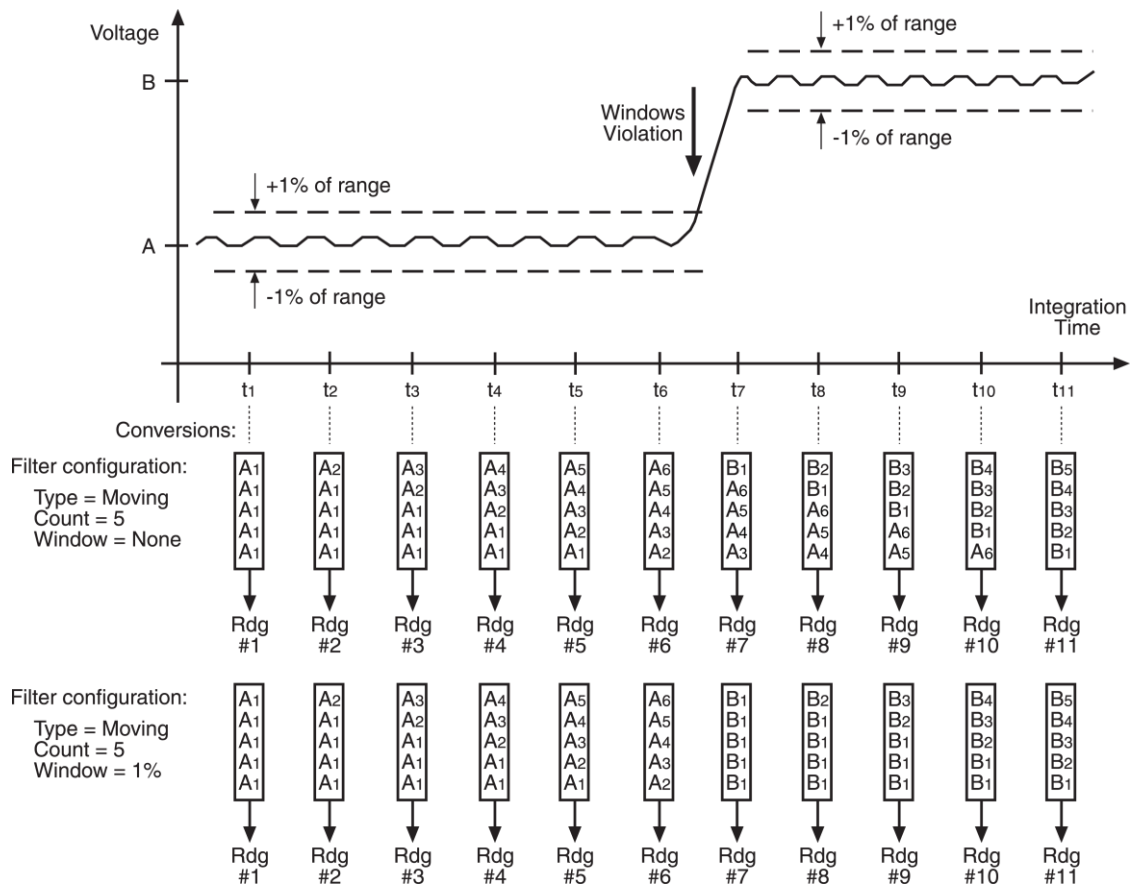

NOTE

When you select the concurrent measurement function, filter operations only apply to current measurements and do not affect voltage measurements.

Setting up the averaging filter

Using the front panel:

1. Select the measurement function. The filter will be applied to this function. For more information, you can refer to [Select a measurement function](#) (on page 2-74).
2. Press the **MENU** key.
3. Under Measure, select **Rel/Filter**.
4. For the **Filter State**, select **On** or **Off**.
5. For the **Count**, enter the number of measurements to be made for each averaged measurement sample.

6. For the **Window**, select one of the sizes.
7. Select **HOME** to return to the operating display.

NOTE

Once the filter type and count are set up, you can enable and disable the averaging filter from the home screen. On home screen 2, press the **Calculate** soft key. The Calculate window is displayed. Press the **Filter** soft key to enable or disable the filter operation. When the operation is enabled, the **CALC** indicator on the home screen is illuminated.

Using SCPI commands

To set number of measurements to be averaged for current measurements:

```
:SENS:CURR:AVER:COUN <n>  
:SENS:CONC:AVER:COUN <n>  
:SENS:VOLT:AVER:COUN <n>
```

Where <n> is the number of measurements to average (2 to 100).

To set filter type to be averaged:

```
:SENS:CURR:AVER:TCON <type>  
:SENS:CONC:AVER:TCON <type>  
:SENS:VOLT:AVER:TCON <type>
```

Where <type> is the filter type MOVing.

To set the filter window size:

```
:SENS:CURR:AVER:WIND <n>  
:SENS:CONC:AVER:WIND <n>  
:SENS:VOLT:AVER:WIND <n>
```

Where <n> is window size (0.01 to 100).

To enable the selected averaging filter:

```
:SENS:CURR:AVER:STATe ON  
:SENS:CONC:AVER:STATe ON  
:SENS:VOLT:AVER:STATe ON
```

Math calculations that you can apply to measurements

The Series 2280 supports $mx+b$ built-in math calculations. Math calculations are applied to the input signal after filter and relative offset operations are completed. For more details on the order of operations, see [Displayed measurements](#) (on page 4-15).

Math operations apply to the selected measurement function. If you change the measurement function, the math operation for that measurement function becomes active.

NOTE

When you select the concurrent measurement function, math operations only apply to current measurements and do not affect voltage measurements.

$mx+b$

The $mx+b$ math operation lets you manipulate normal display readings (x) mathematically based on the following calculation:

$$mx + b = Y$$

Where:

m = A user-defined constant for the scale factor

x = The measurement reading (if you are using a relative offset, this is the measurement with relative offset applied)

b = A user-defined constant for the offset factor

Y = The displayed result

When the $mx+b$ math operation is active, the unit of measure for the front-panel voltage and current readings defaults to the character X and the `CALC` indicator is displayed to the right of the measurement.

NOTE

The `CALC` indicator represents the filter and $mx+b$ operation status. If filter or math operation is enabled, the `CALC` indicator is displayed to the right of the measurement.

Setting mx+b math operations

From the front panel:

1. Select the measurement function. The math operations will be applied to this function. For more information, you can refer to [Select a measurement function](#) (on page 2-74).
2. Press the **MENU** key.
3. Under Measure, select **Math**.
4. Select the button next to **Math State**. The State selection window is displayed.
5. Select **On**.
6. Select the button next to **m (Gain)** and enter a value for m.
7. Select the button next to **b (Offset)** and enter a value for b.
8. Select the button next to **Units**. The keyboard is displayed.
9. Select one alpha character for the units of mx+b operation.

NOTE

Once m, b, and units are set up, you can enable and disable the math operation from the home screen. On home screen 2, press the **Calculate** soft key. The Calculate window is displayed. Press the **Math** soft key to enable or disable the math operation. When the operation is enabled, the **CALC** indicator on the home screen is visible.

Using SCPI commands

To set the math operations to mx+b for the current function:

```
:CALC:CURRE:FORM MXB
:CALC:CURRE:KMAT:MMF <m>
:CALC:CURRE:KMAT:MBF <b>
:CALC:CURRE:KMAT:MUN 'X'
:CALC:CURRE:STAT ON
```

Where <m> is the m factor, is the b factor, and 'X' is the math unit.

To set the math operations for a different function, change **CURREnt** to **VOLTage** for voltage measurements or **CONCurrent** for concurrent measurements.

NOTE

For concurrent measurements, the math operations are applied only to current measurements.

Relative offset

When making measurements, you may want to subtract an offset value from a measurement.

The relative offset feature subtracts a set value or a baseline reading from measurement readings. When you enable relative offset, all measurements are recorded as the difference between the actual measured value and the relative offset value. The formula to calculate the offset value is:

$$\text{Displayed value} = \text{Actual measured value} - \text{Relative offset value}$$

When a relative offset value is established for a measurement function, the value is the same for all ranges for that measurement function. For example, if 2 A is set as the relative offset value on the 10 A range, the relative offset value is also 2 A on the 1 A, 100 mA, and 10 mA ranges.

On the front panel, when relative offset is enabled, the REL indicator to the right of the measured value is displayed.

A relative offset value is saved for each function. If you change the measurement function, the relative offset value is changed to the setting for that measurement function.

The relative offset is applied to the measurement before any math functions. For more information on the order in which operations are performed, see [Displayed measurements](#) (on page 4-15).

NOTE

When you select the concurrent measurement function, relative offset only applies to current measurements and does not affect voltage measurements.

Establishing a relative offset value

You can use the Series 2280 to automatically determine the relative offset, or you can assign a specific relative offset value.

Setting a relative offset value

You can set a specific relative offset value using the front panel or the remote commands.

Using the front panel:

1. Select the measurement function. The relative offset will be applied to this function. For more information, you can refer to [Select a measurement function](#) (on page 2-74).
2. Press the **MENU** key.
3. Under Measure, select **Rel/Filter**.
4. Select the button next to **Reference** and enter a value.

Using SCPI commands:

```
:SENSe:FUNctIon "VOLTage"  
:SENSe:VOLTage:REFerence <n>  
:SENSe:VOLTage:REFerence:STATe ON
```

Where <n> is the amount of the offset.

To set the relative offset for another function, replace `VOLTage` with `CURRent` or `CONCurent`.

Turning on the relative offset

Using the front panel:

1. Select the measurement function. The relative offset will be applied to this function. For more information, you can refer to [Select a measurement function](#) (on page 2-74).
2. Press the **Next** soft key to go to soft key menu 2.
3. Under Calculate in the soft key menu, select **Set** and press **Enter**.
4. Press the soft key below **Rel**. The `REL` indicator to the right of the measurement is displayed.

NOTE

The relative offset feature can also be enabled or disabled by selecting **MENU > Measure > Rel/Filter > Rel State**, and then selecting **On** or **Off**.

Using SCPI commands:

```
:SENSe:VOLTage:REFerence:STATe ON  
:SENSe:CURRent:REFerence:STATe ON  
:SENSe:CONCurent:REFerence:STATe ON
```

NOTE

The default reference value is 0.

Automatically acquiring a relative offset value

When you automatically acquire a relative offset value, the Series 2280 performs the following actions:

- Makes a new measurement.
- Stores the measurement as the new relative offset level.

NOTE

Before you automatically acquire a reference for relative offset, make sure that the trigger model is not in idle mode, set the arm and trigger source to immediate, and turn on the output. For more information about the trigger model, see [Trigger model](#) (on page 3-25).

Using the front panel:

1. Select the measurement function. The relative offset will be applied to this function. For more information, you can refer to [Select a measurement function](#) (on page 2-74).
2. Press the **MENU** key.
3. Under Measure, select **Rel/Filter**.
4. Select the button next to **Rel Acquire** and press **Enter**.

Using SCPI commands:

```
:SENSe:FUNCTION "VOLTage"  
:SENSe:VOLTage:REFeRence:ACQuire  
:SENSe:VOLTage:REFeRence:STATe ON
```

To acquire a relative offset value for another function, replace **VOLTage** with **CURRENT** or **CONCURRENT**.

Displayed measurements

When you make measurements, the instrument may perform operations on the measured values that affect what you see on the display and the measurements that are stored in the buffer.

The operations that can affect the measurement display are:

- Filter operations
- Relative offset
- Math operations

If none of these operations are set, the value that is displayed on the front panel is the actual measurement reading.

If any of these operations are set, the value that is displayed is the measurement reading with these operations applied. For example, if you made a measurement and had a relative offset specified, the measured value would have the relative offset applied. For details, refer to the following data flow figure.

Figure 82: Data flow

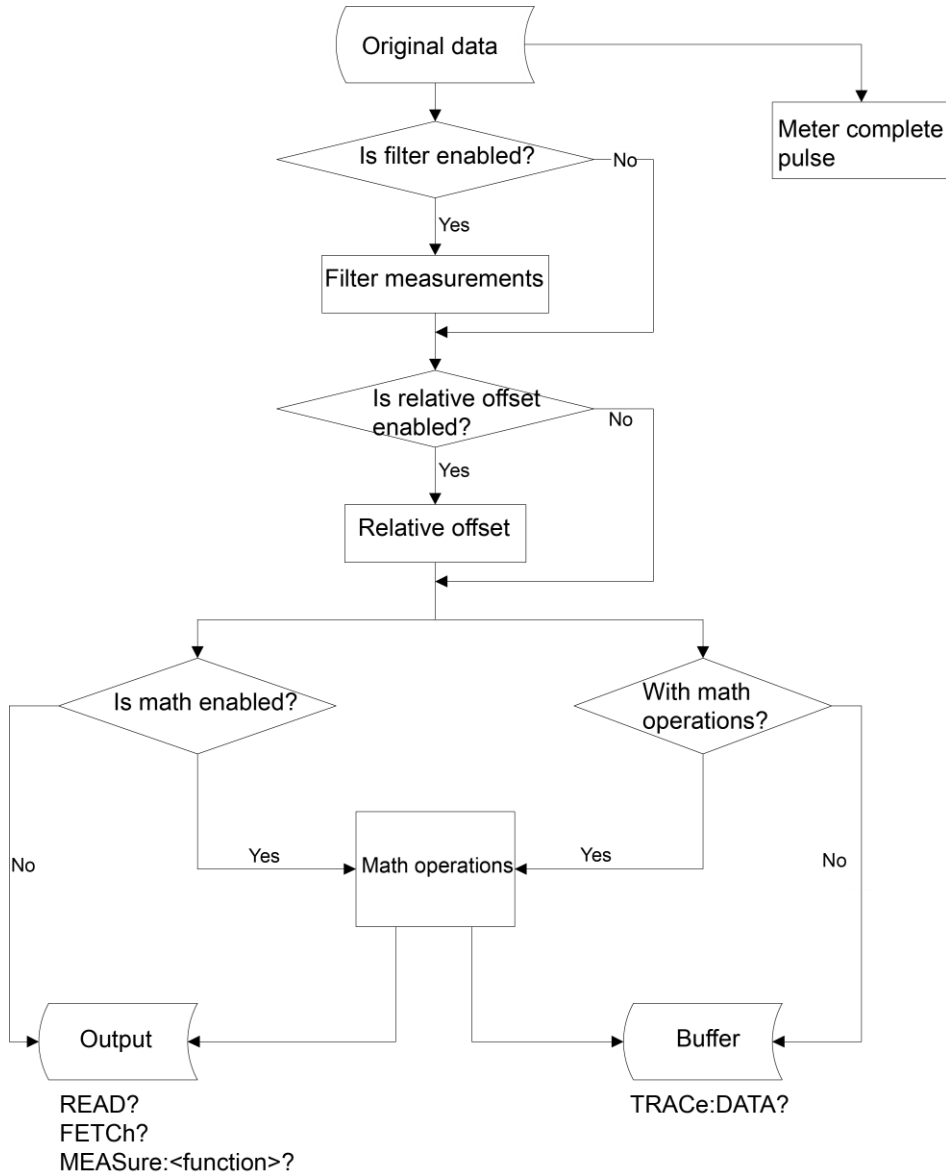

Select the source of readings

You can select the source of readings saved to the buffer using the front panel or SCPI commands.

Using the front panel:

1. Press the **MENU** key.
2. Under Measure, select **Math**.
3. Select the button next to **Buffer Data Type** and press **Enter**.
4. Select **Reading** or **CALC**.

The Reading option selects readings before any math calculations are done. For the CALC option, the result of the math calculation is stored in the buffer.

Using SCPI commands

To select the source of readings before the math calculation:

```
:TRACe:FEED SENSE
```

To save the source of readings after the math calculation:

```
:TRACe:FEED CALCulate
```

Application examples

In this section:

Simple voltage output and current measurement.....	5-1
Configure and execute a 10-step linear list sweep.....	5-3
Perform a fast current load measurement.....	5-7

Simple voltage output and current measurement

This example demonstrates how to configure a voltage output make a precision voltage and current measurement using the default instrument configuration.

Equipment required

- One Series 2280 Power Supply
- 1 k Ω resistor
- Two banana cables

Set up remote communications

You can run this application from the front panel or any of the supported communication interfaces for the instrument (GPIB, USB, or ethernet).

The following figure shows the rear-panel connection locations for the remote communication interfaces. For additional information about setting up remote communications, see [Remote communications interfaces](#) (on page 2-44).

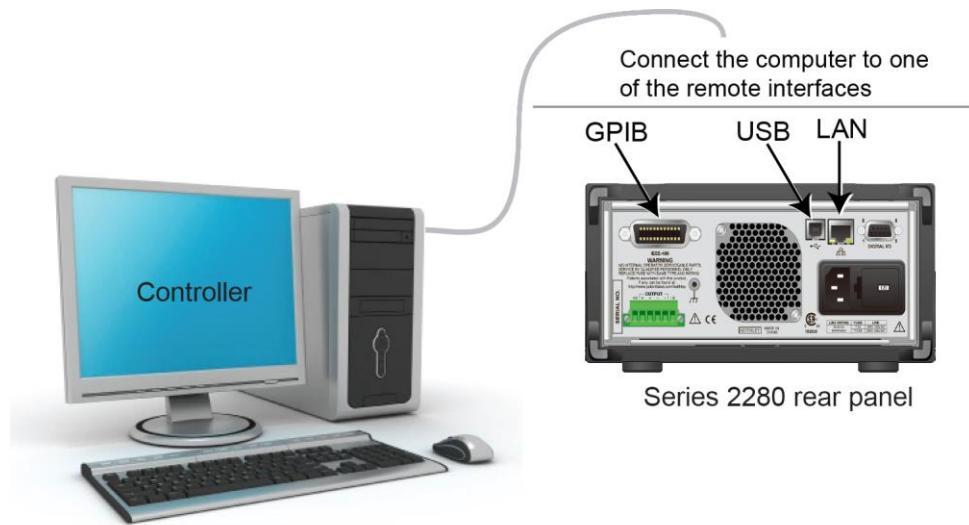
Figure 83: Series 2280 remote interface connections

Device connections

Connect the DUT (for this example, a 1 k Ω resistor) to the output binding posts on the front panel. For details, refer to [Two-wire local sense connection](#) (on page 2-39). You also can use four-wire connections to compensate for voltage drops on the load leads.

Set the voltage and current limit

To set the voltage and current limit on the front panel:

1. Press the **HOME** key. The home screen is displayed.
2. Press the **V-Set** soft key. The editing window is displayed at the bottom.
3. Set the voltage to 5 V. Enter 5 using the numerical keys on the right of the front panel. You can also change the value using either the arrows keys or navigation control.
4. Press the **I-Limit** soft key. The editing window is displayed at the bottom.
5. Set the current limit to 1 A. Press **ENTER**.

CAUTION

When the output is turned on, changing the value with the navigation control can source voltage and current instantly. Make sure the output does not damage your device under test (DUT).

6. Press the **OUTPUT** switch to turn the output on.

Figure 84: Voltage and current readback

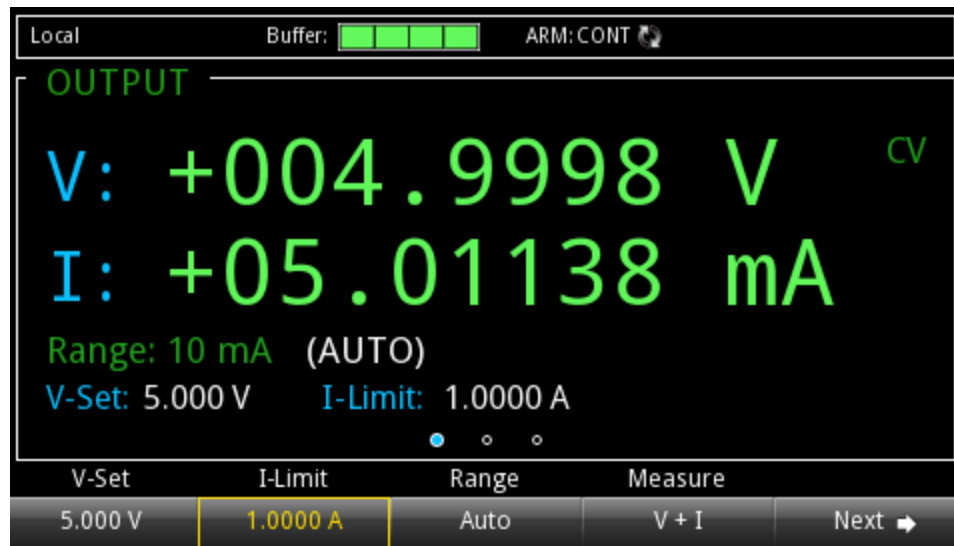

To set the voltage and current limit, send the following SCPI commands:

```
*RST
:VOLT 5
:CURR 1
:OUTP ON
:INIT:CONT ON
```

Configure and execute a 10-step linear list sweep

This example demonstrates the steps to set up the power supply to output a linear list sweep from 1 V to 10 V in 1 V steps (default settings). Each step in the list sweep will dwell for 3 s. The list is stored in list location 1. The output turns on at 0 V and return to 0 V at the end of the list execution.

Equipment required

- One Series 2280 Power Supply
- 1 k Ω resistor
- Two banana cables

Set up remote communications

You can run this application from the front panel or any of the supported communication interfaces for the instrument (GPIB, USB, or ethernet).

The following figure shows the rear-panel connection locations for the remote communication interfaces. For additional information about setting up remote communications, see [Remote communications interfaces](#) (on page 2-44).

Figure 85: Series 2280 remote interface connections

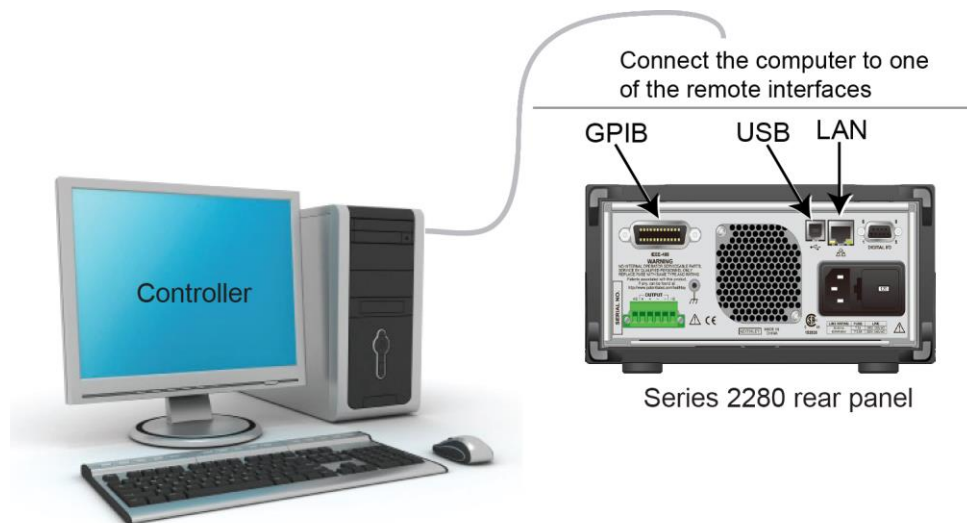

Device connections

Connect a 1 k Ω resistor to the output binding posts on the front panel. For details, refer to [Two-wire local sense connection](#) (on page 2-39). You also can use four-wire connections to compensate for voltage drops on the load leads.

Configure a 10-step linear list sweep

To configure a list on the front panel:

1. Press the **MENU** key.
2. Under Source, highlight the **List** icon using either the navigation control or the soft keys. Press **ENTER**.
3. Select point 1 and press **ENTER** to select the box.
4. Highlight **Insert** and press **ENTER** to increment the points display until it reads 10.
5. Select the Voltage box in the point 1 row. Press **ENTER**.
6. Make the value 1 V and press **ENTER**.
7. Select the Current box in the point 1 row. Press **ENTER**.
8. Make the value 2 A and press **ENTER**.
9. Select the Dwell box in the point 1 row. Press **ENTER**.
10. Make the value 3 s and press **ENTER**.
11. Repeat steps 5 to 8 for points 2 to 10 and increase the voltage by 1 V at each higher step.
12. Select the **Save** button to store the list in memory location 1.
13. Enter a name for the list on the displayed keypad and press **ENTER**.
14. Press the **EXIT** key.

Figure 86: Edit a 10-step list

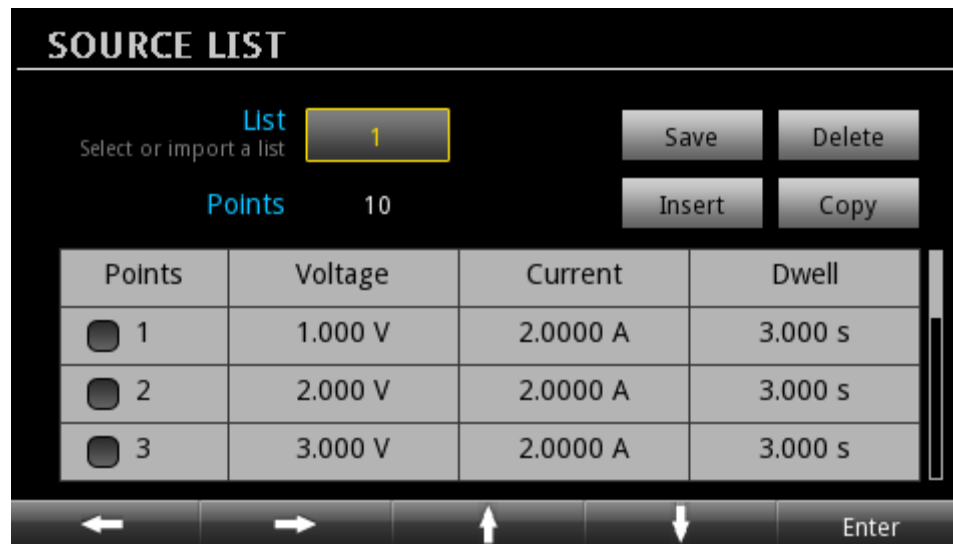

To delete a row on the front panel:

1. Highlight the Points cell of the row you want to delete.
2. Press **ENTER** to select the cell row.
3. Navigate to **Delete**.
4. Press **ENTER**.

Execute a 10-step linear list sweep

To execute a list sweep on the front panel:

1. Press the **MENU** key.
2. Under Trigger, highlight the **Configure** icon using either the navigation control or the soft keys. Press **ENTER**.
3. Select the button next to **Sample Count** and press the **ENTER** key.
4. Set the sample count to 10.
5. Press the **HOME** key.
6. Press the **Next** soft key twice to navigate to the third home screen.
7. Press the **List** soft key. The List dialog box is displayed.
8. If the **Number** soft key is not showing a 1, press the **Number** soft key and enter the value, 1.
9. Press the **Enable** soft key to run list 1.

To view the measurements on the front panel:

1. Press the **Exit** key to close the List dialog box.
2. Press the **View** soft key under Graph to view a plot of the measurements.

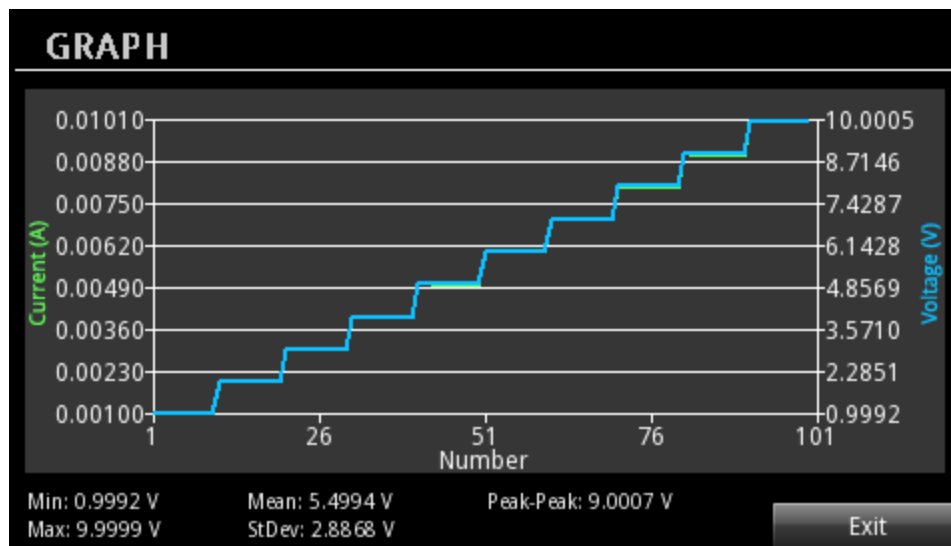
Figure 87: Graph view of 10-step linear list sweep

To configure and execute a list sweep using SCPI commands:

```
*RST
:SENS:CONC:NPLC 1
:LIST1:VOLT "1.0, 2.0, 3.0, 4.0, 5.0, 6.0, 7.0, 8.0, 9.0, 10.0"
:LIST1:CURR "2.0, 2.0, 2.0, 2.0, 2.0, 2.0, 2.0, 2.0, 2.0, 2.0"
:LIST1:DWEL "3.0, 3.0, 3.0, 3.0, 3.0, 3.0, 3.0, 3.0, 3.0, 3.0"
:LIST:SAVE:INTE 1
:LIST:RCL 1
:ARM:SOUR BUS
:TRIG:SOUR IMM
:TRIG:COUN 10
:TRIG:SAMP:COUN 10
:TRAC:CLE
:TRAC:FEED:CONT NEXT
:TRAC:FEED SENS
:TRAC:POIN 100
:LIST:STAT ON
:INIT
*TRG
*WAI
:TRAC:DATA? "READ, SOUR"
```

Perform a fast current load measurement

The following example demonstrates how to configure the power supply to perform a fast current measurement initiated by an external trigger on digital line 1.

Equipment required

- One Series 2280 power supply
- Dual-channel arbitrary function generator (Tektronix AFG3120C)
- Oscilloscope
- Resistors: 2.5 Ω and 20 Ω
- nMOSFET

Set up remote communications

You can run this application from the front panel or any of the supported communication interfaces for the instrument (GPIB, USB, or ethernet).

The following figure shows the rear-panel connection locations for the remote communication interfaces. For additional information about setting up remote communications, see [Remote communications interfaces](#) (on page 2-44).

Figure 88: Series 2280 remote interface connections

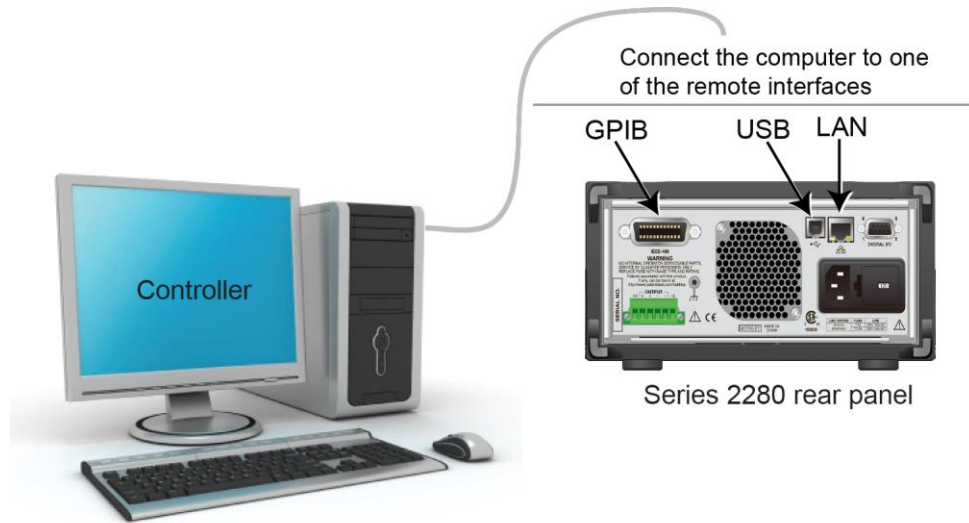

Device connections

Use a Tektronix two-channel AFG (for example, AFG3102C or equivalent) to generate two synchronous pulse signals. One signal is used to control the on and off state of an nMOSFET. The other is used as the external triggering signal of the Series 2280. For details, refer to the following table.

Parameter	nMOSFET control	Series 2280 external triggering
V _{peak-peak}	3 V	3 V
Offset	1.5 V	1.5 V
Period	20 ms	20 ms
Duty	2 ms	10 μs
Invert	Off	On

Figure 89: Fast current measurements setup

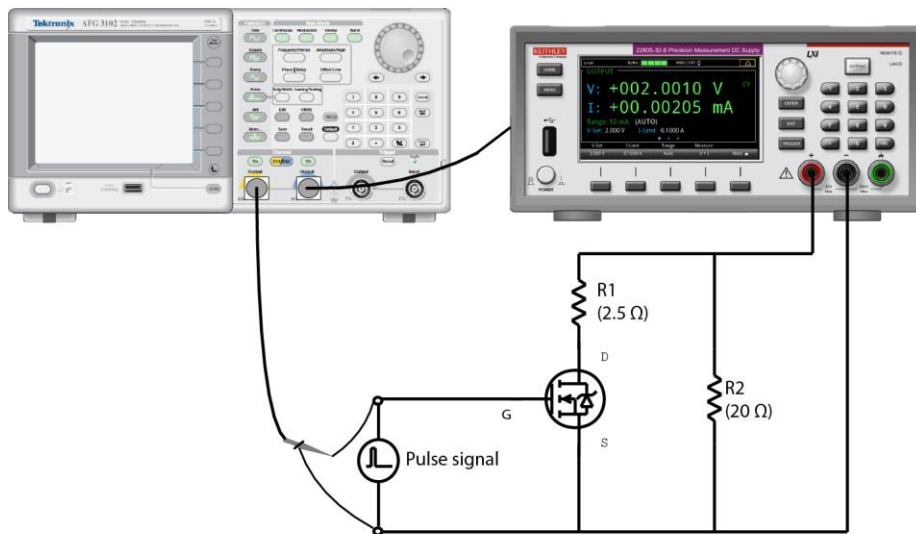

Connect the digital I/O pin 1 and pin 9 with the AFG output channel. For details on digital I/O, refer to [Digital I/O](#) (on page 3-19).

Figure 90: Digital I/O connection

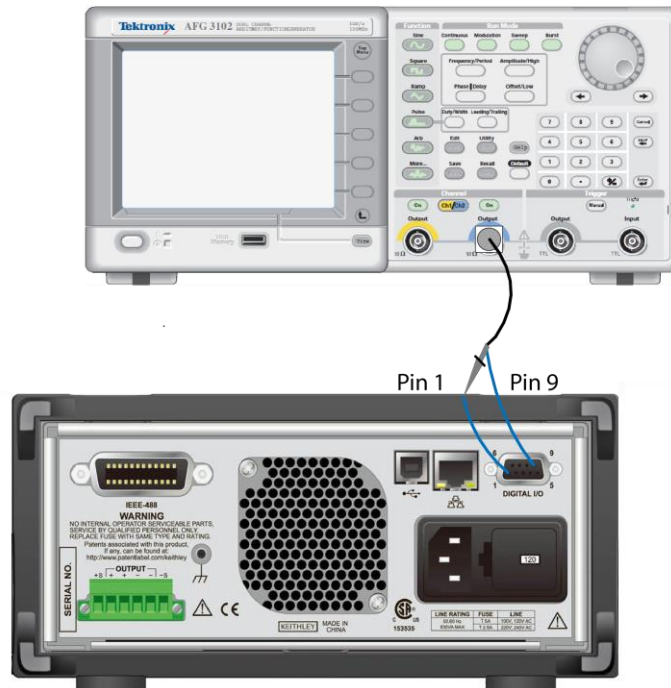

Measure the fast current load changes

To perform a fast current load measurement on the front panel:

1. Press the **MENU** key.
2. Under Measure, select **Settings**.
3. Select the button next to Function and press the **ENTER** key. The function dialog box is displayed.
4. Select the current measurement.
5. Select the button next to **Range** and press the **ENTER** key. The range dialog box is displayed.
6. Use the up and down arrow soft keys to select the 10 A range.
7. Select the button next to **Auto Zero** and press the **ENTER** key. The case issue dialog box is displayed.
8. Select **Off**.
9. Select the button next to **NPLC** and press the **ENTER** key. The number of power line cycles (NPLC) dialog box is displayed.
10. Set the NPLC to 0.01.
11. Connect the external trigger signal to digital I/O line 1 on the rear panel. For details of the digital I/O line, refer to the following table.

Pin	Description
1	I/O line 1
2	I/O line 2
3	I/O line 3
4	I/O line 4
5	V _{ext} line (relay flyback diode protection)
6	I/O line 5
7	+5 V line
8	I/O line 6
9	Ground

12. Press the **MENU** key.
13. Under Trigger, select **Configure**.
14. Select the button next to Arm Source and press the **ENTER** key.
15. Select **External**.
16. Select the button next to Sample Count and press the **ENTER** key.
17. Set the sample count to 30.
18. Press the **HOME** key.
19. Press the **V-Set** or **I-Limit** soft key. The editing window is displayed at the bottom of the screen.
20. Set the voltage to 5 V and current limit to 3 A.

21. Press the **OUTPUT** switch to turn on the output.

To view the current measurements on the front panel:

1. Press the **MENU** key.
2. Under Views, select **Graph**. You can view the current measurements.

Figure 91: Graph view of load current

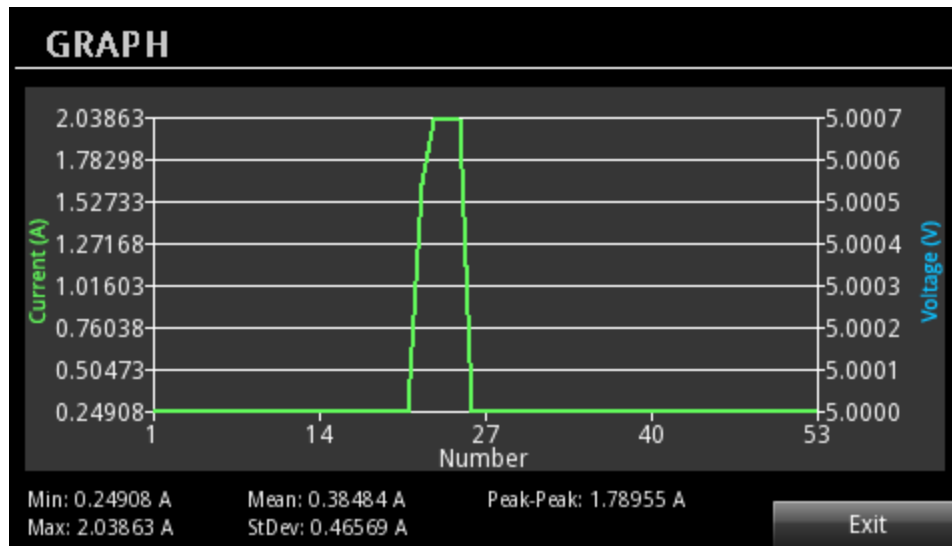

NOTE

When the resistive load is too large (for example, 32 M Ω), the settling time for the source increases. As a result, the instrument performs slow current measurements.

The following graphic shows the Tektronix oscilloscope plot of the generator pulse output and the load current. The green waveform shows the changes of load current and the yellow waveform shows the pulse output.

Figure 92: Oscilloscope plot

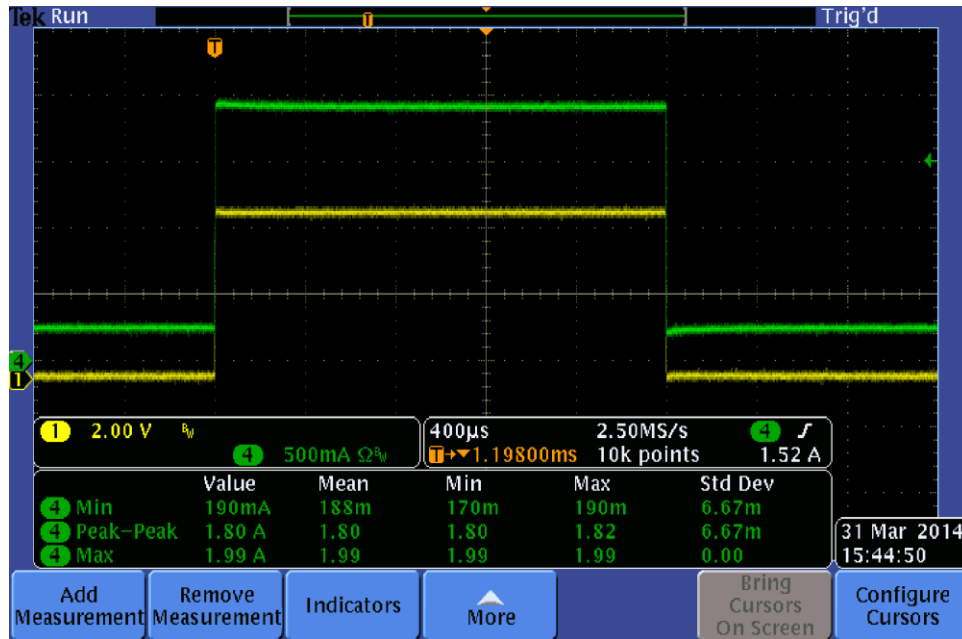

To perform a fast current load measurement using SCPI commands:

```
*RST
VOLT 5
CURR 3
SENS:FUNC "CURR"
SENS:CURR:NPLC 0.01
SENS:CURR:RANG:AUTO OFF
SENS:CURR:RANG 10
SYST:AZER OFF
DIG:LINE1:FUNC AUTO
INIT:CONT ON
TRIG:SOUR EXT
TRIG:COUN 1
TRIG:SAMP:COUN 30
OUTP ON
INIT
TRAC:DATA? "READ"
```

Introduction to SCPI commands

In this section:

Introduction to SCPI.....	6-1
SCPI command programming notes	6-2

Introduction to SCPI

The Standard Commands for Programmable Instruments (SCPI) standard is a syntax and set of commands that is used to control test and measurement devices.

The following information describes some basic SCPI command information and how SCPI is used with the Series 2280 and presented in the Series 2280 documentation.

Command messages

A command message is made up of one or more command words sent by the controller to the instrument.

SCPI commands contain several command words that are structured to create command messages. The command words are separated by colons (:). For example, the command words used to enable an average filter are:

```
:SENSe:CONCurent:AVERage:STATe ON
```

Many commands have query options. If there is a query option, it is created by adding a question mark (?) to the command. For example, to query the present state of the average filter, send:

```
:SENSe:CONCurent:AVERage:STATe?
```

Commands often take parameters. Parameters follow the command words and a space. For example, to turn on the output, send:

```
:OUTPut:STATe ON
```

SCPI can also use common commands, which consist of an asterisk (*) followed by three letters. For example, you can reset the instrument by sending the following command:

```
*RST
```

The examples above show commands that are sent individually. You can also group command messages when you send them to the instrument. To group a set of commands, separate them with semicolons. For example, to reset the instrument, enable relative offset, and set a relative offset of 0.5 for the current function in the same message, send the command:

```
*RST; :SENSe:CURRent:REFeRence:STATe ON; :SENSe:CURRent:REFeRence 0.5
```

The colon (:) at the beginning of a command is optional. For example, the following commands are equivalent:

```
:SENSe:CONCurrenT:REFeRence:STATe ON  
SENSe:CONCurrenT:REFeRence:STATe ON
```

Command execution rules

Command execution rules are as follows:

- Commands execute in the order that they are presented in the command message.
- An invalid command generates an error message and is not executed.
- Valid commands that precede an invalid command in a command message are executed.
- Valid commands that follow an invalid command in a command message are ignored.

SCPI command programming notes

This section contains general information about using Standard Commands for Programmable Instruments (SCPI).

SCPI command formatting

This section describes the formatting that this manual uses when discussing SCPI commands.

SCPI command short and long forms

This documentation shows SCPI commands with both uppercase and lowercase letters. The uppercase letters are the required elements of a command. The lowercase letters are optional. However, if you choose to include the letters that are shown in lowercase letters, you must include all of them.

When you send a command to the instrument, letter case is not important — you can mix uppercase and lowercase letters in program messages.

For example, you can send the command `:DISPlay:CLEAr` in any of the following formats:

```
:DISPlay:CLEAr
:display:clear
:DISP:CLE
:disp:cle
```

Optional command words

If a command word is enclosed in brackets ([]), the command word is optional. Do not include the brackets if you send the optional command word to the instrument.

For example, you can send the command `:STATus:MEASurement[:EVENT]?` in any of the following formats:

```
:STATus:MEASurement:EVENT?
:STATus:MEASurement?
:STAT:MEAS:EVENT?
:STAT:MEAS?
```

MINimum, MAXimum, and DEFault

You can use `MINimum`, `MAXimum`, or `DEFault` instead of a parameter for some commands.

For example, you can set `<defaultParameter>` for the command `:SENSe:CONCurent:NPLCycles <defaultParameter>` to the minimum, maximum, or default value. To set NPLC to the minimum value, you can send either of these commands:

```
:SENSe:CONCurent:NPLCycles MINimum
:SENS:CONC:NPLC MIN
```

Queries

SCPI queries have a question mark (?) after the command. You can use the query to determine the present value of the parameters of the command or to get information from the instrument.

For example, to determine what the present setting for NPLC is, you can send:

```
:SENSe:CONCurent:NPLCycles?
```

This query returns the present setting.

If the command has `MINimum`, `MAXimum`, and `DEFault` options, you can use the query command to determine what the minimum, maximum, and default values are. In these queries, the ? is placed before the `MINimum`, `MAXimum`, or `DEFault` parameter. For example, to determine the minimum value for NPLC, you can send:

```
:SENSe:CONCurent:NPLCycles? MINimum
```

If you send two query commands without reading the response from the first, and then attempt to read the second response, you may receive some data from the first response followed by the complete second response. To avoid this, do not send a query command without reading the response. When you cannot avoid this situation, send a device clear before sending the second query command.

When you query a Boolean option, the instrument returns a 0 or 1, even if you sent OFF or ON when you originally sent the command.

SCPI parameters

The parameters of the SCPI commands are shown in angle brackets (< >). For example:

```
:SYSTem:BEEPer:ERRor:STATe <state>
```

The type of information that you can use to replace <state> is defined in the Usage section of the command description. For this example, the usage is:

<state>	OFF or 0: Disable the beeper ON or 1: Enable the beeper
---------	--

For this example, you can enable the beeper by sending:

```
:SYSTem:BEEPer:ERRor:STATe ON
```

Note that you do not include the angle brackets when sending the command.

Sending strings

If you are sending a string, it must begin and end with matching quotes (either single quotes or double quotes). If you want to include a quote character as part of the string, type it twice with no characters in between.

A command string sent to the instrument must terminate with a <new line> character. The IEEE-488.2 EOI (end-or-identify) message is interpreted as a <new line> character and can be used to terminate a command string in place of a <new line> character. A <carriage return> followed by a <new line> is also accepted. Command string termination will always reset the current SCPI command path to the root level.

Using the SCPI command reference

The SCPI command reference contains detailed descriptions of each of the SCPI commands that you can use to control your instrument. Each command description is broken into several standard subsections. The figure below shows an example of a command description.

Figure 93: SCPI command description sample

:SYSTem:BEEPer:ERRor[:STATe]

This command allows you to turn the beeper on or off.

Type	Affected by	Where saved	Default value
Command and query	Recall settings Instrument reset Power cycle	Save settings	1 (ON)

Usage

```
:SYSTem:BEEPer:ERRor[:STATe] <state>
:SYSTem:BEEPer:ERRor[:STATe]?
```

<state>	Disable the beeper: OFF or 0 Enable the beeper: ON or 1
----------------------	--

Details

This command enables or disables the beeper for error messages. When enabled, a beep signals that an error has happened.

Example

```
:SYSTem:BEEPer:ERRor ON
```

Enable the error beeper.

Also see

[:SYSTem:KCLick](#) (on page 7-104)

Each command listing is divided into five subsections that contain information about the command:

- Command name and summary table
- Usage
- Details
- Example
- Also see

The content of each of these subsections is described in the following topics.

Command name and summary table

Each instrument command description starts with the command name, followed by a table with relevant information for each command. Definitions for the numbered items below are listed following the figure.

Figure 94: SCPI command description table identification

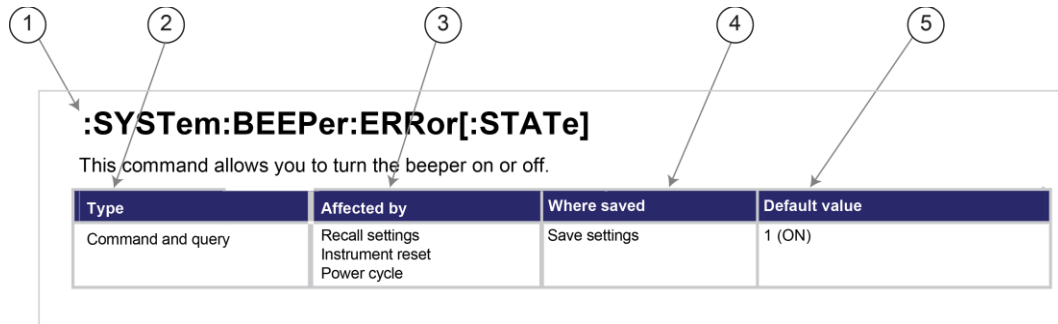

- Instrument command name.** Signals the beginning of the command description and is followed by a brief description of what the command does.
- Type of command.** Options are:
 - Command only.** There is a command but no query option for this command.
 - Command and query.** The command has both a command and query form.
 - Query only.** This command is a query.
- Affected by.** Commands or actions that have a direct effect on the instrument command.
 - Recall settings.** Also known as "Recall setup." Reload setting from a previous saved setup (`*RCL <1-5>`) or from the front panel.
 - Instrument reset.** Reset value back to its default setting (`*RST`) or through the front panel (Factory Preset: Reset value back to the factory preset value (`:SYST:PRES`)).
 - Power cycle.** Turn the instrument off and then on.
- Where saved.** Indicates where the command settings reside once they are used on an instrument. Options include:
 - Save settings.** Also known as "Save setup." This value is saved with the `*SAV <1-5>` command or through the front panel.
 - Not saved.** Command is not saved and must be sent each time you use it.
 - Nonvolatile memory.** Command is stored in a storage area in the instrument where information is saved even when the instrument is turned off.
- Default value.** Lists the default value for the command. The parameter values are defined in the Usage or Details sections of the command description.

Command usage

The Usage section of the remote command listing shows how to properly structure the command. Each line in the Usage section is a separate variation of the command usage; all possible command usage options are shown here.

Figure 95: SCPI command description usage identification

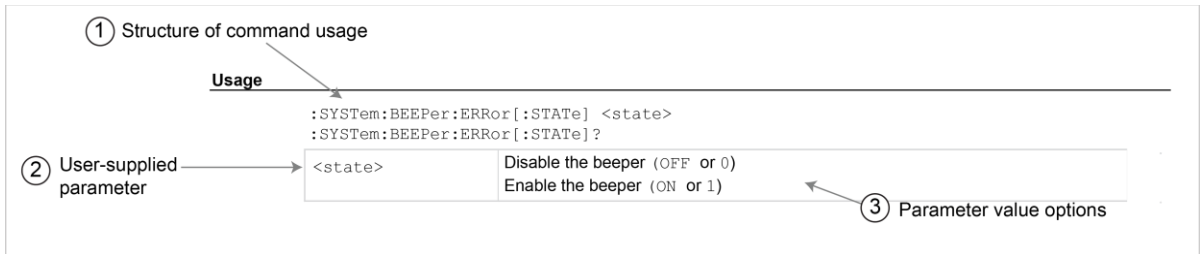

- 1. Structure of command usage:** Shows how the parts of the command should be organized.
- 2. User-supplied parameters:** Indicated by angle brackets (< >).

NOTE

Some commands have optional parameters. Optional parameters are presented on separate lines in the Usage section, presented in the required order with each valid permutation of optional parameters. For example:

```
:TRACe:DATA? "READ, SOURce, UNIT"
:TRACe:DATA? "READ"
:TRACe:DATA?
```

- 3. Parameter value options:** Descriptions of the options that are available for the parameter.

Command details

This section lists additional information you need to know to successfully use the command.

Figure 96: Details section of command listing

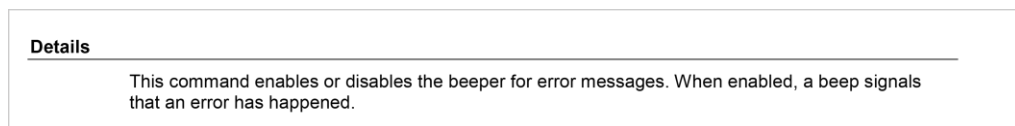

Example section

The Example section of the command description shows some simple examples of how the command can be used.

Figure 97: SCPI command description example



1. Example code that you can copy from this table and paste into your own application. Examples are generally shown using the short forms of the commands.
2. Description of the code and what it does. This may also contain the output of the code.

Related commands list

The Also see section of the remote command description lists commands that are related to the command being described.

Figure 98: SCPI command also see description



SCPI command reference

In this section:

Common commands.....	7-1
:ABORt[n].....	7-11
:CONFigure[n]:<function>.....	7-12
:FETCh[n]?.....	7-13
:FORMat:ELEMents.....	7-14
:FORCe:TRIGger.....	7-15
:MEASure[n]:<function>?.....	7-16
:READ[n]?.....	7-18
ARM subsystem.....	7-18
CALCulate subsystem.....	7-20
CALibration subsystem.....	7-34
Digital subsystem.....	7-44
DISPlay subsystem.....	7-46
INITiate subsystem.....	7-51
MMEMemory subsystem.....	7-52
OUTPut subsystem.....	7-53
SENSe subsystem.....	7-59
SOURce subsystem.....	7-74
STATus subsystem.....	7-94
SYSTem subsystem.....	7-110
TRACe subsystem.....	7-127
TRIGger subsystem.....	7-148

Common commands

This section describes the general remote interface commands and common commands. Note that although these commands are essentially the same as those defined by the IEEE Std 488.2 standard, the Series 2280 does not strictly conform to that standard.

The general remote interface commands are commands that have the same general meaning, regardless of the instrument you use them with (for example, `DCL` always clears the GPIB interface and returns it to a known state).

The common commands perform operations such as reset, wait-to-continue, and status.

Common commands always begin with an asterisk (*) and may include one or more parameters. The command keyword is separated from the first parameter by a blank space.

You can group command messages when you send them to the instrument. Use a semicolon to separate multiple commands, as shown below:

```
*RST; *CLS; *ESE 32; *OPC?
```

Although the commands in this section are shown in uppercase, common commands are not case sensitive (you can use either uppercase or lowercase).

*CLS

This command clears the event registers and error queues.

Type	Affected by	Where saved	Default value
Command only	Not applicable	Not applicable	Not applicable

Usage

*CLS

Details

Use *CLS to clear the event registers and queues. It performs the following actions:

- Clear the Standard Event Status Register and Status Byte Register.
- Clear the event register of Questionable Event, Questionable Instrument Event, and Questionable Instrument Summary Event.
- Clear the event register of Operation Event, Operation Instrument Event, and Operation Instrument Summary Event.
- Clear the event register of Measurement Event, Measurement Instrument Event, and Measurement Instrument Summary Event.
- Clear the error queue.

To reset all of the bits of the Standard Event Enable Register, send the command:

*ESE 0

Also see

[*ESE](#) (on page 7-3)

[STATus subsystem](#) (on page 7-94)

*ESE

This command sets and queries bits in the Standard Event Status Enable Register.

Type	Affected by	Where saved	Default value
Command and query	Power cycle	Not saved	See Details

Usage

*ESE <*n*>

*ESE?

<i>n</i>	The value of the Standard Event Status Enable Register (0 to 255)
----------	---

Details

When a bit in the Standard Event Status Enable Register is set and the corresponding bit in the Standard Event Status Register is set on, the ESB bit of the Status Byte Register is set.

To set a bit, send the constant or the value of the bit as the <*n*> parameter. When 0 (zero) is returned, no bits are set. You can also send 0 to clear all bits.

To query the Standard Event Status Enable Register (ESER), send *ESE?. The instrument returns a decimal value that corresponds to the binary-weighted sum of all bits set in the register.

Example

*ESE 145	*ESE 145 sets the Status Enable Standard Event Register to binary 10010001, which enables the PON, EXE, and OPC bits.
----------	---

Also see

[*CLS](#) (on page 7-2)

[Standard Event Register](#) (on page D-10)

[Status model](#) (on page D-1)

*ESR?

This command reads the contents of the Standard Event Status Register (SESR).

Type	Affected by	Where saved	Default value
Query only	Not applicable	Not applicable	Not applicable

Usage

*ESR?

Details

The instrument returns a decimal value that corresponds to the binary-weighted sum of all bits set in the register and clears the Standard Event Status Register.

Example

*ESR?	Query the contents of the Standard Event Status Register (SESR). Example output: 145 This output indicates that the SESR contains the binary value 10010001.
-------	---

Also see

[*ESE](#) (on page 7-3)

[Status model](#) (on page D-1)

*IDN?

This command retrieves the identification string of the instrument.

Type	Affected by	Where saved	Default value
Query only	None	Not applicable	Not applicable

Usage

*IDN?

Details

The identification string includes the manufacturer, model number, serial number, and firmware revision of the instrument. The string is formatted as follows:

```
KEITHLEY INSTRUMENTS,MODEL nnnn,xxxxxxx,yyyyy
```

Where:

nnnn = the model number

xxxxxxx = the serial number

yyyyy = the firmware revision level

Example

*IDN?

Output:

KEITHLEY INSTRUMENTS LLC,MODEL 2280S-32-
6,01234567,01.00**Also see**[System information](#) (on page 2-86)***OPC**

This command sets the operation complete (OPC) bit after all pending commands, including overlapped commands, have been executed.

Type	Affected by	Where saved	Default value
Command and query	Not applicable	Not applicable	Not applicable

Usage

*OPC
*OPC?

Details

When the *OPC command is sent, the OPC bit (bit 0) in the Status Event Status Register is set after all pending command operations have been executed.

When the *OPC? command is sent, an ASCII "1" is placed in the output queue after all pending command operations have been executed.

After all programmed operations are completed, the instrument returns to the idle state, at which time all pending commands (including *OPC and *OPC?) are executed. After the last pending command is executed, an ASCII "1" is placed in the output queue.

Also see[:INITiate\[n\]:IMMediate](#) (on page 7-52)

*LANG?

This command determines which command set is used by the instrument.

Type	Affected by	Where saved	Default value
Query only	Not applicable	Nonvolatile memory	SCPI

Usage

*LANG?

Details

The only available remote command set is SCPI, which is an instrument-specific language built on the SCPI standard.

Example

*LANG?	Verify the setting by sending the language query. Output: SCPI The SCPI command set is in use.
--------	---

Also see

None

*RCL

This command returns the instrument to the setup that was saved with the *SAV command.

Type	Affected by	Where saved	Default value
Command only	Not applicable	Not applicable	Not applicable

Usage

*RCL <n>

[n]	An integer from 1 to 5 that represents the saved setup
-----	--

Details

Restores the state of the instrument from a copy of its settings that are stored in the setup memory. The settings are saved using the *SAV command.

Example

*RCL 3	Restores the settings stored in memory location 3.
--------	--

Also see

[*SAV](#) (on page 7-7)
[Saving setups](#) (on page 2-82)

*RST

This command resets the instrument settings to their default values.

Type	Affected by	Where saved	Default value
Command only	Not applicable	Not applicable	Not applicable

Usage

*RST

Details

Returns the instrument to default settings, cancels all pending commands, and cancels the response to any previously received *OPC and *OPC? commands.

Also see

[Reset default values](#) (on page 2-88)

*SAV

This command saves the present instrument settings as a user-saved setup.

Type	Affected by	Where saved	Default value
Command only	Not applicable	Nonvolatile memory	Not applicable

Usage

*SAV <n>

[n]	An integer from 1 to 5.
-----	-------------------------

Details

Save the present instrument settings as a user-saved setup. You can restore the settings with the *RCL command.

Any command that is affected by the *RST command can be saved with the *SAV command.

Any settings that were stored previously as <n> are overwritten.

If you view scripts from the front panel of the instrument, these are stored as SETUP<n>.

Example

*SAV 2	Saves the instrument settings in memory location 2.
--------	---

Also see

[*RCL](#) (on page 7-6)

*SRE

This command sets and queries the bits of Status Request Enable Register.

Type	Affected by	Where saved	Default value
Command and query	Power cycle	Not saved	See Details

Usage

*SRE <n>

*SRE?

[n]	Clear the Status Request Enable Register: 0 Set the instrument for an SRQ interrupt: 32
-----	--

Details

To set a bit of Status Request Enable Register, send the constant or the value of the bit as the <n> parameter. You can also send 0 to clear all bits.

To query the Status Request Enable Register, send the *SRE? command. The instrument returns a decimal value that corresponds to the binary-weighted sum of all of the bits set in the register. For details, refer to [Status Byte Register](#) (on page D-7).

Example

*SRE 0	Clear the bits of the Status Request Enable Register.
--------	---

Also see

[Status model](#) (on page D-1)

*STB?

This command reads the contents of Status Byte Register.

Type	Affected by	Where saved	Default value
Query only	Not applicable	Not applicable	Not applicable

Usage

*STB?

Details

This command returns a decimal value that corresponds to the binary-weighted sum of all bits set in the register. Sending this command does not clear the bits in the Status Byte Register.

Example

*STB?

Query the contents of the Status Byte Register.

Output:

145

This output indicates that the Status Byte Register contains the binary value 10010001.

Also see[Standard Event Register](#) (on page D-10)[Status model](#) (on page D-1)***TRG**

This command generates a trigger event from a remote command interface.

Type	Affected by	Where saved	Default value
Command only	Not applicable	Not applicable	Not applicable

Usage

*TRG

Details

Use the *TRG command to generate a trigger event. Using *TRG has the same effect as a group execute trigger (GET).

Use the *TRG command as an event to control operation. The instrument reacts to this trigger if BUS is the programmed arm control source. The control source is programmed from ARM and TRIGGER subsystems.

Example

*RST

:ARM:SOUR BUS

:ARM:COUN 1

:TRIG:SOUR IMM

:TRIG:COUN 1

:TRIG:SAMP:COUNT 1

:OUTP ON

:INIT

*TRG

Restore RST defaults.

Select BUS control source for arm layer.

Set arm layer count to 1.

Set the source trigger layer to trigger immediately.

Set trigger layer count to 1.

Set measure count to 1.

Turn on the output.

Take the Series 2280 out of the idle state.

Trigger one measurement.

Also see[ARM subsystem](#) (on page 7-18)[Status model](#) (on page D-1)[TRIGGER subsystem](#) (on page 7-148)

*TST?

This command performs a complete self-test and returns the results.

Type	Affected by	Where saved	Default value
Query only	Not applicable	Not applicable	0

Usage

*TST?

Details

Sending the command returns 0. A self-test is not performed.

Also see

None

*WAI

This command postpones the execution of subsequent commands until all previous overlapped commands are finished.

Type	Affected by	Where saved	Default value
Command only	Not applicable	Not applicable	Not applicable

Usage

*WAI

Details

There are two types of instrument commands:

- **Overlapped commands:** Commands that allow the execution of subsequent commands while instrument operations of the overlapped command are still in progress.
- **Sequential commands:** Commands whose operations must finish before the next command is executed.

The *WAI command suspends the execution of commands until the instrument operations of all previous overlapped commands are finished. The *WAI command is not needed for sequential commands.

The Series 2280 has the following overlapped commands:

- *TRG
- :INITiate
- :CALibration:PROTection:STEP1:DATA
- :CALibration:PROTection:STEP2:DATA
- :CALibration:PROTection:STEP3:DATA
- :CALibration:PROTection:STEP4:DATA
- :CALibration:PROTection:STEP5:DATA
- :CALibration:PROTection:STEP6:DATA
- :CALibration:PROTection:STEP7:DATA
- :CALibration:PROTection:STEP8:DATA

Also see

[CALibration subsystem](#) (on page 7-34)

[*OPC](#) (on page 7-5)

[*TRG](#) (on page 7-9)

:ABORt[n]

This command stops all trigger model commands on the instrument.

Type	Affected by	Where saved	Default value
Command only	Not applicable	Not applicable	Not applicable

Usage

:ABORt [n]

[n]	Channel number: For single-channel instruments, the value is 1
-----	--

Details

When this command is received, the instrument stops the trigger model.

With continuous initiation disabled, the trigger model of the specified channel goes into the idle state. With continuous initiation enabled, operation continues at the top of the trigger model. For details, refer to [:INITiate\[n\]:CONTinuous](#) (on page 7-51).

Also see

[Trigger model](#) (on page 3-25)

:CONFigure[n]:<function>

This command configures the instrument to a specific setup for measurements.

Type	Affected by	Where saved	Default value
Command only	Recall settings Instrument reset Power cycle	Save settings	See Details

Usage

```
:CONFigure[n]:<function>
:CONFigure[n]:<function> <range>
:CONFigure[n]:<function> <range>,<resolution>
```

[n]	Channel number: For single-channel instruments, the value is 1
<function>	The measurement function to which this setting applies: <ul style="list-style-type: none"> ▪ Concurrent: CONCurrent[:DC] ▪ Current: CURRent[:DC] ▪ Voltage: VOLTage[:DC]
<range>	The range value. Current range and concurrent range: <ul style="list-style-type: none"> ▪ 10 mA range: 0.01 ▪ 100 mA range: 0.1 ▪ 1 A range: 1 ▪ 10 A range: 10 Voltage range: <ul style="list-style-type: none"> ▪ Model 2280S-32-6: 32 V ▪ Model 2280S-60-3: 60 V
<resolution>	<ul style="list-style-type: none"> ▪ 4.5 digit resolution: 4 ▪ 5.5 digit resolution: 5 ▪ 6.5 digit resolution: 6

Details

This command specifies which range and resolution are used for the selected measurement function.

If you send only the command without any parameters, the present setting values for range and for the selected measurement function are used.

Example

```
:CONF:CURR 0.01,5
```

Set the source current to the 10 mA range and the resolution to 5.5 digits.

Also see

[:SENSe\[n\]:<function>:RANGe](#) (on page 7-67)

[:SENSe\[n\]:<function>:RESolution](#) (on page 7-73)

:FETCh[n]?

This command reads the latest post-processed reading.

Type	Affected by	Where saved	Default value
Query only	Not applicable	Not applicable	Not applicable

Usage

:FETCh[n]?

[n]	Channel number: For single-channel instruments, the value is 1
-----	--

Details

This command requests the latest post-processed reading. This command does not trigger a measurement. It simply requests the last available reading.

If you send this command more than once and there are no new readings, it will return the same value that was returned as the previous query.

The return value format depends on the settings specified by the :FORMat:ELEMents command. For details about data flow, refer to [Displayed measurements](#) (on page 4-15).

Example

<pre>:FORM:ELEM "READ,UNIT" :FETCh?</pre>	<p>Specify the data elements contained in the readings. Return the latest reading. Example output: 1.230435E-02A</p>
---	--

Also see

[:FORMat:ELEMents](#) (on page 7-14)

:FORMat:ELEMents

This command specifies or queries data elements to be included in the data string.

Type	Affected by	Where saved	Default value
Command and query	Recall settings Instrument reset Power cycle	Save settings	READ, SOUR, UNIT, REL

Usage

```
:FORMat:ELEMents <item list>
:FORMat:ELEMents?
```

<item list>	See Details
-------------	-----------------------------

Details

When specifying data elements, you can:

- Specify buffer elements in any order.
- Include up to 9 elements in a single list.
- Repeat elements as long as the number of elements in the list is 9 or less.
- Use a comma to delineate multiple elements for a data point.
- Use single or double quotes to enclose all of the elements.

The options for <item list> are described in the following table.

Element	Description	Example output
READing	The measurement reading based on the measurement function	+8.034562E-03
SOURce	The source value	+4.566723E+01
UNIT	The unit of measurement reading, source value, and time stamp	'V', 'A' and 's'
MODE	Output state	CC (constant current), CV (constant voltage), or OFF
DATE	The date for the data point	07/01/2013
TIME	The time for the data point	19:21:36.2553
TSTamp	The timestamp for the data point	07/01/2013 19:21:36.2553
RELative	The relative time when the data point was measured, in seconds	+4.430876E+00s
RSTamp	The relative time when the data point was measured	12:23:32.2345

NOTE

The RELative and RSTamp elements are defined as the time since the first reading was stored in the buffer. These values are reset every 24-hours. The DATE, TIME, and TSTamp elements represent absolute time from the internal real-time clock (RTC).

Example

```
:FORMat:ELEMents "READ,TST"
```

Include reading and timestamp in the reading buffer,
Example output:
+8.034562E-03, 07/01/2013 19:21:36.2553

Also see

[:FETCh\[n\]?](#) (on page 7-13)
[:MEASure\[n\]:<function>?](#) (on page 7-16)
[:READ\[n\]?](#) (on page 7-18)

:FORCe:TRIGger

This command bypasses the control source (Arm layer or Trigger layer) when you do not wish to wait for the programmed event to occur.

Type	Affected by	Where saved	Default value
Command only	Not applicable	Not applicable	Not applicable

Usage

```
:FORCe:TRIGger [n]
```

```
[n]
```

Channel number: For single-channel instruments, the value is 1

Details

This command is used to bypass the control source of Arm layer or Trigger layer. For details, refer to [Trigger mode!](#) (on page 3-25).

Example: Bypass the control source of the arm layer

```
*RST
:INIT:CONT OFF
:TRACe:CLE
:ARM:SOUR MAN
:TRIG:SOUR IMM
:TRIG:SAMP:COUN 1
:TRIG:COUN 5
:ARM:COUN 1
:OUTP ON
:INIT
:FORC:TRIG
*WAI
:DATA:POIN:ACT?
```

Reset the instrument settings to their default values.
 Disable the continuous triggering.
 Clear the trace buffer.
 Set Arm layer to manual triggering.
 Set Trigger layer to external triggering.
 Set sample count to 1.
 Set trigger count to 5.
 Set Arm count to 1.
 Turn the output on.
 Take trigger model out of idle.
 Send a trigger to bypass the trigger event detector.
 Wait until 5 measurements are performed.
 Query how many readings are stored in the trace buffer.

Also see

[:ARM:SEQuence\[n\]:SOURce](#) (on page 7-20)
[:TRIGger\[:SEQuence\[n\]\]:SOURce](#) (on page 7-151)

:MEASure[n]:<function>?

This command makes a measurement and returns the reading.

Type	Affected by	Where saved	Default value
Query only	Not applicable	Not applicable	Not applicable

Usage

```
:MEASure[n]:<function>?
:MEASure[n]:<function>? <range>
:MEASure[n]:<function>? <range>,<resolution>
```

[n]	Channel number: For single-channel instruments, the value is 1
<function>	The measurement function to which this setting applies: <ul style="list-style-type: none"> ▪ Concurrent: CONCurrent[:DC] ▪ Current: CURRent[:DC] ▪ Voltage: VOLTage[:DC]
<range>	The range value. Current range and concurrent range: <ul style="list-style-type: none"> ▪ 10 mA range: 0.01 ▪ 100 mA range: 0.1 ▪ 1 A range: 1 ▪ 10 A range: 10 Voltage range: <ul style="list-style-type: none"> ▪ Model 2280S-32-6: 32 V ▪ Model 2280S-60-3: 60 V
<resolution>	<ul style="list-style-type: none"> ▪ 4.5 digit resolution: 4 ▪ 5.5 digit resolution: 5 ▪ 6.5 digit resolution: 6

Details

This command makes a measurement using the specified function and stores the reading in a reading buffer.

NOTE

If the buffer is set to NEVer mode, this command only makes a measurement and returns the reading without saving in the buffer.

If a different function is selected, sending this command changes the measurement function to the one specified by `<function>`. This function remains selected after the measurement is complete.

When this command is sent, the following commands execute in the following order:

- `:CONFigure[n]:<function>?`
- `:READ[n]?`

When `:CONFigure` is executed, the `MEASure?` parameters (`<range>` and `<resolution>`) are executed and the instrument goes into the single-measurement mode.

When `READ?` is executed, the following commands execute in the order below:

- `:ABORt`
- `:INITiate`
- `:FETCh?`

Example

```
:MEAS:CURR? 10,5
```

Measure current on the 10 A range with 5.5 digit display resolution.
Example output:
2.473375E-02A

Also see

[:CONFigure\[n\]:<function>](#) (on page 7-12)

[:READ\[n\]?](#) (on page 7-18)

:READ[n]?

This query makes measurements and returns the first reading.

Type	Affected by	Where saved	Default value
Query only	Not applicable	Not applicable	Not applicable

Usage

```
:READ[n]?
```

[n]	Channel number: For single-channel instruments, the value is 1
-----	--

Details

When this command is sent, the following commands execute in the order they are presented:

- :ABORt
- :INITiate
- :FETCh?

When this command is executed, the instrument resets the trigger model. If the instrument is in the idle state, the :INITiate command takes the instrument out of the idle state. The :FETCh? command reads the first post-processed reading.

Also see

- [:ABORt\[n\]](#) (on page 7-11)
- [:FETCh\[n\]?](#) (on page 7-13)
- [:INITiate\[n\]:IMMediate](#) (on page 7-52)

ARM subsystem

The commands in this subsystem configure and control the trigger model for the arm layer.

:ARM[:SEquence[n]]:COUNT

This command sets the number of times to repeat the Arm event.

Type	Affected by	Where saved	Default value
Command and query	Recall settings Instrument reset Power cycle	Save settings	1

Usage

```
:ARM[:SEquence[n]]:COUNT <count>
:ARM[:SEquence[n]]:COUNT?
:ARM[:SEquence[n]]:COUNT? DEFault
:ARM[:SEquence[n]]:COUNT? MINimum
:ARM[:SEquence[n]]:COUNT? MAXimum
```

[n]	Channel number: For single-channel instruments, the value is 1
<count>	The number of times to repeat the arm event: 1 to 2500

Example

```
ARM:COUN 4
```

Set the arm count to four.

Also see

[:TRIGger\[:SEquence\[n\]\]:COUNT](#) (on page 7-149)

[Trigger model](#) (on page 3-25)

:ARM[:SEQuence[n]]:SOURce

This command selects the control source for the arm layer.

Type	Affected by	Where saved	Default value
Command and query	Recall settings Instrument reset Power cycle	Save settings	IMM

Usage

```
:ARM[:SEQuence[n]]:SOURce <source>
:ARM[:SEQuence[n]]:SOURce?
```

[n]	Channel number: For single-channel instruments, the value is 1
<source>	<p>The trigger source for the arm layer:</p> <ul style="list-style-type: none"> ▪ Immediate triggering; no delay or gating in arm detection layer: IMMEDIATE. ▪ External triggering: EXTERNAL ▪ Manual triggering; the trigger signal is generated by pressing the TRIGGER key: MANUAL ▪ Bus triggering by the command *TRG: BUS

Example

ARM:SOUR BUS	Select bus triggering as the trigger source for the arm layer.
--------------	--

Also see

[:TRIGger\[:SEQuence\[n\]\]:SOURce](#) (on page 7-151)

[Trigger model](#) (on page 3-25)

CALCulate subsystem

The commands in this subsystem configure and control the math and statistic operations.

:CALCulate[1]:<function>:FORMat

This command specifies which math operation is performed on measurements.

Type	Affected by	Where saved	Default value
Command and query	Recall settings Instrument reset Power cycle	Save settings	MXB

Usage

```
:CALCulate[1]:<function>:FORMat <name>
:CALCulate[1]:<function>:FORMat <name>,<channel>
:CALCulate[1]:<function>:FORMat?
:CALCulate[1]:<function>:FORMat? <channel>
```

<function>	The measurement function to which this setting applies: <ul style="list-style-type: none"> Concurrent: CONCurrent[:DC] Current: CURRent[:DC] Voltage: VOLTage[:DC]
<name>	The name of the math operation: <ul style="list-style-type: none"> y = mx + b: MXB
<channel>	The channel number (default value is CH1): <ul style="list-style-type: none"> Channel 1: CH1 Channel 2: CH2

Details

This command specifies which math operation is performed on measurements for the selected measurement function.

You can choose the math operation $y = mx + b$, and math calculations are applied to the input signal after filter and relative offset operations.

$y = mx+b$: Manipulates normal display readings by adjusting the m and b factors.

Example

```
:CALC:VOLT:FORM MXB
```

Set the math function for voltage measurements to $mx + b$.

Also see

[:CALCulate\[1\]:<function>:KMATH:MBFactor](#) (on page 7-22)

[:CALCulate\[1\]:<function>:KMATH:MMFactor](#) (on page 7-23)

[:CALCulate\[1\]:<function>:KMATH:MUNits](#) (on page 7-25)

[:CALCulate\[1\]:<function>:STATE](#) (on page 7-26)

:CALCulate[1]:<function>:KMATH:MBFactor

This command specifies the offset for the $y = mx + b$ operation.

Type	Affected by	Where saved	Default value
Command and query	Recall settings Instrument reset Power cycle	Save settings	0

Usage

```
:CALCulate[1]:<function>:KMATH:MBFactor <n>
:CALCulate[1]:<function>:KMATH:MBFactor <n>,<channel>
:CALCulate[1]:<function>:KMATH:MBFactor?
:CALCulate[1]:<function>:KMATH:MBFactor? <channel>
```

<function>	The measurement function to which this setting applies: <ul style="list-style-type: none"> Concurrent: CONCurrent[:DC] Current: CURRent[:DC] Voltage: VOLTage[:DC]
[n]	The offset for the $y = mx + b$ operation; the valid range is -1e6 to +1e6
<channel>	The channel number (default value is CH1): <ul style="list-style-type: none"> Channel 1: CH1 Channel 2: CH2

Details

This attribute specifies the offset (b) for an $mx + b$ operation.

The $mx + b$ math operation lets you manipulate normal display readings (x) mathematically based on the calculation:

$$y = mx + b$$

Where:

- y is the displayed result
- m is a user-defined constant for the scale factor
- x is the measurement reading (if you are using a relative offset, this is the measurement with relative offset applied)
- b is the user-defined constant for the offset factor

Example

<pre>:CALC:VOLT:FORM MXB :CALC:VOLT:KMAT:MMF 0.80 :CALC:VOLT:KMAT:MBF 50 :CALC:VOLT:KMAT:MUN 'C' :CALC:VOLT:STATe ON</pre>	<p>Set the math function for voltage measurements to $mx+b$.</p> <p>Set the scale factor for voltage measurements to 0.80.</p> <p>Set the offset factor to 50.</p> <p>Set unit to 'C'</p> <p>Enable the math function.</p>
--	---

Also see

- [:CALCulate\[1\]:<function>:FORMat](#) (on page 7-21)
- [:CALCulate\[1\]:<function>:KMATH:MMFactor](#) (on page 7-23)
- [:CALCulate\[1\]:<function>:KMATH:MUNits](#) (on page 7-25)
- [:CALCulate\[1\]:<function>:STATe](#) (on page 7-26)

:CALCulate[1]:<function>:KMATH:MMFactor

This command specifies the scale factor for the $y = mx + b$ math operation.

Type	Affected by	Where saved	Default value
Command and query	Recall settings Instrument reset Power cycle	Save settings	1.000000

Usage

```
:CALCulate[1]:<function>:KMATH:MMFactor <n>
:CALCulate[1]:<function>:KMATH:MMFactor <n>,<channel>
:CALCulate[1]:<function>:KMATH:MMFactor?
:CALCulate[1]:<function>:KMATH:MMFactor? <channel>
```

<function>	The measurement function to which this setting applies: <ul style="list-style-type: none"> ▪ Concurrent: CONCurrent[:DC] ▪ Current: CURRent[:DC] ▪ Voltage: VOLTage[:DC]
[n]	The scale factor; the valid range is -1e6 to +1e6
<channel>	The channel number (default value is CH1): <ul style="list-style-type: none"> ▪ Channel 1: CH1 Channel 2: CH2

Details

This command sets the scale factor (m) for an $mx + b$ operation for the selected measurement function.

The $mx + b$ math operation lets you manipulate normal display readings (x) mathematically according to the following calculation:

$$y = mx + b$$

Where:

- y is the displayed result
- m is a user-defined constant for the scale factor
- x is the measurement reading (if you are using a relative offset, this is the measurement with relative offset applied)
- b is the user-defined constant for the offset factor

Example

<pre>:CALC:VOLT:FORM MXB :CALC:VOLT:KMAT:MMF 0.80 :CALC:VOLT:KMAT:MBF 50 :CALC:VOLT:KMAT:MUN 'C' :CALC:VOLT:STATe ON</pre>	<p>Set the math function for voltage measurements to $mx + b$.</p> <p>Set the scale factor for voltage measurements to 0.80.</p> <p>Set the offset factor to 50.</p> <p>Set unit to 'C'</p> <p>Enable the math function.</p>
--	---

Also see

- [:CALCulate\[1\]:<function>:FORMat](#) (on page 7-21)
- [:CALCulate\[1\]:<function>:KMATH:MBFactor](#) (on page 7-22)
- [:CALCulate\[1\]:<function>:KMATH:MUNits](#) (on page 7-25)
- [:CALCulate\[1\]:<function>:STATe](#) (on page 7-26)

:CALCulate[1]:<function>:KMATH:MUNits

This command specifies the units suffix name for the $y = mx + b$ math operation.

Type	Affected by	Where saved	Default value
Command and query	Recall settings Instrument reset Power cycle	Save settings	X

Usage

```
:CALCulate[1]:<function>:KMATH:MUNits <string>
:CALCulate[1]:<function>:KMATH:MUNits <string>,<channel>
:CALCulate[1]:<function>:KMATH:MUNits?
:CALCulate[1]:<function>:KMATH:MUNits? <channel>
```

<function>	The measurement function to which this setting applies: <ul style="list-style-type: none"> Concurrent: CONCurrent[:DC] Current: CURRent[:DC] Voltage: VOLTage[:DC]
<string>	The units for the $mx + b$ calculation; this parameter must be one character enclosed in single or double quotes. It can be any letter of the alphabet.
<channel>	The channel number (default value is CH1): <ul style="list-style-type: none"> Channel 1: CH1 Channel 2: CH2

Details

This command specifies the units suffix name for an $mx + b$ operation. Use one letter of the alphabet for the units suffix name.

Example

:CALC:VOLT:FORM MXB	Set the math function for voltage measurements to $mx + b$.
:CALC:VOLT:KMAT:MMF 0.80	Set the scale factor for voltage measurements to 0.80.
:CALC:VOLT:KMAT:MBF 50	Set the offset factor to 50.
:CALC:VOLT:KMAT:MUN 'C'	Set unit to 'C'
:CALC:VOLT:STATe ON	Enable the math function.

Also see

[:CALCulate\[1\]:<function>:FORMat](#) (on page 7-21)
[:CALCulate\[1\]:<function>:KMATH:MBFactor](#) (on page 7-22)
[:CALCulate\[1\]:<function>:KMATH:MMFactor](#) (on page 7-23)
[:CALCulate\[1\]:<function>:STATe](#) (on page 7-26)

:CALCulate[1]:<function>:STATE

This command enables or disables the math operations.

Type	Affected by	Where saved	Default value
Command and query	Recall settings Instrument reset Power cycle	Save settings	0 (OFF)

Usage

```
:CALCulate[1]:<function>:STATE <state>[,<channel>]
:CALCulate[1]:<function>:STATE? [<channel>]
```

<function>	The measurement function to which this setting applies: <ul style="list-style-type: none"> Concurrent: CONCurrent[:DC] Current: CURRent[:DC] Voltage: VOLTage[:DC]
<state>	Enable math operation: ON or 1 Disable math operation: OFF or 0
<channel>	The channel number (default value is CH1): <ul style="list-style-type: none"> Channel 1: CH1 Channel 2: CH2

Details

When this command is set to on, the math operation specified by the math format command is performed before completing a measurement.

Example

:CALC:VOLT:FORM MXB	Set the math function for voltage measurements to $mx + b$.
:CALC:VOLT:KMAT:MMF 0.80	Set the scale factor for voltage measurements to 0.80.
:CALC:VOLT:KMAT:MBF 50	Set the offset factor to 50.
:CALC:VOLT:KMAT:MUN 'C'	Set unit to 'C'
:CALC:VOLT:STATE ON	Enable the math function.

Also see

- [:CALCulate\[1\]:<function>:FORMat](#) (on page 7-21)
- [:CALCulate\[1\]:<function>:KMATH:MBFactor](#) (on page 7-22)
- [:CALCulate\[1\]:<function>:KMATH:MMFactor](#) (on page 7-23)
- [:CALCulate\[1\]:<function>:KMATH:MUNits](#) (on page 7-25)

:CALCulate2:DATA?

This command reads the results of specified statistics.

Type	Affected by	Where saved	Default value
Query only	Not applicable	Not applicable	Not applicable

Usage

```
:CALCulate2:DATA?
:CALCulate2:DATA? <channel>
```

<code><channel></code>	The channel number (default value is CH1): <ul style="list-style-type: none"> ▪ Channel 1: CH1 Channel 2: CH2
------------------------------	---

Details

Return the calculation results of statistics. You can get the results in the following order:

- Minimum (MINimum)
- Maximum (MAXimum)
- Mean (MEAN)
- Standard deviation (SDEViation)
- Peak to peak (PKPK)

NOTE

If the specified statistics have not been performed yet, the instrument will return $-1.000000E+37$.

If the buffer is empty, the instrument returns $-1.000000E+37$.

If there are a lot of readings stored in the buffer, some statistic operations may take too long and cause a buffer time-out error. To avoid this, send the `CALC2:DATA?` command and then wait for the message available (MAV) bit in the Status Byte Register to set before addressing the Series 2280 to talk.

Example

<pre>*RST :TRAC:CLE :TRIG:COUN 10 :VOLT 6 :OUTP ON :INIT *OPC? :CALC2:STATE ON :CALC2:FUNC VOLT :CALC2:FORM:ELEM "READ,UNIT,TST,RNUM" :CALC2:FORM MIN,MAX :CALC2:IMM? :CALC2:FORM MIN,MAX,MEAN,PKPK,SDEV :CALC2:IMM? :CALC2:FORM MAX,SDEV :CALC2:DATA?</pre>	<p>Before the calculation, start the trigger model to take 10 readings.</p> <p>The first <code>CALC2:IMM?</code> returns reading, units, timestamp and reading number for MIN and MAX: 5.986128E+00V,06/25/2013 09:39:31.4455,0008RNDG#,5.987489E+00V,06/25/2013 09:39:30.7283,0001RNDG#</p> <p>The second <code>CALC2:IMM?</code> only returns reading and units for MIN, MAX, MEAN, PKPK and SDEV: 5.986128E+00V,5.987489E+00V,5.986298E+00V,1.360893E-03V,4.204334E-04V</p> <p><code>CALC2:DATA?</code> returns reading and units for MAX and SDEV: 5.987489E+00V,4.204334E-04V</p>
--	--

Also see

- [:CALCulate2:FORMat](#) (on page 7-28)
- [:CALCulate2:IMMediate](#) (on page 7-32)

:CALCulate2:FORMat

This command selects or queries which math statistics are used on readings stored in the buffer.

Type	Affected by	Where saved	Default value
Command and query	Recall settings Instrument reset Power cycle	Save settings	MIN, MAX, MEAN, PKPK, SDEV

Usage

```
:CALCulate2:FORMat <itemList>[,<channel>]
:CALCulate2:FORMat? [<channel>]
```

<code><itemList></code>	<p>The available math statistics:</p> <ul style="list-style-type: none"> ▪ Minimum value: MINimum ▪ Maximum value: MAXimum ▪ Average: MEAN ▪ Standard deviation: SDEViation ▪ Peak to peak: PKPK ▪ None of the statistic operations are selected: NONE
<code><channel></code>	<p>The channel number (default value is CH1):</p> <ul style="list-style-type: none"> ▪ Channel 1: CH1 <p>Channel 2: CH2</p>

Details

Use this command to select one or more available math formats. To use more than one format, separate each format with a comma (,).

NOTE

You can specify the statistic formats in any order. However, when more than one statistic formats are selected, `CALC2:IMM?` and `CALC2:DATA?` always return the data in the following order: MIN, MAX, MEAN, PKPK, and SDEV.

Example

```
*RST
:TRAC:CLE
:TRIG:COUN 10
:VOLT 6
:OUTP ON
:INIT
*OPC?
:CALC2:STATE ON
:CALC2:FUNC VOLT
:CALC2:FORM:ELEM "READ,UNIT,TST,RNUM"
:CALC2:FORM MIN,MAX
:CALC2:IMM?
:CALC2:FORM MIN,MAX,MEAN,PKPK,SDEV
:CALC2:IMM?
:CALC2:FORM MAX,SDEV
:CALC2:DATA?
```

Before the calculation, start the trigger model to take 10 readings.

The first `CALC2:IMM?` returns reading, units, timestamp and reading number for MIN and MAX:

```
5.986128E+00V,06/25/2013
```

```
09:39:31.4455,0008RNDG#,5.987489E+00V,06/25/2013
```

```
09:39:30.7283,0001RNDG#
```

The second `CALC2:IMM?` only returns reading and units for MIN, MAX, MEAN, PKPK and SDEV:

```
5.986128E+00V,5.987489E+00V,5.986298E+00V,1.360
893E-03V,4.204334E-04V
```

`CALC2:DATA?` returns reading and units for MAX and SDEV: `5.987489E+00V,4.204334E-04V`

Also see

[:CALCulate2:FORMat:ELEMents](#) (on page 7-30)

[:CALCulate2:IMMEDIATE](#) (on page 7-32)

[:CALCulate2:STATe](#) (on page 7-34)

:CALCulate2:FORMat:ELEMents

This command specifies or queries data elements to be included in the data string. It only influences minimum and maximum query results.

Type	Affected by	Where saved	Default value
Command and query	Recall settings Instrument reset Power cycle	Save settings	READ, UNIT

Usage

```
:CALCulate2:FORMat:ELEMents <itemList>
:CALCulate2:FORMat:ELEMents <itemList>,<channel>
:CALCulate2:FORMat:ELEMents?
:CALCulate2:FORMat:ELEMents? <channel>
```

<itemList>	<p>The available data elements:</p> <ul style="list-style-type: none"> ▪ Voltage and current reading: READing ▪ Reading units: UNIT ▪ Reading number: RNUMBER ▪ Timestamp: TSTamp. For example, output might be: 07/01/2013 19:21:36.2553
<channel>	<p>The channel number (default value is CH1):</p> <ul style="list-style-type: none"> ▪ Channel 1: CH1 <p>Channel 2: CH2</p>

Details

This command affects the output of the following commands:

- :CALCulate2:IMMEDIATE?
- :CALCulate2:DATA?

You can specify one or more elements. <itemList> is a string that must be enclosed in single or double quotes. Each element in the list must be separated by a comma (,).

Example

<pre>*RST :TRAC:CLE :TRIG:COUN 10 :VOLT 6 :OUTP ON :INIT *OPC? :CALC2:STATE ON :CALC2:FUNC VOLT :CALC2:FORM:ELEM "READ,UNIT,TST,RNUM" :CALC2:FORM MIN,MAX :CALC2:IMM? :CALC2:FORM MIN,MAX,MEAN,PKPK,SDEV :CALC2:IMM? :CALC2:FORM MAX,SDEV :CALC2:DATA?</pre>	<p>Before the calculation, start the trigger model to take 10 readings.</p> <p>The first <code>CALC2:IMM?</code> returns reading, units, timestamp and reading number for MIN and MAX: 5.986128E+00V,06/25/2013 09:39:31.4455,0008RNDG#,5.987489E+00V,06/25/2013 09:39:30.7283,0001RNDG#</p> <p>The second <code>CALC2:IMM?</code> only returns reading and units for MIN, MAX, MEAN, PKPK and SDEV: 5.986128E+00V,5.987489E+00V,5.986298E+00V,1.360893E-03V,4.204334E-04V</p> <p><code>CALC2:DATA?</code> returns reading and units for MAX and SDEV: 5.987489E+00V,4.204334E-04V</p>
--	--

Also see

- [:CALCulate2:FORMat](#) (on page 7-28)
- [:CALCulate2:IMMediate](#) (on page 7-32)
- [:CALCulate2:STATe](#) (on page 7-34)

:CALCulate2:FUNCTION

This command specifies which buffer data to use with statistic operations.

Type	Affected by	Where saved	Default value
Command and query	Power cycle Instrument reset Recall settings	Not applicable	CURR

Usage

```
:CALCulate2:FUNCTION <function>
:CALCulate2:FUNCTION <function>,<channel>
:CALCulate2:FUNCTION?
:CALCulate2:FUNCTION? <channel>
```

<function>	<ul style="list-style-type: none"> ■ CURRent: Apply statistic operations to current data only. ■ VOLTage: Apply statistic operations to voltage data only.
<channel>	<p>The channel number (default value is CH1):</p> <ul style="list-style-type: none"> ■ Channel 1: CH1 ■ Channel 2: CH2

Details

This command allows you to select specific data in the buffer to use with statistic operations. For example, if you select `CURRent`, the statistic operations only apply to current values. Sending the `:CALCulate2:IMMediate?` command only returns the statistic result of current value.

Example

<pre>*RST :TRAC:CLE :TRIG:COUN 10 :VOLT 6 :OUTP ON :INIT *OPC? :CALC2:STATE ON :CALC2:FUNC VOLT :CALC2:FORM:ELEM "READ,UNIT,TST,RNUM" :CALC2:FORM MIN,MAX :CALC2:IMM? :CALC2:FORM MIN,MAX,MEAN,PKPK,SDEV :CALC2:IMM? :CALC2:FORM MAX,SDEV :CALC2:DATA?</pre>	<p>Before the calculation, start the trigger model to take 10 readings.</p> <p>The first <code>CALC2:IMM?</code> returns reading, units, timestamp and reading number for MIN and MAX: 5.986128E+00V,06/25/2013 09:39:31.4455,0008RNDG#,5.987489E+00V,06/25/2013 09:39:30.7283,0001RNDG#</p> <p>The second <code>CALC2:IMM?</code> only returns reading and units for MIN, MAX, MEAN, PKPK and SDEV: 5.986128E+00V,5.987489E+00V,5.986298E+00V,1.360893E-03V,4.204334E-04V</p> <p><code>CALC2:DATA?</code> returns reading and units for MAX and SDEV: 5.987489E+00V,4.204334E-04V</p>
--	--

Also see

- [:CALCulate2:FORMat](#) (on page 7-28)
- [:CALCulate2:IMMediate](#) (on page 7-32)
- [:CALCulate2:STATe](#) (on page 7-34)

:CALCulate2:IMMediate

This command performs the selected statistic operation and reads the results.

Type	Affected by	Where saved	Default value
Command and query	Not applicable	Not applicable	Not applicable

Usage

```
:CALCulate2:IMMediate
:CALCulate2:IMMediate <channel>
:CALCulate2:IMMediate?
:CALCulate2:IMMediate? <channel>
```

<code><channel></code>	<p>The channel number (default value is CH1):</p> <ul style="list-style-type: none"> ■ Channel 1: CH1 Channel 2: CH2
------------------------------	--

Details

This command only performs the selected statistic operations when the operations are enabled. It returns the data in the following order: MIN, MAX, MEAN, PKPK, SDEV.

To query the operation state, send the command:

```
:CALCulate2:STATe?
```

NOTE

When the statistics operations are disabled, sending this command will not perform the statistic operations. However, it will return the last calculation results. If the specified statistics calculations have never been performed, the instrument returns $-1.000000E+37$.

If the buffer is empty, the instrument returns $-1.000000E+37$.

If you send the query command: `:CALCulate2:IMMEDIATE?`, the instrument performs the following two actions:

- Finishes the selected statistic operation.
- Reads the calculation results.

Example

<pre>*RST :TRAC:CLE :TRIG:COUN 10 :VOLT 6 :OUTP ON :INIT *OPC? :CALC2:STATE ON :CALC2:FUNC VOLT :CALC2:FORM:ELEM "READ,UNIT,TST,RNUM" :CALC2:FORM MIN,MAX :CALC2:IMM? :CALC2:FORM MIN,MAX,MEAN,PKPK,SDEV :CALC2:IMM? :CALC2:FORM MAX,SDEV :CALC2:DATA?</pre>	<p>Before the calculation, start the trigger model to take 10 readings.</p> <p>The first <code>CALC2:IMM?</code> returns reading, units, timestamp and reading number for MIN and MAX: <code>5.986128E+00V,06/25/2013</code> <code>09:39:31.4455,0008RNDG#,5.987489E+00V,06/25/2013</code> <code>09:39:30.7283,0001RNDG#</code></p> <p>The second <code>CALC2:IMM?</code> only returns reading and units for MIN, MAX, MEAN, PKPK and SDEV: <code>5.986128E+00V,5.987489E+00V,5.986298E+00V,1.360</code> <code>893E-03V,4.204334E-04V</code></p> <p><code>CALC2:DATA?</code> returns reading and units for MAX and SDEV: <code>5.987489E+00V,4.204334E-04V</code></p>
--	--

Also see

[:CALCulate2:FORMat](#) (on page 7-28)

[:CALCulate2:FORMat:ELEMents](#) (on page 7-30)

[:CALCulate2:STATe](#) (on page 7-34)

:CALCulate2:STATE

This command enables or disables the statistic calculations.

Type	Affected by	Where saved	Default value
Command and query	Recall settings Instrument reset Power cycle	Save settings	0 (OFF)

Usage

```
:CALCulate2:STATE <state>
:CALCulate2:STATE <state>,<channel>
:CALCulate2:STATE?
:CALCulate2:STATE? <channel>
```

<state>	Enable statistic calculations: ON or 1 Disable statistic calculations: OFF or 0
<channel>	The channel number (default value is CH1): <ul style="list-style-type: none"> ▪ Channel 1: CH1 Channel 2: CH2

Example

<pre>*RST :TRAC:CLE :TRIG:COUN 10 :VOLT 6 :OUTP ON :INIT *OPC? :CALC2:STATE ON :CALC2:FUNC VOLT :CALC2:FORM:ELEM "READ,UNIT,TST,RNUM" :CALC2:FORM MIN,MAX :CALC2:IMM? :CALC2:FORM MIN,MAX,MEAN,PKPK,SDEV :CALC2:IMM? :CALC2:FORM MAX,SDEV :CALC2:DATA?</pre>	<p>Before the calculation, start the trigger model to take 10 readings.</p> <p>The first CALC2:IMM? returns reading, units, timestamp and reading number for MIN and MAX: 5.986128E+00V,06/25/2013 09:39:31.4455,0008RNDG#,5.987489E+00V,06/25/2013 09:39:30.7283,0001RNDG#</p> <p>The second CALC2:IMM? only returns reading and units for MIN, MAX, MEAN, PKPK and SDEV: 5.986128E+00V,5.987489E+00V,5.986298E+00V,1.360893E-03V,4.204334E-04V</p> <p>CALC2:DATA? returns reading and units for MAX and SDEV: 5.987489E+00V,4.204334E-04V</p>
--	---

Also see

- [:CALCulate2:FORMat](#) (on page 7-28)
- [:CALCulate2:FORMat:ELEMents](#) (on page 7-30)
- [:CALCulate2:IMMEDIATE](#) (on page 7-32)

CALibration subsystem

The commands in this subsystem configure and control the calibration operations.

:CALibration:PROTeCted:CANCel

This command cancels the calibration procedures and drops the new constants.

Type	Affected by	Where saved	Default value
Command only	Not applicable	Not applicable	Not applicable

Usage

```
:CALibration:PROTeCted:CANCel
```

Details

When this command is sent, the instrument cancels the calibration and loses the new calibration constants.

Example

```
:CAL:PROT:CANC
```

Cancels the calibration procedure and reverts the constants.

Also see

None

:CALibration:PROTECTED:CODE

This command changes the calibration password.

Type	Affected by	Where saved	Default value
Command only	Recall settings	Nonvolatile memory	'K1002280'

Usage

```
:CALibration:PROTECTED:CODE <string>
```

```
<string>
```

Calibration password: An 8-character string including letters and numbers.

Details

Before changing the password, you must first enable calibration mode by using the following command:

```
:CAL:PROT:STAT ON,<password>
```

Example

```
:CAL:PROT:CODE '12345678'
```

Change the calibration password to "12345678".

Also see

[:CALibration:PROTECTED:STATe](#) (on page 7-44)

:CALibration:PROTECTED:COUNT?

This query command returns the number of times that the instrument has completed calibration.

Type	Affected by	Where saved	Default value
Query only	Not applicable	Nonvolatile memory	Not applicable

Usage

```
:CALibration:PROTECTED:COUNT?
```

Details

Returns the number of times that the instrument has completed calibration. The calibration count will increase after saving the calibration constants.

Example

```
:CAL:PROT:COUN?
```

Return the number of times the calibration was completed.

Also see

None

:CALibration:PROTeCted:DATA?

This command queries the saved calibration constants.

Type	Affected by	Where saved	Default value
Query only	Not applicable	Nonvolatile memory	Not applicable

Usage

```
:CALibration:PROTeCted:DATA?
```

Details

For details, refer to [Calibration constants](#) (on page C-25).

Example

:CAL:PROT:DATA?	Return the calibration constants in order: +4.989000E-02,+4.997200E+00,+9.091379E-01,+6.047600E-01,+1.306331E-02,+5.688220E+01,+1.230724E+00,+1.521200E-03,+4.262407E-03,+4.687520E-03,+1.500000E-01,+3.965609E-01,+3.980984E-03,+3.517675E-01,+5.200000E-03,+1.376206E-02,+1.458743E-02,+5.031000E-01,+1.332121E+00
-----------------	---

Also see

None

:CALibration:PROTECTED:DATE

This command specifies the calibration date.

Type	Affected by	Where saved	Default value
Command and query	Not applicable	Nonvolatile memory	Not applicable

Usage

```
:CALibration:PROTECTED:DATE <year>,<month>,<day>
```

```
:CALibration:PROTECTED:DATE?
```

<year>	Year; must be more than 1970
<month>	Month: 1 to 12
<day>	Day: 1 to 31

Details

The query command returns the latest calibration date in the following format: <year> <month> <day>

Example

```
:CAL:PROT:DATE 2014, 5, 12
```

Set the calibration date to May 12, 2014.

Also see

None

:CALibration:PROTECTED[:DC[n]]:STEP<step>

This command performs the calibration procedures.

Type	Affected by	Where saved	Default value
Command only	Not applicable	Not applicable	Not applicable

Usage

```
:CALibration:PROTECTED[:DC[n]]:STEP1
:CALibration:PROTECTED[:DC[n]]:STEP2
:CALibration:PROTECTED[:DC[n]]:STEP3
:CALibration:PROTECTED[:DC[n]]:STEP4
:CALibration:PROTECTED[:DC[n]]:STEP5
:CALibration:PROTECTED[:DC[n]]:STEP6
:CALibration:PROTECTED[:DC[n]]:STEP7
:CALibration:PROTECTED[:DC[n]]:STEP8
```

[n]	Channel number: For single-channel instruments, the value is 1
<step>	<p>The following steps represent the entire calibration process:</p> <ul style="list-style-type: none"> ▪ Step1: V-ADC and V-DAC zero-point calibration. ▪ Step2: V-ADC and V-DAC full-scale calibration. ▪ Step3: I-100 mA and I-10 mA ADC zero-point calibration. ▪ Step4: I-100 mA and I-10 mA ADC full-scale calibration. ▪ Step5: I-10 A and I-1 A ADC zero-point calibration. ▪ Step6: I-DAC zero-point calibration. ▪ Step7: I-10 A and I-1 A ADC full-scale calibration. <p>Step8: I-DAC full-scale calibration.</p>

Details

This command is used to start each calibration step. Users should follow the calibration procedure. See Example.

Example

:CAL:PROT:STAT ON, 'KI002280'	Enable the calibration mode.
:CAL:PROT:STEP1	Start voltage DAC and ADC zero-calibration point.
:CAL:PROT:STEP1:DATA 0.2996	Enter the voltage reading from the external DMM.
*OPC?	Wait until step 1 finishes. When finished, this command returns 1.
:CAL:PROT:STEP2	Start voltage DAC and ADC full-scale calibration.
:CAL:PROT:STEP2:DATA 29.945	Enter the voltage reading from external DMM.
*OPC?	Wait until step 2 finishes. When finished, this command returns 1.
:CAL:PROT:STEP3	Start current ADC zero-point calibration on the 100 mA range.
:CAL:PROT:STEP3:DATA 0.00505, 5.05	Enter the voltage and resistance readings from the external DMM.
*OPC?	Wait until step 3 finishes. When finished, this command returns 1.
:CAL:PROT:STEP4	Start current ADC full-scale calibration on the 100 mA range.
:CAL:PROT:STEP4:DATA 0.505, 5.05	Enter the voltage and resistance readings from the external DMM.
*OPC?	Wait until step 4 finishes. When finished, this command returns 1.
:CAL:PROT:STEP5	Start current ADC zero-point calibration on the 10 A range.
:CAL:PROT:STEP5:DATA 0.00298, 0.0496	Enter the voltage and resistance readings from the external DMM.
*OPC?	Wait until step 5 finishes. When finished, this command returns 1.
:CAL:PROT:STEP6	Start current DAC zero-point calibration.
:CAL:PROT:STEP6:DATA	Wait for the instrument to collect data; you do not need to enter any parameters.
*OPC?	Wait until step 6 finishes. When finished, this command returns 1.
:CAL:PROT:STEP7	Start current ADC full-scale calibration on the 10 A range.
:CAL:PROT:STEP7:DATA 0.2996, 0.0496	Enter the voltage and resistance readings from the external DMM.
*OPC?	Wait until step 7 finishes. When finished, this command returns 1.
:CAL:PROT:STEP8	Start current DAC full-scale calibration.
:CAL:PROT:STEP8:DATA	Wait for the instrument to collect data; you do not need to enter any parameters.
*OPC?	Wait until step 8 finishes. When finished, this command returns 1.
CAL:PROT:SAVE	Save calibration constants to nonvolatile memory.
CAL:PROT:STATe OFF, 'KI002280'	Disable the calibration mode.

Also see

[:CALibration:PROTeCted\[:DC\[n\]\]:STEP<step>:DATA](#) (on page 7-41)

[:CALibration:PROTeCted:SAVE](#) (on page 7-43)

[:CALibration:PROTeCted:STATe](#) (on page 7-44)

:CALibration:PROTeCted[:DC[n]]:STEP<step>:DATA

This command enters the values for calibration calculations.

Type	Affected by	Where saved	Default value
Command only	Not applicable	Not applicable	Not applicable

Usage

```
:CALibration:PROTeCted[:DC[n]]:STEP1:DATA <voltage>
:CALibration:PROTeCted[:DC[n]]:STEP2:DATA <voltage>
:CALibration:PROTeCted[:DC[n]]:STEP3:DATA <voltage>,<resistance>
:CALibration:PROTeCted[:DC[n]]:STEP4:DATA <voltage>,<resistance>
:CALibration:PROTeCted[:DC[n]]:STEP5:DATA <voltage>,<resistance>
:CALibration:PROTeCted[:DC[n]]:STEP6:DATA
:CALibration:PROTeCted[:DC[n]]:STEP7:DATA <voltage>,<resistance>
:CALibration:PROTeCted[:DC[n]]:STEP8:DATA
```

[n]	Channel number: For single-channel instruments, the value is 1
<step>	The following steps represent the entire calibration process: <ul style="list-style-type: none"> ▪ Step1: V-ADC and V-DAC zero-point calibration. ▪ Step2: V-ADC and V-DAC full-scale calibration. ▪ Step3: I-100 mA and I-10 mA ADC zero-point calibration. ▪ Step4: I-100 mA and I-10 mA ADC full-scale calibration. ▪ Step5: I-10 A and I-1 A ADC zero-point calibration. ▪ Step6: I-DAC zero-point calibration. ▪ Step7: I-10 A and I-1 A ADC full-scale calibration. ▪ Step8: I-DAC full-scale calibration.
<voltage>	Voltage reading from the external DMM.
<resistance>	The resistance of the resistor load.

Details

This command is used to set the voltage or resistance for calibration.

NOTE

Step 6 and step 8 do not need any external data entry. The instrument can collect the data for DAC calibration.

Example

:CAL:PROT:STAT ON, "KI002280"	Enable the calibration mode.
:CAL:PROT:STEP1	Start voltage DAC and ADC zero-calibration point.
:CAL:PROT:STEP1:DATA 0.2996	Enter the voltage reading from the external DMM.
*OPC?	Wait until step 1 finishes. When finished, this command returns 1.
:CAL:PROT:STEP2	Start voltage DAC and ADC full-scale calibration.
:CAL:PROT:STEP2:DATA 29.945	Enter the voltage reading from external DMM.
*OPC?	Wait until step 2 finishes. When finished, this command returns 1.
:CAL:PROT:STEP3	Start current ADC zero-point calibration on the 100 mA range.
:CAL:PROT:STEP3:DATA 0.00505, 5.05	Enter the voltage and resistance readings from the external DMM.
*OPC?	Wait until step 3 finishes. When finished, this command returns 1.
:CAL:PROT:STEP4	Start current ADC full-scale calibration on the 100 mA range.
:CAL:PROT:STEP4:DATA 0.505, 5.05	Enter the voltage and resistance readings from the external DMM.
*OPC?	Wait until step 4 finishes. When finished, this command returns 1.
:CAL:PROT:STEP5	Start current ADC zero-point calibration on the 10 A range.
:CAL:PROT:STEP5:DATA 0.00298, 0.0496	Enter the voltage and resistance readings from the external DMM.
*OPC?	Wait until step 5 finishes. When finished, this command returns 1.
:CAL:PROT:STEP6	Start current DAC zero-point calibration.
:CAL:PROT:STEP6:DATA	Wait for the instrument to collect data; you do not need to enter any parameters.
*OPC?	Wait until step 6 finishes. When finished, this command returns 1.
:CAL:PROT:STEP7	Start current ADC full-scale calibration on the 10 A range.
:CAL:PROT:STEP7:DATA 0.2996, 0.0496	Enter the voltage and resistance readings from the external DMM.
*OPC?	Wait until step 7 finishes. When finished, this command returns 1.
:CAL:PROT:STEP8	Start current DAC full-scale calibration.
:CAL:PROT:STEP8:DATA	Wait for the instrument to collect data; you do not need to enter any parameters.
*OPC?	Wait until step 8 finishes. When finished, this command returns 1.
CAL:PROT:SAVE	Save calibration constants to nonvolatile memory.
CAL:PROT:STATe OFF, "KI002280"	Disable the calibration mode.

Also see

[:CALibration:PROTeCted\[:DC\[n\]\]:STEP<step>](#) (on page 7-39)

[:CALibration:PROTeCted:SAVE](#) (on page 7-43)

[:CALibration:PROTeCted:STATe](#) (on page 7-44)

:CALibration:PROTECTED:SAVE

This command saves the calibration to nonvolatile memory after the calibration procedure has been completed.

Type	Affected by	Where saved	Default value
Command only	Not applicable	Nonvolatile memory	Not applicable

Usage

```
:CALibration:PROTECTED:SAVE
```

Details

If the instrument exits the calibration mode by the following command without first saving the new constants, the previous constants are restored.

```
:CALibration:STATE OFF
```

Example

```
:CAL:PROT:SAVE
```

Save calibration constants to memory.

Also see

None

:CALibration:PROTECTED:STATE

This command enables or disables calibration procedures when performing these procedures over the remote interface.

Type	Affected by	Where saved	Default value
Command and query	Instrument reset Power cycle	Not saved	0 (OFF)

Usage

```
:CALibration:PROTECTED:STATE <state>, <password>
:CALibration:PROTECTED:STATE?
```

<state>	Enable the calibration mode: ON or 1 Disable the calibration mode: OFF or 0
<password>	The password for calibration: <ul style="list-style-type: none"> ▪ The maximum length is 8 characters ▪ Not case sensitive

Details

Use this command to enable the calibration mode. After enabled, you can configure and control calibration operations. If the calibration mode is disabled, the commands related to calibration are ignored.

When using this command, you are required to provide the calibration password. You could set a new password by the command:

```
:CALibration:PROTECTED:CODE
```

NOTE

During the calibration process, changing the calibration mode from 1 (ON) to 0 (OFF) could cause the instrument to lose the calibration data if you have not saved them with the :CALibration:PROTECTED:SAVE command.

Example

```
:CAL:PROT:STAT ON, 'KI002280'
```

Enable the calibration procedures.

Also see

None

Digital subsystem

The commands in the DIGital subsystem control the digital I/O lines.

:DIGital:LINE<n>:FUNCTion

This command sets the digital I/O pin to be a digital line and sets the pin to be input or output.

Type	Affected by	Where saved	Default value
Command and query	Recall settings Instrument reset Power cycle	Save settings	Line 1: AUTO Line 2: AUTO Line 3: AUTO Line 4: MINP Line 5: MINP Line 6: MINP

Usage

```
:DIGital:LINE<n>:FUNCTion <function>
:DIGital:LINE<n>:FUNCTion?
```

[n]	The digital I/O line: 1 to 6.
<function>	The pin state; see Details for values.

Details

Set <function> to one of the values shown in the following table.

Value	Description
AUTO	Automatically specify the pin state. This function only applies to line 1 to 3. <ul style="list-style-type: none"> Line 1: Trigger in. Detects falling-edge, rising-edge, or both edge triggers as input. Line 2: Meter complete output pulse. Outputs a 10 μs TTL-compatible pulse after the settling time of each measurement. Line 3: Protection output pulse. Outputs a 10 μs TTL-compatible pulse when OXP (OVP/OCP/OTP) or sense leads are reversed.
MOUTH	Outputs a high TTL-compatible pulse to the specified line
MOUTL	Outputs a low TTL-compatible pulse to the specified line
MINPut	Configures the specified line as an input

Example

```
:DIG:LINE1:FUNC MINPut      Set digital I/O line 1 as a digital input pin.
```

Also see

[Digital I/O](#) (on page 3-19)

:DIGital:LINE<n>:MANual:INPut:DATA?

This command reads the data from manual input to the digital I/O pin.

Type	Affected by	Where saved	Default value
Query only	Not applicable	Not applicable	Not applicable

Usage

```
:DIGital:LINE<n>:MANual:INPut:DATA?
```

[n]	The digital I/O line: 1 to 6.
-----	-------------------------------

Details

This command queries the manual input digital I/O line. If the line is not assigned to manual input, querying the pin gets no return and the instrument generates an error 508, "Querying manual input data of the line which is not set as Manual Input line."

Example

```
:DIG:LINE1:MAN:INP:DATA?
```

Query the data from manual input to the digital I/O pin.
Example output: 1.

Also see

[Digital I/O](#) (on page 3-19)

DISPlay subsystem

This subsystem contains commands that control the front-panel display.

:DISPlay:BRIGhtness

This command sets and queries the brightness of the front-panel display.

Type	Affected by	Where saved	Default value
Command and query	Not applicable	Nonvolatile memory	ON50

Usage

```
:DISPlay:BRIGhtness <brightness>
:DISPlay:BRIGhtness?
:DISPlay:BRIGhtness? DEFault
:DISPlay:BRIGhtness? MINimum
:DISPlay:BRIGhtness? MAXimum
```

<brightness>	The brightness of the display: 5 to 100%.
--------------	---

Details

This command determines the brightness of the front-panel display.

NOTE

Screen life is affected by how long the screen is on at full brightness. The higher the brightness setting and the longer the screen is bright, the shorter the screen life.

Example

:DISP:BRIG 50	Set the display brightness to 50%
---------------	-----------------------------------

Also see

None

:DISPlay:CLEar

This command removes user-defined text messages from the OUTPUT view screen.

Type	Affected by	Where saved	Default value
Command only	Not applicable	Not applicable	Not applicable

Usage

```
:DISPlay:CLEar [<channel>]
```

<code><channel></code>	The channel number (default value is CH1): <ul style="list-style-type: none"> ▪ Channel 1: CH1 ▪ Channel 2: CH2
------------------------------	---

Details

This command clears the user-defined text message from the setting area of the screen. The instrument returns to the normal mode.

Example

<code>:DISP:CLE</code>	Clear the user-defined text message.
------------------------	--------------------------------------

Also see

[:DISPlay:USER:TEXT:DATA](#) (on page 7-49)

:DISPlay:SCREen

This command specifies which screen is displayed on the front-panel.

Type	Affected by	Where saved	Default value
Command only	Power cycle	Not applicable	Not applicable

Usage

```
:DISPlay:SCREen <screenName>
```

<code><screenName></code>	The screen is displayed: <ul style="list-style-type: none"> ▪ Home screen: HOME ▪ Graph screen: GRAPh ▪ Data Sheet screen: DATAsheet
---------------------------------	---

Details

This command allows you to change the screen shown on the display.

Example

<code>:DISP:SCRE DAT</code>	Display the Data Sheet screen.
-----------------------------	--------------------------------

Also see

None

:DISPlay:USER:TEXT[:DATA]

This command defines the text that is displayed on the front-panel OUTPUT view screen.

Type	Affected by	Where saved	Default value
Command only	Power cycle	Not applicable	Not applicable

Usage

```
:DISPlay:USER:TEXT[:DATA] <string>[,<channel>]
```

<string>	String that contains the message; up to 24 characters
<channel>	The channel number (default value is CH1): <ul style="list-style-type: none"> ▪ Channel 1: CH1 Channel 2: CH2

Details

These commands define text messages for the OUTPUT view screen.

If you enter too many characters, the instrument displays an error, -223, "too much data."

When you send this command, text must be enclosed in either single quotes (' '), or double quotes ("").

NOTE

A user-defined text message remains displayed only when the instrument is in remote operation. Taking the instrument out of remote operation cancels the message.

Example

```
:DISP:USER:TEXT "Test running"
```

Display the text, `Test running` in the setting area of the screen.

Also see

None

INITiate subsystem

The commands in the INITiate subsystem control the trigger model.

:INITiate[n]:CONTinuous

This command enables and disables continuous triggering.

Type	Affected by	Where saved	Default value
Command and query	Recall settings Instrument reset Power cycle	Save settings	0 (OFF)

Usage

```
:INITiate[n]:CONTinuous <state>
:INITiate[n]:CONTinuous?
```

[n]	Channel number: For single-channel instruments, the value is 1
<state>	Disable continuous triggering: OFF or 0 Enable continuous triggering: ON or 1

Details

With continuous initiation enabled, sending :INITiate causes error -213, "init ignored."

Example

ARM:SOUR IMM	Select IMMEDIATE arm source.
TRIG:SOUR IMM	Select IMMEDIATE trigger source.
INIT:CONT OFF	Disable continuous initiation.
ABORT	Abort operation. Places the instrument in idle.
ARM:COUN 1	Set arm count to 1.
TRIG:COUN 1	Set trigger count to 1.
TRIG:SAMP:COUN 100	Set Measure count to 100.
:OUTP ON	Turn on the output.
INIT	Start measurement process.

Also see

[Trigger model](#) (on page 3-25)

:INITiate[n][:IMMediate]

This command starts the trigger model.

Type	Affected by	Where saved	Default value
Command only	Not applicable	Not applicable	Not applicable

Usage

```
:INITiate [n] [:IMMediate]
```

[n]	Channel number: For single-channel instruments, the value is 1
-----	--

Also see

[Trigger model](#) (on page 3-25)

MMEMemory subsystem

The commands in the MMEMemory subsystem save or recall the setups to the external USB flash drive.

:MMEMemory:LOAD:SETup

This command recalls the specified setup from the external USB flash drive to the instrument.

Type	Affected by	Where saved	Default value
Command only	Not applicable	Not applicable	Not applicable

Usage

```
:MMEMemory:LOAD:SETup <fileName>
```

<fileName>	A string that contains a name for the imported setup (maximum 8 characters)
------------	---

Detail

This command allows you to recall the specified setup in the external USB flash drive to the instrument.

NOTE

Make sure that the external USB flash drive is connected to the instrument before you send this command. An unstable connection between the USB flash drive and the instrument will cause an error 520: "No USB flash drive found."

Example

```
:MMEMory:LOAD:SETup "mysetup"
```

Recall the setup named `mysetup` in the external USB flash drive to the instrument.

Also see

[:MMEMory:SAVE:SETup](#) (on page 7-53)

[*RCL](#) (on page 7-6)

[*SAV](#) (on page 7-7)

:MMEMory:SAVE:SETup

This command exports the present setup to the external USB flash drive.

Type	Affected by	Where saved	Default value
Command only	Not applicable	Not applicable	Not applicable

Usage

```
:MMEMory:SAVE:SETup <fileName>
```

<fileName>

A string that contains a name for the saved setup (maximum 8 characters)

Detail

This command allows you to save the present instrument setup to the external USB flash drive.

NOTE

Make sure that the external USB flash drive is connected to the instrument before you send this command. An unstable connection between the USB flash drive and the instrument will cause an error 520, "No USB flash drive found."

Example

```
:MMEMory:SAVE:SETup "mysetup"
```

Save the present setup to the external USB flash drive as `mysetup`.

Also see

[:MMEMory:LOAD:SETup](#) (on page 7-52)

[*RCL](#) (on page 7-6)

[*SAV](#) (on page 7-7)

OUTPut subsystem

The output subsystem provides information and settings that control the source output.

:OUTPut:DELAy:FALLing

This command specifies a delay that the instrument waits before turning off the specified output.

Type	Affected by	Where saved	Default value
Command and query	Recall settings Instrument reset Power cycle	Save settings	0 s

Usage

```
:OUTPut:DELAy:FALLing <n>
:OUTPut:DELAy:FALLing <n>,<channel>
:OUTPut:DELAy:FALLing?
:OUTPut:DELAy:FALLing? <channel>
:OUTPut:DELAy:FALLing? DEFault
:OUTPut:DELAy:FALLing? DEFault,<channel>
:OUTPut:DELAy:FALLing? MINimum
:OUTPut:DELAy:FALLing? MINimum,<channel>
:OUTPut:DELAy:FALLing? MAXimum
:OUTPut:DELAy:FALLing? MAXimum,<channel>
```

[n]	Delay rising time: 0 to 10 s with the resolution of 0.001 s.
<channel>	The channel number (default value is CH1): <ul style="list-style-type: none"> ■ Channel 1: CH1 Channel 2: CH2

Details

This command sets the falling delay so that output will not turn off until the delay has elapsed. This command affects on-to-off transitions, including the operation:

```
:OUTPut:STATe ON
```

Example

:OUTP:DELAy:FALLing 1	Set the falling delay time to 1 s.
-----------------------	------------------------------------

Also see

[:OUTPut:DELAy:RISing](#) (on page 7-55)

[:OUTPut\[:STATe\]](#) (on page 7-59)

:OUTPut:DElAy:RISing

This command specifies the delay time that the instrument waits before turning on the specified output.

Type	Affected by	Where saved	Default value
Command and query	Recall settings Instrument reset Power cycle	Save settings	0

Usage

```
:OUTPut:DElAy:RISing <n>
:OUTPut:DElAy:RISing <n>, <channel>
:OUTPut:DElAy:RISing?
:OUTPut:DElAy:RISing? <channel>
:OUTPut:DElAy:RISing? DEFault
:OUTPut:DElAy:RISing? DEFault, <channel>
:OUTPut:DElAy:RISing? MINimum
:OUTPut:DElAy:RISing? MINimum, <channel>
:OUTPut:DElAy:RISing? MAXimum
:OUTPut:DElAy:RISing? MAXimum, <channel>
```

[n]	Delay rising time: 0 to 10 s with the resolution of 0.001 s.
<channel>	The channel number (default value is CH1): <ul style="list-style-type: none"> ▪ Channel 1: CH1 Channel 2: CH2

Details

This command sets the rising delay so that output will not turn on until the delay has elapsed. This command affects off-to-on transitions, including the operation:

```
:OUTPut:STATe ON
```

Example

:OUTPut:DElAy:RIS 1	Set the rising delay time to 1 s.
---------------------	-----------------------------------

Also see

[:OUTPut:DElAy:FALLing](#) (on page 7-54)

[:OUTPut\[:STATe\]](#) (on page 7-59)

:OUTPut:DELAy:STATe

This command enables and disables the delay time that the instrument waits before enabling and disabling the specified output.

Type	Affected by	Where saved	Default value
Command and query	Recall settings Instrument reset Power cycle	Save settings	0 (OFF)

Usage

```
:OUTPut:DELAy:STATe <state>
:OUTPut:DELAy:STATe?
```

<state>	Disable output delay: OFF or 0 Enable output delay: ON or 1
---------	--

Details

When output delay is set to ON, the instrument waits the specified delay time before turning on and off the output. For details, refer to [Output delay](#) (on page 3-6).

Separate delays can be programmed for the off-to-on and the on-to-off transition using the following commands:

- :OUTPut:DELAy:RISing
- :OUTPut:DELAy:FALLing

Example

```
:OUTP:DEL:STAT ON Enable the output delay
```

Also see

- [:OUTPut:DELAy:FALLing](#) (on page 7-54)
- [:OUTPut:DELAy:RISing](#) (on page 7-55)

:OUTPut:PROTection:CLEar

This command clears the overvoltage, overcurrent, overtemperature, or reverse fault status.

Type	Affected by	Where saved	Default value
Command only	Not applicable	Not applicable	Not applicable

Usage

```
:OUTPut:PROTection:CLEar
:OUTPut:PROTection:CLEar <channel>
```

<code><channel></code>	The channel number (default value is CH1): <ul style="list-style-type: none"> ▪ Channel 1: CH1 Channel 2: CH2
------------------------------	---

Details

Clears the protection status if an overvoltage, overcurrent, or overtemperature protection condition occurred or a reverse sense fault was detected. For all four faults, this command also clears the related Questionable Instrument Summary Condition Register bit.

Example

```
:OUTPut:PROTection:CLEar
```

Clear the protection status.

Also see

- [:OUTPut:PROTection:TRIPped?](#) (on page 7-58)
- [Status model](#) (on page D-1)

:OUTPut:PROTection:TRIPped? [<channel>]

This command queries whether overvoltage, overcurrent, overtemperature, or reverse fault protection has been tripped.

Type	Affected by	Where saved	Default value
Query only	Not applicable	Not applicable	Not applicable

Usage

```
:OUTPut:PROTection:TRIPped?
```

<code><channel></code>	<p>The channel number (default value is CH1):</p> <ul style="list-style-type: none"> ▪ Channel 1: CH1 ▪ Channel 2: CH2 ▪ Channel 2: CH2 <p>The</p>
------------------------------	---

Details

There are six types of responses, including:

- OCP indicates over-current protection occurred.
- OVP indicates over-voltage protection occurred.
- OTP indicates over-temperature protection occurred.
- RVS indicates reverse sense fault detected.
- OPS indicates open sense error protection occurred.
- NONE indicates nothing occurred.

Example

<pre>:OUTP:PROT:TRIP? CH1</pre>	<p>If the overvoltage protection circuit in channel 1 is tripped, the query returns <code>OVP</code>.</p> <p>If the protection circuit is not tripped, the query returns <code>NONE</code>.</p>
---------------------------------	---

Also see

None

:OUTPut[:STATe]

This command enables or disables the source output.

Type	Affected by	Where saved	Default value
Command and query	Recall settings Instrument reset Power cycle	Save settings	0 (OFF)

Usage

```
:OUTPut[:STATe] <state>
:OUTPut[:STATe] <state>,<channel>
:OUTPut[:STATe]?
```

<state>	Turn source off: OFF or 0 Turn source on: ON or 1 Disable source: DISable or 2
<channel>	The channel number (default value is CH1): <ul style="list-style-type: none"> ▪ Channel 1: CH1 Channel 2: CH2

Details

Measurements cannot be made while the source is off.

Example

```
:OUTP ON
```

Switch the source output of the instrument to ON.

Also see

None

SENSe subsystem

The SENSe subsystem commands configure and control the measurement functions of the Series 2280.

Many of these commands are set for a specific function (concurrent, current, or voltage). For example, you can program a range setting for each function. The settings are saved with that function.

:SENSe[n]:FUNction

This command selects which type of measurement is active: Concurrent, current, or voltage.

Type	Affected by	Where saved	Default value
Command and query	Recall settings Instrument reset Power cycle	Save settings	"CONC"

Usage

```
:SENSe[n]:FUNction <name>
:SENSe[n]:FUNction?
```

[n]	Channel number: For single-channel instruments, the value is 1
<name>	A string that contains the measurement function to make active: <ul style="list-style-type: none"> ▪ Concurrent: "CONCurent[:DC]" ▪ Current: "CURRent[:DC]" ▪ Voltage: "VOLTag[:DC]" For details, see Select a measurement function (on page 2-74).

Details

Set this command to the type of measurement you want to make.

Reading this command returns the measure function that is presently active.

Examples

:SENS:FUNC "VOLT"	Make the voltage measurement function the active function.
-------------------	--

Also see

None

:SENSe[n]:<function>:AVERage:COUNT

This command sets the number of measurements that are averaged when filtering is enabled for the specified function.

Type	Affected by	Where saved	Default value
Command and query	Recall settings Instrument reset Power cycle	Save settings	10

Usage

```
:SENSe[n]:<function>:AVERage:COUNT <value>
:SENSe[n]:<function>:AVERage:COUNT?
:SENSe[n]:<function>:AVERage:COUNT? DEFault
:SENSe[n]:<function>:AVERage:COUNT? MINimum
:SENSe[n]:<function>:AVERage:COUNT? MAXimum
```

[n]	Channel number: For single-channel instruments, the value is 1
<function>	The measurement function to which this setting applies: <ul style="list-style-type: none"> ▪ Concurrent: CONCurrent[:DC] ▪ Current: CURRent[:DC] ▪ Voltage: VOLTage[:DC]
<value>	The number of readings required for each filtered measurement (2 to 100)

Details

The filter count is the number of readings that are acquired and stored in the filter stack for the averaging calculation. When the filter count is larger, more filtering is done and the data is less noisy.

Example

```
SENS:CONC:AVER:WIND 0.1
```

Set the average filter window as 0.1%.

Also see

[:SENSe\[n\]:<function>:AVERage\[:STATe\]](#) (on page 7-62)
[:SENSe\[n\]:<function>:AVERage:TCONtrol](#) (on page 7-63)
[:SENSe\[n\]:<function>:AVERage:WINDow](#) (on page 7-64)

:SENSe[n]:<function>:AVERage[:STATe]

This command enables or disables the averaging filter for measurements of the selected function.

Type	Affected by	Where saved	Default value
Command and query	Recall settings Instrument reset Power cycle	Save settings	1 (ON)

Usage

```
:SENSe[n]:<function>:AVERage[:STATe] <state>
:SENSe[n]:<function>:AVERage[:STATe]?
```

[n]	Channel number: For single-channel instruments, the value is 1
<function>	The measurement function to which this setting applies: <ul style="list-style-type: none"> ▪ Concurrent: CONCurrent[:DC] ▪ Current: CURRent[:DC] ▪ Voltage: VOLTage[:DC]
<state>	The filter status; set to one of the following values: <ul style="list-style-type: none"> ▪ Disable the averaging filter: OFF or 0 ▪ Enable the averaging filter: ON or 1

Details

This command enables or disables the averaging filter. When this is enabled, the reading returned by the instrument is an averaged value, taken from multiple measurements. The settings of the filter count and filter type for the selected measure function determines how the reading is averaged.

Example

```
SENS:CONC:AVER:WIND 0.1
```

Set the average filter window as 0.1%.

Also see

[:SENSe\[n\]:<function>:AVERage:COUNT](#) (on page 7-61)

[:SENSe\[n\]:<function>:AVERage:TCONtrol](#) (on page 7-63)

[:SENSe\[n\]:<function>:AVERage:WINDow](#) (on page 7-64)

:SENSe[n]:<function>:AVERage:TCONtrol

This command sets the type of averaging filter that is used for measurements for the selected function when the measurement filter is enabled.

Type	Affected by	Where saved	Default value
Command and query	Recall settings Instrument reset Power cycle	Save settings	MOV

Usage

```
:SENSe[n]:<function>:AVERage:TCONtrol <type>
:SENSe[n]:<function>:AVERage:TCONtrol?
```

[n]	Channel number: For single-channel instruments, the value is 1
<function>	The measurement function to which this setting applies: <ul style="list-style-type: none"> ▪ Concurrent: CONCurrent[:DC] ▪ Current: CURRent[:DC] ▪ Voltage: VOLTage[:DC]
<type>	The filter type to use when filtering is enabled; set to one of the following values: <ul style="list-style-type: none"> ▪ Moving filter: MOVing

Details

This command selects the type of averaging filter: Moving average.

When the moving average filter is selected, the measurements are added to the stack continuously on a first-in, first-out basis. As each measurement is made, the oldest measurement is removed from the stack. A new averaged sample is produced using the new measurement and the data that is now in the stack.

NOTE

When the moving average filter is first selected, the stack is empty. When the first measurement is made, it is copied into all the stack locations to fill the stack. A true average is not produced until the stack is filled with new measurements. The size of the stack is determined by the filter count setting.

Example

```
SENS:CONC:AVER:WIND 0.1
```

Set the average filter window as 0.1%.

Also see

[:SENSe\[n\]:<function>:AVERage:COUNT](#) (on page 7-61)
[:SENSe\[n\]:<function>:AVERage:STATe](#) (on page 7-62)
[:SENSe\[n\]:<function>:AVERage:WINDow](#) (on page 7-64)

:SENSe[n]:<function>:AVERage:WINDow

This command specifies a filter window to control filter threshold.

Type	Affected by	Where saved	Default value
Command and query	Recall settings Instrument reset Power cycle	Save settings	1

Usage

```
:SENSe[n]:<function>:AVERage:WINDow <value>
:SENSe[n]:<function>:AVERage:WINDow?
:SENSe[n]:<function>:AVERage:WINDow? DEFault
:SENSe[n]:<function>:AVERage:WINDow? MAXimum
:SENSe[n]:<function>:AVERage:WINDow? MINimum
```

[n]	Channel number: For single-channel instruments, the value is 1
<function>	The measurement function to which this setting applies: <ul style="list-style-type: none"> ▪ Concurrent: CONCurrent[:DC] ▪ Current: CURRent[:DC] ▪ Voltage: VOLTage[:DC]
<value>	The filter window: 0.01 to 100. This value is expressed in terms of a percentage. There are five acceptable window percentages: 0.01, 0.1, 1, 10, and 100.

Details

The <value> parameter can be set to any value from 0.01 to 100. The instrument rounds up the value to the nearest window value. For example, the filter window is set to 1 if you send the following command:

```
SENS:CONC:AVER:WIND 0.5
```

Example

```
SENS:CONC:AVER:WIND 0.1
```

Set the average filter window as 0.1%.

Also see

[:SENSe\[n\]:<function>:AVERage:COUNT](#) (on page 7-61)
[:SENSe\[n\]:<function>:AVERage:STATe](#) (on page 7-62)
[:SENSe\[n\]:<function>:AVERage:TCONtrol](#) (on page 7-63)

:SENSe[n]:<function>:DIGits

This command determines the number of digits that are displayed for measurements on the front panel.

Type	Affected by	Where saved	Default value
Command and query	Recall settings Instrument reset Power cycle	Save settings	6

Usage

```
:SENSe[n]:<function>:DIGits <value>
:SENSe[n]:<function>:DIGits?
:SENSe[n]:<function>:DIGits? DEFault
:SENSe[n]:<function>:DIGits? MINimum
:SENSe[n]:<function>:DIGits? MAXimum
```

[n]	Channel number: For single-channel instruments, the value is 1
<function>	The measurement function to which this setting applies: <ul style="list-style-type: none"> ▪ Concurrent: CONCurrent[:DC] ▪ Current: CURRent[:DC] ▪ Voltage: VOLTage[:DC]
<value>	4.5 digit resolution: 4 5.5 digit resolution: 5 6.5 digit resolution: 6

Details

This command affects how the reading for a measurement is displayed on the front panel of the instrument. It does not affect the number of digits returned in a remote command reading. It also does not affect the accuracy or speed of measurements.

The display digits setting is saved with the function setting, so if you use another function, then return to the function for which you set display digits, the display digits setting you set previously is retained.

The change in digits occurs the next time a measurement is made.

Example

```
:SENS:CURR:DIG 5
```

Set the front panel to display current measurements with 5½ digits.

Also see

[:SENSe\[n\]:<function>:RESolution](#) (on page 7-73)

:SENSe[n]:<function>:NPLCycles

This command sets the time that the input signal is measured for measurements of the selected function.

Type	Affected by	Where saved	Default value
Command and query	Recall settings Instrument reset Power cycle	Save settings	1

Usage

```
:SENSe[n]:<function>:NPLCycles <value>
:SENSe[n]:<function>:NPLCycles?
:SENSe[n]:<function>:NPLCycles? DEFault
:SENSe[n]:<function>:NPLCycles? MINimum
:SENSe[n]:<function>:NPLCycles? MAXimum
```

[n]	Channel number: For single-channel instruments, the value is 1
<function>	The measurement function to which this setting applies: <ul style="list-style-type: none"> ▪ Concurrent: CONCurrent[:DC] ▪ Current: CURRent[:DC] ▪ Voltage: VOLTage[:DC]
<value>	The number of power-line cycles for each measurement: 0.002 to 12 for 50 Hz; 0.002 to 15 for 60 Hz

Details

This command sets the amount of time that the input signal is measured.

The amount of time is specified in parameters that are based on the number of power line cycles (NPLCs). Each PLC for 60 Hz is 16.67 ms (1/60) and each PLC for 50 Hz is 20 ms (1/50).

This command is set for the measurement of specific functions (concurrent, current, or voltage).

The shortest amount of time (0.002 PLC) results in the fastest reading rate, but increases reading noise and decrease the number of usable digits.

The longest amount of time (15 PLC) provides the lowest reading noise and more readable digits, but has the slowest reading rate.

Settings between the fastest and slowest number of PLCs are a compromise between speed and noise.

Example

```
:SENS:CURR:NPLC 0.5
```

Sets the measurement time for current measurements to 0.0083 (0.5/60) s.

Also see

[Optimizing either measurement accuracy or speed](#) (on page 4-1)

:SENSe[n]:<function>:RANGe

This command sets the measurement range for measurements of the selected function.

Type	Affected by	Where saved	Default value
Command and query	Power cycle	Save settings	Concurrent: 10 mA Current: 10 mA Voltage: 33 V for Model 2280S-32-6; 61 V for Model 2280S-60-3

Usage

```
:SENSe[n]:CONCurrent[:DC]:RANGe <range>
:SENSe[n]:CONCurrent[:DC]:RANGe?
:SENSe[n]:CONCurrent[:DC]:RANGe? DEFault
:SENSe[n]:CONCurrent[:DC]:RANGe? MINimum
:SENSe[n]:CONCurrent[:DC]:RANGe? MAXimum
:SENSe[n]:CURRent[:DC]:RANGe <range>
:SENSe[n]:CURRent[:DC]:RANGe?
:SENSe[n]:CURRent[:DC]:RANGe? DEFault
:SENSe[n]:CURRent[:DC]:RANGe? MINimum
:SENSe[n]:CURRent[:DC]:RANGe? MAXimum
:SENSe[n]:VOLTage[:DC]:RANGe <range>
:SENSe[n]:VOLTage[:DC]:RANGe?
```

[n]	Channel number: For single-channel instruments, the value is 1
<range>	Set this command to a specific value or a preset value. See Details .

Details

This command is primarily intended to eliminate the time that is required by the instrument to select an automatic range.

The options for <range> are described in the following table.

Measurement function	Measure ranges
Concurrent	0.01 A, 0.1 A, 1 A, and 10 A
Current	0.01 A, 0.1 A, 1 A, and 10 A
Voltage	32 V for Model 2280S-32-6; 60 V for Model 2280S-60-3

NOTE

When you select a fixed range, an overrange condition can occur.

When you set a value for the measurement range, the measurement autorange setting is automatically disabled for the measurement function.

When you read this setting, you see the measurement range that the instrument is presently using. If you change the range while the output is off, the instrument does not update the hardware settings, but if you read the range setting, the return is the setting that will be used when the output is turned on. If you set a range while the output is on, the new setting takes effect immediately. When you assign a specific value to this command, the instrument is set on a fixed range that is large enough to measure the assigned value. The instrument selects the best range for measuring a value of <range>.

For example, for current measurements, if you expect a reading of approximately 50 mA, set <range> to 0.05 (or 50e-3) to select the 100 mA range.

NOTE

For concurrent measurements, range only applies to current measurement. For voltage measurement, there is only one range.

Example

```
:SENS:CURR:RANG 0.01
```

Select the 10 mA range.

```
:SENS:CONC:RANG 1
```

Select the 1 A range.

```
:SENS:VOLT:RANG 32
```

Select the 32V range.

Also see

[:SENSe\[n\]:<function>:RANGe:AUTO](#) (on page 7-69)

:SENSe[n]:<function>:RANGe:AUTO

This command determines if the range for measurements of the selected function is selected manually or automatically.

Type	Affected by	Where saved	Default value
Command and query	Recall settings Instrument reset Power cycle	Saved setup	1 (ON)

Usage

```
:SENSe[n]:<function>:RANGe:AUTO <state>
:SENSe[n]:<function>:RANGe:AUTO?
```

[n]	Channel number: For single-channel instruments, the value is 1
<function>	The measurement function to which this setting applies: <ul style="list-style-type: none"> ▪ Concurrent: CONCurrent[:DC] ▪ Current: CURRent[:DC]
<state>	Set the measurement range manually: OFF or 0 Set the measurement range automatically: ON or 1

Details

This command determines how the range is selected.

When this command is set to off, you must set the range. If you do not set the range, the instrument remains at the range that was last selected by autorange.

When this command is set to on, the instrument automatically goes to the most sensitive range to perform the measurement.

If a range is manually selected through the front panel or a remote command, this command is automatically set to off.

Example

```
:SENS:CURR:RANG:AUTO ON
```

Set the range to be selected automatically for current measurements.

Also see

[:SENSe\[n\]:<function>:RANGe](#) (on page 7-67)

:SENSe[n]:<function>:REFerence

This command specifies the relative offset value for the measurement.

Type	Affected by	Where saved	Default value
Command and query	Recall settings Instrument reset Power cycle	Save settings	0.0

Usage

```
:SENSe[n]:CONCurent:REFerence <ref>
:SENSe[n]:CURRent:REFerence <ref>
:SENSe[n]:VOLTage:REFerence <ref>
:SENSe[n]:CONCurent:REFerence?
:SENSe[n]:CURRent:REFerence?
:SENSe[n]:VOLTage:REFerence?
```

[n]	Channel number: For single-channel instruments, the value is 1
<ref>	The relative offset value: <ul style="list-style-type: none"> ▪ Concurrent and current: -6.1 to 6.1 A for Model 2280S-32-6, -3.3 to 3.3 A for Model 2280S-60-3 ▪ Voltage: -32 to 32 V for Model 2280S-32-6, -60 to 60 V for Model 2280S-60-3

Details

This command specifies the relative offset value that can be applied to new measurements. When relative offset is enabled, all subsequent measured readings are offset by the value that is set for this command.

You can set this value, or have the instrument acquire a value. If the instrument acquires the value, read this setting to return the value that was measured internally.

NOTE

For concurrent measurements, the offset value is applied only to current measurements.

Example

```
SENS:CONC:REF 1
```

Set the relative offset for current measurements to 1.

Also see

[:SENSe\[n\]:<function>:REFerence:ACQUIRE](#) (on page 7-71)

[:SENSe\[n\]:<function>:REFerence:STATE](#) (on page 7-72)

:SENSe[n]:<function>:REFerence:ACQuire

This command acquires a measurement and stores it as the relative offset value.

Type	Affected by	Where saved	Default value
Command only	Not applicable	Not applicable	Not applicable

Usage

```
:SENSe[n]:<function>:REFerence:ACQuire
```

[n]	Channel number: For single-channel instruments, the value is 1
<function>	The measurement function to which this setting applies: <ul style="list-style-type: none"> ▪ Concurrent: CONCurrent[:DC] ▪ Current: CURRent[:DC] ▪ Voltage: VOLTage[:DC]

Details

This command triggers the Series 2280 to make a new measurement for the selected function. This measurement is then stored as the new relative offset level setting.

When you send this command, the measurement is made without applying any filter operations, even if they are set. It is as if these settings are disabled.

After executing this command, you can use the following command to see the last relative level value that was acquired or that was set.

```
:SENSe[n]:<function>:REFerence?
```

If an error occurs during the measurement, the relative offset level remains at the last valid setting.

NOTE

This command only works if the instrument is on the specified function. For example, if the instrument is on the voltage function, the only valid acquire command is `SENS:VOLT:REF:ACQ`.

Also, if the acquired measurement has caused an overflow condition or the instrument is waiting for the trigger to start measurements, you will see error -200, "Execution error" when you send this command.

Example

<pre>:SENS:FUNC "VOLT" :SENS:VOLT:REF:STAT ON :SENS:VOLT:REF:ACQ :SENS:VOLT:REF?</pre>	<p>Switch to voltage measurements. Turn relative offset on. Acquire a relative offset value for voltage measurements. Query for the offset value.</p>
--	---

Also see

- [:SENSe\[n\]:<function>:REFerence](#) (on page 7-70)
- [:SENSe\[n\]:<function>:REFerence:STATe](#) (on page 7-72)

:SENSe[n]:<function>:REFerence:STATe

This command enables or disables a relative offset value.

Type	Affected by	Where saved	Default value
Command and query	Recall settings Instrument reset Power cycle	Save settings	0 (OFF)

Usage

```
:SENSe[n]:<function>:REFerence:STATe <state>
:SENSe[n]:<function>:REFerence:STATe?
```

[n]	Channel number: For single-channel instruments, the value is 1
<function>	The measurement function to which this setting applies: <ul style="list-style-type: none"> ▪ Concurrent: CONCurrent[:DC] ▪ Current: CURRent[:DC] ▪ Voltage: VOLTage[:DC]
<state>	Disable the relative offset: OFF or 0 Enable the relative offset: ON or 1

Details

This attribute enables or disables relative measurements. When relative measurements are enabled, all subsequent measured readings are offset by the relative offset value calculated when you acquire the relative offset value.

Each returned measured relative reading is the result of the following calculation:

$$\text{Displayed reading} = \text{Actual measured reading} - \text{Relative offset value}$$

NOTE

For concurrent measurements, the offset value is applied only to current measurements.

Example

```
:SENS:FUNC "VOLT"
:SENS:VOLT:REF:ACQ
:SENS:VOLT:REF:STATe ON
```

Set the measurement function to voltage with a relative offset of 5 V and enable the relative offset function.

Also see

[:SENSe\[n\]:<function>:REFerence:ACQuire](#) (on page 7-71)

:SENSe[n]:<function>:RESolution

This command sets the measurement resolution for the selected measurement function.

Type	Affected by	Where saved	Default value
Command only	Recall settings Instrument reset Power cycle	Save settings	6

Usage

:SENSe[n]:<function>:RESolution <value>

[n]	Channel number: For single-channel instruments, the value is 1
<function>	The measurement function to which this setting applies: <ul style="list-style-type: none"> ▪ Concurrent: CONCurrent[:DC] ▪ Current: CURRent[:DC] ▪ Voltage: VOLTage[:DC]
<value>	4.5 digit resolution: 4 5.5 digit resolution: 5 6.5 digit resolution: 6

Details

This command affects how the reading for a measurement is displayed on the front panel of the instrument. It also affects the accuracy or speed of measurements.

When a resolution is selected, the number of power line cycles (NPLCs), autozero, digit, source delay, and filter are automatically set to the value described in the following table.

Resolution	NPLC	Autozero	Source delay	Digits	Average filter
4.5 digits resolution	0.01	Off	<ul style="list-style-type: none"> ▪ 0 s ▪ State: Off 	4.5 digits display resolution	<ul style="list-style-type: none"> ▪ Filter count: 10 ▪ Filter window: 0.01% ▪ Filter state: On
5.5 digits resolution	0.1	Off	<ul style="list-style-type: none"> ▪ 0.001 s ▪ State: On 	5.5 digits display resolution	<ul style="list-style-type: none"> ▪ Filter count: 10 ▪ Filter window: 0.01% ▪ Filter state: Off
6.5 digits resolution	1	On	<ul style="list-style-type: none"> ▪ 0.001 s ▪ State: On 	6.5 digits display resolution	<ul style="list-style-type: none"> ▪ Filter count: 10 ▪ Filter window: 0.01% ▪ Filter state: Off

Example

:SENS:CURR:RES 5	Set the 5½ digit measurement resolution
------------------	---

Also see

[:SENSe\[n\]:<function>:DIGits](#) (on page 7-65)

SOURce subsystem

The commands in the SOURce subsystem configure and control the current source and voltage source.

[:SOURce[n]] :DELay

This command sets the source delay.

Type	Affected by	Where saved	Default value
Command and query	Recall settings Instrument reset Power cycle	Save settings	0.001 s

Usage

```
[ :SOURce[n] ] :DELay <value>
[ :SOURce[n] ] :DELay?
```

[n]	Channel number: For single-channel instruments, the value is 1
<value>	Delay: 0 to 99 s. Resolution 0.00001 s.

Details

This command sets a delay for the source. After the programmed source is turned on, this delay allows the source level to settle before a measurement is taken. For details, refer to [Source delay](#) (on page 3-7).

NOTE

This delay is the same for both the current and voltage source. Delay time must be either zero or a positive value. If you attempt to set it to a negative value, an error -222, "Data out of range" is generated.

Example

<code>:DELay 0.05</code>	Set the delay for the output source to 50 ms.
--------------------------	---

Also see

None

[:SOURce[n]]:DELay:STATe

This command enables or disables the delay that occurs when the source is turned on.

Type	Affected by	Where saved	Default value
Command and query	Recall settings Instrument reset Power cycle	Save settings	1 (ON)

Usage

```
[:SOURce[n]]:DELay:STATe <state>
[:SOURce[n]]:DELay:STATe?
```

[n]	Channel number: For single-channel instruments, the value is 1
<state>	Disable the source delay: OFF or 0 Enable the source delay: ON or 1

Details

This command is used to enable or disable source delay. When enabled, the instrument will delay for a period that is set by the command:

```
[:SOURce[n]]:DELay
```

Example

:DEL:STAT ON :DEL:STAT?	Turn on source delay and query the state. The output is: 1.
----------------------------	---

Also see

[\[:SOURce\[n\]\]:DELay](#) (on page 7-74)

[[:SOURce[n]]:<function>:PROTection[:LEVel]]

This command sets the overvoltage protection setting of the source output.

Type	Affected by	Where saved	Default value
Command and query	Recall settings Instrument reset Power cycle	Save settings	Voltage: 33 V for Model 2280S-32-6; 61 V for Model 2280S-60-3 Current: 6.1 A for model 2280S-32-6; 3.3 A for 2280S-60-3

Usage

```
[[:SOURce[n]]:VOLTage:PROTection[:LEVel] <value>
[:SOURce[n]]:VOLTage:PROTection[:LEVel]?
[:SOURce[n]]:VOLTage:PROTection[:LEVel]? DEFault
[:SOURce[n]]:VOLTage:PROTection[:LEVel]? MINimum
[:SOURce[n]]:VOLTage:PROTection[:LEVel]? MAXimum
[:SOURce[n]]:CURRent:PROTection[:LEVel] <value>
[:SOURce[n]]:CURRent:PROTection[:LEVel]?
[:SOURce[n]]:CURRent:PROTection[:LEVel]? DEFault
[:SOURce[n]]:CURRent:PROTection[:LEVel]? MINimum
[:SOURce[n]]:CURRent:PROTection[:LEVel]? MAXimum
```

[n]	Channel number: For single-channel instruments, the value is 1.
<value>	The overvoltage or overcurrent protection level: <ul style="list-style-type: none"> ▪ Voltage: 0.5 V to 33 V for Model 2280S-32-6, 0.5 V to 61 V for Model 2280S-60-3 ▪ Current: 0.1 A to 6.1 A for Model 2280S-32-6, 0.1 A to 3.3 A for Model 2280S-60-3

Details

Overvoltage protection restricts the maximum voltage level that the instrument can source. Overcurrent protection restricts the maximum current level that the instrument can source. This protection is in effect only for positive output voltages or currents.

When this attribute is used in a test sequence, it should be set before the turning the source on.

Example

<pre>:VOLT:PROT 30 :VOLT:PROT?</pre>	Set the voltage source protection to 30 V and query the value. Output: 30
--------------------------------------	---

Also see

None

[[:SOURce[n]]:<function>[:LEVel][:IMMediate][:AMPLitude]

This command sets the source amplitude for voltage or current.

Type	Affected by	Where saved	Default value
Command and query	Recall settings Instrument reset Power cycle	Save settings	Voltage: 0 V Current: 0.1 A

Usage

```
[[:SOURce[n]]:VOLTage[:LEVel][:IMMediate][:AMPLitude] <value>
[:SOURce[n]]:VOLTage[:LEVel][:IMMediate][:AMPLitude]?
[:SOURce[n]]:VOLTage[:LEVel][:IMMediate][:AMPLitude]? DEFault
[:SOURce[n]]:VOLTage[:LEVel][:IMMediate][:AMPLitude]? MINimum
[:SOURce[n]]:VOLTage[:LEVel][:IMMediate][:AMPLitude]? MAXimum
[:SOURce[n]]:CURRent[:LEVel][:IMMediate][:AMPLitude] <value>
[:SOURce[n]]:CURRent[:LEVel][:IMMediate][:AMPLitude]?
[:SOURce[n]]:CURRent[:LEVel][:IMMediate][:AMPLitude]? DEFault
[:SOURce[n]]:CURRent[:LEVel][:IMMediate][:AMPLitude]? MINimum
[:SOURce[n]]:CURRent[:LEVel][:IMMediate][:AMPLitude]? MAXimum
```

[n]	Channel number: For single-channel instruments, the value is 1.
<value>	The source amplitude: <ul style="list-style-type: none"> Voltage: 0 to 32 V for Model 2280S-32-6; 0 to 60 V for Model 2280S-60-3 Current: 0 to 6.1 A for Model 2280S-32-6; 0 to 3.3 A for Model 2280S-60-3

Details

This command sets the output level of the voltage or current source. If the output is on, the new level is sourced immediately.

NOTE

Sending the `:VOLT? MAX` command returns 32 V for Model 2280S-32-6 and 60 V for Model 2280S-60-3.

Example

<code>:VOLT 20</code> <code>:CURR 1.2</code>	Set the voltage source to 20 V and limit the current to 1.2 A.
---	--

Also see

[\[:SOURce\[n\]\]:VOLTage:LIMit\[:AMPLitude\]](#) (on page 7-78)

[[:SOURce[n]]:VOLTage:LIMit[:AMPLitude]

This command selects the limit of voltage source.

Type	Affected by	Where saved	Default value
Command and query	Recall settings Instrument reset Power cycle	Save settings	32.5 V for Model 2280S-32-6 61 V for Model 2280S-60-3

Usage

```
[[:SOURce[n]]:VOLTage:LIMit[:AMPLitude] <value>
[:SOURce[n]]:VOLTage:LIMit[:AMPLitude]?
[:SOURce[n]]:VOLTage:LIMit[:AMPLitude]? DEFAULT
[:SOURce[n]]:VOLTage:LIMit[:AMPLitude]? MINimum
[:SOURce[n]]:VOLTage:LIMit[:AMPLitude]? MAXimum
```

[n]	Channel number: For single-channel instruments, the value is 1.
<value>	0 to 32 V for Model 2280S-32-6 0 to 60 V for Model 2280S-60-3

Details

This command sets the voltage limit. The Series 2280 cannot source voltage levels that exceed this limit. When you change the voltage limit to a value that is smaller than the set value of voltage, the voltage setting will be forced to voltage limit.

Example

<code>:VOLT:LIM 15</code>	Set the voltage limit to 15 V
---------------------------	-------------------------------

Also see

[\[:SOURce\[n\]\]:<function>\[:LEVel\]\[:IMMediate\]\[:AMPLitude\]](#) (on page 7-77)

[[:SOURce[n]]:VOLTage:SLEW:RISing

This command specifies and queries the rising rate for the voltage source.

Type	Affected by	Where saved	Default value
Command and query	Recall settings Instrument reset Power cycle	Save settings	100 V/s

Usage

```
[[:SOURce[n]]:VOLTage:SLEW:RISing <value>
[:SOURce[n]]:VOLTage:SLEW:RISing?
[:SOURce[n]]:VOLTage:SLEW:RISing? DEFault
[:SOURce[n]]:VOLTage:SLEW:RISing? MINimum
[:SOURce[n]]:VOLTage:SLEW:RISing? MAXimum
```

[n]	Channel number: For single-channel instruments, the value is 1
<value>	The voltage rising rate: 10 V per second to 1000 V per second.

Details

Slew rate is defined as the maximum rate of change of output voltage per unit of time. The slew rising rate is applied to any voltage increase.

NOTE

When you turn on the output, the voltage rises at the specified rate.

Example

<code>:VOLT:SLEW:RIS 20</code>	Set the voltage rising rate to 20 V per second.
--------------------------------	---

Also see

[\[:SOURce\[n\]\]:VOLTage:SLEW:FALLing](#) (on page 7-80)

[:SOURce[n]]:VOLTage:SLEW:FALLing

This command specifies and queries the falling rate for the voltage source.

Type	Affected by	Where saved	Default value
Command and query	Recall settings Instrument reset Power cycle	Save settings	100 V/s

Usage

```
[:SOURce[n]]:VOLTage:SLEW:FALLing <value>
[:SOURce[n]]:VOLTage:SLEW:FALLing?
[:SOURce[n]]:VOLTage:SLEW:FALLing? DEFault
[:SOURce[n]]:VOLTage:SLEW:FALLing? MINimum
[:SOURce[n]]:VOLTage:SLEW:FALLing? MAXimum
```

[n]	Channel number: For single-channel instruments, the value is 1
<value>	The voltage falling rate: 10 V per second to 1000 V per second

Details

Slew rate is defined as the maximum rate of change of output voltage per unit of time. The falling rate is applied to any voltage decrease.

NOTE

When you turn off the output, the voltage drops at the specified rate.

Example

```
:VOLT:SLEW:FALL 90.5 Set the voltage falling rate to 90.5 V per second.
```

Also see

[\[:SOURce\[n\]\]:VOLTage:SLEW:RISing](#) (on page 7-79)

[:SOURce[n]] :LIST<listNumber> :<element>

This command allows you to set up and query a list of custom values for a specified list.

Type	Affected by	Where saved	Default value
Command only	Instrument reset	Nonvolatile memory	Not applicable

Usage

```
[ :SOURce[n] ] :LIST<listNumber> :<element> <string>
```

```
[ :SOURce[n] ] :LIST<listNumber> :<element>?
```

[n]	Channel number: For single-channel instruments, the value is 1
<listNumber>	The list number: 1 to 9
<element>	The elements that each list step contains: <ul style="list-style-type: none"> ▪ Current source value: CURRent ▪ Voltage source value: VOLTage ▪ The dwell time of each list step: DWELL
<string>	The setting values delimited by commas; the maximum length of a string is 2048

Details

This command defines a list of up to 99 values for a specified list. Creating a list with more than 99 step points results in error 201, "Too many list points."

When you specify the values for a list, you should keep the value order in the string identical with the sequence that the list executes.

To add source values to an existing list, use the following command:

```
[ :SOURce[n] ] :LIST<listNumber> :<element> :APPend
```

NOTE

All of the values specified by this command are temporary until they are saved by sending the

```
[ :SOURce[n] ] :LIST :SAVE :INTernal
```

command.

To create a valid list, the number of points for voltage, current, and dwell must be the same. If they are not the same, when you save the list by sending the `[:SOURce[n]] :LIST :SAVE :INTernal` command, the instrument will generate error 202, "List lengths not equivalent."

Example

```

:LIST1:CURR "1,1,1"
:LIST1:VOLT "5,10,15"
:LIST1:DWEL "2,2,2"
:LIST1:CURR:APPE "2,2,2"
:LIST1:VOLT:APPE "5,10,15"
:LIST1:DWEL:APPE "3,3,3"
:LIST:SAVE:INTE 1
:LIST1:CURR?

```

Set up list 1 with the following 6 points:

Point 1: 1 A, 5 V, 2 s

Point 2: 1 A, 10 V, 2 s

Point 3: 1 A, 15 V, 2 s

Point 4: 2 A, 5 V, 3 s

Point 5: 2 A, 10 V, 3 s

Point 6: 2 A, 15 V, 3 s

Query the current settings of list 1. Output:

```

1.0000,1.0000,1.0000,2.0000,2.000
0,2.0000

```

Also see

[\[:SOURce\[n\]\]:LIST<listNumber>:<element>:APPend](#) (on page 7-82)

[\[:SOURce\[n\]\]:LIST:SAVE:INTernal](#) (on page 7-90)

[:SOURce[n]]:LIST<listNumber>:<element>:APPend

This command adds values to the specified list.

Type	Affected by	Where saved	Default value
Command only	Instrument reset	Nonvolatile memory	Not applicable

Usage

```
[:SOURce[n]]:LIST<listNumber>:<element>:APPend <string>
```

[n]	Channel number: For single-channel instruments, the value is 1
<listNumber>	The list number: 1 to 9.
<element>	The elements that each list step contains: <ul style="list-style-type: none"> ▪ Current source value: CURRent ▪ Voltage source value: VOLTage ▪ The dwell time of each list step: DWELl. Range: 0 to 60 s.
<string>	The setting values delimited by commas. The maximum length of a string is 2048.

Details

This command allows you to add values to the specified list. The new values are added to the end of the existing values. You can have a total of 99 values in a list.

NOTE

To create a valid list, the number of points for voltage, current, and dwell must be the same. If they are not the same, when you save the list by sending the `[:SOURce[n]]:LIST:SAVE:INTernal` command, the instrument will generate error 202, "List lengths not equivalent."

Example

<pre> :LIST1:CURR "1,1,1" :LIST1:VOLT "5,10,15" :LIST1:DWEL "2,2,2" :LIST1:CURR:APPE "2,2,2" :LIST1:VOLT:APPE "5,10,15" :LIST1:DWEL:APPE "3,3,3" :LIST:SAVE:INTE 1 :LIST1:CURR? </pre>	<p>Set up list 1 with the following 6 points: Point 1: 1 A, 5 V, 2 s Point 2: 1 A, 10 V, 2 s Point 3: 1 A, 15 V, 2 s Point 4: 2 A, 5 V, 3 s Point 5: 2 A, 10 V, 3 s Point 6: 2 A, 15 V, 3 s</p> <p>Query the current settings of list 1. Output: 1.0000,1.0000,1.0000,2.0000,2.0000,2.0000</p>
--	---

Also see

- [\[:SOURce\[n\]\]:LIST<listNumber>:<element>](#) (on page 7-81)
- [\[:SOURce\[n\]\]:LIST:SAVE:INTernal](#) (on page 7-90)

[:SOURce[n]]:LIST<listNumber>:<element>:POINTs?

This command queries the length of the specified list.

Type	Affected by	Where saved	Default value
Query only	Instrument reset	Not applicable	Not applicable

Usage

```

[:SOURce [n]] :LIST<listNumber>:CURRent:POINTs?
[:SOURce [n]] :LIST<listNumber>:VOLTage:POINTs?
[:SOURce [n]] :LIST<listNumber>:DWELl:POINTs?
                
```

[n]	Channel number: For single-channel instruments, the value is 1
<listNumber>	The list number: 1 to 9.

Details

This command returns the length of the specified list. The response message indicates the number of points in the list.

Example

<pre>:LIST1:VOLT:POIN?</pre>	Check the number of points in the list. Output: 6
------------------------------	---

Also see

- [\[:SOURce\[n\]\]:LIST<listNumber>:<element>](#) (on page 7-81)
- [\[:SOURce\[n\]\]:LIST<listNumber>:<element>:APPend](#) (on page 7-82)

[:SOURce[n]]:LIST:END:ZERO

This command specifies the source values when the instrument is stopping a list.

Type	Affected by	Where saved	Default value
Command and query	Recall settings Instrument reset Power cycle	Save settings	0 (OFF)

Usage

```
[:SOURce[n]]:LIST:END:ZERO <value>
[:SOURce[n]]:LIST:END:ZERO?
```

[n]	Channel number: For single-channel instruments, the value is 1.
<value>	When the list is stopped, <ul style="list-style-type: none"> ▪ Use the last source values: OFF or 0 ▪ Set the voltage to 0 V, current source to 0.1 A: ON or 1

Details

This command allows you to end a specified list with the last source value or zero value.

Example

```
LIST:END:ZERO ON
```

List ends with the 0 V and 0.1000 A.

Also see

None

[:SOURce[n]]:LIST:HTIME

This command determines the hold time of the list running.

Type	Affected by	Where saved	Default value
Command and query	Power cycle	Not applicable	POINT

Usage

```
[:SOURce[n]]:LIST:HTIME <type>
[:SOURce[n]]:LIST:HTIME?
```

[n]	Channel number: For single-channel instruments, the value is 1
<type>	<p>POINT: The list runs until the reading reaches the preset sample count; the hold time is computed by sample count * sample speed; the preset dwell time is ignored in this mode</p> <p>TIME: The list runs until the preset time is reached; the preset sample count is ignored in this mode</p>

NOTE

Hold time is decided by whichever is longer: dwell time or sample count.

Example

```
SOUR:LIST:HTIM time
SOUR:LIST:HTIM?
```

The hold time for list running is set as dwell time.

Also see

[:TRIGger\[:SEQuence\[n\]\]:SAMPle:COUNt](#) (on page 7-150)

[\[:SOURce\[n\]\]:LIST<listNumber>:<element>](#) (on page 7-81)

[[:SOURce[n]]]:LIST:LOAD:USB

This command imports a list from USB flash drive to the instrument and save it in the specified location specified.

Type	Affected by	Where saved	Default value
Command only	Not applicable	Not applicable	Not applicable

Usage

```
[[:SOURce[n]]]:LIST:LOAD:USB <listNumber>,<fileName>
```

[n]	Channel number: For single-channel instruments, the value is 1
<listNumber>	An integer from 1 to 9 that represents the specified location where the list is imported to
<fileName>	A string that contains a name for the list name (maximum 8 characters)

Detail

Import the list from external USB flash drive.

NOTE

Make sure that the external USB flash drive is connected to the instrument before you send this command. An unstable connection between the USB flash drive and the instrument will cause an error 520: "No USB flash drive found."

Example

```
:LIST:SAVE:LOAD 1, "mylist"
```

Import the list in the external USB flash drive to the list 1, and save the list as `mylist`.

Also see

[\[:SOURce\[n\]\]:LIST:SAVE:USB](#) (on page 7-90)

[:SOURce[n]]:LIST:MCOMplete

This command specifies the time when the instrument generates the measure complete signal with list enabled.

Type	Affected by	Where saved	Default value
Command and query	Recall settings Instrument reset Power cycle	Saved settings	1

Usage

```
[:SOURce[n]]:LIST:MCOMplete <type>
[:SOURce[n]]:LIST:MCOMplete?
```

[n]	Channel number: For single-channel instruments, the value is 1
<type>	The time you can choose to generate : <ul style="list-style-type: none"> ▪ STEP: After each list step, the instrument will generate a measure complete pulse; you can detect this pulse on digital I/O line 2; for more information, refer to Digital I/O (on page 3-19) ▪ SWEEP: After each list cycle, the instrument will generate a measure complete pulse; you can detect the pulse on digital I/O line 2

Detail

When the list is running, the instrument allows you to check measure complete single to acquire the running state. You can use this command to configure the measure complete signal. For example, the following figure shows the different output of measure complete signal in a three-point list.

Figure 99: Step and sweep

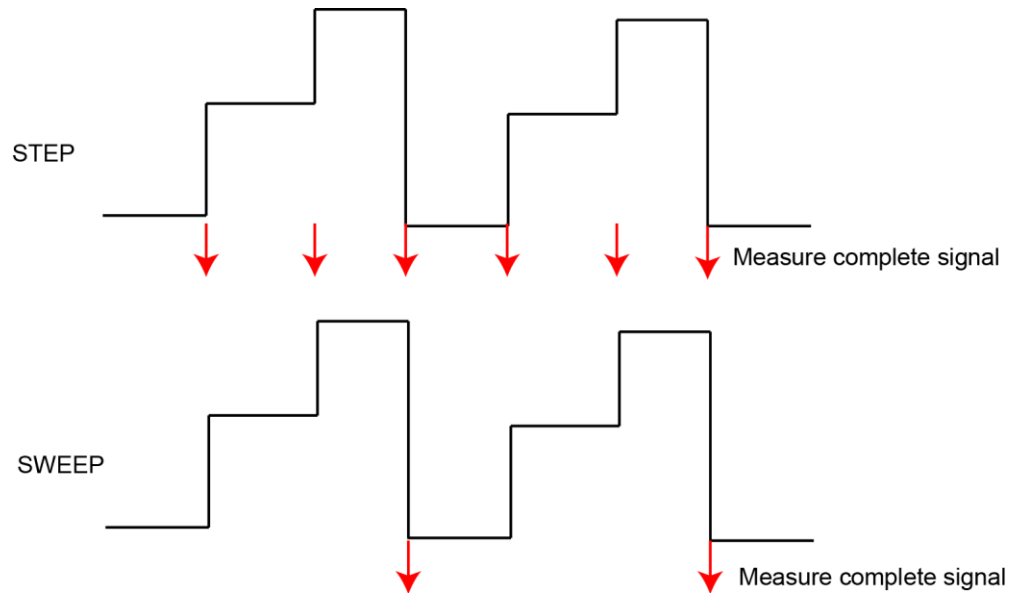

Example

<code>:LIST:MCOMP STEP</code>	After each list step, the instrument generates a measure complete pulse.
-------------------------------	--

Also see

[Digital I/O](#) (on page 3-19)

[[:SOURce[n]]:LIST:RCL

This command recalls a specific list.

Type	Affected by	Where saved	Default value
Command and query	Recall settings Instrument reset Power cycle	Saved settings	0

Usage

```
[[:SOURce[n]]:LIST:RCL <listNumber>
[:SOURce[n]]:LIST:RCL?
```

[n]	Channel number: For single-channel instruments, the value is 1
<listNumber>	The list number: 1 to 9

Details

Before you run a list, you need to recall this list. If you forget to recall a list, the last recalled list is used. Sending the command `:LIST:RCL?` returns the active list number.

Example 1: Sweep list with BUS trigger (hold time type: TIME)

<pre>*RST Define list :LIST1:VOLT "1, 2, 3, 4, 5" :LIST1:CURREN "0.5, 1, 1.5, 2, 2.5" :LIST1:DWELL "0.5, 0.5, 0.5, 0.5, 0.5" :LIST:SAVE:INTe 1 :LIST:RCL 1 :LIST:MCOMP SWEEP :LIST:HTIME TIME Define trigger model (sweep) :ARM:SOUR BUS :TRIG:COUN 5 Enable list mode :LIST:STAT ON :INIT *TRG</pre>	<pre>Reset the instrument and stop the trigger model Program voltage list 1 with 5 points Program current list 1 with 5 points Program dwell list 1 with 5 points Save list 1 to nonvolatile memory Recall list 1 Select sweep mode Set hold time type to TIME Select the BUS arm source Set the trigger count to list points, no need to set the sample count for TIME mode Enable list mode Start the trigger model Run the lists Hold time is the sum of the dwell time of 5 points All the readings will be stored in data buffer</pre>
--	---

Example 2: Sweep list with BUS trigger (hold time type: POINT)

<pre>*RST Define list :LIST1:VOLT "1, 2, 3, 4, 5" :LIST1:CURR "0.5, 1, 1.5, 2, 2.5" :LIST1:DWEL "0.5, 0.5, 0.5, 0.5, 0.5" :LIST:SAVE:INTE 1 :LIST:RCL 1 :LIST:MCOMP SWEEP :LIST:HTIME POINT Define trigger model (sweep) :ARM:SOUR BUS :TRIG:COUN 5 :TRIG:SAMP:COUN 1 Enable list mode :LIST:STAT ON :INIT *TRG</pre>	<p>Reset the instrument and stop the trigger model</p> <p>Program voltage list 1 with 5 points Program current list 1 with 5 points Program dwell list 1 with 5 points Save list 1 to nonvolatile memory Recall list 1 Select sweep mode Set hold time type to POINT</p> <p>Select the BUS arm source Set the trigger count to list points Select 1 sample count (a point is measured at each source level)</p> <p>Enable list mode Start the trigger model Run the lists Dwell time is ignored in this mode The lists run until the preset points are logged All the readings will be stored in data buffer</p>
--	--

Example 3: Step list with BUS trigger (hold time type: TIME)

<pre>*RST Define list :LIST1:VOLT "1, 2" :LIST1:CURR "0.5, 1" :LIST1:DWEL "0.5, 1.0" :LIST:SAVE:INTE 1 :LIST:RCL 1 :LIST:MCOMplete STEP :LIST:HTIME TIME Define trigger model (step) :ARM:SOUR BUS :ARM:COUN 2 :TRIG:COUN 1 Enable list mode :LIST:STAT ON :INIT *TRG *TRG</pre>	<p>Reset the instrument and stop the trigger model</p> <p>Program the voltage list 1 with 2 points Program the current list 1 with 2 points Program the dwell list 1 with 2 points Save list 1 to nonvolatile memory Recall list 1 Select STEP mode Set hold time type to TIME. You do not have to set sample count.</p> <p>Select the BUS arm source Set the arm count to list points, no need to set the sample count for TIME mode</p> <p>Enable list mode Start the trigger model Run the step Hold time is the preset dwell time All the readings will be stored in data buffer Run the next step</p>
---	--

NOTE

You must allow the currently running list to finish before you run a new one. If you try to run a new one anyway, the command will be ignored.

Example 4: Step list with BUS trigger (hold time type: POINT)

<pre>*RST Define list :LIST1:VOLT "1, 2" :LIST1:CURR "0.5, 1" :LIST1:DWEL "0.5, 1.0" :LIST:SAVE:INTE 1 :LIST:RCL 1 :LIST:MCOMPLete STEP :LIST:HTIME POINT Define trigger model (step) :ARM:SOUR BUS :ARM:COUN 2 :TRIG:COUN 1 :TRIG:SAMP:COUN 6 Enable list mode :LIST:STAT ON :INIT *TRG *TRG</pre>	<p>Reset the instrument and stop the trigger model</p> <p>Program the voltage list 1 with 2 points Program the current list 1 with 2 points Program the dwell list 1 with 2 points Save list 1 to nonvolatile memory Recall list 1 Select STEP mode Set hold time type to POINT.</p> <p>Select the BUS arm source Set Arm count to list points Set trigger count to 1 Set trigger count to 6, then every step 6 points will be logged</p> <p>Enable list mode Start the trigger model Run the step Dwell time is ignored in this mode The list runs until the preset points are logged All the readings will be stored in data buffer Run the next step</p>
--	--

NOTE

You must allow the currently running list to finish before you run a new one. If you try to run a new one anyway, the command will be ignored.

Example 5: Stop a running list

<pre>:ABOR :LIST:STAT OFF</pre>	<p>Stop the trigger model Disable list mode</p>
---------------------------------	--

Also see

[\[:SOURce\[n\]\]:LIST:STATe](#) (on page 7-91)

[:SOURce[n]]:LIST:SAVE:INTernal

This command stores the specified list to nonvolatile memory.

Type	Affected by	Where saved	Default value
Command only	Not applicable	Not applicable	Not applicable

Usage

```
[:SOURce[n]]:LIST:SAVE:INTernal <listNumber>
```

[n]	Channel number: For single-channel instruments, the value is 1
<listNumber>	The list number: 1 to 9

Details

The Series 2280 supports up to nine lists. You can save a specified list to internal memory. Before saving, the instrument will verify the points of voltage, current, and dwell in the specified list. If they are the same, the list will be saved. Otherwise, error 202, "List lengths not equivalent," is generated.

If a list already exists for the specified list number, the new list overwrites the existing list.

Example

<pre>LIST1:VOLT "1,2" LIST1:CURR "0.5,1" LIST1:DWEL "0.5,0.5" LIST:SAVE:INT 1</pre>	<p>Create a list with 2 points:</p> <ul style="list-style-type: none"> ▪ Point 1: 1 V, 0.5 A, 0.5 s ▪ Point 2: 2 V, 1 A, 0.5 s <p>Save list 1 to the internal memory</p>
---	--

Also see

[\[:SOURce\[n\]\]:LIST<listNumber>:<element>](#) (on page 7-81)

[\[:SOURce\[n\]\]:LIST<listNumber>:<element>:APPend](#) (on page 7-82)

[:SOURce[n]]:LIST:SAVE:USB

This command saves the specified list to the USB flash drive.

Type	Affected by	Where saved	Default value
Command only	Not applicable	Not applicable	Not applicable

Usage

```
[:SOURce[n]]:LIST:SAVE:USB <listNumber>,<fileName>
```

[n]	Channel number: For single-channel instruments, the value is 1
<listNumber>	An integer from 1 to 9 that represents the list to save to the USB flash drive
<fileName>	A string that contains a name for the saved list (maximum 8 characters)

Detail

Save the specified list to the USB flash drive.

NOTE

Make sure that the external USB flash drive is connected to the instrument before you send this command. An unstable connection between the USB flash drive and the instrument will cause an error 520: "No USB flash drive found."

Example

<code>:LIST:SAVE:USB 1, "mylist"</code>	Export the list 1 to the external USB flash drive as mylist.
---	--

Also see

[\[:SOURce\[n\]\]:LIST:LOAD:USB](#) (on page 7-85)

[:SOURce[n]]:LIST:STATE

This command enables or disables the list mode.

Type	Affected by	Where saved	Default value
Command and query	Recall settings Instrument reset Power cycle	Save settings	0 (OFF)

Usage

```
[:SOURce[n]]:LIST:STATE <value>
[:SOURce[n]]:LIST:STATE?
```

[n]	Channel number: For single-channel instruments, the value is 1
<value>	Enable the list mode: OFF or 0 Disable the list mode: ON or 1

Details

This command enables or disables the list mode.

NOTE

The list only works in the concurrent function. If the function is not concurrent, sending the `[:SOURce[n]]:LIST:STATE` command will result in the error 209, "Change Sense Function to V+I (CONCurrent) before running a list."

Example 1: Sweep list with BUS trigger (hold time type: TIME)

<pre>*RST Define list :LIST1:VOLT "1, 2, 3, 4, 5" :LIST1:CURR "0.5, 1, 1.5, 2, 2.5" :LIST1:DWEL "0.5, 0.5, 0.5, 0.5, 0.5" :LIST:SAVE:INTE 1 :LIST:RCL 1 :LIST:MCOMP SWEEP :LIST:HTIME TIME Define trigger model (sweep) :ARM:SOUR BUS :TRIG:COUN 5 Enable list mode :LIST:STAT ON :INIT *TRG</pre>	<p>Reset the instrument and stop the trigger model</p> <p>Program voltage list 1 with 5 points Program current list 1 with 5 points Program dwell list 1 with 5 points Save list 1 to nonvolatile memory Recall list 1 Select sweep mode Set hold time type to TIME</p> <p>Select the BUS arm source Set the trigger count to list points, no need to set the sample count for TIME mode Enable list mode Start the trigger model Run the lists Hold time is the sum of the dwell time of 5 points All the readings will be stored in data buffer</p>
---	---

Example 2: Sweep list with BUS trigger (hold time type: POINT)

<pre>*RST Define list :LIST1:VOLT "1, 2, 3, 4, 5" :LIST1:CURR "0.5, 1, 1.5, 2, 2.5" :LIST1:DWEL "0.5, 0.5, 0.5, 0.5, 0.5" :LIST:SAVE:INTE 1 :LIST:RCL 1 :LIST:MCOMP SWEEP :LIST:HTIME POINT Define trigger model (sweep) :ARM:SOUR BUS :TRIG:COUN 5 :TRIG:SAMP:COUN 1 Enable list mode :LIST:STAT ON :INIT *TRG</pre>	<p>Reset the instrument and stop the trigger model</p> <p>Program voltage list 1 with 5 points Program current list 1 with 5 points Program dwell list 1 with 5 points Save list 1 to nonvolatile memory Recall list 1 Select sweep mode Set hold time type to POINT</p> <p>Select the BUS arm source Set the trigger count to list points Select 1 sample count (a point is measured at each source level)</p> <p>Enable list mode Start the trigger model Run the lists Dwell time is ignored in this mode The lists run until the preset points are logged All the readings will be stored in data buffer</p>
--	--

Example 3: Step list with BUS trigger (hold time type: TIME)

*RST	Reset the instrument and stop the trigger model
Define list	
:LIST1:VOLT "1, 2"	Program the voltage list 1 with 2 points
:LIST1:CURR "0.5, 1"	Program the current list 1 with 2 points
:LIST1:DWEL "0.5, 1.0"	Program the dwell list 1 with 2 points
:LIST:SAVE:INTE 1	Save list 1 to nonvolatile memory
:LIST:RCL 1	Recall list 1
:LIST:MCOMPLete STEP	Select STEP mode
:LIST:HTIME TIME	Set hold time type to TIME. You do not have to set sample count.
Define trigger model (step)	
:ARM:SOUR BUS	Select the BUS arm source
:ARM:COUN 2	Set the arm count to list points, no need to set the sample count for TIME mode
:TRIG:COUN 1	
Enable list mode	
:LIST:STAT ON	Enable list mode
:INIT	Start the trigger model
*TRG	Run the step
*TRG	Hold time is the preset dwell time
	All the readings will be stored in data buffer
	Run the next step

NOTE

You must allow the currently running list to finish before you run a new one. If you try to run a new one anyway, the command will be ignored.

Example 4: Step list with BUS trigger (hold time type: POINT)

*RST	Reset the instrument and stop the trigger model
Define list	
:LIST1:VOLT "1, 2"	Program the voltage list 1 with 2 points
:LIST1:CURR "0.5, 1"	Program the current list 1 with 2 points
:LIST1:DWEL "0.5, 1.0"	Program the dwell list 1 with 2 points
:LIST:SAVE:INTE 1	Save list 1 to nonvolatile memory
:LIST:RCL 1	Recall list 1
:LIST:MCOMPLete STEP	Select STEP mode
:LIST:HTIME POINT	Set hold time type to POINT.
Define trigger model (step)	
:ARM:SOUR BUS	Select the BUS arm source
:ARM:COUN 2	Set Arm count to list points
:TRIG:COUN 1	Set trigger count to 1
:TRIG:SAMP:COUN 6	Set trigger count to 6, then every step 6 points will be logged
Enable list mode	
:LIST:STAT ON	Enable list mode
:INIT	Start the trigger model
*TRG	Run the step
*TRG	Dwell time is ignored in this mode
	The list runs until the preset points are logged
	All the readings will be stored in data buffer
	Run the next step

NOTE

You must allow the currently running list to finish before you run a new one. If you try to run a new one anyway, the command will be ignored.

Example 5: Stop a running list

:ABOR	Stop the trigger model
:LIST:STAT OFF	Disable list mode

Also see

[\[:SOURce\[n\]\]:LIST:RCL](#) (on page 7-87)

STATus subsystem

The STATus subsystem controls the status registers of the Series 2280. For additional information on the status model, see [Status model](#) (on page D-1).

:STATus:MEASurement[:EVENT]?

This command reads and clears the Measurement Event Register of the status model.

Type	Affected by	Where saved	Default value
Query only	Not applicable	Not applicable	Not applicable

Usage

```
:STATus:MEASurement[:EVENT]?
```

Details

This attribute reads the Measurement Event Register of the status model and then clears the register.

The instrument returns a decimal value that corresponds to the binary-weighted sum of all bits set in the register. For details, see [Measurement Event Register](#) (on page D-17).

Also see

None

:STATus:MEASurement:ENABLE

This command sets or reads the contents of the Measurement Event Enable Register of the status model.

Type	Affected by	Where saved	Default value
Command and query	Power cycle	Not applicable	0

Usage

```
:STATus:MEASurement:ENABLE <n>  
:STATus:MEASurement:ENABLE?
```

[n]	The status of the Measurement Status Register
-----	---

Details

This command sets or reads the contents of the enable register of the Measurement Event Register.

When one of these bits is set and the corresponding bit in the Measurement Event Register is set, the MSB bit in the Status Byte Register is set.

When sending binary values, preface <n> with #b. When sending hexadecimal values, preface <n> with #h. No preface is needed when sending decimal values.

Example

<pre>:STAT:MEAS:ENAB #b00100000000000000</pre>	<p>Sets the ISUM bit of the measurement status enable register using a binary value. You could also send the decimal value 8192 or the hexadecimal value: #h2000.</p>
--	---

Also see

[Measurement Event Register](#) (on page D-17)

:STATus:MEASurement:INSTrument[:EVENT]?

This command reads and clears the Measurement Instrument Event Register of the status model.

Type	Affected by	Where saved	Default value
Query only	Not applicable	Not applicable	Not applicable

Usage

```
:STATus:MEASurement:INSTrument[:EVENT]?
```

Details

This attribute reads the Measurement Instrument Event Register of the status model and then clears the register.

The instrument returns a decimal value that corresponds to the binary-weighted sum of all bits set in the register. For details, see [Measurement Instrument Event Register](#) (on page D-18).

Also see

None

:STATus:MEASurement:INSTrument:ENABle

This command sets or reads the contents of the Measurement Instrument Event Enable Register of the status model.

Type	Affected by	Where saved	Default value
Command and query	Power cycle	Not applicable	0

Usage

```
:STATus:MEASurement:INSTrument:ENABle <n>
:STATus:MEASurement:INSTrument:ENABle?
```

[n]	The status of the Measurement Instrument Enable Register.
-----	---

Details

This command sets or reads the contents of the enable register of the Measurement Instrument Event Register.

When one of these bits is set and the corresponding bit in the Measurement Instrument Event Register is set, the ISUM bit in the Measurement Event Register is set.

When sending binary values, preface <n> with #b. When sending hexadecimal values, preface <n> with #h. No preface is needed when sending decimal values.

Example

:STAT:MEAS:INST:ENAB #b0000000000000010	Sets the bit 1 of the Measurement Instrument Enable Register using a binary value. You could also send the decimal value 2 or the hexadecimal value #h2.
---	--

Also see

[Measurement Instrument Event Register](#) (on page D-18)

:STATus:MEASurement:INSTrument:ISUMmary[:EVENT]?

This command reads the Measurement Instrument Summary Event Register of the status model.

Type	Affected by	Where saved	Default value
Query only	Not applicable	Not applicable	Not applicable

Usage

```
:STATus:MEASurement:INSTrument:ISUMmary[:EVENT]?
```

Details

This attribute reads the Measurement Instrument Summary Event Register of the status model and clears the register.

The instrument returns a decimal value that corresponds to the binary-weighted sum of all bits set in the register.

Example

```
:STAT:MEAS:INST:ISUM?
```

Returns the contents of the Measurement Instrument Summary Event Register of the status model.

Also see

[Measurement Instrument Summary Event Register](#) (on page D-19)

:STATus:MEASurement:INSTrument:ISUMmary:ENABLE

This command sets or reads the contents of the Measurement Instrument Summary Enable Register of the status model.

Type	Affected by	Where saved	Default value
Command and query	Power cycle	Not applicable	0

Usage

```
:STATus:MEASurement:INSTrument:ISUMmary:ENABLE <n>
:STATus:MEASurement:INSTrument:ISUMmary:ENABLE?
```

[n]	The status of the Measurement Instrument Summary Enable Register.
-----	---

Details

This command sets or reads the contents of the enable register of the Measurement Instrument Summary Event Register (MISER).

When one of these bits is set and the corresponding bit in the MISER set, bit 1 in the Measurement Instrument Event Register is set.

When sending binary, preface <n> with #b. When sending hexadecimal, preface <n> with #h. No preface is needed when sending decimal values.

Example

:STAT:MEAS:INST:ISUM:ENAB #b0000100000000001	Sets the output and reading overflow bits of the Measurement Instrument Summary Enable register using a binary value. You could also send the decimal value 2049 or the hexadecimal value: #h801.
--	--

Also see

[Measurement Instrument Summary Event Register](#) (on page D-19)

:STATus:MEASurement:INSTrument:ISUMmary:CONDition?

This command reads the Measurement Instrument Summary Condition Register of the status model.

Type	Affected by	Where saved	Default value
Query only	Not applicable	Not applicable	Not applicable

Usage

```
:STATus:MEASurement:INSTrument:ISUMmary:CONDition?
```

Details

This command reads the contents of the Measurement Instrument Summary Condition Register.

For details about interpreting the value of a register, see [Measurement Instrument Summary Event Register](#) (on page D-19).

Example

```
:STAT:MEAS:INST:ISUM:COND?
```

Returns the contents of the Measurement Instrument Summary Condition Register of the status model.

Also see

None

:STATus:OPERation[:EVENT]?

This command reads and clears the Operation Event Register of the status model.

Type	Affected by	Where saved	Default value
Query only	Not applicable	Not applicable	Not applicable

Usage

```
:STATus:OPERation[:EVENT]?
```

Details

This command reads the Operation Event Register of the status model and then clears the register.

The instrument returns a decimal value that corresponds to the binary-weighted sum of all bits set in the register. For details, see [Operation Event Register](#) (on page D-11)

Also see

None

:STATus:OPERation:ENABLE

This command sets or reads the contents of the Operation Event Enable Register of the status model.

Type	Affected by	Where saved	Default value
Command and query	Power cycle	Not applicable	0

Usage

```
:STATus:OPERation:ENABle <n>
```

```
:STATus:OPERation:ENABle?
```

[n]	The status of the operation status register
-----	---

Details

This command sets or reads the contents of the enable register of the Operation Event Register.

When one of these bits is set and the corresponding bit in the Operation Event Register is set, the OSB bit in the Status Byte Register is set.

When sending binary values, preface <n> with #b. When sending hexadecimal values, preface <n> with #h. No preface is needed when sending decimal values.

Example

```
:STAT:OPER:ENAB #b0010000000000000
```

Sets the Operation Status Enable Register using a binary value. You could also send the decimal value 8192 or the hexadecimal value #h2000.

Also see

[Operation Event Register](#) (on page D-11)

:STATus:OPERation:INSTrument[:EVENT]?

This command reads and clears the Operation Instrument Event Register of the status model.

Type	Affected by	Where saved	Default value
Query only	Not applicable	Not applicable	Not applicable

Usage

```
:STATus:OPERation:INSTrument[:EVENT]?
```

Details

This attribute reads the Operation Instrument Event Register of the status model and then clears the register.

The instrument returns a decimal value that corresponds to the binary-weighted sum of all bits set in the register. For details, see [Operation Instrument Event Register](#) (on page D-12).

Also see

None

:STATus:OPERation:INSTrument:ENABLE

This command sets or reads the contents of the Operation Instrument Enable Register of the status model.

Type	Affected by	Where saved	Default value
Command and query	Power cycle	Not applicable	0

Usage

```
:STATus:OPERation:INSTrument:ENABle <n>
:STATus:OPERation:INSTrument:ENABle?
```

[n]	The status of the Operation Instrument Enable Register
-----	--

Details

This command sets or reads the contents of the Enable register of the Operation Instrument Event Register.

When one of these bits is set and the corresponding bit in the Operation Instrument Event Register is set, the ISUM bit in the Operation Event Register is set.

When sending binary values, preface <n> with #b. When sending hexadecimal values, preface <n> with #h. No preface is needed when sending decimal values.

Example

:STAT:OPER:INST:ENAB #b0000000000000010	Sets bit 1 of the Operation Instrument Enable Register using a binary value. You could also send the decimal value 2 or the hexadecimal value #h2.
---	--

Also see

None

:STATus:OPERation:INSTrument:ISUMmary[:EVENT]?

This command reads the Operation Instrument Summary Event Register of the status model.

Type	Affected by	Where saved	Default value
Query only	Not applicable	Not applicable	Not applicable

Usage

```
:STATus:OPERation:INSTrument:ISUMmary[:EVENT]?
```

Details

This attribute reads the Operation Instrument Summary Event Register of the status model and clears the register.

The instrument returns a decimal value that corresponds to the binary-weighted sum of all bits set in the register.

Example

```
:STAT:OPER:INST:ISUM?
```

Returns the contents of the Operation Instrument Summary Event Register of the status model.

Also see

[Operation Instrument Summary Event Register](#) (on page D-13)

:STATus:OPERation:INSTrument:ISUMmary:ENABLE

This command sets or reads the contents of the Operation Instrument Summary Enable Register of the status model.

Type	Affected by	Where saved	Default value
Command and query	Power cycle	Not applicable	0

Usage

```
:STATus:OPERation:INSTrument:ISUMmary:ENABle <n>
:STATus:OPERation:INSTrument:ISUMmary:ENABle?
```

[n]	The status of the Operation Instrument Summary Enable Register
-----	--

Details

This command sets or reads the contents of the enable register of the Operation Instrument Summary Event Register (OISER).

When one of these bits is set and the corresponding bit in the OISER is set, bit 1 in the Operation Instrument Event Register is set.

When sending binary values, preface <n> with #b. When sending hexadecimal values, preface <n> with #h. No preface is needed when sending decimal values.

Example

:STAT:OPER:INST:ISUM:ENAB #b0000000100010000	Sets the filter and measure bits of the Operation Instrument Summary Enable Register using a binary value. You could also send the decimal value 272 or the hexadecimal value #h110
--	---

Also see

[Operation Instrument summary Event Register](#) (on page D-13)

:STATus:OPERation:INSTrument:ISUMmary:CONDition?

This command reads the Operation Instrument Summary Condition Register of the status model.

Type	Affected by	Where saved	Default value
Query only	Not applicable	Not applicable	Not applicable

Usage

```
:STATus:OPERation:INSTrument:ISUMmary:CONDition?
```

Details

This command reads the contents of the Operation Instrument Summary Condition Register.

For details about interpreting the value of a register, see [Operation Instrument Summary Event Register](#) (on page D-13).

Example

```
:STAT:OPER:INST:ISUM:COND?
```

Returns the contents of the Operation Instrument Summary Condition Register of the status model.

Also see

[Operation Instrument Summary Event Register](#) (on page D-13)

:STATus:PRESet

This command resets all the device-dependent enable registers.

Type	Affected by	Where saved	Default value
Command only	Not applicable	Not applicable	Not applicable

Usage

```
:STATus:PRESet
```

Details

Sending this command can reset the bits of the following enable registers to 0:

- Operation Event Enable Register
- Operation Instrument Event Enable Register
- Operation Instrument Summary Event Enable Register
- Measurement Event Enable Register
- Measurement Instrument Event Enable Register
- Measurement Instrument Summary Event Enable Register
- Questionable Event Enable Register
- Questionable Instrument Event Enable Register
- Questionable Instrument Summary Event Enable Register

Example`:STAT:PRES`

Reset all the enable registers to 0.

Also see

None

:STATus:QUESTionable[:EVENT]?

This command reads the Questionable Event Register.

Type	Affected by	Where saved	Default value
Query only	Not applicable	Not applicable	Not applicable

Usage`:STATus:QUESTionable[:EVENT]?`**Details**

This command reads the Questionable Event Register of the status model and then clears the register.

The instrument returns a decimal value that corresponds to the binary-weighted sum of all bits set in the register. For details, see [Questionable Event Register](#) (on page D-14).

Example`:STAT:QUES?`

Returns the contents of Questionable Event Register

Also see

[Questionable Event Register](#) (on page D-14)

:STATus:QUEStionable:ENABle

This command sets or reads the contents of the Questionable Event Enable Register of the status model.

Type	Affected by	Where saved	Default value
Command and query	Power cycle	Not applicable	0

Usage

```
:STATus:QUEStionable:ENABle <n>
:STATus:QUEStionable:ENABle?
```

[n]	The value of the Questionable Status Enable Register
-----	--

Details

This command sets or reads the contents of the enable register of the Questionable Event Register.

When one of these bits is set and the corresponding bit in the Questionable Event Register is set, the QSM bit in the Status Byte Register is set.

When sending binary values, preface <n> with #b. When sending hexadecimal values, preface <n> with #h. No preface is needed when sending decimal values.

Example

:STAT:QUES:ENAB #b00100000000000000	Sets the operation Status Enable Register using a binary value. You could also send the decimal value 8192 or the hexadecimal value #h2000.
-------------------------------------	---

Also see

[Questionable Event Register](#) (on page D-14)

:STATus:QUEStionable:INSTrument[:EVENT]?

This command reads and clears the Questionable Instrument Event Register of the status model.

Type	Affected by	Where saved	Default value
Query only	Not applicable	Not applicable	Not applicable

Usage

```
:STATus:QUEStionable:INSTrument[:EVENT]?
```

Details

This attribute reads the Questionable Instrument Event Register of the status model and then clears the register.

The instrument returns a decimal value that corresponds to the binary-weighted sum of all bits set in the register. For details, see [Questionable Instrument Event Register](#) (on page D-15).

Also see

None

:STATus:QUESTionable:INSTrument:ENABle

This command sets or reads the contents of the Questionable Instrument Event Enable Register of the status model.

Type	Affected by	Where saved	Default value
Command and query	Power cycle	Not applicable	0

Usage

```
:STATus:QUESTionable:INSTrument:ENABle <n>
:STATus:QUESTionable:INSTrument:ENABle?
```

[n]	The status of the Questionable Instrument Event Enable Register
-----	---

Details

This command sets or reads the contents of the enable register of the Questionable Instrument Event Register.

When one of these bits is set and the corresponding bit in the Questionable Instrument Event Register is set, the ISUM bit in the Questionable Event Register is set.

When sending binary values, preface <n> with #b. When sending hexadecimal values, preface <n> with #h. No preface is needed when sending decimal values.

Example

:STAT:QUES:INST:ENAB #b0000000000000010	Sets bit 1 of the Questionable Instrument Event Enable Register using a binary value. You could also send the decimal value 2 or the hexadecimal value #h2.
---	---

Also see

[Questionable Instrument Event Register](#) (on page D-15)

:STATus:QUEStionable:INSTrument:ISUMmary[:EVENT]?

This command reads the Operation Instrument Summary Event Register of the status model.

Type	Affected by	Where saved	Default value
Query only	Not applicable	Not applicable	Not applicable

Usage

```
:STATus:QUEStionable:INSTrument:ISUMmary[:EVENT]?
```

Details

This attribute reads the Questionable Instrument Summary Event Register of the status model and clears the register.

The instrument returns a decimal value that corresponds to the binary-weighted sum of all bits set in the register.

Example

```
:STAT:QUES:INST:ISUM?
```

Returns the contents of the Questionable Instrument Summary Event Register of the status model.

Also see

[Questionable Instrument Summary Event Register](#) (on page D-16)

:STATus:QUEStionable:INSTrument:ISUMmary:ENABLE

This command sets or reads the contents of the Questionable Instrument Summary Event Enable Register of the status model.

Type	Affected by	Where saved	Default value
Command and query	Power cycle	Not applicable	0

Usage

```
:STATus:QUEStionable:INSTrument:ISUMmary:ENABLE <n>
:STATus:QUEStionable:INSTrument:ISUMmary:ENABLE?
```

```
[n]
```

The status of the Questionable Instrument Summary Event Enable Register

Details

This command sets or reads the contents of the enable register of the Questionable Instrument Summary Event Register (QISER).

When one of these bits is set and the corresponding bit in the QISER is set, bit 1 in the Questionable Instrument Event Register is set.

When sending binary values, preface <n> with #b. When sending hexadecimal values, preface <n> with #h. No preface is needed when sending decimal values.

Example

<code>:STAT:QUES:INST:ISUM:ENAB #b00000000000001010</code>	Sets the overvoltage protection (OVP) and constant voltage (CV) bits of the Questionable Instrument Summary Enable Register using a binary value. You could also send the decimal value 10 or the hexadecimal value #hA.
--	--

Also see

[Questionable Instrument summary Event Register](#) (on page D-16)

:STATus:QUEStionable:INSTrument:ISUMmary:CONDition?

This command reads the Questionable Instrument Summary Condition Register of the status model.

Type	Affected by	Where saved	Default value
Query only	Not applicable	Not applicable	Not applicable

Usage

`:STATus:QUEStionable:INSTrument:ISUMmary:CONDition?`

Details

This command reads the contents of the Questionable Instrument Summary Condition Register.

For details about interpreting the value of a register, see [Questionable Instrument Summary Event Register](#) (on page D-16).

Example

<code>:STAT:QUES:INST:ISUM:COND?</code>	Reads the Questionable Instrument Summary Condition Register.
---	---

Also see

None

SYSTEM subsystem

This subsystem contains commands that affect the overall operation of the instrument, such as autozero, beeper, communications, event logs, and time.

:SYSTEM:AZERO[n][:STATE]

This command enables and disables the autozero.

Type	Affected by	Where saved	Default value
Command and query	Recall settings Instrument reset Power cycle	Save settings	1 (ON)

Usage

```
:SYSTEM:AZERO[n] [:STATE] <state>
:SYSTEM:AZERO[n] [:STATE] ?
```

[n]	Channel number: For single-channel instruments, the value is 1
<state>	Disable autozero: OFF or 0 Enable autozero: ON or 1

Details

When autozero is disabled, the reference and internal temperature measurements are not performed. This increases the measurement speed. However, the reference and temperature reference points will eventually drift, resulting in inaccurate readings of the input signal. For details, refer to [Autozero measurements](#) (on page 4-5).

Example

```
:SYST:AZER OFF
```

Disables autozero to increase measurement speed.

Also see

None

:SYSTem:BEEPer:ERRor[:STATe]

This command allows you to turn the beeper on or off.

Type	Affected by	Where saved	Default value
Command and query	Recall settings Instrument reset Power cycle	Save settings	1 (ON)

Usage

```
:SYSTem:BEEPer:ERRor[:STATe] <state>
:SYSTem:BEEPer:ERRor[:STATe]?
```

<state>	Disable the beeper: OFF or 0 Enable the beeper: ON or 1
---------	--

Details

This command enables or disables the beeper for error messages. When enabled, a beep signals that an error has happened.

Example

:SYSTem:BEEPer:ERRor ON	Enable the error beeper.
-------------------------	--------------------------

Also see

[:SYSTem:KCLick](#) (on page 7-119)

:SYSTem:COMMunication:ABORt

This command causes the remote control to transfer to the present interface.

Type	Affected by	Where saved	Default value
Command only	Not applicable	Not applicable	Not applicable

Usage

```
SYSTem:COMMunication:ABORt
```

Details

The instrument supports the following interfaces:

- USB
- LAN
- GPIB
- LXI

Only one interface may be connected at a time. When one interface is active, all the others are blocked.

When this command is sent by one of the interfaces, the present active interface is blocked, and the interface that sends `SYST:COMM:ABOR` becomes active.

NOTE

Before you use this command to get control of the instrument, make sure this interface is unlocked. If the interface is locked, sending `SYST:COMM:ABOR` causes error 511, "Communication not permitted: This interface is locked, send `SYSTem:PASSword:UNLock` with a password to unlock it."

Example

```
:SYSTem:COMMunication:ABORt
```

For example, if the present active interface is USB, send this command through GPIB. After that, GPIB is activated and USB is blocked.

Also see

[:SYSTem:PASSword:MODE](#) (on page 7-122)

[:SYSTem:PASSword:UNLock](#) (on page 7-123)

:SYSTem:COMMunication:LAN:CONFigure

This command specifies the LAN configuration for the instrument.

Type	Affected by	Where saved	Default value
Command and query	Not applicable	Nonvolatile memory	AUTO

Usage

```
:SYSTem:COMMunication:LAN:CONFigure AUTO
:SYSTem:COMMunication:LAN:CONFigure MANual, "<IPaddress>"
:SYSTem:COMMunication:LAN:CONFigure MANual, "<IPaddress>", "<NETmask>"
:SYSTem:COMMunication:LAN:CONFigure MANual, "<IPaddress>", "<NETmask>", "<GATeway>"
:SYSTem:COMMunication:LAN:CONFigure?
```

AUTO	Use automatically configured LAN settings (default)
MANual	Use manually configured LAN settings
<IPaddress>	LAN IP address; must be a string specifying the IP address in dotted decimal notation; required if the mode is set to manual (default "0.0.0.0")
<NETmask>	The LAN subnet mask; must be a string in dotted decimal notation (default "255.255.255.0")
<GATeway>	The LAN default gateway; must be a string in dotted decimal notation (default "0.0.0.0")

Details

This command specifies how the LAN IP address and other LAN settings are assigned. If automatic configuration is selected, the instrument automatically determines the LAN information. When the method is automatic, the instrument first attempts to configure the LAN settings using dynamic host configuration protocol (DHCP). If DHCP fails, it tries dynamic link local addressing (DLLA). If DLLA fails, an error occurs.

If manual is selected, you must define the IP address. You can also assign a subnet mask and a default gateway. The IP address, subnet mask, and default gateway must be formatted in four groups of numbers, each separated by a decimal. If you do not specify a subnet mask or default gateway, the previous settings are used.

The query form of the command returns the present settings in the order shown here:

```
AUTO or MANual, <IPaddress>, <NETmask>, <GATeway>
```

Example

```
:SYST:COMM:LAN:CONF MAN, "192.168.0.1", "255.255.240.0", "192.168.0.3"
:SYST:COMM:LAN:CONF?
```

Set the IP address to be set manually, with the IP address set to 192.168.0.1, the subnet mask to 255.255.240.0, and the gateway address to 192.168.0.3.

Query to verify the settings. The response to the query should be:

```
MANUAL, "192.168.0.1", "255.255.240.0", "192.168.0.3"
```

Also see

[:SYSTem:COMMunication:LAN:MACaddress?](#) (on page 7-115)

:SYSTem:COMMunication:LAN:MACaddress?

This command queries the LAN MAC address.

Type	Affected by	Where saved	Default value
Query only	Not applicable	Not applicable	Not applicable

Usage

```
:SYSTem:COMMunication:LAN:MACaddress?
```

Details

The MAC address is a character string representing the MAC address of the instrument in hexadecimal notation. The string includes colons that separate the address octets.

Example

:SYSTem:COMMunication:LAN:MACaddress?	Returns the MAC address. For example, you might see: 00:60:1A:00:00:57
---------------------------------------	---

Also see

None

:SYSTem:DATE

This command sets the calendar of the instrument.

Type	Affected by	Where saved	Default value
Command and query	Not applicable	Nonvolatile memory	See Details

Usage

```
:SYSTem:DATE <year>, <month>, <day>  
:SYSTem:DATE?
```

<year>	Year: must be more than 1970
<month>	Month: 1 to 12
<day>	Day: 1 to 31

Details

The query command returns the present date in the format:

```
<year>, <month>, <day>
```

Example

:SYST:DATE 2014, 5, 12	Set the system date to May 12, 2014.
------------------------	--------------------------------------

Also see

[:SYSTem:TIME](#) (on page 7-126)

:SYSTem:ERRor?

This command reads the oldest error message from the event log.

Type	Affected by	Where saved	Default value
Query only	Not applicable	Not applicable	Not applicable

Usage

```
:SYSTem:ERRor?
```

Details

As errors occur, they are placed in the error queue. The error queue is a first-in, first-out (FIFO) register that can hold up to 64 messages.

This command returns the next entry from the error queue. Errors are cleared after you read them.

If there are no entries in the error queue, the following message is returned: 0,"No error"

Example

```
:SYST:ERR?
```

Returns information about the next error in the error queue.

Also see

None

:SYSTem:ERRor:CLEar

This command clears the error queue.

Type	Affected by	Where saved	Default value
Command only	Not applicable	Not applicable	Not applicable

Query

```
:SYSTem:ERRor:CLEar
```

Details

This function removes all messages from the error queue.

Also see

[:SYSTem:ERRor:CODE?](#) (on page 7-117)

:SYSTem:ERRor:CODE?

This command reads and clears the oldest error code.

Type	Affected by	Where saved	Default value
Query only	Not applicable	Not applicable	Not applicable

Usage

```
:SYSTem:ERRor:CODE?
```

Details

This command returns the numeric code of the last error in the event log. The error is cleared from the queue after being read. The following command also clears the returned error:

```
:SYSTem:ERRor?
```

Example

```
:SYST:ERR:CODE?
```

Returns the error number of the last error in the error queue.
For example, if error -222, "Parameter data out of range error" occurred, the output is:
-222

Also see

[:SYSTem:ERRor?](#) (on page 7-116)

:SYSTem:ERRor:COUNT?

This command returns the number of errors in the error queue.

Type	Affected by	Where saved	Default value
Query only	Not applicable	Not applicable	Not applicable

Usage

```
:SYSTem:ERRor:COUNT?
```

Details

This returns the number of errors in the error queue. This command does not clear the errors from the error queue.

Example

```
:SYST:ERR:COUN?
```

If there are five errors in the event log, the output is:
5

Also see

None

:SYSTem:EVENTlog:SAVE

This command saves the event log to a file on a USB flash drive.

Type	Affected by	Where saved	Default value
Command only	Not applicable	Not applicable	Not applicable

Usage

```
:SYSTem:EVENTlog:SAVE <fileName>
```

<fileName>	A string that holds the name of the file to be saved
------------	--

Details

This command saves all event log entries since the last clear command to a USB flash drive.

You must insert the USB flash drive before sending this command.

The extension `.csv` is automatically added to the filename.

Example

```
:SYST:EVEN:SAVE "error_log"
```

Saves the error events in the event log to a file on the USB flash drive named <code>error_log.csv</code> .

Also see

[:SYSTem:ERRor:CLEar](#) (on page 7-116)

:SYSTem:GPIB:ADDRESS

This command sets the GPIB address.

Type	Affected by	Where saved	Default value
Command and query	Not applicable	Nonvolatile memory	5

Usage

```
:SYSTem:GPIB:ADDRESS <n>
:SYSTem:GPIB:ADDRESS?
```

[n]	The GPIB address of the instrument (1 to 30)
-----	--

Details

The address can be set to any address value from 1 to 30. However, the address must be unique in the system. It cannot conflict with an address that is assigned to another instrument or to the GPIB controller.

A new GPIB address takes effect when the command to change it is processed. If there are response messages in the output queue when this command is processed, they must be read at the new address.

If command messages are being queued (sent before this command has executed), the new settings may take effect in the middle of a subsequent command message, so care should be exercised when setting this attribute from the GPIB interface.

You should allow sufficient time for the command to be processed before attempting to communicate with the instrument again.

*RST does not affect the GPIB address.

Example

:SYST:GPIB:ADDR 26 :SYST:GPIB:ADDR?	Sets the GPIB address and reads the address. Output: 26
--	---

Also see

[GPIB communication](#) (on page 2-45)

:SYSTem:KCLick

This command allows you to enable or disable the key click sound.

Type	Affected by	Where saved	Default value
Command and query	Recall settings Instrument reset Power cycle	Save settings	0 (OFF)

Usage

```
:SYSTem:KCLick <state>
:SYSTem:KCLick?
```

<state>	Disable the key click sound: OFF or 0 Enable the key click sound: ON or 1
---------	--

Details

This command enables or disables the key click sound. When enabled, any key presses on the front-panel will output a sound signaling that a front-panel key has been pressed.

Example

:SYSTem:KCLick ON	Enable the key clicks.
-------------------	------------------------

Also see

None

:SYSTem:LOCa1

This command takes the instrument out of remote operation and restores the operation of front-panel controls.

Type	Affected by	Where saved	Default value
Command only	Not applicable	Not applicable	Not applicable

Usage

```
:SYSTem:LOCa1
```

Details

When the instrument is in remote operation, all the front-panel keys except the **LOCAL** and **OUTPUT** keys are locked out. When this command is sent, the instrument restores operation of the front-panel controls. However, you can send `SYSTem:LOCa1` to take the instrument out of remote and restore operation of front panel controls.

NOTE

If the trigger source or arm source is set to manual triggering, the **TRIGGER** key is enabled when the instrument is in the remote mode.

Example

```
:SYST:LOC
```

Returns to local mode and you can control the instrument from the front panel.

Also see

[:SYSTem:RWLock](#) (on page 7-125)

:SYSTem:LFRrequency?

This query returns the line frequency that was automatically detected when the instrument was turned on.

Type	Affected by	Where saved	Default value
Query only	Not applicable	Not applicable	Not applicable

Usage

```
:SYSTem:LFRrequency?
```

Details

The instrument automatically detects the power line frequency when the instrument is powered on. Power line frequency can be 50 Hz or 60 Hz.

Example

```
:SYST:LFR? Return the line frequency.
```

Also see

None

:SYSTem:PASSword:LOCK

This command sets a remote interface to lock mode.

Type	Affected by	Where saved	Default value
Command only	Not applicable	Not applicable	admin

Usage

```
:SYSTem:PASSword:LOCK <password>
```

```
<password> The password for remote connection
```

Details

When password protection is enabled, sending this command disables the remote interface. For example, if you send this command through the GPIB interface, GPIB is locked and the instrument ignores all the SCPI commands from the GPIB except the following command:

```
:SYSTem:LOCa1
```

Example

```
:SYST:PASS:LOCK "admin" Disable the current interface
```

Also see

[:SYSTem:PASSword:MODE](#) (on page 7-122)

[:SYSTem:PASSword:NEW](#) (on page 7-122)

[:SYSTem:PASSword:UNLock](#) (on page 7-123)

:SYSTem:PASSword:MODE

This command sets the protection mode for the remote connection.

Type	Affected by	Where saved	Default value
Command only	Power cycle Instrument reset Recall settings	Save settings	NONE

Usage

```
:SYSTem:PASSword:MODE <value>
```

<value>	Enable the password protection: ALL Disable the password protection: NONE
---------	--

Details

When the password protection is set to ALL, you must enter a password when sending the following commands:

- :SYSTem:PASSword:LOCK
- :SYSTem:PASSword:UNLock

Example

```
:SYST:PASS:MODE ALL Enable the password protection.
```

Also see

- [:SYSTem:PASSword:LOCK](#) (on page 7-121)
- [:SYSTem:PASSword:NEW](#) (on page 7-122)
- [:SYSTem:PASSword:UNLock](#) (on page 7-123)

:SYSTem:PASSword:NEW

This command sets a new password for the remote connection.

Type	Affected by	Where saved	Default value
Command only	Not applicable	Nonvolatile memory	admin

Usage

```
:SYSTem:PASSword:NEW <string1>,<string2>
```

<string1>	A string that contains the present password (maximum 8 characters)
<string2>	A string that contains a new password (maximum 8 characters)

Details

When the access to the instrument is set to lock, this is the password that is used to gain access.

The instrument continues to use the old password for all interactions until the command to change it executes. When changing the password, give the instrument time to execute the command before attempting to use the new password.

If you forget the password, you can reset the password to the default. On the front panel, press **MENU**. Under System, select Manage. Select **Password Reset**. In the pop-up window, select **LXI** to reset the password.

Example

```
:SYST:PASS:NEW "admin","123456"
```

Change the password of the instrument to 123456

Also see

[:SYSTem:PASSword:LOCK](#) (on page 7-121)

[:SYSTem:PASSword:MODE](#) (on page 7-122)

[:SYSTem:PASSword:UNLock](#) (on page 7-123)

:SYSTem:PASSword:UNLock

This command enables a remote interface.

Type	Affected by	Where saved	Default value
Command only	Not applicable	Not applicable	admin

Usage

```
:SYSTem:PASSword:UNLock <password>
```

```
<password>
```

The password for remote mode

Details

When a remote interface is locked, sending this command with the correct password will release it. Sending this command with wrong password will cause the error, 509, "System password not correct."

Example

```
:SYST:PASS:UNL "admin"
```

Unlock the present interface used to send this command.

Also see

[:SYSTem:PASSword:LOCK](#) (on page 7-121)

[:SYSTem:PASSword:MODE](#) (on page 7-122)

[:SYSTem:PASSword:NEW](#) (on page 7-122)

:SYSTem:POSetup:STATe

This command enables or disables default setup loading. When it is set to **On**, the power setup loads setup 1 right after it is powered on.

Type	Affected by	Where saved	Default value
Command and query	Not applicable	Nonvolatile memory	0 (OFF)

Usage

```
:SYSTem:POSetup:STATe <state>
:SYSTem:POSetup:STATe?
```

<state>	
	Disable default setup loading: OFF or 0
	Enable default setup loading: ON or 1

Example

```
:SYST:POS:STAT ON
:SYST:POS:STAT?
```

The default setup is configured to load automatically when the instrument is turned on.

Also see

[*SAV](#) (on page 7-7)

:SYSTem:PRESet

This command returns the instrument to the factory default conditions and erases all user data stored in nonvolatile memory.

Type	Affected by	Where saved	Default value
Command only	Not applicable	Not applicable	Not applicable

Usage

```
:SYSTem:PRESet
```

Details

Sending this command will return the instrument to the factory default conditions and erases all user data stored in nonvolatile memory, such as list parameter and setup information.

NOTE

This command does not influence the status structure registers and error queue.

This command resets GPIB address and IP address to default settings. After sending this command, make sure to use the new address to communicate with the instrument.

You should allow ample time for the command to be processed before attempting to communicate with the instrument again.

Example

```
:SYST:PRES
```

Set the instrument to restore the factory default settings and erase all user data stored in nonvolatile memory, such as list parameter and setup information.

Also see

[*RST](#) (on page 7-7)

[Reset default values](#) (on page 2-88)

:SYSTem:RWLock

This command locks out front-panel controls.

Type	Affected by	Where saved	Default value
Command only	Not applicable	Not applicable	Not applicable

Usage

```
:SYSTem:RWLock
```

Details

When this command is sent, all of the front-panel keys are disabled. The instrument can only be controlled using the remote interface.

Example

```
:SYST:RWLock
```

Disables all of the front-panel keys.

Also see

[:SYSTem:LOCal](#) (on page 7-120)

:SYSTem:TIME

This command sets the absolute time of the instrument.

Type	Affected by	Where saved	Default value
Command and query	Not applicable	Nonvolatile memory	See Details

Usage

```
:SYSTem:TIME <hour>, <minute>, <second>
:SYSTem:TIME?
```

<hour>	Hour in 24-hour time format: 0 to 23
<minute>	Minute: 0 to 60
<second>	Second: 0 to 60

Details

The query command returns the present timestamp in the format:

```
<hour>,<minute>,<second>
```

Example

```
:SYST:TIME 5, 51, 30 Set the system time to 05:51:30.
```

Also see

[:SYSTem:DATE](#) (on page 7-115)

:SYSTem:VERSion?

This command queries the present SCPI standard version.

Type	Affected by	Where saved	Default value
Query only	Not applicable	Not applicable	Not applicable

Usage

```
:SYSTem:VERSion?
```

Details

This query command returns the SCPI standard version.

Example

```
:SYST:VERS? Query the version. Example output:
1999.0
```

Also see

None

TRACe subsystem

The TRACe subsystem contains commands that control the reading buffer.

:DATA[n]:CLEAr

This command clears all readings in the buffer.

Type	Affected by	Where saved	Default value
Command only	Not applicable	Not applicable	Not applicable

Usage

```
:DATA[n]:CLEAr
```

[n]	Channel number: For single-channel instruments, the value is 1
-----	--

Example

:DATA:CLE	Clear the data buffer.
-----------	------------------------

Also see

[Clearing buffer](#) (on page 3-18)

:DATA[n]:CLEAr:AUTO

This command enables or disables the autoclear feature for the buffer.

Type	Affected by	Where saved	Default value
Command and query	Power cycle	Not applicable	1 (ON)

Usage

```
:DATA[n]:CLEAr:AUTO <state>
```

```
:DATA[n]:CLEAr:AUTO?
```

[n]	Channel number: For single-channel instruments, the value is 1
<state>	Enable autoclear: ON or 1 Disable autoclear: OFF or 0

Details

With autoclear enabled, the buffer will automatically clear when the storage process starts. When disabled, readings will append to old readings in the buffer until the buffer becomes full (2,500 readings) or the storage process is stopped.

Example

```
:DATA:CLE:AUTO ON
```

```
Enable autoclear for the buffer.
```

Also see

[Clearing buffer](#) (on page 3-18)

:DATA[n]:DATA?

This query command returns all the readings from the buffer.

Type	Affected by	Where saved	Default value
Query only	Recall settings Instrument reset Power cycle	Not applicable	Not applicable

Usage

```
:DATA[n]:DATA? [<bufferElements>]
```

[n]	Channel number: For single-channel instruments, the value is 1
<bufferElements>	A list of elements in the buffer to print; if nothing is specified, defaults are READING, SOURCE, UNIT, and RELATIVE; see Details for a list of options.

Details

Use `DATA:DATA?` to retrieve all readings that are stored in the buffer. You can send this command even if the instrument is still storing readings. When `DATA:DATA?` is sent, it will return the readings stored up to that point in time. Subsequent `DATA:DATA?` commands will not retrieve readings already returned. However, once the buffer has been fully filled, you can retrieve all the stored readings again by sending this command. For example, if `DATA:DATA? "READ, SOURCE"` is sent, the subsequent `DATA:DATA? "MODE"` command will not return mode information. You can get additional buffer data by sending the command `DATA:DATA:SELEcted?`.

When specifying buffer elements, you can:

- Specify buffer elements in any order.
- Include up to 10 elements in a single list.
- Repeat elements as long as the number of elements in the list is less than 10.
- Use a comma to delineate multiple elements for a data point.
- Use single or double quotes to enclose all the elements.

The options for <bufferElements> are described in the following table.

Option	Description	Example
READing	The measurement reading based on the measurement function.	+8.034562E-03
SOURce	The source value.	+4.566723E+01
UNIT	The unit of measure reading, source value, and timestamp.	V, A, and s
MODE	The output state.	CC, CV or OFF
DATE	The date for the data point.	07/01/2013
TIME	The time for the data point.	19:21:36.2556
TSTamp	The timestamp for the data point.	07/01/2013 19:21:36.2556
RELative	The relative time when the data point was measured, formatted in seconds.	+4.430876E+00s
RSTamp	The relative time when the data point was measured.	12:23:32.2349
RNUMber	The reading number indicates the point index in the trace buffer.	0001

NOTE

The RELative and RSTamp elements are defined as the time since the first reading was stored in the buffer. These values are reset every 24-hours. The DATE, TIME, and TSTamp elements represent absolute time from the internal real-time clock (RTC).

Example

```
:DATA:DATA? "READ,SOUR,REL"
```

Return the measurement value, source value, and the relative time.

Output:

```
+1.000000E+00,+1.779709E-03,  
+0.000000E+00,+1.000000E+00,  
+1.735228E-03,+6.100000E-02
```

Also see

None

:DATA[n]:DATA:SElected?

This query command returns specified data elements in the buffer.

Type	Affected by	Where saved	Default value
Query only	Recall settings Instrument reset Power cycle	Not applicable	Not applicable

Usage

```
:DATA[n]:DATA:SElected? <start>, <end>[,<bufferElements>]
```

[n]	Channel number: For single-channel instruments, the value is 1
<start>	Beginning index of the buffer to return: 1 to 2500
<end>	Ending index of the buffer to return: 1 to 2500
<bufferElements>	A list of elements in the buffer to print; if nothing is specified, defaults are READING, SOURce, UNIT, and RELative; see Details for a list of options

Details

The <start> parameter specifies the first stored reading to return.

NOTE

The first stored reading in the buffer is 1. The <end> parameter specifies the last of the readings to return.

When specifying buffer elements, you can:

- Specify buffer elements in any order.
- Repeat elements as long as the number of elements in the list is less than 10.
- Use a comma to delineate multiple elements for a data point.
- Use single or double quotes to enclose all the elements.

NOTE

For large buffers, you can get the data in 100-point increments. For example, if the data point is 250, `DATA:DATA:SElected 1,100,"READ, SOURce"` command will return the first 100 readings and source values from the buffer. If additional buffer element data is required, such as the CV or CC status, sending the command `DATA:DATA:SElected? 1,100,"MODE"` can get the output status.

The options for <bufferElements> are described in the following table.

Option	Description	Example
READing	The measurement reading based on the SENS:FUNC setting.	+8.034562E-03
SOURce	The source value.	+4.566723E+01
UNIT	The unit of measure reading, source value, and timestamp	V, A, and s
MODE	The output state.	CC, CV or OFF
DATE	The date for the data point.	07/01/2013
TIME	The time for the data point.	19:21:36.2556
TSTamp	The timestamp for the data point.	07/01/2013 19:21:36.2556
RELative	The relative time when the data point was measured, formatted in seconds.	+4.430876E+00s
RSTamp	The relative timestamp when the data point was measured.	12:23:32.2345
RNUMBER	The reading number indicates the point index in the trace buffer.	0001

NOTE

The RELative and RSTamp elements are defined as the time since the first reading was stored in the buffer. These values are reset every 24-hours. The DATE, TIME, and TSTamp elements represent absolute time from the internal real-time clock (RTC).

Example

```
:TRAC:DATA:SEL? 1, 99, "READ,SOUR,REL"
```

Return buffer readings 1 through 99 with the measurement value, source value, and the relative time.

Also see

None

:DATA[n]:FEED

This command selects the source of readings.

Type	Affected by	Where saved	Default value
Command and query	Recall settings Instrument reset Power cycle	Save settings	SENS

Usage

```
:DATA[n]:FEED <name>
:DATA[n]:FEED?
```

[n]	Channel number: For single-channel instruments, the value is 1
<name>	Select the source of readings: <ul style="list-style-type: none"> ▪ Store the readings before the math calculation: SENSE ▪ Store the readings after the math calculation: CALCulate

Details

When you select SENSE for the source, the readings stored in the trace buffer do not have a math calculation even if the math state is ON. For details about data flow, refer to [Displayed measurements](#) (on page 4-15).

Example

:DATA:FEED SENSE :DATA:FEED?	Set the source of readings to SENSE and query the source. Output is: SENS
---------------------------------	---

Also see

None

:DATA[n]:FEED:CONTRol

This command determines if a reading buffer is filled continuously or is filled once and stops.

Type	Affected by	Where saved	Default value
Command and query	Recall settings Instrument reset Power cycle	Save settings	ALW

Usage

```
:DATA[n]:FEED:CONTRol <name>
:DATA[n]:FEED:CONTRol?
```

[n]	Channel number: For single-channel instruments, the value is 1
<name>	Buffer control: <ul style="list-style-type: none"> ▪ Fill once: <i>NEXT</i>. After the specified number of readings (buffer size) is stored, buffer operation is disabled. ▪ Fill continuous: <i>ALWays</i>. After the specified number of readings is stored, operation wraps back to the first buffer location and overwrites the previous readings ▪ No measurements to fill the buffer: <i>NEVer</i>.

Details

Use this command to set and read the fill mode of the reading buffer.

When a reading buffer is set to *NEXT*, no data is overwritten in the buffer. When the buffer is filled, no more data is stored in that buffer and new readings are discarded.

When a reading buffer is set to *ALWays*, the oldest data is overwritten by the newest data after the buffer fills.

Example

<pre>:DATA:FEED:CONT ALWays :DATA:FEED:CONT?</pre>	Set the buffer mode to always and query the mode. Output is: <i>ALW</i>
--	--

Also see

None

:DATA[n]:POINTS

This command contains the number of readings a buffer can store.

Type	Affected by	Where saved	Default value
Command and query	Recall settings Instrument reset Power cycle	Save settings	100

Usage

```
:DATA[n]:POINTS <newSize>
:DATA[n]:POINTS?
:DATA[n]:POINTS? DEFault
:DATA[n]:POINTS? MINimum
:DATA[n]:POINTS? MAXimum
```

[n]	Channel number: For single-channel instruments, the value is 1
<newSize>	The new size for the buffer: 2 to 2500

Details

Use this command to read the number of measurements that a buffer can store.

Example

:DATA:POIN?	Query the capacity of the buffer. Output: 1000
-------------	--

Also see

None

:DATA[n]:POINTS:ACTual?

This command queries the number of readings presently stored in the buffer.

Type	Affected by	Where saved	Default value
Query only	Instrument reset Power cycle	Not applicable	Not applicable

Usage

```
:DATA[n]:POINTS:ACTual?
```

[n]	Channel number: For single-channel instruments, the value is 1
-----	--

Example

:DATA:POIN:ACT?	Query the number of stored reading in the buffer. Output: 200
-----------------	---

Also see

None

:TRACe[n]:CLEAr

This command clears all readings in the buffer.

Type	Affected by	Where saved	Default value
Command only	Not applicable	Not applicable	Not applicable

Usage

```
:TRACe[n]:CLEAr
```

[n]	Channel number: For single-channel instruments, the value is 1
-----	--

Example

:TRAC:CLE	Clear the data buffer.
-----------	------------------------

Also see

[Clearing buffer](#) (on page 3-18)

:TRACe[n]:CLEAr:AUTO

This command enables or disables the autoclear feature for the buffer.

Type	Affected by	Where saved	Default value
Command and query	Power cycle	Not applicable	1 (ON)

Usage

```
:TRACe[n]:CLEAr:AUTO <state>  
:TRACe[n]:CLEAr:AUTO?
```

[n]	Channel number: For single-channel instruments, the value is 1
<state>	Enable autoclear: ON or 1 Disable autoclear: OFF or 0

Details

With autoclear enabled, the buffer will automatically clear when the storage process starts. When disabled, readings will append to old readings in the buffer until the buffer becomes full (2,500 readings) or the storage process is stopped.

Example

:TRAC:CLE:AUTO ON	Enable autoclear for the buffer.
-------------------	----------------------------------

Also see

[Clearing buffer](#) (on page 3-18)

:TRACe[n]:DATA?

This query command returns all the readings from the buffer.

Type	Affected by	Where saved	Default value
Query only	Recall settings Instrument reset Power cycle	Not applicable	Not applicable

Usage

```
:TRACe[n]:DATA? [<bufferElements>]
```

[n]	Channel number: For single-channel instruments, the value is 1
<bufferElements>	A list of elements in the buffer to print; if nothing is specified, defaults are READING, SOURce, UNIT, and RELative; see Details for a list of options

Details

Use `TRACe:DATA?` to retrieve all readings that are stored in the buffer. You can send this command even if the instrument is still storing readings. When `TRACe:DATA?` is sent, it will return the readings stored up to that point in time. Subsequent `TRACe:DATA?` commands will not retrieve readings already returned. However, once the buffer has been fully filled, you can retrieve all the stored readings again by sending this command. For example, if `TRACe:DATA? "READ, SOURce"` is sent, the subsequent `TRACe:DATA? "MODE"` command will not return mode information. You can get additional buffer data by sending the command `TRACe:DATA:SElected?`.

When specifying buffer elements, you can:

- Specify buffer elements in any order.
- Include up to 10 elements in a single list.
- Repeat elements as long as the number of elements in the list is less than 10.
- Use a comma to delineate multiple elements for a data point.
- Use single or double quotes to enclose all the elements.

The options for `<bufferElements>` are described in the following table.

Option	Description	Example
READing	The measurement reading based on the measurement function.	+8.034562E-03
SOURce	The source value.	+4.566723E+01
UNIT	The unit of measure reading, source value, and timestamp.	V, A, and s
MODE	The output state.	CC, CV or OFF
DATE	The date for the data point.	07/01/2013
TIME	The time for the data point.	19:21:36.2556
TSTamp	The timestamp for the data point.	07/01/2013 19:21:36.2556
RELative	The relative time when the data point was measured, formatted in seconds.	+4.430876E+00s
RSTamp	The relative time when the data point was measured.	12:23:32.2349
RNUMber	The reading number indicates the point index in the trace buffer.	0001

NOTE

The RELative and RSTamp elements are defined as the time since the first reading was stored in the buffer. These values are reset every 24-hours. The DATE, TIME, and TSTamp elements represent absolute time from the internal real-time clock (RTC).

Example

:TRACe:DATA? "READ,SOUR,REL"	Return the measurement value, source value, and the relative time. Output: +1.000000E+00,+1.779709E-03,+0.000000E+00,+1.000000E+00,+1.735228E-03,+6.100000E-02
------------------------------	--

Also see

None

:TRACe[n]:DATA:SElected?

This query command returns specified data elements in the buffer.

Type	Affected by	Where saved	Default value
Query only	Recall settings Instrument reset Power cycle	Not applicable	Not applicable

Usage

```
:TRACe[n]:DATA:SElected? <start>, <end>[, <bufferElements>]
```

[n]	Channel number: For single-channel instruments, the value is 1
<start>	Beginning index of the buffer to return: 1 to 2500
<end>	Ending index of the buffer to return: 1 to 2500
<bufferElements>	A list of elements in the buffer to print; if nothing is specified, defaults are READING, SOURce, UNIT, and RELative; see Details for a list of options

Details

The <start> parameter specifies the first stored reading to return.

NOTE

The first stored reading in the buffer is 1. The <end> parameter specifies the last of the readings to return.

When specifying buffer elements, you can:

- Specify buffer elements in any order.
- Repeat elements as long as the number of elements in the list is less than 10.
- Use a comma to delineate multiple elements for a data point.
- Use single or double quotes to enclose all the elements.

NOTE

For large buffers, you can get the data in 100-point increments. For example, if the data point is 250, `TRACe:DATA:SElected 1,100,"READ, SOURce"` command will return the first 100 readings and source values from the buffer. If additional buffer element data is required, such as the CV or CC status, sending the command `TRACe:DATA:SElected? 1,100,"MODE"` can get the output status.

The options for <bufferElements> are described in the following table.

Option	Description	Example
READing	The measurement reading based on the SENS:FUNC setting.	+8.034562E-03
SOURce	The source value.	+4.566723E+01
UNIT	The unit of measure reading, source value, and timestamp	V, A, and s
MODE	The output state.	CC, CV or OFF
DATE	The date for the data point.	07/01/2013
TIME	The time for the data point.	19:21:36.2556
TSTamp	The timestamp for the data point.	07/01/2013 19:21:36.2556
RELative	The relative time when the data point was measured, formatted in seconds.	+4.430876E+00s
RSTamp	The relative timestamp when the data point was measured.	12:23:32.2345
RNUMber	The reading number indicates the point index in the trace buffer.	0001

NOTE

The RELative and RSTamp elements are defined as the time since the first reading was stored in the buffer. These values are reset every 24-hours. The DATE, TIME, and TSTamp elements represent absolute time from the internal real-time clock (RTC).

Example

```
:TRAC:DATA:SEL? 1, 99, "READ,SOUR,REL"
```

Return buffer readings 1 through 99 with the measurement value, source value, and the relative time.

Also see

None

:TRACe[n]:FEED

This command selects the source of readings.

Type	Affected by	Where saved	Default value
Command and query	Recall settings Instrument reset Power cycle	Save settings	SENS

Usage

```
:TRACe[n]:FEED <name>
:TRACe[n]:FEED?
```

[n]	Channel number: For single-channel instruments, the value is 1
<name>	Select the source of readings: <ul style="list-style-type: none"> ▪ Store the readings before the math calculation: SENSE ▪ Store the readings after the math calculation: CALCulate

Details

When you select SENSE for the source, the readings stored in the trace buffer do not have a math calculation even if the math state is ON. For details about data flow, refer to [Displayed measurements](#) (on page 4-15).

Example

:TRACe:FEED SENS :TRACe:FEED?	Set the source of readings to SENSE and query the source. Output is: SENS
----------------------------------	---

Also see

None

:TRACe[n]:FEED:CONTRol

This command determines if a reading buffer is filled continuously or is filled once and stops.

Type	Affected by	Where saved	Default value
Command and query	Recall settings Instrument reset Power cycle	Save settings	ALW

Usage

```
:TRACe[n]:FEED:CONTRol <name>
:TRACe[n]:FEED:CONTRol?
```

[n]	Channel number: For single-channel instruments, the value is 1
<name>	Buffer control: <ul style="list-style-type: none"> ▪ Fill once: <i>NEXT</i>; after the specified number of readings (buffer size) are stored, buffer operation is disabled ▪ Fill continuous: <i>ALWAYS</i>; after the specified number of readings are stored, operation wraps back to the first buffer location and overwrites the previous readings ▪ No measurements to fill the buffer: <i>NEVER</i>

Details

Use this command to set and read the fill mode of the reading buffer.

When a reading buffer is set to *NEXT*, no data is overwritten in the buffer. When the buffer is filled, no more data is stored in that buffer and new readings are discarded.

When a reading buffer is set to *ALWAYS*, the oldest data is overwritten by the newest data after the buffer fills.

Example

<pre>:TRACe:FEED:CONT ALW :TRACe:FEED:CONT?</pre>	Set the buffer mode to always and query the mode. Output is: <i>ALW</i>
---	--

Also see

None

:TRACe[n]:POINTs

This command contains the number of readings a buffer can store.

Type	Affected by	Where saved	Default value
Command and query	Recall settings Instrument reset Power cycle	Save settings	100

Usage

```
:TRACe[n]:POINTs <newSize>
:TRACe[n]:POINTs?
:TRACe[n]:POINTs? DEFault
:TRACe[n]:POINTs? MINimum
:TRACe[n]:POINTs? MAXimum
```

[n]	Channel number: For single-channel instruments, the value is 1
<newSize>	The new size for the buffer: 2 to 2500

Details

Use this command to read the number of measurements that a buffer can store.

Example

:TRAC:POIN?	Query the capacity of the buffer. Output: 1000
-------------	--

Also see

None

:TRACe[n]:POINTs:ACTual?

This command queries the number of readings presently stored in the buffer.

Type	Affected by	Where saved	Default value
Query only	Instrument reset Power cycle	Not applicable	Not applicable

Usage

```
:TRACe[n]:POINTs:ACTual?
```

[n]	Channel number: For single-channel instruments, the value is 1
-----	--

Example

:TRAC:POIN:ACT?	Query the number of stored reading in the buffer. Output: 200
-----------------	---

Also see

None

:TRACe[n]:SAVE

This command saves data from the specified reading buffer to a USB flash drive.

Type	Affected by	Where saved	Default value
Command only	Not applicable	Not applicable	Not applicable

Usage

```
:TRACe[n]:SAVE <fileName>
:TRACe[n]:SAVE <fileName>, <timeFormat>
:TRACe[n]:SAVE <fileName>, <timeFormat>, <start>, <end>
```

[n]	Channel number: For single-channel instruments, the value is 1
<fileName>	A string that indicates the name of the file on the USB flash drive in which to save the reading buffer
<timeFormat>	Defines which information is saved in the file on the USB flash drive: <ul style="list-style-type: none"> ▪ Dates, times, and fractional seconds are saved; the default value: TSTamp ▪ Relative time stamps (in seconds) are saved: RELative ▪ Relative time stamps are saved: RSTamp For details about time format, see :TRACe[n]:DATA? (on page 7-136)
<start>	Defines the starting point in the buffer to start saving data
<end>	Defines the ending point in the buffer to stop saving data

Details

For options that save more than one item of time information, each item is comma-delimited. For example, the default format is date, time, and fractional seconds for each reading.

Example

```
:TRAC:SAVE "myData"
:TRAC:SAVE "myDataRel", REL
:TRAC:SAVE "myDataRel100", REL, 1, 100
```

Save all readings and default time information to a file named `myData.csv` on the USB flash drive.
 Save all readings and relative time stamps to a file named `myDataRel.csv` on the USB flash drive.
 Save the buffer readings from 1 through 100 to a file named `myDataRel100.csv` on the USB flash drive.

Also see

None

:TRACe[n]:TRIGger:CURRent:DIRection

This command specifies whether the current rises above or falls below a specified level when the level trigger is activated.

Type	Affected by	Where saved	Default value
Command and query	Power cycle	Not applicable	RISE

Usage

```
:TRACe[n]:TRIGger:CURRent:DIRection <direction>
:TRACe[n]:TRIGger:CURRent:DIRection?
```

<direction>	The direction can be RISE or FALL
-------------	-----------------------------------

Example

TRAC:TRIG:CURR:DIR RISE TRAC:TRIG:CURR:DIR?	The level trigger will be activated when the current rises above the preset threshold value.
--	--

Also see

[:TRACe\[n\]:TRIGger:CURRent:STATe](#) (on page 7-145)

[:TRACe\[n\]:TRIGger:CURRent\[:LEVel\]](#) (on page 7-144)

:TRACe[n]:TRIGger:CURRent[:LEVel]

This command configures the current threshold value for the level trigger.

Type	Affected by	Where saved	Default value
Command and query	Power cycle	Not applicable	0

Usage

```
:TRACe[n]:TRIGger:CURRent[:LEVel] <current threshold>
:TRACe[n]:TRIGger:CURRent[:LEVel]?
```

<currentthreshold>	<p>The value of this parameter depends on the trace feed and relative status:</p> <ul style="list-style-type: none"> ▪ If TRACe:FEED is CALC, the current threshold ranges from -1.0E7 to 1.0E7 ▪ If TRACe:FEED is SENSE and Relative is off, the current threshold is from 0 to 3.3 for Model 2280S-60-3, and from 0 to 6.1 for Model 2280S-32-6 ▪ If TRACe:FEED is SENSE and Relative is on, the current threshold is from -3.3 to 6.6 for Model 2280S-60-3, and from -6.1 to 12.2 for Model 2280S-32--6.
--------------------	--

Example

```
TRAC:TRIG:CURR 1
TRAC:TRIG:CURR?
```

The current threshold value is set to 1.

Also see

[:TRACe\[n\]:TRIGger:CURRent:STATe](#) (on page 7-145)

[:TRACe\[n\]:TRIGger:CURRent:DIRectioN](#) (on page 7-144)

:TRACe[n]:TRIGger:CURRent:STATe

This command determines whether the current level trigger function is enabled.

Type	Affected by	Where saved	Default value
Command and query	Power cycle	Not applicable	0 (OFF)

Usage

```
:TRACe[n]:TRIGger:CURRent:STATe <state>
:TRACe[n]:TRIGger:CURRent:STATe?
```

<state>

ON or 1: Enable the current level trigger function

OFF or 0: Disable the current level trigger function

Example

```
TRAC:TRIG:CURR:STAT 1
TRAC:TRIG:CURR:STAT?3
```

The current level trigger function is enabled.

Also see

[:TRACe\[n\]:TRIGger:CURRent\[:LEVel\]](#) (on page 7-144)

[:TRACe\[n\]:TRIGger:CURRent:DIRectioN](#) (on page 7-144)

:TRACe[n]:TRIGger:OCCur?

This command queries whether a level trigger has occurred.

Type	Affected by	Where saved	Default value
Query only	Not applicable	Not applicable	Not applicable

Usage

```
:TRACe[n]:TRIGger:OCCur?
```

Example

<pre>TRAC:TRIG:OCC?</pre>	<p>Queries whether a level trigger has occurred.</p> <p>If a level trigger has occurred, the value of 1 will be returned.</p>
---------------------------	---

Also see

None

:TRACe[n]:TRIGger:OFFSet

This command defines the number of points at which the instrument begins to log data in the buffer.

Type	Affected by	Where saved	Default value
Command and query	Power cycle	Not applicable	0

Usage

```
:TRACe[n]:TRIGger:OFFSet <value>
:TRACe[n]:TRIGger:OFFSet?
```

<code><value></code>	From 0 to 100
----------------------------	---------------

Example

<pre>TRAC:TRIG:OFFS 10 TRAC:TRIG:OFFS?</pre>	<p>10 points before the level trigger activation are not cleared.</p>
--	---

Also see

None

:TRACe[n]:TRIGger:VOLTage:DIRection

This command specifies whether the voltage rises above or falls below a specified level when the level trigger is activated.

Type	Affected by	Where saved	Default value
Command and query	Power cycle	Not applicable	RISE

Usage

```
:TRACe[n]:TRIGger:VOLTage:DIRection <direction>
:TRACe[n]:TRIGger:VOLTage:DIRection?
```

<direction>	The direction can be RISE or FALL
-------------	-----------------------------------

Example

TRAC:TRIG:VOLT:DIR RISE TRAC:TRIG:VOLT:DIR?	The level trigger will be activated when the voltage rises above the preset threshold value.
--	--

Also see

- [:TRACe\[n\]:TRIGger:VOLTage:STATe](#) (on page 7-148)
- [:TRACe\[n\]:TRIGger:VOLTage\[:LEVel\]](#) (on page 7-147)

:TRACe[n]:TRIGger:VOLTage[:LEVel]

This command configures the voltage threshold for the level trigger.

Type	Affected by	Where saved	Default value
Command and query	Power cycle	Not applicable	0

Usage

```
:TRACe[n]:TRIGger:VOLTage[:LEVel] <voltage threshold>
:TRACe[n]:TRIGger:VOLTage[:LEVel]?
```

<voltage threshold>	<p>The value of this parameter depends on the trace feed and relative status:</p> <ul style="list-style-type: none"> If TRACe:FEED is CALC, the voltage threshold ranges from -1.0E8 to 1.0E8 If TRACe:FEED is SENSE and Relative is off, the voltage threshold is from 0 to 60 for Model 2280S-60-3, and from 0 to 32 for Model 2280S-32-6 If TRACe:FEED is SENSE and Relative is on, the voltage threshold is from -60 to 120 for Model 2280S-60-3, and from -32 to 64 for Model 2280S-32-6
---------------------	--

Example

```
TRAC:TRIG:VOLT 20
TRAC:TRIG:VOLT?
```

The value of the voltage threshold is set to 20.

Also see

[:TRACe\[n\]:TRIGger:VOLTage:STATe](#) (on page 7-148)

[:TRACe\[n\]:TRIGger:VOLTage:DIRection](#) (on page 7-147)

:TRACe[n]:TRIGger:VOLTage:STATe

This command determines whether the voltage level trigger function is enabled.

Type	Affected by	Where saved	Default value
Command and query	Power cycle	Not applicable	0 (OFF)

Usage

```
:TRACe[n]:TRIGger:VOLTage:STATe <state>
:TRACe[n]:TRIGger:VOLTage:STATe?
```

<state>

ON or 1: Enable the voltage level trigger function
OFF or 0: Disable the voltage level trigger function

Example

```
TRAC:TRIG:VOLT:STAT 1
TRAC:TRIG:VOLT:STAT?
```

The voltage level trigger function is enabled.

Also see

[:TRACe\[n\]:TRIGger:VOLTage\[:LEVel\]](#)

[:TRACe\[n\]:TRIGger:VOLTage:DIRection](#) (on page 7-147)

TRIGger subsystem

The commands in this subsystem configure and control the trigger model for trigger layer.

:TRIGger[:SEQuence[n]]:COUNT

This command sets the number of times to repeat the trigger event.

Type	Affected by	Where saved	Default value
Command and query	Recall settings Instrument reset Power cycle	Save settings	1

Usage

```
:TRIGger[:SEQuence[n]]:COUNT <count>
:TRIGger[:SEQuence[n]]:COUNT?
:TRIGger[:SEQuence[n]]:COUNT? DEFault
:TRIGger[:SEQuence[n]]:COUNT? MINimum
:TRIGger[:SEQuence[n]]:COUNT? MAXimum
```

[n]	Channel number: For single-channel instruments, the value is 1
<count>	The number of times to repeat the trigger: 1 to 2500

Example

```
:TRIG:COUN 4 Set the trigger count to four.
```

Also see

[:ARM\[:SEQuence\[n\]\]:COUNT](#) (on page 7-19)

[Trigger model](#) (on page 3-25)

:TRIGger[:SEQuence[n]]:SAMPle:COUNT

This command sets the number of measurement per trigger event.

Type	Affected by	Where saved	Default value
Command and query	Recall settings Instrument reset Power cycle	Save settings	1

Usage

```
:TRIGger[:SEQuence[n]]:SAMPle:COUNT <count>
:TRIGger[:SEQuence[n]]:SAMPle:COUNT?
:TRIGger[:SEQuence[n]]:SAMPle:COUNT? DEFault
:TRIGger[:SEQuence[n]]:SAMPle:COUNT? MINimum
:TRIGger[:SEQuence[n]]:SAMPle:COUNT? MAXimum
```

[n]	Channel number: For single-channel instruments, the value is 1
<count>	The number of measurements: 1 to 2500

Details

This command sets the number of measurement per trigger event. For details, refer to [Trigger model](#) (on page 3-25).

Example

:TRIG:SAMP:COUNT 10	Set the sample count to 10.
---------------------	-----------------------------

Also see

[Trigger model](#) (on page 3-25)

:TRIGger[:SEQuence[n]]:SOURce

This command selects the control source for trigger layer.

Type	Affected by	Where saved	Default value
Command and query	Recall settings Instrument reset Power cycle	Save settings	IMM

Usage

```
:TRIGger[:SEQuence[n]]:SOURce <source>
:TRIGger[:SEQuence[n]]:SOURce?
```

[n]	Channel number: For single-channel instruments, the value is 1
<source>	The trigger source for trigger layer: <ul style="list-style-type: none"> ▪ Immediate triggering: IMMEDIATE; no delay or gating in the detection layer ▪ External triggering: EXTERNAL ▪ Manual triggering: MANUAL; the trigger signal is generated by pressing the TRIGGER key

Example

:TRIG:SOUR EXT	Select external triggering as the trigger source.
----------------	---

Also see

- [:ARM\[:SEQuence\[n\]\]:SOURce](#) (on page 7-20)
- [Trigger model](#) (on page 3-25)

Troubleshooting guide

In this section:

Introduction	8-1
Contacting support.....	8-1
What to do if the power supply does not turn on	8-2
LAN troubleshooting suggestions	8-3
Error summary	8-3

Introduction

This section includes troubleshooting information on the Keithley Instruments Series 2280 Precision DC Power Supply, including a complete listing of error messages and troubleshooting suggestions.

Contacting support

If you have any questions after reviewing this information, please contact your local Keithley Instruments representative or call Keithley Instruments corporate headquarters (toll-free inside the U.S. and Canada only) at 800-935-5595, or from outside the U.S. at +1-440-248-0400. For worldwide contact numbers, visit the [Keithley Instruments website \(tek.com/keithley\)](http://tek.com/keithley).

When contacting Keithley, please have ready:

- The serial number of the instrument.
- The firmware revision of the instrument.
- The model and firmware revision of all installed cards.

When you call, have the information available, and, if possible, be near the instrument.

What to do if the power supply does not turn on

To solve problems you might encounter when turning on the instrument, follow these steps:

1. Verify that there is AC power to the power supply.

Check that the AC power cord is firmly plugged into the power connector on the rear panel of the power supply. You should also make sure that the AC power source you plugged the power supply into is energized. Then, check that the power supply is turned on.

2. Verify the power-line voltage settings.

Check that the line voltage selector switch on the rear panel is set to the proper value for your country (100 VAC/120 VAC or 220 VAC/ 240 VAC). Change the voltage setting if it is not correct.

NOTE

Under certain circumstances, powering the instrument from a mains voltage for which it is not configured can cause the mains fuse to be damaged.

3. Verify that the correct power-line fuse is installed.
 - If the fuse is damaged, replace the fuse for your power supply.
 - If you set the line selection to 100 V and 120 V, use a 5 A, time delay 250 V fuse.
 - If you set the line selection to 220 V and 240 V, use a 2.5 A, time delay 250 V fuse.
4. If you need more help, see [Additional Series 2280 information](#) (on page 9-1).

LAN troubleshooting suggestions

If you are unable to connect to the instrument's web interface, check the following items:

- Verify that the network cable is in the correct port on the computer. The LAN port of a laptop may be disabled when the laptop is in a docking station.
- Verify that the configuration information for the correct ethernet card was used during the setup procedure.
- Verify that the network card of the computer is enabled.
- Verify that the IP address of the instrument is compatible with the IP address on the computer.
- Verify that the subnet mask address of the instrument is the same as the subnet mask address of the computer.
- Restart your computer.
- Turn the instrument's power off, and then on. Wait at least 60 s for the network configuration to be completed. Verify that the correct settings are assigned to the instrument:
 1. Press the **MENU** key.
 2. Under System, select **Communication**.
 3. Select the LAN interface.
 4. Verify the settings.

If the above actions do not correct the problem, contact your system administrator.

Error summary

Messages in the Event Log are preceded by a numeric code called an Event Number. Negative (-) numbers are used for SCPI-defined messages, and positive (+) numbers are used for Keithley-defined messages.

The event log supports up to 64 errors. You cannot disable the logging of errors

Error code	Error message
-440	Query UNTERMINATED after indefinite response
-430	Query DEADLOCKED
-420	Query UNTERMINATED
-410	Query INTERRUPTED
-405	Request control
-404	Power fail
-403	User request
-402	Operation complete
-401	Power on
-400	Query event
-363	Input buffer overrun
-362	Framing error in program message
-361	Parity error in program message
-360	Communication error
-350	Queue overflow
-330	Self-test failed
-315	Configuration memory lost
-314	Save/recall memory lost
-313	Calibration memory lost
-312	PUD memory lost
-311	Memory error
-310	System error
-300	Device-specific error
-285	Program syntax error
-284	Program currently running
-282	Illegal program name
-281	Cannot create program
-274	Hardcopy configuration error

Error code	Error message
-273	Hardcopy aborted
-272	Hardcopy is busy
-271	Hardcopy device not responding
-270	Hardcopy error
-261	Math error in expression
-260	Expression error
-258	Media protected
-257	File name error
-256	File name not found
-255	Directory full
-254	Media full
-253	Corrupt media
-252	Missing media
-251	Missing mass storage
-250	Mass storage error
-243	Hardware I/O device error
-242	Hardware configuration error
-241	Hardware missing
-240	Hardware error
-230	Data corrupt or stale
-225	Out of memory
-224	Illegal parameter value
-223	Too much data
-222	Data out of range
-221	Settings conflict
-220	Parameter error
-215	Arm deadlock
-214	Trigger deadlock
-213	Init ignored
-212	Arm ignored
-211	Trigger ignored
-210	Trigger error
-202	Settings lost due to rtl
-201	Invalid while in local
-200	Execution error

Error code	Error message
-184	Command in alias requires more/fewer parameters
-183	Invalid inside alias definition
-181	Invalid outside alias definition
-180	Alias error
-178	Data type error
-171	Invalid expression
-170	Expression error
-168	Block data not allowed
-161	Invalid block data
-160	Block data error
-158	String data not allowed
-154	String too long
-152	String data too long
-151	Invalid string data
-150	String data error
-148	Character data not allowed
-144	Character data too long
-141	Invalid character data
-140	Character data error
-138	Suffix not allowed
-134	Suffix too long
-131	Invalid suffix
-130	Suffix error
-128	Numeric data not allowed
-124	Too many digits
-123	Exponent too large
-121	Invalid character in number
-120	Numeric data error
-118	Query not allowed
-114	Header suffix out of range
-113	Undefined header
-112	Program mnemonic too long

Error code	Error message
-111	Header separator error
-110	Command header error
-109	Missing parameter
-108	Parameter not allowed
-106	Invalid program data separator
-105	GET not allowed
-104	Data type error
-103	Invalid separator
-102	Syntax error
-101	Invalid character
-100	Command error
0	No error
Calibration errors	
100	Calibration error
101	Not permitted with cal locked
102	Calibration password is incorrect
105	Bad sequence of calibration commands
106	Calibration save failed
107	Calibration data lost
108	Busy on current step, wait until this step is completed
109	Not permitted with cal unlocked
110	Step1 Kmath error
111	Step1 V-DAC zero DMM reading out of range
112	Step1 V-ADC zero collected data error
113	Step2 V-DAC full scale DMM reading out of range
114	Step2 V-ADC full scale collected data error
115	Step3 I-ADC 100mA zero DMM reading out of range
116	Step3 100mA shunt value out of range
117	Step3 I-ADC 100mA zero collected data error
118	Step3 I-ADC 10mA zero collected data error
119	Step4 I-ADC 100mA full scale DMM reading out of range
120	Step4 100mA shunt value out of range
121	Step4 I-ADC 100mA full scale collected data error
122	Step5 I-ADC 10A zero DMM reading out of range
123	Step5 10A shunt value out of range

Error code	Error message
124	Step5 I-ADC 10A zero collected data error
125	Step5 I-ADC 1A zero collected data error
126	Step6 I-DAC zero collected data error
127	Step7 I-ADC 10A full scale DMM reading out of range
128	Step7 10A shunt value out of range
129	Step7 I-ADC 10A full scale collected data error
130	Step8 I-DAC full scale collected data error
140	OXF or reverse sense error occurred during calibration
141	Incorrect CC/CV mode for one certain step
150	Not permitted when performing cal from front panel
List errors	
200	List error
201	Too many list points
202	List lengths not equivalent
203	Assigning data to undefined list
204	Attempt to run an empty list
205	Save list failed
206	List state is off
207	Load list from USB flash drive failed
208	Load list from internal memory failed
209	Change Sense Function to V+I (CONCurent) before running a list
210	Not permitted with list enabled
Protection errors	
300	OVP error occurred
301	OCP error occurred
302	OTP error occurred
303	Clear OXF failed
304	Open sense error occurred
311	Reverse sense fault
320	Not permitted with output off
330	Not permitted before OXF or reverse sense error is cleared
Communication errors	
400	Could not modify IP address
401	Could not modify subnet mask
402	Could not modify gateway address

Error code	Error message
403	IP address, subnet mask and gateway address don't match
406	IP conflicts
Other errors	
500	Acquire data failed
501	Assign line failed
502	SDEviation not supported when trace buffer feed control is NEXT or ALWays
503	Only supports single channel
504	No upgrade found
507	Lines 4 to 6 don't support function AUTO for single channel instrument
508	Querying manual input data of the line which is not set as Manual Input line
509	System password not correct
510	Parameter error
511	Communication not permitted
520	No USB flash drive found
521	Cannot open file
522	Load file from USB flash drive failed
523	Save file to USB flash drive failed
530	Attempt to call an empty global setup
540	Password is too long
541	Invalid character in password
600	Lines 1/3 don't support function DIGIN/DIGOUT for single channel instrument
601	Lines 2/4 to 6 don't support function AUTO for single channel instrument
602	Parameter error
603	Not supported in this mode
605	Line 1 will be fixed to ATUO when arm source is External
700	Not permitted in this work mode
701	Model length not enough
702	Full Voc can't be less than empty Voc
703	Not permitted with battery model is running
704	Too many model values
705	Model length not enough
708	Illegal model range setting

In this section:

[Additional Series 2280 information](#)9-1

Additional Series 2280 information

For additional information about the Series 2280, refer to:

- The Keithley Instruments website (tek.com/keithley) contains the most up-to-date information. From the website, you can access:
 - The product documentation
 - The Knowledge Center, which contains the following handbooks:
 - *The Low Level Measurements Handbook: Precision DC Current, Voltage, and Resistance Measurements*
 - *Switching Handbook: A Guide to Signal Switching in Automated Test Systems*
 - Application notes
 - Updated drivers
 - Updated firmware
- Your local Field Applications Engineer: They can help you with product selection, configuration, and usage. Check the website for contact information.

Maintenance

In this appendix:

Introduction	A-1
Line fuse replacement	A-1
Upgrading the firmware	A-2
Perform DIN VDE 701 test	A-4
Cleaning the front-panel display	A-4

Introduction

The information in this section describes routine maintenance of the instrument that can be performed by the operator.

Line fuse replacement

A fuse on the Series 2280 rear panel protects the power line input of the instrument. Follow the below instructions to replace the fuse. You do not need to return your instrument for service if the fuse is damaged.

WARNING

Disconnect the line cord at the rear panel and remove all test leads connected to the instrument before replacing a line fuse. Failure to do so could expose the operator to hazardous voltages that could result in personal injury or death.

Use only the correct fuse type. Failure to do so could result in injury, death, or instrument damage.

Choose the right fuse with mechanical characteristics described in the following table.

Model	100 VAC/120 VAC source	220 VAC/240 VAC source
2280S-32-6	250 V, 5 A, Time delay	250 V, 2.5 A, Time delay
2280S-60-3	250 V, 5 A, Time delay	250 V, 5 A, Time delay

To replace the fuses, you will need a small flat-bladed screwdriver.

Perform the following steps to replace the line fuse:

1. Power off the instrument.
2. Remove the line cord.
3. Locate the fuse drawer, which is next to the AC receptacle as shown in the graphic below.

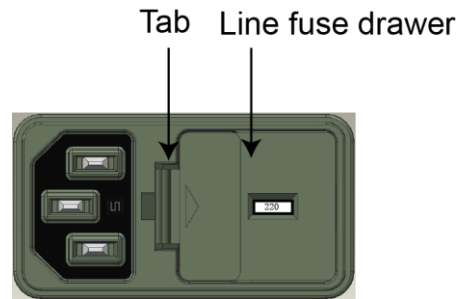
Figure 100: Line fuse

4. Use the screwdriver to lift the tab from the AC receptacle.
5. Slide the fuse drawer out. The fuse drawer must be pulled completely out of the power module.
6. Snap the fuse out of the drawer.
7. Replace the two fuses.
8. Push the fuse drawer back into the power module.

If the power line fuses continue to become damaged, a circuit malfunction exists and must be corrected. Return the instrument to Keithley Instruments for repair.

Upgrading the firmware

To upgrade the Series 2280 firmware, you load an upgrade file into the instrument. You can load the file from the USB port using the front panel of the instrument.

NOTE

The USB flash drive must be less than or equal to 2 GB and formatted in the FAT file format.

During the upgrade process, you must select whether you are upgrading to a newer firmware version or downgrading to an older firmware version. The instrument will verify that the version you are loading is newer or older depending on your selection.

The upgrade process should take about five minutes.

To locate the upgrade files:

1. Go to the [Product Support web page \(tek.com/product-support\)](http://tek.com/product-support).
2. Next to Enter model, type 2280, and select **GO**.
3. Select the **Software** tab.
4. Select the firmware link that you want to download (note that you will need to log in or register to continue).
5. Once you are logged in, select the **Download File** button and choose where to download your file. You can rename the file if you want.
6. Unzip the download file.

CAUTION

Disconnect the input and output terminals before you upgrade or downgrade.

Do not remove power from the Series 2280 or remove the USB flash drive while an upgrade or downgrade is in progress. Wait until the instrument completes the procedure and shows the opening display.

From the front panel

CAUTION

Do not turn off power or remove the USB flash drive until the upgrade process is complete.

From the front panel:

1. Copy the firmware upgrade file to a USB flash drive (the flash drive must be less than or equal to 2 GB and formatted in the FAT file format).
2. Verify that the upgrade file is in the root subdirectory of the flash drive and that it is the only firmware file in that location.
3. Disconnect any input and output terminals that are attached to the instrument.
4. Turn the instrument power off. Wait a few seconds.
5. Turn the instrument power on.
6. Insert the flash drive into the USB port on the front panel of the instrument.
7. From the instrument front panel, press the **MENU** key.
8. Under System, select **Information**.
9. Select **Upgrade**, and press the **ENTER** key.

10. Select the type of upgrade you want to perform:
 - To upgrade to a newer version of firmware: Select **New** and press the **ENTER** key.
 - To return to a previous version of firmware: Select **Previous** and press the **ENTER** key.A message is displayed while the upgrade is in progress.
11. When the upgrade is complete, reboot the instrument.

Perform DIN VDE 701 test

WARNING

The following procedure is intended only for qualified service personnel. This procedure may expose you to hazardous voltages that could result in personal injury or death. Do not attempt to perform these procedures unless you are qualified to do so.

Since the Series 2280 series of instruments have overvoltage protection built in, you should perform an isolation resistance test within a DIN VDE 701 test at 250 volts using a Fluke 6500-2, or equivalent.

Cleaning the front-panel display

Inspect the power supply as often as operating conditions require.

To clean the exterior surface:

1. Remove loose dust on the outside of the power supply with a lint-free cloth. Use care to avoid scratching the display.
2. Use a soft cloth dampened with water to clean the power supply. Use an aqueous solution of 75% isopropyl alcohol for more efficient cleaning.

CAUTION

To avoid damage to the surface of the power supply, do not use any abrasive or chemical cleaning agents.

In this appendix:

Overview	B-1
Test record	B-2
Performance verification procedures.....	B-16

Overview

This section contains performance verification procedures. Additional test equipment is required to complete the verification procedures.

These procedures cover the Series 2280. Please ignore procedures that do not apply to the specific model you are testing.

Print the [Test record](#) (on page B-2), and use it to record the performance test results for your power supply.

NOTE

Completion of the performance verification procedure does not update the stored time and date of the latest successful adjustment. The date and time are updated only when the factory adjustment procedures are successfully completed.

The performance verification procedures verify the performance of your instrument. They do not adjust your instrument. If your instrument fails any of the performance verification tests, refer to the [Keithley Instruments website \(tek.com/keithley\)](http://tek.com/keithley).

Test record

Model	Serial	Procedure performed by	Date

Test	Passed	Failed
DC voltage setting accuracy with remote sense		
DC voltage accuracy without remote sense		
DC voltage readback accuracy		
DC voltage line regulation		
DC voltage load regulation		
DC voltage detection		
DC current accuracy		
DC current readback accuracy (10 mA)		
DC current readback accuracy (100 mA)		
DC current readback accuracy (1 A)		
DC current line regulation		
DC current load regulation		
Oversvoltage protection		
Overcurrent protection		
Voltage noise at 20 MHz		
Current noise at 20 MHz		

DC voltage setting accuracy with remote sense

Model number	DUT voltage (V)	Test current (A)	Minimum (V)	Maximum (V)	Measured voltage (V)
0% test voltage					
2280S-32-6	0	3	-0.003	0.003	
2280S-60-3	0	1.6	-0.006	0.006	
25% test voltage					
2280S-32-6	8	3	7.9954	8.0046	
2280S-60-3	15	1.6	14.991	15.009	
50% test voltage					
2280S-32-6	16	3	15.9938	16.0062	
2280S-60-3	30	1.6	29.988	30.012	
75% test voltage					
2280S-32-6	24	3	23.9922	24.0078	
2280S-60-3	45	1.6	44.985	45.015	
100% test voltage					
2280S-32-6	32	3	31.9906	32.0094	
2280S-60-3	60	1.6	59.982	60.018	

DC voltage setting accuracy without remote sense

Model number	DUT voltage (V)	Test current (A)	Minimum (V)	Maximum (V)	Measured voltage (V)
0% test voltage					
2280S-32-6	0	3	-0.0045	0.0045	
2280S-60-3	0	1.6	-0.0068	0.0068	
25% test voltage					
2280S-32-6	8	3	7.9939	8.0061	
2280S-60-3	15	1.6	14.9902	15.0098	
50% test voltage					
2280S-32-6	16	3	15.9923	16.0077	
2280S-60-3	30	1.6	29.9872	30.0128	
75% test voltage					
2280S-32-6	24	3	23.9907	24.0093	
2280S-60-6	45	1.6	44.9842	45.0158	
100% test voltage					
2280S-32-6	32	3	31.9891	32.0109	
2280S-60-3	60	1.6	59.9891	60.0188	

DC voltage readback accuracy with remote sense

Model number	DUT voltage (V)	Test current (A)	Measured voltage (V)	DUT readback (V)	Absolute difference (mV)	Maximum difference (mV)
0% test voltage						
2280S-32-6	0	3				2
2280S-60-3	0	1.6				4
25% test voltage						
2280S-32-6	8	3				3.6
2280S-60-3	15	1.6				7
50% test voltage						
2280S-32-6	16	3				5.2
2280S-60-3	30	1.6				10
75% test voltage						
2280S-32-6	24	3				6.8
2280S-60-3	45	1.6				15
100% test voltage						
2280S-32-6	32	3				8.4
2280S-60-3	60	1.6				16

DC voltage readback accuracy without remote sense

Model number	DUT voltage (V)	Test current (A)	Measured voltage (V)	DUT readback (V)	Absolute difference (mV)	Maximum difference (mV)
0% test voltage						
2280S-32-6	0	2				3
2280S-60-3	0	4				6
25% test voltage						
2280S-32-6	8	2				4.6
2280S-60-3	15	4				9
50% test voltage						
2280S-32-6	16	2				6.2
2280S-60-3	30	4				12
75% test voltage						
2280S-32-6	24	2				7.8
2280S-60-3	45	4				15
100% test voltage						
2280S-32-6	32	2				9.4
2280S-60-3	60	4				18

DC voltage load regulation

Model number	Minimum (V)	Nominal (V)	Maximum (V)	Nominal - Minimum (V)	Maximum - Nominal (V)	Largest (V)	Maximum value (V)
2280S-32-6							0.0052
2280S-60-3							0.008

DC overvoltage protection

Model number	OVP setting voltage (V)	Minimum (V)	Maximum (V)	Measured voltage (V)
10% OVP setting				
2280S-32-6	3.2	2.942	3.458	
2280S-60-3	6	5.485	6.515	
25% OVP setting				
2280S-32-6	8	7.73	8.27	
2280S-60-3	15	14.4625	15.5375	
50% OVP setting				
2280S-32-6	16	15.71	16.29	
2280S-60-3	30	29.425	30.575	
75% OVP setting				
2280S-32-6	24	23.69	24.31	
2280S-60-3	45	44.3875	45.6125	
90% OVP setting				
2280S-32-6	28.8	28.47	29.12	
2280S-60-3	54	53.365	54.635	

DC current accuracy

Model number	DUT voltage (V)	Test current (A)	Minimum (A)	Maximum (A)	Measured current (A)
0% test current					
2280S-32-6	16	0	-0.005	0.005	
2280S-60-3	30	0	-0.005	0.005	
25% test current					
2280S-32-6	16	1.5	1.49425	1.50575	
2280S-60-3	30	0.8	0.7946	0.80504	
50% test current					
2280S-32-6	16	3	2.9935	3.0065	
2280S-60-3	30	1.6	2.3938	1.60508	
75% test current					
2280S-32-6	16	4.5	4.49275	4.50725	
2280S-60-3	30	2.4	2.3938	2.4062	
100% test current					
2280S-32-6	16	6	5.992	6.008	
2280S-60-3	30	3	2.9935	3.0065	

DC current readback accuracy

DC current readback accuracy on 10 A range

Model number	Test current (A)	Measured current (A)	DUT readback (A)	Absolute difference (mA)	Maximum difference (mA)
0% test current					
2280S-32-6	0				0.25
2280S-60-3	0				0.25
25% test current					
2280S-32-6	1.5				0.1
2280S-60-3	0.75				0.625
50% test current					
2280S-32-6	3				1.75
2280S-60-3	1.6				1.05
100% test current					
2280S-32-6	6				3.25
2280S-60-3	3.0				1.75

DC current readback accuracy on 1 A range

Model number	Test current (A)	Measured current (A)	DUT readback (A)	Absolute difference (mA)	Maximum difference (mA)
0% test current					
2280S-32-6	0				0.25
2280S-60-3	0				0.25
10% test current					
2280S-32-6	0.1				0.3
2280S-60-3	0.1				0.3
50% test current					
2280S-32-6	0.5				0.5
2280S-60-3	0.5				0.5
100% test current					
2280S-32-6	1				0.75
2280S-60-3	1				0.75

DC current readback accuracy on 100 mA range

Model number	Test current (mA)	Measured current (mA)	DUT readback (mA)	Absolute difference (mA)	Maximum difference (μ A)
0% test current (100 mA)					
2280S-32-6	0				10
2280S-60-3	0				10
10% test current (100 mA)					
2280S-32-6	10				15
2280S-60-3	10				15
50% test current (100 mA)					
2280S-32-6	50				35
2280S-60-3	50				35
100% test current (100 mA)					
2280S-32-6	100				60
2280S-60-3	100				60

DC current readback accuracy on 10 mA range

Model number	Test current (mA)	Measured current (mA)	DUT readback (mA)	Absolute difference (mA)	Maximum difference (μ A)
0% test current (10 mA)					
2280S-32-6	0				10
2280S-60-3	0				10
10% test current (10 mA)					
2280S-32-6	1				10.5
2280S-60-3	1				10.5
50% test current (10 mA)					
2280S-32-6	5				12.5
2280S-60-3	5				12.5
100% test current (10 mA)					
2280S-32-6	10				15
2280S-60-3	10				15

DC voltage line regulation

Model number	DUT voltage (V)	Test current (A)	Min (V)	Nom (V)	Max (V)	Nom - Min (V)	Max - Nom (V)	Largest (V)	Max value (V)
2280S-32-6	32	3							0.0042
2280S-60-3	60	1.6							0.007

DC current line regulation

Model number	DUT voltage (V)	Test current (A)	Min (A)	Nom (A)	Max (A)	Nom - Min (mA)	Max - Nom (mA)	Largest (mA)	Max value (A)
2280S-32-6	16	6							0.00085
2280S-60-3	30	3.2							0.00052

DC current load regulation

Model number	Minimum (A)	Nominal (A)	Maximum (A)	Nominal - Minimum (A)	Maximum - Nominal (A)	Largest (A)	Maximum value (A)
2280S-32-6							0.00085
2280S-60-3							0.00057

DC overcurrent protection

Model number	OCP setting value (A)	Minimum (A)	Maximum (A)	Measured current (A)
25% OCP setting				
2280S-32-6	1.5	1.39625	1.60375	
2280S-60-3	0.8	0.698	0.902	
50% OCP setting				
2280S-32-6	3	2.8925	3.1075	
2280S-60-3	1.6	1.496	1.704	
75% OCP setting				
2280S-32-6	4.5	4.38875	4.61125	
2280S-60-3	2.4	2.294	2.506	
90% OCP setting				
2280S-32-6	5.4	5.2865	5.5135	
2280S-60-3	2.88	2.7728	2.9872	

Voltage noise at 20 MHz

Model number	DUT current (A)	DUT voltage (V)	Maximum (mV)	Measured voltage (mV)
20 MHz voltage ripple RMS				
2280S-32-6	3	32	1	
2280S-60-3	1.6	60	2	
20 MHz voltage ripple PKPK				
2280S-32-6	3	32	5	
2280S-60-3	1.6	60	7	

Current noise at 20 MHz, 1 Ω load

Model number	DUT current (A)	DUT voltage (V)	Maximum (mA)	Measured voltage (mA)
20 MHz current ripple RMS				
2280-32-6	6	32	3	
2280S-60-3	3.2	60	3	

Performance verification procedures

Use the procedures in this topic to verify the performance of the Series 2280 instruments.

Performance verification conditions

The following conditions must be met before performing these procedures:

- The device under test (DUT) and all test equipment must have been operating continuously for 20 minutes in an environment that meets the operating range specifications for temperature and humidity.
- Changes to the test setup that affect the remote sense require an additional 20 minute warm-up period.
- The procedures are intended to be used in sequence. If it is necessary to partially test the DUT using an individual test, a 20-minute warm-up period is required for the individual test.
- You must connect the DUT and the test equipment to the same AC power circuit. Connect the DUT and test instruments into a common power strip if you are unsure of the AC power circuit distribution. Connecting the DUT and test instruments into separate AC power circuits can result in offset voltages between the equipment, which can invalidate this performance verification procedure.
- The AC power source for the DUT must match the voltage selector switch setting located on the bottom of the DUT.

DUT voltage selector switch	AC source voltage
100	100 V
120	120 V
220	220 V
240	240 V

WARNING

Some procedures use hazardous voltages. To prevent electrical shock, always power off instruments before touching exposed circuitry. Read and follow the precautions in the [Safety Precaution](#) (on page 1-1).

Required equipment

These procedures use external equipment to directly check warranted characteristics. The following table lists the required equipment.

Equipment	Required specifications	Recommended model
Connectors	Connect wire assemblies and test resistors	
Linear AC power source	Variable AC output from 90 VAC to 265 VAC with at least 750 VA capacity	
Electronic load	Variable DC load capable of 6 A and 75 VDC	
DC voltmeter	7½ -digit high-accuracy voltmeter	Keithley 2001/2002
High current hook up wire	18 AWG minimum connection wires	
Low current hook up wire	22 AWG minimum connection wires	
50 mΩ precision shunt resistor	50 mΩ precision shunt with 5 ppm at 25 °C ±4 ppm/°C temperature coefficient	Isotek Corp RUG-Z-R050-0.1-TK1
5 Ω precision shunt resistor	5 Ω precision shunt with 25 ppm at 25 °C ±4 ppm/°C temperature coefficient	Isotek Corp RUG-Z-5R00-0.1-TK1
Current sense resistor cabling	Kelvin 4 terminal measuring cables from shunt resistor to voltmeter	
300 Ω resistor	Power rating > 5 W	

Check DC voltage setting readback accuracy with remote sense

Equipment required	
AC power source	High-current 18 AWG wire
Electronic load	Low-current 22 AWG wire
DC voltmeter	0.3 Ω resistors

To check DC voltage setting readback accuracy with remote sense:

1. Power off the device under test (DUT).
2. Remove the shorting jumpers that connect the output terminals to the sense terminals from the output mating connector on the rear panel.
3. Set up the equipment, as shown in the following figure.

Figure 101: DC voltage accuracy with remote sense test setup

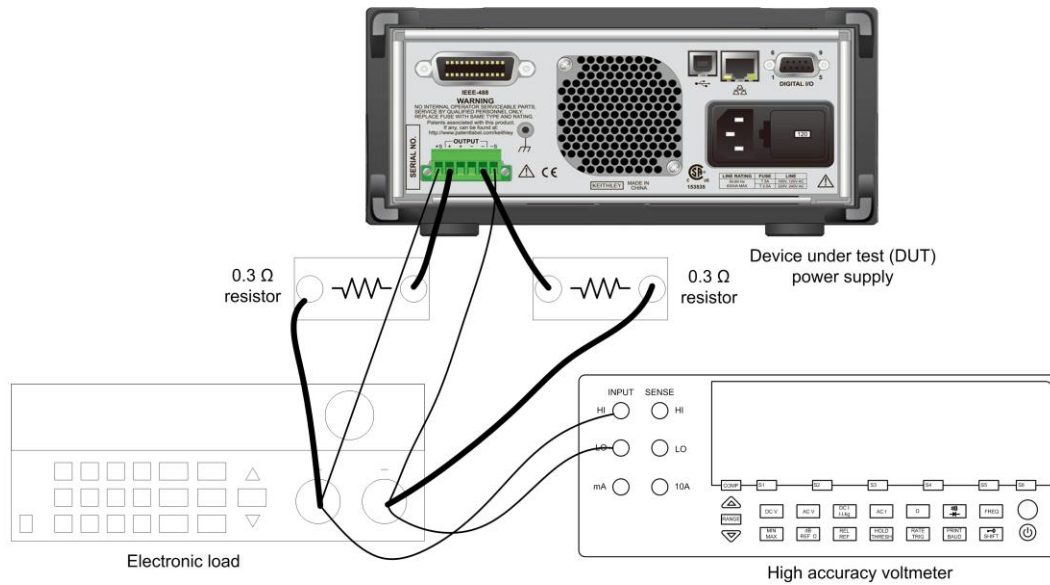

NOTE

To ensure accurate measurements, it is important that a significant amount of current does not flow through the sense leads. For this reason, we recommend that the wiring of the remote sense and the voltmeter be located physically away from the high-current connections between the electronic load and the DUT.

A solution is to use a pair of fork lugs with all three wires crimped in. Another alternative is to use a fork lug between the DUT and the load, and separate connections (using fork lugs) holding the wiring for one or both of the voltmeter and remote sense. A third alternative is to stack banana jacks at the voltmeter, with the remote sense toward the voltmeter, and the two high-current connections on the outside.

4. Power on the DUT. Make sure the warm-up criteria have been met, as described in the Performance verification conditions.
5. Set the voltmeter as follows:
 - Set to measure DC voltage.
 - Set the current range to autorange.
6. Set the electronic load as follows:
 - Set to constant current.
 - Set to draw a constant current at the test current specified for the DUT in the [DC voltage setting accuracy with remote sense](#) (on page B-3) table.

7. Set the DUT to the full-scale output current.
8. Set the DUT to 0% of the full-scale output voltage (0 V).
9. Turn the DUT output on.
10. Enter the voltmeter reading in the [DC voltage setting accuracy with remote sense](#) (on page B-3) and the [DC voltage readback accuracy with remote sense](#) (on page B-5) tables.
11. Enter the DUT readback voltage in the [DC voltage readback accuracy with remote sense](#) (on page B-5) table.
12. Calculate the difference of the two measurements taken in step 10 and step 11 and enter the absolute value in the difference column of the [DC voltage readback accuracy with remote sense](#) (on page B-5) table.
13. Increase the DUT output voltage by 25% of the full-scale output voltage.
14. Repeat step 10 and step 11 until you complete testing at 100% of the full-scale output voltage.
15. Power off the DUT.
16. Disconnect the wires from the remote sense connector and reinstall the shorting jumpers between the output terminals and sense terminals, as shown in the following figure. One jumper goes in terminals 1 and 2 and the other goes in terminals 5 and 6.

Figure 102: Connector terminals

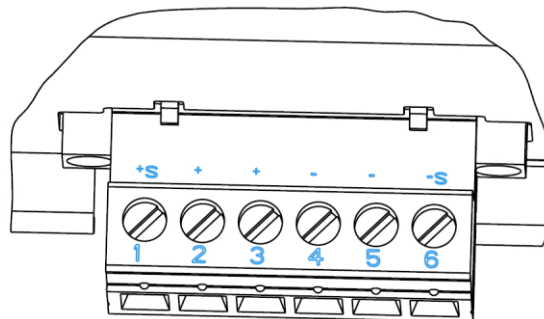

CAUTION

The jumper cables must be installed if you are going to use 2-wire connections.

Even if you are using the front-panel connectors, the output mating connector (with jumper wires installed) must be connected to the Series 2280 rear-panel output connector to ensure proper instrument performance.

17. Power on the DUT.

Check DC voltage setting accuracy with remote sense

Equipment required	
AC power source	High-current 18 AWG wire
Electronic load	Low-current 22 AWG wire
DC voltmeter	

Set up the equipment as shown in the following figure.

Figure 103: Voltage accuracy and protection test setup

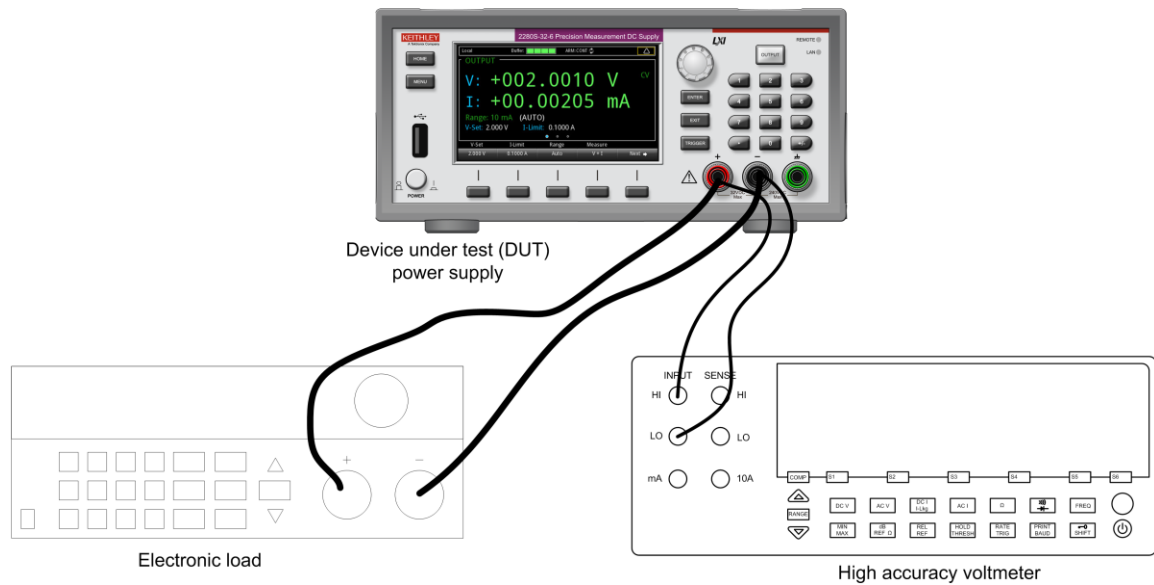

NOTE

Make sure the warm-up criteria have been met, as described in the Performance verification conditions.

To ensure accurate measurements, the voltmeter must be connected as closely as possible to the front panel of the device under test (DUT). A solution is to use fork spade terminals between the electronic load and the DUT, and banana plugs between the DUT and voltmeter. An alternative solution is to use fork spade terminals for both connections at the DUT. For details, see the following figure.

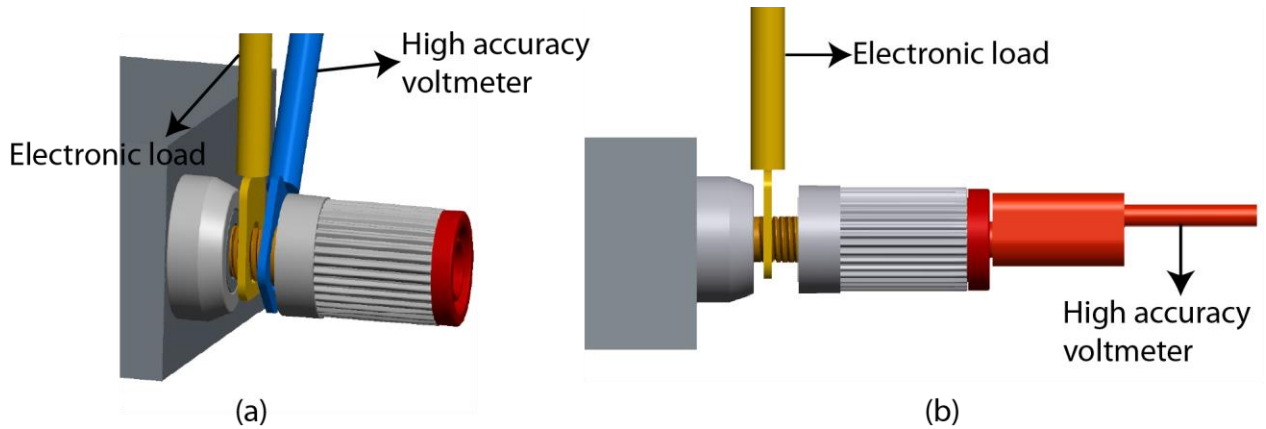
Figure 104: Electronic load and voltmeter connections**Check current noise (20 MHz):**

1. Set the voltmeter as follows:
 - Set to measure DC voltage.
 - Set the current range to autorange.
2. Set the electronic load as follows:
 - Set to constant current (CC) mode.
 - Set to draw a constant current at the test current specified for the DUT in the [DC voltage setting accuracy without remote sense](#) (on page B-4) table.
3. Set the DUT to the full-scale output current.
4. Set the DUT to 0% of the full-scale output voltage (0 V).
5. Turn the DUT output on.
6. Enter the voltmeter reading in the [DC voltage setting accuracy without remote sense](#) (on page B-4) table.
7. Increase the DUT output voltage by 25% of the full-scale output voltage.
8. Repeat steps 5 through 8 until you complete testing at 100% of full-scale output voltage.

Check DC voltage readback accuracy without remote sense

Equipment required	
AC power source	High current 18 AWG wire
DC voltmeter	Low current 22 AWG wire

Set up the equipment as shown in the following figure.

Figure 105: Voltage readback accuracy without remote sense test setup

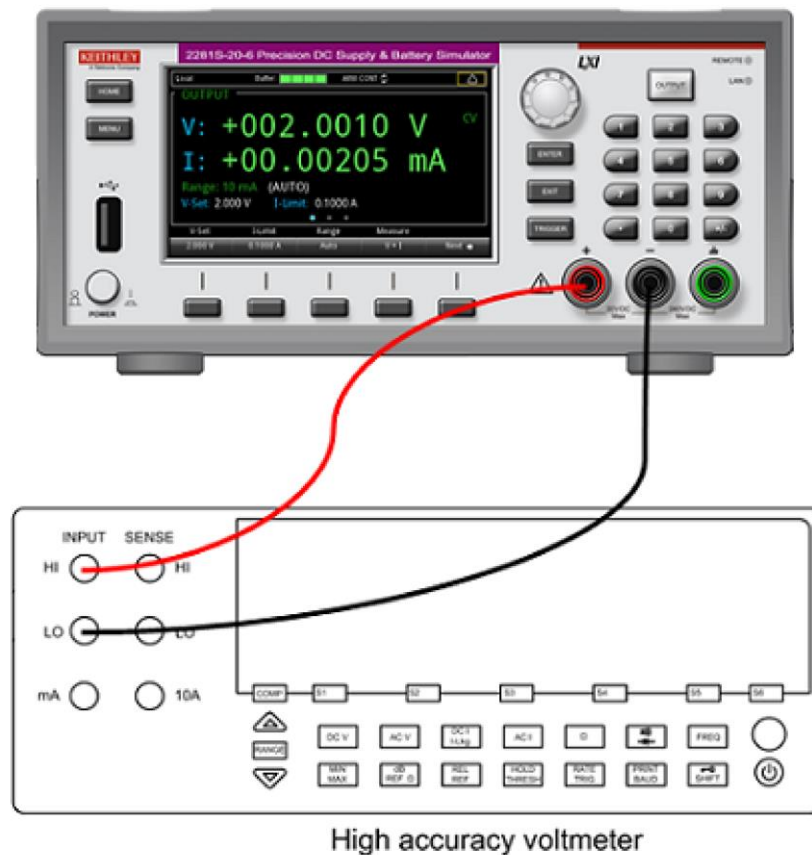

NOTE

Make sure the warm-up criteria have been met, as described in the Performance verification conditions.

To ensure accurate measurements, connect the voltmeter as closely as possible to the front panel of the DUT. A solution is to use fork spade terminals between the electronic load and the DUT, and banana plugs between the DUT and voltmeter. An alternative solution is to use fork spade terminals for both connections at the DUT.

To check DC voltage readback accuracy without remote sense:

1. Set the voltmeter as follows:
 - Set to measure DC voltage.
 - Set the current range to autorange.
 - Verify that the Math $mx + b$ function is disabled (shift DCV), assuring that volts are being read.
2. Set the DUT to the full-scale output current.
3. Set the DUT to 0% of the full-scale output voltage (0 V).
4. Turn the DUT output on.
5. Enter the voltmeter reading in the [DC voltage readback accuracy without remote sense](#) (on page B-6) table.
6. Enter the DUT readback voltage in the [DC voltage readback accuracy without remote sense](#) (on page B-6) table.
7. Calculate the difference of the two measurements taken in step 5 and step 6 and enter the absolute value in the difference column of the [DC voltage readback accuracy without remote sense](#) (on page B-6) table.
8. Increase the DUT output voltage by 25% of the full-scale output voltage.
9. Repeat steps 3 through 8, increasing the output voltage until you complete testing at 100% of full-scale output voltage.

Check DC voltage line regulation

Set up the equipment, as shown in the following figure.

Figure 106: Voltage line regulation test setup

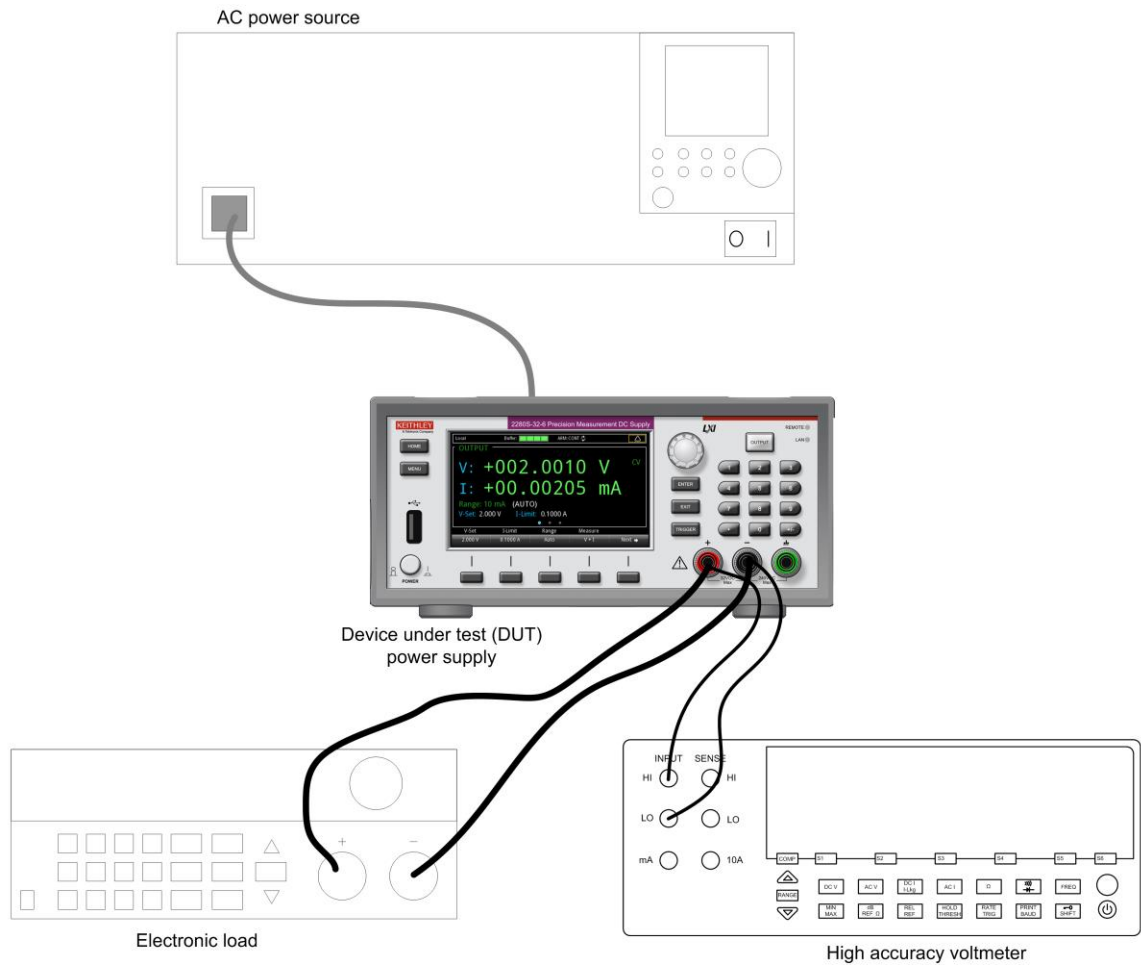

To check DC voltage line regulation:

1. Change the AC power source output to the minimum voltage specified in the following table.

DUT voltage selector switch	AC source voltage
100	90 V
120	108 V
220	198 V
240	216 V

NOTE

Make sure the warm-up criteria have been met, as described in the Performance verification conditions.

2. Set the voltmeter as follows:
 - Set to measure DC voltage.
 - Set the current range to autorange.
 - Verify that the Math mx+b function is disabled (shift DCV), ensuring that voltage is being read.
3. Set the electronic load as follows:
 - Set to constant current (CC) mode.
 - Set to draw the specified test current.

Model	Test current
2280S-32-6	3 A
2280S-60-3	1.6 A

4. Set the device under test (DUT) to 100% of the full-scale output current.
5. Set the DUT to 100% of the full-scale output voltage.
6. Turn the DUT output on.
7. Enter the voltmeter reading in the [DC voltage line regulation](#) (on page B-7) table under the Min column for your product.
8. Change the AC power source output to the maximum voltage specified in the following table.

DUT voltage selector switch	AC source voltage
100	110 V
120	132 V
220	242 V
240	264 V

9. Enter the voltmeter reading in the [DC voltage line regulation](#) (on page B-7) table under the Max column for your product.

10. Change the AC power source output to match the Voltage Selector switch setting of the DUT, as shown in the following table.

DUT voltage selector switch	AC source voltage
100	100 V
120	120 V
220	220 V
240	240 V

11. Enter the voltmeter reading in the [DC voltage line regulation](#) (on page B-7) table under the Nom column for your product.
12. Calculate the two values: Nom – Min and Max – Nom. Enter the values in the appropriate columns in the [DC voltage line regulation](#) (on page B-7) table.
13. Enter the largest of the two values calculated in step 13 in the Largest column in the [DC voltage line regulation](#) (on page B-7) table.

Check DC voltage load regulation

This procedure uses the same test setup as the previous procedure (see [Check DC voltage setting accuracy without remote sense](#) (on page B-21)).

NOTE

Make sure the warm-up criteria have been met, as described in the Performance verification conditions.

To check DC voltage load regulation:

- Set the voltmeter as follows:
 - Set to measure DC voltage.
 - Set the current range to autorange.
 - Verify that the Math $mx + b$ function is disabled, assuring that voltage is being read.
- Set the electronic load as follows:
 - Set to constant current (CC) mode.
 - Set to draw 0 A.
- Set the device under test (DUT) to 100% of the full-scale output current.
- Set the DUT to 100% of the full-scale output voltage.
- Turn the DUT output on.
- Enter the voltmeter reading in the [DC voltage load regulation](#) (on page B-7) table under the Minimum column for your product.

7. Increase the electronic load to the reference load test current value.

Instrument	Test current
2280S-32-6	3 A
2280S-60-3	1.6 A

8. Enter the voltmeter reading in the [DC voltage load regulation](#) (on page B-7) table under the reference load column for your product.
9. Increase the electronic load to the maximum load test current value.

Instrument	Test current
2280S-32-6	5.4 A
2280S-60-3	2.88 A

10. Enter the voltmeter reading in the [DC voltage load regulation](#) (on page B-7) table under the Nom column for your product.
11. Calculate the following values: Nom – Min and Max – Nom. Enter the values in the appropriate columns in the [DC voltage load regulation](#) (on page B-7) table.
12. Enter the largest of the three values calculated in step 11 in the Largest column in the [DC voltage load regulation](#) (on page B-7) table.

Check DC overvoltage protection

This procedure uses the same test setup as the previous procedure (see [Check DC voltage setting accuracy without remote sense](#) (on page B-21)).

NOTE

Make sure the warm-up criteria have been met, as described in the Performance verification conditions.

To check DC overvoltage protection:

- Set the voltmeter as follows:
 - Set to measure DC voltage.
 - Set the current range to autorange.
 - Verify that the Math mx+b function is disabled (shift DCV), assuring that voltage is being read.
- Set the electronic load as follows:
 - Set to Constant Current.
 - Set to draw 1 A.
- Set the DUT to 100% of the full-scale output current.
- Set the overvoltage protection (OVP) threshold to 10% of full-scale output voltage.
- Set DUT output voltage 0.5 V lower than the OVP threshold and turn the DUT output ON.

6. Increase the DUT output voltage slowly by 0.01 V one step at a time until OVP is triggered. When triggered, the output voltage abruptly drops below 1 V and an OVP error is indicated on the display.
7. Enter the voltmeter reading (where OVP triggering occurred) in the [DC overvoltage protection](#) (on page B-8) table.
8. Reset OVP. Press the **Enter** key to clear the OVP error.
9. Set the OVP threshold to 25% of full-scale output voltage and repeat step 5 through step 7.
10. Set the OVP threshold to 50% of full-scale output voltage and repeat step 5 through step 7.
11. Set the OVP threshold to 75% of full-scale output voltage and repeat step 5 through step 7.
12. Set the OVP threshold to 90% of full-scale output voltage and repeat step 5 through step 7.

Check DC current accuracy

Equipment required	
AC power source	High current 18 AWG wire
Electronic load	High accuracy 0.05 Ω resistor
DC voltmeter	Current shunt resistor cabling

Set up the equipment as shown in the following figure.

NOTE

Make sure the warm-up criteria have been met, as described in Performance verification conditions.

Figure 107: DC current accuracy and regulation test setup

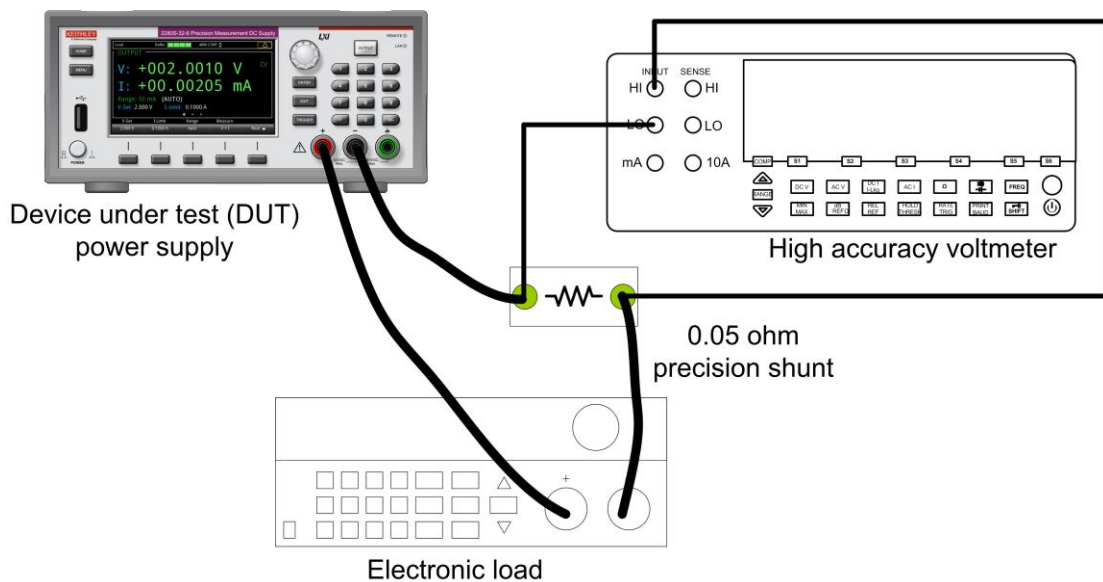

To check DC current accuracy:

1. Set the voltmeter as follows:
 - Set to measure DC voltage.
 - Set the current range to autorange.
 - Calculate the amperes (instead of volts) by multiplying the voltmeter reading result by 20 ($1/R_{\text{Shunt}}$).
2. Set the electronic load as follows:
 - Set to constant voltage.
 - Set to the specified voltage for your DUT (see [DC current accuracy](#) (on page B-9)).
3. Set the DUT to 0% of the full-scale output current.
4. Set the DUT to 25% of the full-scale output voltage.
5. Turn the DUT output on.
6. Enter the voltmeter reading in the [DC current accuracy](#) (on page B-9) table.
7. Set the DUT output current to 50% of full-scale output current and repeat step 7.
8. Set the DUT output current to 75% of full-scale output current and repeat step 7.
9. Set the DUT output current to 100% of full-scale output current and repeat step 7.

Check DC current readback accuracy (10 A and 1 A ranges)

Equipment required	
AC power source	High current 18 AWG wire
DC voltmeter	High accuracy 0.05 Ω shunt
Current shunt resistor cabling	

The Series 2280 has the following ranges to verify: 10 A, 1 A, 100 mA, and 10 mA range. Follow the procedures described below to check the current readback accuracy on 10 A and 1 A range. For other ranges, refer to [Check DC current readback accuracy \(100 mA and 10 mA ranges\)](#) (on page B-33).

Set up the equipment as shown in the following figure.

Figure 108: Current readback accuracy on 10 A and 1 A ranges test setup

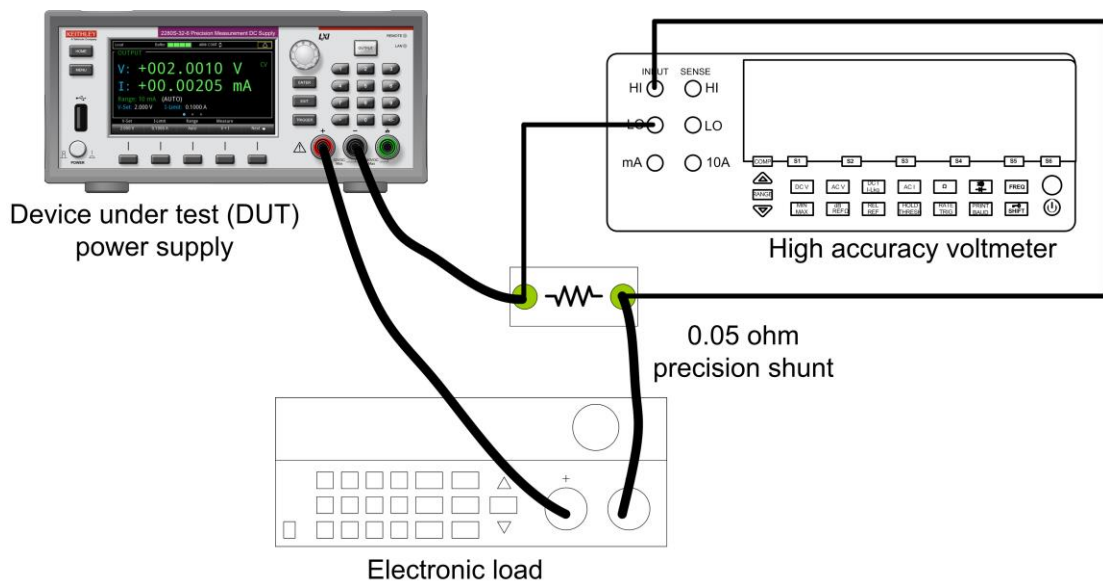

NOTE

Make sure the warm-up criteria have been met, as described in the Performance verification conditions.

To check DC current readback accuracy (10 A and 1 A ranges):

1. Set the voltmeter as follows:
 - a. Set to measure DC voltage.
 - b. Set the current range to autorange.
 - c. Calculate the amperes (instead of volts) by multiplying the voltmeter reading result by $1/(R1)$, where R1 represents the high-accuracy 0.05Ω shunt.
2. Check the current readback accuracy on the 10 A range.
3. Set the device under test (DUT) to 100% of the full-scale output voltage.
4. Set the DUT to 0% of the test current. See the following table.

Model	Range	0% test current (A)	10% test current (A)	50% test current (A)	100% test current (A)
2280S-32-6	10 A	0	0.32	1.6	6
	1 A	0	0.1	0.5	1
2280S-60-3	10 A	0	0.6	3	3.2
	1 A	0	0.1	0.5	1

5. Turn the DUT output on.
6. Enter the voltmeter reading/ $(R1 + R2)$ in the [DC current readback accuracy](#) (on page B-10) table.
7. Enter the DUT current readout in the [DC current readback accuracy](#) (on page B-10) table under the current readout column.
8. Calculate the difference of the two measurements taken in steps 7 and 8. Enter the absolute value of the calculated value in the difference column of the [DC current readback accuracy](#) (on page B-10) table.
9. Increase the DUT output current to 10% of full-scale output current and repeat step 6 through step 9.
10. Increase the DUT output current to 50% of full-scale output current and repeat step 6 through step 9.
11. Increase the DUT output current to 100% of full-scale output current and repeat step 6 through step 9.
12. Repeat steps 3 through 12 to check current readback accuracy on 1 A range.

Check DC current readback accuracy (100 mA and 10 mA ranges)

Equipment required	
AC power source	High current 18 AWG wire
300 Ω load resistor	High accuracy 0.05 Ω shunt and 5 Ω shunt
DC voltmeter	Current shunt resistor cabling

The Series 2280 has the following ranges to verify: 10 A, 1 A, 100 mA, and 10 mA. Follow the procedures described below to check the current readback accuracy on 100 mA and 10 mA range. For other ranges, refer to [Check DC current readback accuracy \(10 A and 1 A ranges\)](#) (on page B-31).

Set up the equipment as shown in the following figure.

Figure 109: Current readback accuracy on 100 mA and 10 mA ranges test setup

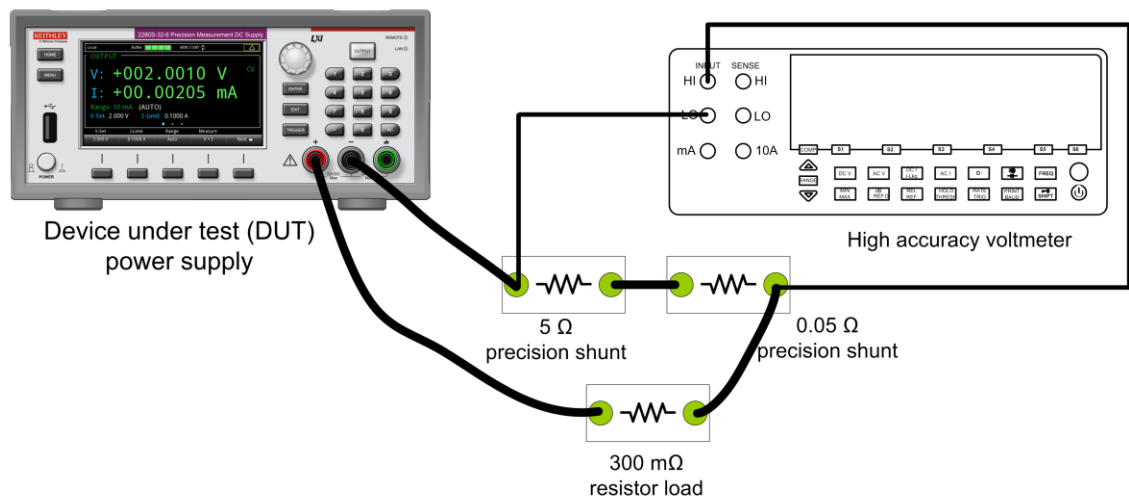

NOTE

Make sure the warm-up criteria have been met, as described in the Performance verification conditions.

To check DC current readback accuracy (100 mA and 10 mA ranges):

1. Set the voltmeter as follows:
 - a. Set to measure DC voltage.
 - b. Set the current range to autorange.
 - c. Calculate the amperes (instead of volts) by multiplying the voltmeter reading result by $1/(R1+R2)$, where R1 and R2 separately represent the high-accuracy 0.05 Ω shunt and 5 Ω shunt.
2. Check the current readback accuracy on the 100 mA range.

3. Set the device under test (DUT) to 100% of the full-scale output voltage.
4. Set the DUT to 0% of the test current. See the following table.

Model	Range	0% test current (A)	10% test current (A)	50% test current (A)	100% test current (A)
2280S-32-6	100 mA	0	0.01	0.05	0.1
	10 mA	0	0.001	0.005	0.01
2280S-60-3	100 mA	0	0.01	0.05	0.1
	10 mA	0	0.001	0.005	0.01

5. Turn the DUT output on.
6. Enter the voltmeter reading/(R1 + R2) in the [DC current readback accuracy](#) (on page B-10) table.
7. Enter the DUT current readout in the [DC current readback accuracy](#) (on page B-10) table under the current readout column.
8. Calculate the difference of the two measurements taken in steps 7 and 8. Enter the absolute value of the calculated value in the difference column of the [DC current readback accuracy](#) (on page B-10) table.
9. Increase the DUT output current to 10% of full-scale output current and repeat step 6 through step 9.
10. Increase the DUT output current to 50% of full-scale output current and repeat step 6 through step 9.
11. Increase the DUT output current to 100% of full-scale output current and repeat step 6 through step 9.
12. Repeat step 3 through step 12 to check current readback accuracy on 10 mA range.

Check DC current line regulation

Set up the equipment as shown in the following figure.

Figure 110: Series 2280 current line regulation

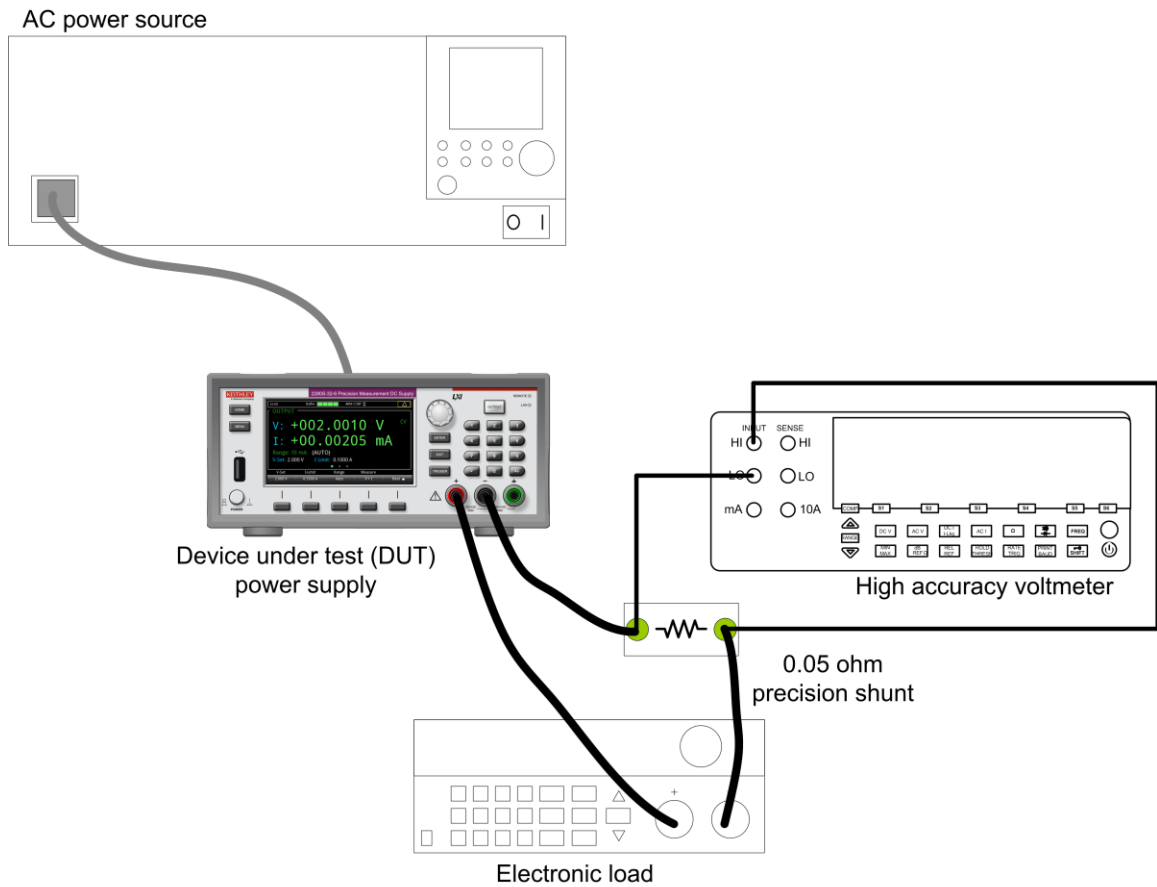

To check DC current line regulation:

1. Change the AC power source output to the minimum voltage specified in the following table.

DUT voltage selector switch	AC power source voltage
100	90 V
120	108 V
220	198 V
240	216 V

NOTE

Make sure the warm-up criteria have been met, as described in the Performance verification conditions.

2. Set the voltmeter as follows:
 - Set to measure DC voltage.
 - Set the current range to autorange.
 - Calculate the amperes (instead of volts) by multiplying the voltmeter reading result by 1/R.
3. Set the electronic load as follows:
 - Set to constant voltage.
 - Set to the specified voltage for your device under test (DUT) (see [DC current line regulation](#) (on page B-13)).
4. Set the device under test DUT to 0% of the full-scale output voltage.
5. Set the DUT to 100% of the full-scale output current.
6. Turn the DUT output on.
7. Enter the voltmeter reading in the [DC current line regulation](#) (on page B-13) table.
8. Change the AC power source output to the voltage specified in the following table.

DUT voltage selector switch	AC power source voltage
100	110 V
120	132 V
220	242 V
240	264 V

9. Enter the voltmeter reading in the Maximum line for your product in the [DC current line regulation](#) (on page B-13) table.
10. Change the AC power source output to the voltage specified in the following table.

DUT voltage selector switch	AC power source voltage
100	100 V
120	120 V
220	220 V
240	240 V

11. Enter the voltmeter reading in the Nominal column for your product in the [DC current line regulation](#) (on page B-13) table.
12. Calculate the two values: Nominal – Minimum and Maximum – Nominal. Enter the values in the appropriate columns in the [DC current line regulation](#) (on page B-13) table.
13. Select the largest of the two calculations from step 13 and enter the value in the Largest column in the [DC current line regulation](#) (on page B-13) table.
14. Turn the DUT output off.

Check DC current load regulation

This procedure uses the same test setup as the previous procedure (see [Check DC current readback accuracy \(10 A and 1 A ranges\)](#) (on page B-31)).

To check DC current load regulation:

1. Set the voltmeter as follows:
 - Set to measure DC voltage.
 - Set the current range to autorange.
 - Calculate the amperes (instead of volts) by multiplying the voltmeter reading result by 1/R.
2. Set the electronic load as follows:
 - Set to constant voltage.
 - Set to the minimum test voltage level in the following table.

Instrument	Test voltage
2280S-32-6	3.2 V
2280S-60-3	6.0 V

3. Set the device under test (DUT) to 100% of the full-scale output current for your product.
4. Set the DUT to 100% of the full-scale output voltage for your product.
5. Turn the DUT output on.
6. Enter the voltmeter reading in the [DC current load regulation](#) (on page B-14) table for checking current load regulation at the minimum voltage for your product.
7. Increase the electronic load to the reference test voltage level.

Instrument	Test voltage
2280S-32-6	16 V
2280S-60-3	30 V

8. Enter the voltmeter reading in the [DC current load regulation](#) (on page B-14) table for checking current load regulation at the reference test voltage for your product.
9. Increase the electronic load to the maximum test voltage level.

Instrument	Test voltage
2280S-32-6	28.8 V
2280S-60-3	54.0 V

10. Enter the voltmeter reading in the [DC current load regulation](#) (on page B-14) table for checking current load regulation at the maximum voltage for your product.
11. Calculate the two values: Reference – Minimum and Maximum – Reference. Enter the values in the appropriate columns in the [DC current load regulation](#) (on page B-14) table.
12. Power off the DUT and test equipment.

Check overcurrent protection

This procedure uses the same test setup as [Check DC overvoltage protection](#) (on page B-28).

NOTE

Make sure the warm-up criteria have been met, as described in the Performance verification conditions.

To check overcurrent protection:

1. Set the voltmeter as follows:
 - Set to measure DC voltage.
 - Set the current range to autorange.
2. Set the electronic load as follows:
Set to constant voltage (CV) mode.
3. Set the device under test (DUT) to 100% of the full-scale output voltage.
4. Set the overcurrent protection (OCP) threshold to 10% of full-scale output current.
5. Turn the DUT output on.
6. Set DUT current to OCP –0.3 A and then slowly increase the DUT current by 0.01 A step by step until OCP is triggered. When triggered, the output voltage abruptly drops below 1 V, and an OCP error is indicated on the display.
7. Enter the current number reading (where OCP triggering occurred) in the [DC overcurrent protection](#) (on page B-15) table for checking DC overcurrent detection.
8. Reset OCP. Press the Enter key to clear the OCP error.
9. Set the OCP threshold to 25% of full-scale output current and repeat step 5 through step 8.
10. Set the OCP threshold to 50% of full-scale output current and repeat step 5 through step 8.
11. Set the OCP threshold to 75% of full-scale output current and repeat step 5 through step 8.
12. Set the OCP threshold to 90% of full-scale output current and repeat step 5 through step 8.

Check voltage noise (20 MHz)

Equipment required	
Oscilloscope	High current 18 AWG wire
Electronic load	Coaxial cable (BNC M-M)
BNC F-to-Banana cable	

To check voltage noise (20 MHz):

1. Plug the device under test (DUT) into your local line power from the mains.
2. Plug the test oscilloscope into the same mains outlet as the DUT.

NOTE

Some AC power sources create large amounts of high frequency noise on the power line that the instrument may not fully reject. Noise directly on the mains is typically better controlled.

Use the same mains outlet for both the DUT and test oscilloscope to avoid ground loops which may cause noise.

3. Power on the DUT and test oscilloscope.
4. Set up the equipment, as shown in the following figure.

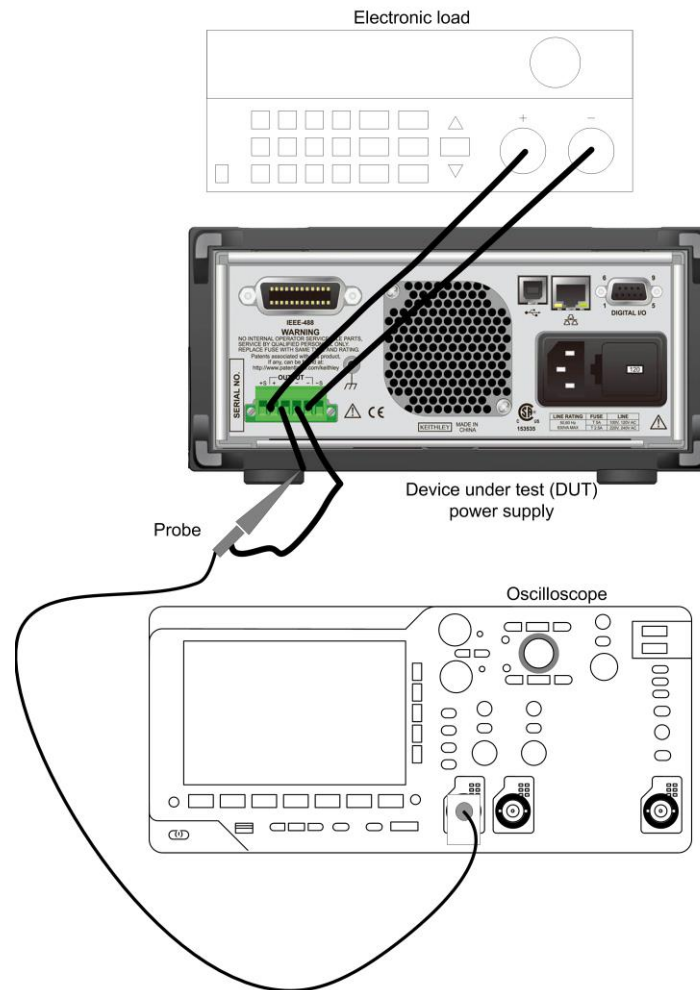
Figure 111: 20 MHz voltage and current noise test setup

5. Set the oscilloscope as follows:

- 1 mV/division
- 1 M Ω input resistance
- 20 MHz bandwidth limit
- AC coupled
- Autotrigger
- 1 ms/div
- Set to measure V_{p-p} and V_{RMS}

6. Set the DUT to the 100% full-scale output voltage.

7. Set the DUT to the 100% full-scale output current.

8. Turn the DUT output on.

9. Enter the oscilloscope measurements in the Voltage noise at 20 MHz table for checking noise at 20 MHz.

Check current noise (20 MHz)

Equipment required	
Oscilloscope	High current 18 AWG wire
Electronic Load	Coaxial cable (BNC M-M)
BNC F-to-Banana	

To check current noise (20 MHz):

1. Plug the device under test (DUT) into your local line power from the mains.
2. Plug the test oscilloscope into the same mains outlet as the DUT.

NOTE

Some AC power sources create large amounts of high frequency noise on the power line that the instrument may not fully reject. Noise directly on the mains is typically better controlled.

Use the same mains outlet for both the DUT and test oscilloscope to avoid ground loops which may cause noise.

3. Power on the DUT and test oscilloscope.
4. Set up the equipment as described in [Check voltage noise \(20 MHz\)](#) (on page B-38).
5. Set the oscilloscope as follows:
 - 1 mV/division
 - 1 M Ω input resistance
 - 20 MHz bandwidth limit
 - AC coupled
 - Autotrigger
 - 1 ms/div
 - Set to measure V_{RMS}
6. Set the DUT to the 100% full-scale output voltage.
7. Set the DUT to the 100% full-scale output current.
8. Turn the DUT output on.
9. Set the electronic load R mode (1 Ω).
10. Enter the oscilloscope measurements in the [Current noise at 20 MHz](#) (on page B-16) table for checking noise at 20 MHz.

Calibration and adjustment

In this appendix:

Overview	C-1
Environmental conditions	C-1
Calibration considerations	C-2
Calibration connection	C-6
Front-panel calibration procedure.....	C-10
Remote calibration procedure	C-16
Change the calibration password	C-24
Calibration constants.....	C-25

Overview

Use the procedures in this section to calibrate the Keithley Instruments Series 2280 Precision DC Power Supply.

WARNING

The information in this section is intended for qualified service personnel only. Do not attempt these procedures unless you are qualified to do so.

Some of these procedures may expose you to hazardous voltages that if contacted, could cause personal injury or death. Use appropriate safety precautions when working with hazardous voltages.

Calibration can be performed by using the front panel or SCPI commands.

The calibration steps test the source, over protection, and measurement circuitry.

Environmental conditions

Conduct the verification procedures in a location that has:

- An ambient temperature of 18 °C to 28 °C
- A relative humidity of less than 70%, unless otherwise noted

Warmup period

Allow the Series 2280 to warm up for at least one hour before performing calibration.

If the instrument has been subjected to temperature extremes (those outside the ranges stated in [Environmental conditions](#) (on page C-1)), allow extra time for the instrument's internal temperature to stabilize. Typically, you need to allow one extra hour to stabilize an instrument that is 10 °C outside the specified temperature range.

Also, allow the test equipment to warm up for the minimum time specified by the manufacturer.

Line power

The Series 2280 requires a line voltage of 100 V, 120 V, 220 V, or 240 V, and a line frequency of 50 Hz or 60 Hz.

NOTE

Before powering up the instrument, properly set the 100 V/120 V or 220 V/240 V selector switch located on the rear panel to the appropriate line power position.

Calibration considerations

When performing calibration procedures:

- Make sure that the equipment is properly warmed up.
- Make sure to use the 4-wire sense connection with shunt during the current calibration process to guarantee the accuracy.
- If an error occurs during a calibration, the Series 2280 generates an appropriate error message. See [Error summary](#) (on page 8-3) for more information.

Calibration cycle

Perform calibration at least once a year to ensure the instrument meets the corresponding specifications.

Required equipment

This section lists the required equipment you need for voltage and current calibration procedures. Alternate equipment may be used, as long as the equipment has specifications at least as good as those listed in the table.

NOTE

You could either select an electronic load or a resistor for calibration.

Equipment	Required specifications	Uncertainty
Digital multimeter	<ul style="list-style-type: none"> ▪ 7½ digits ▪ 90 day +/-5 °C uncertainties, see the following table 	See NOTE below.
Electronic load	<ul style="list-style-type: none"> ▪ Constant current (CC): 0.001 A to 6 A ▪ Constant voltage (CV): 0.3 V to 60 V 	See NOTE below.
Resistor (R-Load)	<ul style="list-style-type: none"> ▪ 300 Ω ▪ Temperature coefficient/ power change: Vout / (R +ΔR) <10% current measure specifications 	See NOTE below.
Shunt	<ul style="list-style-type: none"> ▪ 5.05 Ω and 0.05 Ω ▪ Temperature coefficient/ power change ▪ Vout / (R +ΔR) <10% current measure specifications 	See NOTE below.

The table lists detailed specifications for digital multimeter.

Range	PMM of Reading	PMM of Range	Resolution
0.2 V	25	6	10 nV
2.0 V	18	2	100 nV
200 V	27	3	10 μV
20 Ω	52	7	20 μΩ

NOTE

Refer to the manufacturer's specifications to calculate the uncertainty, which will vary for each test point.

Characterization shunts

Before performing calibration, you need to verify the value of the following shunts.

Shunt value	Tolerance	Calibration use
0.05 Ω	$\pm 0.0005 \Omega$	High current calibration
5.05 Ω	$\pm 0.05 \Omega$	Low current calibration

You can use the calibrated shunts, or you can use the following procedure to prepare your shunts:

- Step 1: Verify the 5.05 Ω shunt
- Step 2: Verify the 0.05 Ω shunt

Step 1

You can use 5 Ω and 0.05 Ω precision shunt resistors in series instead of the 5.05 Ω shunt resistor. To verify the value, you need to make 4-wire sense connections between the shunts and the digital multimeter (DMM).

Figure 112: Verify the precision shunt resistor

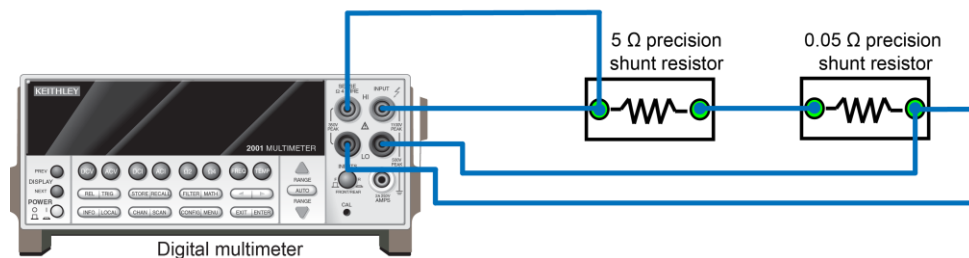

After connection, you can read the shunt value from the DMM (R_{total}). Make sure the R_{total} is within the range of $5.05 \pm 0.05 \Omega$. If it is not, adjust your shunts to guarantee the total shunt value is in the required range.

Step 2

To verify the 0.05 Ω precision shunt resistor, you need to measure two voltages:

Voltage	Description
V_{total}	The total voltage across the two shunts
$V_{0.05}$	The voltage across the 0.05 Ω shunt

Then calculate the value of the 0.05 Ω shunt using the following formula:

$$R_{0.05} = V_{0.05} * R_{total} / V_{total}$$

You need to connect the shunt with the power supply, electronic load, and digital multimeter. For details, see the following figures. After you have made the connections, configure the settings for the power supply and electronic load, as shown in the following table.

Measure step	Power supply	Electronic load
V_{total}	1.0 V, 0.2 A, constant voltage mode	2.0 V, 0.2 A, constant current mode
$V_{0.05}$	1.0 V, 0.2 A, constant voltage mode	2.0 V, 0.2 A, constant current mode

Figure 113: Measure the voltage across the shunts

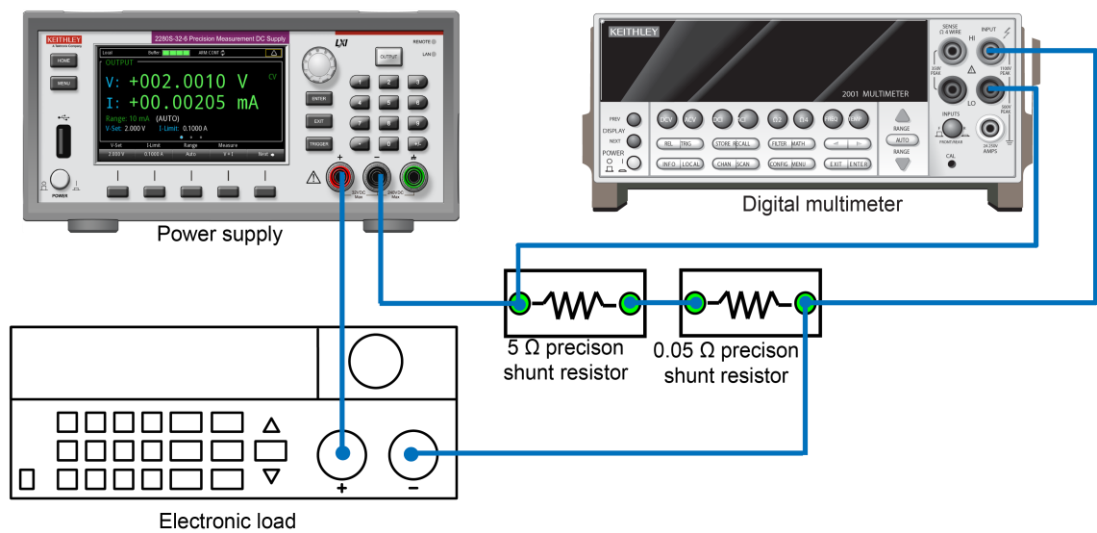
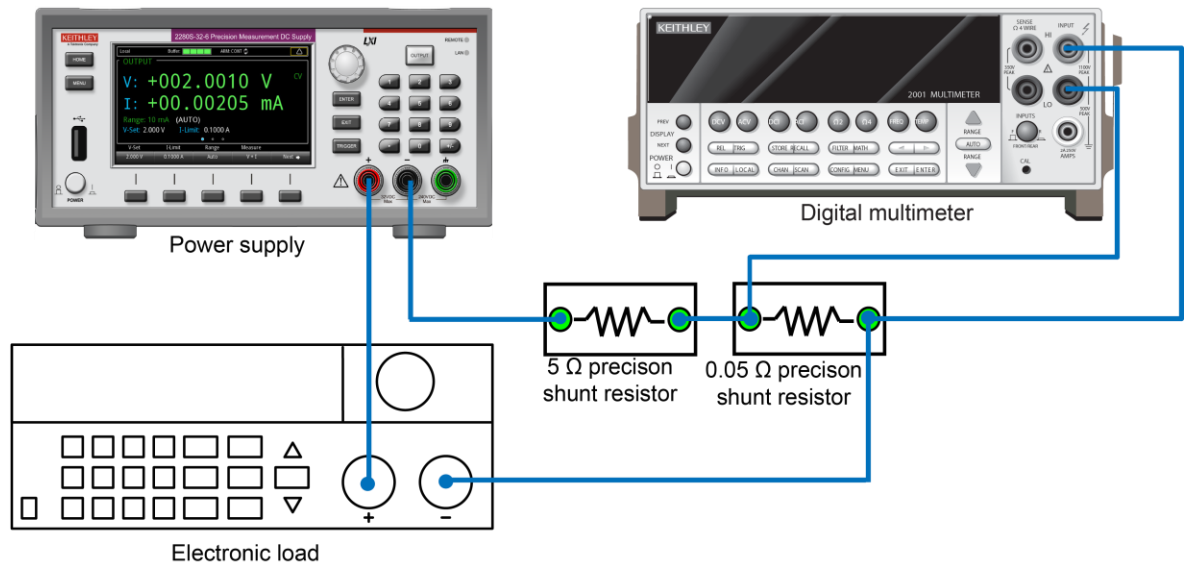

Figure 114: Measure the voltage across the 0.05 ohm shunt

Calibration connection

You can calibrate the instrument using the front panel or by remote commands using ethernet, GPIB, or USB interfaces. Refer to [Remote communications interfaces](#) (on page 2-44) for more information on communicating with the instrument.

The calibration instructions for the Series 2280 include the following procedures:

- Voltage calibration
- Low-current calibration on the 10 mA and 100 mA ranges
- High-current calibration on the 1 A and 10 A ranges

You can perform these calibration procedures individually, but for the instrument to be calibrated properly, all the procedures must be performed. After each procedure, save the calibration result and exit the calibration procedure.

Before calibration, make sure the correct connections are made between the instrument and the test equipment.

Voltage calibration connections

For voltage calibration, connect the digital multimeter (DMM) to the Series 2280. For the DMM specifications, see [Required equipment](#) (on page C-3).

Figure 115: Voltage calibration connections

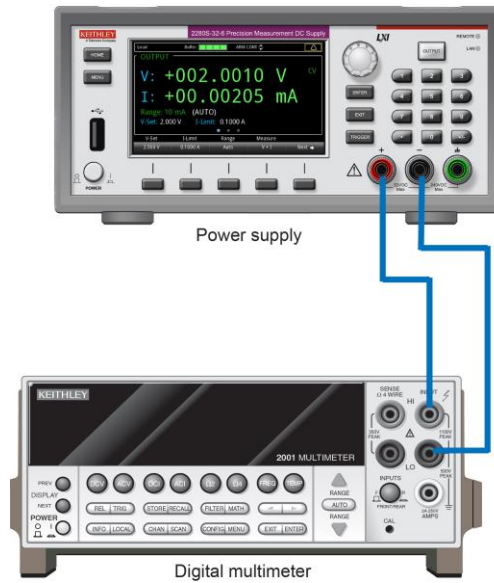

NOTE

When you are using a binding post on the front panel to make a calibration connection, insert the jumper wires to short the output terminals and sense terminals on the rear panel. For details, see the following figure.

Figure 116: Install the output mating connector for 4-wire operation

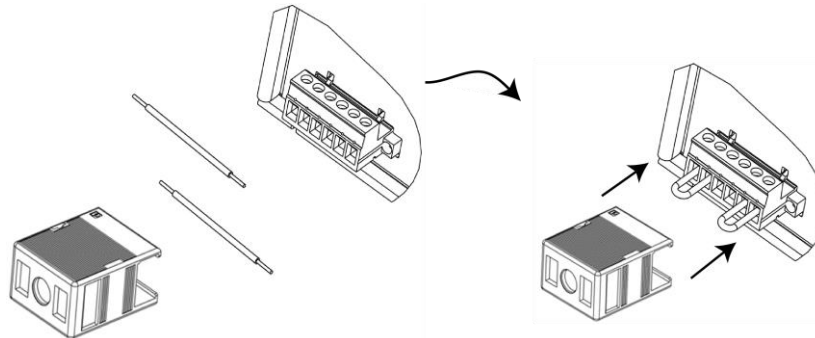

Use the following steps to short the output terminals and sense terminals:

Step	Description
1	Insert the jumper wires in the output mating connector.
2	Connect the mating connector to the terminal on the back side of the Series 2280.
3	Slide the cable housing over the output mating connector and wires.

Current calibration connections

For current calibration, the following equipment is required:

- Digital multimeter
- Precision shunt resistors
- Electronic load or resistor

You can use either an electronic load or a resistor to perform current calibration.

NOTE

When calibrating the 1 A and 10 A ranges (step 5 to step 8), we recommend that you use an electronic load for lowest thermal drift and current stability. When calibrating the 10 mA and 100 mA ranges (step 3 and step 4), we recommend that you use a resistive load for lowest noise and repeatability.

You are required to change the shunt and load configuration for certain steps. Refer to the figures for proper setup.

Figure 117: High-current calibration connection using an electronic load

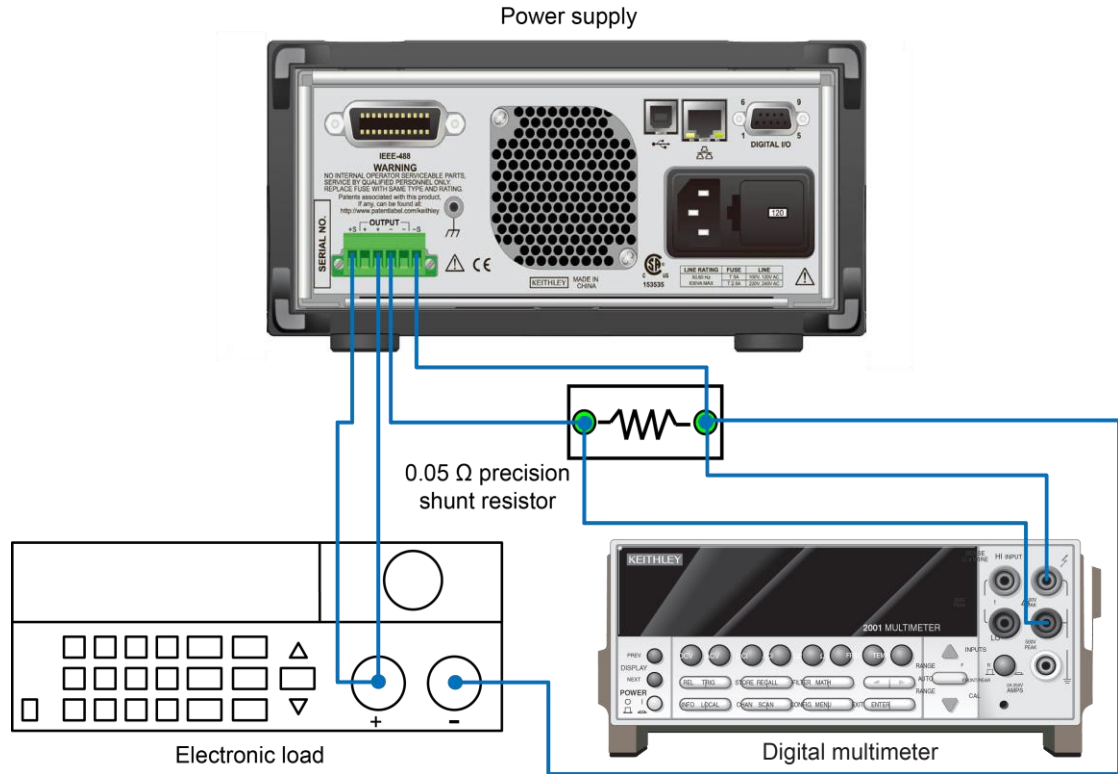
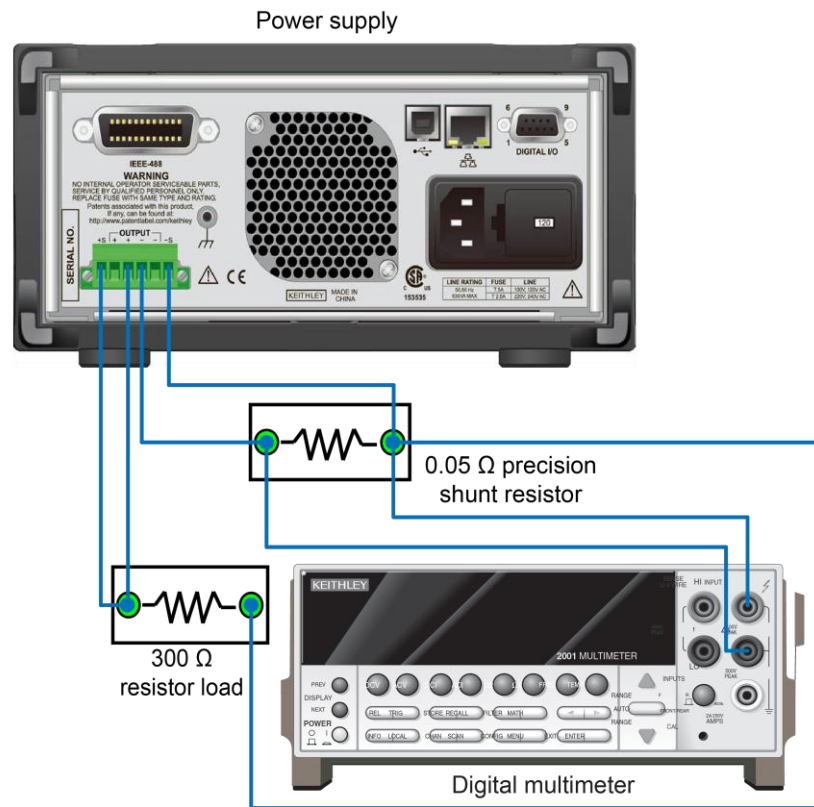

Figure 118: Low-current calibration connection using a resistor



Front-panel calibration procedure

To perform calibration from the front panel:

1. Turn on the instrument and allow it to warm up for at least one hour before performing the calibration.
2. Press the **MENU** key.
3. In the System Information menu, select **Calibrate**. The keypad is displayed.
4. Enter the calibration password and select **OK** on the keypad. The default password is **KI002280**.

NOTE

If you forget the calibration password, you can reset your password to the factory default. For details, refer to [Change calibration password](#) (on page C-24).

5. The Series 2280 will prompt you to make connections and start to calibrate voltage and current. Refer to the instructions on the following pages.

Voltage calibration

Connect the instrument to a digital multimeter (DMM). For details, see [Voltage calibration connection](#) (on page C-7).

NOTE

You must input the measured value from the DMM. The value should be within the expected range. A message will indicate if the DMM data entry was out of the expected range. Verify that the proper shunt value was used or that the cables are properly connected.

For Model 2280S-32-6, the expected values are shown in the following table.

Steps	Maximum voltage	Minimum voltage
1	0.55 V	0.05 V
2	32 V	28 V

For Model 2280S-60-3, the expected values are shown in the following table.

Steps	Maximum voltage	Minimum voltage
1	1.15 V	0.05 V
2	58.25 V	54.25 V

Step 1

1. Enter the measured result from the DMM.
2. After entering the data, the waiting window is displayed. You need to wait a few seconds for the internal measurements and calculations. The step 2 calibration window is displayed.

Step 2

1. Enter the measured result from the DMM.
2. After entering the data, the waiting window is displayed. You need to wait a few seconds for the internal measurements and calculations. Then the Save window is displayed.
3. You can save the calibration results or continue to the next calibration step. For the details on saving, see [Saving calibration constants from the front panel](#) (on page C-15). If you want to continue the calibration, press the **Next** soft key.

NOTE

After each calibration step, the Series 2280 output is set to a safe low-voltage level, preventing inadvertent harm to the user, instrument, or load.

Low-current calibration

Perform the following steps to finish the low-current calibration:

Step 3 and step 4: Current calibration on the 10 mA and 100 mA ranges

NOTE

You must input the measured value from the DMM. The value should be within the expected range. A message will indicate if the DMM data entry was out of the expected range. Verify that the proper shunt value was used or that the cables are properly connected.

For Model 2280S-32-6, the expected values are shown in the following table.

Steps	Maximum voltage	Minimum voltage
3	15.150 mV	0 V
4	1.515 V	0.02 V

For Model 2280S-60-3, the expected values are shown in the following table.

Steps	Maximum voltage	Minimum voltage
3	15.150 mV	0 V
4	1.515 V	0.02 V

Step 3

1. Before starting this calibration step, configure the shunt and load (electronic load or resistor load) as shown in the following table.

Model	Shunt	Electronic load			Resistor load
2280S-32-6	5.05 Ω	Constant current mode	1.5 V	0.001 A	300 Ω
2280S-60-3	5.05 Ω	Constant current mode	1.5 V	0.001 A	300 Ω

2. Enter the shunt value and press the **ENTER** key.
3. Enter the measured result from the digital multimeter (DMM) and press the **ENTER** key.
4. After entering the data, the waiting window is displayed. You need to wait a few seconds for the internal measurements and calculations. The step 4 window is displayed.

Step 4

1. Before starting this calibration step, configure the shunt and load (electronic load or resistor load) as shown in the following table.

Model	Shunt	Electronic load			Resistor load
2280S-32-6	5.05 Ω	Constant current mode	32 V	0.1 A	300 Ω
2280S-60-3	5.05 Ω	Constant current mode	30 V	0.1 A	300 Ω

2. Enter the measured result from the digital multimeter (DMM) and press the **ENTER** key.
3. After entering the data, the waiting window is displayed. You need to wait a few seconds for the internal measurements and calculations. Then the Save window is displayed.
4. You can save the calibration results or continue to the next calibration step. For the details on saving, see [Saving calibration constants from the front panel](#) (on page C-15). If you want to continue the calibration, press the **Next** soft key.

High-current calibration

Connect the instrument with the digital multimeter (DMM), precision shunt resistor, and electronic load (or resistor). For details, see [Current calibration connections](#) (on page C-8).

Perform the following steps to finish the high-current calibration:

Steps 5 through 8: Current calibration on the 1 A and 10 A ranges

NOTE

You must input the measured value from the DMM. The value should be within the expected range. A message will indicate if the DMM data entry was out of the expected range. Verify that the proper shunt value was used or that the cables are properly connected.

For Model 2280S-32-6, the expected values are shown in the following table.

Steps	Maximum voltage	Minimum voltage
5	0.015 V	6e ⁻⁴ V
6	Not applicable	Not applicable
7	1.5 V	0.06 V
8	Not applicable	Not applicable

For Model 2280S-60-3, the expected values are shown in the following table.

Steps	Maximum voltage	Minimum voltage
5	$7.5e^{-3}$ V	$3e^{-4}$ V
6	Not applicable	Not applicable
7	0.8 V	0.032 V
8	Not applicable	Not applicable

WARNING

The Series 2280 has 200 W of constant output power. Make sure that cables, shunts, and loads are properly rated for the intended current. Incorrect shunt connections, such as using the 5.05 Ω shunt during step 5 and step 6, can cause damage.

Step 5

1. Before starting this calibration step, configure the shunt and load (electronic load or resistor load) as shown in the following table.

Model	Shunt	Electronic load			Resistor load
2280S-32-6	0.05 Ω	Constant current mode	1.5 V	0.06 A	5 Ω
2280S-60-3	0.05 Ω	Constant current mode	1.5 V	0.03 A	20 Ω

2. Enter the external shunt value and press the **ENTER** key.
3. Enter the measured result from the digital multimeter (DMM) and press the **ENTER** key.
4. After entering the data, the waiting window is displayed. You need to wait a few seconds for the internal measurements and calculations. The step 6 calibration window is displayed.

Step 6

1. Before starting this calibration step, configure the shunt and load (electronic load or resistor load) as shown in the following table.

Model	Shunt	Electronic load			Resistor load
2280S-32-6	0.05 Ω	Constant voltage mode	0.3 V	0.5 A	5 Ω
2280S-60-3	0.05 Ω	Constant voltage mode	0.6 V	0.5 A	20 Ω

2. Wait for the instrument to take internal measurements and calculations.

Step 7

1. Before starting this calibration step, configure the shunt and load (electronic load or resistor load) as shown in the following table.

Model	Shunt	Electronic load			Resistor load
2280S-32-6	0.05 Ω	Constant current mode	32 V	6.0 A	5 Ω
2280S-60-3	0.05 Ω	Constant current mode	60 V	3 A	20 Ω

2. Enter the measured result from the digital multimeter (DMM) and press the **ENTER** key.

After entering the data, the waiting window is displayed. You need to wait a few seconds for the internal measurements and calculations. The step 8 calibration window is displayed.

Step 8

1. Before starting this calibration step, configure the shunt and load (electronic load or resistor load) as shown in the following table.

Model	Shunt	Electronic load			Resistor load
2280S-32-6	0.05 Ω	Constant voltage mode	30 V	6.5 A	5 Ω
2280S-60-3	0.05 Ω	Constant voltage mode	56.25 V	3.5 A	20 Ω

2. Wait for the instrument to take internal measurements and calculations. Measurements are complete when the Save window is displayed.
3. Press **Save** to save all the calibration constants to system internal memory. If you press **Cancel**, you will lose all the calibration constants and exit the calibration.

Saving calibration constants from the front panel

1. Press the **Save** soft key. The Enter Date window is displayed.
2. Enter the present date and press the **ENTER** key. The date and calibration constants are saved to instrument's internal memory.

Remote calibration procedure

Before performing a calibration by remote control, check the system date of the Series 2280. This can be done by sending the following commands:

```
:SYSTem:DATE?  
:SYSTem:TIME?
```

If the date is incorrect, the date and time need to be modified using the following commands:

```
:SYSTem:DATE <year>, <month>, <day>  
:SYSTem:TIME <hour>, <minute>, <second>
```

Make sure to enter the correct date and time using the 24-hour clock. If the date is incorrect, it will not save the proper date when calibration is saved using SCPI commands. For additional information about this command, see [:SYSTem:DATE](#) (on page 7-115) and [:SYSTem:TIME](#) (on page 7-126).

To perform calibration from a remote interface:

1. Connect the Series 2280 to the computer using one of the following methods:
 - Use a shielded IEEE-488 cable, such as Keithley Instruments Model 7007
 - Use a standard LAN crossover cable to connect to the ethernet port
 - Use a USB cable to connect to the USB port
2. Turn on the Series 2280 and allow it to warm up for at least one hour before performing calibration.
3. Make sure the address of the Series 2280 is the same as the address specified in the program that you will be using to send commands. For more information, refer to [Remote communications interfaces](#) (on page 2-44).
4. Unlock the calibration function by sending the following command:

```
:CALibration:PROTected:STATe ON, "password"
```

The default password for calibration is KI002280.

NOTE

During remote calibration, the front-panel display may not show the actual calibration source and measurements. Also, only the local soft key is supported, and additional key selections are ignored. Calibration must be disabled before local keys are active.

Refer to [:CALibration:PROTected:STATe](#) (on page 7-44) for additional details.

5. Send each calibration command with *OPC? appended to allow the program to know when the operation is complete.

Remote voltage calibration

1. Connect the digital multimeter (DMM) to the instrument. For details, see [Voltage calibration connection](#) (on page C-7).
2. Perform calibration step 1 and step 2.

NOTE

You must input the measured value from the DMM. The value should be within the expected range. A message will indicate if the DMM data entry was out of the expected range. Verify that the proper shunt value was used or that the cables are properly connected.

You can send `SYST:ERR?` to query any error messages and error event codes. For calibration error messages and codes, refer to [Error summary](#) (on page 8-3).

For the Model 2280S-32-6, the expected value is shown in the following table.

Steps	Maximum voltage	Minimum voltage
1	0.55 V	0.05 V
2	32 V	28 V

For Model 2280S-60-3, the expected value is shown in the following table.

Steps	Maximum voltage	Minimum voltage
1	1.15 V	0.05 V
2	58.25 V	54.25 V

Step 1

1. Send the following command to prepare calibration step 1:

```
CALibration:PROTEcted:STEP1
```

2. Send the measured result from the digital multimeter (DMM) by the command:

```
CALibration:PROTEcted:STEP1:DATA <voltage>
```

3. The instrument begins to take internal measurements. This will take a few seconds. To query the operation status, send the command:

```
*OPC?
```

After all of the operations are completed, the instrument returns 1.

Step 2

1. Prepare for step 2 by sending the command:

```
:CALibration:PROTeCted:STEP2
```

2. Send the measured result from the digital multimeter (DMM) by sending the command:

```
:CALibration:PROTeCted:STEP2:DATA <voltage>
```

3. Send the following command to query the operation status:

```
*OPC?
```

After all of the operations are completed, the instrument returns 1.

NOTE

After each calibration step, the Series 2280 output is set to a safe low-voltage level, preventing inadvertent harm to the user, instrument, or load.

Remote low-current calibration

Connect the instrument with the digital multimeter (DMM), shunt, and electronic load (or resistor). For details, see [Current calibration connections](#) (on page C-8).

You need to perform the following steps to finish the low-current calibration:

Steps 3 and 4: Current calibration on the 10 mA and 100 mA ranges

NOTE

You must input the measured value from the DMM. The value should be within the expected range. A message will indicate if the DMM data entry was out of the expected range. Verify that the proper shunt value was used or that the cables are properly connected.

You can send `SYST:ERR?` to query any error messages and error event codes. For calibration error messages and codes, refer to [Error summary](#) (on page 8-3).

For Model 2280S-32-6, the expected values are shown in the following table.

Steps	Maximum voltage	Minimum voltage
3	1.515e ⁻² V	2.0e ⁻³ V
4	1.515 V	0.02 V

For Model 2280S-60-3, the expected values are shown in the following table.

Steps	Maximum voltage	Minimum voltage
3	1.515e ⁻² V	2.0e ⁻³ V
4	1.515 V	0.02 V

Step 3

1. Before calibration, configure the shunt and load (electronic load or resistor load), as shown in the following table.

Model	Shunt	Electronic load			Resistor load
2280S-32-6	5.05 Ω	Constant current mode	1.5 V	0.001 A	300 Ω
2280S-60-3	5.05 Ω	Constant current mode	1.5 V	0.001 A	300 Ω

2. Send the command to prepare for step 3:

```
:CALibration:PROTeCted:STEP3
```

3. Send the measured result from the digital multimeter (DMM) and shunt value using the following command:

```
:CALibration:PROTeCted:STEP3:DATA <voltage>, <resistance>
```

4. Send the following command to query the operation status:

```
*OPC?
```

After all of the operations are completed, the instrument returns 1.

Step 4

1. Before calibration, configure the shunt and load (electronic load or resistor load), as shown in the following table.

Model	Shunt	Electronic load			Resistor load
2280S-32-6	5.05 Ω	Constant current mode	32 V	0.1 A	300 Ω
2280S-60-3	5.05 Ω	Constant current mode	30 V	0.1 A	300 Ω

2. Send the command to prepare for step 4:

```
:CALibration:PROTeCted:STEP4
```

3. Send the measure result from the DMM and shunt value using the following command:

```
:CALibration:PROTeCted:STEP4:DATA <voltage>, <resistance>
```

4. Send the following command to query the operation status:

```
*OPC?
```

After all of the operations are completed, the instrument returns 1.

Remote high-current calibration

1. Connect the instrument with the digital multimeter (DMM), shunt, and load (electronic load or resistor). For details, see [Current calibration connections](#) (on page C-8).
2. Perform calibration step 5 to step 8.

NOTE

You must input the measured value from the DMM. The value should be within the expected range. A message will indicate if the DMM data entry was out of the expected range. Verify that the proper shunt value was used or that the cables are properly connected.

You can send `SYST:ERR?` to query any error messages and error event codes. For calibration error messages and codes, refer to [Error summary](#) (on page 8-3).

For Model 2280S-32-6, the expected values are shown in the following table.

Steps	Maximum voltage	Minimum voltage
5	0.015 V	$6e^{-4}$ V
6	Not applicable	Not applicable
7	1.5 V	0.06 V
8	Not applicable	Not applicable

For Model 2280S-60-3, the expected values are shown in the following table.

Steps	Maximum voltage	Minimum voltage
5	$7.5e^{-3}$ V	$3e^{-4}$ V
6	Not applicable	Not applicable
7	0.8 V	0.032 V
8	Not applicable	Not applicable

WARNING

The Series 2280 has 200 W of constant output power. Make sure that cables, shunts, and loads are properly rated for the intended current. Incorrect shunt connections, such as using the 5.05 Ω shunt during step 5 and step 6, can cause damage.

Step 5

1. Before calibration, configure the shunt and load (electronic load or resistor load), as shown in the following table.

Model	Shunt	Electronic load			Resistor load
2280S-32-6	0.05 Ω	Constant current mode	1.5 V	0.06 A	5 Ω
2280S-60-3	0.05 Ω	Constant current mode	1.5 V	0.03 A	20 Ω

2. Send the command to prepare for step 5:

```
:CALibration:PROTECTED:STEP5
```

3. Send the measured result from the digital multimeter (DMM) and shunt value by sending the command:

```
:CALibration:PROTECTED:STEP5:DATA <voltage>, <resistance>
```

4. The instrument begins to take internal measurements. This will take a few seconds. To query the operation status, send the command:

```
*OPC?
```

After all of the operations are completed, the instrument returns 1.

Step 6

1. Before calibration, configure the shunt and load (electronic load or resistor load), as shown in the following table.

Model	Shunt	Electronic load			Resistor load
2280S-32-6	0.05 Ω	Constant voltage mode	0.3 V	0.5 A	5 Ω
2280S-60-3	0.05 Ω	Constant voltage mode	0.6 V	0.5 A	20 Ω

2. Send the command to prepare for step 6:

```
:CALibration:PROTECTED:STEP6
```

3. Send the following command to take internal measurements and calculations:

```
:CALibration:PROTECTED:STEP6:DATA
```

4. Send the following command to query the operation status:

```
*OPC?
```

After all of the operations are completed, the instrument returns 1.

Step 7

1. Before calibration, configure the shunt and load (electronic load or resistor load), as shown in the following table.

Model	Shunt	Electronic load			Resistor load
2280S-32-6	0.05 Ω	Constant current mode	32 V	6.0 A	5 Ω
2280S-60-3	0.05 Ω	Constant current mode	60 V	3 A	20 Ω

2. Send the command to prepare for step 7:

```
:CALibration:PROTeCted:STEP7
```

3. Send the measured result from the digital multimeter (DMM) and shunt value by sending the command:

```
:CALibration:PROTeCted:STEP7:DATA <voltage>, <resistance>
```

4. Send the following command to query the operation status:

```
*OPC?
```

After all of the operations are completed, the instrument returns 1.

Step 8

1. Before calibration, configure the shunt and load (electronic load or resistor load), as shown in the following table.

Model	Shunt	Electronic load			Resistor load
2280S-32-6	0.05 Ω	Constant voltage mode	30 V	6.5 A	5 Ω
2280S-60-3	0.05 Ω	Constant voltage mode	56.25 V	3.5 A	20 Ω

2. Send the command to prepare for step 8:

```
:CALibration:PROTeCted:STEP8
```

3. Send the following command to take internal measurements and calculations:

```
:CALibration:PROTeCted:STEP8:DATA
```

4. Send the following command to query the operation status:

```
*OPC?
```

After all of the operations are completed, the instrument returns 1.

Saving calibration constants using SCPI commands

You can save the calibration constants to internal memory after each calibration procedure by sending:

```
:CALibration:PROTECTED:SAVE
```

However, it works differently when sending this command after each step in a procedure. See the following table.

Calibration step	What is saved to internal memory:
Step 1	Nothing is saved.
Step 2 and step 3	Only voltage calibration constants are saved.
Step 4 and step 7	The following calibration constants are saved: <ul style="list-style-type: none"> ▪ Voltage calibration constants ▪ Current calibration constants for the 10 mA and 100 mA ranges
Step 8	Saves all of the calibration constants.

You can also cancel the calibration and eliminate the new constants by sending:

```
:CALibration:PROTECTED:CANCEL
```

When you save the constants, you need to configure the calibration date. For details, see [Configure the calibration date](#) (on page C-23).

Configure the calibration date

You can configure the calibration date before saving the calibration constants. You can also configure it after saving.

To configure the date, send the following command:

```
:CALibration:PROTECTED:DATE <year>,<month>,<day>
```

NOTE

If you do not configure the date for calibration, the instrument uses the last calibration date.

Exit the calibration procedure using SCPI commands

After saving the calibration results, exit the calibration procedure by sending:

```
:CALibration:PROTECTED:STAT OFF, "password"
```

The default password for calibration is KI002280.

NOTE

If you do not exit the calibration, you will receive error code 109, "Not permitted with cal unlocked," when you send the commands not included in the calibration command subsystem.

Change the calibration password

To change the calibration password from the front panel:

1. Press the **MENU** key.
2. Under System, select **Settings**.
3. Select the button next to System Password and press **ENTER**. The System Password screen is displayed.
4. Select **Calibration** and press **ENTER**. The Input Original Password screen is displayed.
5. Enter the original password.
6. Select the **OK** button on the displayed keyboard. An Input New Password screen is displayed.
7. Enter the new password.
8. Select the **OK** button on the displayed keyboard. A verification screen is displayed.
9. Enter the new password again.
10. Select the **OK** button on the displayed keyboard. The password is reset.

To change the remote control password using SCPI command:

```
:CALibration:PROTECTED:CODE <string>
```

Where <string> is the new password.

Calibration constants

You can use the following command to read all the calibration constants in order of their index number:

```
:CALibration:PROTECTED:DATA?
```

For Model 2280S-60-3, the default calibration constants are listed in the following table.

Index number	Default constant value	Default constant tolerance	Calibration steps	Error code
1	0.05 Ω	0.2 Ω	Step 5 Step 7	123, Step5 10A shunt value out of range; 128, Step7 10A shunt value out of range
2	5.05 Ω	10.1 Ω	Step 3 Step 4	116, Step3 100mA shunt value out of range; 120, Step4 100mA shunt value out of range
3	0.1	0.02	Step 1	110, Step1 Kmath error
4	0.6 V	0.55 V	Step 1	111, Step1 V-DAC zero DMM reading out of range
5	1.294e ⁻²	2.589e ⁻²	Step 1	112, Step1 V-ADC zero collected data error
6	56.25 V	2 V	Step 2	113, Step2 V-DAC full scale DMM reading out of range
7	1.294	0.1294	Step 2	114, Step2 V-ADC full scale collected data error
8	1.500e ⁻³ V	6.000e ⁻³ V	Step 5	122, Step5 I-ADC 10A zero DMM reading out of range
9	4.285e ⁻³	8.571e ⁻³	Step 5	124, Step5 I-ADC 10A zero collected data error
10	4.285e ⁻²	8.571e ⁻²	Step 5	125, Step5 I-ADC 1A zero collected data error
11	1.600e ⁻¹ V	6.400e ⁻¹ V	Step 7	127, Step7 I-ADC 10A full scale DMM reading out of range
12	4.571e ⁻¹	4.571e ⁻²	Step 7	129, Step7 I-ADC 10A full scale collected data error
13	8.571e ⁻³	1.714e ⁻²	Step 6	126, Step6 I-DAC zero collected data error
14	8.214e ⁻¹	8.214e ⁻²	Step 8	130, Step8 I-DAC full scale collected data error
15	5.050e ⁻³ V	1.010e ⁻² V	Step 3	115, Step3 I-ADC 100mA zero DMM reading out of range
16	1.428e ⁻²	2.857e ⁻²	Step 3	117, Step3 I-ADC 100mA zero collected data error
17	1.428e ⁻¹	2.857e ⁻¹	Step 3	118, Step3 I-ADC 10mA zero collected data error
18	0.505 V	1.01 V	Step 4	119, Step4 I-ADC 100mA full scale DMM reading out of range
19	1.428	1.428e ⁻¹	Step 4	121, Step4 I-ADC 100mA full scale collected data error

For Model 2280S-32-6, the default calibration constants are listed in the following table.

Index number	Default constant value	Default constant tolerance	Calibration steps	Error code
1	0.05 Ω	0.2 Ω	Step 5 Step 7	123, Step5 10A shunt value out of range; 128, Step7 10A shunt value out of range
2	5.05 Ω	10.1 Ω	Step 3 Step 4	116, Step3 100mA shunt value out of range; 120, Step4 100mA shunt value out of range
3	0.1	0.02	Step 1	110, Step1 Kmath error
4	0.3 V	0.25 V	Step 1	111, Step1 V-DAC zero DMM reading out of range
5	1.294e ⁻²	2.589e ⁻²	Step 1	112, Step1 V-ADC zero collected data error
6	30 V	2 V	Step 2	113, Step2 V-DAC full scale DMM reading out of range
7	1.2946	0.12946	Step 2	114, Step2 V-ADC full scale collected data error
8	0.003 V	0.0112 V	Step 5	122, Step5 I-ADC 10A zero DMM reading out of range
9	8.571e ⁻³	1.714e ⁻²	Step 5	124, Step5 I-ADC 10A zero collected data error
10	8.571e ⁻²	1.714 e ⁻¹	Step 5	125, Step5 I-ADC 1A zero collected data error
11	0.3 V	1.2 V	Step 7	127, Step7 I-ADC 10A full scale DMM reading out of range
12	8.571e ⁻¹	8.571e ⁻²	Step 7	129, Step7 I-ADC 10A full scale collected data error
13	8.571e ⁻³	1.714e ⁻²	Step 6	126, Step6 I-DAC zero collected data error
14	8.2142e ⁻¹	8.214e ⁻²	Step 8	130, Step8 I-DAC full scale collected data error
15	5.050e ⁻³ V	1.010e ⁻² V	Step 3	115, Step3 I-ADC 100mA zero DMM reading out of range
16	1.428e ⁻²	2.857e ⁻²	Step 3	117, Step3 I-ADC 100mA zero collected data error
17	1.428e ⁻¹	2.857e ⁻¹	Step 3	118, Step3 I-ADC 10mA zero collected data error
18	0.505 V	1.01 V	Step 4	119, Step4 I-ADC 100mA full scale DMM reading out of range
19	1.428	1.428e ⁻¹	Step 4	121, Step4 I-ADC 100mA full scale collected data error

Status model

In this appendix:

Overview	D-1
Programming and reading registers	D-5
Clearing the registers	D-6
Status byte and service request	D-7
Status register sets.....	D-9
Queues.....	D-20
Serial polling and SRQ	D-21
Status model programming examples	D-22

Overview

The status model consists of status register sets and queues. You can monitor the status model to view instrument events; you can also configure the status model to control the events. The most essential part of the status structure is the Status Byte Register. This register can be read by a test program to determine if a service request (SRQ) has occurred and what event caused it.

As you work with the status model, remember that the end result applies to the Status Byte Register. All the status register sets and queues flow into the Status Byte Register. Your test program can read this register to determine if a service request (SRQ) has occurred, and if so, which event caused it.

The Status Byte Register sets and queues include:

- Standard Event Register
- Questionable Event Register: Questionable Instrument Event Register (Questionable Instrument Summary Event Register)
- Operation Event Register: Operation Instrument Event Register (Operation Instrument Summary Event Register)
- Measurement Event Register: Measurement Instrument Event Register (Measurement Instrument Summary Event Register)
- Output queue
- Error queue

The structure of status model is shown in the diagram in [Status model structure](#) (on page D-2). The relationship between Questionable Event Register, Questionable Instrument Event Register, and Questionable Instrument Summary Event Register is shown in the diagram in [Questionable registers](#) (on page D-3).

The relationship between Operation Event Register, Operation Instrument Event Register, and Operation Instrument Summary Event Register is shown in the diagram in [Operation registers](#) (on page D-4).

The relationship between Measurement Event Register, Measurement Instrument Event Register, and Measurement Instrument Summary Event Register is shown in the diagram in [Measurement registers](#) (on page D-4).

Figure 119: Series 2280 status model diagram

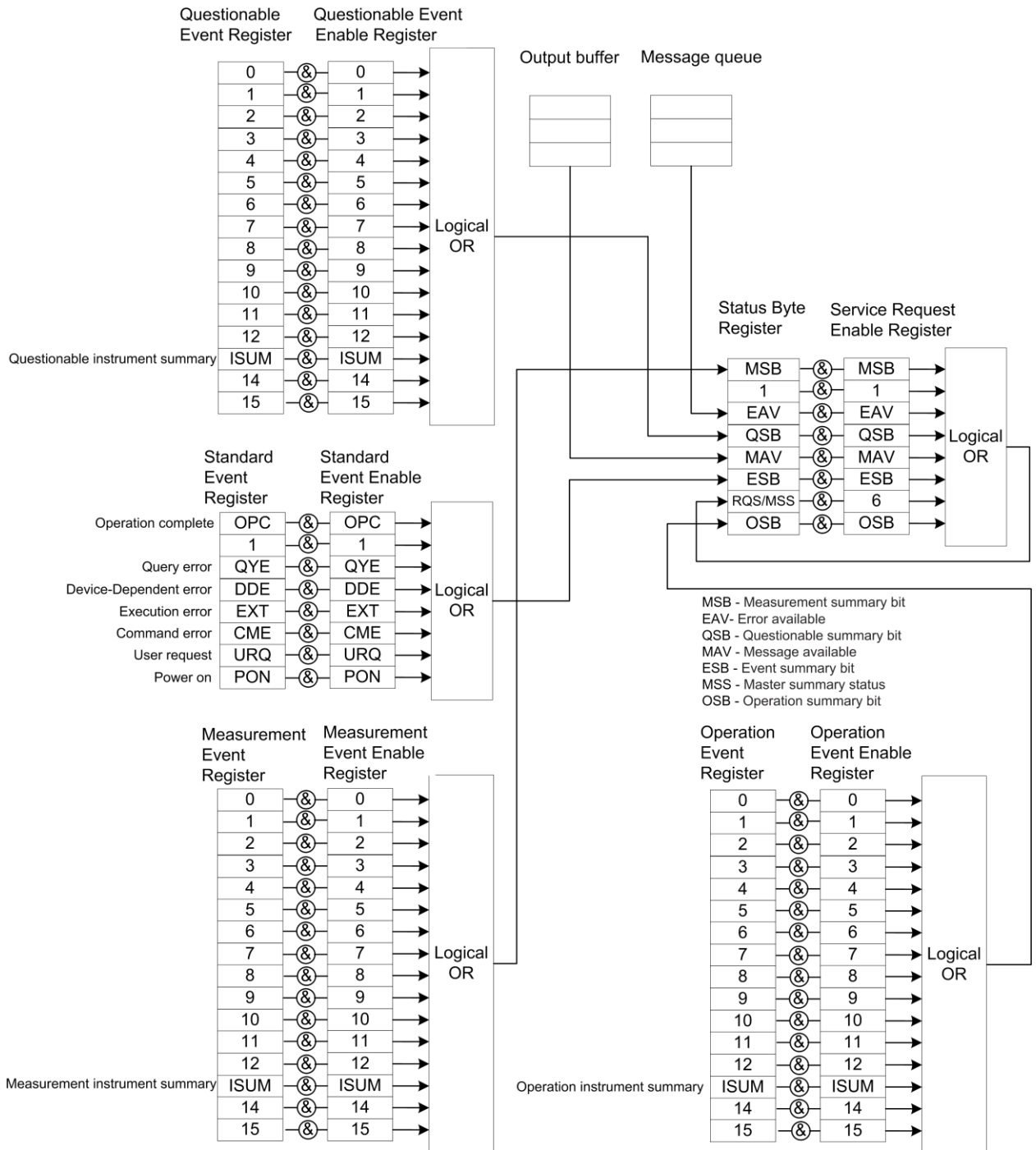

Figure 120: Questionable registers diagram

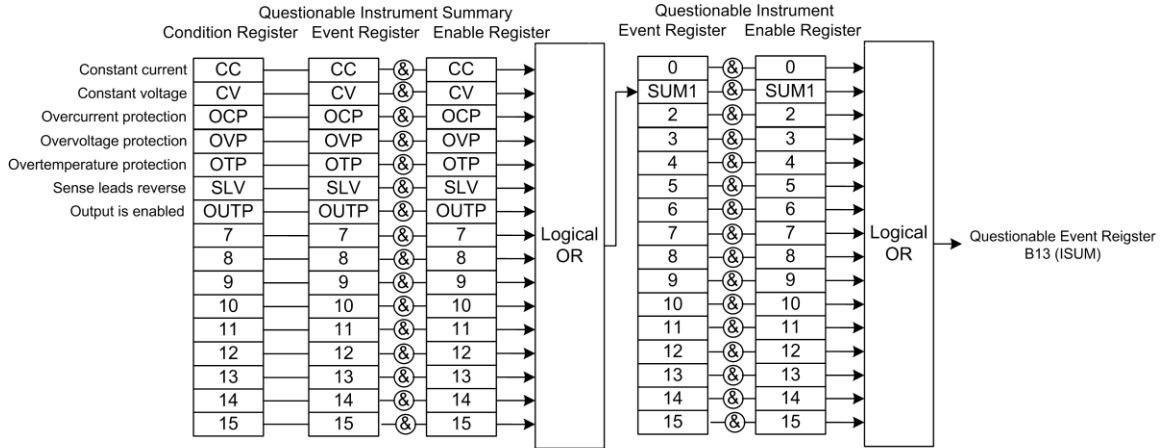

Figure 121: Operation registers diagram

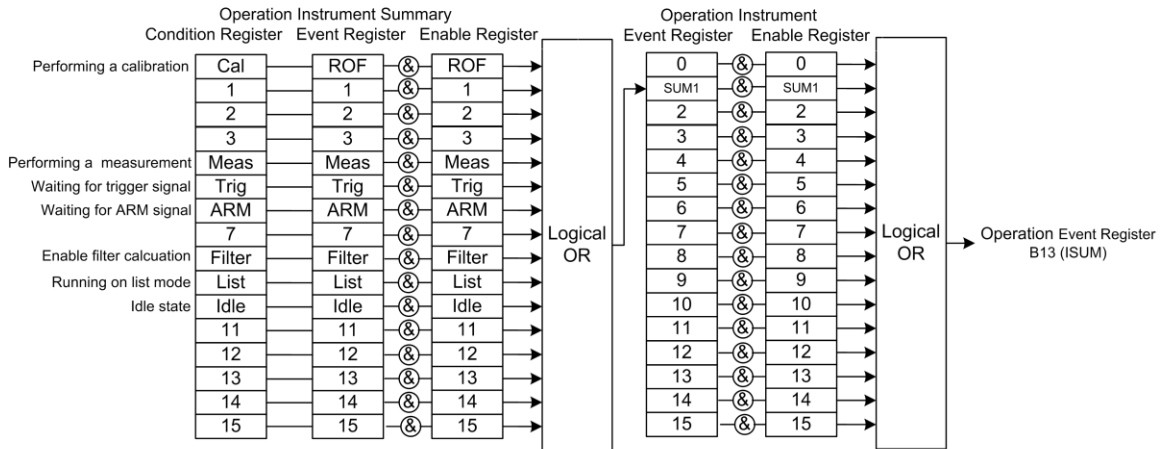
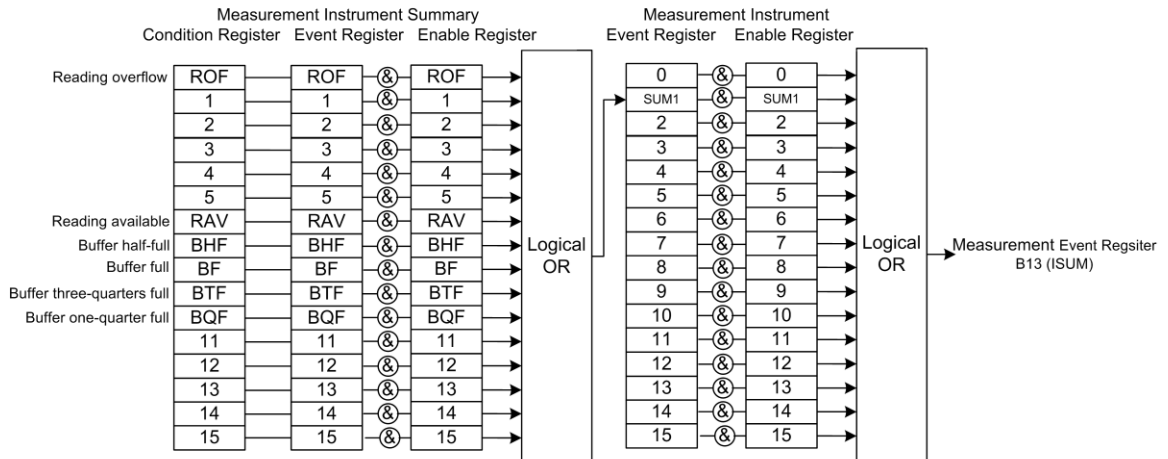

Figure 122: Status model measurement registers



Programming and reading registers

When you write to or read a status register, you can use binary, decimal, or hexadecimal values to represent the binary values of the bit states. When the value is converted to its binary equivalent, you can determine which bits are set on or clear. Zero (0) indicates that all bits are clear.

Programming enable registers

You can program the bits in the enable registers of the status model registers.

When you program an enable register bit to 0, no action occurs if the bits in the corresponding registers are set (1).

When you program an enable register bit to 1, if the bits in the corresponding registers are set (1), the AND condition occurs.

You must program all bits in an enable register at the same time. This means that you need to determine what each bit value in the register will be, then add them together to determine the value of all the bits in the register. See [Register bit descriptions](#) (on page D-9) for more information on determining the value of the bits in the registers.

For example, you might want to enable the Standard Event Register to set the event status bit (ESB) in the Status Byte Register whenever an operation complete event occurs or whenever an operation did not execute properly because of an internal condition. To do this, set bits 0 and 3 of the Standard Event Status Enable Register to 1. These bits have decimal values of 1 and 8, so to set both bits to 1, set the register to 9 by sending SCPI command `*ese 9`.

Reading the registers

You can read any register in the Status Model. The response is a decimal value that indicates which bits in the register are set. See [Register bit descriptions](#) (on page D-9) for information on how to convert the decimal value to bits.

You can use the query commands in the [STATus subsystem](#) (on page 7-94) or send common commands to read registers. For example, you can send the following command to read the Status Enable Register of the Standard Event Register:

```
*ESE?
```

Clearing the registers

Registers in the status model can be cleared using commands or by instrument actions. When a register is cleared, the bits in the register are set to 0.

The event log and all registers are cleared when instrument power is cycled.

Send the command `*CLS` to clear the following event registers and error queue:

- Standard Event Register
- Operation Event Register
- Operation Instrument Event Register
- Operation Instrument Summary Event Register
- Questionable Event Register
- Questionable Instrument Event Register
- Questionable Instrument Summary Event Register
- Measurement Event Register
- Measurement Instrument Event Register
- Measurement Instrument Summary Event Register
- Status Byte register
- Error queue

In addition to this command, any enable register can be reset by sending the 0 parameter value with the individual command to program the register.

Status byte and service request

The Status Byte Register monitors the registers and queues in the status model and generates service requests (SRQs).

When bits are set in the status model registers and queues, they generate summary messages that set or clear bits of the Status Byte Register. You can enable these bits to generate an SRQ.

Service requests (SRQs) instruct the controller that the instrument needs attention or that some event has occurred. When the controller receives an SRQ, the controller can interrupt existing tasks to perform tasks that address the request for service.

Status Byte Register

The Status Byte Register consists of two 8-bit registers that control service requests, the Status Byte Register, and the Service Request Enable Register. These summary bits do not latch, and their states (0 or 1) are solely dependent on the summary messages (0 or 1). For example, if the Standard Event Register is read, its register will clear. As a result, its summary message will reset to 0, which then will reset the ESB bit in the Status Byte Register. These registers are shown in the following figure.

Figure 123: Series 2280 Status Byte Register

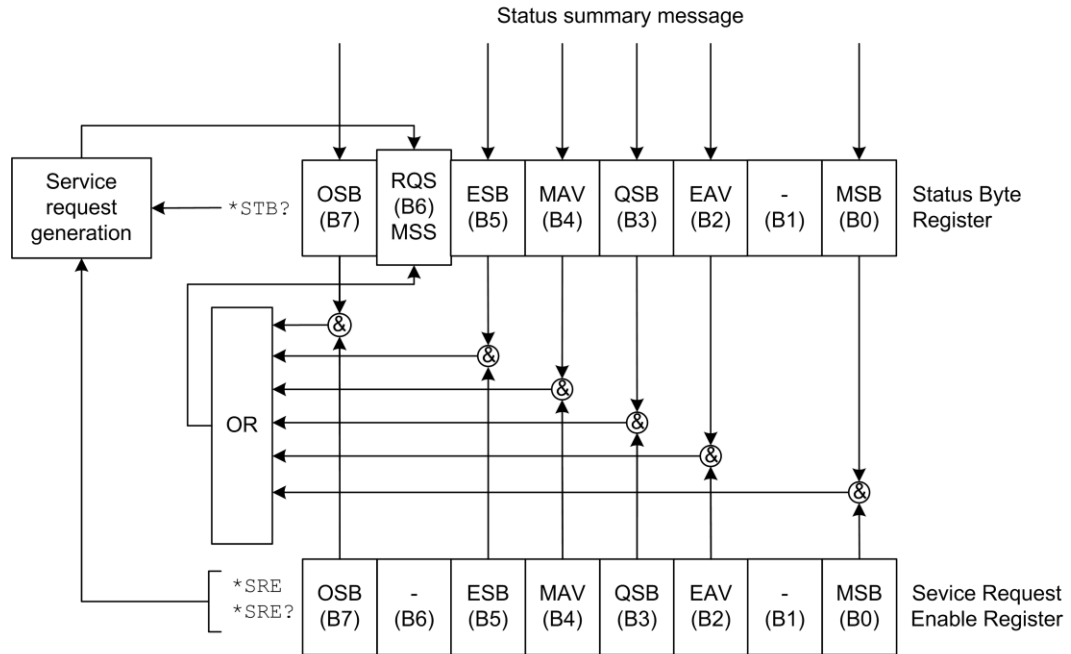

The bits of the Status Byte Register are described in the following table:

Bit	Decimal value	Bit name	When set, indicates the following has occurred:
0	1	Measurement summary bit (MSB)	An enabled measurement event
1	2	Not used	Not applicable
2	4	Error available (EAV)	An error is present in the error queue (warning and information messages do not affect this bit)
3	8	Questionable summary bit (QSB)	An enabled questionable event
4	16	Message available (MAV)	A response message is present in the output queue
5	32	Event summary bit (ESB)	An enabled standard event
6	64	Request for service (RQS)/Master summary status (MSS)	An enabled summary bit of the Status Byte Register is set; depending on how it is used, this is either the Request for Service (RQS) bit or the Master Summary Status (MSS) bit
7	128	Operation summary bit (OSB)	An enabled operation event

Service Request Enable Register

This register is programmed by the user and is used to enable or disable the setting of bit B6 (RQS/MSS) by the Status Summary Message bits (B0, B1, B2, B3, B4, B5, and B7) of the Status Byte Register. As shown in the [Status Byte Register](#) (on page D-7) topic, a logical AND operation is performed on the summary bits (&) with the corresponding enable bits of the Service Request Enable Register. When a logical AND operation is performed with a set summary bit (1) and with an enabled bit (1) of the enable register, the logic “1” output is applied to the input of the logical OR gate and, therefore, sets the MSS/RQS bit in the Status Byte Register.

The individual bits of the Service Request Enable Register can be set or cleared by using the `*SRE` common command. To read the Service Request Enable Register, use the `*SRE?` query. The Service Request Enable Register clears when instrument power is cycled or a parameter value of 0 is sent with a status request enable command (for example, `*SRE 0` is sent). You can program and read the SRQ Enable Register using the following commands.

Description	SCPI command
Read the Status Request Enable Register	<code>*SRE?</code>
Enable bits in the Status Request Enable Register	<code>*SRE</code>

Status register sets

The Series 2280 status structure contains the following status register sets:

- Standard Event Register
- Operation Event Register
- Operation Instrument Event Register
- Operation Instrument Summary Event Register
- Questionable Event Register
- Questionable Instrument Event Register
- Questionable Instrument Summary Event Register
- Measurement Event Register
- Measurement Instrument Event Register
- Measurement Instrument Summary Event Register

Register bit descriptions

The following topics contain detailed information about the register bits.

Standard Event Register

The Standard Event Register records eight types of events that could occur in the instrument. See the following figure and table below it for details.

Figure 124: Series 2280 Standard Event Register

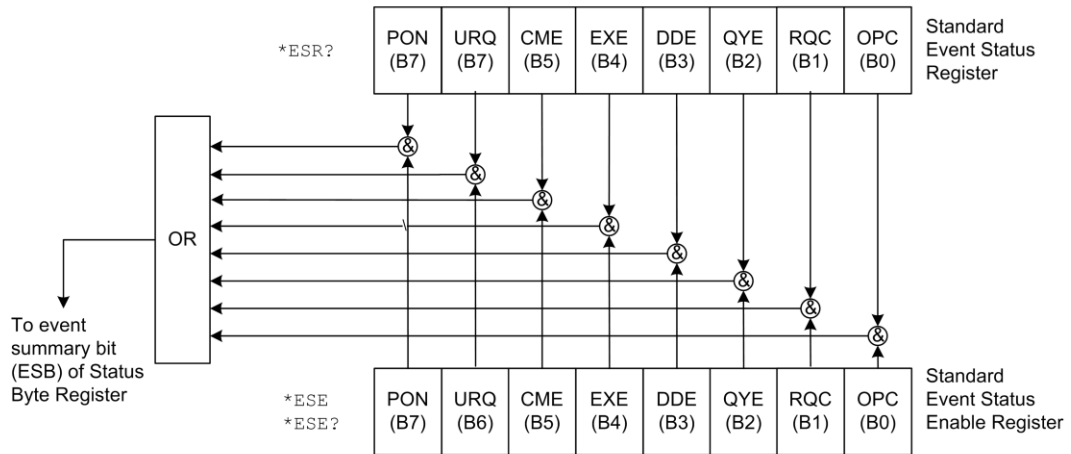

Bit	Decimal value	Bit name	When set, indicates the following has occurred:
0	1	Operation complete (OPC)	All pending selected device operations are completed and the Series 2280 is ready to accept new commands.
1	2	Request control (RQC). Not used.	NA
2	4	Query error (QYE)	An attempt was made to read data from an empty output queue.
3	8	Device error (DDE)	A device error has been detected.
4	16	Execution error (EXE)	An error was detected while the instrument was trying to execute a command.
5	32	Command error (CME)	A command error has occurred. See information following this table for descriptions of command errors.
6	64	User request (URQ)	An enabled summary bit of the Status Byte Register is set; depending on how it is used, this is either the request for service (RQS) bit or the master summary status (MSS) bit.
7	128	Power on (PON)	The instrument has been turned off and turned back on since the last time this register was read.

Command errors include:

- **IEEE Std 488.2 syntax error:** The instrument received a message that does not follow the defined syntax of the IEEE Std 488.2 standard.
- **Semantic error:** The instrument received a command that was misspelled or received an optional IEEE Std 488.2 command that is not implemented in the instrument.
- **GET error:** The instrument received a Group Execute Trigger (GET) inside a program message.

Operation Event Register

The Operation Event Register records the unexpected operation of the power supply. Bit 13 summarizes operation outputs of the power supply. See the following figure and table below it for details.

Figure 125: Series 2280 Operation Event Register

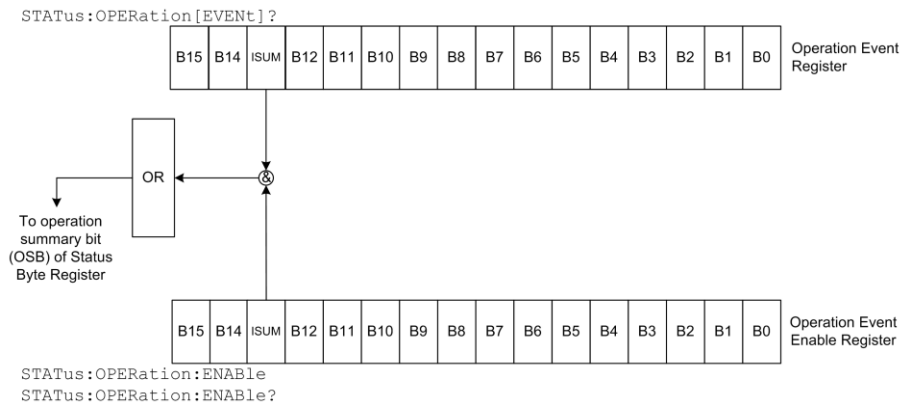

Bit	Decimal value	Bit name	When set, indicates the following has occurred:
0 through 12	Not used	Not used	NA
13	8192	ISUM	Summary of Operation Instrument Event Register and Operation Instrument Summary Event Register.
14 through 15	Not used	Not used	NA

Operation Instrument Event Register

Operation Instrument Event Register summarizes the Operation Instrument Summary Event Register. If bit 1 of the Operation Instrument Event Register is set and bit 1 of Operation Instrument Event Enable Register is enabled, bit 13 (ISUM) of the Operation Event Register is set.

Figure 126: Series 2280 Operation Instrument Event Register

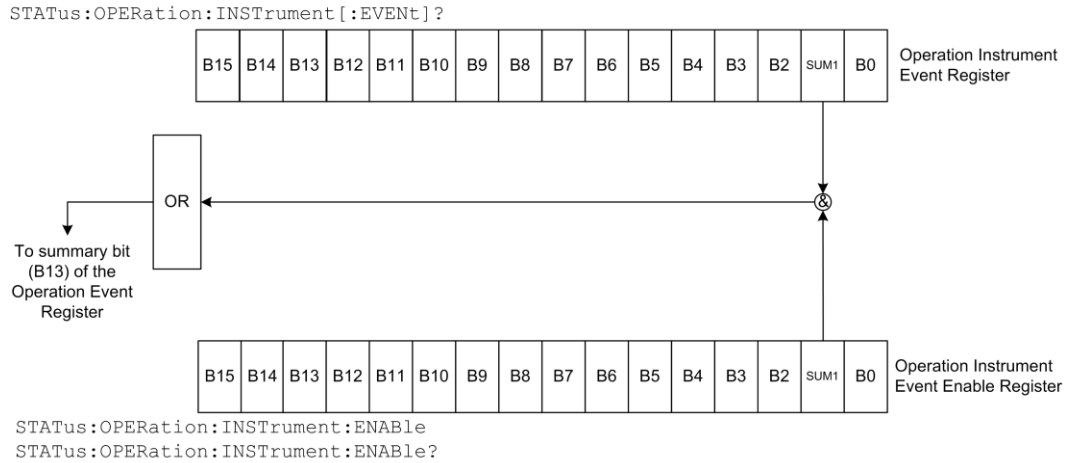

Bit	Decimal value	Bit name	When set, indicates the following has occurred:
0	Not used	Not used	NA
1	2	SUM1	Summary of Operation Instrument Summary Event Register
2 through 15	Not used	Not used	NA

Operation Instrument Summary Event Register

The bits of the Operation Instrument Summary Event Register are described in the following figure and table.

Figure 127: Series 2280 Operation Instrument Summary Event Register

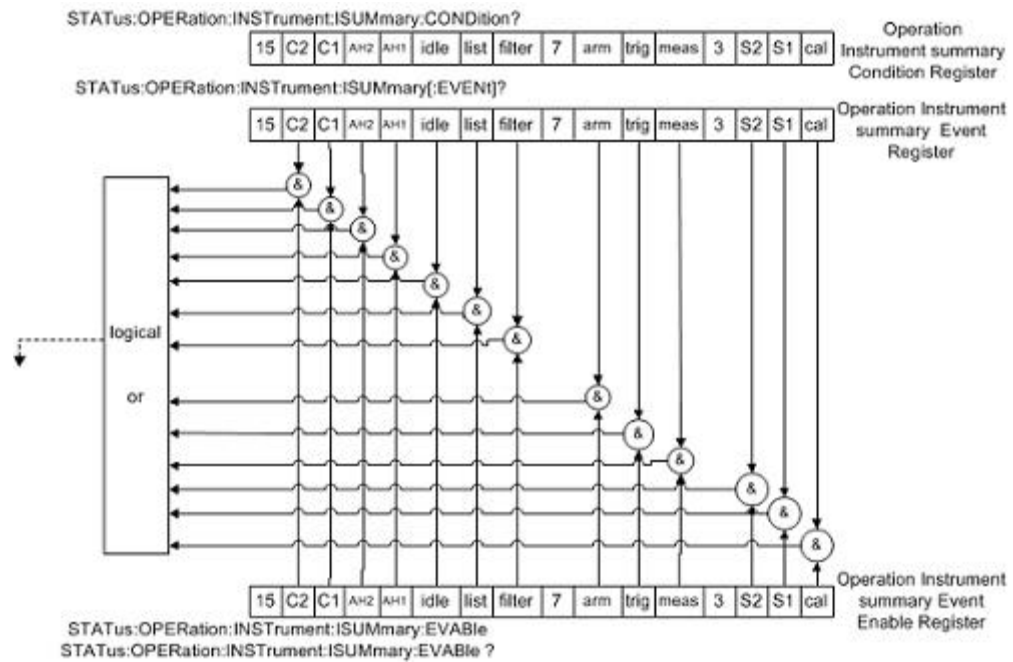

Bit	Decimal value	Bit name	When set, indicates the following has occurred:
0	1	Calibration (Cal)	The instrument is performing a calibration.
1 through 3	Not used	Not used	NA
4	16	Measurement (Meas)	The instrument is performing a measurement.
5	32	Trigger (Trig)	The instrument is in the trigger layer waiting for a trigger event to occur.
6	64	ARM	The instrument is in the ARM layer waiting for an arm event to occur.
7	128	Not used	NA
8	256	Filt	The filter has settled or the filter is disabled.
9	512	List	The instrument is running a list.
10	1024	Idle	The instrument is in idle mode.
11 through 15	Not used	Not used	NA

Questionable Event Register

The bits of the Questionable Event Register are described in the following figure and table.

Figure 128: Series 2280 Questionable Event Register

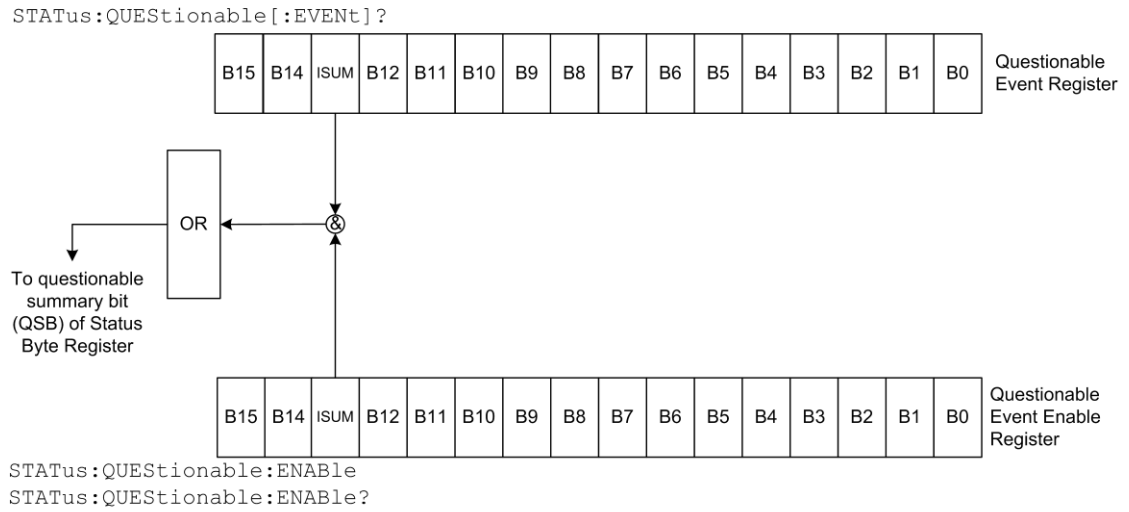

Bit	Decimal value	Bit name	When set, indicates the following has occurred:
0 through 12	Not used	Not used	NA
13	8192	ISUM	Summary of Questionable Instrument Event Register and Questionable Instrument Summary Event Register.
14 through 15	Not used	Not used	NA

Questionable Instrument Event Register

Questionable Instrument Event Register summarizes the Questionable Instrument Summary Event Register. If bit 1 of the Questionable Instrument Event Register is set and bit 1 of Questionable Instrument Event Enable Register is enabled, bit 13 (ISUM) of the Questionable Event Register is set. See the following figure and table below it for details.

Figure 129: Series 2280 Questionable Instrument Event Register

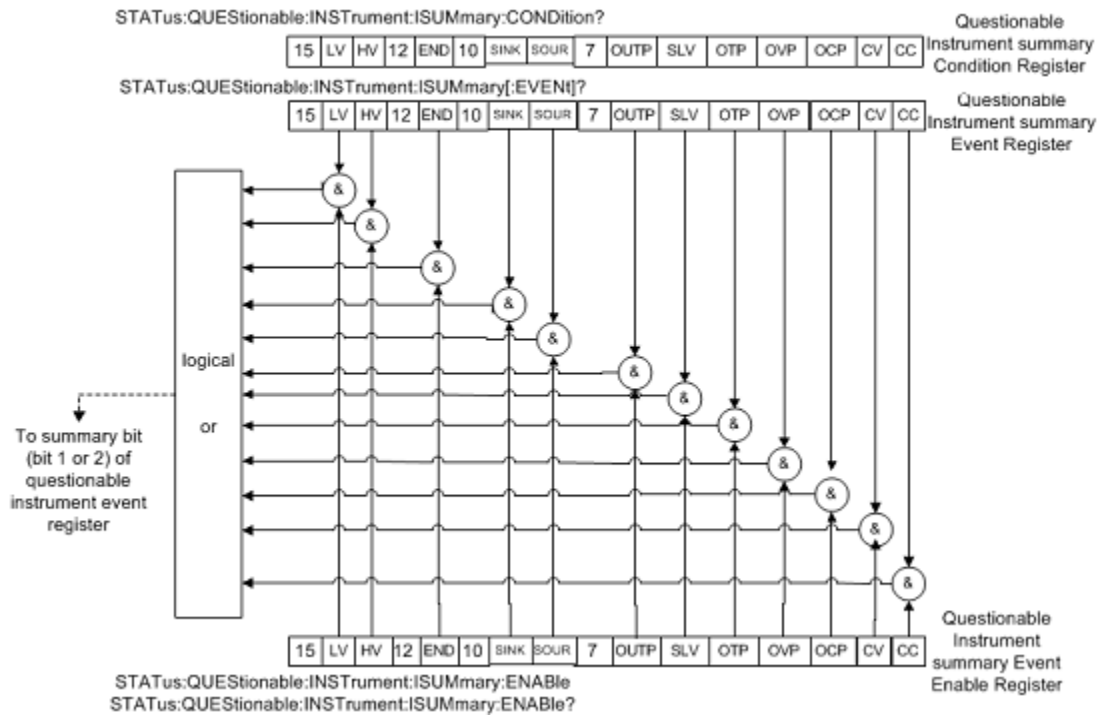

Bit	Decimal value	Bit name	When set, indicates the following has occurred:
0	Not used	Not used	NA
1	2	SUM1	Summary of Questionable Instrument Summary Event Register.
2 through 15	Not used	Not used	NA

Questionable Instrument Summary Event Register

The bits of Questionable Instrument Summary Event Register are described in the following figure and table.

Figure 130: Series 2280 Questionable Instrument Summary Event Register

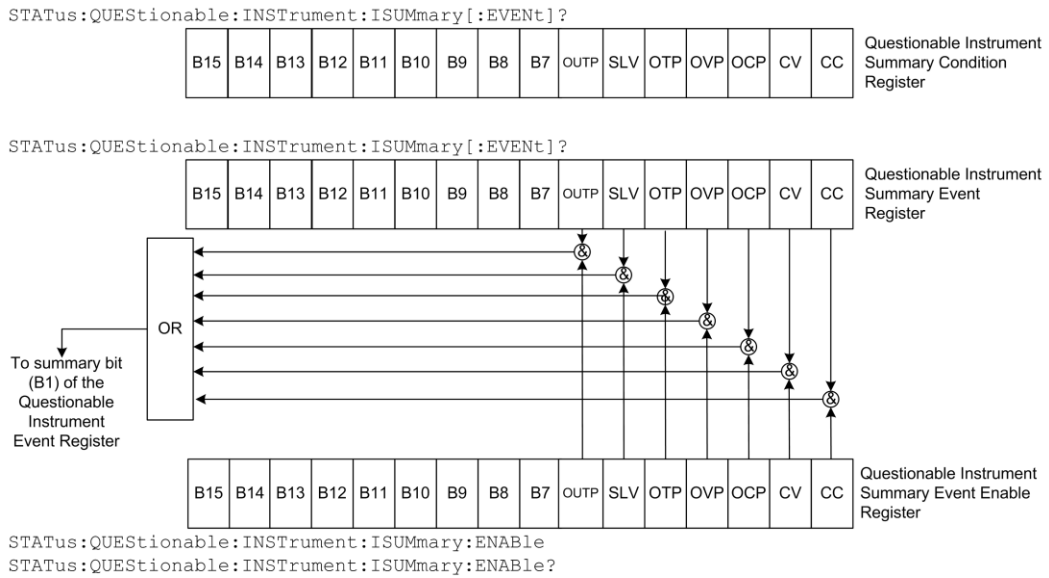

Bit	Decimal value	Bit name	When set, indicates the following has occurred:
0	1	CC	The output is in constant current mode.
1	2	CV	The output is in constant voltage mode.
2	4	OCP	The overcurrent protection circuit has tripped.
3	8	OVP	The overvoltage protection circuit has tripped.
4	16	OTP	The overtemperature protection circuit has tripped.
5	32	SLV	Sense leads are reversed.
6	64	OUTP	Output is enabled.
7 through 15	Not used	Not used	NA

Measurement Event Register

The bits of the Measurement Event Register are described in the following figure and table below it.

Figure 131: Series 2280 Measurement Event Register

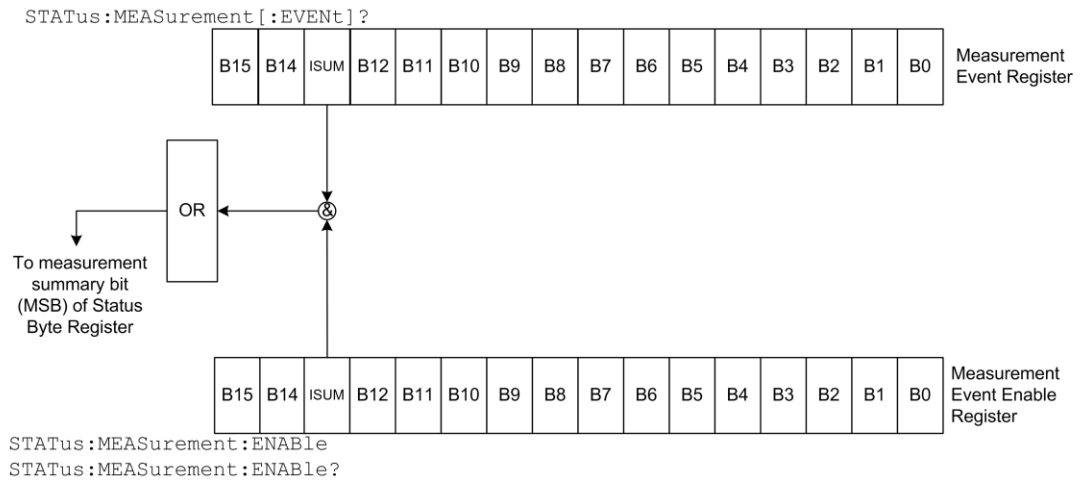

Bit	Decimal value	Bit name	When set, indicates the following has occurred:
0 through 12	Not used	Not used	NA
13	8192	ISUM	Summary of Measurement Instrument Event Register and Measurement Instrument Summary Event Register.
14 through 15	Not used	Not used	NA

Measurement Instrument Event Register

Measurement Instrument Event Register summarizes the Measurement Instrument Summary Event Register. If bit 1 of the Measurement Instrument Event Register is set and bit 1 of Measurement Instrument Event Enable Register is enabled, bit 13 (ISUM) of the Measurement Event Register is set. See the following figure and table below it for details.

Figure 132: Series 2280 Measurement Instrument Event Register

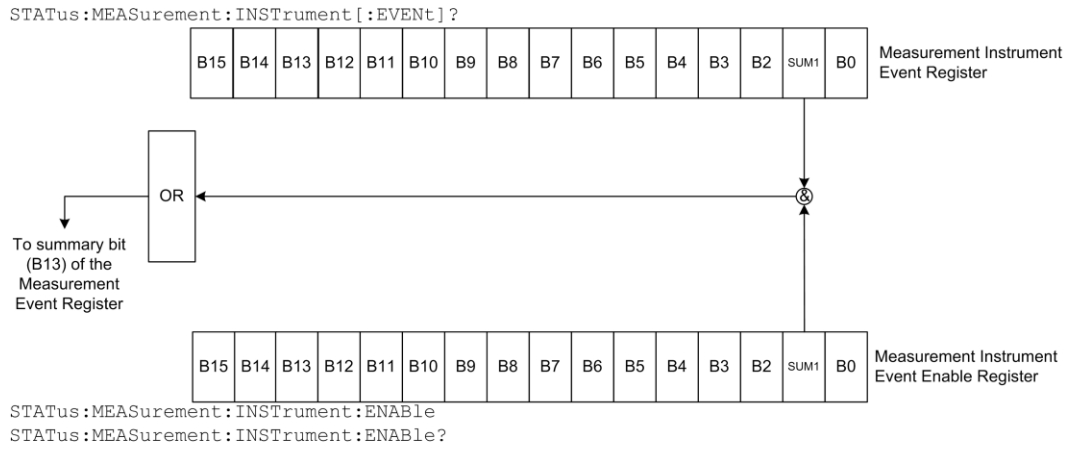

Bit	Decimal value	Bit name	When set, indicates the following has occurred:
0	Not used	Not used	NA
1	2	SUM1	Summary of Measurement Instrument Summary Event Register.
2 through 15	Not used	Not used	NA

Measurement Instrument Summary Event Register

The bits of the Measurement Instrument Summary Event Register are described in the following figure and table.

Figure 133: Series 2280 Measurement Instrument Summary Event Register

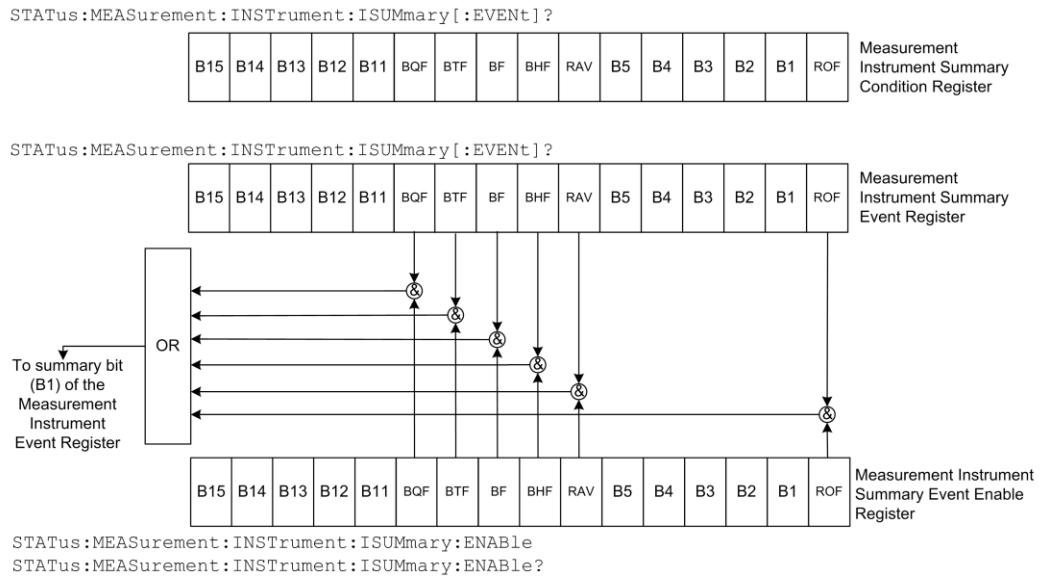

Bit	Decimal value	Bit name	When set, indicates the following has occurred:
0	1	ROF	Reading overflow
1 through 5	Not used.	Not used	NA
6	64	RAV	Reading is available.
7	128	BHF	Buffer is half-full.
8	256	BF	Buffer is full.
9	512	BTF	Buffer is three-quarters full.
10	1024	BQF	Buffer is one-quarter full.
11 through 15	Not used	Not used	NA

Event registers

Each status register set has an event register. When an event occurs, the appropriate event register bit sets to 1. The bit remains latched to 1 until the register is reset. Reading an event register clears the bits of that register. The *CLS command resets all the event registers.

The commands to read the event registers are described in [STATus subsystem](#) (on page 7-94).

Event enable registers

Each status register has an enable register. Each event register bit is logically ANDed (&) to a corresponding enable bit of an enable register. Therefore, when an event bit is set and the corresponding enable bit is set (as programmed by the user), the output (summary) of the register will set to 1.

The commands to program and read the event enable registers are described in [STATus subsystem](#) (on page 7-94).

Condition registers

The Series 2280 has the following condition registers:

- Operation Instrument Summary Condition Register
- Questionable Instrument Summary Condition Register
- Measurement Instrument Summary Condition Register

A condition register is a real-time, read-only register that constantly updates to reflect the present operating conditions of the instrument. For example, while the Series 2280 is in the idle state, bit B10 (idle) of the Operation Instrument Summary Condition Register will be set. When the instrument is taken out of the idle state, bit B10 clears.

Queues

The instrument includes an Output Queue and an Error Queue. The Output Queue holds messages from readings and responses. The Error Queue holds error messages from the event log. Both are first-in, first-out (FIFO) registers.

Output queue

The output queue holds response messages to query and print the commands.

When data is placed in the output queue, the message available (MAV) bit in the Status Byte Register is set. The bit is cleared when the output queue is empty.

To clear data from the output queue, read the messages. To read a message from the output queue, address the instrument to talk after the appropriate query is sent.

Error queue

The error queue holds error messages. When an error occurs, a message that defines the error is placed in the error queue. When a message is placed in the error queue, the error available (EAV) bit in the Status Byte Register is set. An error message is cleared from the error queue when it is read. The error queue is considered cleared when it is empty. An empty error queue clears the EAV bit in the Status Byte Register.

The error queue holds up to 64 error messages. If the queue becomes full, the message “-350, 'Queue Overflow'” will occupy the last memory location. On power-up, the error queue is empty. When empty, the message “0, No Error” is placed in the queue. Messages in the error queue are preceded by a code number. Negative (-) numbers are used for SCPI-defined messages and positive (+) numbers are used for Keithley-defined messages. See [Troubleshooting](#) (on page 8-1) for details.

You can clear the error queue by sending the common command:

```
*CLS
```

In addition, you can send the command:

```
:SYSTem:ERRor:CLear
```

Serial polling and SRQ

Any enabled event summary bit that goes from 0 to 1 sets bit B6 and generates a service request (SRQ).

In your test program, you can periodically read the Status Byte to check if an SRQ has occurred and what caused it. If an SRQ occurs, the program can, for example, branch to an appropriate subroutine that will service the request.

SRQs can be managed by the serial poll sequence of the instrument. If an SRQ does not occur, bit B6 (RQS) of the Status Byte Register remains cleared, and the program proceeds normally after the serial poll is performed. If an SRQ does occur, bit B6 of the Status Byte Register is set, and the program can branch to a service subroutine when the SRQ is detected by the serial poll.

The serial poll automatically resets RQS of the Status Byte Register. This allows subsequent serial polls to monitor bit B6 for an SRQ occurrence that is generated by other event types.

For common commands, B6 is the MSS (Message Summary Status) bit. The serial poll does not clear the MSS bit. The MSS bit stays set until all enabled Status Byte Register summary bits are reset.

Status model programming examples

The following examples illustrate how to generate an SRQ using the status model.

SRQ when reading buffer becomes full

This example shows you how to generate an SRQ when the Series 2280 reading buffer is full. This is useful to notify the controlling computer that it needs to read back the data and empty the buffer. After configuring the status model, this code configures the reading buffer 1 to a size of 10, and then configures the instrument to fill the buffer. After the buffer is full, the instrument generates an SRQ and returns the data.

Using SCPI commands:

```
*RST
*CLS
STAT:MEAS:INST:ISUM:ENAB 256
STAT:MEAS:INST:ENAB 2
STAT:MEAS:ENAB 8192
*SRE 1
TRAC:CLE
TRAC:POIN 10
SOUR:VOLT 1
TRIG:COUN 10
OUTP ON
INIT
*WAI
OUTP OFF
TRAC:DATA:SEL? 1, 10, "READ"
```

SRQ when trigger model is finished

This example shows you how to generate an SRQ when the trigger model is completed and the power supply has returned to the idle state. After configuring the status model, this code will configure and run the trigger model. When the trigger model completes, the instrument will generate an SRQ and the data will be returned.

Using SCPI commands:

```
*RST
:TRAC:CLE
:TRAC:POIN 10
*CLS
:STAT:OPER:INST:ISUM:ENAB 1024
:STAT:OPER:INST:ENAB 2
:STAT:OPER:ENAB 8192
*SRE 128
:SOUR:VOLT 1
:TRIG:COUN 10
:OUTP ON
:INIT
*WAI
:TRAC:DATA? "READ"
```

Specifications are subject to change without notice.
All Keithley trademarks and trade names are the property of Keithley Instruments.
All other trademarks and trade names are the property of their respective companies.

Keithley Instruments
Corporate Headquarters • 28775 Aurora Road • Cleveland, Ohio 44139 • 440-248-0400 • Fax: 440-248-6168 • 1-800-935-5595 • tek.com/keithley

