

 2J Antennas



ANTENNA CATALOGUE



SINGLE EXTERNAL ANTENNAS



COMBINATION EXTERNAL ANTENNAS



SINGLE INTERNAL ANTENNAS



COMBINATION INTERNAL ANTENNAS

 www.2j-antennae.com
 www.2j-antennasusa.com



about company



2J Antennas is a worldwide supplier of antenna solutions

2J Antennas delivers antenna innovations for a connected world over Automotive, IoT, Marine, Telematic, Automation, M2M and other markets. The company employs a personal and customized approach to the development and delivery of every application solution. By putting design and manufacturing under the same roof, projects are personally managed and completed for just-in-time excellence and superior quality.



about company

With our two RF development sites in the Slovakia and UK, we have developed a reputation for engineering excellence and self-sufficiency, allowing us to provide rapid custom antenna solutions, supplementing our extensive range of off-the-shelf antenna.

In 2015, 2J expanded its reach to the American market with new engineering and sales support office in San Diego, California. This new branch offers pre-certification testing and consulting services.



2J Antennas USA



2J UK Ltd.



2J Slovakia

We utilise a plethora of modern engineering tools, from network analysers and anechoic chambers, to simulation software and 3D printers. These tools help reduce design phases, and enable us to react to our customers needs promptly and efficiently.



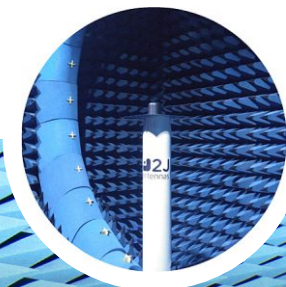

Design ▶ Prototyping ▶ Testing ▶ Manufacturing



- ➔ PCB & RF circuit design
- ➔ rapid prototyping
- ➔ OTA measurements
- ➔ PTCRB guidance
- ➔ TIS noise debugging

- ➔ pre-certification testing
- ➔ ECC testing
- ➔ emissions testing
- ➔ cable assembly
- ➔ plastic injection

Our ISO/TS16949:2009 certified production site in Central Europe ensures production of the highest quality products. Our antennas are all manufactured under the RoHS directive and are REACH compliant. Plastic injection, SMD pick and place, product assembly and quality control are all carried out in-house, aiding us to be flexible in manufacturing and provide competitively priced products.

 <p>ISO/TS 16949:2009 Automotive standards</p>	 <p>EN ISO 14001:2004 Environmental</p>	 <p>EN ISO 9001:2008 Quality management system</p>	 <p>RoHS COMPLIANT</p>	 <p>REACH COMPLIANCE</p>
<p>IP67 Water Resistance</p>	<p>IP69K Hot Water Pressure</p>	<p>IK09 Heavy Duty</p>	<p>UL94-V0 Fire Resistance</p>	<p>EN50155 ESD - CE Vibration, shock Cooling test...</p>

Our close-knit team of engineers and commercial personnel have established strong bonds with customers and suppliers, ensuring a good communication of needs, requirements and solutions.

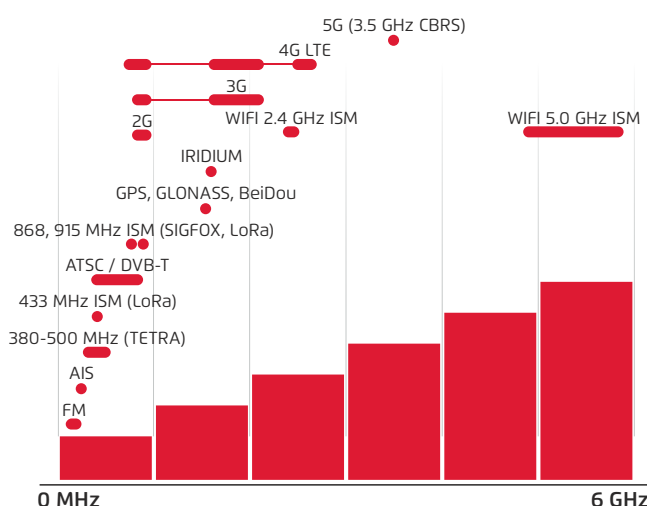

Ensuring the continued development of products to meet the rapidly evolving wireless world remains our primary focus, be it for 4G (LTE), Iridium communications or Galileo satellite based applications. We work closely with technological innovators to ensure that we have a clear vision for future projects, maintaining our strong position in commercial antenna design.



table of contents



05 SINGLE EXTERNAL ANTENNAS

- 06 5G/CBRE
- 06 4G LTE/3G/2G
- 15 3G/2G
- 19 GNSS (Navigation)
- 19 GPS/GLONASS
- 20 2.4/5.0 GHz ISM (WiFi, Bluetooth...)
- 20 2.4/5.0 GHz ISM
- 25 2.4 GHz ISM
- 28 5.0 GHz ISM
- 29 915 MHz ISM (Sigfox, LoRa...)
- 32 868 MHz ISM (Sigfox, LoRa...)
- 33 433 MHz ISM (LoRa...)
- 38 IRIDIUM
- 40 TETRA 380-500 MHz

COMBINATION EXTERNAL ANTENNAS

- Adhesive Mount
 - 2-in-1 42
 - 3-in-1 47
 - 4-in-1 49
 - 5-in-1 50
- Screw Mount
 - 2-in-1 51
 - 3-in-1 59
 - 4-in-1 63
 - 5-in-1 67
- Magnetic Mount
 - 2-in-1 71
 - 3-in-1 74
- Mast Mount
 - 2-in-1 75
 - 4-in-1 76
 - 5-in-1 77

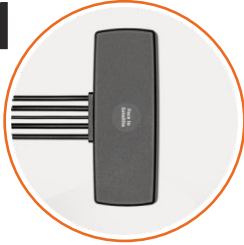

41



78 SINGLE & COMBINATION INTERNAL ANTENNAS

- 79 4G LTE/3G/2G
- 83 3G/2G
- 86 GNSS (Navigation)
- 86 GPS/GLONASS/BeiDou
- 87 GPS/GLONASS
- 89 GPS
- 92 2.4/5.0 GHz ISM (WiFi, Bluetooth...)
- 92 2.4/5.0 GHz ISM
- 93 915 MHz ISM (Sigfox, LoRa...)
- 95 868 MHz ISM (Sigfox, LoRa...)
- 96 433 MHz ISM (LoRa...)
- 97 IRIDIUM
- 98 COMBINATION INTERNAL ANTENNAS

DEVELOPMENT KITS & BOARDS

99



CABLE ASSEMBLIES CONNECTORS

106

single external antennas



2J3757M

5G/CBRE

Key Features

- ✔ 5G / 3.5 GHz CBRS antenna
- ✔ High Performance
- ✔ Ground Plane Dependent
- ✔ Customizable Cable and Connector



General specification

Mounting type	Magnetic mount
Dimensions (mm)	∅ 31 × 72
Operating temperature	-40 °C to +85 °C

Antenna and electrical specifications

5G/CBRE

Standards	CBRS, 5G, WIMAX
Frequency (MHz)	3300-3900
VSWR	~1.4:1
Peak Gain (dBi)	~2.1
Impedance (Ohm)	50
Polarisation	Linear
Max. Input Power (W)	35

2J2024GP

4G LTE/3G/2G

Key Features

- ✔ High Performance
- ✔ Ground Plane Independent
- ✔ Customizable Cable and Connector



General specification

Mounting type	Wall mount
Dimensions (mm)	220 × 22
Operating temperature	-40 °C to +85 °C

Antenna and electrical specifications

4G LTE/3G/2G

Standards	2G,3G and 4G
Frequency (MHz)	698-960, 1710-2170, 2500-2700
VSWR	~1.4:1, ~1.4:1, ~1.4:1
Peak Gain (dBi)	~3.4, ~2.5, ~1.0
Impedance (Ohm)	50
Polarisation	Linear
Max. Input Power (W)	25

2J205GP

4G LTE/3G/2G

Key Features

- ✔ High Performance
- ✔ Ground Plane Independent
- ✔ Customizable Cable and Connector



General specification

Mounting type	Wall mount
Dimensions (mm)	208.3 × 16
Operating temperature	-40 °C to +85 °C

Antenna and electrical specifications

4G LTE/3G/2G

Standards	2G,3G and 4G
Frequency	698-960, 1710-2170, 2500-2700
VSWR	~2.8:1, ~2.5:1, ~2.7:1
Peak Gain (dBi)	~3.0, ~2.3, ~0.7
Impedance (Ohm)	50
Polarisation	Linear
Max. Input Power (W)	25

2J2124-C315N

4G LTE/3G/2G

Key Features

- ✔ Screw/Connector Mount
- ✔ N-Male connector
- ✔ Ground Plane Independent



General specification

Mounting type	Screw mount, Connector mount
Connector type	N-Male connector
Dimensions (mm)	202 × Ø 20
Operating temperature	-40 °C to +85 °C

Antenna and electrical specifications

4G LTE/3G/2G

Standards	2G,3G and 4G
Frequency (MHz)	698-960, 1710-2170, 2500-2700
VSWR	~1.8:1, ~1.5:1, ~2.0:1
Peak Gain (dBi)	~0.3, ~1.7, ~2.3
Impedance (Ohm)	50
Polarisation	Linear
Max. Input Power (W)	25

2J2124-C681N

4G LTE/3G/2G

Key Features

- ✔ N-Female connector
- ✔ Ground Plane Independent



General specification

Mounting type	Connector mount
Connector type	N-Female connector
Dimensions (mm)	189 × Ø 22
Operating temperature	-40 °C to +85 °C

Antenna and electrical specifications

4G LTE/3G/2G

Standards	2G,3G and 4G
Frequency (MHz)	698-960, 1710-2170, 2500-2700
VSWR	~1.8:1, ~1.5:1, ~2.0:1
Peak Gain (dBi)	~0.3, ~1.7, ~2.3
Impedance (Ohm)	50
Polarisation	Linear
Max. Input Power (W)	25

2J300M

4G LTE/3G/2G

Key Features

- ✔ High Performance
- ✔ Ground Plane Dependent
- ✔ Customizable Cable and Connector



General specification

Mounting type	Magnetic mount
Dimensions (mm)	Ø 31 × 72
Operating temperature	-40 °C to +85 °C

Antenna and electrical specifications

4G LTE/3G/2G

Standards	2G,3G and 4G
Frequency (MHz)	698-960, 1710-2170, 2500-2700
VSWR	~1.9:1, ~1.5:1, ~1.3:1
Peak Gain (dBi)	~1.0, ~2.4, ~2.1
Impedance (Ohm)	50
Polarisation	Linear
Max. Input Power (W)	35

2J302M 4G LTE/3G/2G

Key Features

- ✔ High Performance
- ✔ Ground Plane Dependent
- ✔ Customizable Cable and Connector



General specification

Mounting type	Magnetic mount
Dimensions (mm)	∅ 30.9 × 88
Operating temperature	-40 °C to +85 °C

Antenna and electrical specifications 4G LTE/3G/2G

Standards	2G,3G and 4G
Frequency (MHz)	698-960, 1710-2170, 2500-2700
VSWR	~1.7:1, ~2.2:1, ~1.9:1
Peak Gain (dBi)	~1.8, ~1.1, ~2.8
Impedance (Ohm)	50
Polarisation	Linear
Max. Input Power (W)	35

2J7524M 4G LTE/3G/2G

Key Features

- ✔ High Performance
- ✔ Ground Plane Dependent
- ✔ Customizable Cable and Connector
- ✔ Certificates: **IP67** - Water resistant



General specification

Mounting type	Magnetic mount
Dimensions (mm)	∅ 54 × 80 mm
Operating temperature	-40 °C to +85 °C
Certificates	IP67

Antenna and electrical specifications 4G LTE/3G/2G

Standards	2G,3G and 4G
Frequency (MHz)	698-960, 1710-2170, 2500-2700
VSWR	~2.1:1, ~1.6:1, ~1.5:1
Peak Gain (dBi)	~2.0, ~3.9, ~3.5
Impedance (Ohm)	50
Polarisation	Linear
Max. Input Power (W)	25

2J7724M 4G LTE/3G/2G

Key Features

- ✔ High Performance
- ✔ Ground Plane Dependent
- ✔ Customizable Cable and Connector
- ✔ Certificates: **IP67** - Water resistant, **IP69** - Hot water pressure



General specification

Mounting type	Magnetic mount
Dimensions (mm)	54.5 × 67.1
Operating temperature	-40 °C to +85 °C
Certificates	IP67, IP69

Antenna and electrical specifications 4G LTE/3G/2G

Standards	2G,3G and 4G
Frequency (MHz)	698-960, 1710-2170, 2500-2700
VSWR	~1.9:1, ~1.2:1, ~1.4:1
Peak Gain (dBi)	~1.8, ~3.1, ~2.9
Impedance (Ohm)	50
Polarisation	Linear
Max. Input Power (W)	25

2J6A24B

4G LTE/3G/2G

Key Features

- ✔ Ground Plane Dependent
- ✔ Customizable Cable and Connector
- ✔ Certificates: **IP67** - Water resistant, **IP69** - Hot water pressure, **IK09** - Impact resistant



General specification

Mounting type	Screw mount
Dimensions (mm)	Ø 77.3 x 65.5
Operating temperature	-40 °C to +85 °C
Certificates	IP67, IP69, IK09

Antenna and electrical specifications

4G LTE/3G/2G	
Standards	2G,3G and 4G
Frequency (MHz)	698-960, 1710-2170, 2500-2700
VSWR	~2.1:1, ~1.5:1, ~1.5:1
Peak Gain (dBi)	~0.7, ~3.4, ~4.0
Impedance (Ohm)	50
Polarisation	Linear
Max. Input Power (W)	25

2J7624B

4G LTE/3G/2G

Key Features

- ✔ Ground Plane Independent
- ✔ Customizable Cable and Connector
- ✔ Certificates: **IP67** - Water resistant, **IP69** - Hot water pressure



General specification

Mounting type	Screw mount
Dimensions (mm)	Ø 54 x 50
Operating temperature	-40 °C to +85 °C
Certificates	IP67, IP69

Antenna and electrical specifications

4G LTE/3G/2G	
Standards	2G,3G and 4G
Frequency (MHz)	698-960, 1710-2170, 2500-2700
VSWR	~2.1:1, ~1.8:1, ~2.5:1
Peak Gain (dBi)	~2.6, ~3.2, ~1.4
Impedance (Ohm)	50
Polarisation	Linear
Max. Input Power (W)	25

2J7724B

4G LTE/3G/2G

Key Features

- ✔ High Performance
- ✔ Ground Plane Dependent
- ✔ Customizable Cable and Connector
- ✔ Certificates: **IP67** - Water resistant, **IP69** - Hot water pressure



General specification

Mounting type	Screw mount
Dimensions (mm)	Ø 54.5 x 67.1
Operating temperature	-40 °C to +85 °C
Certificates	IP67, IP69

Antenna and electrical specifications

4G LTE/3G/2G	
Standards	2G,3G and 4G
Frequency (MHz)	698-960, 1710-2170, 2500-2700
VSWR	~1.9:1, ~1.2:1, ~1.4:1
Peak Gain (dBi)	~1.9, ~4.3, ~4.2
Impedance (Ohm)	50
Polarisation	Linear
Max. Input Power (W)	25

2J4824P 4G LTE/3G/2G

Key Features

- ✔ Ground Plane Independent
- ✔ Customizable Cable and Connector



Black

Standard colors
Other colors upon request

General specification

Mounting type	Adhesive mount
Dimensions (mm)	83 x 35 x 13.3
Operating temperature	-40 °C to +85 °C
Note	Optional Antenna Detection Resistor

Antenna and electrical specifications

4G LTE/3G/2G

Standards	2G,3G and 4G
Frequency (MHz)	698-960, 1710-2170, 2500-2700
VSWR	~1.9:1, ~1.4:1, ~1.8:1
Peak Gain (dBi)	~3.4, ~2.1, ~1.0
Impedance (Ohm)	50
Polarisation	Linear
Max. Input Power (W)	25

2J4924P 4G LTE/3G/2G

Key Features

- ✔ High Performance
- ✔ Ground Plane Independent
- ✔ Customizable Cable and Connector



Black

Standard colors
Other colors upon request

General specification

Mounting type	Adhesive mount
Dimensions (mm)	150.5 x 42 x 15.3
Operating temperature	-40 °C to +85 °C
Note	Optional Antenna Detection Resistor

Antenna and electrical specifications

4G LTE/3G/2G

Standards	2G,3G and 4G
Frequency (MHz)	698-960, 1710-2170, 2500-2700
VSWR	~1.7:1, ~1.4:1, ~1.5:1
Peak Gain (dBi)	~3.4, ~3.5, ~3.9
Impedance (Ohm)	50
Polarisation	Linear
Max. Input Power (W)	25

2J5024P 4G LTE/3G/2G

Key Features

- ✔ Ground Plane Independent
- ✔ Customizable Cable and Connector



Black

Standard colors
Other colors upon request

General specification

Mounting type	Adhesive mount
Dimensions (mm)	116 x 22 x 6.7
Operating temperature	-40 °C to +85 °C

Antenna and electrical specifications

4G LTE/3G/2G

Standards	2G,3G and 4G
Frequency (MHz)	698-960, 1710-2170, 2500-2700
VSWR	~1.3:1, ~1.4:1, ~1.4:1
Peak Gain (dBi)	~3.0, ~2.2, ~4.0
Impedance (Ohm)	50
Polarisation	Linear
Max. Input Power (W)	25

2J5124P 4G LTE/3G/2G

Key Features

- ✔ Flexible Housing
- ✔ High Performance
- ✔ Compact Size
- ✔ Customizable Cable and Connector



General specification

Mounting type	Adhesive mount
Dimensions (mm)	122 x 14 x 6
Operating temperature	-40 °C to +85 °C
Note	Optional Antenna Detection Resistor

Antenna and electrical specifications

4G LTE/3G/2G

Standards	2G,3G and 4G
Frequency (MHz)	698-960, 1710-2170, 2500-2700
VSWR	~2.0:1, ~1.5:1, ~1.8:1
Peak Gain (dBi)	~2.0, ~4.1, ~4.1
Impedance (Ohm)	50
Polarisation	Linear
Max. Input Power (W)	25

2J5224P 4G LTE/3G/2G

Key Features

- ✔ Flexible Housing
- ✔ High Performance
- ✔ Compact Size
- ✔ Customizable Cable and Connector



General specification

Mounting type	Adhesive mount
Dimensions (mm)	117.4 x 12.5 x 6.5
Operating temperature	-40 °C to +85 °C
Note	Optional Antenna Detection Resistor

Antenna and electrical specifications

4G LTE/3G/2G

Standards	2G,3G and 4G
Frequency (MHz)	698-960, 1710-2170, 2500-2700
VSWR	~2.0:1, ~1.5:1, ~1.8:1
Peak Gain (dBi)	~2.0, ~4.1, ~4.1
Impedance (Ohm)	50
Polarisation	Linear
Max. Input Power (W)	25

2J540P 4G LTE/3G/2G

Key Features

- ✔ Ultra Wide Band Antenna
- ✔ Customizable Cable and Connector



General specification

Mounting type	Adhesive mount
Dimensions (mm)	112.5 x 60 x 11.3
Operating temperature	-40 °C to +85 °C

Antenna and electrical specifications

4G LTE/3G/2G

Standards	2G,3G and 4G
Frequency (MHz)	698-960, 1710-2170, 2500-2700
VSWR	~2.7:1, ~2.1:1, ~2.0:1
Peak Gain (dBi)	~1.8, ~1.4, ~2.1
Impedance (Ohm)	50
Polarisation	Linear
Max. Input Power (W)	25

2JW0124 antenna

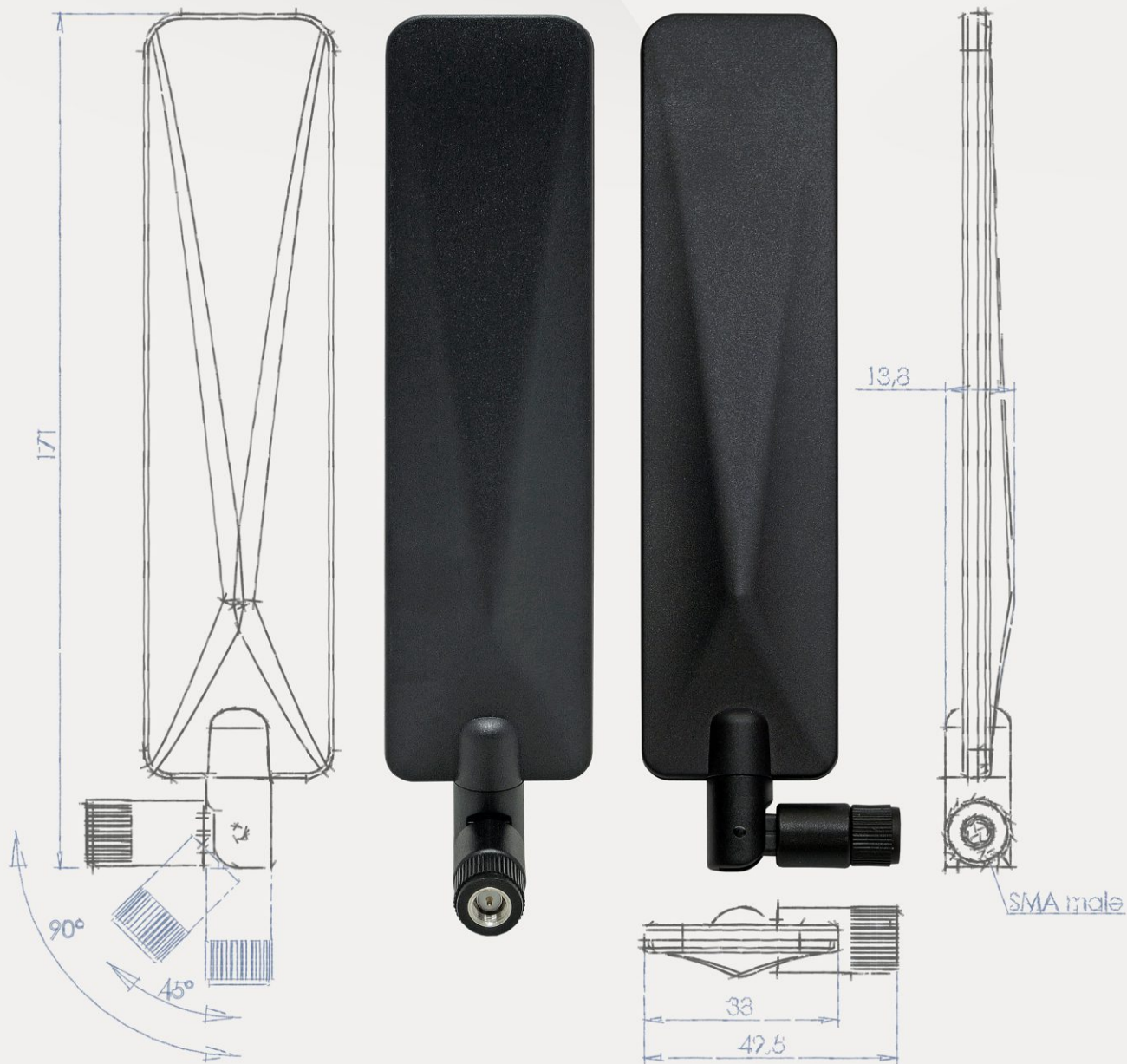

Antenna description

2JW0124 is Ultra wide band High performance connector mount antenna solution for worldwide 4G LTE with 2G, 3G fallback compatibility, covering all cellular bands ranging from 698-960, 1710-2170 and 2500-2700 MHz.

High efficiency, high gain and omni-directional properties gives the antenna consistent and stable connectivity with high throughput data to access points, routers, small base station, femto cells, repeaters, boosters, fleet management devices and other telematics devices with cellular needs.

This antenna is ideal for major carrier approvals and certification process around the globe. The antenna can freely swivel 360 degrees and features a hinged connector up to 90 degrees, having flexibility in orientation with respect to the device for easier installation or multiple antenna mounting.

Two variations of mounting swivels allow different orientation of antennas on devices with MIMO systems. See the different swivel orientation on 2JW0124a antenna.

2JW0124a-C868B

4G LTE/3G/2G

Key Features

- ✔ Ultra Wide band Antenna
- ✔ High Performance
- ✔ Hinged Connector



General specification

Mounting type	Connector mount
Dimensions (mm)	171 × 38 × 13.8
Operating temperature	-40 °C to +85 °C

Antenna and electrical specifications

4G LTE/3G/2G

Standards	2G,3G and 4G
Frequency (MHz)	698-960, 1710-2170, 2500-2700
VSWR	~2.4:1, ~1.6:1, ~2.2:1
Peak Gain (dBi)	~0.4, ~2.6, ~1.3
Impedance (Ohm)	50
Polarisation	Linear
Max. Input Power (W)	25

2JW0124-C868B

4G LTE/3G/2G

Key Features

- ✔ Ultra Wide band Antenna
- ✔ High Performance
- ✔ Hinged Connector



General specification

Mounting type	Connector mount
Dimensions (mm)	171 × 38 × 13.8
Operating temperature	-40 °C to +85 °C

Antenna and electrical specifications

4G LTE/3G/2G

Standards	2G,3G and 4G
Frequency (MHz)	698-960, 1710-2170, 2500-2700
VSWR	~2.4:1, ~1.6:1, ~2.2:1
Peak Gain (dBi)	~0.4, ~2.6, ~1.3
Impedance (Ohm)	50
Polarisation	Linear
Max. Input Power (W)	25

2JW1024

4G LTE/3G/2G

Key Features

- ✔ Wide band Antenna
- ✔ High Efficiency
- ✔ Low Profile
- ✔ Hinged Connector



General specification

Mounting type	Connector mount
Dimensions (mm)	∅ 10 × 71
Operating temperature	-40 °C to +85 °C
	∅ 10 × 71

Antenna and electrical specifications

4G LTE/3G/2G

Standards	2G,3G and 4G
Frequency (MHz)	698-960, 1710-2170, 2500-2700
VSWR	~3.1:1, ~1.7:1, ~1.5:1
Peak Gain (dBi)	~0.1, ~2.9, ~4.6
Impedance (Ohm)	50
Polarisation	Linear
Max. Input Power (W)	10

2JW1124-C675B

4G LTE/3G/2G

Key Features

- ✔ Ultra Wide band Antenna
- ✔ High Performance
- ✔ Hinged Connector
- ✔ Ground Plane Independent



Standard colors
Other colors upon request

General specification

Mounting type	Connector mount
Dimensions (mm)	135 × 19 × 10
Operating temperature	-40 °C to +85 °C

Antenna and electrical specifications

4G LTE/3G/2G	
Standards	2G,3G and 4G
Frequency (MHz)	698-960, 1710-2170, 2500-2700
VSWR	~1.6:1, ~2.1:1, ~2.3:1
Peak Gain (dBi)	~-1.6, ~-1.5, ~-2.9
Impedance (Ohm)	50
Polarisation	Linear
Max. Input Power (W)	25

2JW0924-C675B

4G LTE/3G/2G

Key Features

- ✔ Ultra Wide band Antenna
- ✔ High Performance
- ✔ Hinged Connector
- ✔ Ground Plane Independent



Standard colors
Other colors upon request

General specification

Mounting type	Connector mount
Dimensions (mm)	170 × 18 × 10
Operating temperature	-40 °C to +85 °C

Antenna and electrical specifications

4G LTE/3G/2G	
Standards	2G,3G and 4G
Frequency (MHz)	698-960, 1710-2170, 2500-2700
VSWR	~1.7:1, ~1.5:1, ~1.3:1
Peak Gain (dBi)	~0.6, ~-2.6, ~-2.3
Impedance (Ohm)	50
Polarisation	Linear
Max. Input Power (W)	25

2J0104-C884G

3G/2G

Key Features

- ✔ Low Profile
- ✔ Ground Plane Dependent
- ✔ Right-Angle Connector



General specification

Mounting type	Connector mount
Dimensions (mm)	44 x 19.1 x 9
Operating temperature	-40 °C to +85 °C

Antenna and electrical specifications 3G/2G

Standards	2G and 3G
Frequency (MHz)	824-960, 1710-2170
VSWR	~1.9:1, ~2.3:1
Peak Gain (dBi)	~1.3, ~1.3
Impedance (Ohm)	50
Polarisation	Linear
Max. Input Power (W)	25

2J0104-C885G

3G/2G

Key Features

- ✔ Low Profile
- ✔ Ground Plane Dependent



General specification

Mounting type	Connector mount
Dimensions (mm)	48 x Ø 9
Operating temperature	-40 °C to +85 °C

Antenna and electrical specifications 3G/2G

Standards	2G and 3G
Frequency (MHz)	824-960, 1710-2170
VSWR	~2.6:1, ~2.3:1
Peak Gain (dBi)	~1.0, ~1.0
Impedance (Ohm)	50
Polarisation	Linear
Max. Input Power (W)	25

2JW031-C675

3G/2G

Key Features

- ✔ Low Profile
- ✔ Hinged Connector



General specification

Mounting type	Connector mount
Dimensions (mm)	Ø 10 x 113
Operating temperature	-40 °C to +85 °C

Antenna and electrical specifications 3G/2G

Standards	2G and 3G
Frequency (MHz)	824-960, 1710-2170
VSWR	~2.1:1, ~1.6:1
Peak Gain (dBi)	~1.3, ~2.0
Impedance (Ohm)	50
Polarisation	Linear
Max. Input Power (W)	25

2J120B

3G/2G

Key Features

- ✔ Ground Plane Dependent
- ✔ Customizable Cable and Connector
- ✔ Certificates: IP67 - Water resistant



Standard colors
Other colors upon request



General specification

Mounting type	Screw mount
Dimensions (mm)	Ø 30 × 76.5
Operating temperature	-40 °C to +85 °C
Certificates	IP67

Antenna and electrical specifications

3G/2G	
Standards	2G and 3G
Frequency (MHz)	824-960, 1710-2170
VSWR	~1.8:1, ~2.2:1
Peak Gain (dBi)	~2.0, ~1.3
Impedance (Ohm)	50
Polarisation	Linear
Max. Input Power (W)	100

2J121B

3G/2G

Key Features

- ✔ Ground Plane Dependent
- ✔ Customizable Cable and Connector
- ✔ Certificates: IP67 - Water resistant



Standard colors
Other colors upon request



General specification

Mounting type	Screw mount
Dimensions (mm)	Ø 29 × 231
Operating temperature	-40 °C to +85 °C
Certificates	IP67

Antenna and electrical specifications

3G/2G	
Standards	2G and 3G
Frequency (MHz)	824-960, 1710-2170
VSWR	~1.5:1, ~2.6:1
Peak Gain (dBi)	~2.5, ~0.5
Impedance (Ohm)	50
Polarisation	Linear
Max. Input Power (W)	100

2J474B

3G/2G

Key Features

- ✔ Low Profile
- ✔ Ground Plane Independent
- ✔ Customizable Cable and Connector
- ✔ Certificates: IP69 - Hot water pressure



Standard colors
Other colors upon request



General specification

Mounting type	Screw mount
Dimensions (mm)	Ø 52 × 18.5
Operating temperature	-40 °C to +85 °C
Certificates	IP69

Antenna and electrical specifications

3G/2G	
Standards	2G and 3G
Frequency (MHz)	824-960, 1710-2170
VSWR	~1.6:1, ~2.9:1
Peak Gain (dBi)	~1.7, ~-1.5
Impedance (Ohm)	50
Polarisation	Linear
Max. Input Power (W)	25

2J4804P

3G/2G

Key Features

- ✔ Ground Plane Independent
- ✔ Customizable Cable and Connector



Black

Standard colors
Other colors upon request

General specification

Mounting type	Adhesive mount
Dimensions (mm)	83 x 35 x 13.3
Operating temperature	-40 °C to +85 °C
Note	Optional Antenna Detection Resistor

Antenna and electrical specifications

3G/2G

Standards	2G and 3G
Frequency (MHz)	824-960, 1710-2170
VSWR	~1.4:1, ~1.3:1
Peak Gain (dBi)	~3.6, ~2.1
Impedance (Ohm)	50
Polarisation	Linear
Max. Input Power (W)	25

2J500L

3G/2G

Key Features

- ✔ Ground Plane Independent
- ✔ Customizable Cable and Connector



Black

Standard colors
Other colors upon request

General specification

Mounting type	Adhesive mount
Dimensions (mm)	126.5 x 22 x 6.7
Operating temperature	-40 °C to +85 °C

Antenna and electrical specifications

3G/2G

Standards	2G and 3G
Frequency (MHz)	824-960, 1710-2170
VSWR	~1.5:1, ~1.4:1
Peak Gain (dBi)	~3.5, ~4.6
Impedance (Ohm)	50
Polarisation	Linear
Max. Input Power (W)	25

2J6804P

3G/2G

Key Features

- ✔ For Metal Surfaces
- ✔ Customizable Cable and Connector



Black

Standard colors
Other colors upon request

General specification

Mounting type	Adhesive mount
Dimensions (mm)	117 x 49.5 x 38
Operating temperature	-40 °C to +85 °C

Antenna and electrical specifications

3G/2G

Standards	2G and 3G
Frequency (MHz)	824-960, 1710-2170
VSWR	~1.4:1, ~1.5:1
Peak Gain (dBi)	~0.7, ~0.2
Impedance (Ohm)	50
Polarisation	Linear
Max. Input Power (W)	50

2J680MP

3G/2G

Key Features

- ✔ Adhesive/Magnetic Mount
- ✔ Customizable Cable and Connector



Black
Standard colors
Other colors upon request

General specification

Mounting type	Adhesive mount, Magnetic mount
Dimensions (mm)	117 x 49.5 x 38
Operating temperature	-40 °C to +85 °C

Antenna and electrical specifications

3G/2G	
Standards	2G and 3G
Frequency (MHz)	824-960, 1710-2170
VSWR	~1.4:1, ~1.5:1
Peak Gain (dBi)	~0.9, ~0.7
Impedance (Ohm)	50
Polarisation	Linear
Max. Input Power (W)	50

2J301M

3G/2G

Key Features

- ✔ Low Profile
- ✔ Ground Plane Dependent
- ✔ Customizable Cable and Connector



Black
Standard colors
Other colors upon request

General specification

Mounting type	Magnetic mount
Dimensions (mm)	30.9 x 71.5
Operating temperature	-40 °C to +85 °C

Antenna and electrical specifications

3G/2G	
Standards	2G and 3G
Frequency (MHz)	824-960, 1710-2170
VSWR	~1.6:1, ~1.8:1
Peak Gain (dBi)	~1.7, ~0.3
Impedance (Ohm)	50
Polarisation	Linear
Max. Input Power (W)	25

2J2104GP

3G/2G

Key Features

- ✔ Ground Plane Independent



White Black
Standard colors
Other colors upon request

General specification

Mounting type	Wall mount
Dimensions (mm)	368 x 155 x 36
Operating temperature	-40 °C to +85 °C

Antenna and electrical specifications

3G/2G	
Standards	2G and 3G
Frequency (MHz)	824-960, 1710-2170
VSWR	~2.9:1, ~2.2:1~
Peak Gain (dBi)	-1, ~-0.7
Impedance (Ohm)	50
Polarisation	Linear
Max. Input Power (W)	25

2J431MPGF

GPS/GLONASS

Key Features

- ✓ Adhesive/Magnetic Mount
- ✓ Ground Plane Independent
- ✓ Customizable Cable and Connector
- ✓ Certificates: **IP67** - Water resistant



Black

Standard colors
Other colors upon request

General specification

Mounting type	Adhesive mount, Magnetic mount
Dimensions (mm)	41 x 34 x 13.5/14.5
Operating temperature	-40 °C to +85 °C
Certificates	IP67

Antenna and electrical specifications

GPS/GLONASS	
Standards	GPS/QZSS/Galileo/GLONASS
Frequency (MHz)	1575.42, 1598-1606
VSWR	<1.2:1
Impedance (Ohm)	50
Polarisation	RHCP
Active Gain (dB)	26 @ 3V, 28 @ 5V
Voltage (V)	2.7 - 5.5
Current (mA)	15 - 25
Power Consumption (mW)	138 Max

2J433MPGF

GPS/GLONASS

Key Features

- ✓ Adhesive/Magnetic Mount
- ✓ Pre-Filter
- ✓ Ground Plane Independent
- ✓ Customizable Cable and Connector
- ✓ Certificates: **IP67** - Water resistant



Black

Standard colors
Other colors upon request



General specification

Mounting type	Adhesive mount, Magnetic mount
Dimensions (mm)	38 x 34 x 13.5/14.5
Operating temperature	-40 °C to +85 °C
Certificates	IP67

Antenna and electrical specifications

GPS/GLONASS	
Standards	GPS/QZSS/Galileo/GLONASS
Frequency (MHz)	1575.42, 1598-1606
VSWR	<1.2:1
Impedance (Ohm)	50
Polarisation	RHCP
Active Gain (dB)	23 @ 3V, 24 @ 5V
Voltage (V)	2.7 - 5.5
Current (mA)	15 - 25
Power Consumption (mW)	138 Max

2J471BGF

GPS/GLONASS

Key Features

- ✓ Ground Plane Independent
- ✓ Customizable Cable and Connector
- ✓ Certificates: **IP69** - Hot water pressure



Black

Standard colors
Other colors upon request



General specification

Mounting type	Screw mount
Dimensions (mm)	∅ 52 x 18.5
Operating temperature	-40 °C to +85 °C
Certificates	IP69

Antenna and electrical specifications

GPS/GLONASS	
Standards	GPS/QZSS/Galileo/GLONASS
Frequency (MHz)	1575.42, 1598-1606
VSWR	<=1.2:1, <=1.4:1
Impedance (Ohm)	50
Active Gain (dB)	32 dB @ 5V
Voltage (V)	1.8 - 5.0
Current (mA)	5 @ 1.8 V, 13 @ 3.3V, 25 @ 5V
Power Consumption (mW)	138 Max

2J0202-C115N

2.4/5.0 GHz ISM

Key Features

- ✔ Ground Plane Dependent
- ✔ High Gain



General specification

Mounting type	Connector mount
Dimensions (mm)	56 x 9.5
Operating temperature	-40 °C to +85 °C

Antenna and electrical specifications

2.4/5.0 GHz ISM

Standards	WiFi, BT, ZigBee, ISM
Frequency (MHz)	2410-2490, 4920-5925
VSWR	~1.4:1, ~1.7:1
Peak Gain (dBi)	~4.0, ~5.2
Impedance (Ohm)	50
Polarisation	Linear
Max. Input Power (W)	25

2J0202-C366N

2.4/5.0 GHz ISM

Key Features

- ✔ Ground Plane Dependent
- ✔ High Gain



General specification

Mounting type	Connector mount
Dimensions (mm)	53 x 10 x 18
Operating temperature	-40 °C to +85 °C

Antenna and electrical specifications

2.4/5.0 GHz ISM

Standards	WiFi, BT, ZigBee, ISM
Frequency (MHz)	2410-2490, 4920-5925
VSWR	~1.4:1, ~1.7:1
Peak Gain (dBi)	~4.0, ~5.2
Impedance (Ohm)	50
Polarisation	Linear
Max. Input Power (W)	25

2J230GP

2.4/5.0 GHz ISM

Key Features

- ✔ High Gain
- ✔ Ground Plane Independent
- ✔ Customizable Cable and Connector



General specification

Mounting type	Connector mount
Dimensions (mm)	53 x 10 x 18
Operating temperature	-40 °C to +85 °C

Antenna and electrical specifications

2.4/5.0 GHz ISM

Standards	WiFi, BT, ZigBee, ISM
Frequency (MHz)	2410-2490, 4920-5925
VSWR	~1.9:1, ~1.9:1
Peak Gain (dBi)	~2.9, ~4.0
Impedance (Ohm)	50
Polarisation	Linear
Max. Input Power (W)	25

2JW03-C442B

2.4/5.0 GHz ISM

Key Features

- ✔ Ground Plane Independent
- ✔ Hinged Connector
- ✔ High Gain



Black
Standard colors
Other colors upon request

General specification

Mounting type	Connector mount
Dimensions (mm)	∅ 10 × 173
Operating temperature	-40 °C to +85 °C

Antenna and electrical specifications

2.4/5.0 GHz ISM

Standards	WiFi, BT, ZigBee, ISM
Frequency (MHz)	2410-2490, 4920-5925
VSWR	~1.6:1, ~1.6:1
Peak Gain (dBi)	~3.5, ~4.2
Impedance (Ohm)	50
Polarisation	Linear
Max. Input Power (W)	25

2JW035-C442B

2.4/5.0 GHz ISM

Key Features

- ✔ Ground Plane Independent
- ✔ Hinged Connector
- ✔ Low Profile



Black
Standard colors
Other colors upon request

General specification

Mounting type	Connector mount
Dimensions (mm)	∅ 10 × 76
Operating temperature	-40 °C to +85 °C

Antenna and electrical specifications

2.4/5.0 GHz ISM

Standards	WiFi, BT, ZigBee, ISM
Frequency (MHz)	2410-2490, 4920-5925
VSWR	~2.1:1, ~2.8:1
Peak Gain (dBi)	~1.4, ~3.2
Impedance (Ohm)	50
Polarisation	Linear
Max. Input Power (W)	25

2JW1102

2.4/5.0 GHz ISM

Key Features

- ✔ Ground Plane Independent
- ✔ High Gain
- ✔ Hinged Connector

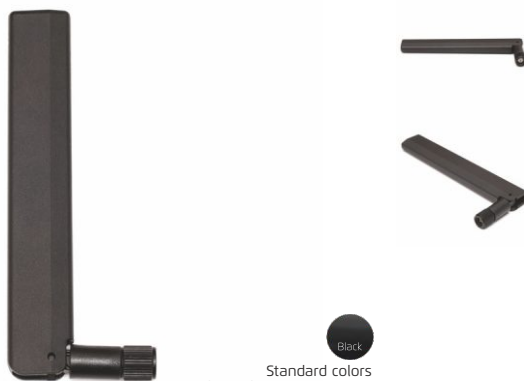

Black
Standard colors
Other colors upon request

General specification

Mounting type	Connector mount
Dimensions (mm)	135 × 19 × 10
Operating temperature	-40 °C to +85 °C

Antenna and electrical specifications

2.4/5.0 GHz ISM

Standards	WiFi, BT, ZigBee, ISM
Frequency (MHz)	2410-2490, 4920-5925
VSWR	~1.4:1, ~1.7:1
Peak Gain (dBi)	~4.1, ~3.9
Impedance (Ohm)	50
Polarisation	Linear
Max. Input Power (W)	25

2J4802P

2.4/5.0 GHz ISM

Key Features

- ✔ Ground Plane Independent
- ✔ Customizable Cable and Connector



Black

Standard colors
Other colors upon request

General specification

Mounting type	Adhesive mount
Dimensions (mm)	83 x 35 x 13.3
Operating temperature	-40 °C to +85 °C

Antenna and electrical specifications

2.4/5.0 GHz ISM

Standards	WiFi, BT, ZigBee, ISM
Frequency (MHz)	2410-2490, 4920-5925
VSWR	~1.3:1, ~1.3:1
Peak Gain (dBi)	~3.2, ~4.2
Impedance (Ohm)	50
Polarisation	Linear
Max. Input Power (W)	25

2J5502P

2.4/5.0 GHz ISM

Key Features

- ✔ Ground Plane Independent
- ✔ Customizable Cable and Connector



Black

Standard colors
Other colors upon request

General specification

Mounting type	Adhesive mount
Dimensions (mm)	7 x 25.5 x 72
Operating temperature	-40 °C to +85 °C

Antenna and electrical specifications

2.4/5.0 GHz ISM

Standards	WiFi, BT, ZigBee, ISM
Frequency (MHz)	2410-2490, 4920-5925
VSWR	~1.3:1, ~1.9:1
Peak Gain (dBi)	~3.4, ~2.6
Impedance (Ohm)	50
Polarisation	Linear
Max. Input Power (W)	25

2J6302MP

2.4/5.0 GHz ISM

Key Features

- ✔ Adhesive/Magnetic Mount
- ✔ Ground Plane Dependent
- ✔ Customizable Cable and Connector
- ✔ Certificates: **IP67** - Water resistant



Black

Standard colors
Other colors upon request

General specification

Mounting type	Adhesive mount, Magnetic mount
Dimensions (mm)	52.5 x 14.3
Operating temperature	-40 °C to +85 °C
Certificates	IP67

Antenna and electrical specifications

2.4/5.0 GHz ISM

Standards	WiFi, BT, ZigBee, ISM
Frequency (MHz)	2410-2490, 4920-5925
VSWR	~1.3:1, ~1.3:1
Peak Gain (dBi)	~2.0, ~1.6
Impedance (Ohm)	50
Polarisation	Linear
Max. Input Power (W)	25

2J4702B

2.4/5.0 GHz ISM

Key Features

- ✔ Ground Plane Dependent
- ✔ Customizable Cable and Connector
- ✔ Certificates: **IP69** - Hot water pressure



Standard colors
Other colors upon request

General specification

Mounting type	Screw mount
Dimensions (mm)	Ø 52 x 18.5
Operating temperature	-40 °C to +85 °C
Certificates	IP69

Antenna and electrical specifications

2.4/5.0 GHz ISM

Standards	WiFi, BT, ZigBee, ISM
Frequency (MHz)	2410-2490, 4920-5925
VSWR	~1.6:1, ~1.7:1
Peak Gain (dBi)	~2.2, ~1.5
Impedance (Ohm)	50
Polarisation	Linear
Max. Input Power (W)	25

2J6A02B

2.4/5.0 GHz ISM

Key Features

- ✔ surge protection up to 6kV
- ✔ Ground Plane Independent
- ✔ Customizable Cable and Connector
- ✔ Certificates: **IP67** - Water resistant, **IP69** - Hot water pressure, **IK09** - Impact resistant



Standard colors
Other colors upon request

General specification

Mounting type	Screw mount
Dimensions (mm)	Ø 77.3 x 65.5
Operating temperature	-40 °C to +85 °C
Certificates	IP67, IP69, IK09

Antenna and electrical specifications

2.4/5.0 GHz ISM

Standards	WiFi, BT, ZigBee, ISM
Frequency (MHz)	2410-2490, 4920-5925
VSWR	~1.8:1, ~1.8:1
Peak Gain (dBi)	~2.6, ~4.4
Impedance (Ohm)	50
Polarisation	Linear
Max. Input Power (W)	25

2J662B

2.4/5.0 GHz ISM

Key Features

- ✔ Low Profile
- ✔ Ground Plane Dependent
- ✔ Customizable Cable and Connector
- ✔ Certificates: **IP67** - Water resistant, **IP69** - Hot water pressure



Standard colors
Other colors upon request

General specification

Mounting type	Screw mount
Dimensions (mm)	77.3 x 15.9
Operating temperature	-40 °C to +85 °C
Certificates	IP67, IP69

Antenna and electrical specifications

2.4/5.0 GHz ISM

Standards	WiFi, BT, ZigBee, ISM
Frequency (MHz)	2410-2490, 4920-5925
VSWR	~1.2:1, ~1.4:1
Peak Gain (dBi)	~4.3, ~1.8
Impedance (Ohm)	50
Polarisation	Linear
Max. Input Power (W)	25

2J672B

2.4/5.0 GHz ISM

Key Features

- ✔ Ground Plane Independent
- ✔ Customizable Cable and Connector
- ✔ Certificates: **IP67** - Water resistant, **IP69** - Hot water pressure, **IK09** and **IK10** version possible



General specification

Mounting type	Screw mount
Dimensions (mm)	77.3 x 36.5
Operating temperature	-40 °C to +85 °C
Certificates	IP67, IP69, IK09 and IK10 version possible

Antenna and electrical specifications

2.4/5.0 GHz ISM

Standards	WiFi, BT, ZigBee, ISM
Frequency (MHz)	2410-2490, 4920-5925
VSWR	~1.2:1, ~1.4:1
Peak Gain (dBi)	~4.3, ~1.8
Impedance (Ohm)	50
Polarisation	Linear
Max. Input Power (W)	25

2JWIF12

2.4/5.0 GHz ISM

Key Features

- ✔ High Gain 7.2 dBi (2.4 GHz)
- ✔ Directional Antenna
- ✔ Customizable Cable and Connector



General specification

Mounting type	Mast mount
Dimensions (mm)	104 x 104 x 90
Operating temperature	-40 °C to +85 °C

Antenna and electrical specifications

2.4/5.0 GHz ISM

Standards	WiFi, BT, ZigBee, ISM
Frequency (MHz)	2410-2490, 4920-5925
VSWR	~1.6:1, ~1.8:1
Peak Gain (dBi)	~7.2, ~5.2
Impedance (Ohm)	50
Polarisation	Linear
Max. Input Power (W)	25

2J0102-C115N

2.4 GHz ISM

Key Features

- ✔ Low Profile



Standard colors
Other colors upon request

General specification

Mounting type	Connector mount
Dimensions (mm)	∅ 9.5 × 56
Operating temperature	-40 °C to +85 °C

Antenna and electrical specifications

2.4 GHz ISM	
Standards	WiFi, BT, ZigBee, ISM
Frequency (MHz)	2410-2490
VSWR	~2.2:1
Peak Gain (dBi)	~3.6
Impedance (Ohm)	50
Polarisation	Linear
Max. Input Power (W)	25

2J0102-C366N

2.4 GHz ISM

Key Features

- ✔ Low Profile
- ✔ High Efficiency

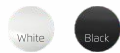

Standard colors
Other colors upon request

General specification

Mounting type	Connector mount
Dimensions (mm)	53 × 10 × 18
Operating temperature	-40 °C to +85 °C

Antenna and electrical specifications

2.4 GHz ISM	
Standards	WiFi, BT, ZigBee, ISM
Frequency (MHz)	2410-2490
VSWR	~1.3:1
Peak Gain (dBi)	~3.2
Impedance (Ohm)	50
Polarisation	Linear
Max. Input Power (W)	25

2J1002B

2.4 GHz ISM

Key Features

- ✔ Ground Plane Dependent
- ✔ Customizable Cable and Connector



Standard colors
Other colors upon request

General specification

Mounting type	Screw mount
Dimensions (mm)	∅ 16 × 50
Operating temperature	-40 °C to +85 °C

Antenna and electrical specifications

2.4 GHz ISM	
Standards	WiFi, BT, ZigBee, ISM
Frequency (MHz)	2410-2490
VSWR	~1.3:1
Peak Gain (dBi)	~1.2
Impedance (Ohm)	50
Polarisation	Linear
Max. Input Power (W)	25

2J0A02-2.4-C151G

2.4 GHz ISM

Key Features

- ✔ High Efficiency
- ✔ Ground Plane Dependent



Black

Standard colors
Other colors upon request

General specification

Mounting type	Connector mount
Dimensions (mm)	Ø 9.6 x 44
Operating temperature	-40 °C to +85 °C

Antenna and electrical specifications

2.4 GHz ISM	
Standards	WiFi, BT, ZigBee, ISM
Frequency (MHz)	2410-2490
VSWR	~4.1:1
Peak Gain (dBi)	~3.5
Impedance (Ohm)	50
Polarisation	Linear
Max. Input Power (W)	25

2JW032-C442B

2.4 GHz ISM

Key Features

- ✔ Ground Plane Independent
- ✔ Hinged Connector
- ✔ High Efficiency



Black

Standard colors
Other colors upon request

General specification

Mounting type	Connector mount
Dimensions (mm)	Ø 10 x 113
Operating temperature	-40 °C to +85 °C

Antenna and electrical specifications

2.4 GHz ISM	
Standards	WiFi, BT, ZigBee, ISM
Frequency (MHz)	2410-2490
VSWR	~1.9:1
Peak Gain (dBi)	~1.5
Impedance (Ohm)	50
Polarisation	Vertical
Max. Input Power (W)	25

2J3702M

2.4 GHz ISM

Key Features

- ✔ Ground Plane Dependent
- ✔ Certificates: IP67 - Water resistant



Black

Standard colors
Other colors upon request

General specification

Mounting type	Magnetic mount
Dimensions (mm)	Ø 31 x 71.5
Operating temperature	-40 °C to +85 °C
Certificates	IP67

Antenna and electrical specifications

2.4 GHz ISM	
Standards	WiFi, BT, ZigBee, ISM
Frequency (MHz)	2410-2490
VSWR	~1.2:1
Peak Gain (dBi)	~1.6
Impedance (Ohm)	50
Polarisation	Linear
Max. Input Power (W)	25

2J472B

2.4 GHz ISM

Key Features

- ✔ Ground Plane Dependent
- ✔ Customizable Cable and Connector
- ✔ Certificates: **IP69** - Hot water pressure



General specification

Mounting type	Screw mount
Dimensions (mm)	Ø 52 × 18.5
Operating temperature	-40 °C to +85 °C
Certificates	IP69

Antenna and electrical specifications

2.4 GHz ISM	
Standards	WiFi, BT, ZigBee, ISM
Frequency (MHz)	2410-2490
VSWR	~1.6:1
Peak Gain (dBi)	~2.2
Impedance (Ohm)	50
Polarisation	Linear
Max. Input Power (W)	25

2J7102B

2.4 GHz ISM

Key Features

- ✔ Ground Plane Dependent
- ✔ Customizable Cable and Connector
- ✔ Certificates: **IP67** - Water resistant



General specification

Mounting type	Screw mount
Dimensions (mm)	Ø 60 × 15.3
Operating temperature	-40 °C to +85 °C
Certificates	IP67

Antenna and electrical specifications

2.4 GHz ISM	
Standards	WiFi, BT, ZigBee, ISM
Frequency (MHz)	2410-2490
VSWR	~1.5:1
Peak Gain (dBi)	~3.3
Impedance (Ohm)	50
Polarisation	Linear
Max. Input Power (W)	25

2J7102M

2.4 GHz ISM

Key Features

- ✔ Ground Plane Dependent
- ✔ Customizable Cable and Connector
- ✔ Certificates: **IP67** - Water resistant, **IP69** - Hot water pressure



General specification

Mounting type	Magnetic mount
Dimensions (mm)	Ø 54 × 14.7
Operating temperature	-40 °C to +85 °C
Certificates	IP67, IP69

Antenna and electrical specifications

2.4 GHz ISM	
Standards	WiFi, BT, ZigBee, ISM
Frequency (MHz)	2410-2490
VSWR	~1.3:1
Peak Gain (dBi)	~3.0
Impedance (Ohm)	50
Polarisation	Linear
Max. Input Power (W)	25

2J0A02-5.0-C151G

5.0 GHz ISM

Key Features

- ✔ High Efficiency
- ✔ High Gain
- ✔ Ground Plane Dependent



Standard colors
Other colors upon request

General specification

Mounting type	Connector mount
Dimensions (mm)	∅ 9.6 × 44
Operating temperature	-40 °C to +85 °C

Antenna and electrical specifications

5.0 GHz ISM

Standards	WiFi, ISM
Frequency (MHz)	4920-5925
VSWR	~1.6:1
Peak Gain (dBi)	~5.3
Impedance (Ohm)	50
Polarisation	Linear
Max. Input Power (W)	25

2J0115-915-C109N

915 MHz ISM

Key Features

- ✔ Ground Plane Dependent
- ✔ Low Profile



General specification

Mounting type	Connector mount
Dimensions (mm)	53 × 10 × 18
Operating temperature	-40 °C to +85 °C

Antenna and electrical specifications

915 MHz ISM

Standards	ZigBee, ISM, SIGFOX, LoRa
Frequency (MHz)	902-928
VSWR	~2.5:1
Peak Gain (dBi)	~0.6
Impedance (Ohm)	50
Polarisation	Linear
Max. Input Power (W)	25

2J0115-915-C20N

915 MHz ISM

Key Features

- ✔ Ground Plane Dependent
- ✔ Low Profile



General specification

Mounting type	Connector mount
Dimensions (mm)	∅ 9.6 × 56
Operating temperature	-40 °C to +85 °C

Antenna and electrical specifications

915 MHz ISM

Standards	ZigBee, ISM, SIGFOX, LoRa
Frequency (MHz)	902-928
VSWR	~2.8:1
Peak Gain (dBi)	~-0.03
Impedance (Ohm)	50
Polarisation	Linear
Max. Input Power (W)	25

2JW031-915-C675

915 MHz ISM

Key Features

- ✔ Ground Plane Independent
- ✔ Hinged Connector



General specification

Mounting type	Connector mount
Dimensions (mm)	∅ 10 × 113
Operating temperature	-40 °C to +85 °C

Antenna and electrical specifications

915 MHz ISM

Standards	ZigBee, ISM, SIGFOX, LoRa
Frequency (MHz)	902-928
VSWR	~1.5:1
Peak Gain (dBi)	~-2.5
Impedance (Ohm)	50
Polarisation	Linear
Max. Input Power (W)	25

2J7615B-915

915 MHz ISM

Key Features

- ✔ Ground Plane Independent
- ✔ Customizable Cable and Connector
- ✔ Certificates: **IP67** - Water resistant, **IP69** - Hot water pressure



Black
Standard colors
Other colors upon request

General specification

Mounting type	Screw mount
Dimensions (mm)	Ø 54 x 50
Operating temperature	-40 °C to +85 °C
Certificates	IP67, IP69

Antenna and electrical specifications

915 MHz ISM

Standards	ZigBee, ISM, SIGFOX, LoRa
Frequency (MHz)	902-928
VSWR	~2.1:1
Peak Gain (dBi)	~2.5
Impedance (Ohm)	50
Polarisation	Linear
Max. Input Power (W)	25

2J6615B-915

915 MHz ISM

Key Features

- ✔ Low Profile
- ✔ Ground Plane Dependent
- ✔ Customizable Cable and Connector
- ✔ Certificates: **IP67** - Water resistant, **IP69** - Hot water pressure



Black
Standard colors
Other colors upon request

General specification

Mounting type	Screw mount
Dimensions (mm)	Ø 77.4 x 15
Operating temperature	-40 °C to +85 °C
Certificates	IP67, IP69

Antenna and electrical specifications

915 MHz ISM

Standards	ZigBee, ISM, SIGFOX, LoRa
Frequency (MHz)	902-928
VSWR	~1.5:1
Peak Gain (dBi)	~0.85
Impedance (Ohm)	50
Polarisation	Linear
Max. Input Power (W)	25

2J6A42B-915

915 MHz ISM

Key Features

- ✔ High Gain
- ✔ Ground Plane Independent
- ✔ Customizable Cable and Connector
- ✔ Certificates: **IP67** - Water resistant, **IP69** - Hot water pressure, **IK09** - Impact resistant



White Black
Standard colors
Other colors upon request

General specification

Mounting type	Screw mount
Dimensions (mm)	Ø 77.3 x 65.5
Operating temperature	-40 °C to +85 °C
Certificates	IP67, IP69, IK09

Antenna and electrical specifications

915 MHz ISM

Standards	ZigBee, ISM, SIGFOX, LoRa
Frequency (MHz)	902-928
VSWR	~1.4:1
Peak Gain (dBi)	~4.0
Impedance (Ohm)	50
Polarisation	Linear
Max. Input Power (W)	25

2J2024B-915

915 MHz ISM

Key Features

- ✔ High Gain 3 dBi
- ✔ Omni-Directional
- ✔ Customizable Cable and Connector



Standard colors
Other colors upon request

General specification

Mounting type	Screw mount
Dimensions (mm)	Ø 22 x 170
Operating temperature	-40 °C to +85 °C

Antenna and electrical specifications

915 MHz ISM

Standards	ZigBee, ISM, SIGFOX, LoRa
Frequency (MHz)	902-928
VSWR	~1.6:1
Peak Gain (dBi)	~3.0
Impedance (Ohm)	50
Polarisation	Linear
Max. Input Power (W)	25

2J5215P

915 MHz ISM

Key Features

- ✔ Flexible Housing
- ✔ Compact Size
- ✔ High Performance
- ✔ Customizable Cable and Connector



Standard colors
Other colors upon request

General specification

Mounting type	Adhesive mount
Dimensions (mm)	117.4 x 12.5 x 6.5
Operating temperature	-40 °C to +85 °C

Antenna and electrical specifications

915 MHz ISM

Standards	ZigBee, ISM, SIGFOX, LoRa
Frequency (MHz)	902-928
VSWR	~1.4:1
Peak Gain (dBi)	~3.6
Impedance (Ohm)	50
Polarisation	Linear
Max. Input Power (W)	25

2J3015M-915

915 MHz ISM

Key Features

- ✔ High Performance
- ✔ Ground Plane Dependent
- ✔ Customizable Cable and Connector



Standard colors
Other colors upon request

General specification

Mounting type	Magnetic mount
Dimensions (mm)	Ø 30.9 x 88
Operating temperature	-40 °C to +85 °C

Antenna and electrical specifications

915 MHz ISM

Standards	ZigBee, ISM, SIGFOX, LoRa
Frequency (MHz)	902-928
VSWR	~1.5:1
Peak Gain (dBi)	~2.4
Impedance (Ohm)	50
Polarisation	Linear
Max. Input Power (W)	25

2J3015M-868

868 MHz ISM

Key Features

- ✔ High Performance
- ✔ Ground Plane Dependent
- ✔ Customizable Cable and Connector



General specification

Mounting type	Magnetic mount
Dimensions (mm)	Ø 30.9 × 88
Operating temperature	-40 °C to +85 °C

Antenna and electrical specifications

868 MHz ISM

Standards	ZigBee, ISM, SIGFOX, LoRa
Frequency (MHz)	863-870
VSWR	~1.3:1
Peak Gain (dBi)	~2.6
Impedance (Ohm)	50
Polarisation	Linear
Max. Input Power (W)	25

2J7615B-868

868 MHz ISM

Key Features

- ✔ Ground Plane Independent
- ✔ Customizable Cable and Connector
- ✔ Certificates: **IP67** - Water resistant, **IP69** - Hot water pressure



General specification

Mounting type	Screw mount
Dimensions (mm)	Ø 54 × 50
Operating temperature	-40 °C to +85 °C
Certificates	IP67, IP69

Antenna and electrical specifications

868 MHz ISM

Standards	ZigBee, ISM, SIGFOX, LoRa
Frequency (MHz)	863-870
VSWR	~1.9:1
Peak Gain (dBi)	~-0.8
Impedance (Ohm)	50
Polarisation	Linear
Max. Input Power (W)	25

2J0115-433-C109N

433 MHz ISM

Key Features

- ✔ Ground Plane Dependent
- ✔ Low Profile



General specification

Mounting type	Connector mount
Dimensions (mm)	53 × 10 × 18
Operating temperature	-40 °C to +85 °C

Antenna and electrical specifications

433 MHz ISM

Standards	ISM, LoRa
Frequency (MHz)	433-435
VSWR	~1.6:1
Peak Gain (dBi)	~-3.8
Impedance (Ohm)	50
Polarisation	Linear
Max. Input Power (W)	25

2J0115-433-C20N

433 MHz ISM

Key Features

- ✔ Ground Plane Dependent
- ✔ Low Profile



General specification

Mounting type	Connector mount
Dimensions (mm)	∅ 9.5 × 56
Operating temperature	-40 °C to +85 °C

Antenna and electrical specifications

433 MHz ISM

Standards	ISM, LoRa
Frequency (MHz)	433-435
VSWR	~1.8:1
Peak Gain (dBi)	~-2.4
Impedance (Ohm)	50
Polarisation	Linear
Max. Input Power (W)	25

2JW0410-C109N

433 MHz ISM

Key Features

- ✔ Ground Plane Dependent

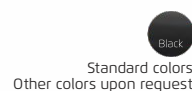

General specification

Mounting type	Connector mount
Dimensions (mm)	138 × 10 × 18
Operating temperature	-40 °C to +85 °C

Antenna and electrical specifications

433 MHz ISM

Standards	ISM, LoRa
Frequency (MHz)	433-435
VSWR	~2.2:1
Peak Gain (dBi)	~-1.1
Impedance (Ohm)	50
Polarisation	Linear
Max. Input Power (W)	35

2JW0410-C20N

433 MHz ISM

Key Features

- ✔ Ground Plane Dependent



Standard colors
Other colors upon request

General specification

Mounting type	Connector mount
Dimensions (mm)	∅ 10 × 139
Operating temperature	-40 °C to +85 °C

Antenna and electrical specifications

433 MHz ISM

Standards	ISM, LoRa
Frequency (MHz)	433-435
VSWR	~3.0:1
Peak Gain (dBi)	~-0.7
Impedance (Ohm)	50
Polarisation	Linear
Max. Input Power (W)	35

2JW08-C20N

433 MHz ISM

Key Features

- ✔ Ground Plane Dependent
- ✔ Low Profile



Standard colors
Other colors upon request



General specification

Mounting type	Connector mount
Dimensions (mm)	∅ 12.6 × 132
Operating temperature	-40 °C to +85 °C

Antenna and electrical specifications

433 MHz ISM

Standards	ISM, LoRa
Frequency (MHz)	433-435
VSWR	~3.8:1
Peak Gain (dBi)	~-0.3
Impedance (Ohm)	50
Polarisation	Linear
Max. Input Power (W)	25

2J0710-C708N

433 MHz ISM

Key Features

- ✔ Ground Plane Dependent
- ✔ Low Profile



Standard colors
Other colors upon request



General specification

Mounting type	Connector mount
Dimensions (mm)	∅ 13.2 × 54.6
Operating temperature	-40 °C to +85 °C

Antenna and electrical specifications

433 MHz ISM

Standards	ISM, LoRa
Frequency (MHz)	433-435
VSWR	~1.6:1
Peak Gain (dBi)	~-1.1
Impedance (Ohm)	50
Polarisation	Linear
Max. Input Power (W)	25

2J340M

433 MHz ISM

Key Features

- ✔ Ground Plane Dependent
- ✔ Low Profile
- ✔ Customizable Cable and Connector

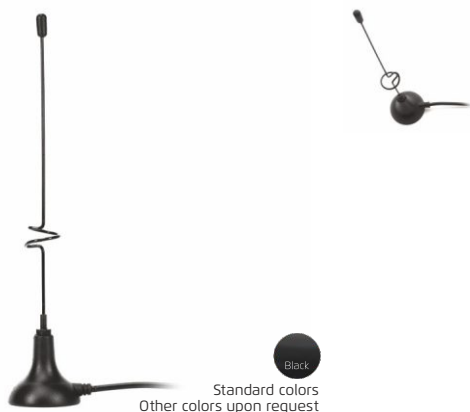

General specification

Mounting type	Magnetic mount
Dimensions (mm)	Ø 31 × 164
Operating temperature	-40 °C to +85 °C

Antenna and electrical specifications

433 MHz ISM

Standards	ISM, LoRa
Frequency (MHz)	433-435
VSWR	~1.1:1
Peak Gain (dBi)	~2.1
Impedance (Ohm)	50
Polarisation	Linear
Max. Input Power (W)	50

2J6510M

433 MHz ISM

Key Features

- ✔ Ground Plane Dependent
- ✔ Customizable Cable and Connector
- ✔ Certificates: **IP67** - Water resistant, **IP69** - Hot water pressure, **IK09** - Impact resistant



General specification

Mounting type	Magnetic mount
Dimensions (mm)	Ø 135.5 × 30
Operating temperature	-40 °C to +85 °C
Certificates	IP67, IP69, IK09

Antenna and electrical specifications

433 MHz ISM

Standards	ISM, LoRa
Frequency (MHz)	433-435
VSWR	~1.1:1
Peak Gain (dBi)	~2.9
Impedance (Ohm)	50
Polarisation	Linear
Max. Input Power (W)	50

2J7510M

433 MHz ISM

Key Features

- ✔ Ground Plane Dependent
- ✔ Customizable Cable and Connector
- ✔ Certificates: **IP67** - Water resistant, **IP69** - Hot water pressure



General specification

Mounting type	Magnetic mount
Dimensions (mm)	Ø 54 × 201.9
Operating temperature	-40 °C to +85 °C
Certificates	IP67, IP69

Antenna and electrical specifications

433 MHz ISM

Standards	ISM, LoRa
Frequency (MHz)	433-435
VSWR	~2.0:1
Peak Gain (dBi)	~0.1
Impedance (Ohm)	50
Polarisation	Linear
Max. Input Power (W)	50

2J130B

433 MHz ISM

Key Features

- ✔ Ground Plane Independent
- ✔ High Gain
- ✔ Customizable Cable and Connector



General specification

Mounting type	Screw mount
Dimensions (mm)	∅ 33 x 172
Operating temperature	-40 °C to +85 °C

Antenna and electrical specifications

433 MHz ISM

Standards	ISM, LoRa
Frequency (MHz)	433-435
VSWR	~2.0:1
Peak Gain (dBi)	~1.6
Impedance (Ohm)	50
Polarisation	Linear
Max. Input Power (W)	50

2J5410H-433

433 MHz ISM

Key Features

- ✔ Screw/Adhesive/Wall Mount
- ✔ High Gain
- ✔ Ground Plane Independent
- ✔ Customizable Cable and Connector



General specification

Mounting type	Screw/Adhesive/Wall Mount
Dimensions (mm)	60 x 112.5 x 11.3
Operating temperature	-40 °C to +85 °C

Antenna and electrical specifications

433 MHz ISM

Standards	ISM, LoRa
Frequency (MHz)	433-435
VSWR	~1.2:1
Peak Gain (dBi)	~2.4
Impedance (Ohm)	50
Polarisation	Linear
Max. Input Power (W)	50

2J545P-433

433 MHz ISM

Key Features

- ✔ High Gain
- ✔ Ground Plane Independent
- ✔ Customizable Cable and Connector



General specification

Mounting type	Adhesive mount
Dimensions (mm)	60 x 112.5 x 11.3
Operating temperature	-40 °C to +85 °C

Antenna and electrical specifications

433 MHz ISM

Standards	ISM, LoRa
Frequency (MHz)	433-435
VSWR	~1.2:1
Peak Gain (dBi)	~2.4
Impedance (Ohm)	50
Polarisation	Linear
Max. Input Power (W)	50

2J6510B

433 MHz ISM

Key Features

- ✔ Ground Plane Dependent
- ✔ Customizable Cable and Connector
- ✔ Certificates: **IP67** - Water resistant, **IP69** - Hot water pressure, **IK09** - Impact resistant



General specification

Mounting type	Screw mount
Dimensions (mm)	Ø 146 × 31.5
Operating temperature	-40 °C to +85 °C
Certificates	IP67, IP69, IK09

Antenna and electrical specifications

433 MHz ISM

Standards	ISM, LoRa
Frequency (MHz)	433-435
VSWR	~1.3:1
Peak Gain (dBi)	~2.9
Impedance (Ohm)	50
Polarisation	Linear
Max. Input Power (W)	50

2J7510B

433 MHz ISM

Key Features

- ✔ Ground Plane Dependent
- ✔ Customizable Cable and Connector
- ✔ Certificates: **IP67** - Water resistant, **IP69** - Hot water pressure



General specification

Mounting type	Screw mount
Dimensions (mm)	Ø 60 × 205
Operating temperature	-40 °C to +85 °C
Certificates	IP67, IP69

Antenna and electrical specifications

433 MHz ISM

Standards	ISM, LoRa
Frequency (MHz)	433-435
VSWR	~2.0:1
Peak Gain (dBi)	~-0.1
Impedance (Ohm)	50
Polarisation	Linear
Max. Input Power (W)	50

2J6026M Iridium Certified Antenna

IRIDIUM

Key Features

- ✔ Low Profile
- ✔ High Performance
- ✔ Ground Plane Independent
- ✔ Customizable Cable and Connector
- ✔ Certificates: **IP67** - Water resistant



Black
Standard colors
Other colors upon request

General specification

Mounting type	Magnetic mount
Dimensions (mm)	80 x 76 x 13
Operating temperature	-40 °C to +85 °C
Certificates	IP67

Antenna and electrical specifications

IRIDIUM	
Standards	IRIDIUM
Frequency (MHz)	1616-1627
VSWR	~1.2:1
Passive Gain (dBiC)	~4.5
Impedance (Ohm)	50
Axial Ratio (dB)	3 max
Radiation Pattern	Hemispherical
Polarization	RHCP

2J6026P

IRIDIUM

Key Features

- ✔ Low Profile
- ✔ High Performance
- ✔ Ground Plane Independent
- ✔ Customizable Cable and Connector
- ✔ Certificates: **IP67** - Water resistant



Black
Standard colors
Other colors upon request

General specification

Mounting type	Adhesive mount
Dimensions (mm)	80 x 76 x 13
Operating temperature	-40 °C to +85 °C
Certificates	IP67

Antenna and electrical specifications

IRIDIUM	
Standards	IRIDIUM
Frequency (MHz)	1616-1627
VSWR	~1.2:1
Passive Gain (dBiC)	~4.5
Impedance (Ohm)	50
Axial Ratio (dB)	3 max
Radiation Pattern	Hemispherical
Polarization	RHCP

2J6726B Iridium Certified Antenna

IRIDIUM

Key Features

- ✔ Ground Plane Independent
- ✔ Customizable Cable and Connector
- ✔ Certificates: **IP67** - Water resistant, **IP69** - Hot water pressure, **IK09** - Impact resistant



Black
Standard colors
Other colors upon request

General specification

Mounting type	Screw mount
Dimensions (mm)	∅ 77.3 x 36.5
Operating temperature	-40 °C to +85 °C
Certificates	IP67, IP69, IK09

Antenna and electrical specifications

IRIDIUM	
Standards	IRIDIUM
Frequency (MHz)	1616-1627
VSWR	~1.2:1
Passive Gain (dBiC)	~4.5
Impedance (Ohm)	50
Axial Ratio (dB)	3 max
Radiation Pattern	Hemispherical
Polarization	RHCP

2J9026B

IRIDIUM

Key Features

- ✔ Marine Antenna
- ✔ High Performance
- ✔ Ground Plane Independent
- ✔ Customizable Cable and Connector
- ✔ Certificates: **IP67** - Water resistant



General specification

Mounting type	Screw mount
Dimensions (mm)	116 x 110 x 74
Operating temperature	-40 °C to +85 °C
Certificates	IP67

Antenna and electrical specifications

IRIDIUM

Standards	IRIDIUM
Frequency (MHz)	1616-1627
VSWR	~1.2:1
Passive Gain (dBiC)	~4.5
Impedance (Ohm)	50
Axial Ratio (dB)	3 max
Radiation Pattern	Hemispherical
Polarization	RHCP

2J5410H

TETRA 380-500 MHz

Key Features

- ✔ Screw/Adhesive/Wall Mount
- ✔ High Gain
- ✔ Ground Plane Independent
- ✔ Customizable Cable and Connector

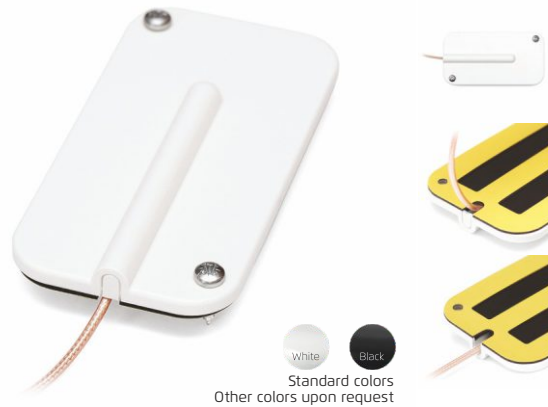

General specification

Mounting type	Screw/Adhesive/Wall Mount
Dimensions (mm)	60 x 112.5 x 11.3
Operating temperature	-40 °C to +85 °C

Antenna and electrical specifications

TETRA 380-500 MHz	
Standards	TETRA
Frequency (MHz)	380-470
VSWR	~2:1
Peak Gain (dBi)	~2.8
Impedance (Ohm)	50
Polarisation	Linear
Max. Input Power (W)	50

2J545P

TETRA 380-500 MHz

Key Features

- ✔ High Gain
- ✔ Ground Plane Independent
- ✔ Customizable Cable and Connector



General specification

Mounting type	Adhesive mount
Dimensions (mm)	60 x 112.5 x 11.3
Operating temperature	-40 °C to +85 °C

Antenna and electrical specifications

TETRA 380-500 MHz	
Standards	TETRA
Frequency (MHz)	380-470
VSWR	~2:1
Peak Gain (dBi)	~2.8
Impedance (Ohm)	50
Polarisation	Linear
Max. Input Power (W)	50

2J7010B

TETRA 380-500 MHz

Key Features

- ✔ DC Grounded Antenna
- ✔ High Gain
- ✔ Loaded Dipole
- ✔ Ground Plane Dependent
- ✔ Customizable Cable and Connector
- ✔ Certificates: **IP67** - Water resistant, **IP69** - Hot water pressure, **IK09** - Impact resistant



General specification

Mounting type	Screw mount
Dimensions (mm)	∅ 96 x 130
Operating temperature	-40 °C to +85 °C
Certificates	IP67, IP69, IK09

Antenna and electrical specifications

TETRA 380-500 MHz	
Standards	TETRA
Frequency (MHz)	380-470
VSWR	~1.5:1
Peak Gain (dBi)	~2.5
Impedance (Ohm)	50
Polarisation	Linear
Max. Input Power (W)	50

combination external antennas



2J4A24Pa 2-in-1 antenna

2 x 4G LTE/3G/2G MIMO

Key Features

- ✔ High Performance
- ✔ Ground Plane Independent
- ✔ Customizable Cable and Connector
- ✔ Certificates: **IP67** - Water resistant, **IP69** - Hot water pressure



General specification

Mounting type	Adhesive mount
Dimensions (mm)	58.7 x 157.6 x 14.4
Operating temperature	-40 °C to +85 °C
Certificates	IP67, IP69

Antenna and electrical specifications

4G LTE/3G/2G (Connection 1)	
Standards	2G,3G and 4G
Frequency (MHz)	698-960, 1710-2170, 2500-2700
VSWR	~2.1:1, ~1.6:1, ~2.0:1
Peak Gain (dBi)	~1.9, ~3.3, ~2.2
Impedance (Ohm)	50
Polarisation	Linear
Max. Input Power (W)	25

Antenna and electrical specifications

4G LTE/3G/2G (Connection 2)	
Standards	2G,3G and 4G
Frequency (MHz)	698-960, 1710-2170, 2500-2700
VSWR	~2.1:1, ~1.7:1, ~1.8:1
Peak Gain (dBi)	~2.0, ~2.7, ~1.6
Impedance (Ohm)	50
Polarisation	Linear
Max. Input Power (W)	25

2J4441RPGF 2-in-1 antenna

4G LTE/3G/2G | GPS/GLONASS

Key Features

- ✔ 10K resistor for antenna detection
- ✔ Ground Plane Independent
- ✔ Customizable Cable and Connector
- ✔ Certificates: **IP67** - Water resistant



General specification

Mounting type	Adhesive mount
Dimensions (mm)	161 x 76.5 x 16
Operating temperature	-40 °C to +85 °C
Certificates	IP67

Antenna and electrical specifications

4G LTE/3G/2G (Connection 1)	
Standards	2G,3G and 4G
Frequency (MHz)	698-960, 1710-2170, 2500-2700
VSWR	~2.2:1, ~1.3:1, ~1.7:1
Peak Gain (dBi)	~3.1, ~4.1, ~3.7
Impedance (Ohm)	50
Polarisation	Linear
Max. Input Power (W)	35

Antenna and electrical specifications

GPS/GLONASS (Connection 2)	
Standards	GPS/QZSS/Galileo/GLONASS
Frequency (MHz)	1575.42, 1598-1610
VSWR	<=1.5:1
Impedance (Ohm)	50
Polarisation	RHCP
Active Gain (dB)	23 @ 3 V, 24 @ 5 V
Voltage (V)	2.7 - 5.5
Current (mA)	15 - 25
Power Consumption (mW)	40.5 - 137.5

2J4841PGF 2-in-1 antenna 4G LTE/3G/2G | GPS/GLONASS

Key Features

- ✔ Ground Plane Independent
- ✔ Customizable Cable and Connector



Antenna and electrical specifications

4G LTE/3G/2G (Connection 1)

Standards	2G,3G and 4G
Frequency (MHz)	698-960, 1710-2170, 2500-2700
VSWR	~1.8:1, ~1.3:1, ~2.0:1
Peak Gain (dBi)	~2.4, ~1.3, ~0.4
Impedance (Ohm)	50
Polarisation	Linear
Max. Input Power (W)	25

General specification

Mounting type	Adhesive mount
Dimensions (mm)	83 x 35 x 13.3
Operating temperature	-40 °C to +85 °C
Note	Optional Antenna Detection Resistor

Antenna and electrical specifications

GPS/GLONASS (Connection 2)

Standards	GPS/QZSS/Galileo/GLONASS
Frequency (MHz)	1575.42, 1598-1606
VSWR	<=1.4:1
Impedance (Ohm)	50
Polarisation	RHCP
Active Gain (dB)	28 @ 2.7 V
Voltage (V)	1.5 – 3.6
Current (mA)	9 Typ
Power Consumption (mW)	24.3 Typ

2J4847P 2-in-1 antenna 4G LTE/3G/2G | 2.4/5.0 GHz ISM

Key Features

- ✔ Ground Plane Independent
- ✔ Customizable Cable and Connector



Antenna and electrical specifications

4G LTE/3G/2G (Connection 1)

Standards	2G,3G and 4G
Frequency (MHz)	698-960, 1710-2170, 2500-2700
VSWR	~1.9:1, ~1.4:1, ~1.8:1
Peak Gain (dBi)	~2.0, ~1.0, ~-0.6
Impedance (Ohm)	50
Polarisation	Linear
Max. Input Power (W)	25

General specification

Mounting type	Adhesive mount
Dimensions (mm)	83 x 35 x 13.3
Operating temperature	-40 °C to +85 °C
Note	Optional Antenna Detection Resistor

Antenna and electrical specifications

2.4/5.0 GHz ISM (Connection 2)

Standards	WiFi, BT, ZigBee, ISM
Frequency (MHz)	2410-2490, 4920-5925
VSWR	~1.2:1, ~1.3:1
Peak Gain (dBi)	~2.5, ~0.5
Impedance (Ohm)	50
Polarisation	Linear
Max. Input Power (W)	25

2J4941PGF 2-in-1 antenna 4G LTE/3G/2G | GPS/GLONASS

Key Features

- ✔ High Performance
- ✔ Ground Plane Independent
- ✔ Customizable Cable and Connector



Standard colors
Other colors upon request



General specification

Mounting type	Adhesive mount
Dimensions (mm)	150.5 x 42 x 15.3
Operating temperature	-40 °C to +85 °C
Note	Optional Antenna Detection Resistor

Antenna and electrical specifications

4G LTE/3G/2G (Connection 1)	
Standards	2G,3G and 4G
Frequency (MHz)	698-960, 1710-2170, 2500-2700
VSWR	~1.7:1, ~1.4:1, ~1.5:1
Peak Gain (dBi)	~3.4, ~3.5, ~3.9
Impedance (Ohm)	50
Polarisation	Linear
Max. Input Power (W)	25

Antenna and electrical specifications

GPS/GLONASS (Connection 2)	
Standards	GPS/QZSS/Galileo/GLONASS
Frequency (MHz)	1575.42, 1598-1606
VSWR	<=1.4:1
Impedance (Ohm)	50
Polarisation	RHCP
Active Gain (dB)	28 @ 2.7 V
Voltage (V)	1.5 – 3.6
Current (mA)	9 Typ
Power Consumption (mW)	24.3 Typ

2J6024Pa 2-in-1 antenna 2 x 4G LTE/3G/2G MIMO

Key Features

- ✔ Ground Plane Independent
- ✔ Customizable Cable and Connector
- ✔ Certificates: IP67 - Water resistant



Standard colors
Other colors upon request

General specification

Mounting type	Adhesive mount
Dimensions (mm)	80 x 76 x 13
Operating temperature	-40 °C to +85 °C
Certificates	IP67

Antenna and electrical specifications

4G LTE/3G/2G (Connection 1)	
Standards	2G,3G and 4G
Frequency (MHz)	698-960, 1710-2170, 2500-2700
VSWR	~2.2:1, ~1.2:1, ~2.2:1
Peak Gain (dBi)	~2.9, ~3.2, ~2.1
Impedance (Ohm)	50
Polarisation	Linear
Max. Input Power (W)	25

Antenna and electrical specifications

4G LTE/3G/2G (Connection 2)	
Standards	2G,3G and 4G
Frequency (MHz)	698-960, 1710-2170, 2500-2700
VSWR	~2.3:1, ~1.2:1, ~2.0:1
Peak Gain (dBi)	~2.7, ~3.5, ~2.2
Impedance (Ohm)	50
Polarisation	Linear
Max. Input Power (W)	25

2J4800PGF 2-in-1 antenna

3G/2G | GPS/GLONASS

Key Features

- ✔ Pre-Filter
- ✔ Ground Plane Independent
- ✔ Customizable Cable and Connector



Antenna and electrical specifications

3G/2G (Connection 1)

Standards	2G and 3G
Frequency (MHz)	824-960, 1710-2170
VSWR	~1.4:1, ~1.3:1
Peak Gain (dBi)	~3.0, ~1.3
Impedance (Ohm)	50
Polarisation	Linear
Max. Input Power (W)	25

General specification

Mounting type	Adhesive mount
Dimensions (mm)	83 x 35 x 13.3
Operating temperature	-40 °C to +85 °C
Note	Optional Antenna Detection Resistor

Antenna and electrical specifications

GPS/GLONASS (Connection 2)

Standards	GPS/QZSS/Galileo/GLONASS
Frequency (MHz)	1575.42, 1598-1606
VSWR	<=1.4:1
Impedance (Ohm)	50
Polarisation	RHCP
Active Gain (dB)	28 @ 2.7 V
Voltage (V)	1.5 – 3.6
Current (mA)	9 Typ
Power Consumption (mW)	24.3 Typ

2J4805P 2-in-1 antenna

3G/2G | 2.4/5.0 GHz ISM

Key Features

- ✔ Ground Plane Independent
- ✔ Customizable Cable and Connector

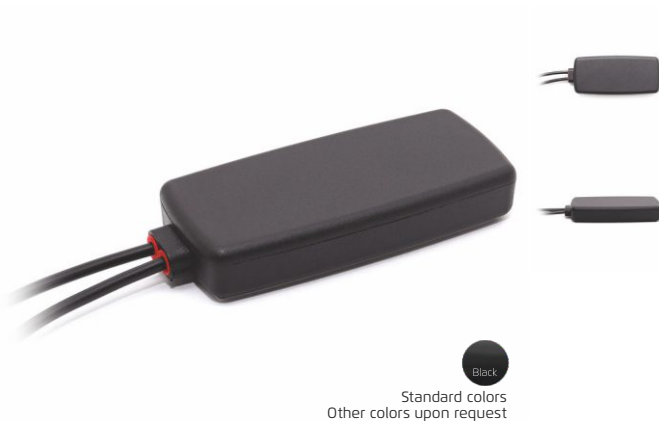

Antenna and electrical specifications

3G/2G (Connection 1)

Standards	2G and 3G
Frequency (MHz)	824-960, 1710-2170
VSWR	~1.4:1, ~1.4:1
Peak Gain (dBi)	~2.1, ~1.1
Impedance (Ohm)	50
Polarisation	Linear
Max. Input Power (W)	25

General specification

Mounting type	Adhesive mount
Dimensions (mm)	83 x 35 x 13.3
Operating temperature	-40 °C to +85 °C
Note	Optional Antenna Detection Resistor

Antenna and electrical specifications

2.4/5.0 GHz ISM (Connection 2)

Standards	WiFi, BT, ZigBee, ISM
Frequency (MHz)	2410-2490, 4920-5925
VSWR	~1.2:1, ~1.3:1
Peak Gain (dBi)	~2.5, ~0.5
Impedance (Ohm)	50
Polarisation	Linear
Max. Input Power (W)	25

2J620PF

2-in-1 antenna

3G/2G | GPS

Key Features

- ✔ Non-Metal Surfaces Installation
- ✔ Ground Plane Independent
- ✔ Pre-Filter GPS
- ✔ Customizable Cable and Connector



Standard colors
Other colors upon request

General specification

Mounting type	Adhesive mount
Dimensions (mm)	Ø 77 x 12
Operating temperature	-40 °C to +85 °C

Antenna and electrical specifications

3G/2G (Connection 1)

Standards	2G and 3G
Frequency (MHz)	824-960, 1710-2170
VSWR	~1.6:1, ~2.4:1
Peak Gain (dBi)	~1.5, ~0.5
Impedance (Ohm)	50
Polarisation	Linear
Max. Input Power (W)	25

Antenna and electrical specifications

GPS (Connection 2)

Standards	GPS/QZSS/Galileo
Frequency (MHz)	1575.42
VSWR	<=1.5:1
Impedance (Ohm)	50
Polarisation	RHCP
Active Gain (dB)	26 @ 3 V
Voltage (V)	2.7 - 5.5
Current (mA)	15 - 25
Power Consumption (mW)	40 - 137
Saw Filter Type	Pre-Filter

2J4A41PCFa 3-in-1 antenna 2 x 4G LTE/3G/2G MIMO | GPS/GLONASS

Key Features

- ✔ High Performance
- ✔ Ground Plane Independent
- ✔ Customizable Cable and Connector
- ✔ Certificates: **IP67** - Water resistant, **IP69** - Hot water pressure



General specification

Mounting type	Adhesive mount
Dimensions (mm)	58.7 x 157.6 x 14.4
Operating temperature	-40 °C to +85 °C
Certificates	IP67, IP69

Antenna and electrical specifications

4G LTE/3G/2G (Connection 1)

Standards	2G,3G and 4G
Frequency (MHz)	698-960, 1710-2170, 2500-2700
VSWR	~2.1:1, ~1.6:1, ~2.0:1
Peak Gain (dBi)	~1.9, ~3.3, ~2.2
Impedance (Ohm)	50
Polarisation	Linear
Max. Input Power (W)	25

Antenna and electrical specifications

4G LTE/3G/2G (Connection 2)

Standards	2G,3G and 4G
Frequency (MHz)	698-960, 1710-2170, 2500-2700
VSWR	~2.1:1, ~1.7:1, ~1.8:1
Peak Gain (dBi)	~2.0, ~2.7, ~1.6
Impedance (Ohm)	50
Polarisation	Linear
Max. Input Power (W)	25

Antenna and electrical specifications

GPS/GLONASS (Connection 3)

Standards	GPS/QZSS/Galileo/GLONASS
Frequency (MHz)	1575.42, 1598-1606
VSWR	<=1.4:1
Impedance (Ohm)	50
Polarisation	RHCP
Active Gain (dB)	28 @ 2.7 V
Voltage (V)	1.5 – 3.6
Current (mA)	9 Typ
Power Consumption (mW)	24.3 Typ

2J4950PGF 3-in-1 antenna 4G LTE/3G/2G | 2.4/5.0 GHz ISM | GPS/GLONASS

Key Features

- ✔ High Performance
- ✔ Ground Plane Independent
- ✔ Customizable Cable and Connector
- ✔ Certificates: **IP67** - Water resistant, **IP69** - Hot water pressure

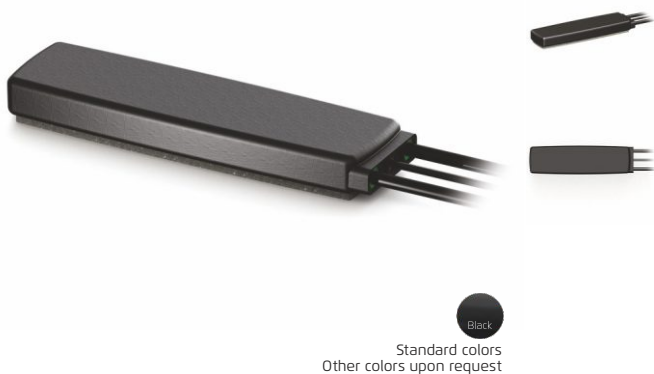

General specification

Mounting type	Adhesive mount
Dimensions (mm)	145.5 x 41.8 x 15.2
Operating temperature	-40 °C to +85 °C
Certificates	IP67, IP69

Antenna and electrical specifications

4G LTE/3G/2G (Connection 1)

Standards	2G,3G and 4G
Frequency (MHz)	698-960, 1710-2170, 2500-2700
VSWR	~1.6:1, ~1.3:1, ~1.5:1
Peak Gain (dBi)	~5.1, ~5.0, ~4.2
Impedance (Ohm)	50
Polarisation	Linear
Max. Input Power (W)	25

Antenna and electrical specifications

2.4/5.0 GHz ISM (Connection 2)

Standards	WiFi, BT, ZigBee, ISM
Frequency (MHz)	2410-2490, 4920-5925
VSWR	~1.3:1, ~1.6:1
Peak Gain (dBi)	~5.8, ~8.3
Impedance (Ohm)	50
Polarisation	Linear
Max. Input Power (W)	25

Antenna and electrical specifications

GPS/GLONASS (Connection 3)

Standards	GPS/QZSS/Galileo/GLONASS
Frequency (MHz)	1575.42, 1598-1606
VSWR	<=1.4:1
Impedance (Ohm)	50
Polarisation	RHCP
Active Gain (dB)	28 @ 2.7 V
Voltage (V)	1.5 – 3.6
Current (mA)	9 Typ
Power Consumption (mW)	24.3 Typ

2J6041PGFa 3-in-1 antenna 2 x 4G LTE/3G/2G MIMO | GPS/GLONASS

Key Features

- ✔ Ground Plane Independent ✔ Customizable Cable and Connector
- ✔ Certificates: **IP67** - Water resistant

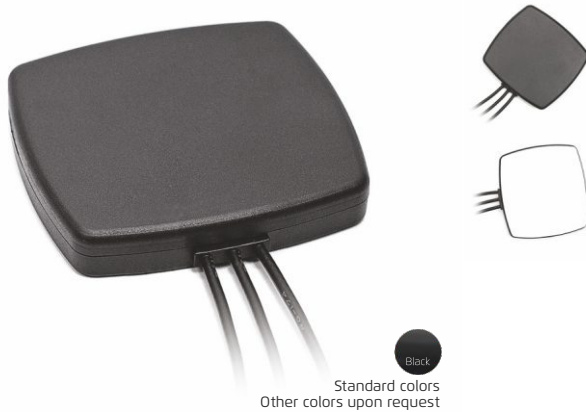

General specification

Mounting type	Adhesive mount
Dimensions (mm)	80 x 76 x 13
Operating temperature	-40 °C to +85 °C
Certificates	IP67

Antenna and electrical specifications

4G LTE/3G/2G (Connection 1)

Standards	2G,3G and 4G
Frequency (MHz)	698-960, 1710-2170, 2500-2700
VSWR	~2.2:1, ~1.2:1, ~2.2:1
Peak Gain (dBi)	~2.9, ~3.2, ~2.1
Impedance (Ohm)	50
Polarisation	Linear
Max. Input Power (W)	25

Antenna and electrical specifications

4G LTE/3G/2G (Connection 2)

Standards	2G,3G and 4G
Frequency (MHz)	698-960, 1710-2170, 2500-2700
VSWR	~2.3:1, ~1.2:1, ~2.0:1
Peak Gain (dBi)	~2.7, ~3.5, ~2.2
Impedance (Ohm)	50
Polarisation	Linear
Max. Input Power (W)	25

Antenna and electrical specifications

GPS/GLONASS (Connection 3)

Standards	GPS/QZSS/Galileo/GLONASS
Frequency (MHz)	1575.42, 1598-1606
VSWR	<=1.4:1
Impedance (Ohm)	50
Polarisation	RHCP
Active Gain (dB)	28 @ 2.7 V
Voltage (V)	1.5 – 3.6
Current (mA)	9 Typ
Power Consumption (mW)	24.3 Typ

2J6050PGF 3-in-1 antenna 4G LTE/3G/2G | 2.4/5.0 GHz ISM | GPS/GLONASS

Key Features

- ✔ Ground Plane Independent ✔ Customizable Cable and Connector
- ✔ Certificates: **IP67** - Water resistant

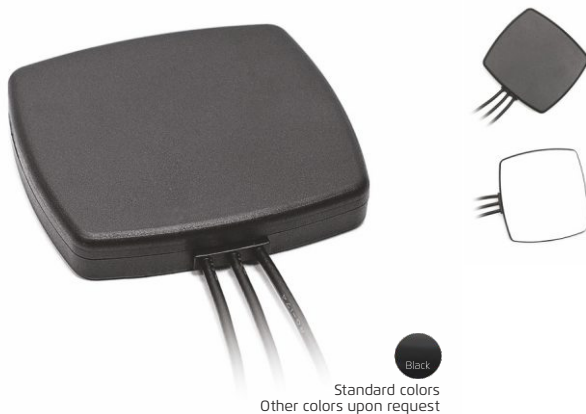

General specification

Mounting type	Adhesive mount
Dimensions (mm)	80 x 76 x 13
Operating temperature	-40 °C to +85 °C
Certificates	IP67

Antenna and electrical specifications

4G LTE/3G/2G (Connection 1)

Standards	2G,3G and 4G
Frequency (MHz)	698-960, 1710-2170, 2500-2700
VSWR	~2.2:1, ~1.2:1, ~2.2:1
Peak Gain (dBi)	~2.9, ~3.2, ~2.1
Impedance (Ohm)	50
Polarisation	Linear
Max. Input Power (W)	25

Antenna and electrical specifications

2.4/5.0 GHz ISM (Connection 2)

Standards	WiFi, BT, ZigBee, ISM
Frequency (MHz)	2410-2490, 4920-5925
VSWR	~1.3:1, ~1.3:1
Peak Gain (dBi)	~3.2, ~4.2
Impedance (Ohm)	50
Polarisation	Linear
Max. Input Power (W)	25

Antenna and electrical specifications

GPS/GLONASS (Connection 3)

Standards	GPS/QZSS/Galileo/GLONASS
Frequency (MHz)	1575.42, 1598-1606
VSWR	<=1.4:1
Impedance (Ohm)	50
Polarisation	RHCP
Active Gain (dB)	28 @ 2.7 V
Voltage (V)	1.5 – 3.6
Current (mA)	9 Typ
Power Consumption (mW)	24.3 Typ

2J4A50PCFc 4-in-1 antenna

2 x 4G LTE/3G/2G MIMO | 2.4/5.0 GHz ISM | GPS/GLONASS

Key Features

- ✔ High Performance
- ✔ Ground Plane Independent
- ✔ Customizable Cable and Connector
- ✔ Certificates: **IP67** - Water resistant, **IP69** - Hot water pressure



General specification

Mounting type	Adhesive mount
Dimensions (mm)	58.7 x 157.6 x 14.4
Operating temperature	-40 °C to +85 °C
Certificates	IP67, IP69

Antenna and electrical specifications

4G LTE/3G/2G (Connection 1)

Standards	2G,3G and 4G
Frequency (MHz)	698-960, 1710-2170, 2500-2700
VSWR	~2.1:1, ~1.6:1, ~2.0:1
Peak Gain (dBi)	~1.9, ~3.3, ~2.2
Impedance (Ohm)	50
Polarisation	Linear
Max. Input Power (W)	25

Antenna and electrical specifications

4G LTE/3G/2G (Connection 2)

Standards	2G,3G and 4G
Frequency (MHz)	698-960, 1710-2170, 2500-2700
VSWR	~2.1:1, ~1.7:1, ~1.8:1
Peak Gain (dBi)	~2.0, ~2.7, ~1.6
Impedance (Ohm)	50
Polarisation	Linear
Max. Input Power (W)	25

Antenna and electrical specifications

2.4/5.0 GHz ISM (Connection 3)

Standards	WiFi, BT, ZigBee, ISM
Frequency (MHz)	2410-2490, 4920-5925
VSWR	~1.3:1, ~1.6:1
Peak Gain (dBi)	~3.9, ~4.0
Impedance (Ohm)	50
Polarisation	Linear
Max. Input Power (W)	25

Antenna and electrical specifications

GPS/GLONASS (Connection 4)

Standards	GPS/QZSS/Galileo/GLONASS
Frequency (MHz)	1575.42, 1598-1606
VSWR	<=1.4:1
Impedance (Ohm)	50
Polarisation	RHCP
Active Gain (dB)	28 @ 2.7 V
Voltage (V)	1.5 – 3.6
Current (mA)	9 Typ
Power Consumption (mW)	24.3 Typ

2J4A50PCFa 5-in-1 antenna

2 × 4G LTE/3G/2G MIMO | 2 × 2.4/5.0 GHz ISM MIMO | GPS/GLONASS

Key Features

- ✔ High Performance
- ✔ Ground Plane Independent
- ✔ Customizable Cable and Connector
- ✔ Certificates: **IP67** - Water resistant, **IP69** - Hot water pressure



General specification

Mounting type	Adhesive mount
Dimensions (mm)	58.7 x 157.6 x 14.4
Operating temperature	-40 °C to +85 °C
Certificates	IP67, IP69

Antenna and electrical specifications

4G LTE/3G/2G (Connection 1)

Standards	2G,3G and 4G
Frequency (MHz)	698-960, 1710-2170, 2500-2700
VSWR	~2.1:1, ~1.6:1, ~2.0:1
Peak Gain (dBi)	~1.9, ~3.3, ~2.2
Impedance (Ohm)	50
Polarisation	Linear
Max. Input Power (W)	25

Antenna and electrical specifications

4G LTE/3G/2G (Connection 2)

Standards	2G,3G and 4G
Frequency (MHz)	698-960, 1710-2170, 2500-2700
VSWR	~2.1:1, ~1.7:1, ~1.8:1
Peak Gain (dBi)	~2.0, ~2.7, ~1.6
Impedance (Ohm)	50
Polarisation	Linear
Max. Input Power (W)	25

Antenna and electrical specifications

2.4/5.0 GHz ISM (Connection 3)

Standards	WiFi, BT, ZigBee, ISM
Frequency (MHz)	2410-2490, 4920-5925
VSWR	~1.3:1, ~1.6:1
Peak Gain (dBi)	~3.9, ~4.0
Impedance (Ohm)	50
Polarisation	Linear
Max. Input Power (W)	25

Antenna and electrical specifications

2.4/5.0 GHz ISM (Connection 4)

Standards	WiFi, BT, ZigBee, ISM
Frequency (MHz)	2410-2490, 4920-5925
VSWR	~1.3:1, ~1.6:1
Peak Gain (dBi)	~4.5, ~3.9
Impedance (Ohm)	50
Polarisation	Linear
Max. Input Power (W)	25

Antenna and electrical specifications

GPS/GLONASS (Connection 5)

Standards	GPS/QZSS/Galileo/GLONASS
Frequency (MHz)	1575.42, 1598-1606
VSWR	<=1.4:1
Impedance (Ohm)	50
Polarisation	RHCP
Active Gain (dB)	28 @ 2.7 V
Voltage (V)	1.5 – 3.6
Current (mA)	9 Typ
Power Consumption (mW)	24.3 Typ

2J6A02Ba 2-in-1 antenna

2 x 2.4/5.0 GHz ISM MIMO

Key Features

- ✔ surge protection up to 6kV
- ✔ Ground Plane Independent
- ✔ Customizable Cable and Connector
- ✔ Certificates: **IP67** - Water resistant, **IP69** - Hot water pressure, **IK09** - Impact resistant



General specification

Mounting type	Screw mount
Dimensions (mm)	Ø 77.3 x 65.5
Operating temperature	-40 °C to +85 °C
Certificates	IP67, IP69, IK09

Antenna and electrical specifications

2.4/5.0 GHz ISM (Connection 1)

Standards	WiFi, BT, ZigBee, ISM
Frequency (MHz)	2410-2490, 4920-5925
VSWR	~1.8:1, ~1.8:1
Peak Gain (dBi)	~2.6, ~4.4
Impedance (Ohm)	50
Polarisation	Linear
Max. Input Power (W)	25

Antenna and electrical specifications

2.4/5.0 GHz ISM (Connection 2)

Standards	WiFi, BT, ZigBee, ISM
Frequency (MHz)	2410-2490, 4920-5925
VSWR	~2.1:1, ~1.9:1
Peak Gain (dBi)	~2.4, ~4.4
Impedance (Ohm)	50
Polarisation	Linear
Max. Input Power (W)	25

2J6A24Ba 2-in-1 antenna

2 x 4G LTE/3G/2G MIMO

Key Features

- ✔ Ground Plane Dependent
- ✔ Customizable Cable and Connector
- ✔ Certificates: **IP67** - Water resistant, **IP69** - Hot water pressure, **IK09** - Impact resistant



General specification

Mounting type	Screw mount
Dimensions (mm)	Ø 77.3 x 65.5
Operating temperature	-40 °C to +85 °C
Certificates	IP67, IP69, IK09

Antenna and electrical specifications

4G LTE/3G/2G (Connection 1)

Standards	2G,3G and 4G
Frequency (MHz)	698-960, 1710-2170, 2500-2700
VSWR	~2.8:1, ~1.7:1, ~1.3:1
Peak Gain (dBi)	~-0.8, ~2.5, ~3.4
Impedance (Ohm)	50
Polarisation	Linear
Max. Input Power (W)	25

Antenna and electrical specifications

4G LTE/3G/2G (Connection 2)

Standards	2G,3G and 4G
Frequency (MHz)	698-960, 1710-2170, 2500-2700
VSWR	~2.8:1, ~1.7:1, ~1.3:1
Peak Gain (dBi)	~-0.8, ~2.5, ~3.4
Impedance (Ohm)	50
Polarisation	Linear
Max. Input Power (W)	25

2J6A41BGF 2-in-1 antenna 4G LTE/3G/2G | GPS/GLONASS

Key Features

- ✓ Ground Plane Dependent
- ✓ Customizable Cable and Connector
- ✓ Certificates: **IP67** - Water resistant, **IP69** - Hot water pressure, **IK09** - Impact resistant



Antenna and electrical specifications

4G LTE/3G/2G (Connection 1)

Standards	2G,3G and 4G
Frequency (MHz)	698-960, 1710-2170, 2500-2700
VSWR	~2.2:1, ~1.5:1, ~1.6:1
Peak Gain (dBi)	~2, ~4, ~3.5
Impedance (Ohm)	50
Polarisation	Linear
Max. Input Power (W)	25

General specification

Mounting type	Screw mount
Dimensions (mm)	Ø 77.3 x 65.5
Operating temperature	-40 °C to +85 °C
Certificates	IP67, IP69, IK09

Antenna and electrical specifications

GPS/GLONASS (Connection 2)

Standards	GPS/QZSS/Galileo/GLONASS
Frequency (MHz)	1575.42, 1598-1610
VSWR	<=1.5:1
Impedance (Ohm)	50
Polarisation	RHCP
Active Gain (dB)	23 @ 3 V
Voltage (V)	2.7 – 5.5
Current (mA)	15 - 25
Power Consumption (mW)	40 - 137

2J6A41BCF 2-in-1 antenna 4G LTE/3G/2G | GPS/GLONASS/BeiDou

Key Features

- ✓ Ground Plane Dependent
- ✓ Customizable Cable and Connector
- ✓ Certificates: **IP67** - Water resistant, **IP69** - Hot water pressure, **IK09** - Impact resistant



Antenna and electrical specifications

4G LTE/3G/2G (Connection 1)

Standards	2G,3G and 4G
Frequency (MHz)	698-960, 1710-2170, 2500-2700
VSWR	~2.1:1, ~1.5:1, ~1.5:1
Peak Gain (dBi)	~0.7, ~3.4, ~4.0
Impedance (Ohm)	50
Polarisation	Linear
Max. Input Power (W)	25

General specification

Mounting type	Screw mount
Dimensions (mm)	Ø 77.3 x 65.5
Operating temperature	-40 °C to +85 °C
Certificates	IP67, IP69, IK09

Antenna and electrical specifications

GPS/GLONASS/BeiDou (Connection 2)

Standards	BeiDou/GPS/QZSS/Galileo/GLONASS
Frequency (MHz)	1561.098, 1575.42, 1598-1610
VSWR	<=1.4:1
Impedance (Ohm)	50
Polarisation	RHCP
Active Gain (dB)	28 @ 2.7 V
Voltage (V)	1.5 – 3.6
Current (mA)	9 Typ
Power Consumption (mW)	24.3 Typ

2J6A47B 2-in-1 antenna 4G LTE/3G/2G | 2.4/5.0 GHz ISM

Key Features

- ✔ Ground Plane Dependent
- ✔ Customizable Cable and Connector
- ✔ Certificates: **IP67** - Water resistant, **IP69** - Hot water pressure, **IK09** - Impact resistant



Antenna and electrical specifications

4G LTE/3G/2G (Connection 1)

Standards	2G,3G and 4G
Frequency (MHz)	698-960, 1710-2170, 2500-2700
VSWR	~2.1:1, ~1.5:1, ~1.5:1
Peak Gain (dBi)	~0.7, ~3.4, ~4.0
Impedance (Ohm)	50
Polarisation	Linear
Max. Input Power (W)	25

General specification

Mounting type	Screw mount
Dimensions (mm)	Ø 77.3 x 65.5
Operating temperature	-40 °C to +85 °C
Certificates	IP67, IP69, IK09

Antenna and electrical specifications

2.4/5.0 GHz ISM (Connection 2)

Standards	WiFi, BT, ZigBee, ISM
Frequency (MHz)	2410-2490, 4920-5925
VSWR	~1.2:1, ~1.8:1
Peak Gain (dBi)	~5.0, ~3.9
Impedance (Ohm)	50
Polarisation	Linear
Max. Input Power (W)	25

2J6500BGF 2-in-1 antenna 3G/2G | GPS/GLONASS

Key Features

- ✔ Heavy Duty antenna
- ✔ Ground Plane Dependent
- ✔ Customizable Cable and Connector
- ✔ Certificates: **IP67** - Water resistant, **IP69** - Hot water pressure, **IK09** - Impact resistant



Antenna and electrical specifications

3G/2G (Connection 1)

Standards	2G and 3G
Frequency (MHz)	824-960, 1710-2170
VSWR	~2.1:1, ~1.7:1
Peak Gain (dBi)	~1.8, ~2.3
Impedance (Ohm)	50
Polarisation	Linear
Max. Input Power (W)	25

General specification

Mounting type	Screw mount
Dimensions (mm)	Ø 146 x 31.5
Operating temperature	-40 °C to +85 °C
Certificates	IP67, IP69, IK09

Antenna and electrical specifications

GPS/GLONASS (Connection 2)

Standards	GPS/QZSS/Galileo/GLONASS
Frequency (MHz)	1575.42, 1598-1610
Impedance (Ohm)	50
Active Gain (dB)	28 @ 2.7 V
Voltage (V)	1.5 - 3.6
Current (mA)	9 @ 2.7 V
Power Consumption (mW)	24.3 @ 2.7V

2J6507BGF 2-in-1 antenna 433 MHz ISM | GPS/GLONASS

Key Features

- ✓ Heavy Duty antenna
- ✓ Ground Plane Dependent
- ✓ Customizable Cable and Connector
- ✓ Certificates: **IP67** - Water resistant, **IP69** - Hot water pressure, **IK09** - Impact resistant



General specification

Mounting type	Screw mount
Dimensions (mm)	Ø 146 x 31.5
Operating temperature	-40 °C to +85 °C
Certificates	IP67, IP69, IK09

Antenna and electrical specifications

433 MHz ISM (Connection 1)

Standards	ISM, LoRa
Frequency (MHz)	433-435
VSWR	~1.3:1
Peak Gain (dBi)	~2.9
Impedance (Ohm)	50
Polarisation	Linear
Max. Input Power (W)	50

Antenna and electrical specifications

GPS/GLONASS (Connection 2)

Standards	GPS/QZSS/Galileo/GLONASS
Frequency (MHz)	1575.42, 1598-1610
Impedance (Ohm)	50
Active Gain (dB)	28 @ 2.7 V
Voltage (V)	1.5 - 3.6
Current (mA)	9 @ 2.7 V
Power Consumption (mW)	24.3 @ 2.7V

2J663B 2-in-1 antenna 2.4/5.0 GHz ISM | GPS

Key Features

- ✓ Ground Plane Independent
- ✓ Customizable Cable and Connector
- ✓ Certificates: **IP67** - Water resistant, **IP69** - Hot water pressure



General specification

Mounting type	Screw mount
Dimensions (mm)	Ø 77.4 x 15.9
Operating temperature	-40 °C to +85 °C
Certificates	IP67, IP69

Antenna and electrical specifications

2.4/5.0 GHz ISM (Connection 1)

Standards	WiFi, BT, ZigBee, ISM
Frequency (MHz)	2410-2490, 4920-5925
VSWR	~1.2:1, ~1.4:1
Peak Gain (dBi)	~4.3, ~1.8
Impedance (Ohm)	50
Polarisation	Linear
Max. Input Power (W)	25

Antenna and electrical specifications

GPS (Connection 2)

Standards	GPS/QZSS/Galileo
Frequency (MHz)	1575.42
VSWR	<=1.2:1
Impedance (Ohm)	50
Polarisation	RHCP
Active Gain (dB)	26 @ 3 V
Voltage (V)	3 - 5
Current (mA)	15 - 25
Power Consumption (mW)	45 - 125

2J673B 2-in-1 antenna

2.4/5.0 GHz ISM | GPS

Key Features

- ✔ Ground Plane Independent
- ✔ Customizable Cable and Connector
- ✔ Certificates: **IP67** - Water resistant, **IP69** - Hot water pressure, **IK09** and **IK10** version possible



Standard colors
Other colors upon request

General specification

Mounting type	Screw mount
Dimensions (mm)	Ø 77.3 x 37.8
Operating temperature	-40 °C to +85 °C
Certificates	IP67, IP69K, IK09 and IK10 version possible

Antenna and electrical specifications

2.4/5.0 GHz ISM (Connection 1)

Standards	WiFi, BT, ZigBee, ISM
Frequency (MHz)	2410-2490, 4920-5925
VSWR	~1.2:1, ~1.4:1
Peak Gain (dBi)	~4.3, ~1.8
Impedance (Ohm)	50
Polarisation	Linear
Max. Input Power (W)	25

Antenna and electrical specifications

GPS (Connection 2)

Standards	GPS/QZSS/Galileo
Frequency (MHz)	1575.42
VSWR	<=1.2:1
Impedance (Ohm)	50
Polarisation	RHCP
Active Gain (dB)	26 @ 3 V
Voltage (V)	3 - 5
Current (mA)	15 - 25
Power Consumption (mW)	45 - 125

2J7024Ba 2-in-1 antenna

2 x 4G LTE/3G/2G MIMO

Key Features

- ✔ Heavy Duty antenna
- ✔ High Performance
- ✔ Customizable Cable and Connector
- ✔ Certificates: **IP67** - Water resistant, **IP69** - Hot water pressure, **IK09** - Impact resistant



Standard colors
Other colors upon request

General specification

Mounting type	Screw mount
Dimensions (mm)	Ø 96 x H 90
Operating temperature	-40 °C to +85 °C
Certificates	IP67, IP69, IK09

Antenna and electrical specifications

4G LTE/3G/2G (Connection 1)

Standards	2G,3G and 4G
Frequency (MHz)	698-960, 1710-2170, 2500-2700
VSWR	~1.9:1, ~1.6:1, ~1.7:1
Peak Gain (dBi)	~2.1, ~4.2, ~3.1
Impedance (Ohm)	50
Polarisation	Linear
Max. Input Power (W)	25

Antenna and electrical specifications

4G LTE/3G/2G (Connection 2)

Standards	2G,3G and 4G
Frequency (MHz)	698-960, 1710-2170, 2500-2700
VSWR	~1.9:1, ~1.6:1, ~1.4:1
Peak Gain (dBi)	~3.0, ~3.2, ~4.0
Impedance (Ohm)	50
Polarisation	Linear
Max. Input Power (W)	25

2J7507B

2-in-1 antenna

GPS | 433 MHz ISM

Key Features

- ✓ Ground Plane Dependent
- ✓ Customizable Cable and Connector
- ✓ Certificates: **IP67** - Water resistant, **IP69** - Hot water pressure



Black

Standard colors
Other colors upon request

General specification

Mounting type	Screw mount
Dimensions (mm)	Ø 63 × 186.5
Operating temperature	-40 °C to +85 °C
Certificates	IP67, IP69

Antenna and electrical specifications

GPS (Connection 1)

Standards	GPS/QZSS/Galileo
Frequency (MHz)	1575.42
VSWR	<=1.5:1
Impedance (Ohm)	50
Polarisation	RHCP
Active Gain (dB)	23 @ 3 V
Voltage (V)	2.7 – 5.5
Current (mA)	15 - 25
Power Consumption (mW)	40.5 – 137.5

Antenna and electrical specifications

433 MHz ISM (Connection 2)

Standards	ISM, LoRa
Frequency (MHz)	433-435
VSWR	~1.7:1
Peak Gain (dBi)	~-0.4
Impedance (Ohm)	50
Polarisation	Linear
Max. Input Power (W)	50

2J7539B

2-in-1 antenna

GPS/GLONASS | 915 MHz ISM

Key Features

- ✓ High Performance
- ✓ Ground Plane Dependent
- ✓ Customizable Cable and Connector
- ✓ Certificates: **IP67** - Water resistant



Black

Standard colors
Other colors upon request

General specification

Mounting type	Screw mount
Dimensions (mm)	Ø 60 × 97
Operating temperature	-40 °C to +85 °C
Certificates	IP67

Antenna and electrical specifications

GPS/GLONASS (Connection 1)

Standards	GPS/QZSS/Galileo/GLONASS
Frequency (MHz)	1575.42, 1598-1610
VSWR	<=1.2:1
Impedance (Ohm)	50
Polarisation	RHCP
Active Gain (dB)	26 @ 3V / 27dB @ 5V
Voltage (V)	2.7 – 5.5
Current (mA)	15 - 25
Power Consumption (mW)	40 - 137

Antenna and electrical specifications

915 MHz ISM (Connection 2)

Standards	ZigBee, ISM, SIGFOX, LoRa
Frequency (MHz)	902-928
VSWR	~1.1:1
Peak Gain (dBi)	~1.9
Impedance (Ohm)	50
Polarisation	Linear
Max. Input Power (W)	25

2J7641BCF 2-in-1 antenna 4G LTE/3G/2G | GPS/GLONASS/BeiDou

Key Features

- ✔ Ground Plane Dependent
- ✔ Customizable Cable and Connector
- ✔ Certificates: **IP67** - Water resistant, **IP69** - Hot water pressure, **IK09** - Impact resistant



Antenna and electrical specifications

4G LTE/3G/2G (Connection 1)	
Standards	2G,3G and 4G
Frequency (MHz)	698-960, 1710-2170, 2500-2700
VSWR	~2.1:1, ~1.8:1, ~2.5:1
Peak Gain (dBi)	~2.6, ~3.2, ~1.4
Impedance (Ohm)	50
Polarisation	Linear
Max. Input Power (W)	25

General specification

Mounting type	Screw mount
Dimensions (mm)	Ø 77.3 x 65.5
Operating temperature	-40 °C to +85 °C
Certificates	IP67, IP69, IK09

Antenna and electrical specifications

GPS/GLONASS/BeiDou (Connection 2)	
Standards	BeiDou/GPS/QZSS/Galileo/GLONASS
Frequency (MHz)	1561.098, 1575.42, 1598-1610
VSWR	<=1.4:1
Impedance (Ohm)	50
Polarisation	RHCP
Active Gain (dB)	28 @ 2.7 V
Voltage (V)	1.5 – 3.6
Current (mA)	9 Typ
Power Consumption (mW)	24.3 Typ

2J7741BGF 2-in-1 antenna 4G LTE/3G/2G | GPS/GLONASS

Key Features

- ✔ Ground Plane Dependent
- ✔ High Performance
- ✔ Customizable Cable and Connector
- ✔ Certificates: **IP67** - Water resistant, **IP69** - Hot water pressure



Antenna and electrical specifications

4G LTE/3G/2G (Connection 1)	
Standards	2G,3G and 4G
Frequency (MHz)	698-960, 1710-2170, 2500-2700
VSWR	~1.9:1, ~1.2:1, ~1.4:1
Peak Gain (dBi)	~1.9, ~4.3, ~4.2
Impedance (Ohm)	50
Polarisation	Linear
Max. Input Power (W)	25

General specification

Mounting type	Screw mount
Dimensions (mm)	Ø 54.5 x 67.1
Operating temperature	-40 °C to +85 °C
Certificates	IP67, IP69

Antenna and electrical specifications

GPS/GLONASS (Connection 2)	
Standards	GPS/QZSS/Galileo/GLONASS
Frequency (MHz)	1575.42, 1598-1610
VSWR	<=1.4:1
Impedance (Ohm)	50
Polarisation	RHCP
Active Gain (dB)	28 @ 2.7 V
Voltage (V)	1.5 – 3.6
Current (mA)	9 Typ
Power Consumption (mW)	24.3 Typ

2J7724Ba 2-in-1 antenna

2 x 4G LTE/3G/2G MIMO

Key Features

- ✔ Ground Plane Dependent
- ✔ High Performance
- ✔ Customizable Cable and Connector
- ✔ Certificates: **IP67** - Water resistant, **IP69** - Hot water pressure



Antenna and electrical specifications

4G LTE/3G/2G (Connection 1)

Standards	2G,3G and 4G
Frequency (MHz)	698-960, 1710-2170, 2500-2700
VSWR	~2.9:1, ~1.4:1, ~1.4:1
Peak Gain (dBi)	~-0.8, ~3.6, ~4.1
Impedance (Ohm)	50
Polarisation	Linear
Max. Input Power (W)	25

General specification

Mounting type	Screw mount
Dimensions (mm)	Ø 54.5 x 67.1
Operating temperature	-40 °C to +85 °C
Certificates	IP67, IP69

Antenna and electrical specifications

4G LTE/3G/2G (Connection 2)

Standards	2G,3G and 4G
Frequency (MHz)	698-960, 1710-2170, 2500-2700
VSWR	~2.8:1, ~1.5:1, ~2.1:1
Peak Gain (dBi)	~-0.6, ~2.9, ~3.0
Impedance (Ohm)	50
Polarisation	Linear
Max. Input Power (W)	25

2J9524a-B01 2-in-1 antenna

2 x 4G LTE/3G/2G MIMO

Key Features

- ✔ High Performance
- ✔ Customizable Cable and Connector
- ✔ Certificates: **IP69** - Hot water pressure



Antenna and electrical specifications

4G LTE/3G/2G (Connection 1)

Standards	2G,3G and 4G
Frequency (MHz)	698-960, 1710-2170, 2500-2700
VSWR	~1.7:1, ~1.3:1, ~1.3:1
Peak Gain (dBi)	~3.5, ~4.6, ~3.9
Impedance (Ohm)	50
Polarisation	Linear
Max. Input Power (W)	25

General specification

Mounting type	Screw mount
Dimensions (mm)	280 x 280 x 150
Operating temperature	-40 °C to +85 °C
Certificates	IP69K for antenna

Antenna and electrical specifications

4G LTE/3G/2G (Connection 2)

Standards	2G,3G and 4G
Frequency (MHz)	698-960, 1710-2170, 2500-2700
VSWR	~1.7:1, ~1.3:1, ~1.2:1
Peak Gain (dBi)	~3.8, ~5.8, ~4.0
Impedance (Ohm)	50
Polarisation	Linear
Max. Input Power (W)	25

2J6A41BCFa 3-in-1 antenna 2 x 4G LTE/3G/2G MIMO | GPS/GLONASS/BeiDou

Key Features

- ✔ Ground Plane Dependent
- ✔ Customizable Cable and Connector
- ✔ Certificates: **IP67** - Water resistant, **IP69** - Hot water pressure, **IK09** - Impact resistant



General specification

Mounting type	Screw mount
Dimensions (mm)	Ø 77.3 x 65.5
Operating temperature	-40 °C to +85 °C
Certificates	IP67, IP69, IK09

Antenna and electrical specifications

4G LTE/3G/2G (Connection 1)

Standards	2G,3G and 4G
Frequency (MHz)	698-960, 1710-2170, 2500-2700
VSWR	~2.8:1, ~1.7:1, ~1.3:1
Peak Gain (dBi)	~-0.8, ~2.5, ~3.4
Impedance (Ohm)	50
Polarisation	Linear
Max. Input Power (W)	25

Antenna and electrical specifications

4G LTE/3G/2G (Connection 2)

Standards	2G,3G and 4G
Frequency (MHz)	698-960, 1710-2170, 2500-2700
VSWR	~2.9:1, ~1.4:1, ~1.8:1
Peak Gain (dBi)	~-1.0, ~1.7, ~3.2
Impedance (Ohm)	50
Polarisation	Linear
Max. Input Power (W)	25

Antenna and electrical specifications

GPS/GLONASS/BeiDou (Connection 3)

Standards	BeiDou/GPS/QZSS/Galileo/GLONASS
Frequency (MHz)	1561.098, 1575.42, 1598-1610
VSWR	<=1.4:1
Impedance (Ohm)	50
Polarisation	RHCP
Active Gain (dB)	28 @ 2.7 V
Voltage (V)	1.5 – 3.6
Current (mA)	9 Typ
Power Consumption (mW)	24.3 Typ

2J6A50BCF 3-in-1 antenna 4G LTE/3G/2G | 2.4/5.0 GHz ISM | GPS/GLONASS/BeiDou

Key Features

- ✔ Ground Plane Dependent
- ✔ Customizable Cable and Connector
- ✔ Certificates: **IP67** - Water resistant, **IP69** - Hot water pressure, **IK09** - Impact resistant



General specification

Mounting type	Screw mount
Dimensions (mm)	Ø 77.3 x 65.5
Operating temperature	-40 °C to +85 °C
Certificates	IP67, IP69, IK09

Antenna and electrical specifications

4G LTE/3G/2G (Connection 1)

Standards	2G,3G and 4G
Frequency (MHz)	698-960, 1710-2170, 2500-2700
VSWR	~2.1:1, ~1.5:1, ~1.5:1
Peak Gain (dBi)	~-0.7, ~3.4, ~4.0
Impedance (Ohm)	50
Polarisation	Linear
Max. Input Power (W)	25

Antenna and electrical specifications

2.4/5.0 GHz ISM (Connection 2)

Standards	WiFi, BT, ZigBee, ISM
Frequency (MHz)	2410-2490, 4920-5925
VSWR	~1.2:1, ~1.8:1
Peak Gain (dBi)	~5.0, ~3.9
Impedance (Ohm)	50
Polarisation	Linear
Max. Input Power (W)	25

Antenna and electrical specifications

GPS/GLONASS/BeiDou (Connection 3)

Standards	BeiDou/GPS/QZSS/Galileo/GLONASS
Frequency (MHz)	1561.098, 1575.42, 1598-1610
VSWR	<=1.4:1
Impedance (Ohm)	50
Polarisation	RHCP
Active Gain (dB)	28 @ 2.7 V
Voltage (V)	1.5 – 3.6
Current (mA)	9 Typ
Power Consumption (mW)	24.3 Typ

2J6506BGF 3-in-1 antenna 3G/2G | 2.4 GHz ISM | GPS/GLONASS

Key Features

- ✓ Heavy Duty antenna
- ✓ Ground Plane Dependent
- ✓ Customizable Cable and Connector
- ✓ Certificates: **IP67** - Water resistant, **IP69** - Hot water pressure, **IK09** - Impact resistant



General specification

Mounting type	Screw mount
Dimensions (mm)	Ø 146 x 31.5
Operating temperature	-40 °C to +85 °C
Certificates	IP67, IP69, IK09

Antenna and electrical specifications

3G/2G (Connection 1)

Standards	2G and 3G
Frequency (MHz)	824-960, 1710-2170
VSWR	~2.1:1, ~1.7:1
Peak Gain (dBi)	~1.8, ~2.3
Impedance (Ohm)	50
Polarisation	Linear
Max. Input Power (W)	25

Antenna and electrical specifications

2.4 GHz ISM (Connection 2)

Standards	WiFi, BT, ZigBee, ISM
Frequency (MHz)	2410-2490
VSWR	~1.4:1
Peak Gain (dBi)	~2.5
Impedance (Ohm)	50
Polarisation	Linear
Max. Input Power (W)	10

Antenna and electrical specifications

GPS/GLONASS (Connection 3)

Standards	GPS/QZSS/Galileo/GLONASS
Frequency (MHz)	1575.42, 1598-1610
Impedance (Ohm)	50
Active Gain (dB)	28 @ 2.7 V
Voltage (V)	1.5 - 3.6
Current (mA)	9 @ 2.7 V
Power Consumption (mW)	24.3 @ 2.7V

2J6552BGF 3-in-1 antenna 3G/2G | GPS/GLONASS | IRIDIUM

Key Features

- ✓ Heavy Duty antenna
- ✓ Ground Plane Dependent
- ✓ Customizable Cable and Connector
- ✓ Certificates: **IP67** - Water resistant, **IP69** - Hot water pressure, **IK09** - Impact resistant



General specification

Mounting type	Screw mount
Dimensions (mm)	Ø 146 x 31.5
Operating temperature	-40 °C to +85 °C
Certificates	IP67, IP69, IK09

Antenna and electrical specifications

3G/2G (Connection 1)

Standards	2G and 3G
Frequency (MHz)	824-960, 1710-2170
VSWR	~2.1:1, ~1.7:1
Peak Gain (dBi)	~1.8, ~2.3
Impedance (Ohm)	50
Polarisation	Linear
Max. Input Power (W)	25

Antenna and electrical specifications

GPS/GLONASS (Connection 2)

Standards	GPS/QZSS/Galileo/GLONASS
Frequency (MHz)	1575.42, 1598-1610
Impedance (Ohm)	50
Active Gain (dB)	28 @ 2.7 V
Voltage (V)	1.5 - 3.6
Current (mA)	9 @ 2.7 V
Power Consumption (mW)	24.3 @ 2.7V

Antenna and electrical specifications

IRIDIUM (Connection 3)

Standards	IRIDIUM
Frequency (MHz)	1616-1627
Passive Gain (dBi)	~4.5
Impedance (Ohm)	50
Axial Ratio (dB)	3 max
Radiation Pattern	Hemispherical
Polarization	RHCP

2J7041BGFa 3-in-1 antenna 2 × 4G LTE/3G/2G MIMO | GPS/GLONASS

Key Features

- ✓ Heavy Duty antenna
- ✓ High Performance
- ✓ Customizable Cable and Connector
- ✓ Certificates: **IP67** - Water resistant, **IP69** - Hot water pressure, **IK09** - Impact resistant



Standard colors
Other colors upon request

Antenna and electrical specifications

4G LTE/3G/2G (Connection 2)

Standards	2G,3G and 4G
Frequency (MHz)	698-960, 1710-2170, 2500-2700
VSWR	~1.9:1, ~1.6:1, ~1.4:1
Peak Gain (dBi)	~3.0, ~3.2, ~4.0
Impedance (Ohm)	50
Polarisation	Linear
Max. Input Power (W)	25

General specification

Mounting type	Screw mount
Dimensions (mm)	Ø 96 x H 90
Operating temperature	-40 °C to +85 °C
Certificates	IP67, IP69, IK09

Antenna and electrical specifications

4G LTE/3G/2G (Connection 1)

Standards	2G,3G and 4G
Frequency (MHz)	698-960, 1710-2170, 2500-2700
VSWR	~1.9:1, ~1.6:1, ~1.7:1
Peak Gain (dBi)	~2.1, ~4.2, ~3.1
Impedance (Ohm)	50
Polarisation	Linear
Max. Input Power (W)	25

Antenna and electrical specifications

GPS/GLONASS (Connection 3)

Standards	GPS/QZSS/Galileo/GLONASS
Frequency (MHz)	1575.42, 1598-1610
VSWR	<=1.5:1
Impedance (Ohm)	50
Polarisation	RHCP
Active Gain (dB)	28 @ 2.7 V
Voltage (V)	1.5 - 3.6
Noise Figure (dB)	1.8 @ 2.7 V
Current Consumption (mA)	9 @ 2.7 V
Power Consumption (mW)	24.3 @ 2.7 V
Saw Filter Type	Pre-Filter
Out of Band Rejection (dB)	43
ESD Protection (kV)	6

2J7741BGFa 3-in-1 antenna 2 × 4G LTE/3G/2G MIMO | GPS/GLONASS

Key Features

- ✓ Ground Plane Dependent
- ✓ High Performance
- ✓ Customizable Cable and Connector
- ✓ Certificates: **IP67** - Water resistant, **IP69** - Hot water pressure



Standard colors
Other colors upon request

Antenna and electrical specifications

4G LTE/3G/2G (Connection 2)

Standards	2G,3G and 4G
Frequency (MHz)	698-960, 1710-2170, 2500-2700
VSWR	~2.8:1, ~1.5:1, ~2.1:1
Peak Gain (dBi)	~-0.6, ~2.9, ~3.0
Impedance (Ohm)	50
Polarisation	Linear
Max. Input Power (W)	25

General specification

Mounting type	Screw mount
Dimensions (mm)	Ø 54.5 × 67.1
Operating temperature	-40 °C to +85 °C
Certificates	IP67, IP69

Antenna and electrical specifications

4G LTE/3G/2G (Connection 1)

Standards	2G,3G and 4G
Frequency (MHz)	698-960, 1710-2170, 2500-2700
VSWR	~2.9:1, ~1.4:1, ~1.4:1
Peak Gain (dBi)	~-0.8, ~3.6, ~4.1
Impedance (Ohm)	50
Polarisation	Linear
Max. Input Power (W)	25

Antenna and electrical specifications

GPS/GLONASS (Connection 3)

Standards	GPS/QZSS/Galileo/GLONASS
Frequency (MHz)	1575.42, 1598-1610
VSWR	<=1.4:1
Impedance (Ohm)	50
Polarisation	RHCP
Active Gain (dB)	28 @ 2.7 V
Voltage (V)	1.5 - 3.6
Current (mA)	9 Typ
Power Consumption (mW)	24.3 Typ

2J7750BGF 3-in-1 antenna 4G LTE/3G/2G | 2.4/5.0 GHz ISM | GPS/GLONASS

Key Features

- ✔ Ground Plane Dependent ✔ High Performance ✔ Customizable Cable and Connector
- ✔ Certificates: **IP67** - Water resistant, **IP69** - Hot water pressure



General specification

Mounting type	Screw mount
Dimensions (mm)	Ø 54.5 × 67.1
Operating temperature	-40 °C to +85 °C
Certificates	IP67, IP69

Antenna and electrical specifications

4G LTE/3G/2G (Connection 1)

Standards	2G,3G and 4G
Frequency (MHz)	698-960, 1710-2170, 2500-2700
VSWR	~2.2:1, ~1.4:1, ~1.6:1
Peak Gain (dBi)	~2.0, ~4.5, ~3.7
Impedance (Ohm)	50
Polarisation	Linear
Max. Input Power (W)	25

Antenna and electrical specifications

2.4/5.0 GHz ISM (Connection 2)

Standards	WiFi, BT, ZigBee, ISM
Frequency (MHz)	2410-2490, 4920-5925
VSWR	~1.5:1, ~2.5:1
Peak Gain (dBi)	~4.5, ~2.5
Impedance (Ohm)	50
Polarisation	Linear
Max. Input Power (W)	25

Antenna and electrical specifications

GPS/GLONASS (Connection 3)

Standards	GPS/QZSS/Galileo/GLONASS
Frequency (MHz)	1575.42, 1598-1610
VSWR	<=1.4:1
Impedance (Ohm)	50
Polarisation	RHCP
Active Gain (dB)	28 @ 2.7 V
Voltage (V)	1.5 – 3.6
Current (mA)	9 Typ
Power Consumption (mW)	24.3 Typ

2J6551BGF 4-in-1 antenna

3G/2G | 2.4 GHz ISM | GPS/GLONASS | IRIDIUM

Key Features

- ✔ Heavy Duty antenna
- ✔ Ground Plane Dependent
- ✔ Customizable Cable and Connector
- ✔ Certificates: **IP67** - Water resistant, **IP69** - Hot water pressure, **IK09** - Impact resistant



General specification

Mounting type	Screw mount
Dimensions (mm)	Ø 146 x 31.5
Operating temperature	-40 °C to +85 °C
Certificates	IP67, IP69, IK09

Antenna and electrical specifications

3G/2G (Connection 1)

Standards	2G and 3G
Frequency (MHz)	824-960, 1710-2170
VSWR	~2.1:1, ~1.7:1
Peak Gain (dBi)	~1.8, ~2.3
Impedance (Ohm)	50
Polarisation	Linear
Max. Input Power (W)	25

Antenna and electrical specifications

2.4 GHz ISM (Connection 2)

Standards	WiFi, BT, ZigBee, ISM
Frequency (MHz)	2410-2490
VSWR	~1.4:1
Peak Gain (dBi)	~2.5
Impedance (Ohm)	50
Polarisation	Linear
Max. Input Power (W)	10

Antenna and electrical specifications

GPS/GLONASS (Connection 3)

Standards	GPS/QZSS/Galileo/GLONASS
Frequency (MHz)	1575.42, 1598-1610
Impedance (Ohm)	50
Active Gain (dB)	28 @ 2.7 V
Voltage (V)	1.5 - 3.6
Current (mA)	9 @ 2.7 V
Power Consumption (mW)	24.3 @ 2.7V

Antenna and electrical specifications

IRIDIUM (Connection 4)

Standards	IRIDIUM
Frequency (MHz)	1616-1627
Passive Gain (dBi)	~4.5
Impedance (Ohm)	50
Axial Ratio (dB)	3 max
Radiation Pattern	Hemispherical
Polarization	RHCP

2J7002Bc 4-in-1 antenna

4 × 2.4/5.0 GHz ISM MIMO

Key Features

- ✔ Heavy Duty antenna
- ✔ High Performance
- ✔ Ground Plane Independent
- ✔ Customizable Cable and Connector
- ✔ Certificates: **IP67** - Water resistant, **IP69** - Hot water pressure, **IK09** - Impact resistant



General specification

Mounting type	Screw mount
Dimensions (mm)	Ø 96 x H 90
Operating temperature	-40 °C to +85 °C
Certificates	IP67, IP69, IK09

Antenna and electrical specifications

2.4/5.0 GHz ISM (Connection 1)

Standards	WiFi, BT, ZigBee, ISM
Frequency (MHz)	2410-2490, 4920-5925
VSWR	~1.9:1, ~1.6:1
Peak Gain (dBi)	~5.6, ~5.5
Impedance (Ohm)	50
Polarisation	Linear
Max. Input Power (W)	25

Antenna and electrical specifications

2.4/5.0 GHz ISM (Connection 2)

Standards	WiFi, BT, ZigBee, ISM
Frequency (MHz)	2410-2490, 4920-5925
VSWR	~1.6:1, ~1.5:1
Peak Gain (dBi)	~3.9, ~4.1
Impedance (Ohm)	50
Polarisation	Linear
Max. Input Power (W)	25

Antenna and electrical specifications

2.4/5.0 GHz ISM (Connection 3)

Standards	WiFi, BT, ZigBee, ISM
Frequency (MHz)	2410-2490, 4920-5925
VSWR	~2.1:1, ~1.6:1
Peak Gain (dBi)	~5.5, ~4.4
Impedance (Ohm)	50
Polarisation	Linear
Max. Input Power (W)	25

Antenna and electrical specifications

2.4/5.0 GHz ISM (Connection 4)

Standards	WiFi, BT, ZigBee, ISM
Frequency (MHz)	2410-2490, 4920-5925
VSWR	~1.8:1, ~1.5:1
Peak Gain (dBi)	~3.4, ~3.1
Impedance (Ohm)	50
Polarisation	Linear
Max. Input Power (W)	25

2J7024Bc 4-in-1 antenna

4 x 4G LTE/3G/2G MIMO

Key Features

- ✔ Heavy Duty antenna ✔ High Performance ✔ Customizable Cable and Connector
- ✔ Certificates: **IP67** - Water resistant, **IP69** - Hot water pressure, **IK09** - Impact resistant



General specification

Mounting type	Screw mount
Dimensions (mm)	Ø 96 x H 90
Operating temperature	-40 °C to +85 °C
Certificates	IP67, IP69, IK09

Antenna and electrical specifications

4G LTE/3G/2G (Connection 1)	
Standards	2G,3G and 4G
Frequency (MHz)	698-960, 1710-2170, 2500-2700
VSWR	~2.9:1, ~1.9:1, ~1.3:1
Peak Gain (dBi)	~0.2, ~3.8, ~6.0
Impedance (Ohm)	50
Polarisation	Linear
Max. Input Power (W)	25

Antenna and electrical specifications

4G LTE/3G/2G (Connection 2)	
Standards	2G,3G and 4G
Frequency (MHz)	698-960, 1710-2170, 2500-2700
VSWR	~2.8:1, ~2.1:1, ~1.4:1
Peak Gain (dBi)	~-0.1, ~3.2, ~5.6
Impedance (Ohm)	50
Polarisation	Linear
Max. Input Power (W)	25

Antenna and electrical specifications

4G LTE/3G/2G (Connection 3)	
Standards	2G,3G and 4G
Frequency (MHz)	698-960, 1710-2170, 2500-2700
VSWR	~2.9:1, ~2.0:1, ~1.4:1
Peak Gain (dBi)	~-0.5, ~3.1, ~5.0
Impedance (Ohm)	50
Polarisation	Linear
Max. Input Power (W)	25

Antenna and electrical specifications

4G LTE/3G/2G (Connection 4)	
Standards	2G,3G and 4G
Frequency (MHz)	698-960, 1710-2170, 2500-2700
VSWR	~2.8:1, ~2.1:1, ~1.4:1
Peak Gain (dBi)	~-0.7, ~3.0, ~4.8
Impedance (Ohm)	50
Polarisation	Linear
Max. Input Power (W)	25

2J9547a-B01 4-in-1 antenna 2 x 4G LTE/3G/2G MIMO | 2 x 2.4/5.0 GHz ISM MIMO

Key Features

- ✔ High Performance ✔ Customizable Cable and Connector
- ✔ Certificates: **IP69** - Hot water pressure



General specification

Mounting type	Screw mount
Dimensions (mm)	280 x 280 x 150
Operating temperature	-40 °C to +85 °C
Certificates	IP69

Antenna and electrical specifications

4G LTE/3G/2G (Connection 1)

Standards	2G,3G and 4G
Frequency (MHz)	698-960, 1710-2170, 2500-2700
VSWR	~1.7:1, ~1.3:1, ~1.3:1
Peak Gain (dBi)	~3.5, ~4.6, ~3.9
Impedance (Ohm)	50
Polarisation	Linear
Max. Input Power (W)	25

Antenna and electrical specifications

4G LTE/3G/2G (Connection 2)

Standards	2G,3G and 4G
Frequency (MHz)	698-960, 1710-2170, 2500-2700
VSWR	~1.7:1, ~1.3:1, ~1.2:1
Peak Gain (dBi)	~3.8, ~5.8, ~4.0
Impedance (Ohm)	50
Polarisation	Linear
Max. Input Power (W)	25

Antenna and electrical specifications

2.4/5.0 GHz ISM (Connection 3)

Standards	WiFi, BT, ZigBee, ISM
Frequency (MHz)	2410-2490, 4920-5925
VSWR	~1.8:1, ~2.2:1
Peak Gain (dBi)	~2.9, ~2.7
Impedance (Ohm)	50
Polarisation	Linear
Max. Input Power (W)	25

Antenna and electrical specifications

2.4/5.0 GHz ISM (Connection 4)

Standards	WiFi, BT, ZigBee, ISM
Frequency (MHz)	2410-2490, 4920-5925
VSWR	~2.0:1, ~2.2:1
Peak Gain (dBi)	~5.2, ~3.3
Impedance (Ohm)	50
Polarisation	Linear
Max. Input Power (W)	25

2J7041BGFc 5-in-1 antenna 4 × 4G LTE/3G/2G MIMO | GPS/GLONASS

Key Features

- ✔ Heavy Duty antenna ✔ High Performance ✔ Customizable Cable and Connector
- ✔ Certificates: **IP67** - Water resistant, **IP69** - Hot water pressure, **IK09** - Impact resistant



General specification

Mounting type	Screw mount
Dimensions (mm)	Ø 96 x H 90
Operating temperature	-40 °C to +85 °C
Certificates	IP67, IP69, IK09

Antenna and electrical specifications

4G LTE/3G/2G (Connection 1)

Standards	2G,3G and 4G
Frequency (MHz)	698-960, 1710-2170, 2500-2700
VSWR	~2.9:1, ~1.9:1, ~1.3:1
Peak Gain (dBi)	~0.2, ~3.8, ~6.0
Impedance (Ohm)	50
Polarisation	Linear
Max. Input Power (W)	25

Antenna and electrical specifications

4G LTE/3G/2G (Connection 2)

Standards	2G,3G and 4G
Frequency (MHz)	698-960, 1710-2170, 2500-2700
VSWR	~2.8:1, ~2.1:1, ~1.4:1
Peak Gain (dBi)	~-0.1, ~3.2, ~5.6
Impedance (Ohm)	50
Polarisation	Linear
Max. Input Power (W)	25

Antenna and electrical specifications

4G LTE/3G/2G (Connection 3)

Standards	2G,3G and 4G
Frequency (MHz)	698-960, 1710-2170, 2500-2700
VSWR	~2.9:1, ~2.0:1, ~1.4:1
Peak Gain (dBi)	~-0.5, ~3.1, ~5.0
Impedance (Ohm)	50
Polarisation	Linear
Max. Input Power (W)	25

Antenna and electrical specifications

4G LTE/3G/2G (Connection 4)

Standards	2G,3G and 4G
Frequency (MHz)	698-960, 1710-2170, 2500-2700
VSWR	~2.8:1, ~2.1:1, ~1.4:1
Peak Gain (dBi)	~-0.7, ~3.0, ~4.8
Impedance (Ohm)	50
Polarisation	Linear
Max. Input Power (W)	25

Antenna and electrical specifications

GPS/GLONASS (Connection 5)

Standards	GPS/QZSS/Galileo/GLONASS
Frequency (MHz)	1575.42, 1598-1610
VSWR	<=1.5:1
Impedance (Ohm)	50
Polarisation	RHCP
Active Gain (dBi)	28 @ 2.7 V
Voltage (V)	1.5 - 3.6
Noise Figure (dB)	1.8 @ 2.7 V
Current Consumption (mA)	9 @ 2.7 V
Power Consumption (mW)	24.3 @ 2.7 V
Saw Filter Type	Pre-Filter
Out of Band Rejection (dB)	43
ESD Protection (kV)	6

2J7050BGFa antenna



DC Grounded Antenna

2 × 4G LTE
2 × WIFI
1 × GPS/Glonass

5-in-1

Antenna description

2J7050BGa is one of the smallest form factor, multiple technology antennas still offering the highest level of performance.

2J7050BGa Antenna is compact, heavy duty 5-in-1 combination antenna solution with LTE-MIMO, Dual WiFi-MIMO and GNSS (GPS/GLONASS). High gain and 60% efficiency across worldwide 4G LTE and 2G, 3G bands, its ideal for high-end public safety applications such as police, ambulance and fire, HD video broadcasting, resource management, transportation, critical communications and other industries. Having extremely low ECC (Envelope Correlation Coefficient) allows for low latency and high data transfer rates. High gain, low noise and pre-filtered GNSS antenna for more accurate geo-location and navigation, as well as high performance dual WI-FI-MIMO antennas for better signal reception.

The IP67 and IP69 ingress ratings provide this compact antenna with maximum protection against dust and water penetration, while the IK09 rating adds an extra level of anti-vandal security, with high impact resistance. The antenna has also been tested to EN61373 (Vibration and Shock) and EN45545-2 (Fire Protection) for use in railway applications while the UV stable housing material is available in a range of colored finishes.

This screw mount antenna comes with low loss cables thread through a single mounting hole for easy installation. Cables and connectors can be customized to specific requirements. A truly versatile antenna solution allowing to change (other technologies) or remove antennas and its respective cable to satisfy your end application.

2J7050BGFa 5-in-1 antenna

2 × 4G LTE/3G/2G MIMO | 2 × 2.4/5.0 GHz ISM MIMO | GPS/GLONASS

Key Features

- ✔ Heavy Duty antenna
- ✔ High Performance
- ✔ DC Grounded Antenna
- ✔ Customizable Cable and Connector
- ✔ Certificates: **IP67** - Water resistant, **IP69** - Hot water pressure, **IK09** - Impact resistant, Vibration & Shock, Fire protection



General specification

Mounting type	Screw mount
Dimensions (mm)	Ø 96 x H 90
Operating temperature	-40 °C to +85 °C
Certificates	IP67, IP69, IK09

Antenna and electrical specifications

4G LTE/3G/2G (Connection 1)

Standards	2G,3G and 4G
Frequency (MHz)	698-960, 1710-2170, 2500-2700
VSWR	~1.9:1, ~1.6:1, ~1.7:1
Peak Gain (dBi)	~2.1, ~4.2, ~3.1
Impedance (Ohm)	50
Polarisation	Linear
Max. Input Power (W)	25

Antenna and electrical specifications

4G LTE/3G/2G (Connection 2)

Standards	2G,3G and 4G
Frequency (MHz)	698-960, 1710-2170, 2500-2700
VSWR	~1.9:1, ~1.6:1, ~1.4:1
Peak Gain (dBi)	~3.0, ~3.2, ~4.0
Impedance (Ohm)	50
Polarisation	Linear
Max. Input Power (W)	25

Antenna and electrical specifications

2.4/5.0 GHz ISM (Connection 3)

Standards	WiFi, BT, ZigBee, ISM
Frequency (MHz)	2410-2490, 4920-5925
VSWR	~1.9:1, ~1.6:1
Peak Gain (dBi)	~5.6, ~5.5
Impedance (Ohm)	50
Polarisation	Linear
Max. Input Power (W)	25

Antenna and electrical specifications

2.4/5.0 GHz ISM (Connection 4)

Standards	WiFi, BT, ZigBee, ISM
Frequency (MHz)	2410-2490, 4920-5925
VSWR	~2.1:1, ~1.6:1
Peak Gain (dBi)	~5.5, ~4.4
Impedance (Ohm)	50
Polarisation	Linear
Max. Input Power (W)	25

Antenna and electrical specifications

GPS/GLONASS (Connection 5)

Standards	GPS/QZSS/Galileo/GLONASS
Frequency (MHz)	1575.42, 1598-1610
VSWR	<=1.5:1
Impedance (Ohm)	50
Polarisation	RHCP
Active Gain (dBi)	28 @ 2.7 V
Voltage (V)	1.5 - 3.6
Noise Figure (dB)	1.8 @ 2.7 V
Current Consumption (mA)	9 @ 2.7 V
Power Consumption (mW)	24.3 @ 2.7 V
Saw Filter Type	Pre-Filter
Out of Band Rejection (dB)	43
ESD Protection (kV)	6

2J7068BGFa-915 5-in-1 antenna

2 x 4G LTE/3G/2G MIMO | 2.4/5.0 GHz ISM | GPS/GLONASS | 915 MHz ISM

Key Features

- ✓ Heavy Duty antenna
- ✓ High Performance
- ✓ Customizable Cable and Connector
- ✓ Certificates: **IP67** - Water resistant, **IP69** - Hot water pressure, **IK09** - Impact resistant



General specification

Mounting type	Screw mount
Dimensions (mm)	Ø 96 x H 90
Operating temperature	-40 °C to +85 °C
Certificates	IP67, IP69, IK09

Antenna and electrical specifications

4G LTE/3G/2G (Connection 1)

Standards	2G,3G and 4G
Frequency (MHz)	698-960, 1710-2170, 2500-2700
VSWR	~2.9:1, ~1.9:1, ~1.3:1
Peak Gain (dBi)	~0.2, ~3.8, ~6.0
Impedance (Ohm)	50
Polarisation	Linear
Max. Input Power (W)	25

Antenna and electrical specifications

4G LTE/3G/2G (Connection 2)

Standards	2G,3G and 4G
Frequency (MHz)	698-960, 1710-2170, 2500-2700
VSWR	~2.8:1, ~2.1:1, ~1.4:1
Peak Gain (dBi)	~-0.1, ~3.2, ~5.6
Impedance (Ohm)	50
Polarisation	Linear
Max. Input Power (W)	25

Antenna and electrical specifications

2.4/5.0 GHz ISM (Connection 3)

Standards	WiFi, BT, ZigBee, ISM
Frequency (MHz)	2410-2490, 4920-5925
VSWR	~1.9:1, ~1.6:1
Peak Gain (dBi)	~5.6, ~5.5
Impedance (Ohm)	50
Polarisation	Linear
Max. Input Power (W)	25

Antenna and electrical specifications

GPS/GLONASS (Connection 4)

Standards	GPS/QZSS/Galileo/GLONASS
Frequency (MHz)	1575.42, 1598-1610
VSWR	<=1.5:1
Impedance (Ohm)	50
Polarisation	RHCP
Active Gain (dB)	28 @ 2.7 V
Voltage (V)	1.5 - 3.6
Noise Figure (dB)	1.8 @ 2.7 V
Current Consumption (mA)	9 @ 2.7 V
Power Consumption (mW)	24.3 @ 2.7 V
Saw Filter Type	Pre-Filter
Out of Band Rejection (dB)	43
ESD Protection (kV)	6

Antenna and electrical specifications

915 MHz ISM (Connection 5)

Standards	ZigBee, ISM, SIGFOX, LoRa
Frequency (MHz)	902-928
VSWR	~2.3:1
Peak Gain (dBi)	~0.5
Impedance (Ohm)	50
Polarisation	Linear
Max. Input Power (W)	25

2J6507MGF 2-in-1 antenna 433 MHz ISM | GPS/GLONASS

Key Features

- ✓ Heavy Duty antenna
- ✓ Ground Plane Dependent
- ✓ Customizable Cable and Connector
- ✓ Certificates: **IP67** - Water resistant, **IP69** - Hot water pressure, **IK09** - Impact resistant



Antenna and electrical specifications

433 MHz ISM (Connection 1)

Standards	ISM, LoRa
Frequency (MHz)	433-435
VSWR	~1.1:1
Peak Gain (dBi)	~2.9
Impedance (Ohm)	50
Polarisation	Linear
Max. Input Power (W)	50

General specification

Mounting type	Magnetic mount
Dimensions (mm)	Ø 136 x 31.5
Operating temperature	-40 °C to +85 °C
Certificates	IP67, IP69, IK09

Antenna and electrical specifications

GPS/GLONASS (Connection 2)

Standards	GPS/QZSS/Galileo/GLONASS
Frequency (MHz)	1575.42, 1598-1610
Impedance (Ohm)	50
Active Gain (dB)	28 @ 2.7 V
Voltage (V)	1.5 - 3.6
Current (mA)	9 @ 2.7 V
Power Consumption (mW)	24.3 @ 2.7V

2J7507M 2-in-1 antenna 433 MHz ISM | GPS

Key Features

- ✓ Ground Plane Dependent
- ✓ Customizable Cable and Connector
- ✓ Certificates: **IP67** - Water resistant, **IP69** - Hot water pressure



Antenna and electrical specifications

433 MHz ISM (Connection 1)

Standards	ISM, LoRa
Frequency (MHz)	433-435
VSWR	~1.5:1
Peak Gain (dBi)	~0.3
Impedance (Ohm)	50
Polarisation	Linear
Max. Input Power (W)	50

General specification

Mounting type	Magnetic mount
Dimensions (mm)	Ø 54 x 185
Operating temperature	-40 °C to +85 °C
Certificates	IP67, IP69

Antenna and electrical specifications

GPS (Connection 2)

Standards	GPS/QZSS/Galileo
Frequency (MHz)	1575.42
VSWR	<=1.5:1
Impedance (Ohm)	50
Polarisation	RHCP
Active Gain (dB)	23 @ 3 V
Voltage (V)	2.7 - 5.5
Current (mA)	15 - 25
Power Consumption (mW)	40.5 - 137.5

2J7539M 2-in-1 antenna 915 MHz ISM | GPS/GLONASS

Key Features

- ✔ High Performance
- ✔ Ground Plane Dependent
- ✔ Customizable Cable and Connector
- ✔ Certificates: **IP67** - Water resistant, **IP69** - Hot water pressure



Antenna and electrical specifications

915 MHz ISM (Connection 1)

Standards	ZigBee, ISM, SIGFOX, LoRa
Frequency (MHz)	902-928
VSWR	~1.2:1
Peak Gain (dBi)	~2.0
Impedance (Ohm)	50
Polarisation	Linear
Max. Input Power (W)	25

General specification

Mounting type	Magnetic mount
Dimensions (mm)	Ø 54 × 95.4
Operating temperature	-40 °C to +85 °C
Certificates	IP67, IP69

Antenna and electrical specifications

GPS/GLONASS (Connection 2)

Standards	GPS/QZSS/Galileo/GLONASS
Frequency (MHz)	1575.42, 1598-1610
VSWR	<=1.2:1
Impedance (Ohm)	50
Polarisation	RHCP
Active Gain (dB)	26 @ 3V / 27dB @ 5V
Voltage (V)	2.7 - 5.5
Current (mA)	15 - 25
Power Consumption (mW)	40 - 137

2J7541MF 2-in-1 antenna 4G LTE/3G/2G | GPS

Key Features

- ✔ High Performance
- ✔ Ground Plane Dependent
- ✔ Customizable Cable and Connector
- ✔ Certificates: **IP67** - Water resistant



Antenna and electrical specifications

4G LTE/3G/2G (Connection 1)

Standards	2G,3G and 4G
Frequency (MHz)	698-960, 1710-2170, 2500-2700
VSWR	~2.1:1, ~1.6:1, ~1.5:1
Peak Gain (dBi)	~1.3, ~2.0, ~2.6
Impedance (Ohm)	50
Polarisation	Linear
Max. Input Power (W)	25

General specification

Mounting type	Magnetic mount
Dimensions (mm)	Ø 54 × 80
Operating temperature	-40 °C to +85 °C
Certificates	IP67

Antenna and electrical specifications

GPS (Connection 2)

Standards	GPS/QZSS/Galileo
Frequency (MHz)	1575.42
VSWR	<=1.5:1
Impedance (Ohm)	50
Polarisation	RHCP
Active Gain (dB)	26 @ 3 V
Voltage (V)	2.7 - 5.5
Current (mA)	15 - 25
Power Consumption (mW)	40 - 137

2J7724Ma 2-in-1 antenna

2 x 4G LTE/3G/2G MIMO

Key Features

- ✔ Ground Plane Dependent
- ✔ High Performance
- ✔ Customizable Cable and Connector
- ✔ Certificates: **IP67** - Water resistant, **IP69** - Hot water pressure



General specification

Mounting type	Magnetic mount
Dimensions (mm)	Ø 54.5 x 67.1
Operating temperature	-40 °C to +85 °C
Certificates	IP67, IP69

Antenna and electrical specifications

4G LTE/3G/2G (Connection 1)	
Standards	2G,3G and 4G
Frequency (MHz)	698-960, 1710-2170, 2500-2700
VSWR	~2.7:1, ~1.5:1, ~1.4:1
Peak Gain (dBi)	~-0.1, ~2.9, ~3.5
Impedance (Ohm)	50
Polarisation	Linear
Max. Input Power (W)	25

Antenna and electrical specifications

4G LTE/3G/2G (Connection 2)	
Standards	2G,3G and 4G
Frequency (MHz)	698-960, 1710-2170, 2500-2700
VSWR	~2.7:1, ~1.5:1, ~1.5:1
Peak Gain (dBi)	~-0.1, ~3.1, ~2.7
Impedance (Ohm)	50
Polarisation	Linear
Max. Input Power (W)	25

2J7741MCF 2-in-1 antenna

4G LTE/3G/2G | GPS/GLONASS/BeiDou

Key Features

- ✔ Ground Plane Dependent
- ✔ High Performance
- ✔ Customizable Cable and Connector
- ✔ Certificates: **IP67** - Water resistant, **IP69** - Hot water pressure

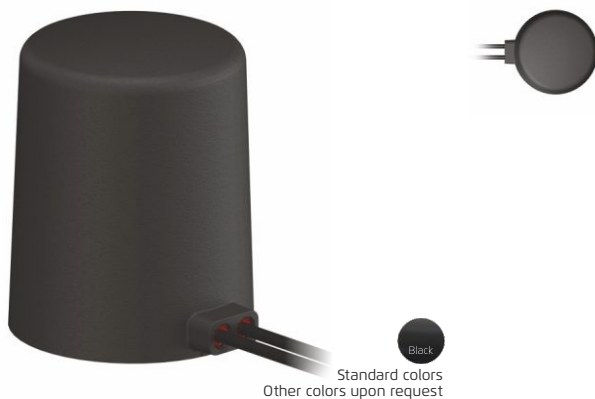

General specification

Mounting type	Magnetic mount
Dimensions (mm)	Ø 54.5 x 67.1
Operating temperature	-40 °C to +85 °C
Certificates	IP67, IP69

Antenna and electrical specifications

4G LTE/3G/2G (Connection 1)	
Standards	2G,3G and 4G
Frequency (MHz)	698-960, 1710-2170, 2500-2700
VSWR	~1.9:1, ~1.2:1, ~1.4:1
Peak Gain (dBi)	~-1.8, ~3.1, ~2.9
Impedance (Ohm)	50
Polarisation	Linear
Max. Input Power (W)	25

Antenna and electrical specifications

GPS/GLONASS/BeiDou (Connection 2)	
Standards	BeiDou/GPS/QZSS/Galileo/GLONASS
Frequency (MHz)	1561.098, 1575.42, 1598-1610
VSWR	<=1.4:1
Impedance (Ohm)	50
Polarisation	RHCP
Active Gain (dB)	28 @ 2.7 V
Voltage (V)	1.5 - 3.6
Current (mA)	9 Typ
Power Consumption (mW)	24.3 Typ

2J7741MCFa 3-in-1 antenna 2 x 4G LTE/3G/2G MIMO | GPS/GLONASS/BeiDou

Key Features

- ✓ Ground Plane Dependent
- ✓ High Performance
- ✓ Customizable Cable and Connector
- ✓ Certificates: **IP67** - Water resistant, **IP69** - Hot water pressure

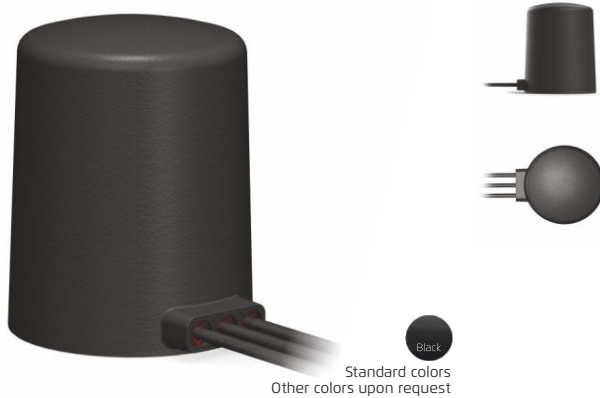

General specification

Mounting type	Magnetic mount
Dimensions (mm)	Ø 54.5 × 67.1
Operating temperature	-40 °C to +85 °C
Certificates	IP67, IP69

Antenna and electrical specifications

4G LTE/3G/2G (Connection 1)

Standards	2G,3G and 4G
Frequency (MHz)	698-960, 1710-2170, 2500-2700
VSWR	~2.7:1, ~1.5:1, ~1.4:1
Peak Gain (dBi)	~-0.1, ~2.9, ~3.5
Impedance (Ohm)	50
Polarisation	Linear
Max. Input Power (W)	25

Antenna and electrical specifications

4G LTE/3G/2G (Connection 2)

Standards	2G,3G and 4G
Frequency (MHz)	698-960, 1710-2170, 2500-2700
VSWR	~2.7:1, ~1.5:1, ~1.5:1
Peak Gain (dBi)	~-0.1, ~3.1, ~2.7
Impedance (Ohm)	50
Polarisation	Linear
Max. Input Power (W)	25

Antenna and electrical specifications

GPS/GLONASS/BeiDou (Connection 3)

Standards	BeiDou/GPS/QZSS/Galileo/GLONASS
Frequency (MHz)	1561.098, 1575.42, 1598-1610
VSWR	<=1.4:1
Impedance (Ohm)	50
Polarisation	RHCP
Active Gain (dB)	28 @ 2.7 V
Voltage (V)	1.5 – 3.6
Current (mA)	9 Typ
Power Consumption (mW)	24.3 Typ

2J7750MCF 3-in-1 antenna 4G LTE/3G/2G | 2.4/5.0 GHz ISM | GPS/GLONASS/BeiDou

Key Features

- ✓ Ground Plane Dependent
- ✓ High Performance
- ✓ Customizable Cable and Connector
- ✓ Certificates: **IP67** - Water resistant, **IP69** - Hot water pressure

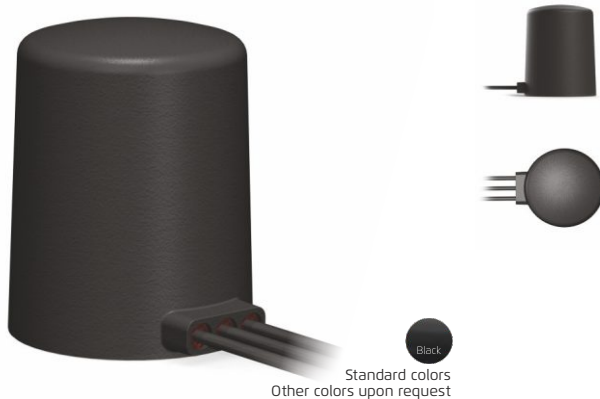

General specification

Mounting type	Magnetic mount
Dimensions (mm)	Ø 54.5 × 67.1
Operating temperature	-40 °C to +85 °C
Certificates	IP67, IP69

Antenna and electrical specifications

4G LTE/3G/2G (Connection 1)

Standards	2G,3G and 4G
Frequency (MHz)	698-960, 1710-2170, 2500-2700
VSWR	~2.1:1, ~1.4:1, ~2.1:1
Peak Gain (dBi)	~2.2, ~3.7, ~3.2
Impedance (Ohm)	50
Polarisation	Linear
Max. Input Power (W)	25

Antenna and electrical specifications

2.4/5.0 GHz ISM (Connection 2)

Standards	WiFi, BT, ZigBee, ISM
Frequency (MHz)	2410-2490, 4920-5925
VSWR	~1.7:1, ~1.8:1
Peak Gain (dBi)	~4.5, ~4.8
Impedance (Ohm)	50
Polarisation	Linear
Max. Input Power (W)	25

Antenna and electrical specifications

GPS/GLONASS/BeiDou (Connection 3)

Standards	BeiDou/GPS/QZSS/Galileo/GLONASS
Frequency (MHz)	1561.098, 1575.42, 1598-1610
VSWR	<=1.4:1
Impedance (Ohm)	50
Polarisation	RHCP
Active Gain (dB)	28 @ 2.7 V
Voltage (V)	1.5 – 3.6
Current (mA)	9 Typ
Power Consumption (mW)	24.3 Typ

2J9524a 2-in-1 antenna

2 x 4G LTE/3G/2G MIMO

Key Features

- ✔ High Performance ✔ Customizable Cable and Connector
- ✔ Certificates: IP69 - Hot water pressure



Standard colors
Other colors upon request

General specification

Mounting type	Mast mount
Dimensions (mm)	280 x 280 x 150
Operating temperature	-40 °C to +85 °C
Certificates	IP69K for antenna

Antenna and electrical specifications

4G LTE/3G/2G (Connection 1)

Standards	2G,3G and 4G
Frequency (MHz)	698-960, 1710-2170, 2500-2700
VSWR	~1.7:1, ~1.3:1, ~1.3:1
Peak Gain (dBi)	~3.5, ~4.6, ~3.9
Impedance (Ohm)	50
Polarisation	Linear
Max. Input Power (W)	25

Antenna and electrical specifications

4G LTE/3G/2G (Connection 2)

Standards	2G,3G and 4G
Frequency (MHz)	698-960, 1710-2170, 2500-2700
VSWR	~1.7:1, ~1.3:1, ~1.2:1
Peak Gain (dBi)	~3.8, ~5.8, ~4.0
Impedance (Ohm)	50
Polarisation	Linear
Max. Input Power (W)	25

2J9547a

4-in-1 antenna

2 × 4G LTE/3G/2G MIMO | 2 × 2.4/5.0 GHz ISM MIMO

Key Features

- High Performance
- Customizable Cable and Connector
- Certificates: IP69 - Hot water pressure



General specification

Mounting type	Mast mount
Dimensions (mm)	280 x 280 x 150
Operating temperature	-40 °C to +85 °C
Certificates	IP69

Antenna and electrical specifications

4G LTE/3G/2G (Connection 1)

Standards	2G,3G and 4G
Frequency (MHz)	698-960, 1710-2170, 2500-2700
VSWR	~1.7:1, ~1.3:1, ~1.3:1
Peak Gain (dBi)	~3.5, ~4.6, ~3.9
Impedance (Ohm)	50
Polarisation	Linear
Max. Input Power (W)	25

Antenna and electrical specifications

4G LTE/3G/2G (Connection 2)

Standards	2G,3G and 4G
Frequency (MHz)	698-960, 1710-2170, 2500-2700
VSWR	~1.7:1, ~1.3:1, ~1.2:1
Peak Gain (dBi)	~3.8, ~5.8, ~4.0
Impedance (Ohm)	50
Polarisation	Linear
Max. Input Power (W)	25

Antenna and electrical specifications

2.4/5.0 GHz ISM (Connection 3)

Standards	WiFi, BT, ZigBee, ISM
Frequency (MHz)	2410-2490, 4920-5925
VSWR	~1.8:1, ~2.2:1
Peak Gain (dBi)	~2.9, ~2.7
Impedance (Ohm)	50
Polarisation	Linear
Max. Input Power (W)	25

Antenna and electrical specifications

2.4/5.0 GHz ISM (Connection 4)

Standards	WiFi, BT, ZigBee, ISM
Frequency (MHz)	2410-2490, 4920-5925
VSWR	~2.0:1, ~2.2:1
Peak Gain (dBi)	~5.2, ~3.3
Impedance (Ohm)	50
Polarisation	Linear
Max. Input Power (W)	25

2J7050JGFa 5-in-1 antenna

2 x 4G LTE/3G/2G MIMO | 2 x 2.4/5.0 GHz ISM MIMO | GPS/GLONASS

Key Features

- ✔ Heavy Duty antenna
- ✔ High Performance
- ✔ For 43,2mm or 1.7 inches Mast Mounting
- ✔ Customizable Cable and Connector
- ✔ Certificates: **IP67** - Water resistant, **IP69** - Hot water pressure, **IK09** - Impact resistant, Vibration & Shock, Fire protection



General specification

Mounting type	Mast mount
Dimensions (mm)	Ø 96 x H 90
Operating temperature	-40 °C to +85 °C
Certificates	IP67, IP69, IK09

Antenna and electrical specifications

4G LTE/3G/2G (Connection 1)

Standards	2G,3G and 4G
Frequency (MHz)	698-960, 1710-2170, 2500-2700
VSWR	~1.9:1, ~1.6:1, ~1.7:1
Peak Gain (dBi)	~2.1, ~4.2, ~3.1
Impedance (Ohm)	50
Polarisation	Linear
Max. Input Power (W)	25

Antenna and electrical specifications

4G LTE/3G/2G (Connection 2)

Standards	2G,3G and 4G
Frequency (MHz)	698-960, 1710-2170, 2500-2700
VSWR	~1.9:1, ~1.6:1, ~1.4:1
Peak Gain (dBi)	~3.0, ~3.2, ~4.0
Impedance (Ohm)	50
Polarisation	Linear
Max. Input Power (W)	25

Antenna and electrical specifications

2.4/5.0 GHz ISM (Connection 3)

Standards	WiFi, BT, ZigBee, ISM
Frequency (MHz)	2410-2490, 4920-5925
VSWR	~1.9:1, ~1.6:1
Peak Gain (dBi)	~5.6, ~5.5
Impedance (Ohm)	50
Polarisation	Linear
Max. Input Power (W)	25

Antenna and electrical specifications

2.4/5.0 GHz ISM (Connection 4)

Standards	WiFi, BT, ZigBee, ISM
Frequency (MHz)	2410-2490, 4920-5925
VSWR	~2.1:1, ~1.6:1
Peak Gain (dBi)	~5.5, ~4.4
Impedance (Ohm)	50
Polarisation	Linear
Max. Input Power (W)	25

Antenna and electrical specifications

GPS/GLONASS (Connection 5)

Standards	GPS/QZSS/Galileo/GLONASS
Frequency (MHz)	1575.42, 1598-1610
VSWR	<=1.5:1
Impedance (Ohm)	50
Polarisation	RHCP
Active Gain (dBi)	28 @ 2.7 V
Voltage (V)	1.5 - 3.6
Noise Figure (dB)	1.8 @ 2.7 V
Current Consumption (mA)	9 @ 2.7 V
Power Consumption (mW)	24.3 @ 2.7 V
Saw Filter Type	Pre-Filter
Out of Band Rejection (dB)	43
ESD Protection (kV)	6

single & combination internal antennas

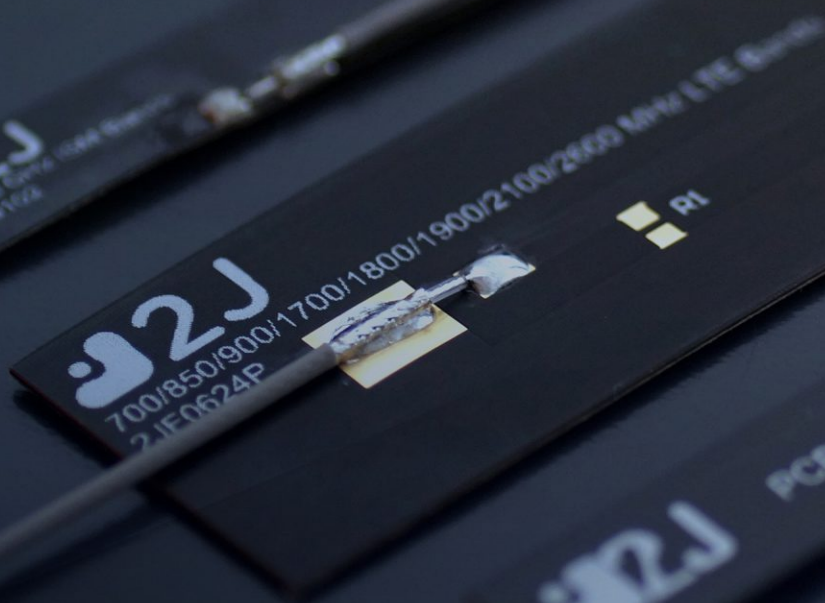

2JP0124P

4G LTE/3G/2G

Key Features

- ✔ Rigid Embedded Antenna
- ✔ High Performance
- ✔ Self-Adhesive
- ✔ Customizable Cable and Connector



General specification

Mounting type	Adhesive mount
Dimensions (mm)	136.8 x 32.6 x 0.4
Operating temperature	-40 °C to +85 °C

Antenna and electrical specifications

4G LTE/3G/2G

Standards	2G,3G and 4G
Frequency (MHz)	698-960, 1710-2170, 2500-2700
VSWR	~1.7:1, ~1.1:1, ~1.7:1
Peak Gain (dBi)	~1.5, ~3.1, ~3.5
Impedance (Ohm)	50
Polarisation	Linear
Max. Input Power (W)	25

2JP0224P

4G LTE/3G/2G

Key Features

- ✔ Rigid Embedded Antenna
- ✔ High Performance
- ✔ Self-Adhesive
- ✔ Customizable Cable and Connector



General specification

Mounting type	Adhesive mount
Dimensions (mm)	115.3 x 19.7 x 0.8
Operating temperature	-40 °C to +85 °C

Antenna and electrical specifications

4G LTE/3G/2G

Standards	2G,3G and 4G
Frequency (MHz)	698-960, 1710-2170
VSWR	~1.7:1, ~1.6:1
Peak Gain (dBi)	~0.8, ~2.7
Impedance (Ohm)	50
Polarisation	Linear
Max. Input Power (W)	25

2JP0424P

4G LTE/3G/2G

Key Features

- ✔ Rigid Embedded Antenna
- ✔ High Performance
- ✔ Ground Plane Independent
- ✔ Customizable Cable and Connector



General specification

Mounting type	Adhesive mount
Dimensions (mm)	113 x 8.5 x 0.8
Operating temperature	-40 °C to +85 °C

Antenna and electrical specifications

4G LTE/3G/2G

Standards	2G,3G and 4G
Frequency (MHz)	698-960, 1710-2170, 2500-2700
VSWR	~3.4:1, ~2.6:1, ~1.9:1
Peak Gain (dBi)	~1.2, ~4.0, ~5.6
Impedance (Ohm)	50
Polarisation	Linear
Max. Input Power (W)	25

2JP0524P

4G LTE/3G/2G

Key Features

- ✔ Rigid Embedded Antenna
- ✔ High Performance
- ✔ Self-Adhesive
- ✔ Customizable Cable and Connector



General specification

Mounting type	Adhesive mount
Dimensions (mm)	126 x 13.6 x 0.8
Operating temperature	-40 °C to +85 °C

Antenna and electrical specifications

4G LTE/3G/2G	
Standards	2G,3G and 4G
Frequency (MHz)	698-960, 1710-2170, 2500-2700
VSWR	~1.9:1, ~1.6:1, ~1.4:1
Peak Gain (dBi)	~0.8, ~2.2, ~2.0
Impedance (Ohm)	50
Polarisation	Linear
Max. Input Power (W)	25

2JP0624P

4G LTE/3G/2G

Key Features

- ✔ Rigid Embedded Antenna
- ✔ High Performance
- ✔ Self-Adhesive
- ✔ Ground Plane Independent
- ✔ Customizable Cable and Connector



General specification

Mounting type	Adhesive mount
Dimensions (mm)	89.7 x 14.1 x 0.8
Operating temperature	-40 °C to +85 °C

Antenna and electrical specifications

4G LTE/3G/2G	
Standards	2G,3G and 4G
Frequency (MHz)	698-960, 1710-2170, 2500-2700
VSWR	~1.5:1, ~1.8:1, ~2.1:1
Peak Gain (dBi)	~0.3, ~1.5, ~2.8
Impedance (Ohm)	50
Polarisation	Linear
Max. Input Power (W)	25

2JF0624P antenna

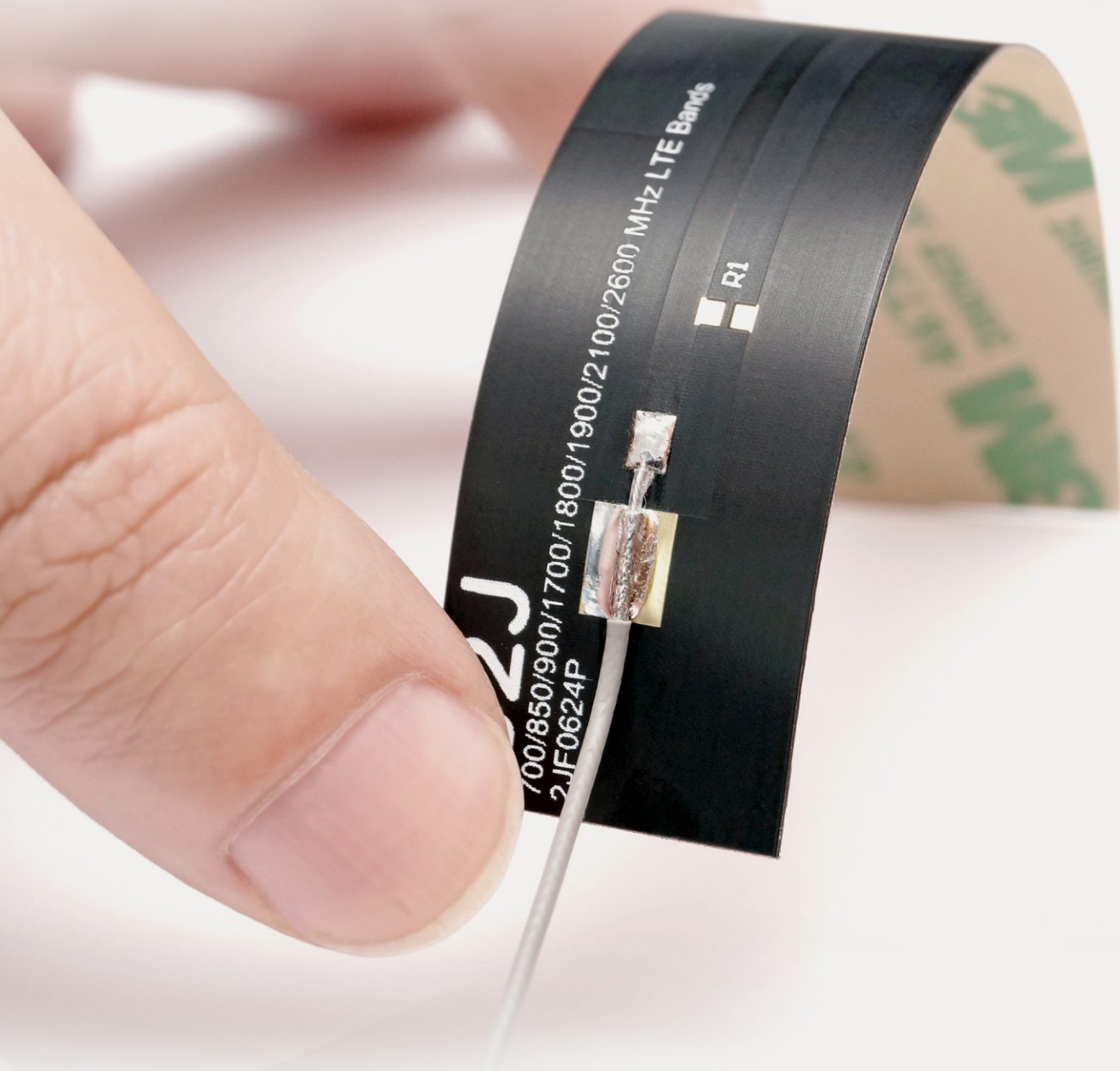

Antenna description

2J has a comprehensive range of embedded antenna solutions, from chip antenna to flexible printed circuit antennas, enabling efficient use of space within the device.

An example of which is the 2JF0624P, adhesive lined flexible antenna covering worldwide cellular and 4G LTE bands. With efficiency over 50% across all bands, our customers can be confident of passing PTCRB/CTIA approvals first time, achieving excellent performance from a compact, cost effective solution.

2JF0624P

Flexible antenna

4G LTE/3G/2G

Key Features

- ✔ Flexi Embedded Antenna
- ✔ Self-Adhesive
- ✔ High Performance
- ✔ Ground Plane Independent
- ✔ Customizable Cable and Connector



General specification

Mounting type	Adhesive mount
Dimensions (mm)	110.4 x 20.8 x 0.2
Operating temperature	-40 °C to +85 °C

Antenna and electrical specifications

4G LTE/3G/2G

Standards	2G,3G and 4G
Frequency (MHz)	698-960, 1710-2170, 2500-2700
VSWR	~1.6:1, ~2.0:1, ~2.8:1
Peak Gain (dBi)	~1.0, ~3.4, ~2.5
Impedance (Ohm)	50
Polarisation	Linear
Max. Input Power (W)	25

2JF0424P

Flexible antenna

4G LTE/3G/2G

Key Features

- ✔ Flexi Embedded Antenna
- ✔ Self-Adhesive
- ✔ High Performance
- ✔ Customizable Cable and Connector

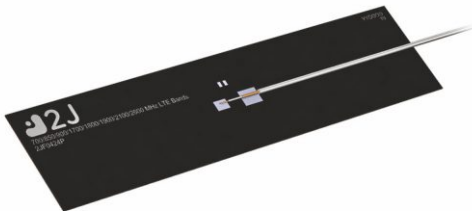

General specification

Mounting type	Adhesive mount
Dimensions (mm)	136.8 x 32.6 x 0.2
Operating temperature	-40 °C to +85 °C

Antenna and electrical specifications

4G LTE/3G/2G

Standards	2G,3G and 4G
Frequency (MHz)	698-960, 1710-2170, 2500-2700
VSWR	~1.7:1, ~1.1:1, ~1.7:1
Peak Gain (dBi)	~1.5, ~3.1, ~3.5
Impedance (Ohm)	50
Polarisation	Linear
Max. Input Power (W)	25

2JE03

3G/2G

Key Features

- ✔ Embedded Antenna
- ✔ High Performance
- ✔ Low Cost

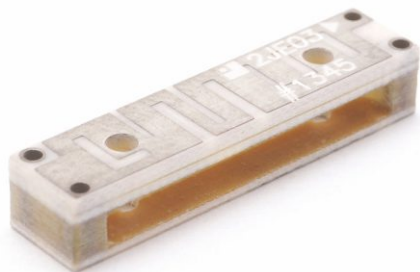

General specification

Mounting type	Surface mount
Dimensions (mm)	24 x 5.5 x 4.4
Operating temperature	-40 °C to +85 °C

Antenna and electrical specifications

3G/2G	
Standards	2G and 3G
Frequency (MHz)	824-960, 1710-2170
VSWR	~3:1, ~3:1
Peak Gain (dBi)	~1, ~3
Impedance (Ohm)	50
Polarisation	Linear
Max. Input Power (W)	25

2JE04

3G/2G

Key Features

- ✔ Embedded Antenna
- ✔ High Performance
- ✔ Low Cost

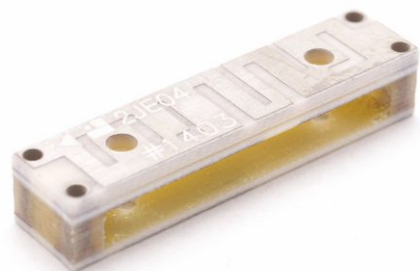

General specification

Mounting type	Surface mount
Dimensions (mm)	24 x 5.5 x 4.4
Operating temperature	-40 °C to +85 °C

Antenna and electrical specifications

3G/2G	
Standards	2G and 3G
Frequency (MHz)	824-960, 1710-2170
VSWR	~3:1, ~3:1
Peak Gain (dBi)	~1, ~3
Impedance (Ohm)	50
Polarisation	Linear
Max. Input Power (W)	25

2JP0104P

3G/2G

Key Features

- ✔ Rigid Embedded Antenna
- ✔ Self-Adhesive
- ✔ High Performance
- ✔ Customizable Cable and Connector



General specification

Mounting type	Adhesive mount
Dimensions (mm)	75 x 25 x 0.8
Operating temperature	-40 °C to +85 °C

Antenna and electrical specifications

3G/2G	
Standards	2G and 3G
Frequency (MHz)	824-960, 1710-2170
VSWR	~3:1, ~3:1
Peak Gain (dBi)	~1, ~3
Impedance (Ohm)	50
Polarisation	Linear
Max. Input Power (W)	25

2JP0704P

3G/2G

Key Features

- ✔ Rigid Embedded Antenna
- ✔ Self-Adhesive
- ✔ High Performance
- ✔ Customizable Cable and Connector



General specification

Mounting type	Adhesive mount
Dimensions (mm)	75 x 8.1 x 0.8
Operating temperature	-40 °C to +85 °C

Antenna and electrical specifications

3G/2G

Standards	2G and 3G
Frequency (MHz)	824-960, 1710-2170
VSWR	~2.5:1, ~1.7:1
Peak Gain (dBi)	~-1.3, ~-1.3
Impedance (Ohm)	50
Polarisation	Linear
Max. Input Power (W)	25

2JF0304P

Flexible antenna

3G/2G

Key Features

- ✔ Flexi Embedded Antenna
- ✔ Self-Adhesive
- ✔ Customizable Cable and Connector



General specification

Mounting type	Adhesive mount
Dimensions (mm)	70.4 x 26.4 x 0.1
Operating temperature	-40 °C to +85 °C

Antenna and electrical specifications

3G/2G

Standards	2G and 3G
Frequency (MHz)	824-960, 1710-2170
VSWR	~2.4:1, ~1.5:1
Peak Gain (dBi)	~1, ~2.1
Impedance (Ohm)	50
Polarisation	Linear
Max. Input Power (W)	25

2JF0404P

Flexible antenna

3G/2G

Key Features

- ✔ Flexi Embedded Antenna
- ✔ Self-Adhesive
- ✔ Ground Plane Independent
- ✔ Customizable Cable and Connector



General specification

Mounting type	Adhesive mount
Dimensions (mm)	82.2 x 20.6 x 0.2
Operating temperature	-40 °C to +85 °C

Antenna and electrical specifications

3G/2G

Standards	2G and 3G
Frequency (MHz)	824-960, 1710-2170
VSWR	~1.9:1, ~1.6:1
Peak Gain (dBi)	~-0.3, ~-2.2
Impedance (Ohm)	50
Polarisation	Linear
Max. Input Power (W)	25

2JF0604P

Flexible antenna

3G/2G

Key Features

- ✔ Flexi Embedded Antenna
- ✔ Self-Adhesive
- ✔ Ground Plane Independent
- ✔ Customizable Cable and Connector



General specification

Mounting type	Adhesive mount
Dimensions (mm)	74.9 x 8.1 x 0.1
Operating temperature	-40 °C to +85 °C

Antenna and electrical specifications

3G/2G

Standards	2G and 3G
Frequency (MHz)	824-960, 1710-2170
VSWR	~2.4:1, ~1.6:1
Peak Gain (dBi)	~0.7, ~0.7
Impedance (Ohm)	50
Polarisation	Linear
Max. Input Power (W)	25

2JF0101P Flexible antenna

GPS/GLONASS/BeiDou

Key Features

- ✓ Flexi Embedded Antenna
- ✓ High Performance
- ✓ Self-Adhesive
- ✓ Ground Plane Independent
- ✓ Customizable Cable and Connector



General specification

Mounting type	Adhesive mount
Dimensions (mm)	42 x 8.9 x 0.2
Operating temperature	-40 °C to +85 °C

Antenna and electrical specifications

GPS/GLONASS/BeiDou

Standards	BeiDou/GPS/QZSS/Galileo/GLONASS
Frequency (MHz)	1561.098, 1575.42, 1598-1606
Passive Gain (dBi)	~2.9, ~2.8, ~2.9
Impedance (Ohm)	50
Radiation Pattern	Omni-Directional
Polarization	Linear

2JCP2540101Ca

GPS/GLONASS/BeiDou

Key Features

- ✓ Ceramic Passive Antenna
- ✓ High Gain
- ✓ 25 x 25 x 4 mm



General specification

Mounting type	Thru-Hole mount
Dimensions (mm)	25 x 25 x 4
Operating temperature	-40 °C to +85 °C

Antenna and electrical specifications

GPS/GLONASS/BeiDou - Ceramic Passive Antenna

Standards	GPS/GLONASS/BeiDou/QZSS/Galileo
Frequency (MHz)	1561.098, 1575.42, 1598-1606
Passive Gain (dBi)	~4.2, ~4.5, ~5.0
Impedance (Ohm)	50
Radiation Pattern	Hemispherical
Polarization	RHCP

2JCP3640101Ca

GPS/GLONASS/BeiDou

Key Features

- ✓ Ceramic Passive Antenna
- ✓ High Gain
- ✓ 36 x 36 x 4 mm



General specification

Mounting type	Thru-Hole mount
Dimensions (mm)	36 x 36 x 4
Operating temperature	-40 °C to +85 °C

Antenna and electrical specifications

GPS/GLONASS/BeiDou - Ceramic Passive Antenna

Standards	GPS/GLONASS/BeiDou/QZSS/Galileo
Frequency (MHz)	1561.098, 1575.42, 1598-1606
Passive Gain (dBi)	~4.0, ~3.8, ~4.1
Impedance (Ohm)	50
Radiation Pattern	Hemispherical
Polarization	RHCP

2JCP1340101Ga

GPS/GLONASS

Key Features

- ✔ Ceramic Passive Antenna
- ✔ High Gain
- ✔ 13 x 13 x 4 mm



General specification

Mounting type	Thru-Hole mount
Dimensions (mm)	13 x 13 x 4
Operating temperature	-40 °C to +85 °C

Antenna and electrical specifications

GPS/GLONASS - Ceramic Passive Antenna

Standards	GPS/GLONASS/QZSS/Galileo
Frequency (MHz)	1575.42, 1598-1606
Passive Gain (dBi)	~3.5, ~3.1
Impedance (Ohm)	50
Radiation Pattern	Hemispherical

2JCP1840101Ga

GPS/GLONASS

Key Features

- ✔ Ceramic Passive Antenna
- ✔ High Gain
- ✔ 18 x 18 x 4 mm



General specification

Mounting type	Thru-Hole mount
Dimensions (mm)	18 x 18 x 4
Operating temperature	-40 °C to +85 °C

Antenna and electrical specifications

GPS/GLONASS - Ceramic Passive Antenna

Standards	GPS/GLONASS/QZSS/Galileo
Frequency (MHz)	1575.42, 1598-1606
Passive Gain (dBi)	~4.1, ~4.2
Impedance (Ohm)	50
Radiation Pattern	Hemispherical

2JCP2540101Ga

GPS/GLONASS

Key Features

- ✔ Ceramic Passive Antenna
- ✔ High Gain
- ✔ 25 x 25 x 4 mm



General specification

Mounting type	Thru-Hole mount
Dimensions (mm)	25 x 25 x 4
Operating temperature	-40 °C to +85 °C

Antenna and electrical specifications

GPS/GLONASS - Ceramic Passive Antenna

Standards	GPS/GLONASS/QZSS/Galileo
Frequency (MHz)	1575.42, 1598-1606
Passive Gain (dBi)	~3.6, ~3.9
Impedance (Ohm)	50
Radiation Pattern	Hemispherical

2JM0601GF

GPS/GLONASS

Key Features

- ✔ 14 dB Gain
- ✔ Pre-Filter
- ✔ Low Noise Figure
- ✔ Low Power Consumption
- ✔ 25 x 25 x 7.6 mm



General specification

Mounting type	Adhesive mount
Dimensions (mm)	25 x 25 x 7.6
Operating temperature	-40 °C to +85 °C

Antenna and electrical specifications

GPS/GLONASS - Ceramic Active Antenna

Standards	GPS/GLONASS/QZSS/Galileo
Frequency (MHz)	1575.42, 1598-1606
Passive Gain (dBi)	~3.6
Impedance (Ohm)	50
Voltage Range (V)	1.5 - 3.6
Active Gain (dB)	14 @ 2.7 V
Noise Figure (dB)	1.5 @ 2.7 V
Current Consumption (mA)	4 @ 2.7 V
Power Consumption (mW)	10.8 @ 2.7 V
Saw Filter Type	Pre-Filter
Out of Band Rejection (dB)	43
ESD Protection (kV)	6

2JM0701GF

GPS/GLONASS

Key Features

- ✔ 28 dB Gain
- ✔ Pre-Filter
- ✔ Low Noise Figure
- ✔ Low Power Consumption
- ✔ 25 x 25 x 7.6 mm



General specification

Mounting type	Adhesive mount
Dimensions (mm)	25 x 25 x 7.6
Operating temperature	-40 °C to +85 °C

Antenna and electrical specifications

GPS/GLONASS - Ceramic Active Antenna

Standards	GPS/GLONASS/QZSS/Galileo
Frequency (MHz)	1575.42, 1598-1606
Passive Gain (dBi)	~3.6
Impedance (Ohm)	50
Voltage Range (V)	1.5 - 3.6
Active Gain (dB)	28 @ 2.7 V
Noise Figure (dB)	1.8 @ 2.7 V
Current Consumption (mA)	9 @ 2.7 V
Power Consumption (mW)	24.3 @ 2.7 V
Saw Filter Type	Pre-Filter
Out of Band Rejection (dB)	43
ESD Protection (kV)	6

2JM0801GF

GPS/GLONASS

Key Features

- ✔ 28 dB Gain
- ✔ Mid-Filter
- ✔ Low Noise Figure
- ✔ Low Power Consumption
- ✔ 25 x 25 x 7.6 mm



General specification

Mounting type	Adhesive mount
Dimensions (mm)	25 x 25 x 7.6
Operating temperature	-40 °C to +85 °C

Antenna and electrical specifications

GPS/GLONASS - Ceramic Active Antenna

Standards	GPS/GLONASS/QZSS/Galileo
Frequency (MHz)	1575.42, 1598-1606
Passive Gain (dBi)	~3.6
Impedance (Ohm)	50
Voltage Range (V)	1.5 - 3.6
Active Gain (dB)	28 @ 2.7 V
Noise Figure (dB)	1.0 @ 2.7 V
Current Consumption (mA)	9 @ 2.7 V
Power Consumption (mW)	24.3 @ 2.7 V
Saw Filter Type	Mid-Filter
Out of Band Rejection (dB)	43
ESD Protection (kV)	2

2JCP1840101a

GPS

Key Features

- ✔ Ceramic Passive Antenna
- ✔ High Gain
- ✔ 18 x 18 x 4 mm

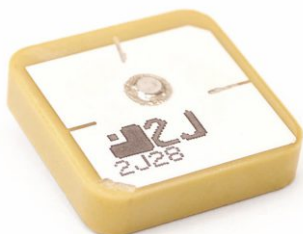

General specification

Mounting type	Thru-Hole mount
Dimensions (mm)	18 x 18 x 4
Operating temperature	-40 °C to +85 °C

Antenna and electrical specifications

GPS - Ceramic Passive Antenna

Standards	GPS/QZSS/Galileo
Frequency (MHz)	1575.42
Passive Gain (dBi)	~3.6
Impedance (Ohm)	50
Radiation Pattern	Hemispherical
Axial Ratio (dB)	3 max
Polarization	RHCP

2JCP2540101a

GPS

Key Features

- ✔ Ceramic Passive Antenna
- ✔ High Gain
- ✔ 25 x 25 x 4 mm



General specification

Mounting type	Thru-Hole mount
Dimensions (mm)	25 x 25 x 4
Operating temperature	-40 °C to +85 °C

Antenna and electrical specifications

GPS - Ceramic Passive Antenna

Standards	GPS/QZSS/Galileo
Frequency (MHz)	1575.42
Passive Gain (dBi)	~3.9
Impedance (Ohm)	50
Radiation Pattern	Hemispherical
Axial Ratio (dB)	3 max
Polarization	RHCP

2JM001F

GPS

Key Features

- ✔ 25 dB Gain
- ✔ Pre-Filter
- ✔ High Voltage
- ✔ 25 x 25 x 7.7 mm

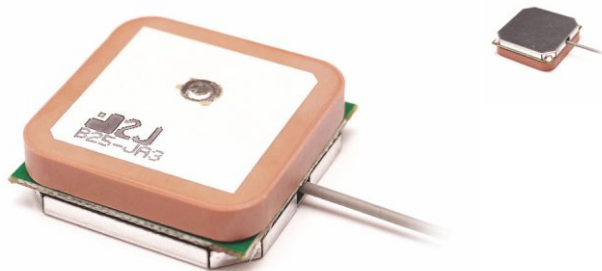

General specification

Mounting type	Adhesive mount
Dimensions (mm)	25 x 25 x 7.7
Operating temperature	-40 °C to +85 °C

Antenna and electrical specifications

GPS - Ceramic Active Antenna

Standards	GPS/QZSS/Galileo
Frequency (MHz)	1575.42
Passive Gain (dBi)	~3.6
Impedance (Ohm)	50
Voltage Range (V)	3.0 - 5.0
Active Gain (dB)	25 @ 5.0 V
Noise Figure (dB)	2.5 @ 5.0 V
Current Consumption (mA)	20 @ 5.0 V
Power Consumption (mW)	100 @ 5.0 V
Saw Filter Type	Pre-Filter
Out of Band Rejection (dB)	43
ESD Protection (kV)	2

2JM0301F

GPS

Key Features

- ✔ 14 dB Gain
- ✔ Pre-Filter
- ✔ Low Noise Figure
- ✔ Low Power Consumption
- ✔ 18 × 18 × 6.8 mm

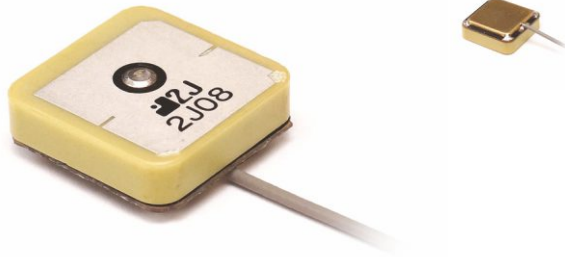

General specification

Mounting type	Adhesive mount
Dimensions (mm)	18 × 18 × 6.8
Operating temperature	-40 °C to +85 °C

Antenna and electrical specifications GPS - Ceramic Active Antenna

Standards	GPS/QZSS/Galileo
Frequency (MHz)	1575.42
Passive Gain (dBi)	~3.6
Impedance (Ohm)	50
Voltage Range (V)	1.5 - 3.6
Active Gain (dB)	14 @ 2.7 V
Noise Figure (dB)	1.5 @ 2.7 V
Current Consumption (mA)	4 @ 2.7 V
Power Consumption (mW)	10.8 @ 2.7 V
Saw Filter Type	Pre-Filter
Out of Band Rejection (dB)	43
ESD Protection (kV)	6

2JM0401F

GPS

Key Features

- ✔ 28 dB Gain
- ✔ Pre-Filter
- ✔ Low Noise Figure
- ✔ Low Power Consumption
- ✔ 18 × 18 × 6.5 mm

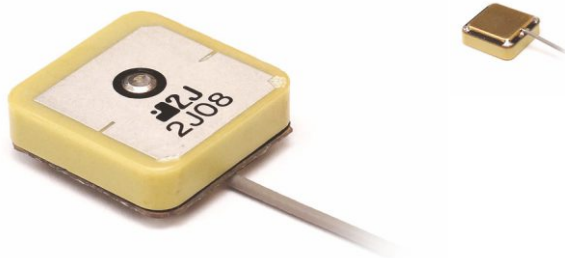

General specification

Mounting type	Adhesive mount
Dimensions (mm)	18 × 18 × 6.5
Operating temperature	-40 °C to +85 °C

Antenna and electrical specifications GPS - Ceramic Active Antenna

Standards	GPS/QZSS/Galileo
Frequency (MHz)	1575.42
Passive Gain (dBi)	~3.6
Impedance (Ohm)	50
Voltage Range (V)	1.5 - 3.6
Active Gain (dB)	28 @ 2.7 V
Noise Figure (dB)	1.8 @ 2.7 V
Current Consumption (mA)	9 @ 2.7 V
Power Consumption (mW)	24.3 @ 2.7 V
Saw Filter Type	Pre-Filter
Out of Band Rejection (dB)	43
ESD Protection (kV)	6

2JM0501F

GPS

Key Features

- ✔ 28 dB Gain
- ✔ Mid-Filter
- ✔ Low Noise Figure
- ✔ Low Power Consumption
- ✔ 18 × 18 × 6.5 mm

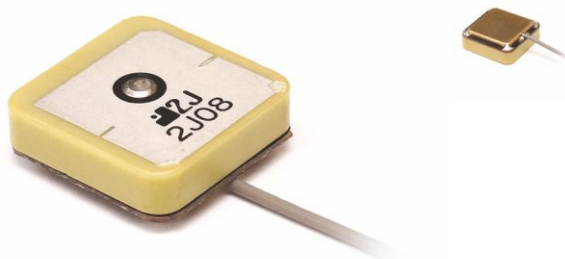

General specification

Mounting type	Adhesive mount
Dimensions (mm)	18 × 18 × 6.5
Operating temperature	-40 °C to +85 °C

Antenna and electrical specifications GPS - Ceramic Active Antenna

Standards	GPS/QZSS/Galileo
Frequency (MHz)	1575.42
Passive Gain (dBi)	~3.6
Impedance (Ohm)	50
Voltage Range (V)	1.5 - 3.6
Active Gain (dB)	28 @ 2.7 V
Noise Figure (dB)	1.0 @ 2.7 V
Current Consumption (mA)	9 @ 2.7 V
Power Consumption (mW)	24.3 @ 2.7 V
Saw Filter Type	Mid-Filter
Out of Band Rejection (dB)	43
ESD Protection (kV)	2

2JM0601F

GPS

Key Features

- ✓ 14 dB Gain
- ✓ Pre-Filter
- ✓ Low Noise Figure
- ✓ Low Power Consumption
- ✓ 25 x 25 x 7.6 mm

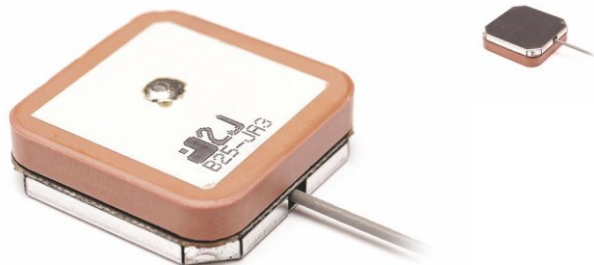

General specification

Mounting type	Adhesive mount
Dimensions (mm)	25 x 25 x 7.6
Operating temperature	-40 °C to +85 °C

Antenna and electrical specifications

GPS - Ceramic Active Antenna

Standards	GPS/QZSS/Galileo
Frequency (MHz)	1575.42
Passive Gain (dBi)	~3.6
Impedance (Ohm)	50
Voltage Range (V)	1.5 - 3.6
Active Gain (dB)	14 @ 2.7 V
Noise Figure (dB)	1.5 @ 2.7 V
Current Consumption (mA)	4 @ 2.7 V
Power Consumption (mW)	10.8 @ 2.7 V
Saw Filter Type	Pre-Filter
Out of Band Rejection (dB)	43
ESD Protection (kV)	6

2JM0701F

GPS

Key Features

- ✓ 28 dB Gain
- ✓ Pre-Filter
- ✓ Low Noise Figure
- ✓ Low Power Consumption
- ✓ 25 x 25 x 7.6 mm

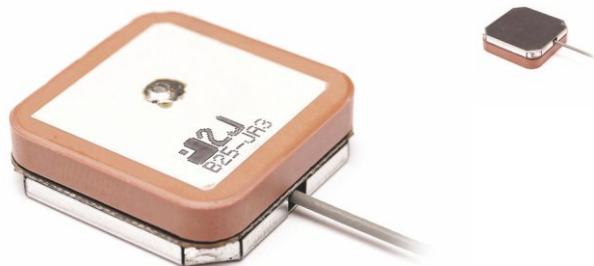

General specification

Mounting type	Adhesive mount
Dimensions (mm)	25 x 25 x 7.6
Operating temperature	-40 °C to +85 °C

Antenna and electrical specifications

GPS - Ceramic Active Antenna

Standards	GPS/QZSS/Galileo
Frequency (MHz)	1575.42
Passive Gain (dBi)	~3.6
Impedance (Ohm)	50
Voltage Range (V)	1.5 - 3.6
Active Gain (dB)	28 @ 2.7 V
Noise Figure (dB)	1.8 @ 2.7 V
Current Consumption (mA)	9 @ 2.7 V
Power Consumption (mW)	24.3 @ 2.7 V
Saw Filter Type	Pre-Filter
Out of Band Rejection (dB)	43
ESD Protection (kV)	6

2JM0801F

GPS

Key Features

- ✓ 28 dB Gain
- ✓ Mid-Filter
- ✓ Low Noise Figure
- ✓ Low Power Consumption
- ✓ 25 x 25 x 7.6 mm

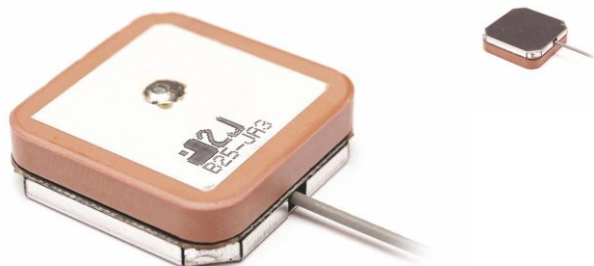

General specification

Mounting type	Adhesive mount
Dimensions (mm)	25 x 25 x 7.6
Operating temperature	-40 °C to +85 °C

Antenna and electrical specifications

GPS - Ceramic Active Antenna

Standards	GPS/QZSS/Galileo
Frequency (MHz)	1575.42
Passive Gain (dBi)	~3.6
Impedance (Ohm)	50
Voltage Range (V)	1.5 - 3.6
Active Gain (dB)	28 @ 2.7 V
Noise Figure (dB)	1.0 @ 2.7 V
Current Consumption (mA)	9 @ 2.7 V
Power Consumption (mW)	24.3 @ 2.7 V
Saw Filter Type	Mid-Filter
Out of Band Rejection (dB)	43
ESD Protection (kV)	2

2JF0102P Flexible antenna

2.4/5.0 GHz ISM

Key Features

- ✓ Flexi Embedded Antenna
- ✓ High Performance
- ✓ Self-Adhesive
- ✓ Customizable Cable and Connector



General specification

Mounting type	Adhesive mount
Dimensions (mm)	39.6x 8.4 x 0.1
Operating temperature	-40 °C to +85 °C

Antenna and electrical specifications

2.4/5.0 GHz ISM

Standards	WiFi, BT, ZigBee, ISM
Frequency (MHz)	2410-2490, 4920-5925
VSWR	~1.2:1, ~1.4:1
Peak Gain (dBi)	~2.2, ~3.8
Impedance (Ohm)	50
Polarisation	Linear
Max. Input Power (W)	25

2JP0102P

2.4/5.0 GHz ISM

Key Features

- ✓ Rigid Embedded Antenna
- ✓ High Performance
- ✓ Low Profile
- ✓ Self-Adhesive
- ✓ Customizable Cable and Connector

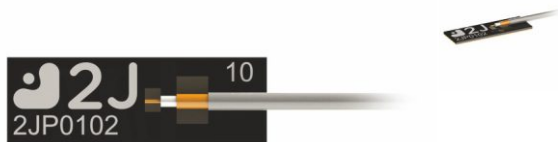

General specification

Mounting type	Adhesive mount
Dimensions (mm)	16.4 x 5.4 x 0.4
Operating temperature	-40 °C to +85 °C

Antenna and electrical specifications

2.4/5.0 GHz ISM

Standards	WiFi, BT, ZigBee, ISM
Frequency (MHz)	2410-2490, 4920-5925
VSWR	~2.4:1, ~2.2:1
Peak Gain (dBi)	~2.5, ~3.5
Impedance (Ohm)	50
Polarisation	Linear
Max. Input Power (W)	10

2JF0202P Flexible antenna

2.4/5.0 GHz ISM

Key Features

- ✓ Flexi Embedded Antenna
- ✓ High Performance
- ✓ Self-Adhesive
- ✓ Customizable Cable and Connector



General specification

Mounting type	Screw mount
Dimensions (mm)	30 x 30 x 0.2
Operating temperature	-40 °C to +85 °C

Antenna and electrical specifications

2.4/5.0 GHz ISM

Standards	WiFi, BT, ZigBee, ISM
Frequency (MHz)	2410-2490, 4920-5925
VSWR	~1.2:1, ~1.5:1
Peak Gain (dBi)	~4.4, ~6.7
Impedance (Ohm)	50
Polarisation	Linear
Max. Input Power (W)	25

2JF0215P

Flexible antenna

915 MHz ISM

Key Features

- ✔ Flexi Embedded Antenna
- ✔ Self-Adhesive
- ✔ Ground Plane Independent
- ✔ Customizable Cable and Connector



General specification

Mounting type	Adhesive mount
Dimensions (mm)	40 x 7.1 x 0.22
Operating temperature	-40 °C to +85 °C

Antenna and electrical specifications

915 MHz ISM

Standards	ZigBee, ISM, SIGFOX, LoRa
Frequency (MHz)	902-928
VSWR	~1.6:1
Peak Gain (dBi)	~-0.1
Impedance (Ohm)	50
Polarisation	Linear
Max. Input Power (W)	25

2JF0515P

Flexible antenna

915 MHz ISM

Key Features

- ✔ Flexi Embedded Antenna
- ✔ Self-Adhesive
- ✔ Customizable Cable and Connector



General specification

Mounting type	Adhesive mount
Dimensions (mm)	40.1 x 7.1 x 0.2
Operating temperature	-40 °C to +85 °C

Antenna and electrical specifications

915 MHz ISM

Standards	ZigBee, ISM, SIGFOX, LoRa
Frequency (MHz)	902-928
VSWR	~1.3:1
Peak Gain (dBi)	~0.3
Impedance (Ohm)	50
Polarisation	Linear
Max. Input Power (W)	25

2JP0215P

915 MHz ISM

Key Features

- ✔ Rigid Embedded Antenna
- ✔ Ground Plane Independent
- ✔ Self-Adhesive
- ✔ Customizable Cable and Connector



General specification

Mounting type	Adhesive mount
Dimensions (mm)	35.3 x 6.54 x 0.8
Operating temperature	-40 °C to +85 °C

Antenna and electrical specifications

915 MHz ISM

Standards	ZigBee, ISM, SIGFOX, LoRa
Frequency (MHz)	902-928
VSWR	~1.7:1
Peak Gain (dBi)	~-0.4
Impedance (Ohm)	50
Polarisation	Linear
Max. Input Power (W)	25

2JP0515P

915 MHz ISM

Key Features

- ✔ Rigid Embedded Antenna
- ✔ Ground Plane Independent
- ✔ Self-Adhesive
- ✔ Customizable Cable and Connector



General specification

Mounting type	Adhesive mount
Dimensions (mm)	35.4 x 6.8 x 0.8
Operating temperature	-40 °C to +85 °C

Antenna and electrical specifications

915 MHz ISM

Standards	ZigBee, ISM, SIGFOX, LoRa
Frequency (MHz)	902-928
VSWR	~1.3:1
Peak Gain (dBi)	~0.1
Impedance (Ohm)	50
Polarisation	Linear
Max. Input Power (W)	25

2JF0115P

Flexible antenna

868 MHz ISM

Key Features

- ✔ Flexi Embedded Antenna
- ✔ Self-Adhesive
- ✔ Ground Plane Independent
- ✔ Customizable Cable and Connector



General specification

Mounting type	Adhesive mount
Dimensions (mm)	35 x 6.6 x 0.2
Operating temperature	-40 °C to +85 °C

Antenna and electrical specifications

868 MHz ISM

Standards	ZigBee, ISM, SIGFOX, LoRa
Frequency (MHz)	863-870
VSWR	~1.9:1
Peak Gain (dBi)	~-0.8
Impedance (Ohm)	50
Polarisation	Linear
Max. Input Power (W)	25

2JP0115P

868 MHz ISM

Key Features

- ✔ Rigid Embedded Antenna
- ✔ Ground Plane Independent
- ✔ Self-Adhesive
- ✔ Customizable Cable and Connector



General specification

Mounting type	Adhesive mount
Dimensions (mm)	35 x 6.6 x 0.8
Operating temperature	-40 °C to +85 °C

Antenna and electrical specifications

868 MHz ISM

Standards	ZigBee, ISM, SIGFOX, LoRa
Frequency (MHz)	863-870
VSWR	~3.0:1
Peak Gain (dBi)	~-1.4
Impedance (Ohm)	50
Polarisation	Linear
Max. Input Power (W)	25

2JE15b 433 MHz ISM

Key Features

- ✔ Ground Plane Dependent
- ✔ High Gain
- ✔ Compact Size

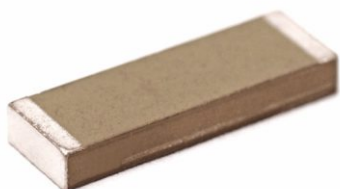

General specification

Mounting type	Surface mount
Dimensions (mm)	12 x 4 x 1.5
Operating temperature	-40 °C to +85 °C

Antenna and electrical specifications

433 MHz ISM

Standards	ISM, LoRa
Frequency (MHz)	433-435
VSWR	~1.5:1
Peak Gain (dBi)	~-10.3
Impedance (Ohm)	50
Polarisation	Linear
Max. Input Power (W)	20

2JCP2542601a

IRIDIUM

Key Features

- ✔ Ceramic Passive Antenna
- ✔ High Gain
- ✔ 25 x 25 x 4 mm

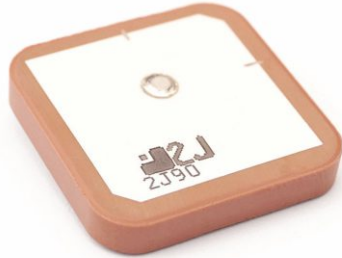

General specification

Mounting type	Thru-Hole mount
Dimensions (mm)	25 x 25 x 4
Operating temperature	-40 °C to +85 °C

Antenna and electrical specifications

IRIDIUM - Ceramic Passive Antenna

Standards	IRIDIUM
Frequency (MHz)	1616-1627
Passive Gain (dBi)	~5.1
Impedance (Ohm)	50
Axial Ratio (dB)	3 max
Radiation Pattern	Hemispherical
Polarization	RHCP

2JCP3642601a

IRIDIUM

Key Features

- ✔ Ceramic Passive Antenna
- ✔ High Gain
- ✔ 36 x 36 x 4 mm



General specification

Mounting type	Thru-Hole mount
Dimensions (mm)	36 x 36 x 4
Operating temperature	-40 °C to +85 °C

Antenna and electrical specifications

IRIDIUM - Ceramic Passive Antenna

Standards	IRIDIUM
Frequency (MHz)	1616-1627
Passive Gain (dBi)	~4.5
Impedance (Ohm)	50
Axial Ratio (dB)	3 max
Radiation Pattern	Hemispherical
Polarization	RHCP

2JF0302Pa

2-in-1 antenna Flexible antenna

2 × 2.4/5.0 GHz ISM MIMO

Key Features

- ✔ Flexi Embedded antenna
- ✔ Ground Plane Independent
- ✔ High Performance
- ✔ Self-Adhesive
- ✔ Compact Size
- ✔ Customizable Cable and Connector



General specification

Mounting type	Adhesive mount
Dimensions (mm)	25 x 20 x 0.2
Operating temperature	-40 °C to +85 °C

Antenna and electrical specifications

2.4/5.0 GHz ISM (Connection 1)

Standards	WiFi, BT, ZigBee, ISM
Frequency (MHz)	2410-2490, 4920-5925
VSWR	~2.4:1, ~2.2:1
Peak Gain (dBi)	~3.2, ~5.0
Impedance (Ohm)	50
Polarisation	Linear
Max. Input Power (W)	20

Antenna and electrical specifications

2.4/5.0 GHz ISM (Connection 2)

Standards	WiFi, BT, ZigBee, ISM
Frequency (MHz)	2410-2490, 4920-5925
VSWR	~2.4:1, ~2.2:1
Peak Gain (dBi)	~3.0, ~4.9
Impedance (Ohm)	50
Polarisation	Linear
Max. Input Power (W)	10

Development Kits & Boards



2JDK0201Ca-A28 GPS/GLONASS/BeiDou

Key Features

- ✔ Development Kit for GNSS
- ✔ Set of 6 patches to try on devices
- ✔ Thru-Hole Mount
- ✔ High Gain

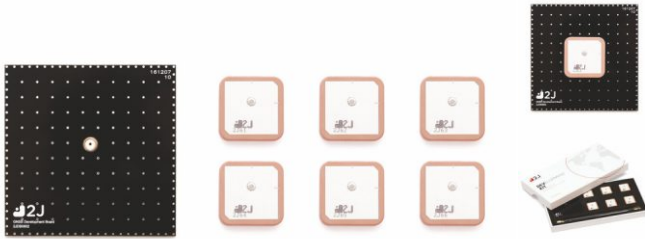

General specification

Mounting type	Thru-Hole mount
Dimensions (mm)	25 x 25 x 4 (Patches) 70.4 x 70.4 x 13.5 (Board)
Operating temperature	-40 °C to +85 °C

Antenna and electrical specifications GPS/GLONASS/BeiDou - Ceramic Passive Antenna

Standards	GPS/GLONASS/BeiDou/QZSS/Galileo
Frequency (MHz)	1561.098, 1575.42, 1598-1606 - Ceramic patch 2JCP2540101Ca (2J61) 1566.098, 1580.42, 1603-1611 - Ceramic patch 2JCP2540102Ca (2J62) 1571.098, 1585.42, 1608-1616 - Ceramic patch 2JCP2540103Ca (2J63) 1576.098, 1590.42, 1613-1621 - Ceramic patch 2JCP2540104Ca (2J64) 1581.098, 1595.42, 1618-1626 - Ceramic patch 2JCP2540105Ca (2J65) 1586.098, 1600.42, 1623-1631 - Ceramic patch 2JCP2540106Ca (2J66)
Passive Gain (dBi)	~4.2, ~4.5, ~5.0
Impedance (Ohm)	50
Radiation Pattern	Hemispherical
Polarization	RHCP

2JDK0301Ca-A28 GPS/GLONASS/BeiDou

Key Features

- ✔ Development Kit for GNSS
- ✔ Set of 6 patches to try on devices
- ✔ Thru-Hole Mount
- ✔ High Gain



General specification

Mounting type	Thru-Hole mount
Dimensions (mm)	36 x 36 x 4 (Patches) 70.4 x 70.4 x 13.5 (Board)
Operating temperature	-40 °C to +85 °C

Antenna and electrical specifications GPS/GLONASS/BeiDou - Ceramic Passive Antenna

Standards	GPS/GLONASS/BeiDou/QZSS/Galileo
Frequency (MHz)	1561.098, 1575.42, 1598-1606 - Ceramic patch 2JCP3640101Ca (2J46) 1566.098, 1580.42, 1603-1611 - Ceramic patch 2JCP3640102Ca (2J47) 1571.098, 1585.42, 1608-1616 - Ceramic patch 2JCP3640103Ca (2J48) 1576.098, 1590.42, 1613-1621 - Ceramic patch 2JCP3640104Ca (2J49) 1581.098, 1595.42, 1618-1626 - Ceramic patch 2JCP3640105Ca (2J50) 1586.098, 1600.42, 1623-1631 - Ceramic patch 2JCP3640106Ca (2J51)
Passive Gain (dBi)	~4.0, ~3.8, ~4.1
Impedance (Ohm)	50
Radiation Pattern	Hemispherical
Polarization	RHCP

2JDK0401Ga-A28

GPS/GLONASS

Key Features

- Development Kit for GNSS
- Set of 6 patches to try on devices
- Thru-Hole Mount
- High Gain

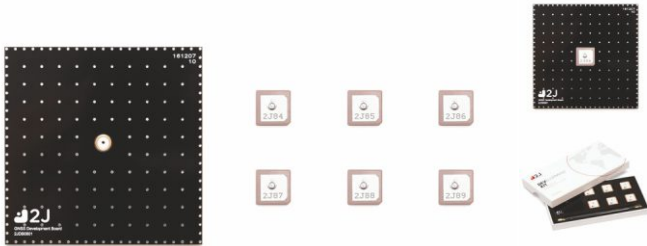

General specification

Mounting type	Thru-Hole mount
Dimensions (mm)	13 x 13 x 4 (Patches) 70.4 x 70.4 x 13.5 (Board)
Operating temperature	-40 °C to +85 °C

Antenna and electrical specifications GPS/GLONASS - Ceramic Passive Antenna

Standards	GPS/GLONASS/QZSS/Galileo
Frequency (MHz)	1575.42, 1598-1606 - Ceramic patch 2JCP1340101Ga (2J84) 1580.42, 1603-1611 - Ceramic patch 2JCP1340102Ga (2J85) 1585.42, 1608-1616 - Ceramic patch 2JCP1340103Ga (2J86) 1590.42, 1613-1621 - Ceramic patch 2JCP1340104Ga (2J87) 1595.42, 1618-1626 - Ceramic patch 2JCP1340105Ga (2J88) 1600.42, 1623-1631 - Ceramic patch 2JCP1340106Ga (2J89)
Passive Gain (dBi)	~3.5, ~3.1
Impedance (Ohm)	50
Radiation Pattern	Hemispherical

2JDK0101Ga-A28

GPS/GLONASS

Key Features

- Development Kit for GNSS
- Set of 6 patches to try on devices
- Thru-Hole Mount
- High Gain

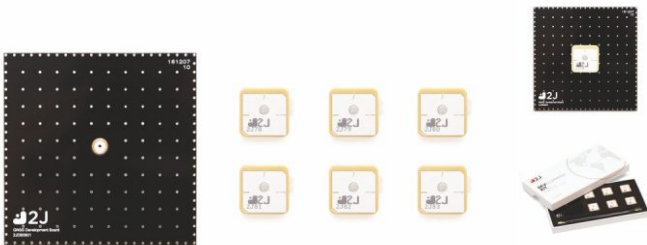

General specification

Mounting type	Thru-Hole mount
Dimensions (mm)	18 x 18 x 4 (Patches) 70.4 x 70.4 x 13.5 (Board)
Operating temperature	-40 °C to +85 °C

Antenna and electrical specifications GPS/GLONASS - Ceramic Passive Antenna

Standards	GPS/GLONASS/QZSS/Galileo
Frequency (MHz)	1575.42, 1598-1606 - Ceramic patch 2JCP1840101Ga (2J78) 1580.42, 1603-1611 - Ceramic patch 2JCP1840102Ga (2J79) 1585.42, 1608-1616 - Ceramic patch 2JCP1840103Ga (2J80) 1590.42, 1613-1621 - Ceramic patch 2JCP1840104Ga (2J81) 1595.42, 1618-1626 - Ceramic patch 2JCP1840105Ga (2J82) 1600.42, 1623-1631 - Ceramic patch 2JCP1840106Ga (2J83)
Passive Gain (dBi)	~4.1, ~4.2
Impedance (Ohm)	50
Radiation Pattern	Hemispherical

2JDK0201Ga-A28

GPS/GLONASS

Key Features

- Development Kit for GNSS
- Set of 6 patches to try on devices
- Thru-Hole Mount
- High Gain



General specification

Mounting type	Thru-Hole mount
Dimensions (mm)	25 x 25 x 4 (Patches) 70.4 x 70.4 x 13.5 (Board)
Operating temperature	-40 °C to +85 °C

Antenna and electrical specifications GPS/GLONASS - Ceramic Passive Antenna

Standards	GPS/GLONASS/QZSS/Galileo
Frequency (MHz)	1575.42, 1598-1606 - Ceramic patch 2JCP2540101Ga (2J40) 1580.42, 1603-1611 - Ceramic patch 2JCP2540102Ga (2J41) 1585.42, 1608-1616 - Ceramic patch 2JCP2540103Ga (2J42) 1590.42, 1613-1621 - Ceramic patch 2JCP2540104Ga (2J43) 1595.42, 1618-1626 - Ceramic patch 2JCP2540105Ga (2J44) 1600.42, 1623-1631 - Ceramic patch 2JCP2540106Ga (2J45)
Passive Gain (dBi)	~3.6, ~3.9
Impedance (Ohm)	50
Radiation Pattern	Hemispherical

2JDK0101a-A28

GPS

Key Features

- ✔ Development Kit for GNSS
- ✔ Set of 6 patches to try on devices
- ✔ Thru-Hole Mount
- ✔ High Gain

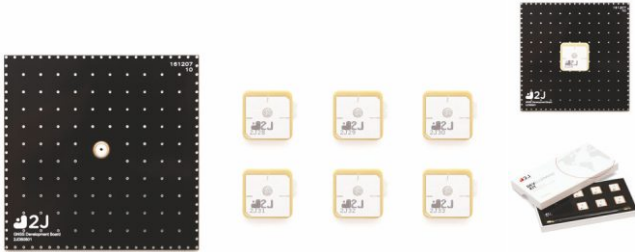

General specification

Mounting type	Thru-Hole mount
Dimensions (mm)	18 x 18 x 4 (Patches) 70.4 x 70.4 x 13.5 (Board)
Operating temperature	-40 °C to +85 °C

Antenna and electrical specifications GPS - Ceramic Passive Antenna

Standards	GPS/QZSS/Galileo
Frequency (MHz)	1575.42 - Ceramic patch 2JCP1840101a (2J28) 1580.42 - Ceramic patch 2JCP1840102a (2J29) 1585.42 - Ceramic patch 2JCP1840103a (2J30) 1590.42 - Ceramic patch 2JCP1840104a (2J31) 1595.42 - Ceramic patch 2JCP1840105a (2J32) 1600.42 - Ceramic patch 2JCP1840106a (2J33)
Passive Gain (dBi)	~3.6
Impedance (Ohm)	50
Radiation Pattern	Hemispherical
Polarization	RHCP

2JDK0201a-A28

GPS

Key Features

- ✔ Development Kit for GNSS
- ✔ Set of 6 patches to try on devices
- ✔ Thru-Hole Mount
- ✔ High Gain



General specification

Mounting type	Thru-Hole mount
Dimensions (mm)	25 x 25 x 4 (Patches) 70.4 x 70.4 x 13.5 (Board)
Operating temperature	-40 °C to +85 °C

Antenna and electrical specifications GPS - Ceramic Passive Antenna

Standards	GPS/QZSS/Galileo
Frequency (MHz)	1575.42 - Ceramic patch 2JCP2540101a (2J34) 1580.42 - Ceramic patch 2JCP2540102a (2J35) 1585.42 - Ceramic patch 2JCP2540103a (2J36) 1590.42 - Ceramic patch 2JCP2540104a (2J37) 1595.42 - Ceramic patch 2JCP2540105a (2J38) 1600.42 - Ceramic patch 2JCP2540106a (2J39)
Passive Gain (dBi)	~3.9
Impedance (Ohm)	50
Radiation Pattern	Hemispherical
Polarization	RHCP

2JDK0226a-A28

IRIDIUM

Key Features

- ✔ Development Kit for IRIDIUM
- ✔ Set of 6 patches to try on devices
- ✔ Thru-Hole Mount
- ✔ High Gain



General specification

Mounting type	Thru-Hole mount
Dimensions (mm)	25 x 25 x 4 (Patches) 70.4 x 70.4 x 13.5 (Board)
Operating temperature	-40 °C to +85 °C

Antenna and electrical specifications IRIDIUM - Ceramic Passive Antenna

Standards	IRIDIUM
Frequency (MHz)	1616-1627 - Ceramic patch 2JCP2542601a (2J90) 1621-1632 - Ceramic patch 2JCP2542602a (2J91) 1626-1637 - Ceramic patch 2JCP2542603a (2J92) 1631-1642 - Ceramic patch 2JCP2542604a (2J93) 1636-1647 - Ceramic patch 2JCP2542605a (2J94) 1641-1652 - Ceramic patch 2JCP2542606a (2J95)
Passive Gain (dBi)	~5.1
Impedance (Ohm)	50
Radiation Pattern	Hemispherical
Polarization	RHCP

2JDK0126a-A28

IRIDIUM

Key Features

- ✔ Development Kit for IRIDIUM
- ✔ Set of 6 patches to try on devices
- ✔ Thru-Hole Mount
- ✔ High Gain



General specification

Mounting type	Thru-Hole mount
Dimensions (mm)	36 x 36 x 4 (Patches) 70.4 x 70.4 x 13.5 (Board)
Operating temperature	-40 °C to +85 °C

Antenna and electrical specifications IRIDIUM - Ceramic Passive Antenna

Standards	IRIDIUM
Frequency (MHz)	1616-1627 - Ceramic patch 2JCP3642601a (2J52) 1621-1632 - Ceramic patch 2JCP3642602a (2J53) 1626-1637 - Ceramic patch 2JCP3642603a (2J54) 1631-1642 - Ceramic patch 2JCP3642604a (2J55) 1636-1647 - Ceramic patch 2JCP3642605a (2J56) 1641-1652 - Ceramic patch 2JCP3642606a (2J57)
Passive Gain (dBi)	~4.5
Impedance (Ohm)	50
Radiation Pattern	Hemispherical
Polarization	RHCP

2JDB0203-C831G

3G/2G

Key Features

- ✓ Flange SMA-Female Board Connector
- ✓ Ground Plane of 95x40 mm



General specification

Mounting type	Connector mount
Dimensions (mm)	104.89 × 40.4 × 13.85
Operating temperature	-40 °C to +85 °C
Usage	2G/3G Cellular Antennas: 2G, CDMA, GPRS, 3G, WCDMA, HSPA, etc.

Development Board for Connector Mount Antennas

2JDB0202-C831G

4G LTE/3G/2G

Key Features

- ✓ Flange SMA-Female Board Connector
- ✓ Ground Plane of 115x45 mm

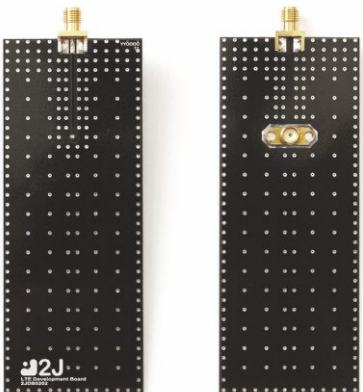

General specification

Mounting type	Connector mount
Dimensions (mm)	124.89 × 45.41 × 13.81
Operating temperature	-40 °C to +85 °C
Usage	2G/3G/4G LTE Cellular Antennas: 2G, CDMA, GPRS, 3G, WCDMA, HSPA, 4G LTE, etc.

Development Board for Connector Mount Antennas

2JDB0204-C831G

GPS/GLONASS/BeiDou

Key Features

- ✓ Flange SMA-Female Board Connector
- ✓ Ground Plane of 83x40 mm

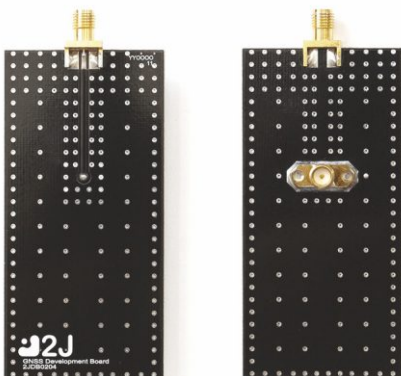

General specification

Mounting type	Connector mount
Dimensions (mm)	92.89 × 40.4 × 13.81
Operating temperature	-40 °C to +85 °C
Usage	GNSS Antennas: GPS, GLONASS, BeiDou, Galileo and QZSS

Development Board for Connector Mount Antennas

2JDB0205-C477GB

2.4/5.0 GHz ISM

Key Features

- ✓ Flange SMA-Female Board Connector
- ✓ Ground Plane of 70x35 mm

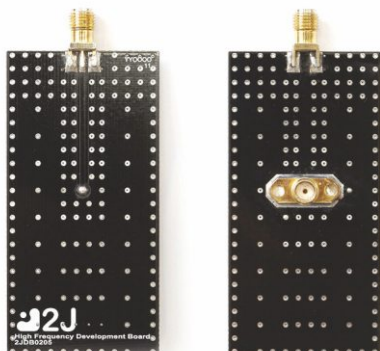

General specification

Mounting type	Connector mount
Dimensions (mm)	79.89 × 35.4 × 13.81
Operating temperature	-40 °C to +85 °C
Usage	High Frequency Connector Mount Antennas: 2.4, 3.5 and 5.0 GHz

Development Board
for Connector Mount Antennas

2JDB0201-C831G

169, 433, 450 MHz, 380-500 MHz TETRA, ORBCOMM...

Key Features

- ✓ Flange SMA-Female Board Connector
- ✓ Ground Plane of 150x50 mm

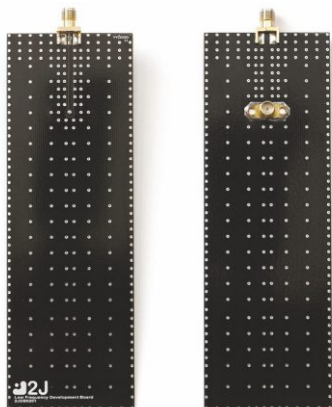

General specification

Mounting type	Connector mount
Dimensions (mm)	159.89 × 50.4 × 13.81
Operating temperature	-40 °C to +85 °C
Usage	Low Frequency Connector Mount Antennas: 169, 433, 450 MHz, TETRA, ORBCOMM, etc.

Development Board
for Connector Mount Antennas

Cable assemblies, connectors

Example of cable assemblies

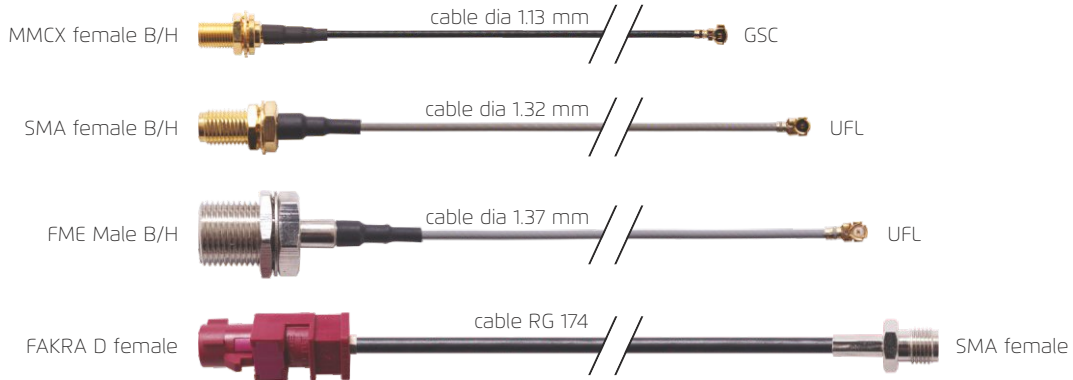

Standard connectors and cable types

<ul style="list-style-type: none"> SMA-Male SMA-Female SMA-Male R/A SMA-Female R/A SMA-Male RP SMA-Female RP SMA-Male RP R/A SMA-Female Bulkhead FME-Male FME-Female FME-Male Bulkhead FME-Female R/A MCX-Male MCX-Female MCX-Male R/A MCX-Female R/A MMCX F-Male F-Female N-Male N-Female N-Female Bulkhead SMB-Male SMB-Female SMB-Female B/H SMB-Female R/A TNC-Male TNC-Female TNC-Male RP TNC-Female Bulkhead SMC-Male SMC-Female SMC-Male R/A SMC-Female Bulkhead BNC-Male BNC-Female FAKRA all types U.FL H.FL W.FL GSC 	<ul style="list-style-type: none"> RG174 RX174 RG174HF RG174LL RG174TWIN RG178 RG223 RG316 RG58 RG6 LMR100 LMR195 Enviroflex 316 D H155 LEONI DACAR100 LEONI DACAR302 Microcoax 0.81 Microcoax 1.13 Microcoax 1.37 	<ul style="list-style-type: none"> SMA-Male SMA-Female SMA-Male R/A SMA-Female R/A SMA-Male RP SMA-Female RP SMA-Male RP R/A SMA-Female Bulkhead FME-Male FME-Female FME-Male Bulkhead FME-Female R/A MCX-Male MCX-Female MCX-Male R/A MCX-Female R/A MMCX F-Male F-Female N-Male N-Female N-Female Bulkhead SMB-Male SMB-Female SMB-Female B/H SMB-Female R/A TNC-Male TNC-Female TNC-Male RP TNC-Female Bulkhead SMC-Male SMC-Female SMC-Male R/A SMC-Female Bulkhead BNC-Male BNC-Female FAKRA all types U.FL H.FL W.FL GSC
--	--	--

Specific cable assembly available as per request. Please contact our sales support.

2J Antennas reserves all rights
to this document and the information contained herein.

Data shown in this document are estimated only and do not constitute
a warranty of guarantee of product performance or services.

2J Antennas



2J s.r.o

Stefanikova 61
085 01 Bardejov
Slovakia

☎ +421 54 4880130
✉ sales@2j-antennae.com
🌐 www.2j-antennae.com

2J UK Ltd.

21-22 The Slipway
Marina Keep, Port Solent
Hampshire, PO6 4TR, **United Kingdom**

☎ +44 (0)2392 385985
✉ salesuk@2j-antennae.com
🌐 www.2j-antennae.com

2J Antennas USA, Corp

5744 Pacific Center Blvd
Suite 311
San Diego, CA 92121, **USA**

☎ +1 (858) 465-6262
✉ sales@2j-antennasusa.com
🌐 www.2j-antennasusa.com