

2J7724Ba

CELLULAR/LTE MIMO Screw Mount

Key Features

Cable 1 - 2: CELLULAR / LTE

- 698-960 MHz
- 1710-2170 MHz
- 2500-2700 MHz

Screw Mount

High Performance

Ground Plane Dependent

Customizable Cable and Connector

Dimensions: Ø 60 x 69 mm

Certificates IP67, IP69, IK09



1. Antenna and electrical specifications

Cable 1

Parameters	CELLULAR / LTE Antenna		
Standards	2G,3G and 4G		
Band (MHz)	700/850/900	1700/1800/1900/2100	2600
Frequency (MHz)	698-960	1710-2170	2500-2700
Return Loss (dB)	~-6.9	~-15.3	~-16.7
VSWR	~2.9:1	~1.4:1	~1.4:1
Efficiency (%)	~37.8	~53.3	~54.9
Peak Gain (dBi)	~-0.8	~3.6	~4.1
Average Gain (dB)	~-4.3	~-2.7	~-2.6
Impedance (Ohm)	50		
Polarisation	Linear		
Radiation Pattern	Omni-Directional		
Max. Input Power (W)	25		
Connector Type	SMA-Male Standard (Other Connectors Available)		
Cable Length	300 cm Standard (Any Cable Length Available)		
Cable Type	LL100 Standard (Other Cables Available)		

Cable 2

Parameters	CELLULAR / LTE Antenna		
Standards	2G,3G and 4G		
Band (MHz)	700/850/900	1700/1800/1900/2100	2600
Frequency (MHz)	698-960	1710-2170	2500-2700
Return Loss (dB)	~-6.8	~-14.3	~-9.3
VSWR	~2.8:1	~1.5:1	~2.1:1
Efficiency (%)	~38.7	~52.3	~42.1
Peak Gain (dBi)	~-0.6	~2.9	~3.0
Average Gain (dB)	~-4.2	~-2.8	~-3.8
Impedance (Ohm)	50		
Polarisation	Linear		
Radiation Pattern	Omni-Directional		
Max. Input Power (W)	25		
Connector Type	SMA-Male Standard (Other Connectors Available)		
Cable Length	300 cm Standard (Any Cable Length Available)		
Cable Type	LL100 Standard (Other Cables Available)		

Antenna Measurement Conditions:

Mounted on 30 x 30 cm Ground Plane

200 cm of Cable LL100

Measured in Certified CTIA 3D Anechoic Chamber

2. Mechanical and environmental specifications

Specifications	2J7724Ba
Mounting Type	Screw Mount
Dimensions (mm)	Ø 60 x 69
Max. Tighten Torque (Nm)	6 Nm
Radome Type	PC/ABS UV Stable
Radome Color	Black
Antenna Base	Zamak
Gasket	TPE
Operating Temperature (C)	-40 to +85
Storage Temperature (C)	-40 to +85
Substance Compliance	RoHS
Certificates	IP67, IP69, IK09

3. Antenna parameters

Table 1: CELLULAR/LTE

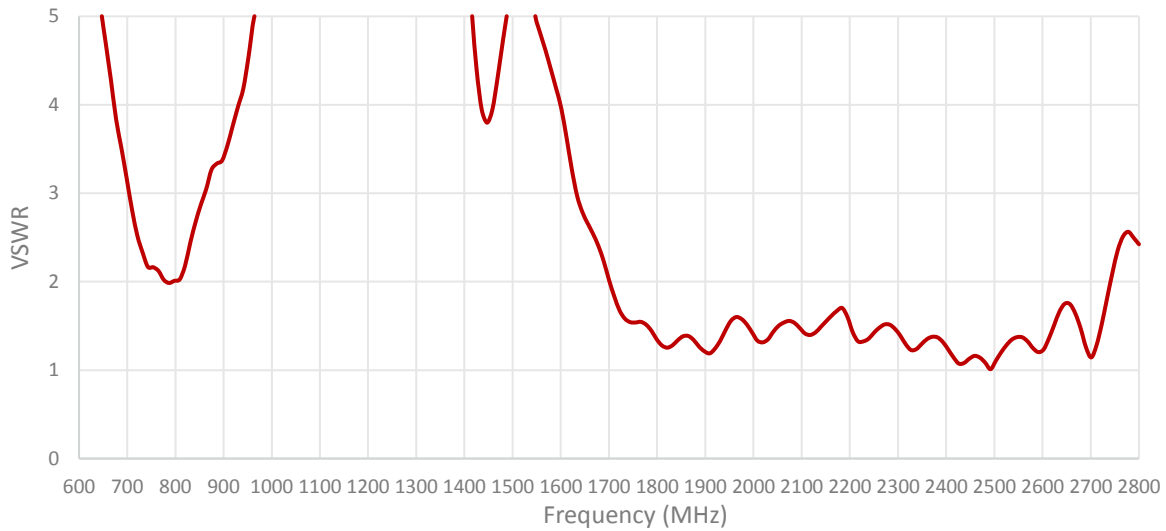
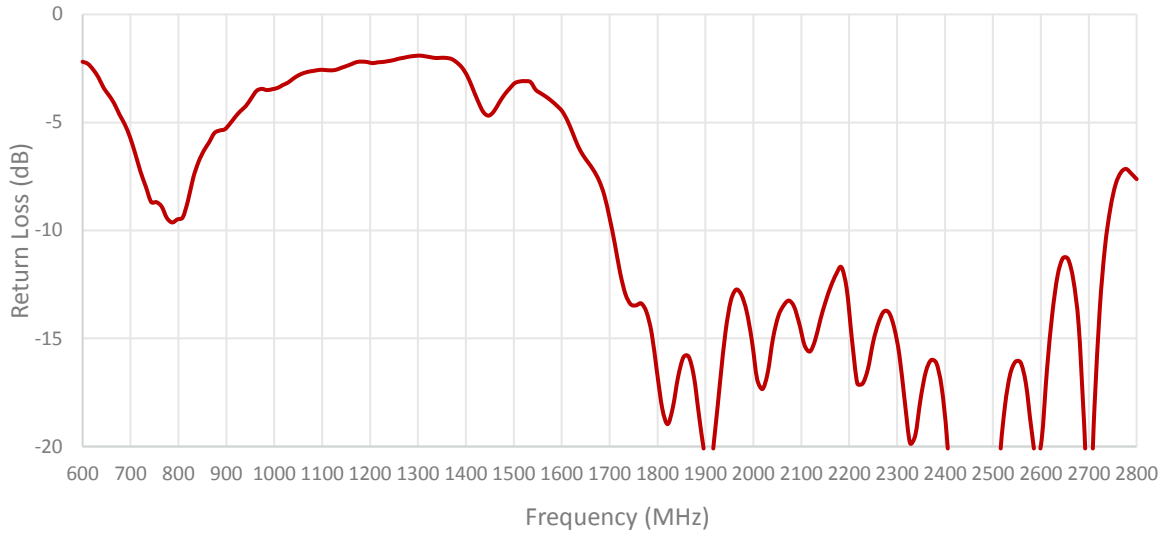

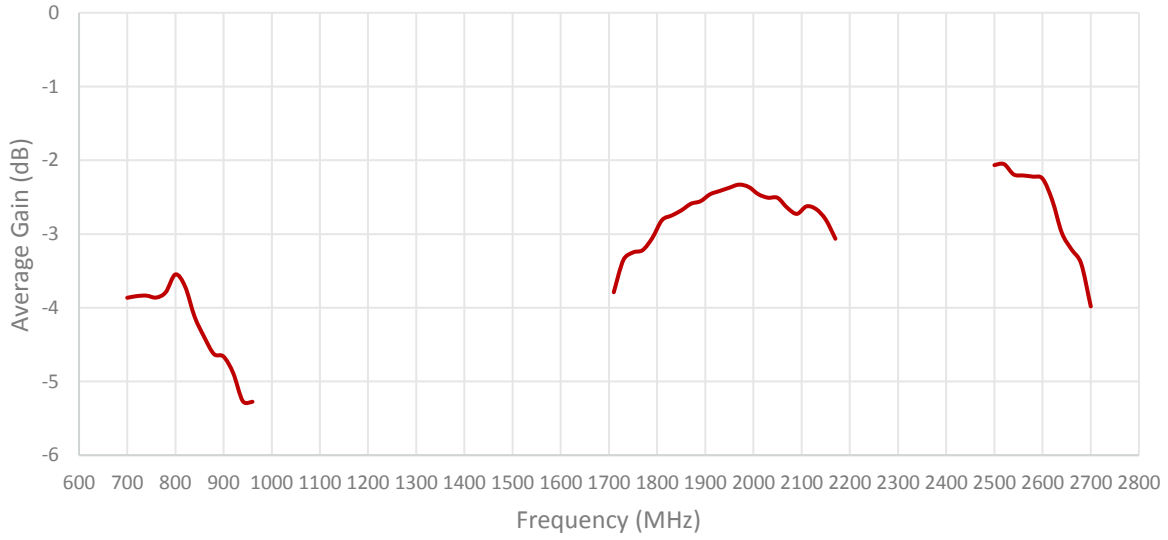
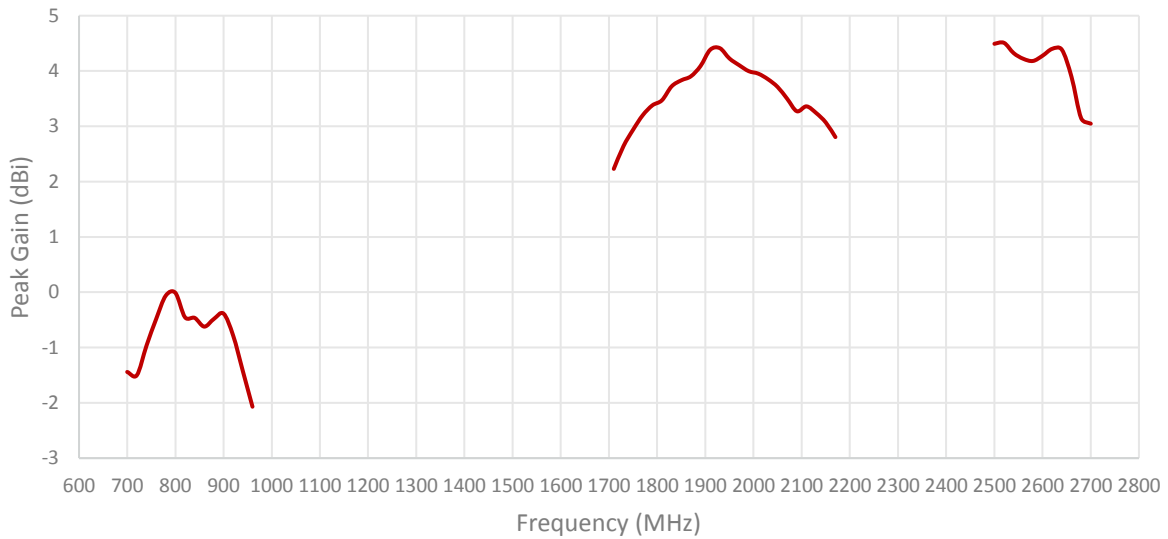
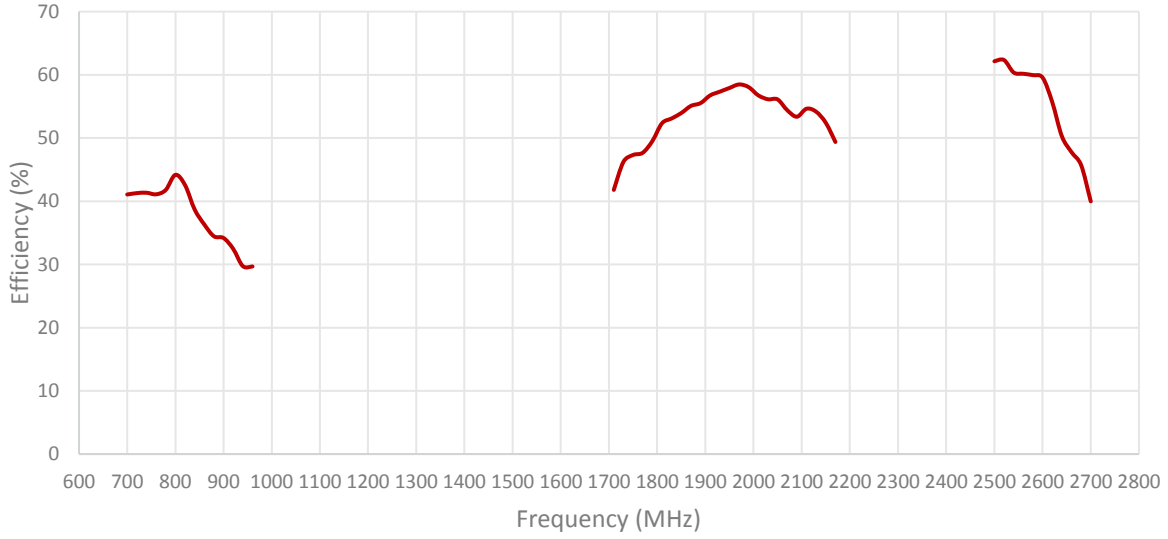
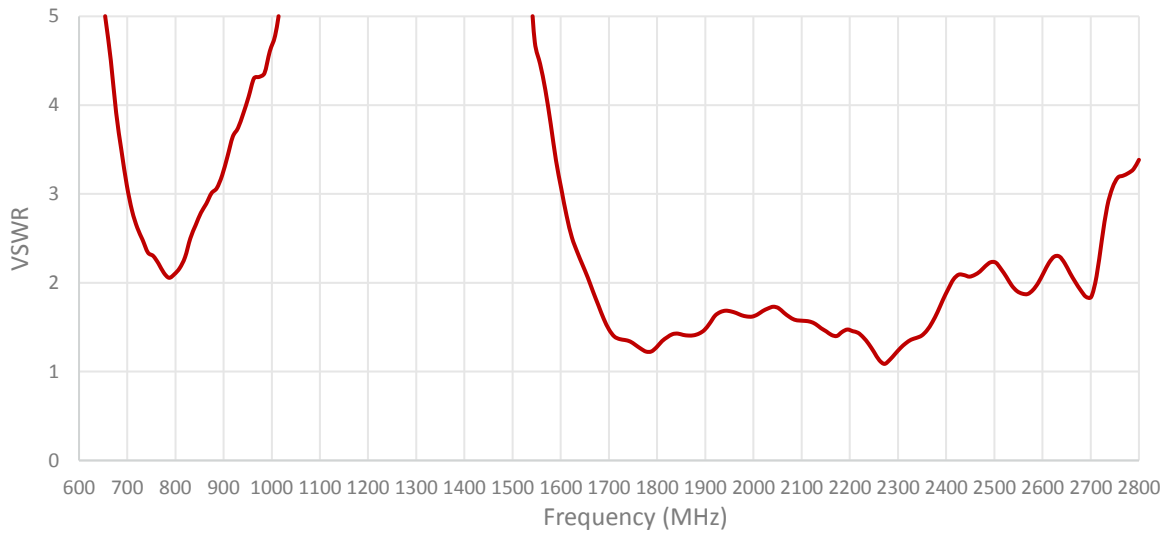
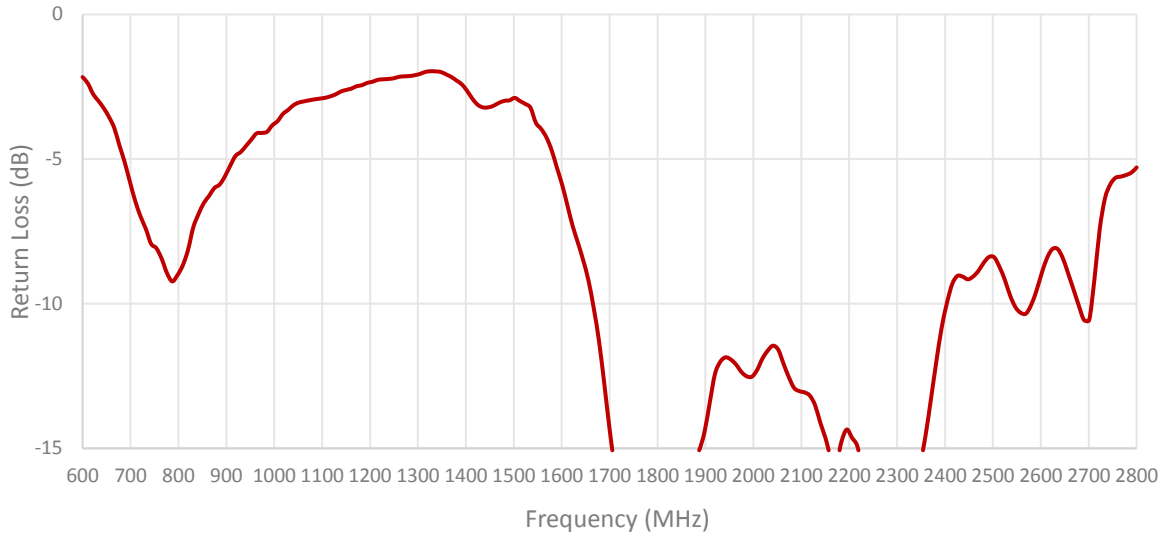
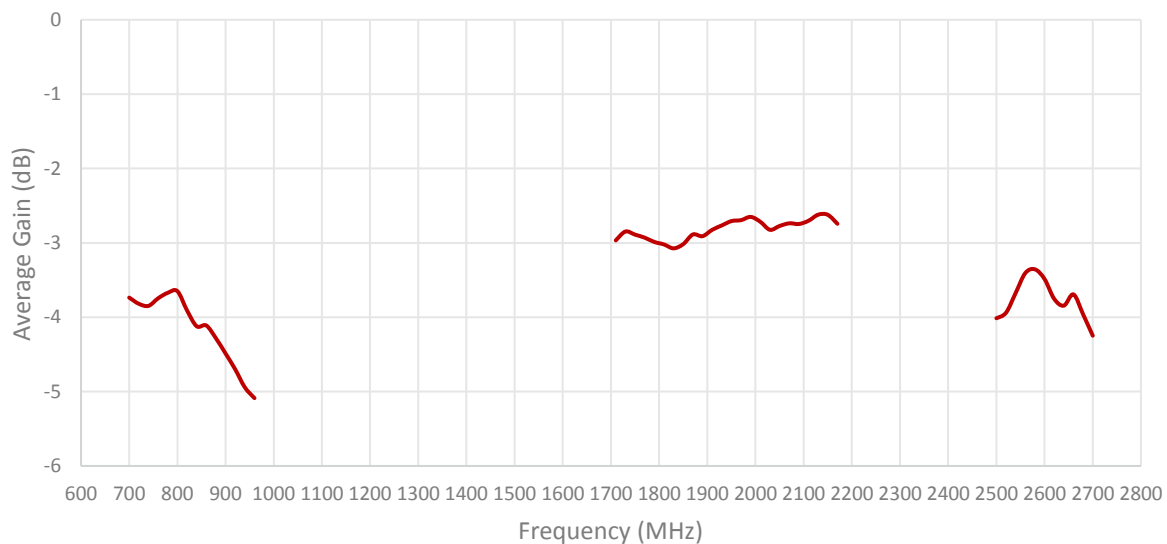
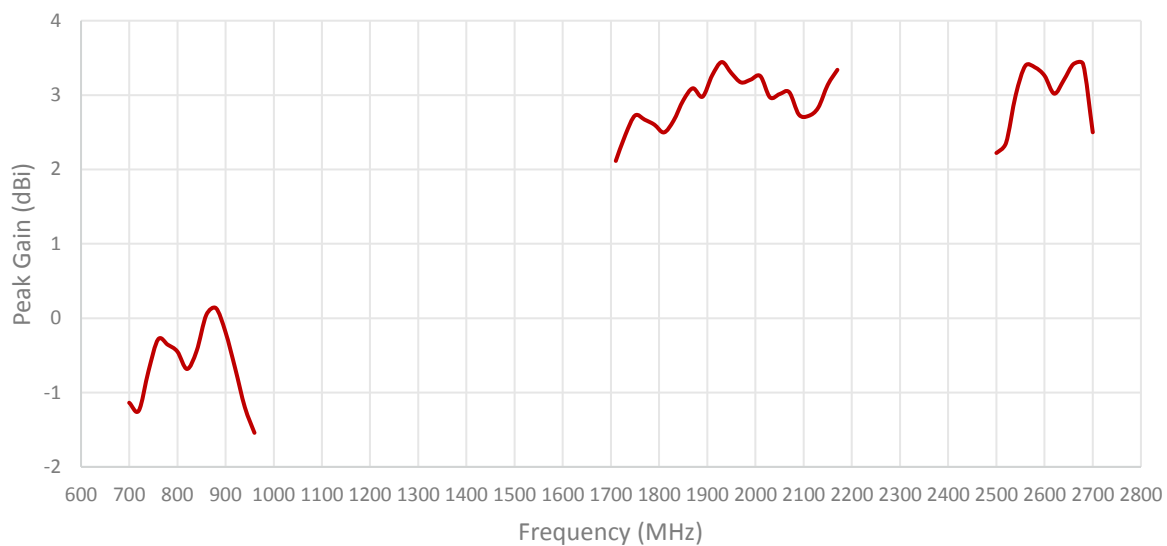
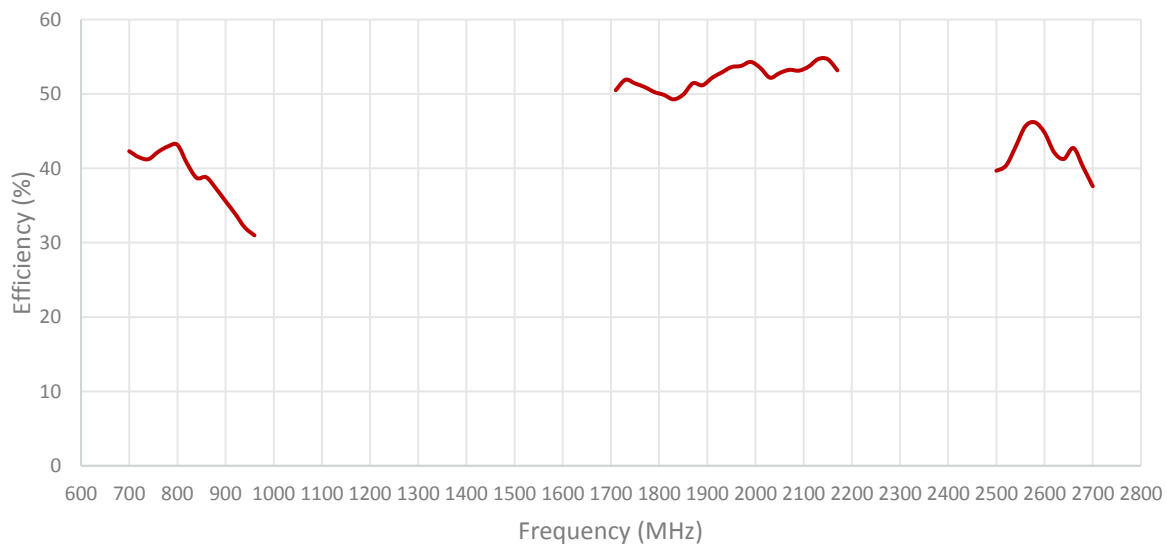
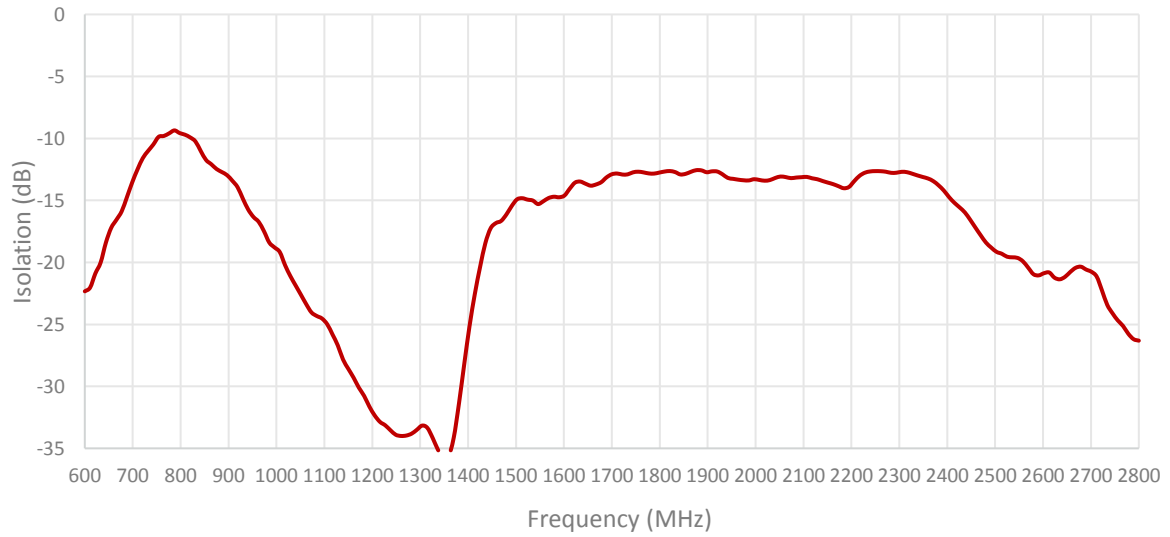

Table 2: CELLULAR/LTE





ISOLATION FOR CABLES 1 AND 2



ENVELOPE CORRELATION COEFFICIENT FOR CABLES 1 AND 2

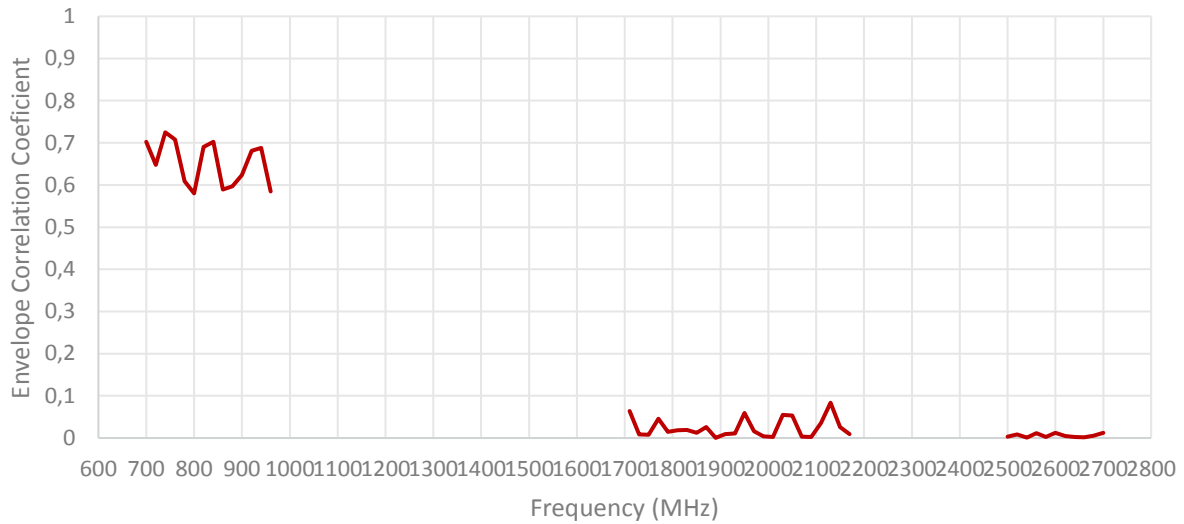

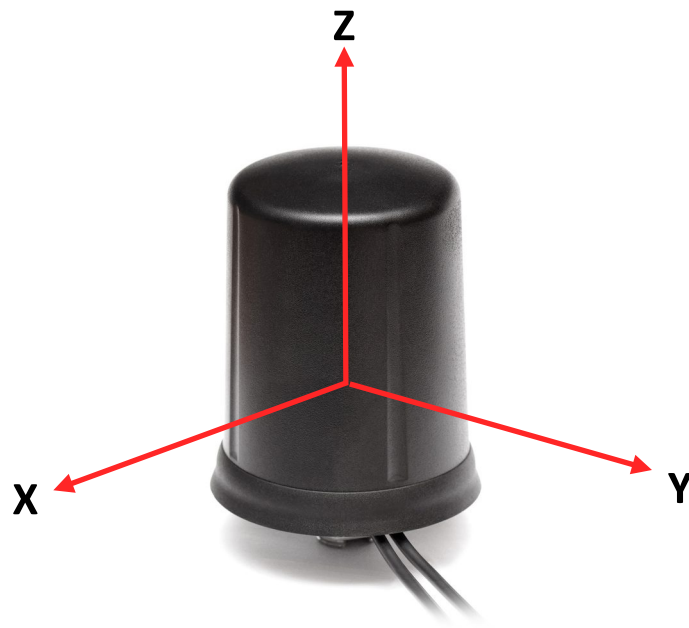

Radiation pattern reference

Cable 1: CELLULAR/LTE

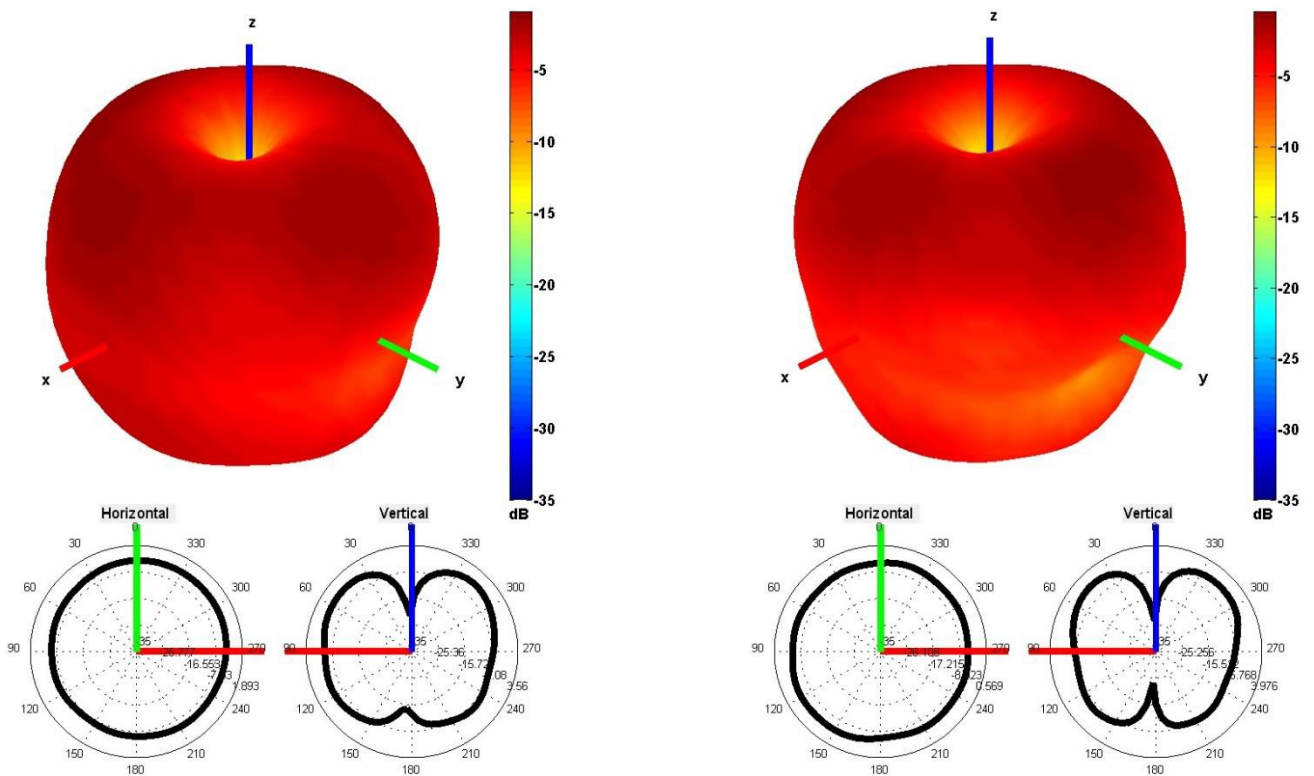

750 and 850 MHz Radiation pattern

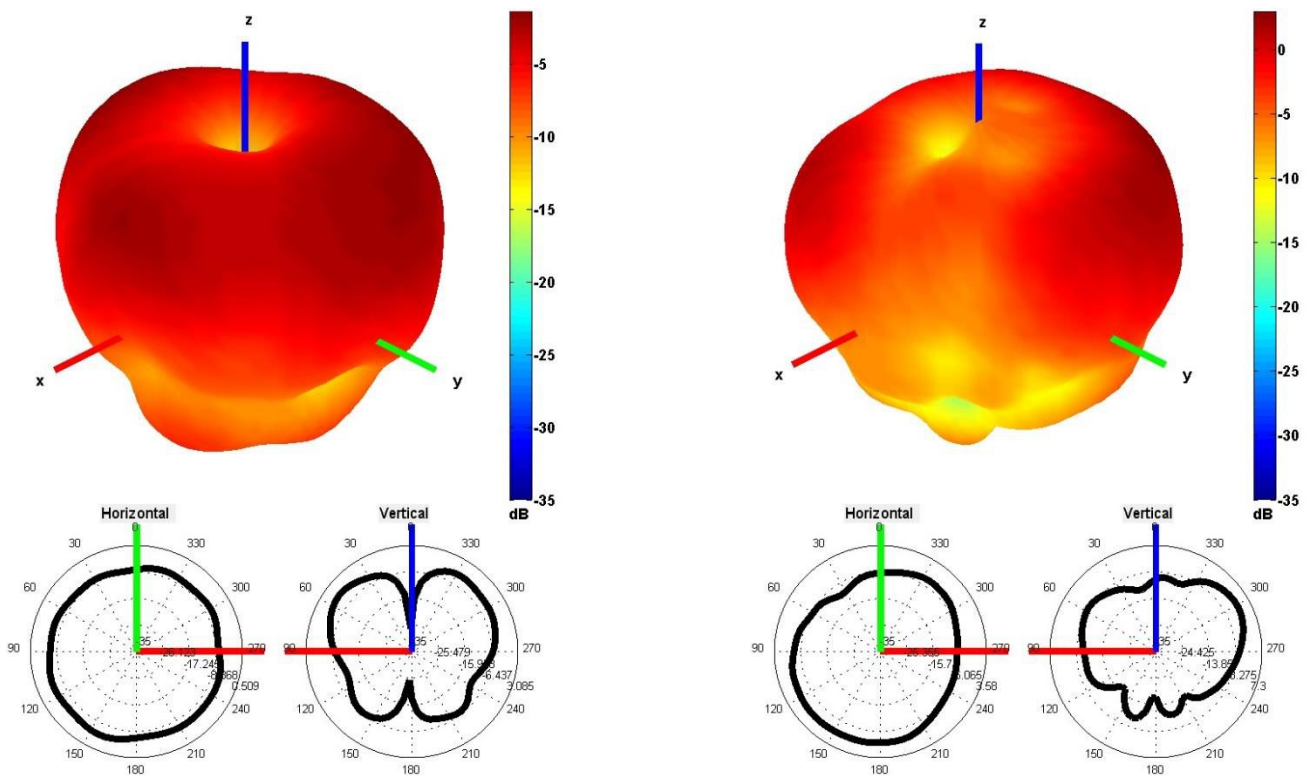

940 and 1750 MHz Radiation pattern

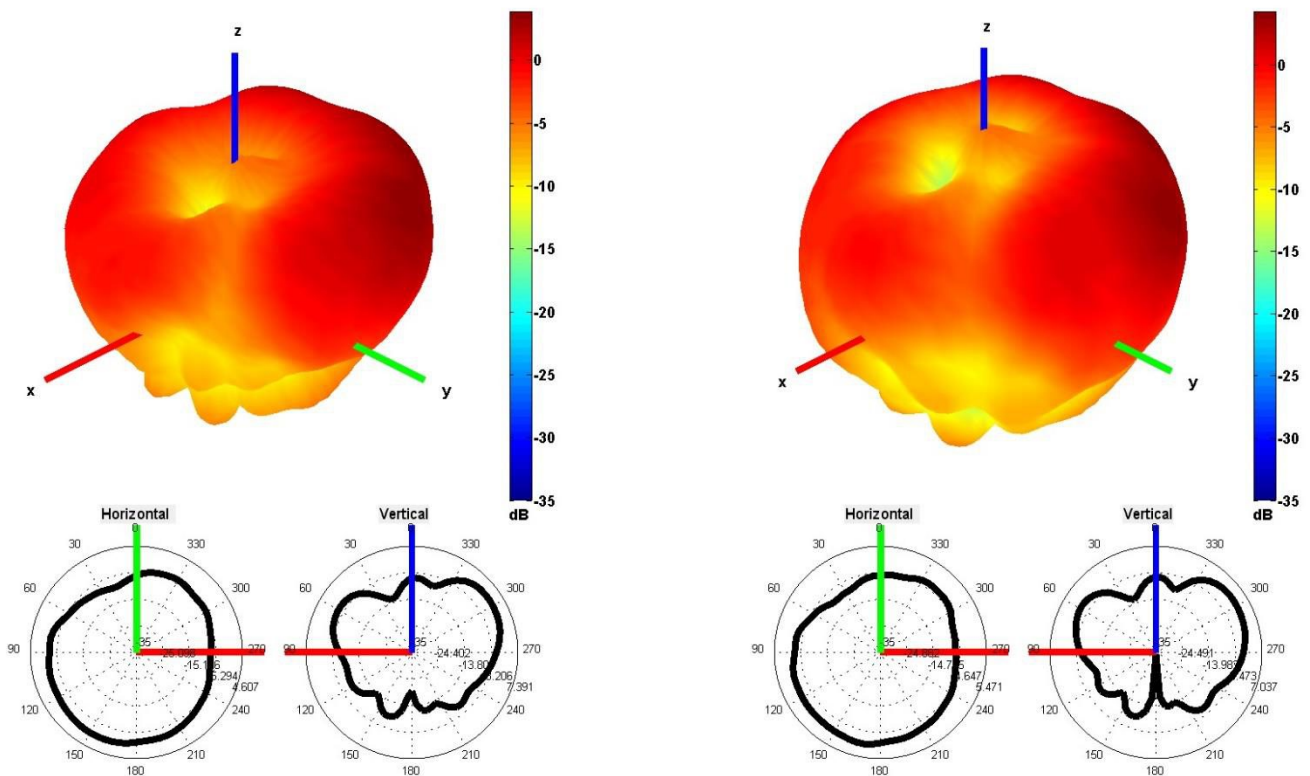

1850 and 1950 MHz Radiation pattern

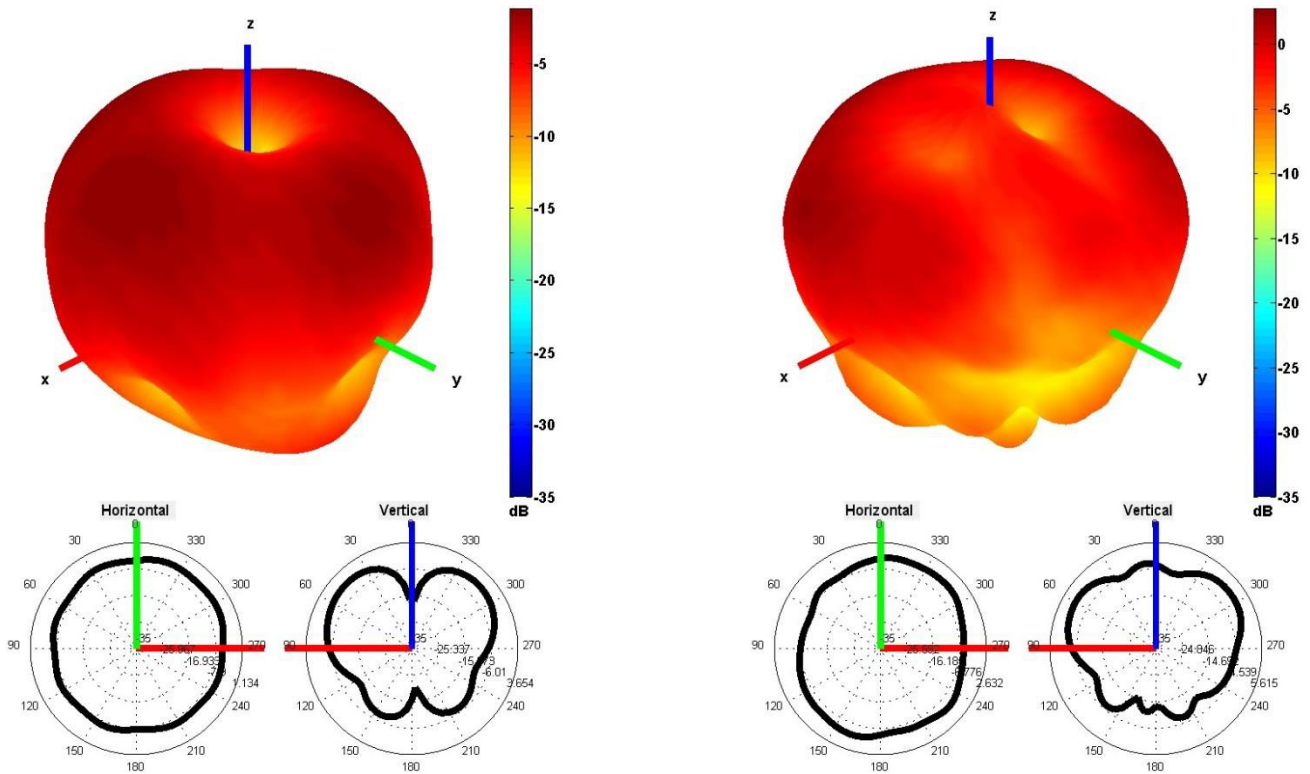

940 and 1750 MHz Radiation pattern

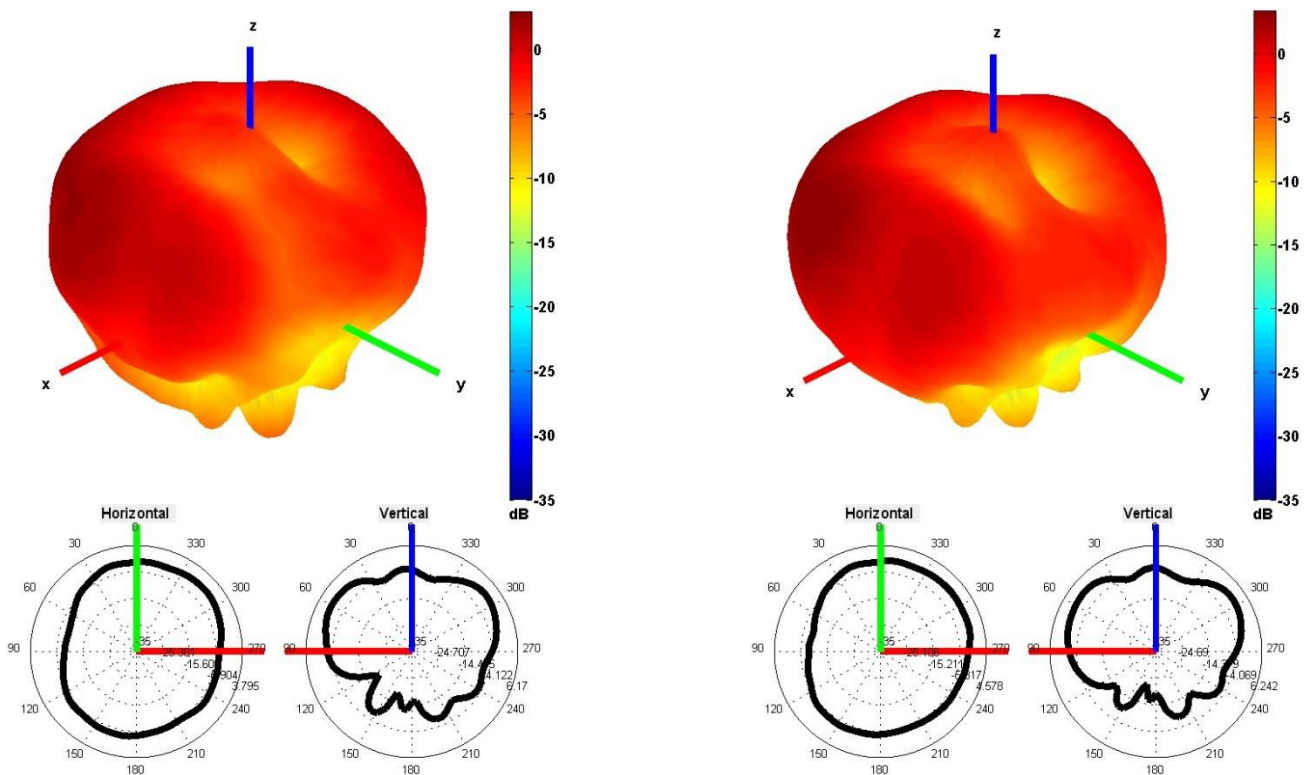

1850 and 1950 MHz Radiation pattern

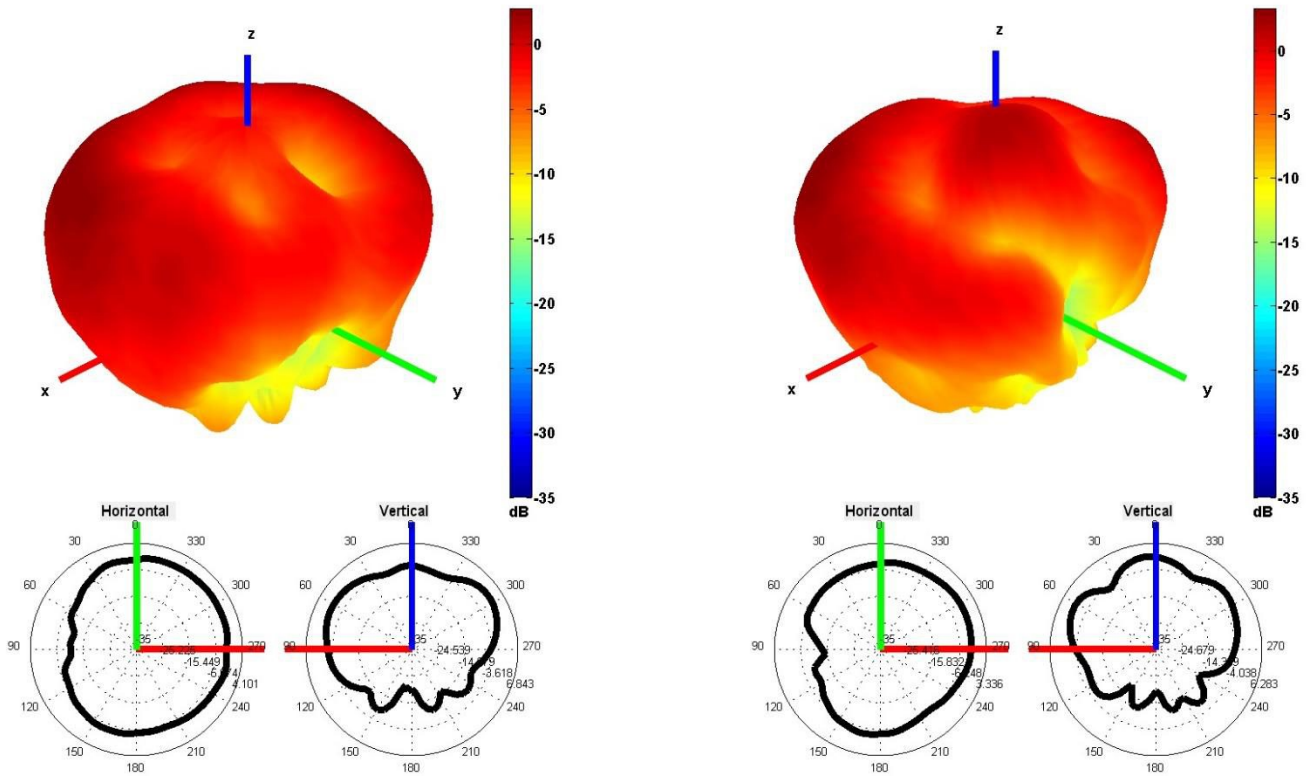

2100 and 2600 MHz Radiation pattern

4. Antenna drawings

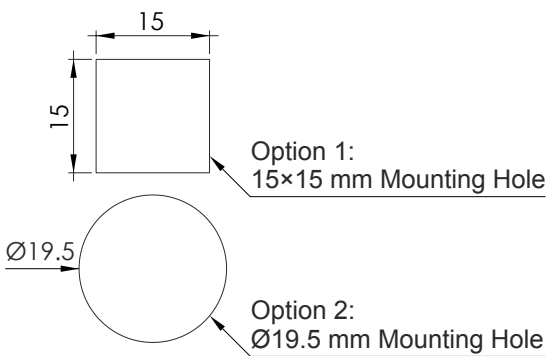
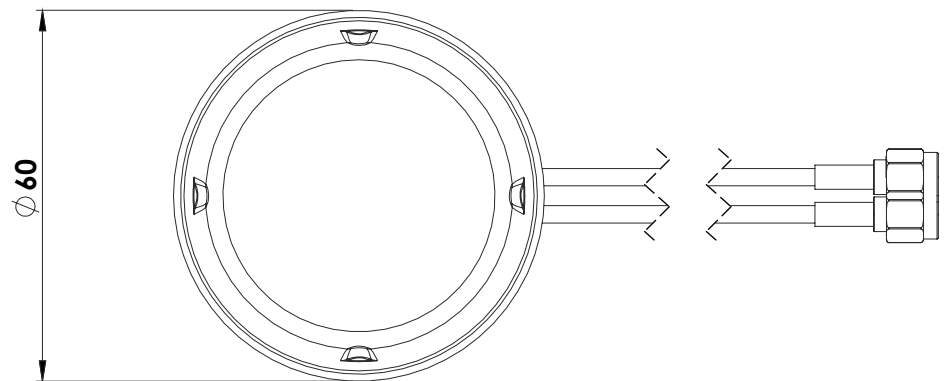
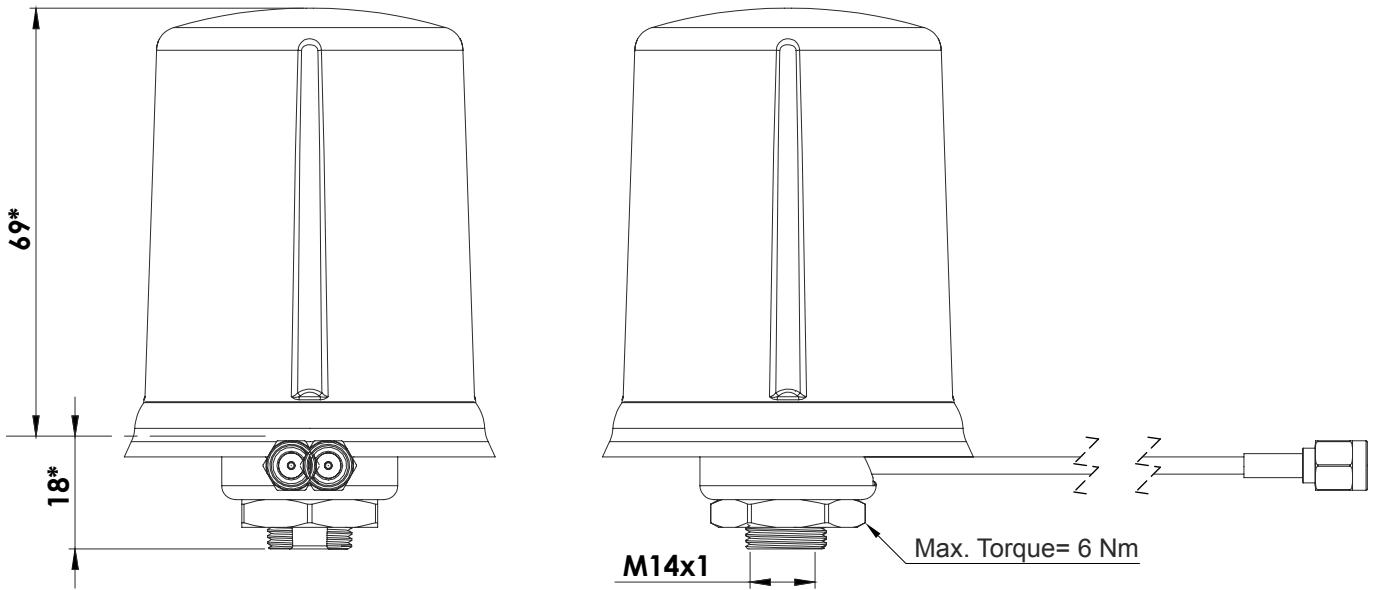

Note: Dimensions are in millimeters
***Dimensions are after mounting**
****Max. Torque= 6 Nm**

5. Antenna Images

