



User Guide for the Cisco Application Networking Manager 5.2

February 2012

Americas Headquarters

Cisco Systems, Inc.
170 West Tasman Drive
San Jose, CA 95134-1706
USA
<http://www.cisco.com>
Tel: 408 526-4000
800 553-NETS (6387)
Fax: 408 527-0883

Text Part Number: OL-26572-01

THE SPECIFICATIONS AND INFORMATION REGARDING THE PRODUCTS IN THIS MANUAL ARE SUBJECT TO CHANGE WITHOUT NOTICE. ALL STATEMENTS, INFORMATION, AND RECOMMENDATIONS IN THIS MANUAL ARE BELIEVED TO BE ACCURATE BUT ARE PRESENTED WITHOUT WARRANTY OF ANY KIND, EXPRESS OR IMPLIED. USERS MUST TAKE FULL RESPONSIBILITY FOR THEIR APPLICATION OF ANY PRODUCTS.

THE SOFTWARE LICENSE AND LIMITED WARRANTY FOR THE ACCOMPANYING PRODUCT ARE SET FORTH IN THE INFORMATION PACKET THAT SHIPPED WITH THE PRODUCT AND ARE INCORPORATED HEREIN BY THIS REFERENCE. IF YOU ARE UNABLE TO LOCATE THE SOFTWARE LICENSE OR LIMITED WARRANTY, CONTACT YOUR CISCO REPRESENTATIVE FOR A COPY.

The Cisco implementation of TCP header compression is an adaptation of a program developed by the University of California, Berkeley (UCB) as part of UCB's public domain version of the UNIX operating system. All rights reserved. Copyright © 1981, Regents of the University of California.

NOTWITHSTANDING ANY OTHER WARRANTY HEREIN, ALL DOCUMENT FILES AND SOFTWARE OF THESE SUPPLIERS ARE PROVIDED "AS IS" WITH ALL FAULTS. CISCO AND THE ABOVE-NAMED SUPPLIERS DISCLAIM ALL WARRANTIES, EXPRESSED OR IMPLIED, INCLUDING, WITHOUT LIMITATION, THOSE OF MERCHANTABILITY, FITNESS FOR A PARTICULAR PURPOSE AND NONINFRINGEMENT OR ARISING FROM A COURSE OF DEALING, USAGE, OR TRADE PRACTICE.

IN NO EVENT SHALL CISCO OR ITS SUPPLIERS BE LIABLE FOR ANY INDIRECT, SPECIAL, CONSEQUENTIAL, OR INCIDENTAL DAMAGES, INCLUDING, WITHOUT LIMITATION, LOST PROFITS OR LOSS OR DAMAGE TO DATA ARISING OUT OF THE USE OR INABILITY TO USE THIS MANUAL, EVEN IF CISCO OR ITS SUPPLIERS HAVE BEEN ADVISED OF THE POSSIBILITY OF SUCH DAMAGES.

Cisco and the Cisco Logo are trademarks of Cisco Systems, Inc. and/or its affiliates in the U.S. and other countries. A listing of Cisco's trademarks can be found at www.cisco.com/go/trademarks. Third party trademarks mentioned are the property of their respective owners. The use of the word partner does not imply a partnership relationship between Cisco and any other company. (1005R)

Any Internet Protocol (IP) addresses used in this document are not intended to be actual addresses. Any examples, command display output, and figures included in the document are shown for illustrative purposes only. Any use of actual IP addresses in illustrative content is unintentional and coincidental.



CONTENTS

Preface ix

Audience ix

Organization ix

Conventions xi

Open-Source Software Included in the Cisco Application Networking Manager xi

Obtaining Documentation and Submitting a Service Request xii

CHAPTER 1

Overview 1-1

ANM Overview 1-1

IPv6 Considerations 1-3

Logging In To the Cisco Application Networking Manager 1-5

Changing Your Account Password 1-6

ANM Licenses 1-7

ANM Interface Components 1-8

ANM Windows and Menus 1-9

ANM Buttons 1-11

Table Conventions 1-14

Filtering Entries 1-14

Customizing Tables 1-15

Using the Advanced Editing Option 1-16

ANM Screen Conventions 1-17

CHAPTER 2

Using Homepage 2-1

Information About Homepage 2-1

Customizing the Default ANM Page 2-4

CHAPTER 3

Using ANM Guided Setup 3-1

Information About Guided Setup 3-1

Guidelines and Limitations 3-4

Using Import Devices 3-4

Using ACE Hardware Setup 3-5

Using Virtual Context Setup 3-10

Using Application Setup 3-12

ACE Network Topology Overview 3-12
 Using Application Setup 3-14

CHAPTER 4

Using Application Template Definitions 4-1

Information About Application Template Definitions and Instances 4-1
 Managing Application Template Instances 4-3
 Creating an Application Template Instance 4-4
 Deploying a Staged Application Template Instance 4-7
 Editing an Application Template Instance 4-9
 Duplicating an Application Template Instance 4-10
 Viewing and Editing Application Template Instance Details 4-12
 Deleting an Application Template Instance 4-13
 Managing Application Template Definitions 4-15
 Editing an Application Template Definition 4-15
 Editing an Application Template Definition Using the ANM Template Editor 4-18
 Editing an Application Template Definition Using an External Editor 4-19
 Creating an Application Template Definition 4-20
 Creating an Application Template Definition Using the ANM Template Editor 4-21
 Creating an Application Template Definition Using an External XML Editor 4-23
 Exporting an Application Template Definition 4-26
 Importing an Application Template Definition 4-26
 Testing an Application Template Definition 4-28
 Deleting an Application Template Definition 4-29
 Using the ANM Template Editor 4-29

CHAPTER 5

Importing and Managing Devices 5-1

Information About Device Management 5-2
 Information About Importing Devices 5-4
 Preparing Devices for Import 5-4
 Enabling SSH or Telnet Access on Catalyst 6500 Series Switches and Cisco 7600 Series Routers 5-5
 Enabling SSH Access and the HTTPS Interface on the ACE Module and Appliance 5-6
 Enabling SNMP Polling from ANM 5-7
 ANM Requirements for ACE High Availability 5-8
 Modifying the ANM Timeout Setting to Compensate for Network Latency 5-9
 Importing Network Devices into ANM 5-10
 Importing Cisco IOS Host Chassis and Chassis Modules 5-11
 Importing Cisco IOS Devices with Installed Modules 5-12
 Importing ACE Modules after the Host Chassis has been Imported 5-16
 Importing CSM Devices after the Host Chassis has been Imported 5-19

Importing VSS 1440 Devices after the Host Chassis has been Imported	5-20
Importing ACE Appliances	5-21
Importing CSS Devices	5-22
Importing GSS Devices	5-23
Importing VMware vCenter Servers	5-24
Enabling a Setup Syslog for Autosync for Use With an ACE	5-27
Discovering Large Numbers of Devices Using IP Discovery	5-27
Preparing Devices for IP Discovery	5-28
Configuring Device Access Credentials	5-29
Modifying Credential Pools	5-30
Running IP Discovery to Identify Devices	5-31
Monitoring IP Discovery Status	5-33
Configuring Devices	5-34
Configuring Device System Attributes	5-34
Configuring CSM Primary Attributes	5-34
Configuring CSS Primary Attributes	5-35
Configuring GSS Primary Attributes	5-36
Configuring Catalyst 6500 VSS 1440 Primary Attributes	5-38
Configuring Catalyst 6500 Series Chassis and Cisco 7600 Series Router Primary Attributes	5-38
Configuring Catalyst 6500 Series Chassis, Catalyst 6500 Virtual Switching System 1440 Devices, and Cisco 7600 Series Routers Static Routes	5-39
Configuring VMware vCenter Server Primary Attributes	5-41
Configuring Catalyst 6500 Series Chassis or Cisco 7600 Series Router Interfaces	5-41
Displaying Chassis Interfaces and Configuring High-Level Interface Attributes	5-42
Configuring Access Ports	5-43
Configuring Trunk Ports	5-44
Configuring Switch Virtual Interfaces	5-45
Configuring Routed Ports	5-46
Managing Catalyst 6500 Series Chassis or Cisco 7600 Series Router VLANs	5-48
Adding Device VLANs	5-48
Displaying All Device VLANs	5-49
Configuring Device Layer 2 VLANs	5-50
Configuring Device Layer 3 VLANs	5-51
Modifying Device VLANs	5-51
Creating VLAN Groups	5-52
Configuring ACE Module and Appliance Role-Based Access Controls	5-53
Configuring Device RBAC Users	5-53
Guidelines for Managing Users	5-53
Displaying a List of Device Users	5-54
Configuring Device User Accounts	5-54

- Modifying Device User Accounts 5-55
- Deleting Device User Accounts 5-56
- Configuring Device RBAC Roles 5-56
 - Guidelines for Managing User Roles 5-57
 - Role Mapping in Device RBAC 5-57
 - Configuring Device User Roles 5-58
 - Modifying Device User Roles 5-60
 - Deleting Device User Roles 5-60
 - Adding, Editing, or Deleting Rules 5-61
- Configuring Device RBAC Domains 5-61
 - Guidelines for Managing Domains 5-62
 - Displaying Domains for a Device 5-62
 - Configuring Device Domains 5-63
 - Modifying Device Domains 5-65
 - Deleting Device Domains 5-65
- Managing Devices 5-66
 - Synchronizing Device Configurations 5-66
 - Synchronizing Chassis Configurations 5-67
 - Synchronizing Module Configurations 5-67
 - Mapping Real Servers to VMware Virtual Machines 5-68
 - Instructing ANM to Recognize an ACE Module Software Upgrade 5-71
 - Configuring User-Defined Groups 5-72
 - Adding a User-Defined Group 5-72
 - Modifying a User-Defined Group 5-73
 - Duplicating a User-Defined Group 5-74
 - Deleting a User-Defined Group 5-75
 - Changing Device Credentials 5-75
 - Changing ACE Module Passwords 5-77
 - Restarting Device Polling 5-78
 - Displaying All Devices 5-78
 - Displaying Modules by Chassis 5-79
 - Removing Modules from the ANM Database 5-80
 - Replacing an ACE Module Managed by ANM 5-82
 - Using the Preferred Method to Replace an ACE Module 5-82
 - Using the Alternate Method to Replace an ACE Module 5-84

CHAPTER 6

Configuring Virtual Contexts 6-1

- Information About Virtual Contexts 6-2
- Creating Virtual Contexts 6-2

Configuring Virtual Contexts	6-8
Configuring Virtual Context System Attributes	6-13
Configuring Virtual Context Primary Attributes	6-14
Configuring Virtual Context Syslog Settings	6-19
Configuring Syslog Log Hosts	6-23
Configuring Syslog Log Messages	6-24
Configuring Syslog Log Rate Limits	6-26
Configuring SNMP for Virtual Contexts	6-27
Configuring Basic SNMP Attributes	6-27
Configuring SNMPv2c Communities	6-28
Configuring SNMPv3 Users	6-29
Configuring SNMP Trap Destination Hosts	6-32
Configuring SNMP Notification	6-33
Applying a Policy Map Globally to All VLAN Interfaces	6-35
Managing ACE Licenses	6-36
Viewing ACE Licenses	6-36
Installing ACE Licenses	6-37
Uninstalling ACE Licenses	6-39
Updating ACE Licenses	6-40
Displaying the File Contents of a License	6-42
Using Resource Classes	6-43
Global and Local Resource Classes	6-44
Resource Allocation Constraints	6-44
Using Global Resource Classes	6-46
Configuring Global Resource Classes	6-46
Deploying Global Resource Classes	6-48
Auditing Resource Classes	6-49
Modifying Global Resource Classes	6-50
Deleting Global Resource Classes	6-51
Using Local Resource Classes	6-51
Configuring Local Resource Classes	6-52
Deleting Local Resource Classes	6-53
Displaying Local Resource Class Use on Virtual Contexts	6-54
Using the Configuration Checkpoint and Rollback Service	6-54
Creating a Configuration Checkpoint	6-55
Deleting a Configuration Checkpoint	6-56
Rolling Back a Running Configuration	6-56
Displaying Checkpoint Information	6-57
Comparing a Checkpoint to the Running Configuration	6-58

- Performing Device Backup and Restore Functions **6-59**
 - Backing Up Device Configuration and Dependencies **6-62**
 - Restoring Device Configuration and Dependencies **6-66**
- Performing Global Device Backup and Copy Functions **6-68**
 - Backing Up Multiple Device Configuration and SSL Files **6-69**
 - Associating a Global Backup Schedule with a Device **6-71**
 - Managing Global Backup Schedules **6-73**
 - Creating a Backup Schedule **6-73**
 - Updating an Existing Backup Schedule **6-76**
 - Deleting a Backup Schedule **6-76**
 - Copying Existing Tarded Backup Files to a Remote Server **6-77**
- Configuring Security with ACLs **6-78**
 - Creating ACLs **6-79**
 - Setting Extended ACL Attributes **6-82**
 - Resequencing Extended ACLs **6-87**
 - Setting EtherType ACL Attributes **6-87**
 - Displaying ACL Information and Statistics **6-89**
- Configuring Object Groups **6-89**
 - Creating or Editing an Object Group **6-90**
 - Configuring IP Addresses for Object Groups **6-91**
 - Configuring Subnet Objects for Object Groups **6-92**
 - Configuring Protocols for Object Groups **6-93**
 - Configuring TCP/UDP Service Parameters for Object Groups **6-94**
 - Configuring ICMP Service Parameters for an Object Group **6-97**
- Managing ACLs **6-99**
 - Viewing All ACLs by Context **6-99**
 - Editing or Deleting ACLs **6-100**
- Configuring Virtual Context Expert Options **6-101**
- Comparing Context and Building Block Configurations **6-101**
- Managing Virtual Contexts **6-103**
 - Displaying All Virtual Contexts **6-103**
 - Synchronizing Virtual Context Configurations **6-105**
 - Managing Syslog Settings for Autosynchronization **6-105**
 - Editing Virtual Contexts **6-106**
 - Deleting Virtual Contexts **6-107**
 - Upgrading Virtual Contexts **6-107**
 - Restarting Virtual Context Polling **6-108**

CHAPTER 7**Configuring Virtual Servers 7-1**

- Information About Load Balancing 7-1
- Configuring Virtual Servers 7-2
 - Virtual Server Configuration and ANM 7-2
 - Information About Using ANM to Configure Virtual Servers 7-4
 - Virtual Server Usage Guidelines 7-5
 - Virtual Server Testing and Troubleshooting 7-6
 - Virtual Server Configuration Procedure 7-7
 - Shared Objects and Virtual Servers 7-9
 - Virtual Server Protocols by Device Type 7-11
 - Configuring Virtual Server Properties 7-11
 - Configuring Virtual Server SSL Termination 7-17
 - Configuring Virtual Server Protocol Inspection 7-18
 - Configuring Virtual Server Layer 7 Load Balancing 7-30
 - Configuring Virtual Server Default Layer 7 Load Balancing 7-50
 - Configuring Application Acceleration and Optimization 7-53
 - Configuring Virtual Server NAT 7-63
 - Displaying Virtual Servers by Context 7-65
 - Displaying Virtual Server Statistics and Status Information 7-65
- Managing Virtual Servers 7-66
 - Managing Virtual Server Groups 7-67
 - Creating a Virtual Server Group 7-68
 - Editing or Copying a Virtual Server Group 7-69
 - Displaying a Virtual Server Group 7-70
 - Deleting a Virtual Server Group 7-70
 - Activating Virtual Servers 7-71
 - Suspending Virtual Servers 7-72
 - Managing GSS VIP Answers 7-73
 - Activating and Suspending DNS Rules Governing GSS Load Balancing 7-75
 - Managing GSS VIP Answer and DNS Rule Groups 7-76
 - Creating a VIP Answer or DNS Rule Group 7-77
 - Editing or Copying a VIP Answer or DNS Rule Group 7-78
 - Displaying a VIP Answer or DNS Rule Group 7-79
 - Deleting a VIP Answer or DNS Rule Group 7-80
 - Displaying Detailed Virtual Server Information 7-81
 - Displaying Virtual Servers 7-81
 - Using the Virtual Server Connection Statistics Graph 7-84
 - Using the Virtual Server Topology Map 7-85
 - Understanding CLI Commands Sent from Virtual Server Table 7-86

- Deploying Virtual Servers **7-86**
 - Deploying a Virtual Server **7-87**
 - Displaying All Staged Virtual Servers **7-87**
 - Modifying Deployed Virtual Servers **7-88**
 - Modifying Staged Virtual Servers **7-88**

CHAPTER 8

Configuring Real Servers and Server Farms 8-1

- Information About Server Load Balancing **8-1**
 - Load-Balancing Predictors **8-2**
 - Real Servers **8-3**
 - Dynamic Workload Scaling Overview **8-4**
 - Server Farms **8-5**
- Configuring Real Servers **8-5**
 - Configuring Load Balancing on Real Servers **8-6**
 - Displaying Real Server Statistics and Status Information **8-9**
- Managing Real Servers **8-9**
 - Managing Real Server Groups **8-10**
 - Creating a Real Server Group **8-11**
 - Editing or Copying a Real Server Group **8-12**
 - Displaying a Real Server Group **8-13**
 - Deleting a Real Server Group **8-13**
 - Activating Real Servers **8-14**
 - Suspending Real Servers **8-15**
 - Modifying Real Server Weight Value **8-17**
 - Displaying Real Servers **8-18**
 - Using the Real Server Connection Statistics Graph **8-22**
 - Using the Real Server Topology Map **8-23**
 - CLI Commands Sent from the Real Server Table **8-23**
 - Server Weight Ranges **8-25**
- Configuring Dynamic Workload Scaling **8-26**
 - Configuring and Verifying a Cisco Nexus 7000 Series Switch Connection **8-27**
 - Configuring and Verifying a VM Controller Connection **8-29**
- Configuring Server Farms **8-30**
 - Configuring Load Balancing Using Server Farms **8-31**
 - Adding Real Servers to a Server Farm **8-37**
 - Configuring the Predictor Method for Server Farms **8-39**
 - Configuring Server Farm HTTP Return Error-Code Checking **8-46**
 - Displaying All Server Farms **8-48**
 - Displaying Server Farm Statistics and Status Information **8-48**

Configuring Health Monitoring	8-49
TCL Scripts	8-50
Configuring Health Monitoring for Real Servers	8-51
Configuring Probe Attributes	8-56
DNS Probe Attributes	8-57
Echo-TCP Probe Attributes	8-58
Echo-UDP Probe Attributes	8-58
Finger Probe Attributes	8-58
FTP Probe Attributes	8-59
HTTP Probe Attributes	8-60
HTTPS Probe Attributes	8-61
IMAP Probe Attributes	8-63
POP Probe Attributes	8-64
RADIUS Probe Attributes	8-65
RTSP Probe Attributes	8-65
Scripted Probe Attributes	8-66
SIP-TCP Probe Attributes	8-67
SIP-UDP Probe Attributes	8-68
SMTP Probe Attributes	8-69
SNMP Probe Attributes	8-69
TCP Probe Attributes	8-70
Telnet Probe Attributes	8-70
UDP Probe Attributes	8-71
VM Probe Attributes	8-72
Configuring DNS Probe Expect Addresses	8-73
Configuring Headers for HTTP and HTTPS Probes	8-74
Configuring Health Monitoring Expect Status	8-74
Configuring an OID for SNMP Probes	8-76
Displaying Health Monitoring Statistics and Status Information	8-77
Configuring Secure KAL-AP	8-77

CHAPTER 9

Configuring Stickiness	9-1
Information About Stickiness	9-1
Sticky Types	9-2
HTTP Content Stickiness	9-3
HTTP Cookie Stickiness	9-3
HTTP Header Stickiness	9-4
IP Netmask and IPv6 Prefix Stickiness	9-4
Layer 4 Payload Stickiness	9-4

- RADIUS Stickiness 9-5
- RTSP Header Stickiness 9-5
- SIP Header Stickiness 9-5
- Sticky Groups 9-6
- Sticky Table 9-6
- Configuring Sticky Groups 9-7
 - Sticky Group Attribute Tables 9-11
 - HTTP Content Sticky Group Attributes 9-11
 - HTTP Cookie Sticky Group Attributes 9-12
 - HTTP Header Sticky Group Attributes 9-13
 - IP Netmask Sticky Group Attributes 9-13
 - V6 Prefix Sticky Group Attributes 9-13
 - Layer 4 Payload Sticky Group Attributes 9-14
 - RADIUS Sticky Group Attributes 9-14
 - RTSP Header Sticky Group Attributes 9-15
- Displaying All Sticky Groups by Context 9-15
- Configuring Sticky Statics 9-15

CHAPTER 10

Configuring Parameter Maps 10-1

- Information About Parameter Maps 10-1
- Configuring Connection Parameter Maps 10-3
- Configuring Generic Parameter Maps 10-8
- Configuring HTTP Parameter Maps 10-9
- Configuring Optimization Parameter Maps 10-12
- Configuring RTSP Parameter Maps 10-20
- Configuring SIP Parameter Maps 10-21
- Configuring Skinny Parameter Maps 10-23
- Configuring DNS Parameter Maps 10-25
- Supported MIME Types 10-26

CHAPTER 11

Configuring SSL 11-1

- SSL Overview 11-2
- SSL Configuration Prerequisites 11-2
- Summary of SSL Configuration Tasks 11-3
- SSL Setup Sequence 11-4
- Using SSL Certificates 11-5
- Importing SSL Certificates 11-7

Using SSL Keys	11-10
Importing SSL Key Pairs	11-11
Generating SSL Key Pairs	11-14
Exporting SSL Certificates	11-15
Exporting SSL Key Pairs	11-16
Configuring SSL Parameter Maps	11-18
Configuring SSL Chain Group Parameters	11-23
Configuring SSL CSR Parameters	11-24
Generating CSRs	11-26
Configuring SSL Proxy Service	11-27
Configuring SSL OCSP Service	11-29
Enabling Client Authentication	11-31
Configuring SSL Authentication Groups	11-31
Configuring CRLs for Client Authentication	11-33

CHAPTER 12

Configuring Network Access	12-1
Information About VLANs	12-2
ACE Module VLANs	12-2
ACE Appliance VLANs	12-2
Configuring VLANs Using Cisco IOS Software (ACE Module)	12-3
Creating VLAN Groups Using Cisco IOS Software	12-3
Assigning VLAN Groups to the ACE Module Through Cisco IOS Software	12-4
Adding Switched Virtual Interfaces to the MSFC	12-5
Configuring Virtual Context VLAN Interfaces	12-6
Displaying All VLAN Interfaces	12-18
Displaying VLAN Interface Statistics and Status Information	12-18
Configuring Virtual Context BVI Interfaces	12-19
Configuring BVI Interfaces for a Virtual Context	12-19
Displaying All BVI Interfaces by Context	12-25
Displaying BVI Interface Statistics and Status Information	12-26
Configuring VLAN Interface NAT Pools	12-26
Configuring Virtual Context Static Routes	12-28
Configuring Global IP DHCP	12-29
Configuring Static VLANs for Over 8000 Static NAT Configurations	12-31
Configuring Gigabit Ethernet Interfaces on the ACE Appliance	12-32
Configuring Gigabit Ethernet Interfaces	12-32
Displaying Gigabit Ethernet Interface Statistics and Status Information	12-35
Configuring Port-Channel Interfaces for the ACE Appliance	12-35

- Why Use Port Channels? 12-35
- Configuring a Port-Channel Interface 12-36
- Configuring a Catalyst 6500 Series Switch for an ACE Appliance Port-Channel Interface Connection 12-38
 - Creating the Port Channel Interface on the Catalyst 6500 12-38
 - Adding Interfaces to the Port Channel 12-39
- Displaying Port Channel Interface Statistics and Status Information 12-40

CHAPTER 13

Configuring High Availability 13-1

- Understanding ANM High Availability 13-2
 - Understanding ANM High Availability Processes 13-3
 - Configuring ANM High Availability Overview 13-3
 - CLI Commands for ANM High Availability Processes 13-4
 - Recovering From an HA Database Replication Failure 13-6
- Understanding ACE Redundancy 13-6
 - ACE High Availability Polling 13-7
 - ACE Redundancy Protocol 13-8
 - ACE Stateful Failover 13-9
 - ACE Fault-Tolerant VLAN 13-10
 - ACE Configuration Synchronization 13-11
 - ACE Redundancy Configuration Requirements and Restrictions 13-12
 - ACE High Availability Troubleshooting Guidelines 13-12
- Configuring ACE High Availability 13-14
- Configuring ACE High Availability Peers 13-15
- Clearing ACE High Availability Pairs 13-17
- Configuring ACE High Availability Groups 13-17
 - Editing High Availability Groups 13-19
 - Taking a High Availability Group Out of Service 13-20
 - Enabling a High Availability Group 13-21
- Displaying High Availability Group Statistics and Status 13-21
- Switching Over an ACE High Availability Group 13-22
- Deleting ACE High Availability Groups 13-23
- ACE High Availability Tracking and Failure Detection Overview 13-23
- Tracking ACE VLAN Interfaces for High Availability 13-24
- Tracking Hosts for High Availability 13-25
- Configuring Host Tracking Probes 13-26
 - Deleting Host Tracking Probes 13-27
- Configuring ACE Peer Host Tracking Probes 13-28

Deleting Peer Host Tracking Probes	13-29
Configuring ACE HSRP Groups	13-29
Synchronizing ACE High Availability Configurations	13-30
Synchronizing Virtual Context Configurations in High Availability Mode	13-31
Synchronizing SSL Certificate and Key Pairs on Both ACE Peers	13-32

CHAPTER 14**Configuring Traffic Policies 14-1**

Traffic Policy Overview	14-1
Class Map and Policy Map Overview	14-2
Class Maps	14-3
Policy Maps	14-4
Parameter Maps and Their Use in Layer 3 and Layer 4 Policy Maps	14-5
Protocol Inspection Overview	14-6
Configuring Virtual Context Class Maps	14-6
Deleting Class Maps	14-8
Setting Match Conditions for Class Maps	14-8
Setting Match Conditions for Layer 3/Layer 4 Network Traffic Class Maps	14-9
Setting Match Conditions for Layer 3/Layer 4 Management Traffic Class Maps	14-12
Setting Match Conditions for Layer 7 Server Load Balancing Class Maps	14-14
Setting Match Conditions for Layer 7 HTTP Deep Packet Inspection Class Maps	14-17
Setting Match Conditions for Layer 7 FTP Command Inspection Class Maps	14-22
Setting Match Conditions for Generic Server Load Balancing Class Maps	14-23
Setting Match Conditions for RADIUS Server Load Balancing Class Maps	14-25
Setting Match Conditions for RTSP Server Load Balancing Class Maps	14-26
Setting Match Conditions for SIP Server Load Balancing Class Maps	14-27
Setting Match Conditions for Layer 7 SIP Deep Packet Inspection Class Maps	14-30
Configuring Virtual Context Policy Maps	14-32
Configuring Rules and Actions for Policy Maps	14-34
Setting Policy Map Rules and Actions for Generic Server Load Balancing	14-35
Setting Policy Map Rules and Actions for Layer 3/Layer 4 Management Traffic	14-39
Setting Policy Map Rules and Actions for Layer 3/Layer 4 Network Traffic	14-41
Setting Policy Map Rules and Actions for Layer 7 FTP Command Inspection	14-48
Setting Policy Map Rules and Actions for Layer 7 HTTP Deep Packet Inspection	14-51
Setting Policy Map Rules and Actions for Layer 7 HTTP Optimization	14-57
Setting Policy Map Rules and Actions for Layer 7 Server Load-Balancing Traffic	14-61
Setting Policy Map Rules and Actions for Layer 7 SIP Deep Packet Inspection	14-68
Setting Policy Map Rules and Actions for Layer 7 Skinny Deep Packet Inspection	14-71
Setting Policy Map Rules and Actions for RADIUS Server Load Balancing	14-73
Setting Policy Map Rules and Actions for RDP Server Load Balancing	14-75

- Setting Policy Map Rules and Actions for RTSP Server Load Balancing 14-76
- Setting Policy Map Rules and Actions for SIP Server Load Balancing 14-79
- Special Characters for Matching String Expressions 14-84
- Configuring Actions Lists 14-85
 - Configuring an HTTP Header Modify Action List 14-85
 - Configuring HTTP Header Insertion, Deletion, and Rewrite 14-85
 - Configuring SSL URL Rewrite 14-88
 - Configuring SSL Header Insertion 14-89

CHAPTER 15

Configuring Application Acceleration and Optimization 15-1

- Optimization Overview 15-2
- Optimization Traffic Policies and Typical Configuration Flow 15-2
- Configuring an HTTP Optimization Action List 15-3
- Configuring Optimization Parameter Maps 15-6
- Configuring Traffic Policies for HTTP Optimization 15-6
- Enabling HTTP Optimization Using Virtual Servers 15-9
- Configuring Global Application Acceleration and Optimization 15-9

CHAPTER 16

Using Configuration Building Blocks 16-1

- Information About Building Block Versions and Tagging 16-4
- Enabling the Building Block Feature 16-5
- Creating Building Blocks 16-5
- Extracting Building Blocks from Virtual Contexts 16-6
- Configuring Building Blocks 16-7
 - Configuring Building Block Primary Attributes 16-8
- Tagging Building Blocks 16-9
- Applying Building Blocks 16-9
 - Applying a Building Block to a Single Virtual Context 16-10
 - Applying a Building Block to Multiple Virtual Contexts 16-10
- Displaying Building Block Use 16-11

CHAPTER 17

Monitoring Your Network 17-1

- Setting Up Devices for Monitoring 17-2
- Device Monitoring Features 17-3
- Using Dashboards to Monitor Devices and Virtual Contexts 17-4
 - ACE Dashboard 17-5
 - Device Information Table 17-6

License Status Table	17-6
High Availability Table	17-7
ACE Device Configuration Summary Table	17-7
Context With Denied Resource Usage Detected Table	17-8
Device Resource Usage Graph	17-9
Top 10 Current Resources Table	17-10
Control Plane CPU/Memory Graphs	17-11
ACE Virtual Context Dashboard	17-12
ACE Virtual Context Device Configuration Summary Table	17-13
Context With Denied Resource Usage Detected Table	17-14
Context Resource Usage Graph	17-15
Load Balancing Servers Performance Graphs	17-15
ANM Group Dashboard	17-16
Managed Devices Table	17-17
Context With Denied Resource Usage Detected Table	17-18
ANM Group Device Configuration Summary Table	17-18
Top 10 Current Resources Table	17-20
Latest 5 Alarms Notifications Table	17-21
Latest 5 Critical Events Table	17-21
Contexts Performance Overview Graph	17-22
Monitoring Device Groups	17-23
Monitoring Devices	17-24
Monitoring the System	17-25
Monitoring Resource Usage	17-26
Monitoring Virtual Context Resource Usage	17-26
Monitoring System Traffic Resource Usage	17-27
Monitoring System Non-Connection Based Resource Usage	17-29
Monitoring Traffic	17-30
Displaying Device-Specific Traffic Data	17-31
Monitoring Load Balancing	17-33
Monitoring Load Balancing on Virtual Servers	17-33
Monitoring Load Balancing on Real Servers	17-37
Monitoring Load Balancing on Probes	17-40
Monitoring Load Balancing Statistics	17-41
Monitoring Application Acceleration	17-43
Displaying the Polling Status of All Managed Objects	17-44
Setting Polling Parameters	17-46
Enabling Polling on Specific Devices	17-46
Disabling Polling on Specific Devices	17-47

- Enabling Polling on All Devices 17-47
- Disabling Polling on All Devices 17-48
- Configuring Historical Trend and Real Time Graphs for Devices 17-48
- Exporting Historical Data 17-52
- Monitoring Events 17-55
- Configuring Alarm Notifications on ANM 17-57
- Displaying Alarm Notifications 17-65
 - Displaying Alarms in ANM 17-65
 - Displaying Email Notifications 17-66
 - Displaying Traps 17-67
- Configuring SMTP for Email Notifications 17-68
- Displaying Network Topology Maps 17-68
- Testing Connectivity 17-71

CHAPTER 18

Administering the Cisco Application Networking Manager 18-1

- Overview of the Admin Function 18-2
- Controlling Access to Cisco ANM 18-3
 - Types of Users 18-5
 - Understanding Roles 18-6
 - Understanding Operations Privileges 18-6
 - Understanding Domains 18-7
 - Understanding Organizations 18-7
- How ANM Handles Role-Based Access Control 18-8
- Configuring User Authentication and Authorization 18-9
 - Adding a New Organization 18-10
 - Changing Authentication Server Passwords 18-14
 - Changing the Admin Password 18-14
 - Modifying Organizations 18-14
 - Duplicating an Organization 18-15
 - Displaying Authentication Server Organizations 18-16
 - Deleting Organizations 18-16
- Managing User Accounts 18-17
 - Guidelines for Managing User Accounts 18-17
 - Displaying a List of Users 18-18
 - Creating User Accounts 18-19
 - Duplicating a User Account 18-20
 - Modifying User Accounts 18-21
 - Resetting Another User's Password 18-22

Deleting User Accounts	18-23
Displaying or Terminating Current User Sessions	18-24
Managing User Roles	18-25
Guidelines for Managing User Roles	18-25
Understanding Predefined Roles	18-26
Displaying User Role Relationships	18-27
Displaying User Roles and Associated Tasks and ANM Menu Privileges	18-28
Creating User Roles	18-29
Duplicating a User Role	18-31
Modifying User Roles	18-31
Deleting User Roles	18-32
Managing Domains	18-32
Guidelines for Managing Domains	18-33
Displaying Network Domains	18-33
Creating a Domain	18-34
Duplicating a Domain	18-35
Modifying a Domain	18-36
Deleting a Domain	18-37
Using an AAA Server for Remote User Authentication and Authorization	18-38
Information About Using AD/LDAPS for Remote User Authentication	18-38
Configuring Remote User Authentication Using a TACACS+ Server	18-39
Configuring Remote User Authorization Using a TACACS+ Server	18-45
Configuring Remote User Authorization Using Cisco Secure ACS Version 5.1	18-46
Configuring Remote User Authorization Using Cisco Secure ACS Version 4.2	18-48
Disabling the ANM Login Window Change Password Feature	18-50
Managing ANM	18-51
Checking the Status of the ANM Server	18-52
Using ANM License Manager to Manage ANM Server or Demo Licenses	18-54
Displaying and Adding ANM Licenses to License Management	18-54
Removing an ANM License File	18-55
Displaying ANM Server Statistics	18-56
Configuring ANM Statistics Collection	18-57
Configuring Audit Log Settings	18-58
Performing Device Audit Trail Logging	18-59
Displaying Change Audit Logs	18-61
Configuring Auto Sync Settings	18-61
Configuring Advanced Settings	18-62
Configuring the Overwrite ACE Logging device-id for the Syslog Option	18-62
Configuring the Enable Write Mem on the Config > Operations Option	18-63

- Enabling the ACE Real Server Details Popup Window Option 18-64
- Enabling the ACE Server Farm Details Popup Window Option for Virtual Servers 18-65
- Enable Mobile Notifications from ANM 18-66
- Managing the Syslog Buffer Display in the All Devices Dashboard 18-66
- Managing the Display of Virtual Servers in the Operations and Monitoring Windows 18-66
- Administering the ANM Mobile Feature 18-67
 - Configuring ANM with a Proxy Server for ANM Mobile Push Notifications 18-67
 - Enabling Mobile Device Notifications for Remotely Authorized Users 18-69
 - Globally Enabling or Disabling Mobile Device Notifications 18-69
 - Displaying Mobile Device Notifications and Testing the Notification Channel 18-70
- Lifeline Management 18-72

CHAPTER 19

Using ANM Mobile 19-1

- Information About ANM Mobile 19-2
- ANM Mobile Prerequisites and Supported Devices 19-4
- Guidelines and Restrictions 19-5
- Using ANM Mobile 19-5
 - Logging In and Out of ANM Mobile 19-6
 - Using the Favorites Feature 19-6
 - Monitoring Managed Object Status 19-7
 - Modifying an Object's Operating State or Weight 19-10
 - Displaying Real Time Charts 19-12
 - Using the ANM Mobile Setting Feature 19-12
 - Setting Up and Viewing Mobile Device Alarm Notifications 19-13
 - Enabling Alarm Notifications on ANM Mobile 19-15
 - Viewing Alarm Notifications from ANM Mobile 19-15
 - Managing iPod Alarm Notification Sound and Alerts 19-16

CHAPTER 20

Troubleshooting Cisco Application Networking Manager Problems 20-1

- Changing ANM Software Configuration Attributes 20-1
 - Changing ANM Configuration Properties 20-2
 - Example ANM Standalone Configuration 20-4
 - Example ANM HA Configuration 20-5
 - Example ANM Advanced Options Configuration Session 20-6
- Discovering and Adding a Device Does Not Work 20-7
- Cisco License Manager Server Not Receiving Syslog Messages 20-7
- Using Lifeline 20-7
 - Guidelines for Using Lifeline 20-8

Creating a Lifeline Package	20-8
Downloading a Lifeline Package	20-9
Adding a Lifeline Package	20-10
Deleting a Lifeline Package	20-11
Backing Up and Restoring Your ANM Configuration	20-11

APPENDIX A**ANM Ports Reference A-1****APPENDIX B****Using the ANM Plug-In With Virtual Data Centers B-1**

Information About Using ANM With VMware vCenter Server	B-2
Information About the Cisco ACE SLB Tab in vSphere Client	B-3
Prerequisites for Using ANM With VMware vSphere Client	B-4
Guidelines and Restrictions	B-5
Registering or Unregistering the ANM Plug-in	B-5
Logging In To ANM from VMware vSphere Client	B-7
Using the Cisco ACE SLB Tab	B-8
Managing ACE Real Servers From vSphere Client	B-12
Adding a Real Server	B-13
Deleting a Real Server Using vSphere Client	B-14
Activating Real Servers Using vSphere Client	B-15
Suspending Real Servers Using vSphere Client	B-16
Modifying Real Server Weight Value Using vSphere Client	B-18
Monitoring Real Server Details Using vSphere Client	B-19
Refreshing the Displayed Real Server Information	B-20
Using the VMware vSphere Plug-in Manager	B-22

GLOSSARY**INDEX**



Preface

Date: 3/28/12

This guide describes the Cisco Application Networking Manager and explains how to use it to manage your network.

This preface provides information about using this guide and includes the following topics:

- [Audience, page ix](#)
- [Organization, page ix](#)
- [Conventions, page xi](#)
- [Open-Source Software Included in the Cisco Application Networking Manager, page xi](#)
- [Obtaining Documentation and Submitting a Service Request, page xii](#)

Audience

This guide is intended for experienced system and network administrators. Depending on the configuration required, readers should have specific knowledge in the following areas:

- Networking and data communications
- Network security
- Router configuration

Organization

This documentation contains the following sections:

- [Chapter 1, “Overview”](#) summaries key features and provides an look into some general topics such as the interface.
- [Chapter 2, “Using Homepage”](#) describes ANM Homepage, a launching point for quick access to selected areas within ANM.
- [Chapter 3, “Using ANM Guided Setup”](#) describes how to use the guided setup pages to simplify configuration of ANM.
- [Chapter 4, “Using Application Template Definitions”](#) describes how to use the application templates to simplify configuration of ACE devices (or virtual contexts).

- [Chapter 5, “Importing and Managing Devices”](#) describes how to add and manage your supported network devices.
- [Chapter 6, “Configuring Virtual Contexts”](#) describes how to configure virtual contexts on the ACE so that you can effectively and efficiently manage and allocate resources, users, and services.
- [Chapter 7, “Configuring Virtual Servers”](#) contains procedures for configuring virtual servers for load balancing on the ACE.
- [Chapter 8, “Configuring Real Servers and Server Farms”](#) provides an overview of server load balancing and procedures for configuring real servers and server farms for load balancing on the ACE.
- [Chapter 9, “Configuring Stickiness”](#) provides information about sticky behavior and procedures for configuring stickiness with the ANM.
- [Chapter 10, “Configuring Parameter Maps”](#) describes how to configure parameter maps so that the ACE can perform actions on incoming traffic based on certain criteria, such as protocol or connection attributes.
- [Chapter 11, “Configuring SSL”](#) describes how to configure your ACE (both the ACE module and the ACE appliance) as a virtual Secure Sockets Layer (SSL) server for SSL initiation or termination.
- [Chapter 12, “Configuring Network Access”](#) describes how to configure network access using ANM.
- [Chapter 13, “Configuring High Availability”](#) describes how to configure redundancy to ensure that your network remains operational even if one of the ACE devices becomes unresponsive.
- [Chapter 14, “Configuring Traffic Policies”](#) describes how to configure class maps and policy maps to provide a global level of filtering traffic received by or passing through the ACE.
- [Chapter 15, “Configuring Application Acceleration and Optimization”](#) describes how to configure application acceleration and optimization options on the ACE.
- [Chapter 16, “Using Configuration Building Blocks”](#) provides an overview of configuration building blocks and describes how to configure them, tag them for version control, and apply them to virtual contexts.
- [Chapter 17, “Monitoring Your Network”](#) describes the ANM monitoring functions, including the various ANM dashboards, and explains how to configure thresholds and configure alarm notifications.
- [Chapter 18, “Administering the Cisco Application Networking Manager”](#) describes how to administer, maintain, and manage the ANM management system.
- [Chapter 19, “Using ANM Mobile”](#) describes how to use the Cisco ANM Mobile app to access your ANM server to remotely manage your network from your mobile device.
- [Chapter 20, “Troubleshooting Cisco Application Networking Manager Problems”](#) describes some procedures and tips on common troubleshooting scenarios.
- [Appendix A, “ANM Ports Reference”](#) identifies the TCP and UDP ports used by the ANM as well as well-known TCP and UDP port numbers and key words.
- [Appendix B, “Using the ANM Plug-In With Virtual Data Centers”](#) describes how to integrate ANM with VMware vCenter Server and VMware vSphere Client.

Conventions

This document uses the following conventions:

Item	Convention
Commands and keywords	boldface font
Variables for which you supply values	<i>italic</i> font
Displayed session and system information	screen font
Information you enter	boldface screen font
Variables you enter	<i>italic screen</i> font
Menu items and button names	boldface font
Choosing a menu item in paragraphs	Option > Network Preferences
Choosing a menu item in tables	Option > Network Preferences



Note

Means *reader take note*. Notes contain helpful suggestions or references to material not covered in the publication.



Caution

Means *reader be careful*. In this situation, you might do something that could result in equipment damage or loss of data.

Open-Source Software Included in the Cisco Application Networking Manager

- The Cisco Application Networking Manager includes the following open-source software, which is covered by the Apache 2.0 license (<http://www.apache.org/>): Ant, Avalon Logkit, Commons, Ehcache, Jetty, Log4J, Oro, Commons_Logging, Xmlrpc.
- The Cisco Application Networking Manager includes the following open-source software, which is covered by The Legion of the Bouncy Castle (<http://www.bouncycastle.org/licence.html>) license: BouncyCastle.
- The Cisco Application Networking Manager includes the following open-source software, which is covered by the GNU Lesser General Public License Version 2.1 (<http://www.gnu.org/licenses/lgpl.html>): c3p0-0.9.0.2.jar, Enterprise DT, Jasperreports 1.2, Jcommon 1.2, Jfreechart 1.0.1
- The Cisco Application Networking Manager includes the following open-source software, which is covered by the Mozilla Public License Version 1.1 (<http://www.mozilla.org/MPL/MPL-1.1.html>): Itext 1.4.

Obtaining Documentation and Submitting a Service Request

For information on obtaining documentation, submitting a service request, and gathering additional information, see the monthly *What's New in Cisco Product Documentation*, which also lists all new and revised Cisco technical documentation, at:

<http://www.cisco.com/en/US/docs/general/whatsnew/whatsnew.html>

Subscribe to the *What's New in Cisco Product Documentation* as a Really Simple Syndication (RSS) feed and set content to be delivered directly to your desktop using a reader application. The RSS feeds are a free service and Cisco currently supports RSS version 2.0.



CHAPTER 1

Overview

Date: 3/28/12

This chapter provides an overview of Cisco Application Networking Manager (ANM), which is a networking management application.

This chapter includes the following sections:

- [ANM Overview, page 1-1](#)
- [IPv6 Considerations, page 1-3](#)
- [Logging In To the Cisco Application Networking Manager, page 1-5](#)
- [Changing Your Account Password, page 1-6](#)
- [ANM Licenses, page 1-7](#)
- [ANM Interface Components, page 1-8](#)

ANM Overview

ANM is a client server application that enables you to perform the following functions:

- Configure, monitor, and troubleshoot the functions of supported data center devices.
- Create policies for operations, applications owners, and server administration staff to activate and suspend network-based services without knowledge of, or ability to, change network configuration or topology.
- Manage the following product types:
 - Cisco Application Control Engine (ACE) module or appliance
 - Cisco Global Site Selector (GSS)
 - Cisco Content Services Switch (CSS)
 - Cisco Catalyst 6500 Virtual Switching System (VSS) 1440
 - Cisco Catalyst 6500 series switch
 - Cisco 7600 series router
 - Cisco Content Switching Module (CSM)
 - Cisco Content Switching Module with SSL (CSM-S)
 - VMware vCenter Server

You can install the ANM server software on a standalone server or on a VMware virtual machine as shown in [Figure 1-1](#). The capabilities and functions of the ANM software are the same regardless of which application you use. This guide uses the following terms to reference the two ANM applications:

ANM server

Dedicated server with ANM server software and Red Hat Enterprise Linux (RHEL) operating system installed on it. For information about installing this type of ANM application, see the [Installation Guide for the Cisco Application Networking Manager 5.2](#).

ANM Virtual Appliance

VMware virtual appliance with ANM server software and Cisco Application Delivery Engine Operating System (ADE OS) installed on it. Cisco distributes ANM Virtual Appliance (ANM VA) in Open Virtual Appliance (.OVA) format. For information about installing this type of ANM application, see the [Installation Guide for the Cisco Application Networking Manager 5.2 Virtual Appliance](#).

Figure 1-1 Sample ANM Network Deployment

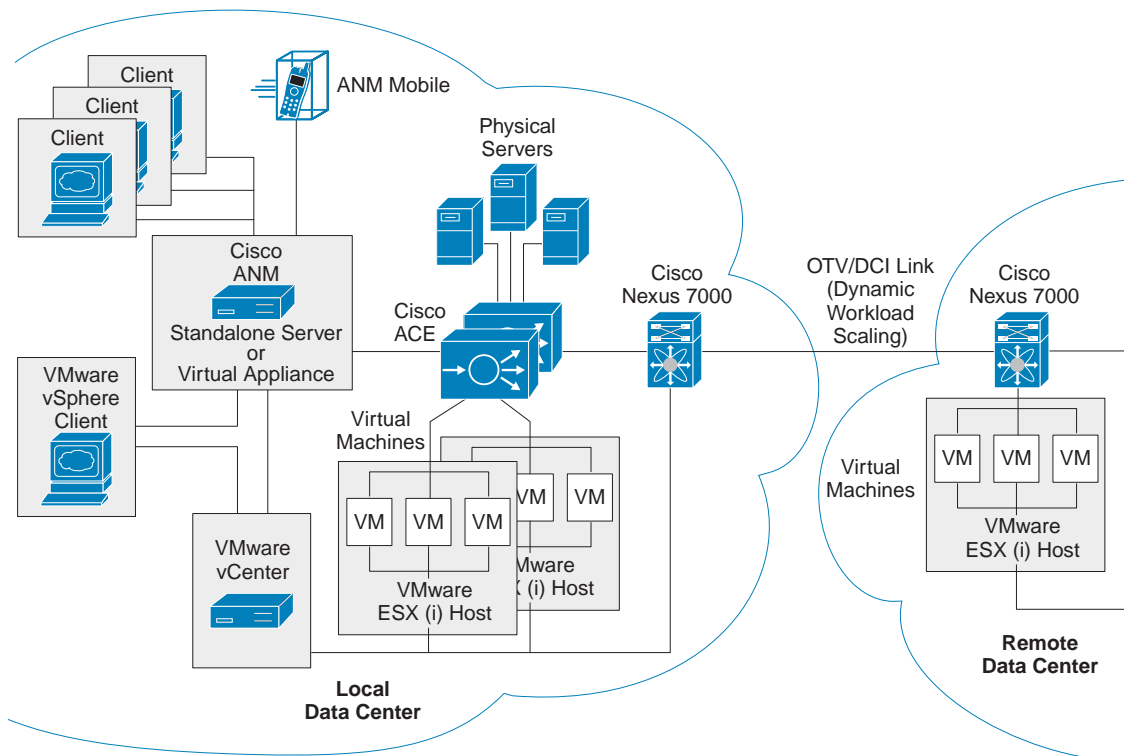

The sample network application in [Figure 1-1](#) illustrates the following ANM and ACE features:

- **VMware integration**—Feature that enables ANM and the ACE to be integrated with VMware, allowing you to create and manage server farms for application delivery that consist of real servers that are a combination of physical servers and VMware virtual machines (VMs).

- **Dynamic Workload Scaling**—ACE feature that permits on-demand access to remote resources, such as VMs, that you own or lease from an Internet service provider (or cloud service provider). This feature uses Cisco's Nexus 7000 series switches with Cisco's Overlay Transport Virtualization (OTV), which is a Data Center Interconnect (DCI) technology used to create a Layer 2 link over an existing IP network between geographically distributed data centers.

For more information, see the [“Dynamic Workload Scaling Overview”](#) section on page 8-4.



Note Dynamic Workload Scaling requires ACE module or appliance software Version A4(2.0) or later and the Cisco Nexus 7000 Series switch.

- **ANM plug-in for vCenter Server**—Enabling the plug-in on an ANM server or ANM Virtual Appliance permits access to ANM's ACE server load-balancing functions from a VMware vSphere Client.

For more information, see [Appendix B, “Using the ANM Plug-In With Virtual Data Centers.”](#)

- **ANM Mobile**—Feature that enables supported mobile devices to access to your ANM server or ANM Virtual Appliance, allowing you to manage the network objects in much the same way you do from an ANM client. Using a mobile device, you can run ANM Mobile as a native application or inside the mobile device's browser.

For more information, see [Chapter 19, “Using ANM Mobile.”](#)

IPv6 Considerations

Beginning with ACE software Version 5.1, the ACE supports IPv6 configurations, which you can configure using ANM beginning with ANM software Version 5.1.

The ACE supports IPv6 configurations with the following considerations:

- All the management traffic used by ANM is required to send over IPv4 protocol. IPv6 is not supported.
- By default, IPv6 is disabled on an interface. You must enable IPv6 on the interface to enable its configured IPv6 addresses. The interface cannot be in bridged mode. The interface may or may not have IPv4 addresses configured on it.
- When you enable IPv6 or configure a global IPv6 address on an interface, the ACE automatically does the following:

- Configures a link-local address (if it is not already configured)
- Performs duplicate address detection (DAD) on both addresses

You must enable IPv6 on the interface to enable global IPv6 address.

- IPv6 on interface can be individually enabled or disabled. IPv6 cannot be enabled or disabled globally.
- A link-local address is an IPv6 unicast address that has a scope of the local link only and is required on every interface. Every link-local address has a predefined prefix of FE80::/10. You can configure a link-local address manually. If you do not configure a link-local address before enabling an IPv6 address on the interface, the ACE automatically generates a link-local address with a prefix of FE80::/64. Only one IPv6 link-local address can be configured on an interface.

In a redundant configuration, you can configure an IPv6 peer link-local address for the standby ACE. You can configure only one peer link-local address on an interface.

- A unique-local address is an optional IPv6 unicast address that is used for local communication within an organization and it is similar to a private IPv4 address (for example, 10.10.2.1). unique-local addresses have a global scope, but they are not routable on the Internet, and they are assigned by a central authority. All unique-local addresses have a predefined prefix of FC00::/7. You can configure only one IPv6 unique-local address on an interface.

In a redundant configuration, you can configure an IPv6 peer unique-local address on the active that is synchronized to the standby ACE. You can configure only one peer unique-local IPv6 address on an interface.

- A global address is an IPv6 unicast address that is used for general IPv6 communication. Each global address is unique across the entire Internet. Therefore, its scope is global. The low order 64 bits can be assigned in several ways, including autoconfiguration using the EUI-64 format. You can configure only one globally unique IPv6 address on an interface.

In a redundant configuration, you can configure an IPv6 peer global address that is synchronized to the standby ACE.

When you configure redundancy with active and standby ACEs, you can configure a VLAN interface that has an alias global IPv6 address that is shared between the active and standby ACEs. The alias IPv6 address serves as a shared gateway for the two ACEs in a redundant configuration. You can configure only one alias global IPv6 address on an interface.

- A multicast address is used for communications from one source to many destinations. IPv6 multicast addresses function in a manner that is similar to IPv4 multicast addresses. All multicast addresses have a predefined prefix of FF00::/8.
- The ACE supports abbreviated IPv6 addresses. When using double colons (::) for leading zeros in a contiguous block, they can only be used once in an address. Leading zeros can be omitted. Trailing zeros cannot be omitted. The DM will abbreviate an IPv6 address after you finish typing it. If you enter the entire address with a block of contiguous zeros, the DM collapses it into the double colons. For example: FF01:0000:0000:0000:0000:0000:101 becomes FF01::101.
- The ACE uses the Neighbor Discovery (ND) protocol to manage and learn the mapping of IPv6 to Media Access Control (MAC) addresses of nodes attached to the local link. The ACE uses this information to forward and transmit IPv6 packets. The neighbor discovery protocol enables IPv6 nodes and routers to:
 - Determine the link-layer address of a neighbor on the same link
 - Find neighboring routers
 - Keep track of neighbors

The IPv6 neighbor discovery process uses ICMPv6 messages and solicited-node multicast addresses to determine the link-layer address of a neighbor on the same network (local link), verify the reachability of a neighbor, and keep track of neighbor routers. The IPv6 neighbor discovery process uses the following mechanisms for its operation:

- Neighbor Solicitation
- Neighbor Advertisement
- Router Solicitation
- Router Advertisement
- Duplicate Address Detection
- The ACE supports IPv6-to-IPv6 L4/L7 SLB, including support for IPv6 VIP, predictor, probe, serverfarm, sticky, access-list, object-group, interface, source NAT, OCSP, and CRL.

- The probe must have the same IP address type (IPv6 or IPv4) as the real server. For example, you cannot configure an IPv6 probe to an IPv4 real server.
- A server farm can support a mix of IPv6 and IPv4 real servers, and can be associated with both IPv6 and IPv4 probes.
- Only the following Layer 7 protocols support IPv6:
 - Layer 7 HTTP/HTTPS/DNS
 - Layer 4 TCP/UDP
- The ACE supports the following:
 - IPv6-to-IPv4 SLB and IPv4-to-IPv6 SLB for L7 HTTP/HTTPS/TCP/UDP
 - Source NAT support of IPv6
 - IPv6 access-list and object group
 - DHCPv6 relay
- ICMPv6 traffic is not automatically allowed. You must configure the corresponding management traffic policy to allow the ping request to ACE. However, the necessary Neighbor Discovery (ND) messages for ARP, duplication address detection are automatically permitted.
- Copying files over IPv6 to or from devices are not supported.
- The ACE supports IPv6 HA:
 - All the FT transport (ft vlan) is still on IPv4.
 - Track IPv6 host /peer will be supported

Logging In To the Cisco Application Networking Manager

You access ANM features and functions through a web-based interface. The following sections describe logging in, the interface, and terms used in ANM.

The ANM login window allows you to do the following tasks:

- Log into the ANM server.
- Change the password for your account (see the [“Changing Your Account Password”](#) section on page 1-6).
- Obtain online help by clicking **Help**.

Procedure

Step 1 Choose one the following:

- To log in after a new install, which uses the default web ports of 443 and 80, enter **https://host**.



Note You do not have to explicitly enter the default ports 443 and 80.



Caution

If you log in using HTTP, you must change the properties file. See the [“Changing ANM Software Configuration Attributes”](#) section on page 20-1 for details. If you enable HTTP, you make your connection to ANM less secure.

- To log in after an upgrade, enter **https://<host>:10443** or **https://<host>:10080**.



Note You must explicitly enter the nondefault ports 10443 and 10080.



Note All browsers require that cookies, Javascript/scripting, and popup windows are enabled. If you reinstall a subsequent ANM release, you must delete the cookies and clear the browser cache.

For example, enter **https://192.168.10.10:10443**. The login window appears.

Step 2 In the User Name field, enter **admin**, which is the predefined user account that comes with a new installation.



Note If you are logging in using ACS authentication (TACACS or RADIUS), you *must* add '@<organization>' to the username on the login page, or you will not be able to log in.

Once you are logged in using this account, you can create additional user accounts. For information on changing account passwords, see the [“Modifying User Accounts” section on page 18-21](#).

Step 3 In the Password field, enter the password that you configured the admin account with when installing ANM.

Step 4 Press **Enter** or click **Login**.

When you log in, the default page that appears is the ANM Homepage (see the [“ANM Windows and Menus” section on page 1-9](#)). You can change your default page by making a different selection from the Homepage. See the [“Customizing the Default ANM Page” section on page 2-4](#) for details.

For a description of the user interface, see [Figure 1-2 on page 1-8](#). The interface will not contain data until you add devices by one of the methods described in the [“Importing Network Devices into ANM” section on page 5-10](#).

Related Topics

- [Changing Your Account Password, page 1-6](#)
- [ANM Interface Components, page 1-8](#)

Changing Your Account Password

You can change your account password when you log into ANM.

Guidelines and Restrictions

By default, the feature that allows you to change your password when logging into ANM is enabled; however, this feature can be disabled. When disabled, the ANM login window no longer displays the Change Password hyperlink. For more information, see the [“Disabling the ANM Login Window Change Password Feature” section on page 18-50](#).

Procedure

-
- Step 1** Using a web browser, navigate to the ANM login window by typing the IP address or hostname where ANM is installed. For example, enter **https://192.168.10.10**. The login window appears.
- Step 2** In the User Name field, enter your account username.
- Step 3** Click **Change Password**. The Change password configuration window appears.
- Step 4** In the User Name field, enter the username of the account that you want to modify.
- Step 5** In the Old Password field, enter the current password for this account.
- Step 6** In the New Password field, enter the new password for this account.
- Password attributes such as minimum and maximum length or accepted characters are defined at the organizational level. For more information on configuring passwords, see the [“Configuring User Authentication and Authorization”](#) section on page 18-9.
- Step 7** In the Confirm New Password field, reenter the new password for this account.
- Step 8** Do one of the following:
- Click **OK** to save your entries and to return to the login window.
 - Click **Cancel** to exit this procedure without saving your entries and to return to the login window.
-

Related Topics

- [Logging In To the Cisco Application Networking Manager, page 1-5](#)
- [ANM Interface Components, page 1-8](#)
- [Disabling the ANM Login Window Change Password Feature, page 18-50](#)

ANM Licenses

Beginning with ANM software Version 5.2, ANM includes a 90-day evaluation period that begins when you install the software image. During this time, you can use all the functions of ANM without installing a license, including managing any number of supported devices and any number of ACE virtual contexts. However, to continue using ANM beyond the evaluation period, you must install the ANM server license, which is available at no charge.

The ANM demo license is also available, which allows ANM to perform all the functions associated with the ANM server license; however, the demo license has an expiration date associated with it. You can order a demo license if you do not know the PAK number required to order the ANM server license.

For more information about the 90-day evaluation period, available ANM licenses, and installing a license, see the [“Using ANM License Manager to Manage ANM Server or Demo Licenses”](#) section on page 18-54

Related Topics

[Using ANM License Manager to Manage ANM Server or Demo Licenses, page 18-54](#)

ANM Interface Components

This section includes the following topics:

- [ANM Windows and Menus, page 1-9](#)
- [ANM Buttons, page 1-11](#)
- [Table Conventions, page 1-14](#)
- [ANM Screen Conventions, page 1-17](#)

When you log in to ANM, the default window that appears is the Homepage from which you can access the operational and monitoring features of ANM. For details about using Homepage, see the “[Information About Homepage](#)” section on page 2-1).

[Figure 1-2](#) shows the Devices window (Config > Devices), which is an example ANM work window where you view the network device tree and perform network management tasks. [Table 1-1](#) describes the numbered fields.



Note

The ANM software version that displays across the top of the window varies depending on your version of ANM.

Figure 1-2 ANM Interface Components

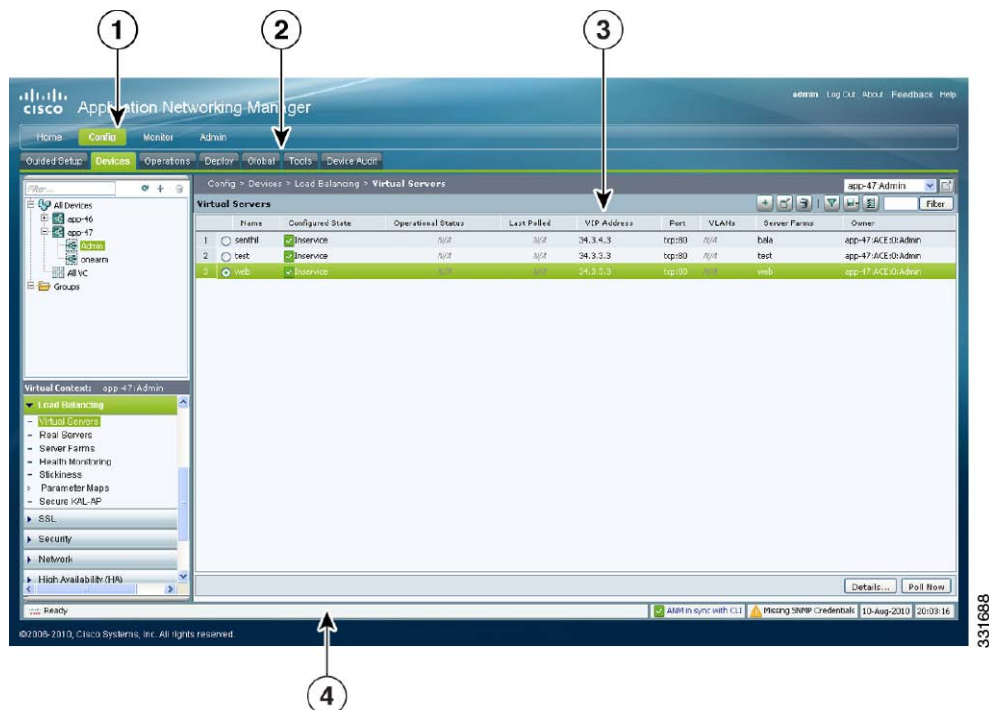

Table 1-1 ANM Interface Components Descriptions

Field	Description
1	Navigation pane, which contains the following components: <ul style="list-style-type: none"> • High-level navigation path within the ANM interface, which includes Config, Monitor, and Admin. You can click an item in the navigation path to view that window. • Logout hyperlink. • About hyperlink that provides ANM version information. • Feedback hyperlink that opens a new browser window containing the ANM user feedback form hosted on www.ciscofeedback.vovici.com. • Help hyperlink that provides context-sensitive help and a PDF version of the ANM user guide.
2	Second-level Navigation pane, which contains another level of navigation. Clicking an option in this pane displays the associated window in the content area.
3	Content area, which contains the display and input area of the window. It can include tables, configuration items, buttons, or combinations of these items.
4	Status bar, which indicates the date and time of the ANM server machine. ANM frequently updates the status bar.

Related Topics

- [ANM Windows and Menus, page 1-9](#)
- [ANM Interface Components, page 1-8](#)
- [Using Homepage, page 2-1](#)

ANM Windows and Menus

[Figure 1-3](#) contains many common window elements found in ANM and described in [Table 1-2](#). Not all windows contain all buttons.

**Note**

The ANM software version that displays across the top of the window varies depending on your version of ANM.

Figure 1-3 Example ANM Window

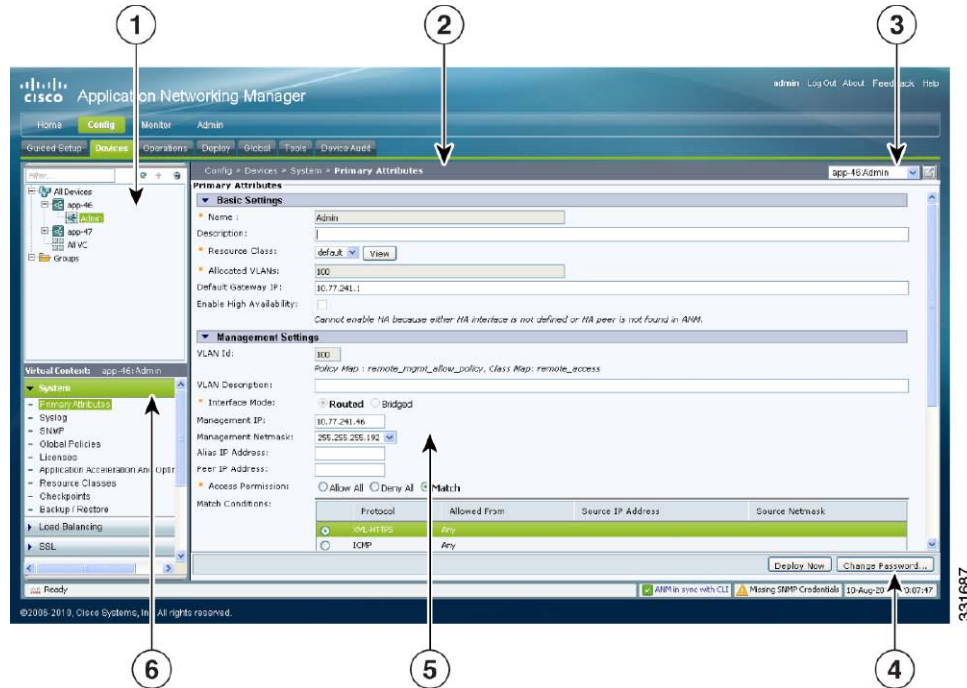

Table 1-2 Example ANM Window Descriptions

Number	Description
1	<p>Device tree that appears when you click Config or Monitor. The device tree includes All Devices and Groups folders:</p> <ul style="list-style-type: none"> The All Devices folder expands to show the names of imported Cisco devices and their associated modules or virtual contexts. When you click the plus sign (+) in front of a chassis icon, you can see a list of the modules in the chassis. When you expand an ACE appliance or ACE module, you can see the list of existing virtual contexts for that device. For more information about adding devices, see the “Importing Network Devices into ANM” section on page 5-10. The Groups folder contains the list of user-defined groups. For more information about user-defined groups, see the “Configuring User-Defined Groups” section on page 5-72. <p>The Organization tree displays when you click Admin > Role-Based Access Control. The organization tree includes all organizations in ANM. Choosing an organization name displays its details.</p> <p>To expand folders in the device tree, click the plus sign (+) to the right of an option. To collapse the structure, click the minus sign (-).</p> <p>At the top of the tree are the following buttons:</p> <ul style="list-style-type: none"> Refresh—Refreshes the device tree after you have imported devices or made changes to the User Groups. Plus sign (+)—Allows you to add an item to the selected option in the device tree. Garbage can—Deletes the selected entry. <p>Note Menus are based on device types. Although menu labels are the same for different device types, the actual menu definition is different. For example, you cannot preserve the menu state while traversing back and forth from a module to a virtual context in the device tree.</p>
2	Option menus, which appear in Config windows. Click the icon on the bar to show or hide the options.

Table 1-2 Example ANM Window Descriptions

Number	Description
3	Object selector. Use this field to choose a device, context, building block, or other object that you want to view information on or configure.
4	Command buttons. Use these buttons to perform the action identified by the button label.
5	Input fields. Use these fields to make selections and provide information. When there are more than three choices for any field, the field displays as a drop-down list. Otherwise, selections display with radio buttons.
6	Feature panel that contains functions that correspond to what is selected in the device or organization tree. Click on a command to expand the list of options that correspond to that command.

Related Topics

- [ANM Buttons, page 1-11](#)
- [ANM Screen Conventions, page 1-17](#)

ANM Buttons

Table 1-3 describes the buttons that appear in some of the Config, Monitor, and Admin windows.

Table 1-3 Button Descriptions







Button	Name	Description
	ACL table (expand)	Allows you to expand all ACL table entries.
	ACL table (collapse)	Allows you to collapse all ACL table entries.
	ACL table (resequence)	Allows you to open the resequence popup window that allows you to reorder the ACL table entries.
	Add	Allows you to add an entry to the displayed table.
	Add another	Saves the current entries and refreshes the window so that you can add another entry.
	Advanced editing mode	Allows you to view or enter advanced arguments for the chosen display.

Table 1-3 Button Descriptions (continued)





Button	Name	Description
	Auto refresh (pause)	Allows you to interrupt the table data autorefresh process.
	Auto refresh (resume)	Indicates that the table data autorefresh process is on pause and allows you to resume.
	Customize	Allows you to customize the table to suit your needs. (See the “Customizing Tables” section on page 1-15.)
	Delete	Deletes the chosen entry in the table.
	Duplicate	Duplicates the chosen entry in the table.
	Edit	Opens the configuration window of a chosen entry in the table.
	Groups	Allows you to create groups of the following objects: <ul style="list-style-type: none"> • Real servers (see the “Managing Real Server Groups” section on page 8-10) • Virtual servers (see the “Managing Virtual Server Groups” section on page 7-67) • GSS VIP answers or DVS rules (see the “Creating a VIP Answer or DNS Rule Group” section on page 7-77)
	Filter	Filters the displayed list of items according to the criteria that you specify. (See the “Filtering Entries” section on page 1-14.) Also displays a filter text box where strings can be entered.
	Go	Appears when filtering is enabled; updates the table with the filtering criteria.
	Key	Indicates that the associated field is a foreign key field. This field takes its values from another table.
	Plus	Displays a table with information related to the field where Plus appears. For example, if Plus appears next to the field label <i>VLAN Group</i> , clicking Plus displays a list of all VLAN groups in a separate window.

Table 1-3 Button Descriptions (continued)













Button	Name	Description
	Refresh	Refreshes the content area.
	Save	Displays the current information in a new window in either raw data or Microsoft Excel format so you can save it to a file or print it.
	Full window view	Allows you to adopt a larger (full) window view for a table or dashboard window.
	Reduced window view (normal)	Allows you to adopt a smaller window view for a table or dashboard window.
	Sort	Sorts a column alphabetically up or down.
	Stop	Stops the current process. If a process is only partially complete, it will finish its current operation and exit. For example, when stop is used during the import of two modules, it will complete only the first of two module imports.
	Switch between configure and browse modes	Displays the subtables for those items that have additional sets of parameters that can be configured, such as Config > Devices > Network > VLAN Interfaces. Note This button is not available on single-row tables such as Config > Devices > System > Syslog or Config > Devices > System > SNMP. To switch between these modes, navigate to another window where the button appears (for example, Config > Devices > Load Balancing > Server Farms), click the button to enter desired mode, then return to the window on which the button was missing. You will remain in the mode you chose.
	View Excel	Displays the raw data in Microsoft Excel format in a separate browser window.
	View raw data	Displays the raw data in table format.
	Show as image	Displays the historical data object graph in a separate browser window.

Table 1-3 Button Descriptions (continued)

Button	Name	Description
	View as chart	Toggles the display of a historical data object as a graph in the monitoring window.
	View as grid	Toggles the display of a historical data object as a numerical grid in the monitoring window. From this display, you can export the data in Microsoft Excel format.

Related Topics

- [ANM Windows and Menus, page 1-9](#)
- [ANM Screen Conventions, page 1-17](#)

Table Conventions

This section describes the ANMGUI table conventions, including how to filter the information displayed and how to customize a table's appearance.

This section includes the following topics:

- [Filtering Entries, page 1-14](#)
- [Customizing Tables, page 1-15](#)
- [Using the Advanced Editing Option, page 1-16](#)

Filtering Entries

You can filter the information that a table displays. Click **Filter** to view table entries using the criteria that you chose. When filtering is enabled, a filter row appears above the first table entry that allows you to filter entries in the following ways:

- In fields with drop-down lists, choose one of the ANM-identified categories (see [Figure 1-4](#)). The table refreshes automatically with the entries that match the chosen criterion.
- In fields without drop-down lists, enter the string that you want to match, and then click Go above the first table entry. The table refreshes with the entries that match your input.
- Enter the string in the filter box. For example, by entering the string gold and clicking Go, only the gold Resource Class virtual contexts appear (see [Figure 1-4](#)).

Figure 1-4 Example Table with Filtering Enabled



Name	Resource Class	Management IPs	CLI Sync Status	Last CLI Sync Status Change	ACE HA Status	ACE HA Peer	ACE HA Peer Status	Polling Status
1. app-46-Admin	gold	10.77.241.46	Out of sync	10-Aug-2010 20:16:25	Not	Not	Not	Missing SNMP Credentials
2. app-47-Admin	gold	10.77.241.47	OK	10-Aug-2010 20:16:41	Not	Not	Not	Missing SNMP Credentials

Related Topics

- [ANM Interface Components, page 1-8](#)
- [Customizing Tables, page 1-15](#)
- [Using the Advanced Editing Option, page 1-16](#)

Customizing Tables

You can customize a table for your use. Click **Customize** in a table to configure the table to suit your needs.

When you place the cursor over **Customize**, the following items appear:

- **Default**—When chosen with a check mark, this item indicates that the ANM default table format is being used by the current table.
- **Configure**—When chosen, this item opens a dialog box that allows you to create a new customized table format or to modify the table format currently in use.

Procedure

Step 1 When viewing a table, choose **Customize > Configure**.

The List Configuration dialog box appears.

Step 2 In the List Configuration dialog box, enter the information in [Table 1-4](#).



Note Depending on the table that you chose, the available fields in the configuration table differ. [Table 1-4](#) includes sample fields that might appear.



Note You can be as inclusive or as restrictive as you like when setting table configuration options.

Table 1-4 *Table Configuration Attributes*

Field	Description
List Customization Name	Unique name for a new table configuration.
Fields	Fields that you can include in the table, choose the fields from the Available Items list, and click Add. To remove fields from the table, choose the fields from the Selected Items list, and then click Remove.
Up/Down	Location of a column in the table that you can change. Choose its name in the column on the right, then click Up or Down to place it in the desired location.
Group By	Field that you want to group entries by. When you choose a field for grouping, one or more entries appears in the table with + at the beginning of the entry, the name of the field, the grouping criteria, and the number of items in the group. Click + to view all entries in the group.
Descending	Descending check box to sort the groups in reverse order. Clear the Descending check box to sort the groups in ascending order.

Table 1-4 Table Configuration Attributes (continued)

Field	Description
Sort By	Field that you want to sort entries by. When you choose a field for sorting, all entries in the table are sorted according to the values in the selected field.
Name Filter	Name that represents the name of each field in the table. Enter the string or value that you want to filter the results by. You can enter complete or partial strings or values to be matched. Do not include wildcard characters.
Version Filter	Version that represents the name of each field in the table. Enter the string or value that you want to filter the results by. You can enter complete or partial strings or values to be matched. Do not include wildcard characters.

Step 3 Do one of the following:

- Click **Save** to save your entries under a new name and to close the List Configuration dialog box. If a table using this format is displayed, the table is updated automatically.
- Click **Cancel** to exit the procedure without saving your entries and to close the List Configuration dialog box.
- Click **Apply** to apply your current entries to the table that you are viewing, to save your entries, and to close the List Configuration dialog box.
- Click **Delete** to delete the currently selected customized table format. It no longer appears as an option when you click **Customize**.

Related Topics

- [ANM Interface Components, page 1-8](#)
- [Filtering Entries, page 1-14](#)
- [Using the Advanced Editing Option, page 1-16](#)

Using the Advanced Editing Option

By default, tables include columns that contain configured attributes or a subset of columns related to a key field.

To view all configurable attributes in table format, click **Advanced Editing Mode** (the highlighted button in [Figure 1-5](#)). When advanced editing mode is enabled, all columns appear for your review (see [Figure 1-5](#)).

Figure 1-5 Advanced Editing Enabled Window



Related Topics

- [ANM Interface Components, page 1-8](#)
- [Filtering Entries, page 1-14](#)
- [Customizing Tables, page 1-15](#)

ANM Screen Conventions

Table 1-5 describes other conventions used in ANM screens.

Table 1-5 ANM Window Conventions

Convention	Example	Description
Dimmed field		If no items are selected, buttons are dimmed. If an item is selected, only operational buttons appear.
Red asterisk	* Policy Name:	A red asterisk indicates a required field.
Yellow field with red font		Incorrect, invalid, or incomplete entries appear as red font against a yellow background with the reason for that error. In the example, an IP address cannot begin with four digits, which results in this display.
Drop-down lists	<p>* Policy Name: 255.255.255.128</p> <p>* VLAN to use: 255.255.255.224</p> <p>* Management IP: 255.255.255.248</p> <p>* Management Netmask: 255.255.255.252</p> <p>255.255.255.254</p> <p>255.255.255.255</p> <p>255.255.255.128</p>	When there are more than three choices for any field, the field displays as a drop-down list. Otherwise, selections display with radio buttons.

Related Topics

- [Table Conventions, page 1-14](#)

- [ANM Interface Components, page 1-8](#)



CHAPTER 2

Using Homepage

This section describes how to use Homepage, which is a launching point for quick access to selected areas within Cisco Application Networking Manager (ANM).

This chapter includes the following sections:

- [Information About Homepage, page 2-1](#)
- [Customizing the Default ANM Page, page 2-4](#)

Information About Homepage

Homepage allows you to have quick access to the following operations and guided setup tasks in ANM:

- Operational tasks that you can access:
 - The Real Servers table to view information for each configured real server, activate or suspend real servers listed in the table, or modify server weight and connection limits.
 - The Virtual Servers table to view information for each configured virtual server and to activate or suspend virtual servers listed in the table.
 - The Cisco Global Site Selector (GSS) Answer table to manage GSS VIP answers (resources that respond to content queries) by specifying virtual IP (VIP) addresses associated with a server load balancer (SLB) such as the Cisco Content Services Switch (CSS), Cisco Content Switching Module (CSM), Cisco IOS-compliant SLB, LocalDirector, or a web server.
 - The DNS Rules table to specify actions in the DNS rules table for the GSS to take when it receives a request from a known source (a member of a source address list) for a known hosted domain (a member of a domain list).
- Monitoring—Connect to the central Device Dashboard where you can quickly view device and virtual context monitoring results and track potential issues; view detailed context-level resource usage information; and monitor load balancing statistics for virtual servers.
- Guided setup tasks that you can launch:
 - The Import Devices guided setup task to establish communication between ANM and hardware devices.
 - The Cisco Application Control Engine (ACE) Hardware Setup task to configure ACE devices that are new to the network by establishing network connectivity in either standalone or high-availability (HA) deployments.
 - The Virtual Context Setup task to create and connect an ACE virtual context.
 - The Application Setup task to configure end-to-end load-balancing for your application.

- **Configuration**—Tasks that allow you to configure system attributes for a virtual context, control a user’s access to ANM, and display configuration and deployment changes logged in the ANM database.
- **Documentation**—Quick links to ANM, ACE module, and ACE appliance user documentation on www.cisco.com.
- **System Summary**—Tasks that allow you to display critical alarm notifications when the value for a specific statistic rises above the specified setting or display all critical events received from an ACE device for syslog and SNMP traps from all virtual contexts.

By default, the ANM Homepage (see [Figure 2-1](#)) is the first page that appears in ANM after you log in. To access the Homepage from other locations within ANM, click the **Home** menu option at the top of the window. From the Homepage, you can customize which page you want to display for subsequent logins into ANM. See the [“Customizing the Default ANM Page”](#) section on [page 2-4](#) for details.

**Note**

All menu options on the Homepage are under Role-Based Access Control (RBAC). Menu options will be grayed if proper permission has not been granted to the logged in user by the administrator. See the [“How ANM Handles Role-Based Access Control”](#) section on [page 18-8](#) for more information about RBAC in ANM.

**Note**

The ANM software version that displays across the top of the window varies depending on your version of ANM.

Figure 2-1 *Homepage Window*

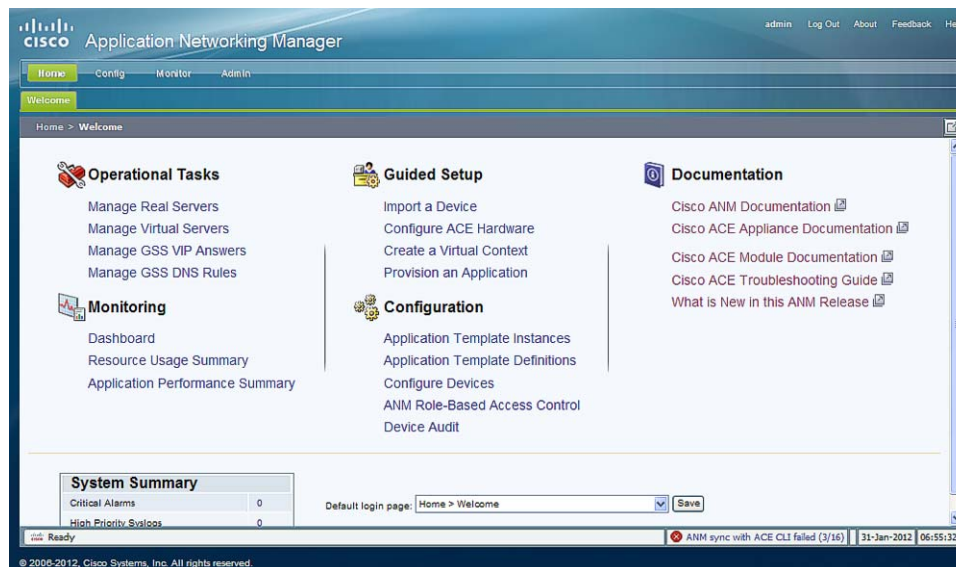

Table 2-1 identifies the Homepage links, associated pages in ANM, and related topics that can be found in this document.

Table 2-1 *Homepage Links*

Homepage Link	ANM Page	Related Topics
Operational Tasks		
Manage Real Servers	Config > Operations > Real Servers	Managing Real Servers, page 8-9
Manage Virtual Servers	Config > Operations > Virtual Servers	Managing Virtual Servers, page 7-66
Manage GSS VIP Answers	Config > Operations > GSS VIP Answers	Managing GSS VIP Answers, page 7-73
Manage GSS DNS Rules	Config > Operations > DNS Rules	Activating and Suspending DNS Rules Governing GSS Load Balancing, page 7-75
Monitoring		
Dashboard	Monitor > Devices > Dashboard	Using Dashboards to Monitor Devices and Virtual Contexts, page 17-4
Resource Usage Summary	Monitor > Devices > Resource Usage > Connections	Monitoring System Traffic Resource Usage, page 17-27
Application Performance Summary	Monitor > Devices > Load Balancing > Virtual Servers	Monitoring Load Balancing, page 17-33
Guided Setup		
Import a Device	Config > Guided Setup > Import Devices	Using Import Devices, page 3-4
Configure ACE Hardware	Config > Guided Setup > ACE Hardware Setup	Using ACE Hardware Setup, page 3-5
Create a Virtual Context	Config > Guided Setup > Virtual Context Setup	Using Virtual Context Setup, page 3-10
Provision an Application	Config > Guided Setup > Application Setup	Using Application Setup, page 3-12
Configuration		
Configure Devices	Config > Devices > System > Primary Attributes	Configuring Virtual Context Primary Attributes, page 6-14
ANM Role-Based Access Control	Admin > Role-Based Access Control > Users	Managing User Accounts, page 18-17
Device Audit	Config > Device Audit	Performing Device Audit Trail Logging, page 18-59
Application Configs	Config > Global > Application Configs	Managing Application Template Instances, page 4-3
Application Config Templates	Config > Global > Application Config Templates	Managing Application Template Definitions, page 4-15
System Summary		
Critical Alarms	Monitor > Alarm Notifications > Alarms	Displaying Alarms in ANM, page 17-65
High Priority Syslogs	Monitor > Events > Events	Monitoring Events, page 17-55
Documentation		

Table 2-1 Homepage Links (continued)

Homepage Link	ANM Page	Related Topics
Operational Tasks		
Cisco ANM Documentation (link to documentation set on www.cisco.com)	N/A	N/A
Cisco ACE Appliance Documentation (link to documentation set on www.cisco.com)	N/A	N/A
Cisco ACE Module Documentation (link to documentation set on www.cisco.com)	N/A	N/A
Cisco ACE Troubleshooting Guide (link to DocWiki)	N/A	N/A
What is New in this ANM Release (link to release notes on www.cisco.com)		

**Note**

For information about the navigational tabs and hyperlinks located at the top of the Homepage window, see the [“ANM Interface Components”](#) section on page 1-8.

Customizing the Default ANM Page

You can choose the default page that you access after logging in to ANM. By default, the ANM Homepage is the first page that appears after you log in. From the ANM Homepage, you can specify a different page that appears as the default page after you log in.

Procedure

-
- Step 1** If the Homepage is not active in ANM, click the Home tab. The Homepage appears.
- Step 2** From the Default Login Page drop-down list, choose one of the following pages that you want to appear after you log in to ANM:
- Home > Welcome
 - Config > Guided Setup
 - Config > Devices
 - Config > Operations > Real Servers
 - Config > Operations > Virtual Servers
 - Config > Operations > GSS VIP Answers
 - Config > Operations > GSS DNS Rules

- Config > Deploy
- Config > Device Audit
- Monitor > Devices > Dashboard
- Monitor > Devices > Resource Usage
- Monitor > Devices > Traffic Summary
- Monitor > Devices > Load Balancing > Real Servers
- Monitor > Devices > Load Balancing > Probes
- Monitor > Devices > Load Balancing > Statistics
- Monitor > Devices > Load Balancing > Application Acceleration (ACE appliance only)
- Monitor > Events
- Monitor > Alarm Notifications > Alarms

Step 3 Click **Save** to save your new selection as the default page the next time that you log in to ANM.



CHAPTER 3

Using ANM Guided Setup

Date: 3/28/12

This chapter describes how to use Cisco Application Networking Manager (ANM) Guided Setup.



Note

When naming ACE objects (such as a real server, virtual server, parameter map, class map, health probe, and so on), enter an alphanumeric string of 1 to 64 characters, which can include the following special characters: underscore (_), hyphen (-), dot (.), and asterisk (*). Spaces are not allowed.

If you are using ANM with an ACE module or ACE appliance and you configure a named object at the ACE CLI, keep in mind that ANM does not support all of the special characters that the ACE CLI allows you to use when configuring a named object. If you use special characters that ANM does not support, you may not be able to import or manage the ACE using ANM.

This chapter includes the following sections:

- [Information About Guided Setup, page 3-1](#)
- [Guidelines and Limitations, page 3-4](#)
- [Using Import Devices, page 3-4](#)
- [Using ACE Hardware Setup, page 3-5](#)
- [Using Virtual Context Setup, page 3-10](#)
- [Using Application Setup, page 3-12](#)

Information About Guided Setup

ANM Guided Setup provides a series of setup sequences that offer GUI window guidance and networking diagrams to simplify the configuration of ANM and the network devices that it manages.

Guided Setup allows you to quickly perform the following tasks:

- Establish communication between ANM and Application Control Engine (ACE) hardware devices.
- Configure ACE devices that are new to the network by establishing network connectivity in either standalone or high-availability (HA) deployments.
- Create and connect to an ACE virtual context.
- Set up load balancing application from an ACE to a group of back-end servers.

To access Guided Setup, click the Config tab located at the top of the window, then click Guided Setup.

**Note**

The available menu and button options on the Guided Setup tasks are under Role-Based Access Control (RBAC). Menu and button options will be grayed if proper permission has not been granted to the logged in user by the administrator. See the “[How ANM Handles Role-Based Access Control](#)” section on [page 18-8](#) for more information about RBAC in ANM.

[Table 3-1](#) identifies the individual guided setup tasks and related topics.

Table 3-1 *Guided Setup Tasks and Related Topics*

Guided Setup Tasks	Purpose	Related Topics
Import devices	Launch the Import Devices setup task to establish communication between ANM and hardware devices. Imported devices can include: ACE modules, ACE appliances, Catalyst 6500 series chassis, Catalyst 6500 Virtual Switching System (VSS) 1440, Cisco 7600 series routers, Content Services Switches (CSS) devices, Content Switching Module (CSM) devices, or Global Site Selector (GSS) devices.	<ul style="list-style-type: none"> • Using Import Devices, page 3-4 • Information About Importing Devices, page 5-4 • Preparing Devices for Import, page 5-4 • Importing Network Devices into ANM, page 5-10 • Discovering Large Numbers of Devices Using IP Discovery, page 5-27
ACE hardware setup	Launch the ACE Hardware Setup task to help you configure ACE devices that are new to the network by establishing network connectivity in either standalone or high-availability (HA) deployments.	<ul style="list-style-type: none"> • Using ACE Hardware Setup, page 3-5 • Configuring Devices, page 5-34 • Configuring ACE Module and Appliance Role-Based Access Controls, page 5-53 • Managing Devices, page 5-66 • Configuring ACE High Availability Peers, page 13-15

Table 3-1 Guided Setup Tasks and Related Topics

Guided Setup Tasks	Purpose	Related Topics
Virtual context setup	Launch the Virtual Context Setup task to create and connect an ACE virtual context.	<ul style="list-style-type: none"> • Using Virtual Context Setup, page 3-10 • Using Resource Classes, page 6-43 • Creating Virtual Contexts, page 6-2 • Configuring Virtual Contexts, page 6-8 • Configuring VLANs Using Cisco IOS Software (ACE Module), page 12-3
Application setup	Launch the Application Setup task to configure load balancing for your application. This task guides you through a complete end-to-end configuration of the ACE for many common server load-balancing situations.	<ul style="list-style-type: none"> • Using Application Setup, page 3-12 • Creating an Application Template Instance, page 4-4 • Configuring Virtual Context VLAN Interfaces, page 12-6 • Configuring Virtual Context BVI Interfaces, page 12-19 • Configuring Virtual Context Static Routes, page 12-28 • Configuring Virtual Context BVI Interfaces, page 12-19 • Configuring Security with ACLs, page 6-78 • SSL Setup Sequence, page 11-4

Guidelines and Limitations

As you perform a Guided Setup task, use the following operating conventions:

- To move between steps, click the name of the step in the menu to the left.
- The steps for each task are listed in an order that is designed to prevent problems during later steps; however, you can skip steps if you know they are not applicable to your application.
- Depending on your user privileges, ANM may prevent you from making changes on certain steps.
- You must save and deploy any changes you want to keep before leaving each page.
- Each task can be run as many times as you like.

Using Import Devices

You can use the Import Device task to import ACE modules, ACE appliances, Catalyst 6500 series chassis, Catalyst 6500 Virtual Switching System (VSS) 1440, Cisco 7600 series routers, CSS devices, CSM devices, or GSS devices into ANM. You must import the hardware devices before ANM can manage them.

Before You Begin

- Because ANM communicates with network devices through Secure Shell (SSH) and other protocols, you must set up your devices to allow ANM to collect data from them. See the [“Preparing Devices for Import”](#) section on page 5-4.
- Before ANM can import a device, you must ensure that the device has a management interface that ANM can access. Also, you need the IP address and credentials for the device's management interface in order to import it.
- If the ACE module is new and retains its factory settings, you can configure basic management during the import process by using the Bare Blade option.

Procedure

Step 1 Choose **Config > Guided Setup > Import Devices**.

The Import Devices window appears, which includes the All Devices table.

Step 2 At the top of the All Devices table, click **Add (+)** to import a new device.

The New Device window appears.

Step 3 Enter the information for the specific device and complete the import devices procedure as described in [“Importing Network Devices into ANM”](#) section on page 5-10.



Note To manage modules inside a Catalyst 6500 series switch, you must first import the Catalyst into the All Devices table.

To import modules from a Catalyst that is already imported, choose the Catalyst switch from the All Devices table and click **Modules** below the All Devices table.

**Note**

The time required to import depends on the size of the existing configuration on each device. The process can range from a few minutes to 30 minutes or more for a very large configuration.

- Step 4** After you finish importing the ACE devices (module or appliance) into ANM, continue to the ACE Hardware Setup task to guide you through the basic device setup and network configuration. See the “Using ACE Hardware Setup” section on page 3-5.

Related Topics

- [Information About Importing Devices, page 5-4](#)
- [Preparing Devices for Import, page 5-4](#)
- [Importing Network Devices into ANM, page 5-10](#)
- [Discovering Large Numbers of Devices Using IP Discovery, page 5-27](#)
- [Using ACE Hardware Setup, page 3-5](#)

Using ACE Hardware Setup

You can use the ACE Hardware Setup task to configure ACE devices that are new to the network by establishing network connectivity in either standalone or high-availability (HA) deployments.

Before You Begin

Before you can set up the ACE hardware using ANM, you must use the Import Devices task to import the ACE into ANM if you have not already. See the “Using Import Devices” section on page 3-4.

Assumptions

- You can extend the functionality of the ACE by installing licenses. If you plan to extend the ACE functionality, ensure that you have received the proper software license key for the ACE, that ACE licenses are available on a remote server for importing to the ACE, or you have received the software license key and have copied the license file to the disk0: file system on the ACE using the **copy path/filename1 disk0:** CLI command.

**Note**

See either the *Cisco Application Control Engine Module Administration Guide* or *Cisco 4700 Series Application Control Engine Appliance Administration Guide* for details on the **copy path/filename1 disk0:** CLI command.

- You must be in the Admin virtual context on an ACE device (ACE module or ACE appliance) to configure ACE devices that are new to the network.
- When importing an ACE HA pair into ANM, you should follow one of the following configuration requirements so that ANM can uniquely identify the ACE HA pair:
 - Use a unique combination of FT interface VLAN and FT IP address/peer IP address for every ACE HA pair imported into ANM. For HA, it is critical that the combination of FT interface VLAN and IP address/peer IP address is always unique across every pair of ACE peer devices.

- Define a peer IP address in the management interface using the management IP address of the peer ACE (module or appliance). The management IP address and management peer IP address used for this definition should be the management IP address used to import both ACE devices into ANM.



Note For more information about the use of HA pairs imported into ANM, see the [“ANM Requirements for ACE High Availability”](#) section on page 5-8.

- When you are configuring the ACE, changes to the physical interfaces (including Gigabit Ethernet ports or port channels) can result in a loss of connectivity between ANM and the ACE. Use caution when following the ACE Hardware Setup task if you are modifying the interface that management traffic is traversing.

Procedure

Step 1 Choose **Config > Guided Setup > ACE Hardware Setup**.

The ACE Hardware Setup window appears, which includes the ACE Device and Configuration Type drop-down lists.

Step 2 From the ACE Device drop-down list, choose an ACE device (module or appliance).

Step 3 From the Configuration Type drop-down list, choose whether to set up the ACE as a standalone device or as a member of a high-availability (HA) ACE pair:

- Standalone—The ACE is not to be used in an HA configuration.
- HA Secondary—The ACE is to be the secondary peer in an HA configuration.
- HA Primary—The ACE is to be the primary peer in an HA configuration.



Note Ensure that you complete the ACE hardware setup task for the secondary device *before* you set up the primary device.

Step 4 Click **Start Setup**.

The License window appears (Config > Guided Setup > ACE Hardware Setup > Licenses). Cisco offers licenses for ACE modules and appliances that allows you to increase the number of default contexts, bandwidth, and SSL TPS (transactions per second). For more information, see either the *Cisco Application Control Engine Module Administration Guide* or the *Cisco 4700 Series Application Control Engine Appliance Administration Guide* on cisco.com.

If you need to install licenses at this point, go to Step 5.

If you do not need to install licenses at this point, go to Step 6.

Step 5 Install one or more ACE licenses (see the [“Managing ACE Licenses”](#) section on page 6-36).



Note For an ACE primary and secondary HA pair, because each ACE license is only valid on a single hardware device, licenses are not synchronized between HA peer devices. You must install an appropriate version of each license independently on both the primary and secondary ACE devices.

- Step 6** Click **SNMP v2c Read-Only Community String** under ACE Hardware Setup (Config > Guided Setup > ACE Hardware Setup > SNMP v2c Read-Only Community String).

The SNMP v2c Read-Only Community String window appears.

Perform the following actions to configure an SNMP community string (a requirement for an ACE to be monitored by ANM):

- a. Click **Add (+)** at the top of the SNMP v2c Read-Only Community String table to create an SNMP community string. The New SNMP v2c Community window appears.



Note For ANM to monitor an ACE, you must configure an SNMPv2c community string in the Admin virtual context.

- b. In the Read-Only Community field, enter the SNMP read-only community string name. Valid entries are unquoted text strings with no spaces and a maximum of 32 characters.

Additional SNMP configuration selections are available under Config > Devices > context > System > SNMP. See the [“Configuring SNMP for Virtual Contexts”](#) section on page 6-27.

- Step 7** If you are configuring an ACE appliance, to group physical ports together on the ACE appliance to form a logical Layer 2 interface called the port-channel (sometimes known as EtherChannels), click **Port Channel Interfaces** under ACE Hardware Setup.

The Port Channel Interfaces window appears (Config > Guided Setup > ACE Hardware Setup > Port Channel Interfaces).



Note You must configure port channels on both the ACE appliance and the switch that the ACE is connected to.

Perform the following actions to configure a port channel interface:

- a. If you want to poll the devices and display the current values, click **Poll Now**, and then **OK** when prompted if you want to poll the devices for data now.
- b. At the top of the Port Channel Interfaces table, click **Add (+)** to add a port channel interface, or choose an existing port channel interface and click **Edit** to modify it. The New Port Channel Interface window appears.



Note If you click Edit, not all of the fields can be modified.

- c. Enter the port channel interface attributes as described in the [“Configuring Port-Channel Interfaces for the ACE Appliance”](#) section on page 12-35.
- d. Click **Deploy Now** to deploy this configuration on the ACE and save your entries to the running-configuration and startup-configuration files.
- e. To display statistics and status information for a port-channel interface, choose the interface from the Port Channel Interfaces table and click **Details**. The **show interface port-channel** CLI command output appears. See the [“Displaying Port Channel Interface Statistics and Status Information”](#) section on page 12-40 for details.

- Step 8** If you are configuring an ACE appliance, to configure one or more of the Gigabit Ethernet ports on the appliance, click **GigabitEthernet Interfaces** under ACE Hardware Setup. The GigabitEthernet Interfaces window appears (Config > Guided Setup > ACE Hardware Setup > GigabitEthernet Interfaces).
- If you want to poll the devices and display the current values, click **Poll Now**, and then **OK** when prompted if you want to poll the devices for data now.
 - Choose an existing Gigabit Ethernet interface and click **Edit** to modify it.
 - Enter the Gigabit Ethernet physical interface attributes as described in the [“Configuring Gigabit Ethernet Interfaces on the ACE Appliance”](#) section on page 12-32.
 - Click **Deploy Now** when completed to deploy this configuration on the ACE and save your entries to the running-configuration and startup-configuration files.
 - Repeat Steps a through c for each Gigabit Ethernet interface that you want to configure.
 - To display statistics and status information for a particular Gigabit Ethernet interface, choose the interface from the GigabitEthernet Interfaces table, then click **Details**. The **show interface gigabitEthernet** CLI command output appears. See the [“Displaying Gigabit Ethernet Interface Statistics and Status Information”](#) section on page 12-35 for details.
- Step 9** If the ACE is a member of an HA ACE pair, click **VLAN Interfaces** under ACE Hardware Setup. The VLAN Interfaces window appears (Config > Guided Setup > ACE Hardware Setup > VLAN Interfaces).



Note To prevent loss of management connectivity during an HA configuration, you must configure the IP addresses of the management VLAN interface correctly for your HA setup. During this procedure, choose the management VLAN interface (and click the **Edit** button) and make sure its IP address, alias IP address, and peer IP address are all set correctly. You can repeat this process for any VLAN interfaces that you want. If the management VLAN is properly configured before establishing HA, you will be able to return later to reconfigure other VLANs.

- If you want to poll the devices and display the current values, click **Poll Now**, and then **OK** when prompted if you want to poll the devices for data now.
- Click **Add** to add a new VLAN interface, or choose an existing VLAN interface and click **Edit** to modify it.



Note If you click Edit, not all of the fields can be modified.

- Enter the VLAN interface attributes as described in the [“Configuring Virtual Context VLAN Interfaces”](#) section on page 12-6. Click **More Settings** to access the additional VLAN interface attributes. By default, ANM hides the default VLAN interface attributes and the VLAN interface attributes which are not commonly used.
- Click **Deploy Now** to deploy this configuration on the ACE and save your entries to the running-configuration and startup-configuration files.
- To display statistics and status information for a VLAN interface, choose the VLAN interface from the VLAN Interface table, then click **Details**. The output of the **show interface vlan**, **show ipv6 interface vlan**, and **show ipv6 neighbor** CLI commands appears. The IPv6 commands require ACE module and ACE appliance software Version A5(1.0) or later. See the [“Displaying VLAN Interface Statistics and Status Information”](#) section on page 12-18 for details.

Step 10 If the ACE is the primary peer in a high availability (HA) configuration, click **HA Peering** under ACE Hardware Setup (Config > Guided Setup > ACE Hardware Setup > HA Peering).

- a. Click **Edit** below the HA Management section to configure the primary ACE and the secondary ACE as described in the [“Configuring ACE High Availability Peers”](#) section on page 13-15. There are two columns, one for the selected ACE and another for a peer ACE.

You can specify the following information:

- Identify the two members of a HA pair.
- Assign IP addresses to the peer ACEs.
- Assign an HA VLAN to HA peers and bind a physical Gigabit Ethernet interface to the FT VLAN.
- Configure the heartbeat frequency and count on the peer ACEs in a fault-tolerant VLAN.

When completed, click **Deploy Now** to deploy this configuration on the ACE and save your entries to the running-configuration and startup-configuration files.



Note For ACE modules, the HA VLAN specified for ACE HA Groups must also be set up on the Catalyst 6500 series switch using the **svclc** command. See the [“Configuring VLANs Using Cisco IOS Software \(ACE Module\)”](#) section on page 12-3 for details.

- b. Click **Add** below the ACE HA group table to add a new high availability group. Enter the information in the configurable fields as described in the [“Configuring ACE High Availability Peers”](#) section on page 13-15. When completed, click **Deploy Now** to deploy this configuration on the ACE and save your entries to the running-configuration and startup-configuration files.

The HA State field displays FT VLAN Compatible once HA setup has been successfully completed.



Note To display statistics and status information for a particular HA group, choose the group from the ACE HA Groups table and click **Details**. The **show ft group group_id detail** CLI command output appears. See the [“Displaying High Availability Group Statistics and Status”](#) section on page 13-21 for details.

Step 11 Once the HA State field in the ACE HA Groups table shows a successful state, the ACE is ready for further configuration as follows:

- To set up additional virtual contexts, continue to the Virtual Context Setup task to create and connect an ACE virtual context. See the [“Using Virtual Context Setup”](#) section on page 3-10.
- To set up an application in an existing virtual context, continue to the Application Setup task to set up load-balancing for an application from an ACE to a group of back-end servers. See the [“Using Application Setup”](#) section on page 3-12.

Related Topics

- [Using Import Devices, page 3-4](#)
- [Configuring Devices, page 5-34](#)
- [Configuring ACE Module and Appliance Role-Based Access Controls, page 5-53](#)
- [Managing Devices, page 5-66](#)

Using Virtual Context Setup

You can use the Virtual Context Setup task to create and connect an ACE virtual context. Virtual contexts use virtualization to partition your ACE appliance or module into multiple virtual devices, or contexts. Each context contains its own set of policies, interfaces, resources, and administrators.

Before You Begin

You must be in the Admin context on the ACE to create a new user context.

Procedure

Step 1 Choose **Config > Guided Setup > Virtual Context Setup**.

The Virtual Context Setup window appears.

Step 2 From the ACE Device drop-down list, choose an ACE.

Step 3 Click **Start Setup**.

The Resource Classes window appears (Config > Guided Setup > Virtual Context Setup > Resource Classes).

Perform the following tasks to create or modify a resource class:

- a. If you want to create a resource class, click **Add (+)**. The New Resource Class configuration window appears. Enter the resource information as described in the [“Configuring Global Resource Classes” section on page 6-46](#).
- b. If you want to modify an existing resource, choose the resource class that you want to modify, then click **Edit**. The Edit Resource Class configuration window appears. Enter the resource information as described in the [“Modifying Global Resource Classes” section on page 6-50](#).
- c. Click **OK** to save your entries and to return to the Resource Classes table.

Make note of the resource class that you want to use because you will need it in Step 5.

Step 4 Click **Virtual Context Management** under Virtual Context Setup.

The Virtual Context window appears (Config > Guided Setup > Virtual Context Setup > Virtual Context Management).

Perform the following actions to create or modify a virtual context:

- a. If you want to create a virtual context, click **Add (+)**. The New Virtual Context window appears. Configure the virtual context as described in the [“Configuring Virtual Contexts” section on page 6-8](#).
- b. If you want to modify an existing virtual context, choose the virtual context that you want to modify and click **Edit**. The Edit Resource Class configuration window appears. Enter the resource information as described in the [“Modifying Global Resource Classes” section on page 6-50](#).

Step 5 To create or modify the attributes of a virtual context, configure the virtual context as described in the [“Configuring Virtual Contexts” section on page 6-8](#).

When completed, click **Deploy Now** to deploy this configuration on the ACE and save your entries to the running-configuration and startup-configuration files. Follow these guidelines when creating or modifying the virtual context:

- To connect the virtual context to the available VLANs, specify one or more VLANs in the Allocated VLANs field. You can specify multiple VLAN values and ranges (for example, “10, 14, 70-79”).
- For virtual contexts configured for an ACE, do the following:

- For an ACE appliance, you must set up all VLANs used in this step as trunk or access VLANs on the port channel or Gigabit Ethernet interfaces. If you did not set up these VLANs during the ACE Hardware Setup task, you can return to the ACE Hardware Setup window to configure the required VLANs. See the [“Using ACE Hardware Setup” section on page 3-5](#).
- For an ACE module, you must set up all VLANs used in this step as trunk or access VLANs on the Catalyst 6500 series switch using the `svclc` command. See the [“Configuring VLANs Using Cisco IOS Software \(ACE Module\)” section on page 12-3](#) for details.
- When specifying the resource class for the virtual context, choose the resource class that you created or specified in Step 3.



Note If you are unsure of the resource class to use for this virtual context, choose **default**. You can change the resource class setting at a later time.

- If HA has been correctly configured for this ACE device, the High Availability checkbox will be checked. If the checkbox is unchecked, check it to instruct ANM to automatically configure synchronization for this virtual context.



Note The High Availability checkbox is available only if HA Peering has previously been completed for the ACE hardware.

- If you want to set up a separate management VLAN interface for the virtual context, under Management Settings, configure the management interface for this virtual context and create an admin user. Each context also has its own management VLAN that you can access using the ANM GUI. In this case, you would assign an independent VLAN and IP address for management traffic to access the virtual context.

Step 6 To edit the load-balancing configuration for a virtual context, continue to the Application Setup task. See the [“Using Application Setup” section on page 3-12](#).

Related Topics

- [Using Import Devices, page 3-4](#)
- [Using ACE Hardware Setup, page 3-5](#)
- [Information About Virtual Contexts, page 6-2](#)
- [Using Resource Classes, page 6-43](#)
- [Creating Virtual Contexts, page 6-2](#)
- [Configuring Virtual Contexts, page 6-8](#)
- [Configuring VLANs Using Cisco IOS Software \(ACE Module\), page 12-3](#)
- [Using Application Setup, page 3-12](#)

Using Application Setup

This section includes the following topics on application setup:

- [ACE Network Topology Overview, page 3-12](#)
- [Using Application Setup, page 3-14](#)

ACE Network Topology Overview

With respect to ACE configuration, the network topology describes where—which VLAN or subnet—client traffic comes into the ACE and where this traffic is sent to real servers. Network configuration for ACE load balancing depends on the surrounding topology. By specifying to ANM the topology that is appropriate for your networking application, ANM can present more relevant options and guidance.

The network topology is often determined solely by your existing network; however, the goals for your ACE deployment can also play a role. For example, when ACE acts as a router between clients and servers, it provides a level of protection by effectively hiding the servers from the clients. On the other hand, for a routed topology to work, each of those servers must be configured to route back through the ACE, which can be a significant change to the network routing.

The ACE is also capable of bridging the client and server VLANs, which does not affect server routing. However, it does require the network to have VLANs set up appropriately.

If you are not sure what topology to use, or do not want to make topology decisions immediately, use the “one-armed” topology. The one-armed topology does not typically require any changes to an existing network and can be set up with minimal knowledge of the network. You can then expand your ACE network topology to routed mode or bridged mode to better suit your networking requirements.

[Figure 3-1](#) illustrates the one-armed network topology.

Figure 3-1 Example of a One-Armed Network Topology

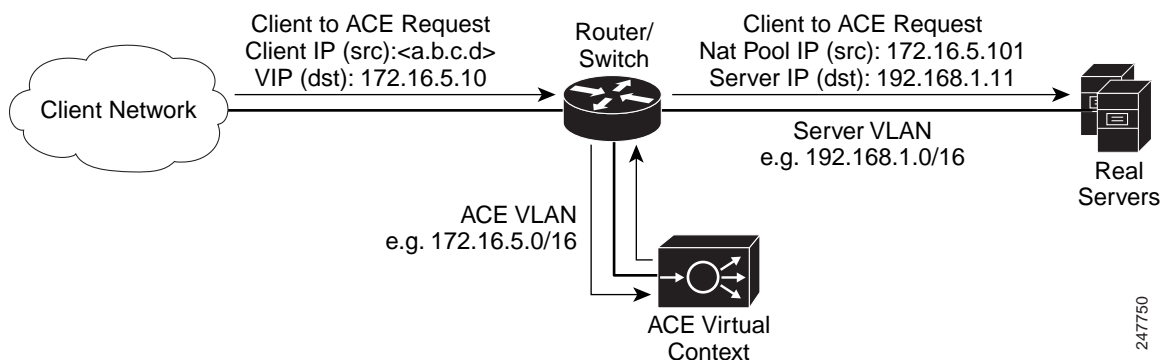

Figure 3-2 illustrates the routed mode network topology.

Figure 3-2 Example of a Routed Mode Network Topology

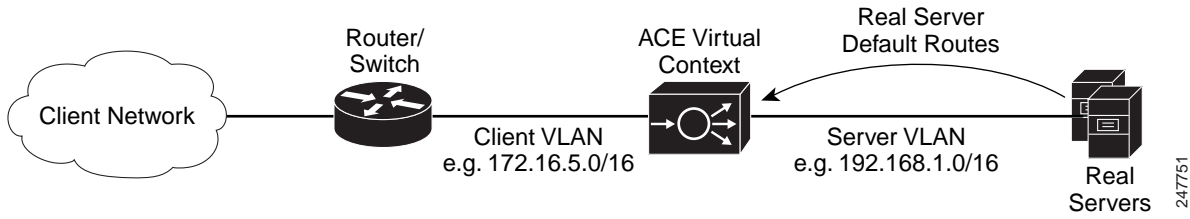
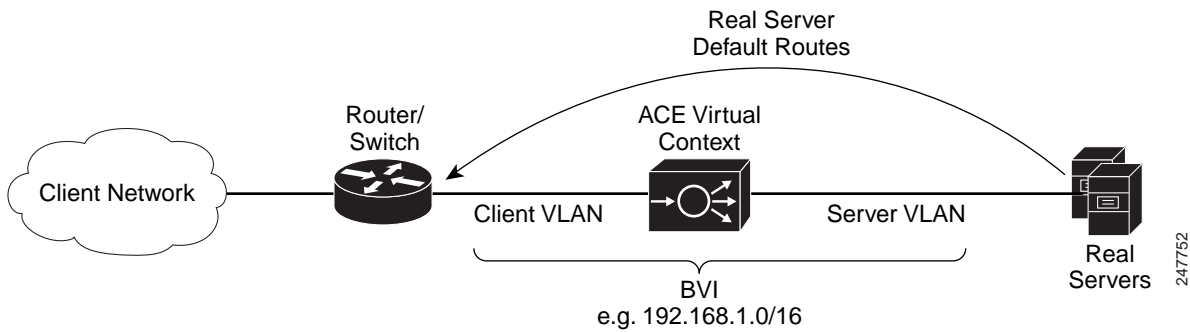

Figure 3-3 illustrates the bridged mode network topology.

Figure 3-3 Example of a Bridged Mode Network Topology



Using Application Setup

You use the Application Setup task to set up load balancing for an application in which you choose an application type, virtual context to configure, and network topology (see [Figure 3-4](#)). ANM Guided Setup displays a list of configuration attributes to define that is based on your choice of application type and network topology.

Figure 3-4 Guided Setup: Application Setup

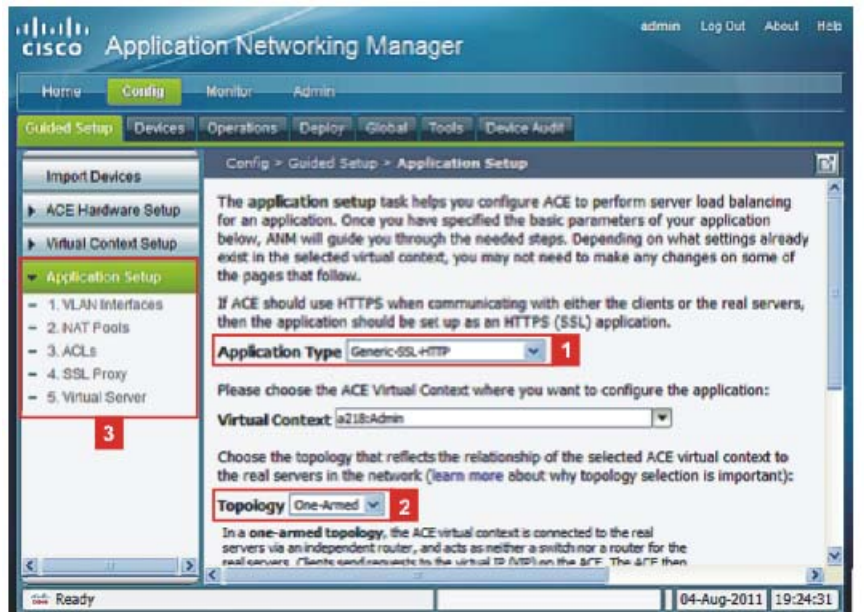

Selected Application Type (1) and Topology (2) determine the Application Setup configuration attributes (3) that display.

881421

Guidelines and Restrictions

The Application Type drop down list (see [Figure 3-4](#)) includes both non-template and template-based options. The template-based options are application definition templates that allow you to quickly configure one or more ACE virtual contexts (or devices) with a complex configuration for well known or custom in-house applications. A template can be a Cisco-defined system template or it can be user-defined. The number of system templates that display in the drop-down list increases as more of these templates become available during ANM upgrades or you import them into ANM from the Cisco Developers Network. For more information, see the [“Information About Application Template Definitions and Instances”](#) section on page 4-1.

By default, all system templates display in the Application Type drop down list. You can edit a template so that it does not display in this list. For more information, see the [“Editing an Application Template Definition”](#) section on page 4-15.

Procedure

-
- Step 1** Choose **Config > Guided Setup > Application Setup**.
The Application Setup window appears.
- Step 2** From the Application Type drop-down list, choose an application as follows:

- Non-template options—Choose one of the following application types if you do not want to create an application that is not based on a system or user-defined template:
 - **Generic-SSL-HTTP**—Choose this application type if your ACE is to use HTTPS when communicating with either the client or with real servers.
 - **Generic-Non-SSL**—Choose this application type if your ACE is to use HTTP when communicating with either the client or with real servers.

These applications allow you to create an application that is more granular in terms of the number of attributes that you can configure using Guided Setup compared to an application based on a system or user template.

- Template-based options—Choose one of the application types that are based on a system template provided with ANM or a user-defined template. Examples of system templates include the following:
 - **Microsoft Exchange**
 - **Microsoft SharePoint**

For more information, see “[Guidelines and Restrictions](#).”

- Step 3** From the Select Virtual Context drop-down list, choose an existing ACE virtual context.
- Step 4** Choose the network topology that reflects the relationship of the selected ACE virtual context to the real servers in the network.
- Topology choices include one-armed, routed, or bridged. See the “[ACE Network Topology Overview](#)” section on page 3-12 for background details on networking topology.
- Step 5** Click **Start Setup**.
- Step 6** Configure the attributes that are associated with the selected application type and topology and listed under Application Setup (see [Figure 3-5](#)) and described in [Table 3-2](#), which includes all possible attributes.

Figure 3-5 Navigating Application Setup Configuration Attributes

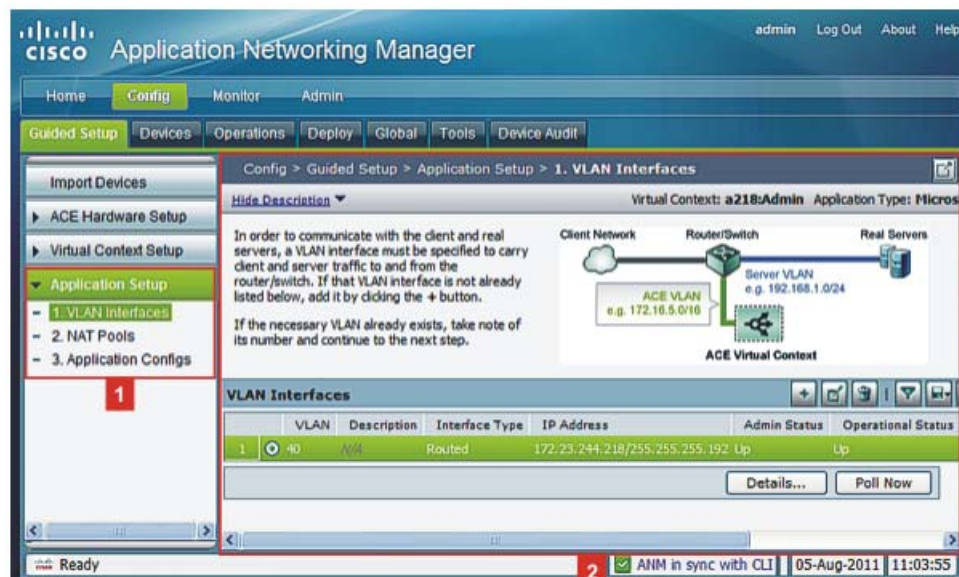

Click an **Application Setup** configuration attribute (1) to display its configuration window (2).

331420

**Note**

As you complete and deploy an attribute configuration, go to the next one by clicking on the attribute listed under Application Setup (see [Figure 3-5](#)).

Table 3-2 Guide Setup Configuration Attributes

Attribute	Description
VLAN Interfaces	<p>To communicate with the client and real servers, a VLAN interface must be specified for client and server traffic to be sent and received.</p> <p>Perform the following actions to configure a VLAN interface:</p> <ol style="list-style-type: none"> <li data-bbox="267 642 1474 705">a. If you want to poll the devices and display the current values, click Poll Now, and then click OK when prompted to poll the devices for data. <li data-bbox="267 720 1474 783">b. Click Add to add a new VLAN interface, or choose an existing VLAN interface and click Edit to modify it. <li data-bbox="267 798 1474 919">c. Enter the VLAN interface attributes. Click More Settings to access the additional VLAN interface attributes. By default, ANM hides the default VLAN interface attributes and the VLAN interface attributes that are not commonly used. For configuration details, see the “Configuring Virtual Context VLAN Interfaces” section on page 12-6. <p> Note After you define the VLAN, write down the VLAN number. You need this number when configuring the ACLs and Virtual Server attributes.</p> <ol style="list-style-type: none"> <li data-bbox="267 1087 1474 1150">d. Click Deploy Now to deploy this configuration on the ACE and save your entries to the running-configuration and startup-configuration files. <li data-bbox="267 1165 1474 1316">e. To display statistics and status information for a VLAN interface, choose the VLAN interface from the VLAN Interface table, then click Details. The output of the show interface vlan, show ipv6 interface vlan, and show ipv6 neighbor CLI commands appears. The IPv6 commands require ACE module and ACE appliance software Version A5(1.0) or later. See the “Displaying VLAN Interface Statistics and Status Information” section on page 12-18 for details.

Table 3-2 Guide Setup Configuration Attributes (continued)



Attribute	Description
BVI Interfaces	<p>Perform the following actions to configure a BVI interface:</p> <ol style="list-style-type: none"> If you want to poll the devices and display the current values, click Poll Now, and then OK when prompted if you want to poll the devices for data now. Click Add to add a new BVI interface, or choose an existing BVI interface, then click Edit to modify it. Enter the BVI interface attributes. For configuration details, see the “Configuring Virtual Context BVI Interfaces” section on page 12-19. <p> Note After you define the BVI, write down the client-side VLAN number. You need this number when configuring the ACLs and Virtual Server attributes.</p> <ol style="list-style-type: none"> Click Deploy Now to deploy this configuration on the ACE and save your entries to the running-configuration and startup-configuration files. To display statistics and status information for a BVI interface, choose the BVI interface from the BVI Interface table, then click Details. The show interface bvi, show ipv6 interface bvi, and show ipv6 neighbors CLI commands output appears. The IPv6 commands require ACE module and ACE appliance software Version A5(1.0) or later. See the “Displaying BVI Interface Statistics and Status Information” section on page 12-26 for details.
NAT Pools	<p>To set up a one-armed topology, you need a NAT pool to provide the set of IP addresses that ACE can use as source addresses when sending requests to the real servers.</p> <p> Note You must configure the NAT pool on the same VLAN interface that you configured in Step 6.</p> <p>Perform the following actions to create or modify a NAT pool for a VLAN:</p> <ol style="list-style-type: none"> Click Add to add a new NAT pool entry, or choose an existing NAT pool entry and click Edit to modify it. The NAT Pool configuration window appears. Configure the NAT pool attributes. For configuration details, see the “Configuring VLAN Interface NAT Pools” section on page 12-26. <p> Note After you define the NAT pool, write down the NAT pool ID. You specify the NAT pool ID when configuring the Virtual Server attributes.</p> <ol style="list-style-type: none"> Click Deploy Now to deploy this configuration on the ACE and save your entries to the running-configuration and startup-configuration files.

Table 3-2 Guide Setup Configuration Attributes (continued)



Attribute	Description
ACLs	<p>An ACL applies to one or more VLAN interfaces. Each ACL consists of a list of entries, each of which defines a source, a destination, and whether to permit or deny traffic between those locations.</p> <p>Perform the following actions to create or modify an ACL:</p> <ol style="list-style-type: none"> Click Add to add a new ACL entry, or choose an existing ACL entry and click Edit to modify it. The Access List configuration window appears. Add or edit the required fields. For configuration details, see the “Configuring Security with ACLs” section on page 6-78. Click Deploy to save this configuration. To display statistics and status information for an ACL, choose an ACL from the ACLs table, then click Details. The <code>show access-list access-list detail</code> CLI command output appears. See the “Displaying ACL Information and Statistics” section on page 6-89 for details.
SSL Proxy	<p> Note To terminate or initiate HTTPS connections with ACE, the virtual context must have at least one SSL proxy service. An SSL proxy contains the certificate and key information needed to terminate HTTPS connections from the client or initiate them to the servers.</p> <p>Perform the following actions to create or modify an SSL proxy service:</p> <ol style="list-style-type: none"> To create an SSL proxy service, click SSL Proxy Setup. <p> Note To edit an existing SSL proxy service, choose it from the SSL Proxy table, and click Edit to modify the SSL proxy service. The SSL Proxy Service configuration window appears. Edit the required fields as described in the “Configuring SSL Proxy Service” section on page 11-27.</p> <ol style="list-style-type: none"> Add required fields. For configuration details, see the “Configuring SSL Proxy Service” section on page 11-27. Click Deploy Now to deploy this configuration on the ACE and save your entries to the running-configuration and startup-configuration files.

Table 3-2 Guide Setup Configuration Attributes (continued)

Attribute	Description
Virtual Server	<p>The virtual server defines the load-balancing configuration for an application. Perform the following actions to create or modify a virtual server:</p> <ol style="list-style-type: none"> If you want to poll the devices and display the current values, click Poll Now, and then OK when prompted if you want to poll the devices for data now. Click Add to add a new virtual server, or choose an existing virtual server, and click Edit to modify it. The Virtual Server configuration window appears with a number of configuration subsets. The subsets that you see depend on whether you use the Basic View or the Advanced View and entries you make in the Properties subset. Change views by using the View object selector at the top of the configuration pane. Add or edit required fields. For configuration details, see the “Virtual Server Configuration Procedure” section on page 7-7. Table 7-1 identifies and describes virtual server configuration subsets with links to related topics for configuration information. Virtual servers have many configuration options. At a minimum, you need to configure the following attributes: <ul style="list-style-type: none"> – Set the VIP, port number (TCP or UDP), and application protocol for your application. <p> Note If the ACE is to terminate the client HTTPS connections, choose HTTPS as the Application Protocol.</p> <ul style="list-style-type: none"> – (One-Armed Topology) For VLAN, choose the VLAN defined in VLAN Interfaces. – (Routed Topology) For VLAN, choose the client-side VLAN defined VLAN Interfaces. – (Bridged Topology) For VLAN, choose the client-side VLAN defined in VLAN Interfaces. – If the ACE is to terminate client HTTPS connections, then under the SSL Termination header, specify the SSL proxy defined in SSL Proxy. – Under the Default L7 Loadbalancing Action, set Primary Action to Loadbalance. – Create a server farm that contains one or more real servers for this application (see Table 7-13 in the “Configuring Virtual Server Layer 7 Load Balancing” section for details on setting server farm attributes). – If the ACE is to initiate HTTPS connections to the real servers, choose the desired SSL proxy for initiation to this application from the menu next to SSL Initiation. – (One-Armed Topology) Under NAT, enter the NAT pool ID from Step 8. <p>After you set up a base virtual server, you can test it to validate your configuration and isolate any issues in your networking application. You can then add these more advanced load balancing options to your networking application:</p> <ul style="list-style-type: none"> – Additional real servers to a server farm. See Table 7-13 in the “Configuring Virtual Server Layer 7 Load Balancing” section for details. – Health monitoring probes and attributes for the specific probe type. See Table 7-14 in the “Configuring Virtual Server Layer 7 Load Balancing” section for details. – Stickiness, where client requests for content are to be handled by a sticky group when match conditions are met. See Table 7-15 in the “Configuring Virtual Server Layer 7 Load Balancing” section for details.

Table 3-2 Guide Setup Configuration Attributes (continued)

Attribute	Description
Virtual Server (continued)	<ul style="list-style-type: none"> <li data-bbox="308 308 1476 405">– Application protocol inspection, where the ACE allows the virtual server to verify protocol behavior and identify unwanted or malicious traffic passing through the ACE. See the “Configuring Virtual Server Protocol Inspection” section for details. <li data-bbox="259 422 1476 485">d. Click Deploy Now to deploy this configuration on the ACE and save your entries to the running-configuration and startup-configuration files. <li data-bbox="259 501 1476 625">e. To display statistics and status information for an existing virtual server, choose a virtual server from the Virtual Servers table, then click Details. The show service-policy global detail CLI command output appears. See the “Displaying Virtual Server Statistics and Status Information” section on page 7-65 for details.
Application Config	<p data-bbox="259 630 1476 693">You can create an application configuration or modify one that is staged (not deployed). Perform the following actions to create or modify an application configuration:</p> <ul style="list-style-type: none"> <li data-bbox="259 709 1476 772">a. Click Add to add a new application config, or choose an existing application config with a Type of Staged, and click Edit to modify it. The Application Configuration window appears. <li data-bbox="259 789 1476 852">b. Configure or edit the required fields. For configuration details, see the “Creating an Application Template Instance” section on page 4-4. <li data-bbox="259 869 1476 1050">c. Do one of the following: <ul style="list-style-type: none"> <li data-bbox="308 911 1476 974">– Click Deploy Now to deploy this application config on the ACE and save your entries to the running-configuration and startup-configuration files. <li data-bbox="308 991 1476 1054">– Click Save to save the information but not deploy the application config to the ACE. Use this option if you want to deploy or complete the configuration at a later time.

Related Topics

- [Using Import Devices, page 3-4](#)
- [Using ACE Hardware Setup, page 3-5](#)
- [Using Virtual Context Setup, page 3-10](#)
- [Configuring Virtual Context VLAN Interfaces, page 12-6](#)
- [Configuring Virtual Context BVI Interfaces, page 12-19](#)
- [Configuring Virtual Context Static Routes, page 12-28](#)
- [Configuring Virtual Context BVI Interfaces, page 12-19](#)
- [Configuring Security with ACLs, page 6-78](#)
- [SSL Setup Sequence, page 11-4](#)



CHAPTER 4

Using Application Template Definitions

Date: 3/28/12

This chapter describes how to use Cisco Application Networking Manager (ANM) application template definitions for configuring ACE virtual contexts.



Note

This chapter uses the terms “virtual context” and “device” interchangeably.



Note

When naming ACE objects (such as a real server, virtual server, parameter map, class map, health probe, and so on), enter an alphanumeric string of 1 to 64 characters, which can include the following special characters: underscore (_), hyphen (-), dot (.), and asterisk (*). Spaces are not allowed.

If you are using ANM with an ACE module or ACE appliance and you configure a named object at the ACE CLI, keep in mind that ANM does not support all of the special characters that the ACE CLI allows you to use when configuring a named object. If you use special characters that ANM does not support, you may not be able to import or manage the ACE using ANM.

This chapter includes the following sections:

- [Information About Application Template Definitions and Instances, page 4-1](#)
- [Managing Application Template Instances, page 4-3](#)
- [Managing Application Template Definitions, page 4-15](#)

Information About Application Template Definitions and Instances

The ANM *application template definitions* allow you to quickly configure one or more ACE virtual contexts (or devices) with a complex configuration for well-known or custom in-house applications. A template is defined by an XML template definition file, which contains the configuration that is deployed to a device with place holders for variable replacement. The template variables are presented to the user in the ANM GUI.

The two types of application template definitions are as follows:

- System templates—Defined by Cisco and included in ANM for major applications. You can edit a system file to customize it if needed.

Examples of system templates are as follows:

- Basic HTTP
 - DNS
 - DWS with Cisco Nexus 7000 OTV
 - FTP
 - Java Application Server
 - Layer 3 LB
 - Layer 4 LB
 - Microsoft Exchange 2010
 - Microsoft SharePoint 2010
 - RDP
 - Secure Webserver
- User-defined templates—User defined for custom applications. You can create a user-defined template that is based on an existing template or you can create a template using the base code provided in this chapter.

The template file follows a specific schema that is defined by ANM. All user-defined templates must follow this schema before ANM can deploy it to an ACE. You can create or edit a template using the internal ANM template editor or you can use the template export and import feature that allows you to use an external XML editor.

Using application template definitions, you create *application template instances*, which are based on the template that you choose. You can display and manage application template instances on a global or device-specific level.

Guidelines and Restrictions

The variable fields of an application template definition are role-based access controlled (RBAC), which means that when you use a template to create an application template instance, your user account must be configured with the required roles that will allow you to enter the variable information. ANM does not allow you to enter variable information for those fields that you are not permitted to fill in. If you are not permitted to enter all the variable information, you can save the incomplete template instance with the information that you are allowed to input, and then have a user with the required roles complete the template instance so that it can be deployed.

Related Topics

- [Managing Application Template Instances, page 4-3](#)
- [Managing Application Template Definitions, page 4-15](#)

Managing Application Template Instances

Application template instances are ACE configurations that you create based on a specific application template definition. ANM maintains a table of the template instances that you create using ANM, which you can view by doing one of the following:

- To display the template instances of all devices, display the global view by doing one of the following:
 - Choose **Home** and from the Configuration category, choose **Application Template Instances**.
 - Choose **Config > Global > Application Template Instances**.
- To display only the template instances associated with a specific device, choose **Config > Devices > context > Load Balancing > Application Template Instances**.

The Application Template Instances window appears, displaying the information described in [Table 4-1](#).

Table 4-1 Application Template Instances Window

Field	Description
Name	Application template instance name.
Application Type	Name of the application template definition used to create the template instance.
Device	Virtual context associated with the template instance.
Type	Template instance type as follows: <ul style="list-style-type: none"> • Staged—Template instance is saved but has not been deployed. • Deployed—Template instance is saved and deployed to the device.
Status	Current status of the template instance as follows: <ul style="list-style-type: none"> • Complete—Template instance attributes have all been defined and the template instance can be deployed if the Type field displays Staged (see the “Deploying a Staged Application Template Instance” section on page 4-7). • Incomplete—Template instance attributes have not all been defined so it cannot be deployed. This status is possible only when the Type field displays Staged.
Last Updated Time	Last time that ANM retrieved the status information.

From the Application Template Instances window, you can perform such tasks as creating, editing, deploying, or deleting a template instance.



Note

ANM tracks only application template instances that you create and deploy using ANM. It does not discover template instances that may reside on an ACE. For example, if you use the CLI to configure an ACE with a configuration that matches an installed application template configuration, you will not see this configuration listed as a template instance in the ANM GUI (Config > Global > Application Template Instances).

This section includes the following topics:

- [Creating an Application Template Instance, page 4-4](#)
- [Deploying a Staged Application Template Instance, page 4-7](#)

- [Editing an Application Template Instance, page 4-9](#)
- [Duplicating an Application Template Instance, page 4-10](#)
- [Viewing and Editing Application Template Instance Details, page 4-12](#)
- [Deleting an Application Template Instance, page 4-13](#)

Creating an Application Template Instance

You can create an application template instance by configuring a virtual context using an application template definition.

Prerequisites

You must have a user account with the following RBAC tasks assigned to it:

ace_interface=modify, ace_access-list=modify, ace_ssl=modify, ace_vip=modify

Procedure

-
- Step 1** Display the Application Template Instances window by doing one of the following:
- Choose **Home** and from the Configuration category, choose **Application Template Instances**.
 - Choose **Config > Devices > context > Load Balancing > Application Template Instances**.
 - Choose **Config > Global > Application Template Instances**.

For information about the information that is displayed, see [Table 4-1](#).



Note You can also create a template instance using Application Setup (see the [“Using Application Setup”](#) section on page 3-12).

- Step 2** From the Application Template Instances window, click the **Add** icon (+).
The New Application Template Instance dialog box appears.
- Step 3** In the dialog box, do the following:
- From the Application Type drop-down list, choose one of the system templates provided with ANM or a user-defined template.
The number of system templates that display in the drop-down list will increase as more templates become available and you import them into ANM.
 - Click **OK**. The dialog box closes and the template configuration attributes appear in the Application Template Instances window.
- Step 4** (Optional) From the Application Template Instances window, choose one of the following view settings from the drop-down list located at the top of the window:
- **Basic View**—Displays only the variable fields that require user input. Variable fields that are optional or are configured with default values are hidden.
 - **Advanced View**—Displays all available variable fields.

**Note**

The Basic/Advanced display option appears only when a variable field in the application template definition file uses the “advanced” attribute (see the [“Creating an Application Template Definition Using the ANM Template Editor”](#) section on page 4-21). The DWS with Nexus 7000 OTV system template is an example of a template that uses the advanced attribute.



Step 5 From the Application Template Instances window, configure the variable attributes.

[Table 4-2](#) describes some variable attributes that are associated with the system templates included with ANM. Use the information provided here to define the variables.

Table 4-2 System Template Attributes

Field	Description
Application Configuration	Visual grouping of application-specific options.
Application Config Name	Name of the application that is used as a base name for many ACE objects, such as class maps, policy maps, stickies, or server farms.
VIP Address/Exchange VIP Address	Application server VIP address, which is generally the IP address that appears in DNS for the application. You can enter an IPv4 or IPv6 formatted address here; however, IPv6 requires ACE software Version A5(1.0) or later. Optionally, an IPv4 can include a prefix of /32 or less, and an IPv6 address can include a prefix of /128 or less.
Real Server IP/ Client Access Servers (CAS)/ SharePoint Web Front End Servers Addresses	IP addresses of the servers that are being load balanced. You can enter an IPv4 or IPv6 formatted address here; however, IPv6 requires ACE software Version A5(1.0) or later.
Relative Probe URL	File location that the ACE health check probes.
FQDN	Fully qualified domain name that is used for web host redirection. The %H string redirects based on the hostname in the header of the client HTTP requests.
Web Front End Port	Real server port on which the service is running.
Secure communications between Load Balancers and Servers	Check box option that when checked, instructs the ACE to use SSL to encrypt the traffic between it and the real servers.
Key Type	SSL key type. Choose one of the following from the drop-down list: <ul style="list-style-type: none"> • PKCS12 • DER • PEM
SSL Key URL	Field that appears only when the Key Type field is set to PKCS12 or DER. The TFTP, FTP, or SFTP URL including a key server IP address. You must use two forward slashes (//) to do absolute references; otherwise, the user home directory is used as the base path.
Key Server Username	Field that appears only when the Key Type field is set to PKCS12 or DER. The username to use for SFTP or FTP with the SSL key URL.
Key Server Password	Field that appears only when the Key Type field is set to PKCS12 or DER. The password to use for SFTP or FTP with the SSL key URL.
SSL Key	Field that appears only when the Key Type field is set to PEM. The SSL key that the ACE uses to decrypt and encrypt traffic from the client.

Table 4-2 System Template Attributes (continued)

Field	Description
SSL Certificate	Field that appears only when the Key Type field is set to PEM. The SSL certificate that the ACE presents to the client.
Cert/Key Passphrase	Optional passphrase that the key and certificate are encrypted.
Session Persistence	Check box option that when checked, enables session persistence. Depending on the type of template, the persistence type is generally either IP Netmask or HTTP Cookie.
Redirect from 80 to 443	Check box option that when checked, configures an automatic HTTP redirect.  Note When you enable this option, you must specify a FQDN .
Network Configuration	Visual grouping of network-specific options.
Load Balancer (Device: Virtual Context)	Virtual context to which the template is deployed. When you access the Application Template Instances window through device configurations (Config > Devices > context > Load Balancing > Application Template Instances), this field is already populated with the specified virtual context. When you access the Application Template Instances window through the Home page or global configuration, choose the virtual context from the drop-down device tree.
Client VLANs	VLANs on which client traffic originates.
Enable Source NAT	Check box option that when checked, specifies that traffic from the servers must have source NAT applied in order to return to the ACE. In general, you do not want to enable this feature if your ACE is installed in a one-armed network topology (see the “ACE Network Topology Overview” section on page 3-12).  Note You must define NAT pools on the server interfaces before you select this option.

Step 6 Do one of the following:

- Click **Deploy** to deploy the template instance to the device. The deployment verification popup window appears. Go to [Step 7](#).



Note The Deploy option requires a user account with the following RBAC task assigned to it: ace_virtualcontext=create.

- Click **Stage** to save the template instance without deploying it to the specified virtual context.
- Click **Cancel** to exit the configuration window without saving your changes.

Step 7 From the popup window, do one of the following:

- Click **OK** to deploy the template instance. The Deploy dialog box appears, which displays the list of configuration attributes to be deployed. Go to [Step 8](#).
- Click **Cancel** to exit this procedure without deploying the template instance.

Step 8 In the dialog box, do the following:

- a. (Optional) Check the **Create Named Checkpoint** check box to create a checkpoint that ANM does not delete after a successful deployment.

This check box works as follows:

- Unchecked—ANM creates a checkpoint that you can revert back to if the deployment of the staged application template is unsuccessful. ANM assigns a random name to the checkpoint and deletes the checkpoint after a successful deployment.
- Checked—ANM creates a checkpoint that you name and can revert back to at any time because ANM does not delete it even after a successful deployment.



Note ACE virtual contexts have a limit of 10 checkpoints. If you attempt to exceed this limit, ANM does not deploy the template instance.

- Do one of the following:
 - Click **Deploy Now**. The template instance is applied to the device running-configuration and startup-configuration files. The Results window appears with the deployment status as follows:
 - Deployment Successful
 - Error in deploying template: *error_details*
 - Click **Cancel** to cancel the deployment.
-

Related Topics

- [Information About Application Template Definitions and Instances, page 4-1](#)
- [Managing Application Template Instances, page 4-3](#)
- [Deploying a Staged Application Template Instance, page 4-7](#)
- [Editing an Application Template Instance, page 4-9](#)
- [Duplicating an Application Template Instance, page 4-10](#)
- [Viewing and Editing Application Template Instance Details, page 4-12](#)
- [Deleting an Application Template Instance, page 4-13](#)

Deploying a Staged Application Template Instance

You can deploy an application template instance that has been saved (or staged) but not yet deployed to the device.

Prerequisites

You must have a user account with the following RBAC task assigned to it: `ace_virtualcontext=create`.

Procedure

-
- Step 1** Display the Application Template Instances window by doing one of the following:
- Choose **Home** and from the Configuration category, choose **Application Template Instances**.
 - Choose **Config > Devices > context > Load Balancing > Application Template Instances**.
 - Choose **Config > Global > Application Template Instances**.

For information about the information that is displayed, see [Table 4-1](#).

Step 2 From the Application Template Instances window, choose the staged template instance to deploy and click **Deploy**.

The deployment verification popup window appears.

Step 3 From the popup window, do one of the following:

- Click **OK** to deploy the template instance. One of the following popups appear depending on the template instance status:
 - Complete template instance—The Deploy dialog box appears, which displays the list of configuration attributes to be deployed. Go to [Step 4](#).
 - Incomplete template instance—A popup window appears with the following message:

```
The selected instance is not completely filled. Do you want to proceed to edit screen?
```

 Do one of the following:
 - Click **OK** to proceed to the edit window where you can complete the template instance as described in the [“Editing an Application Template Instance”](#) section on page 4-9.
 - Click **Cancel** to return to the Application Template Instances window.
- Click **Cancel** to exit this procedure without deploying the template instance.

Step 4 In the dialog box, do the following:

- a. (Optional) Check the **Create Named Checkpoint** check box to create a checkpoint that ANM does not delete after a successful deployment.

This check box works as follows:

- Unchecked—ANM creates a checkpoint that you can revert back to if the deployment of the staged application template is unsuccessful. ANM assigns a random name to the checkpoint and deletes the checkpoint after a successful deployment.
- Checked—ANM creates a checkpoint that you name and can revert back to at any time because ANM does not delete it even after a successful deployment.



Note ACE virtual contexts have a limit of 10 checkpoints. If you attempt to exceed this limit, ANM does not deploy the template instance.

- b. Do one of the following:
- Click **Deploy Now**. The template instance is applied to the device running-configuration and startup-configuration files. The Results window appears with the deployment status as follows:
 - Deployment Successful
 - Error in deploying template: *error_details*
 - Click **Cancel** to cancel the deployment.
-

Related Topics

- [Information About Application Template Definitions and Instances, page 4-1](#)
- [Managing Application Template Instances, page 4-3](#)
- [Creating an Application Template Instance, page 4-4](#)
- [Editing an Application Template Instance, page 4-9](#)

- [Duplicating an Application Template Instance](#), page 4-10
- [Viewing and Editing Application Template Instance Details](#), page 4-12
- [Deleting an Application Template Instance](#), page 4-13

Editing an Application Template Instance

You can edit a staged application template instance.

Guidelines and Restrictions

This topic includes the following guidelines and restrictions:

- To edit an application template instance, it must display as the type Staged. You cannot edit a template instance that displays as the type Deployed.
- To retain the original template instance and make changes to a copy of it, go to the [“Duplicating an Application Template Instance”](#) section on page 4-10.

Prerequisites

You must have a user account with the following RBAC tasks assigned to it:

ace_interface=modify, ace_access-list=modify, ace_ssl=modify, ace_vip=modify

Procedure

-
- Step 1** View the list of application template instances by doing one of the following:
- To display the template instances of all devices, display the global view by doing one of the following:
 - Choose **Home** and from the Configuration category, choose **Application Template Instances**.
 - Choose **Config > Global > Application Template Instances**.
 - To display only the template instances associated with a specific device, choose **Config > Devices > context > Load Balancing > Application Template Instances**.
- The Application Template Instances window appears, displaying the information described in [Table 4-2](#).
- Step 2** From the Application Template Instances window, choose a staged template instance to edit and click the **Edit** icon ().
- The Application Configuration window appears, displaying the configured variable attributes.
- Step 3** From the Application Configuration window, edit the configuration as needed.
- For information about configuring the attributes, see [Table 4-2](#).
- Step 4** When your edits are complete, do one of the following:
- Click **Deploy** to deploy the template instance to the device. The deployment verification popup window appears. Go to [Step 5](#).
 - Click **Stage** to save the template instance without deploying it to the specified virtual context.
 - Click **Cancel** to exit the configuration window without saving your changes.
- Step 5** From the popup window, do one of the following:
- Click **OK** to deploy the template instance. The Deploy dialog box appears, which displays the list of configuration attributes to be deployed. Go to [Step 6](#).

- Click **Cancel** to exit this procedure without deploying the template instance.

Step 6 From the Deploy dialog box, do the following:

- (Optional) Check the **Create Named Checkpoint** check box to create a checkpoint that ANM does not delete after a successful deployment.

This check box works as follows:

- Unchecked—ANM creates a checkpoint that you can revert back to if the deployment of the staged application template is unsuccessful. ANM assigns a random name to the checkpoint and deletes the checkpoint after a successful deployment.
- Checked—ANM creates a checkpoint that you name and can revert back to at any time because ANM does not delete it even after a successful deployment.



Note ACE virtual contexts have a limit of 10 checkpoints. If you attempt to exceed this limit, ANM does not deploy the template instance.

- Do one of the following:
 - Click **Deploy Now**. The template instance is applied to the device running-configuration and startup-configuration files. The Results window appears with the deployment status as follows:
 - Deployment Successful
 - Error in deploying template: *error_details*
 - Click **Cancel** to cancel the deployment.
-

Related Topics

- [Information About Application Template Definitions and Instances, page 4-1](#)
- [Managing Application Template Instances, page 4-3](#)
- [Creating an Application Template Instance, page 4-4](#)
- [Deploying a Staged Application Template Instance, page 4-7](#)
- [Duplicating an Application Template Instance, page 4-10](#)
- [Viewing and Editing Application Template Instance Details, page 4-12](#)
- [Deleting an Application Template Instance, page 4-13](#)

Duplicating an Application Template Instance

You can duplicate an existing application template instance, which allows you to create a new template instance based on the original one.

Procedure

- Step 1** View the list of application template instances by doing one of the following:
 - To display the template instances of all devices, display the global view by doing one of the following:
 - Choose **Home** and from the Configuration category, choose **Application Template Instances**.

- Choose **Config > Global > Application Template Instances**.

- To display only the application configurations associated with a specific device, choose **Config > Devices > context > Load Balancing > Application Template Instances**.

The Application Template Instances window appears, displaying the information described in [Table 4-1](#).

Step 2 From the Application Template Instances window, choose the template instance to duplicate and click the **Duplicate** icon ()

The Duplicate Application Config dialog box appears.

Step 3 In the dialog box, enter the prefix to use for the duplicate and click **OK**.

The dialog box closes and the Application Template Instances window appears, displaying the configuration attributes of the original template instance.

Step 4 (Optional) From the Application Template Instances window, edit the variable attributes if needed.

For information about configuring the attributes, see [Table 4-2](#).

Step 5 Do one of the following:

- Click **Deploy** to deploy the template instance to the device. The deployment verification popup window appears. Go to [Step 6](#).
- Click **Stage** to save the template instance without deploying it to the specified virtual context.
- Click **Cancel** to exit the configuration window without saving your changes.

Step 6 From the popup window, do one of the following:

- Click **OK** to deploy the template instance. The Deploy dialog box appears, which displays the list of configuration attributes to be deployed. Go to [Step 6](#).
- Click **Cancel** to exit this procedure without deploying the template instance.

Step 7 In the dialog box, do the following:

- a. (Optional) Check the **Create Named Checkpoint** check box to create a checkpoint that ANM does not delete after a successful deployment.

This check box works as follows:

- Unchecked—ANM creates a checkpoint that you can revert back to if the deployment of the staged application template is unsuccessful. ANM assigns a random name to the checkpoint and deletes the checkpoint after a successful deployment.
- Checked—ANM creates a checkpoint that you name and can revert back to at any time because ANM does not delete it even after a successful deployment.



Note ACE virtual contexts have a limit of 10 checkpoints. If you attempt to exceed this limit, ANM does not deploy the template instance.

- b. Do one of the following:

- Click **Deploy Now**. The template instance is applied to the device running-configuration and startup-configuration files. The Results window appears with the deployment status as follows:
 - Deployment Successful
 - Error in deploying template: *error_details*
 - Click **Cancel** to cancel the deployment.
-

Related Topics

- [Information About Application Template Definitions and Instances, page 4-1](#)
- [Creating an Application Template Instance, page 4-4](#)
- [Deploying a Staged Application Template Instance, page 4-7](#)
- [Editing an Application Template Instance, page 4-9](#)
- [Viewing and Editing Application Template Instance Details, page 4-12](#)
- [Deleting an Application Template Instance, page 4-13](#)

Viewing and Editing Application Template Instance Details

You can view the configuration details of an application template instance, such as the real servers and server farms associated with the template instance. The view details feature also allows you to open the configuration window of a specific attribute to make changes if needed.

Guidelines and Restrictions

This topic includes the following guidelines and restrictions:

- You can view the details of deployed template instance but you cannot view the details of a staged template instance.
- ANM tracks only application template instances that you create and deploy using ANM. It does not discover template instances that may reside on an ACE. For example, if you use the CLI to configure an ACE with a configuration that matches an installed application template configuration, you will not see this configuration listed as a template instance in the ANM GUI (Config > Global > Application Template Instances).

Procedure

-
- Step 1** View the list of application template instances by doing one of the following:
- To display the template instances of all devices, display the global view by doing one of the following:
 - Choose **Home** and from the Configuration category, choose **Application Template Instances**.
 - Choose **Config > Global > Application Template Instances**.
 - To display only the application template instances associated with a specific device, choose **Config > Devices > context > Load Balancing > Application Template Instances**.

The Application Template Instances window appears, displaying the information described in [Table 4-1](#).

- Step 2** From the Application Template Instances window, view the details of a configuration by choosing a template instance name and clicking **Details**.

The Application Template Instance - Detail window appears, displaying details about the configuration objects. The information that displays varies depending on the template instance and user input. Configuration objects that can appear include the following:

- Virtual Servers
- Server Farms
- Real Servers
- Redirect Real Servers
- Sticky
- Probe
- SSL Proxy Service
- SSL Keys
- SSL Certificates
- SSL Auth Group Parameters
- SSL Chain Group Parameters
- SSL Parameter Maps
- HTTP Parameter Maps
- TCP Parameter Maps
- HTTP Header Modify Action Lists

Step 3 To view and edit one of the objects, click the **Go To Config Page** link.

The associated attribute window opens, such as the Virtual Server, Real Server, or Server Farm window, where all the objects associated with the attribute display. For example, if you click the **Go To Config Page** link associated with a real server, the Real Servers window appears, displaying the complete table of real servers. You must locate the real server in the table to view its details and make changes to it if needed.

Related Topics

- [Information About Application Template Definitions and Instances, page 4-1](#)
- [Managing Application Template Instances, page 4-3](#)
- [Creating an Application Template Instance, page 4-4](#)
- [Deploying a Staged Application Template Instance, page 4-7](#)
- [Editing an Application Template Instance, page 4-9](#)
- [Duplicating an Application Template Instance, page 4-10](#)
- [Deleting an Application Template Instance, page 4-13](#)

Deleting an Application Template Instance

You can delete an application template instance.

Guidelines and Restrictions

When you delete a deployed template instance, the virtual context configuration attributes that were added or modified as a result of deploying the application configuration are changed back to what they were prior to deploying the template instance, which means that if the virtual context was configured and operating prior to deploying the template instance, it reverts to operating with the previous configuration after you delete the template instance.

Prerequisites

You must have a user account with the following RBAC task assigned to it: `ace_virtualcontext=create`.

Procedure

-
- Step 1** View the list of application configurations by doing one of the following:
- To display the template instances of all devices, display the global view by doing one of the following:
 - Choose **Home** and from the Configuration category, choose **Application Template Instances**.
 - Choose **Config > Global > Application Template Instances**.
 - To display only the application template instances associated with a specific device, choose **Config > Devices > context > Load Balancing > Application Template Instances**.

The Application Template Instances window appears, displaying the information described in [Table 4-1](#).

- Step 2** From the Application Template Instances window, choose the template instance to delete and click the **Delete** icon ()

ANM removes the template instance from the table. If the template instance was of the type Saved, no virtual context operations are affected. If the template instance was of the type Deployed, the associated virtual context operations are affected as described in “[Guidelines and Restrictions](#)” section on [page 4-13](#).

Related Topics

- [Information About Application Template Definitions and Instances, page 4-1](#)
- [Managing Application Template Instances, page 4-3](#)
- [Creating an Application Template Instance, page 4-4](#)
- [Deploying a Staged Application Template Instance, page 4-7](#)
- [Editing an Application Template Instance, page 4-9](#)
- [Duplicating an Application Template Instance, page 4-10](#)
- [Viewing and Editing Application Template Instance Details, page 4-12](#)

Managing Application Template Definitions

ANM maintains a table of the application template definitions, which you can view by choosing **Config > Global > Application Template Definitions**. The Application Template Definitions window appears, displaying the information described in [Table 4-3](#).

Table 4-3 Application Template Definitions Window Fields

Field	Description
Application Type	Template name.
Version	Template version.
Template Type	Template type: User-defined or System (Cisco defined).
Description	Template description that indicates the type of network application in which the template configures the ACE.
Validity	Icons that indicate the validity of a template as follows: <ul style="list-style-type: none"> • Check mark—Template conforms to the XML schema and can be deployed to an ACE. • Error icon (!)—Template does not conform to the XML schema and cannot be deployed to an ACE.

From the Application Template Definitions window, you can create, edit, export, import, and test application template definitions.

This section includes the following topics:

- [Editing an Application Template Definition, page 4-15](#)
- [Creating an Application Template Definition, page 4-20](#)
- [Exporting an Application Template Definition, page 4-26](#)
- [Importing an Application Template Definition, page 4-26](#)
- [Testing an Application Template Definition, page 4-28](#)
- [Deleting an Application Template Definition, page 4-29](#)
- [Using the ANM Template Editor, page 4-29](#)

Editing an Application Template Definition

You can edit the XML code of an application template definition file from within ANM using the template editor that comes with ANM, or you can export the template definition file and edit it outside of ANM using an XML editor or text editor such as WordPad.

To help you understand how a template can be edited to suit your particular requirements, this section includes an example that involves editing the probe information in the Basic HTTP system template. In the code editing example, the probe interval value is changed from a set value of 60 seconds to a variable with a default of 60 seconds. This change allows you to configure the interval value when you use the template to create an application template instance (see the [“Creating an Application Template Instance” section on page 4-4](#)).

Figure 4-1 highlights the XML code for the probe URI variable and its set interval value. The figure also shows the GUI window that the code produces, including the variable field for inputting the relative probe URI.

Figure 4-1 Basic HTTP Template: Probe with Set Interval Value

```
<?xml version="1.0"?>
<template name="basicHTTP" application="Basic HTTP" version="1" xmlns:xsi="http://www.w3.org/2001/XMLSchema-instance"
xsi:noNamespaceSchemaLocation="file:application_template.xsd"
description="Basic L4 LB for HTTP" apptemplate="true">
<input>
<variable name="probe_url" type="string" displayString="Relative Probe URI:"
<variable name="vip" type="IPAddress" displayString="VIP Address" perms="ace_vip"/>
<array name="reals" displayString="IP Addresses of Real Servers" perms="ace_vip">
<variable name="ipAddr" displayString="Real Server IP Addresses:" type="IPAddress" perms="ace_vip"/>
</array>
<variable name="probe_url" type="string" displayString="Relative Probe URI:" default="/" perms="ace_vip"/>
<variable name="sticky" type="Boolean" displayString="Session Persistence:" perms="ace_vip"/>
</group>
<group name="network" type="group" displayString="Network Configuration">
<variable name="device" type="Device" displayString="Load Balancer (Device:VirtualContext):" perms="ace_vip"/>
<variable name="vlans" type="Vlans" displayString="Client VLANs:" perms="ace_vip"/>
<variable name="autoNat" type="Boolean" displayString="Enable Source NAT:" perms="ace_vip"/>
<probe requestHttpUrl="{ $probe_url }" interval="60"
</probe>
<config device="{ $device }">
<slb>
<serverfarm name="{ $name }" predictor="leastconns">
<probe requestHttpUrl="{ $probe_url }" interval="60"
passDetectCount="2" requestMethodType="get"
passDetectInterval="60" isRouted="false" expectedResponseCode="200">
<foreach iterate="{ $reals/$ipAddr }">
<server name="{ $reals/$ipAddr }" ipAddr="{ $reals/$ipAddr }">
</foreach>
</serverfarm>
<server-http name="{ $name }_http" vlans="{ $vlans }" inService="true">
<vip address="{ $vip }" port="80"/>
<sticky="{ $sticky }">
<enable loadbalance="{ $autoNat }">
</enable>
</server-http>
</slb>
</config>
</template>
```

You can modify a template to fit your particular requirements. Figure 4-2 highlights the probe code that was added or modified to produce a variable field in the GUI that allows you to set the probe interval if you do not want to use the default value of 60 seconds.

Figure 4-2 Modified Basic HTTP Template: Probe with Variable Interval Setting

```

<template name="basicHTTP" application="Basic HTTP" version="1.1"
</XML VERSION="1.0" />
<template name="basicHTTP" application="Basic HTTP" version="1.1" xmlns:xsi="http://www.w3.org/2001/XMLSchema-instance"
xsi:noNamespaceSchemaLocation="file:application_template.xml"
description="Basic L4 LB for HTTP" appTemplate="true">
<injt>
<group name="service" type="group" displayString="Application Configuration">
<variable name="name" type="name" displayString="Application Config Name:" param="ace_vip"/>
<variable name="probe_interval" type="string" displayString="Probe Interval:" default="60" param="ace_vip"/>
<array name="reals" displayString="IP Addresses of Real Servers" param="ace_vip">
<variable name="ipaddr" displayString="Real Server IP Addresses:" type="IPAddress" param="ace_vip"/>
</array>
<variable name="probe_url" type="string" displayString="Relative Probe URI:" default="/" param="ace_vip"/>
<variable name="probe_interval" type="string" displayString="Probe Interval:" default="60" param="ace_vip"/>
<variable name="sticky" type="Boolean" displayString="Session Persistence:" param="ace_vip"/>
</group>
<group name="network" type="group" displayString="Network Configuration">
<variable name="device" type="Device" displayString="Load Balancer (Device:VirtualContext):" param="ace_vip"/>
<variable name="vlans" type="Vlans" displayString="Client VLANs:" param="ace_vip"/>
<variable name="autoNat" type="Boolean" displayString="Enable Source NAT:" param="ace_vip"/>
</group>
</injt>
<probe requestHttpUrl="{ $probe_url }" interval="{ $probe_interval }"
<config device="{ $device }">
<slb>
<serverfarm name="{ $name }" predictor="leastconn">
<probe requestHttpUrl="{ $probe_url }" interval="{ $probe_interval }"
passDetectCount="2" requestMethodType="get"
passDetectInterval="60" isRouted="false" expectedResp="200"
<foreach iterate="{ $reals / $ipaddr }">
<server name="{ $reals / $ipaddr }" ipAddr="{ $reals / $ipaddr }"
</foreach>
</serverfarm>
<vserver-http name="{ $name }_http" vlans="{ $vlans }" inService="true">
<vip address="{ $vip }" port="80"/>
<if test="{ $sticky }" true">
<sticky-loadbalance>
</if test>
</vserver-http>
</slb>
</config>
</template>

```

Application Type: Basic HTTP version 1.1

Config - Global - Application Configs

Application Type: Basic HTTP version 1.1 Description: Basic L4/LB for HTTP

Application Configuration

- Application Config Name:
- VIP Address:
- Real Server IP Address:
- Probe Interval:
- Relative Probe URI:
- Session Persistence:

Network Configuration

- Load Balancer (Device:VirtualContext):
- Client VLANs:

Available:	Selected:
<input type="text"/>	<input type="text"/>
- Enable Source NAT:

Table 4-4 describes the XML code and ANM GUI changes called out in Figure 4-2.

Table 4-4 Example XML Code and ANM GUI Changes

Item	Description
Code Changes	
1	Modified code that changes the template version number from 1 to 1.1.
2	New code that defines a probe interval variable (probe_interval) that has a default value of 60.
3	Modified code that changes the set probe interval value (60) to a variable (\$probe_interval).
GUI Changes	
4	Modified template identification bar that includes the new version number (1.1).
5	New user field that allows the user to specify a probe interval other than the default of 60.

Guidelines and Restrictions

This topic includes the following guidelines and restrictions:

- You can edit the template definition within ANM using the ANM template editor or you can export the template file, edit the code using a text editor such as WordPad, and then import the modified template file.
- When editing a system template file, in the XML code you must change the template type or version number (or both).
- By default, templates that you created using the ANM template editor display as options when using Application Setup in Guided Setup (see the “[Using Application Setup](#)” section on page 3-14). To configure a template not to display in Application Setup, either change the following code in the template root element from true to false or remove this piece of code from the root element:

```
showsInGuidedSetup="false"
```

This section includes the following topics:

- [Editing an Application Template Definition Using the ANM Template Editor, page 4-18](#)
- [Editing an Application Template Definition Using an External Editor, page 4-19](#)

Editing an Application Template Definition Using the ANM Template Editor

You can use the template editor that comes with ANM to modify an application template definition from within ANM.

Procedure

Step 1 Choose **Config > Global > Application Template Definitions**.

The Application Template Definitions window appears, displaying the information described in [Table 4-3](#).

Step 2 From the Application Template Definitions window, choose the template to edit and click the **Edit** icon (.

The template editor window appears, displaying the template code.

Step 3 Edit the code as needed.

For information about using the ANM template editor to make your edits, see the “[Using the ANM Template Editor](#)” section on page 4-29.

Step 4 When your edits are complete, do one of the following:

- Click **Validate** to have ANM validate the application template definition file, which means that ANM checks to see that it is a well-formed XML document that follows the rules defined by the ANM Template XML schema. ANM highlights any errors in the code.
- Click **Save** to save your changes using the same filename. This button is not available when you edit a system template (you must use the Save As option).
- Click **Save As** to open the Save As New Template Definition popup window and save your changes under a new application type or version. The popup window text fields are populated with the attributes of the original file opened with the exception of the Version field, which ANM increments by one. If the version is not a number, the “-next” suffix is added to the version. From the popup window, modify the file attributes if needed and click **Save**.



Note When using the Save As feature, ANM does not allow you to save a template using the same application type and version number as the original template file. You must change either the application type or the version number.

- Click **Exit** to exit the template editor and return to the Application Template Definitions window.

Related Topics

- [Information About Application Template Definitions and Instances, page 4-1](#)
- [Editing an Application Template Instance, page 4-9](#)
- [Managing Application Template Definitions, page 4-15](#)
- [Editing an Application Template Definition Using an External Editor, page 4-19](#)
- [Testing an Application Template Definition, page 4-28](#)
- [Deleting an Application Template Definition, page 4-29](#)
- [Using the ANM Template Editor, page 4-29](#)

Editing an Application Template Definition Using an External Editor

You can export an application template definition file, modify it using a text editor, and then import it back into ANM.

Prerequisites

You must have a text editor (minimum) such as WordPad or an XML editor (preferred).

Procedure

Step 1 Choose **Config > Global > Application Template Definitions** and export the template to edit from the list of available templates.

For details, see the [“Exporting an Application Template Definition” section on page 4-26](#).

Step 2 Using a text editor such as WordPad, open the template XML file that you exported in Step 1.

Step 3 Modify the template identification by doing one or both of the following in the header code:

- Assign a new value to the applicationType attribute.
- Change the version number attribute.

In the example (see [Figure 4-2](#)), the template version number is changed from 1 to 1.1.

```
version="1.1"
```



Note When you change the template name or version number and import the template, ANM displays the template as a new line item in the Application Template Definitions window even if you save the file under the same name (see [Step 5](#)).

Step 4 Modify the operation of the template as needed.

In the example (see [Figure 4-2](#)), the following changes are made:

- The template version number is changed from 1 to 1.1.

```
version="1.1"
```
- The input variable name `probe_interval` is added and defined as having a default value of 60 (seconds).

```
<variable name="probe_interval" type="string" displayString="Probe Interval:"
default="60" perm="ace_vip"/>
```
- The slb code for the probe interval is changed from the set value of 60 to the `{$probe_interval}` variable.

```
<probe requestHttpUrl="{ $probe_url}" interval="{ $probe_interval}"
```

Step 5 Save your changes by doing one of the following:

- **Save**—Save the template under the same filename.
- **Save as**—Save the template under a new filename. We recommend this option.



Note Be sure to save the file as an XML file using the .xml extension.

Step 6 From the Application Template Definitions window of ANM, click **Import** to import the edited template.

For details, see the [“Importing an Application Template Definition” section on page 4-26](#).

Step 7 (Optional) From the Application Template Definitions window, choose the edited template and click **Test** to test the template to ensure that it works correctly.

For details, see the [“Testing an Application Template Definition” section on page 4-28](#).

Related Topics

- [Information About Application Template Definitions and Instances, page 4-1](#)
- [Managing Application Template Definitions, page 4-15](#)
- [Editing an Application Template Definition Using the ANM Template Editor, page 4-18](#)
- [Creating an Application Template Definition, page 4-20](#)
- [Exporting an Application Template Definition, page 4-26](#)
- [Importing an Application Template Definition, page 4-26](#)
- [Testing an Application Template Definition, page 4-28](#)
- [Deleting an Application Template Definition, page 4-29](#)

Creating an Application Template Definition

You can create an ACE application template definition using the template editor that comes with ANM or you can use an external XML editor and import the template file. The ANM template editor provides you with several base application types that provide you with the basic XML code to get you started.

Guidelines and Restrictions

The ability to create a complex template requires a thorough knowledge of XML programming and the ACE CLI and is beyond the scope of this guide. For information about creating complex templates for configuring your ACEs, go to the Cisco Developer Network (CDN) site at the following URL:

<http://developer.cisco.com/web/anm/application-templates>

This section includes the following topics:

- [Creating an Application Template Definition Using the ANM Template Editor, page 4-21](#)
- [Creating an Application Template Definition Using an External XML Editor, page 4-23](#)

Creating an Application Template Definition Using the ANM Template Editor

You can use the ANM Template editor to create a new Application Template Definition.

Guidelines and Restrictions

This topic includes the following guidelines and restrictions:

- The configuration options provided during the template creation process are provided as a starting point for defining the ACE configuration and are not intended to produce a fully written and functional configuration. You must complete the configuration with the specifics of your ACE application using the template editor. If your template is to be based on an existing ACE configuration, you can use the **show running config** command output as a model and a source for the needed configuration specifics (see the [“Creating an Application Template Definition Using an External XML Editor”](#) section on page 4-23).
- By default, templates that you create using the template editor display as options when using Application Setup in Guided Setup (see the [“Using Application Setup”](#) section on page 3-14). To configure a template not to display in Application Setup, change the following code in the template root element from true to false:

```
showsInGuidedSetup="false"
```

- When defining the variable fields in the XML code, you can enable the Basic/Advanced display feature that allows a user to hide certain variable fields when creating a template instance using the application template definition. Use this feature when you want to give the user creating a template instance the ability to hide optional variable fields or mandatory variable fields that have default values. The Basic view hides these fields while the Advanced view displays all available fields.

You can hide a specific variable field or variable array using the advanced attribute as follows:

- To hide a specific variable field in Basic view, add the advanced attribute to the variable element as follows:

```
<variable name="probe_url" type="string" displayString="Probe URL:" default="/"
perm="ace_vip" advanced="true" />
```

- To hide a variable array in Basic view, add the advanced attribute to the variable array as follows:

```
<array name="reals" displayString="IP Addresses of Real Servers" perm="ace_vip"
advanced="true">
<variable name="ipAddr" displayString="Real Server IP Addresses:"
type="ipaddress" perm="ace_vip" default="2.2.2.2"/>
<variable name="port" displayString="Real Server Ports:" type="port"
perm="ace_vip" default="80"/>
```



```
</array>
```



Note ANM does not display the drop-down list for Basic and Advanced viewing options when the advanced attribute is not used in the XML code.

Procedure

Step 1 Choose **Config > Global > Application Template Definitions**.

The Application Template Definitions window appears, displaying the list of existing templates.

Step 2 Click **Add (+)** to begin creating a new template.

The Create New Template Definition dialog box appears.

Step 3 From the dialog box, do the following:

- a. In the Application Type field, enter a brief description of the intended application.
- b. In the Version field, enter the template version number. By default, this field is set to 1.0.
- c. In the Description field, describe the intended use of the template.
- d. Check the **Load Balance** check box if the configuration is to perform load balancing (it is checked by default).

If you uncheck the check box, go to Step e.

If you check the check box, do the following:

- From the vserver type drop-down list, choose the virtual server type: **http, dns, ftp, rdp, terminated-https, or other**.

- Check the **Sticky** check box to enable sticky (it is unchecked by default).

If you check the check box, choose one of the following from the sticky type drop-down list: **ip-sticky, http-cookie-sticky, or http-header-sticky**.

- Check the **SSL** check box to include in the template a configuration block with an SSL termination proxy (it is unchecked by default).

e. Do one of the following:

- Click **Go to Editor** to open the template editor and the template base code, which is configured with the information that you provided. Go to [Step 4](#).

- Click **Cancel** to return to the The Application Template Definitions window.

Step 4 Edit the code as needed.

For information about using the ANM template editor to make your edits, see the [“Using the ANM Template Editor”](#) section on page 4-29.

Step 5 (Optional) Tag specific variable fields or variable arrays with the advanced attribute, which enables the Basic/Advanced display feature when creating a template instance that uses this application template definition.

When creating an application template instance, the Basic/Advanced display feature allows the user to set the view to Basic, which displays only the variable fields that require their input. For more information about configuring this feature, see the [“Guidelines and Restrictions”](#) section on page 4-21.

- Step 6** When your edits are complete, do one of the following:
- Click **Validate** to have ANM validate the application template definition file, which means that ANM checks to see that it is a well-formed XML document that follows the rules defined by the ANM Template XML schema. ANM highlights any errors in the code.
 - Click **Save** to save your changes.
-

Related Topics

- [Managing Application Template Definitions, page 4-15](#)
- [Editing an Application Template Definition, page 4-15](#)
- [Creating an Application Template Definition, page 4-20](#)
- [Using the ANM Template Editor, page 4-29](#)
- [Testing an Application Template Definition, page 4-28](#)
- [Deleting an Application Template Definition, page 4-29](#)
- [Creating an Application Template Instance, page 4-4](#)

Creating an Application Template Definition Using an External XML Editor

You can create a basic ACE application template definition using an external XML editor rather than the template editor that comes with ANM. The procedure shows how to create a base XML file with which to base your template on and then use the free form XML tag to encapsulate ACE CLI commands that you copy from a known working configuration and paste into the template. The example template that you create during the procedure will initialize a virtual context by doing the following:

- Specify a variable message of the day (MOTD) field.
- Enable logging.
- Specify a number of SNMP attributes, some of which are variables.

Guidelines and Restrictions

The ability to create a complex template requires a knowledge of XML programming and the ACE CLI and is beyond the scope of this guide. For information about creating complex templates for configuring your ACEs, go to the Cisco Developer Network (CDN) site at the following URL:

<http://developer.cisco.com/web/anm/application-templates>

Prerequisites

This topic has the following requirements:

- Basic knowledge of XML programming and the ACE CLI.
- Text editor (minimum), such as WordPad, or an XML editor (preferred).
- The application template definition XML schema. You can obtain a copy of this file from the CDN site at the following URL:

<http://developer.cisco.com/web/anm/docs>

From this site, use the schemas hyperlink located under the “Application Template Schemas” heading to download the XML schema.

- Access to an ACE CLI and the output of the **show running config** command from which you copy the commands that you need and paste them into the template.

Procedure

- Step 1** From the ACE CLI, enter the **show running config** command.
- Step 2** Create a folder in which to work while creating a template and place the application template definition XML schema file in it.
- Step 3** Using a text editor or XML editor, create an XML template file, save it to your work folder, and copy in the following base code:

```
<?xml version="1.0" encoding="UTF-8"?>
<template xmlns:xalan="http://xml.apache.org/xslt" applicationType="app_name"
version="1.0" xsi:noNamespaceSchemaLocation="file:application_template_v2.xsd"
xmlns:xsi="http://www.w3.org/2001/XMLSchema-instance" description="desc"
showsInGuidedSetup="true">
<input>
  <group name="service" type="group" displayString="ACE Configuration">
    <variable displayString="Template Instance Name" name="name" type="name"></variable>
    <variable name="vc" type="device" displayString="ACE Virtual Context"/>
  </group>
</input>
<config device="{vc}">
  <freeform></freeform>
</config>
</template>
```

- Step 4** Do the following (shown in **bold** text in the example):
- Assign values to the application type and provide a brief description.
 - Within the input tags, add the required variable tags.
 - Within the free form tags, paste the required ACE CLI commands that you copy from the **show running config** command output.

In the following example, the modified code is shown in **bold** text:

```
<?xml version="1.0" encoding="UTF-8"?>
<template xmlns:xalan="http://xml.apache.org/xslt" applicationType="Init_VC" version="1.0"
xsi:noNamespaceSchemaLocation="file:application_template_v2.xsd"
xmlns:xsi="http://www.w3.org/2001/XMLSchema-instance" description="Initialize a new
Virtual Context" showsInGuidedSetup="true">
<input>
  <group name="service" type="group" displayString="ACE Configuration">
    <variable displayString="Template Instance Name" name="name" type="name"></variable>
    <variable name="vc" type="device" displayString="ACE Virtual Context:"/>
    <variable name="motd" type="other" displayString="Message of the Day (use ^| as
newline):" default="Warning! ^| This is a secure system
do not use."/>
    <variable name="syslog" type="ipaddress" displayString="Syslog Server:"/>
    <variable name="traphost" type="ipaddress" displayString="SNMP Trap Host:"/>
    <variable name="community" type="string" displayString="SNMP Community String"
default="public"/>
  </group>
</input>
<config device="{vc}">
  <freeform>banner motd #{$motd}#
logging host {$syslog}
logging enable
snmp-server host {$traphost} traps {$community}
snmp-server enable traps
```

```
</freeform>
</config>
</template>
```

- d. (Optional) Tag specific variable fields or variable arrays with the advanced attribute, which enables the Basic/Advanced display feature when creating a template instance that uses this application template definition.

When creating an application template instance, the Basic/Advanced display feature allows the user to set the view to Basic, which displays only the variable fields that require their input. For more information about configuring this feature, see the [“Guidelines and Restrictions” section on page 4-21](#).

- e. To configure a template not to display in Application Setup, change the following code in the template root element from true to false:

```
showsInGuidedSetup="false"
```

By default, templates that you create using the base code in [Step 3](#) display as options when using Application Setup in Guided Setup (see the [“Using Application Setup” section on page 3-14](#)).

Step 5 Save the template file as an .xml file.

Step 6 (Optional) Do the following:

- a. Import the template into ANM (see the [“Importing an Application Template Definition” section on page 4-26](#)).
 - b. From ANM, test the template (see the [“Testing an Application Template Definition” section on page 4-28](#)).
 - c. From ANM, create an application template instance using the new template and deploy it (see the [“Creating an Application Template Instance” section on page 4-4](#)).
-

Related Topics

- [Managing Application Template Definitions, page 4-15](#)
- [Editing an Application Template Definition, page 4-15](#)
- [Creating an Application Template Definition, page 4-20](#)
- [Exporting an Application Template Definition, page 4-26](#)
- [Importing an Application Template Definition, page 4-26](#)
- [Testing an Application Template Definition, page 4-28](#)
- [Deleting an Application Template Definition, page 4-29](#)
- [Creating an Application Template Instance, page 4-4](#)

Exporting an Application Template Definition

You can export an application template definition for editing or to create a backup that you can import into another ANM server.

Procedure

- Step 1** Choose **Config > Global > Application Template Definitions**.
- The Application Template Definitions window appears, displaying the information described in [Table 4-3](#).
- Step 2** From the Application Template Definitions window, choose the template to export and click **Export**.
- The File Download dialog box opens.
- Step 3** From the File Download dialog box, click **Save**.
- The Save As dialog box window appears.
- Step 4** From the Save As dialog box, navigate to where you want to save the template definitions file.
- Rename the file if you want.
- Step 5** Click **Save**.
- The template definitions file is saved to the specified location.
-

Related Topics

- [Information About Application Template Definitions and Instances, page 4-1](#)
- [Managing Application Template Definitions, page 4-15](#)
- [Editing an Application Template Definition, page 4-15](#)
- [Creating an Application Template Definition, page 4-20](#)
- [Importing an Application Template Definition, page 4-26](#)
- [Testing an Application Template Definition, page 4-28](#)
- [Deleting an Application Template Definition, page 4-29](#)

Importing an Application Template Definition

You can import an application template definition. The import process checks the file to ensure that the XML conforms to the application template schema, using valid tags and attributes.

Guidelines and Restrictions

This topic includes the following guidelines and restrictions:

- ANM allows you to import files that do not conform to the XML schema and does the following:
 - Issues an error message when importing the file that indicates the detected issues.
 - Places an error icon in the Validity column of the template listing in the Application Template Definitions window (Config > Global > Application Template Definitions).

This feature allows you import a template file that is not complete and that you may want to edit further using the ANM template editor (see the [“Editing an Application Template Definition Using the ANM Template Editor”](#) section on page 4-18).

- The import process does not check the file to ensure that the ACE configuration attributes are structured correctly. To test the ACE configuration attributes, use the template test feature (see the [“Testing an Application Template Definition”](#) section on page 4-28).
- You can import application template definitions that you created for use with ANM 5.1, which used an earlier version of the XML schema. When you import the template, ANM modifies the template root element as required by the current version of the XML schema. This modification does not affect the ACE configuration.

Procedure

Step 1 Choose **Config > Global > Application Template Definitions**.

The Application Template Definitions window appears, displaying the information described in [Table 4-3](#).

Step 2 From the Application Template Definitions window, click **Import**.

The Select a Template Definition File to Upload dialog box appears.

Step 3 In the dialog box, click **Browse** to navigate to and choose the template file to upload.

Step 4 Click **Upload**.

The upload status box appears and displays one of the following messages:

- “Template is imported”—The template definition conforms to the XML schema. Click **OK** to close the popup window and complete the upload process.
- “Template is not imported because its XML structure is not valid”—ANM detected that the file does not contain properly structured XML code and cannot import the file.
- “Template is not imported because upload error was found”—A system or network error has occurred that prevented the upload. This message is not an indication that a problem exists with the template.
- “Template is imported, but the following errors were found”—The template contains properly structure XML code; however, the code does not conform to the XML schema. The message includes the errors found in the code.

ANM displays the template in the Application Template Definitions window.

Related Topics

- [Information About Application Template Definitions and Instances, page 4-1](#)
- [Managing Application Template Definitions, page 4-15](#)
- [Editing an Application Template Definition, page 4-15](#)
- [Creating an Application Template Definition, page 4-20](#)
- [Exporting an Application Template Definition, page 4-26](#)
- [Testing an Application Template Definition, page 4-28](#)
- [Deleting an Application Template Definition, page 4-29](#)

Testing an Application Template Definition

You can test an application template definition. The test performs the following tasks:

- Displays the application configuration window to verify that the variable information the user is expected to fill in displays correctly.
- Performs a test deployment and displays the configuration attributes that will be deployed for a live application configuration deployment. If there is a problem with the template definition, an error message displays that indicates what the problem is with the source code.



Note The test deployment is done locally on ANM only. No commands are sent to an ACE.

Procedure

Step 1 Choose **Config > Global > Application Template Definitions**.

The Application Template Definitions window appears, displaying the information described in [Table 4-3](#).

Step 2 From the Application Template Definitions window, choose a template to test and click **Test**.

The Application Configuration window appears.

Step 3 From the Application Configuration window, enter the required variable information and click **Test Deploy**.

The Test popup window appears displaying the application configuration attributes that the template generates.



Note If the template contains a boolean statement that allows you to choose one of two values, be sure to test both values. For example, if the template includes the Secure Backend Servers checkbox option, test the template with the check box checked (enabled) and unchecked (disabled).

Step 4 Click **Cancel** to close the Test popup window and return to the Application Template Definitions window.

Related Topics

- [Information About Application Template Definitions and Instances, page 4-1](#)
- [Managing Application Template Definitions, page 4-15](#)
- [Editing an Application Template Definition, page 4-15](#)
- [Creating an Application Template Definition, page 4-20](#)
- [Exporting an Application Template Definition, page 4-26](#)
- [Importing an Application Template Definition, page 4-26](#)
- [Deleting an Application Template Definition, page 4-29](#)

Deleting an Application Template Definition

You can delete a user-defined application template definition.

Guidelines and Restrictions

You cannot delete a system template.



Caution

When you delete an application template definition and you have staged application template instances that were created using the template, you cannot edit or deploy the template instances.

Procedure

Step 1 Choose **Config > Global > Application Template Definitions**.

The Application Template Definitions window appears, displaying the information described in [Table 4-3](#).

Step 2 From the Application Template Definitions window, choose a user-defined template to delete and click the **Delete** icon (.

The Delete Verification popup window appears.

Step 3 From the popup window, do one of the following:

- Click **OK** to delete the template.
- Click **Cancel** to ignore the template delete request.

Related Topics

- [Information About Application Template Definitions and Instances](#), page 4-1
- [Managing Application Template Definitions](#), page 4-15
- [Editing an Application Template Definition](#), page 4-15
- [Creating an Application Template Definition](#), page 4-20
- [Importing an Application Template Definition](#), page 4-26
- [Exporting an Application Template Definition](#), page 4-26
- [Testing an Application Template Definition](#), page 4-28

Using the ANM Template Editor

ANM includes a template editor that you can use to create or edit application template definitions from within the ANM GUI. This section describes the editor components and how to use them.

You access the ANM template editor by doing one of the following:

- Create a new template (see the “[Creating an Application Template Definition Using the ANM Template Editor](#)” section on page 4-21).
- Edit an existing template (see the “[Editing an Application Template Definition Using the ANM Template Editor](#)” section on page 4-18).

Figure 4-3 shows a sample view of the ANM template editor. The sample code includes invalid code in line 6 to show how the editor highlights problem code.

Figure 4-3 ANM Template Editor Components

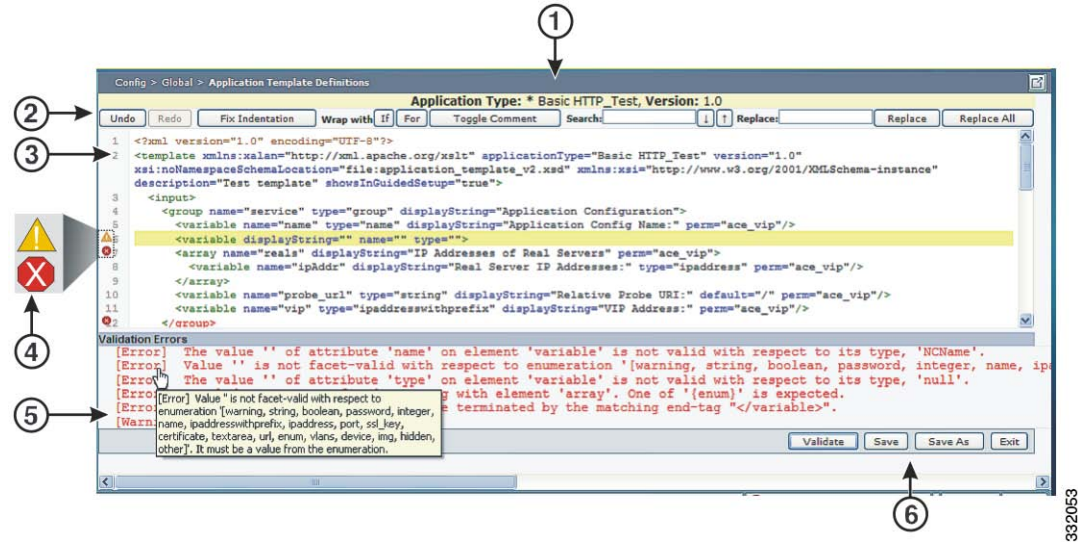

Table 4-5 describes the editor GUI components called out in Figure 4-3.

Table 4-5 ANM Template Editor Component Descriptions

Item	Description
1	<p>Template Identifier</p> <p>Template type and version number. ANM displays an asterisk (*) next to the template type to indicate that a change to the template has been made but not saved.</p>

Table 4-5 ANM Template Editor Component Descriptions (continued)





Item	Description
2	<p>Tool Bar</p> <p>Editing tools that work as follows:</p> <ul style="list-style-type: none"> • Undo button—With each click, undoes the changes that you made but did not save, beginning with the most recent change made. • Redo button—With each click, redoes the changes reversed by the Undo button, beginning with the most recent undo operation. • Fix Indentation button—Corrects any indentation errors in the code. • Wrap with: <ul style="list-style-type: none"> – If button—Wraps the code that you highlight with the “if” opening and closing tags to create an if block. – For button—Wraps the code that you highlight with the “foreach” opening and closing tags to create a foreach block. <p>If you do not highlight the code to wrap, ANM places the If or For block at the location of the cursor.</p> <ul style="list-style-type: none"> • Toggle Comments button—Makes the code that you highlighted a comment. You can use this feature to add description comments to sections of the code. You can also tag incomplete code as a comment until you are ready to complete it. At that time, you would highlight the commented code and click Toggle Comments again. • Search text box—String to locate in the code. The template editor highlights all instances of the string. Use the following associated tools: <ul style="list-style-type: none"> – Up button—Moves to the next instance of the search string above the currently highlighted instance. – Down button—Moves to the next instance of the search string below the currently highlighted instance. • Replace text box—String that is to replace the search string as follows: <ul style="list-style-type: none"> – Replace button—Replaces only the currently highlighted occurrence of the search string. – Replace All button—Replaces all occurrences of the search string.
3	<p>Work Area</p> <p>Area where the code is displayed and modified. The work area includes the following editing tools:</p> <ul style="list-style-type: none"> • Code folding—Allows you to expand or collapse sections of code as follows: <ul style="list-style-type: none"> – —Collapses code group. – —Expands code group. <p>ANM hides these icons and expands the code when an error exists.</p> • Code auto complete—ANM completes the code tag being entered or displays a list of possible options that match what has been entered so far. This feature works for a predefined set of elements only and is not available with every element type. <p>To use this feature, begin entering the start-tag and then press Ctrl + Space. Enter at least one character after the open character (<) before pressing Ctrl + Space. For example:</p> <pre data-bbox="266 1703 886 1766"><var -->Press Ctrl + Space <variable displayName="" name="" type=""></pre>

Table 4-5 ANM Template Editor Component Descriptions (continued)

Item	Description
4	<p>Error and Warning Indicators</p> <p>Icons that appear when the code that does not conform to the XML schema as follows:</p> <ul style="list-style-type: none"> •  —Warning indicator: Error exists; however, the error will not prevent deployment of the template. •  —Error indicator: Error exists that will prevent deployment of the template. <p>For details about the indicated error, see the Error Description Pane located at the bottom of the window or hover over the icon to open the popup error message display.</p>
5	<p>Error Description Pane</p> <p>Descriptions of the detected errors in the code, which are also highlighted with Error and Warning Indicators. Because the error description text does not wrap, it can extend beyond the display. To view the entire description, hover over the message to open the popup error message display.</p> <p>Displayed errors remain in this pane until you fix the issue and validate the fix by clicking Validate.</p>
6	<p>Function Buttons</p> <p>Buttons that work as follows:</p> <ul style="list-style-type: none"> • Validate—ANM validates the application template definition file, which means that ANM checks to see that it is a well-formed XML document that follows the rules defined by the ANM Template XML schema. When ANM detects errors in the code, it highlights the errors with Error and Warning Indicators and displays the Error Description Pane. If you correct the code and click Validate again, ANM removes the error indicators and closes the error description pane if no other errors exist. • Save—Saves your changes using the same filename. <ul style="list-style-type: none"> Note the following when using this button: <ul style="list-style-type: none"> – If any errors exist in the code, ANM displays a verification popup window, asking you to verify that you want to save the information regardless of the detected errors. – If the code is not properly structured, ANM displays an error message stating that the template cannot be saved because the XML structure is not valid. For example, if you enter a tag and do not close it, this error occurs. You must correct the code error before ANM allows you to save the template. – The Save button is not available when editing a system template, which requires that you use the Save As button. • Save As—Saves the file to a different filename. This option opens the Save As New Template Definition popup window to save your changes under a new application type name or version. From the popup window, modify the file attributes if needed and click Save. <ul style="list-style-type: none"> Note the following when using this button: <ul style="list-style-type: none"> – ANM populates the popup window text fields with the attributes of the original file opened with the exception of the Version field, which ANM increments by one. If the version is not a number, ANM adds the “-next” suffix to the version. – ANM does not allow you to save a template using the same application type and version number as the original template file. You must change either the application type or version number (or both). • Exit—Exits the editor without saving your changes.



CHAPTER 5

Importing and Managing Devices

Date: 3/28/12

This chapter describes how to import and manage Cisco Application Networking Manager (ANM) devices. You can import the following Cisco devices to ANM:

- Application Control Engine (ACE) module or appliance
- Global Site Selector (GSS)
- Content Services Switch (CSS)
- Catalyst 6500 Virtual Switching System (VSS) 1440
- Catalyst 6500 series switch
- Cisco 7600 series router
- Cisco Content Switching Module (CSM)
- Cisco Content Switching Module with SSL (CSM-S)
- VMware vCenter Server



Note

The terms *add* and *import* are interchangeable in this document.



Note

When naming ACE objects (such as a real server, virtual server, parameter map, class map, health probe, and so on), enter an alphanumeric string of 1 to 64 characters, which can include the following special characters: underscore (_), hyphen (-), dot (.), and asterisk (*). Spaces are not allowed.

If you are using ANM with an ACE module or ACE appliance and you configure a named object at the ACE CLI, keep in mind that ANM does not support all of the special characters that the ACE CLI allows you to use when configuring a named object. If you use special characters that ANM does not support, you may not be able to import or manage the ACE using ANM.

This chapter includes the following sections:

- [Information About Device Management, page 5-2](#)
- [Information About Importing Devices, page 5-4](#)
- [Preparing Devices for Import, page 5-4](#)
- [Modifying the ANM Timeout Setting to Compensate for Network Latency, page 5-9](#)
- [Importing Network Devices into ANM, page 5-10](#)

- [Discovering Large Numbers of Devices Using IP Discovery, page 5-27](#)
- [Configuring Devices, page 5-34](#)
- [Configuring ACE Module and Appliance Role-Based Access Controls, page 5-53](#)
- [Managing Devices, page 5-66](#)
- [Replacing an ACE Module Managed by ANM, page 5-82](#)

Information About Device Management

ANM includes many device management features. You can import devices and then configure them for use in your network. In addition to configuring ports, VLANs, and routes, you can modify device configurations, and manage them.

[Table 5-1](#) identifies common management categories and related topics.

Table 5-1 **Device Management Options**

Device Management Activities	Related Topics
Importing devices	<ul style="list-style-type: none"> • Information About Importing Devices, page 5-4 • Preparing Devices for Import, page 5-4 • Enabling SSH or Telnet Access on Catalyst 6500 Series Switches and Cisco 7600 Series Routers, page 5-5 • Modifying the ANM Timeout Setting to Compensate for Network Latency, page 5-9 • Importing Network Devices into ANM, page 5-10 • Importing Cisco IOS Host Chassis and Chassis Modules, page 5-11 • Importing ACE Appliances, page 5-21 • Importing CSS Devices, page 5-22 • Importing GSS Devices, page 5-23 • Importing VMware vCenter Servers, page 5-24 • Discovering Large Numbers of Devices Using IP Discovery, page 5-27

Table 5-1 *Device Management Options (continued)*

Device Management Activities	Related Topics
Configuring device attributes	<ul style="list-style-type: none"> • Configuring Devices, page 5-34 • Configuring CSM Primary Attributes, page 5-34 • Configuring CSS Primary Attributes, page 5-35 • Configuring GSS Primary Attributes, page 5-36 • Configuring Catalyst 6500 Series Chassis and Cisco 7600 Series Router Primary Attributes, page 5-38 • Configuring Catalyst 6500 Series Chassis, Catalyst 6500 Virtual Switching System 1440 Devices, and Cisco 7600 Series Routers Static Routes, page 5-39 • Configuring VMware vCenter Server Primary Attributes, page 5-41 • Displaying Chassis Interfaces and Configuring High-Level Interface Attributes, page 5-42 • Managing Catalyst 6500 Series Chassis or Cisco 7600 Series Router VLANs, page 5-48 • Creating VLAN Groups, page 5-52
Configuring device role-based access control (RBAC)	<ul style="list-style-type: none"> • Configuring Device RBAC Users, page 5-53 • Configuring Device RBAC Roles, page 5-56 • Configuring Device RBAC Domains, page 5-61
Managing devices	<ul style="list-style-type: none"> • Synchronizing Device Configurations, page 5-66 • Mapping Real Servers to VMware Virtual Machines, page 5-68 • Instructing ANM to Recognize an ACE Module Software Upgrade, page 5-71 • Configuring User-Defined Groups, page 5-72 • Changing Device Credentials, page 5-75 • Changing ACE Module Passwords, page 5-77 • Restarting Device Polling, page 5-78 • Displaying All Devices, page 5-78 • Displaying Modules by Chassis, page 5-79 • Removing Modules from the ANM Database, page 5-80

Information About Importing Devices

The quickest and easiest way to add devices to ANM is to import them individually using the Add function available at Config > Devices. If you already know the device IP address, you can use this procedure to add your devices to ANM.

Before you begin importing, you need to set up your network devices so that ANM can communicate and monitor them.

In the sections that follow, you will perform the following steps to prepare and import devices:

1. Enable SSH access (see the [“Preparing Devices for Import”](#) section on page 5-4).
2. Modifying the ANM timeout setting (see the [“Modifying the ANM Timeout Setting to Compensate for Network Latency”](#) section on page 5-9).



Note This step is required only when network latency is causing a timeout issue that prevents ANM from establishing a communication link with the device to be imported.

3. Import devices (see the [“Importing Network Devices into ANM”](#) section on page 5-10).

To add large numbers of devices, you can use IP Discovery before you import your devices. This process is not as efficient as using the Add function. IP Discovery shows where devices are but does not add the devices to ANM. We recommend that you use the Config > Devices > Device Management > Add function. For details on IP Discovery, see the [“Discovering Large Numbers of Devices Using IP Discovery”](#) section on page 5-27.



Note

Before importing a device, the ANM server pings the IP address of the device. If you have a firewall between the ANM server and the device that you want to import, your network administrator needs to modify the firewall to allow the ping traffic to reach the device or ACE.

Preparing Devices for Import

This section describes how to set up your devices to allow ANM to communicate with them and also describes the requirements for adding ACE devices that are high availability peers.

ANM uses the following protocols for communication:

- For communication to an ACE module or appliance:
 - XML over HTTPS
 - SSHv2 (read and write)
 - SNMP V2C (read-only)
 - Syslog over User Datagram Protocol (UDP) (inbound notifications only)
- For communication to the Catalyst 6500 Virtual Switching System (VSS) 1440:
 - SSHv2 and Telnet (read and write)
 - SNMP V2C (read-only)
 - Syslog over UDP (inbound notifications only)
- For communication to a Catalyst 6500 series switch, Cisco 7600 series router, CSM, or CSM-S:
 - SSHv2 and Telnet (read and write)

- SNMP V2C (read-only)
- Syslog over UDP (inbound notifications only)
- For communication to the CSS:
 - Telnet (read and write)
 - SNMP V2C (read-only)
 - Syslog over UDP (inbound notifications only)
- For communication to the GSS:
 - SSHv2
 - Remote Method Invocation (RMI) over SSL



Note Before you import a GSS device into ANM, you need to set the GSS communication on the GSS Ethernet interface that will be used to import the GSS into ANM. See the *Cisco Global Site Selector Command Reference* on Cisco.com for instructions on using the **gss-communications** command.

- For communication to a VMware vCenter Server, HTTPS is used.



Note For more information about communication between ANM and a VMware vCenter Server, see the “[Prerequisites for Using ANM With VMware vSphere Client](#)” section on page B-4 and “[Guidelines and Restrictions](#)” section on page B-5.

This section includes the following topics:

- [Enabling SSH or Telnet Access on Catalyst 6500 Series Switches and Cisco 7600 Series Routers, page 5-5](#)
- [Enabling SSH Access and the HTTPS Interface on the ACE Module and Appliance, page 5-6](#)
- [Enabling SNMP Polling from ANM, page 5-7](#)
- [ANM Requirements for ACE High Availability, page 5-8](#)

Enabling SSH or Telnet Access on Catalyst 6500 Series Switches and Cisco 7600 Series Routers

You can choose to use Telnet or SSH to import a Catalyst 6500 series switch or Cisco 7600 series router in ANM. Telnet is enabled by default on the Catalyst 6500 series chassis. If you have disabled Telnet on the device, you need to enable it to perform the initial setup and import of an ACE module. If you plan to directly import an ACE module into ANM, Telnet is not mandatory on a Catalyst 6500 series switch.



Note

If you choose Telnet, the Use Telnet checkbox will be checked in the Primary Attributes window (see the “[Configuring Catalyst 6500 Series Chassis and Cisco 7600 Series Router Primary Attributes](#)” section on page 5-38).

If you use SSH to communicate with the device, you must do the following:

- SSHv2 must be enabled on the chassis, as well as the ACE, in order for ANM to add device information about the chassis.

- Ensure that the chassis has a K9 (Triple Data Encryption Standard [3DES]) software image in order to enable the SSH server. The ANM requires SSHv2 to be enabled on the chassis.

To enable SSH or Telnet access on Catalyst 6500 series switches or Cisco 7600 series routers, use the following commands:

	Command	Purpose
Step 1	<code>ip ssh version 2</code>	Enables SSHv2.
Step 2	<code>ip domain-name abc.com</code>	
Step 3	<code>crypto key generate rsa general-keys modulus 1024</code>	Generates the key.
Step 4	<code>username <i>username</i> password <i>password</i></code>	Enters the username and password.
Step 5	<code>line vty 0 4</code>	
Step 6	<code>session-timeout 60</code>	
Step 7	<code>login local</code>	This is an example only. This commands works for Cisco IOS 12.2.18SXF(10), but not for 12.2.18SXF(8).
Step 8	<code>transport input telnet ssh</code>	Allows SSH and Telnet to the chassis.
Step 9	<code>transport output telnet ssh</code>	Allows SSH and Telnet from the chassis to the ACE module.

Enabling SSH Access and the HTTPS Interface on the ACE Module and Appliance

You can enable SSH access and the HTTPS interface on the ACE modules and appliances. ANM uses SSH and XML over HTTPS to communicate with the ACE devices. You need to enable both SSH access and HTTPS as explained in this section. These settings can be enabled during device import as described in the [“Importing Network Devices into ANM”](#) section on page 5-10 or in the CLI.



Note

If the ACE module or appliance is new and still has its factory settings, you do not need to perform the procedure in this section because SSH is enabled by default.



Note

Ensure that the management policy applied on the management interface permits SSH.

To enable SSH access and the HTTPS interface on an ACE module or appliance, enter the following commands in config mode in the Admin context:

	Command	Purpose
Step 1	<code>ssh key rsa 1024 force</code>	Configures SSH access on the ACE.
Step 2	<code>access-list acl line 10 extended permit ip any any</code>	

	Command	Purpose
Step 3	<pre>class-map type management match-any ANM_management 2 match protocol ssh any 3 match protocol telnet any 4 match protocol https any 5 match protocol snmp any 6 match protocol icmp any 7 match protocol xml-https</pre>	<p>Configures discovery for ANM.</p> <p>The following comments apply to the line number specified before the command text in the left column:</p> <ul style="list-style-type: none"> Line 2 classifies the SSH traffic. Line 4 is needed by ANM for making configuration changes on the ACE. Line 5 is needed by ANM for periodic statistics. Line 6 is not mandatory but useful for network and route validation. Line 7 is needed only for ACE 4710 devices.
Step 4	<pre>policy-map type management first-match ANM_management class ANM_management permit</pre>	Allows protocols matched in the management class map.
Step 5	<pre>interface vlan 30 ip address 192.168.65.131 255.255.255.0 access-group input acl service-policy input ANM_management no shutdown</pre>	Configures a management interface with the ACL and specifies the management service policy. This configuration is not recommended for a client or server interface.
Step 6	<pre>username admin password 5 \$l\$faXJEFBj\$TJRlNx7sLPTi5BZ97v08c/ role Admin domain default-domain</pre>	Defined by the administrator.
Step 7	<pre>ip route 0.0.0.0 0.0.0.0 192.168.0.1</pre>	Specifies the default route (or appropriate route) for traffic to reach ANM using the management interface if ANM is not on the same subnet.

For more information about configuring SSH access on the ACE, see either the *Cisco Application Control Engine Module Administration Guide* or the *Cisco 4700 Series Appliance Administration Guide* on Cisco.com.

Enabling SNMP Polling from ANM

You can enable SNMP polling from ANM, which uses SNMPv2 for polling ACE, CSS, CSM, or CSM-S devices. To receive traps from these devices, ANM supports use of SNMPv2 traps.



Note

To send SNMP traps to ANM, configure the SNMP trap host to the ANM server so that it can receive traps from ANM.

For alarm condition notifications, ANM uses SNMPv1 EPM-Notificaton-MIB based SNMP traps.

For the ACE, in order for ANM to successfully perform SNMP polling, you must configure the ACE Admin context with a management IP with a suitable management policy that permits SNMP traffic. All other contexts can be polled using this Admin context management IP.

For each device type (ACE, CSS, CSM, or CSM-S), see the corresponding configuration guide to configure the device to permit SNMP traffic.

ANM Requirements for ACE High Availability

ANM automatically identifies ACE high availability (HA) peers if both peers are imported into ANM. For ANM to identify two ACE devices (ACE modules or ACE appliances) as high availability peers, ANM looks for two ACE devices with the same fault-tolerant (FT) interface VLAN configuration and whose peer IP addresses are reversed.

For example, ANM would consider Peer 1 with the following configuration:

```
ft interface vlan 4000
  ip address 10.10.10.1 255.255.255.0
  peer ip address 10.10.10.4 255.255.255.0
```

and Peer 2 with the following configuration:

```
ft interface vlan 4000
  ip address 10.10.10.4 255.255.255.0
  peer ip address 10.10.10.1 255.255.255.0
```

as HA peers because they both use FT interface VLAN 4000 and their IP and peer IP addresses are reversed.

However, it is possible that multiple ACE devices imported into ANM have the same FT interface VLAN and IP address/peer IP address combinations. In this case, ANM is not able to identify the ACE HA pair correctly. To resolve this issue, ANM uses the following logic to determine that two ACE devices are an HA pair:

1. Two ACE devices could be identified as a HA pair if their FT interface VLAN IDs match and their FT interface IP and peer IP addresses are reversed.
2. If the Admin context management interface peer IP address is already defined, ANM will conclusively identify its HA peer if the other Admin context management interface reversely matches the management IP and peer IP addresses.
3. If both ACE Admin context management interface peer IP addresses are not defined, and their FT interface configuration combination is unique across all ACE devices, ANM will then identify them as an HA pair.
4. An ACE HA peer is identified as Inconclusive if there is a non unique FT interface configuration combination across all ACE devices and its Admin context management interface peer IP is not defined.

When importing an ACE HA pair into ANM, you should follow one of the following configuration requirements so that ANM can uniquely identify the ACE HA pair:

- Use a unique combination of FT interface VLAN and FT IP address/peer IP address for every ACE HA pair imported into ANM. For HA, it is critical that the combination of FT interface VLAN and IP address/peer IP address is always unique across every pair of ACE peer devices.
- Define a peer IP address in the management interface using the management IP address of the peer ACE (module or appliance). The management IP address and management peer IP address used for this definition should be the management IP address used to import both ACE devices into ANM.

An example is as follows:

- ACE1 is imported into ANM with management IP 10.10.10.10.
- ACE2 is imported into ANM with management IP 10.10.10.12.

In this case, you would perform the following actions for both ACE1 and ACE2:

- Update the management interface on ACE1 with IP address 10.10.10.10. to have 10.10.10.12 as the peer IP address.

- Update the management interface on ACE2 with IP address 10.10.10.12 to have 10.10.10.10 as the peer IP address.

An ACE module or appliance may have many other management interfaces defined, but ANM is particularly interested only in the management interface whose IP address is used for importing into ANM.

When ANM is unable to determine a unique ACE HA peer pair, it displays an Inconclusive state in the ACE HA State column of the All Virtual Contexts table (Config > Devices > Virtual Context Management) or the Virtual Contexts listing page. The Inconclusive state indicates that ANM was able to determine that the given ACE was configured in HA; however, ANM was able to find more than one ACE module or ACE appliance that appeared to be a peer. In this case, ANM was unable to conclusively find a unique HA peer for the given ACE module or ACE appliance. You must then perform the actions outlined in this section to fix the ACE that is in this state.

More information will appear in the tooltip for the Inconclusive state to specify whether this state was reached because the FT interface VLAN and the IP address/peer IP address was not unique, or because the peer IP address on the management interface was not unique.

Based on the information provided to you in the tooltip for the Inconclusive state, you must update the ACE configuration as described in the configuration requirements outlined above. After you make these configuration changes, resynchronize the affected ACE devices in ANM to update the configuration and HA mapping. For more information about synchronizing virtual contexts, see the [“Creating Virtual Contexts” procedure on page 6-2](#).

Modifying the ANM Timeout Setting to Compensate for Network Latency

You can adjust the amount of time that ANM waits for a response from a device that you want ANM to import. You may need to adjust the timeout value when network latency prevents ANM from establishing a communication link with the device to be imported.

To establish communications between ANM and the device during the device import process, the device sends requests to ANM for the required device username and password information. After ANM provides the device username, it waits two seconds for the device to make the next request for the password. If network latency prevents the password request from arriving within two seconds of providing the username, the connection times out, preventing ANM from importing the device.

This type of issue can occur when importing devices that are Telnet-managed or require remote user authentication. To compensate for the resulting network latency, you can modify the default two-second timeout value by editing the ANM `cs-config.properties` file.

Procedure

Step 1 Modify the timeout value to 20000 milliseconds (20 seconds) as follows:

- ANM Server—Open the `/opt/CSCOanm/etc/cs-config.properties` file in a text editor and add the following line to the end of the file:
`telnet.transport.login.timeout=20000`
- ANM Virtual Appliance—Enter the following command:
`anm-property set telnet.transport.login.timeout 20000`

- Step 2** Restart ANM as follows:
- ANM Server—Enter the following command:
`/opt/CSCOanm/bin/anm-tool restart`
 - ANM Virtual Appliance—Enter the following command:
`anm-tool restart`
- Step 3** Import the device.
See one of the following sections:
- [Importing Network Devices into ANM, page 5-10](#)
 - [Discovering Large Numbers of Devices Using IP Discovery, page 5-27](#)
- Step 4** (Optional) If the timeout issue persists, slowly increase the timeout value by repeating this procedure.
Do not increase the timeout value beyond 60000 milliseconds.
-

Related Topics

- [Importing Network Devices into ANM, page 5-10](#)
- [Discovering Large Numbers of Devices Using IP Discovery, page 5-27](#)

Importing Network Devices into ANM

ANM allows you to add the following devices individually to its database:

- ACE appliances
- ACE modules
- Catalyst 6500 series chassis
- Catalyst 6500 Virtual Switching System (VSS) 1440
- Cisco 7600 series routers
- Cisco Content Services Switch (CSS) devices
- Cisco Content Switching Module (CSM) devices
- Cisco Global Site Selector (GSS) devices
- VMware vCenter Servers

We recommend that you use the procedures in this section to add your devices to ANM because they are faster and more efficient than running IP Discovery (see the [“Discovering Large Numbers of Devices Using IP Discovery”](#) section on page 5-27).

Guidelines and Restrictions

This topic includes the following guidelines and restrictions:

- When adding a module device, such as an ACE module or a CSM, you must first import the host chassis device, such as a Cisco Catalyst 6500 series switch chassis, and then you add the installed modules. The chassis device is referred to as a *Cisco IOS device* during the device import process.

- The time required to import devices depends on the number of appliances, chassis, modules, and contexts that you are importing. For example, an ACE appliance with 20 virtual contexts takes longer than an ACE appliance with 5 contexts. While ANM imports devices, you cannot perform other activities in the same session. You can, however, establish a new session with the ANM server and perform activities on other appliances, chassis, modules, or virtual contexts.
- Network latency can prevent ANM from establishing a communication link with a device that you want to import. When ANM is providing the device with the device credentials (username and password), by default it waits two seconds after providing the device username for the password prompt to appear. The link times out when it takes longer than two seconds for the next prompt to appear. For information about possible causes of network latency that can create this issue and how to adjust the ANM timeout value, see the [“Modifying the ANM Timeout Setting to Compensate for Network Latency”](#) section on page 5-9.

Prerequisites

This topic includes the following prerequisites:

- Before adding a device or ACE module, the ANM server pings the IP address of the device or ACE module. If you have a firewall between the ANM server and the device you want to import, your network administrator needs to modify the firewall to allow the ping traffic to reach the device or ACE module.
- To import your devices successfully, ensure the following:
 - The ACE module or CSM has booted successfully and is in the OK/Pass state (enter the **show module** supervisor Cisco IOS CLI command to verify this action).
 - The ACE appliance or the CSS state is up and running. There is no command to validate whether these devices are up and running.

This section includes the following topics:

- [Importing Cisco IOS Host Chassis and Chassis Modules, page 5-11](#)
- [Importing ACE Appliances, page 5-21](#)
- [Importing CSS Devices, page 5-22](#)
- [Importing GSS Devices, page 5-23](#)
- [Importing VMware vCenter Servers, page 5-24](#)

Importing Cisco IOS Host Chassis and Chassis Modules

This section shows how to import a Cisco IOS host chassis into ANM, such as the Catalyst 6500 series chassis or the Cisco 7600 series router. After you define the Cisco IOS device during the import process, you import the ACE or CSM modules that currently reside in the chassis and are detected by ANM. When you add additional modules to the Cisco IOS device, you import the new modules into ANM without having to redefine the host chassis.

This section includes the following topics:

- [Importing Cisco IOS Devices with Installed Modules, page 5-12](#)
- [Importing ACE Modules after the Host Chassis has been Imported, page 5-16](#)
- [Importing CSM Devices after the Host Chassis has been Imported, page 5-19](#)
- [Importing VSS 1440 Devices after the Host Chassis has been Imported, page 5-20](#)

Importing Cisco IOS Devices with Installed Modules

This section shows how to import the following Cisco IOS chassis devices into ANM along with any installed ACE modules or CSMs that ANM detects in the chassis:

- Catalyst 6500 series chassis
- Catalyst 6500 Virtual Switching System (VSS) 1440
- Cisco 7600 series routers

Procedure

-
- Step 1** Choose **Config > Devices > All Devices**.
The Device Management window appears.
- Step 2** In the device tree or in the All Devices table, click **Add**.
The New Device window appears.
- Step 3** Enter the information for the device using the information in [Table 5-2](#).

Table 5-2 *New Device Attributes*

Field	Description
Name	Unique name for the device. Valid entries are unquoted text strings with no spaces and a maximum of 26 alphanumeric characters.
Model	Type of device to import. From the Model drop-down list, choose Cisco IOS Device .
Primary IP	IP address for the device in dotted-decimal format.
Access Protocol	Protocol to use for communication with the device. Choose Secure/SSH2 (default setting) or Telnet as the protocol that ANM uses to access the Cisco IOS devices.
User Name	Account name for device access. Note If you did not configure an account on the chassis before starting this procedure, you can enter an alphanumeric string with no spaces to complete this procedure. However, we recommend that you configure an account on the device to prevent unauthorized access.
Password	Password for the account.
Enable Password	Provides an extra level of security.
SNMP v2c Enabled	Check the SNMP v2c Enabled checkbox to configure SNMP access.
Description	Field that appears if you check the SNMP v2c Enabled checkbox. Enter the community string for the device. Note If you are adding a Catalyst 6500 series chassis, in the Community field, enter the SNMP community string already configured on the Catalyst 6500 series chassis. ANM uses this string to query device status information such as VLAN and interface status. This SNMP community string is also used for any CSM devices contained in the specified Catalyst 6500 series chassis. For Catalyst 6500 series chassis, CSS, and CSM devices, the SNMP community string already configured on the device is used by ANM for polling. For ACE modules and ACE appliances, the SNMP community string entered into ANM is configured on the ACE module/appliance and is used for polling the devices.

Custom Prompt Settings

Table 5-2 *New Device Attributes (continued)*

Field	Description
Custom Username Prompt	Optional field for use with the Cisco Catalyst 6500 series switch and Cisco 7600 series router only. With either device, if you have it configured to use a TACACS+ server for remote authentication, you can also configure it to display a custom username prompt during the login process rather than the default username prompt. If you have the device configured to use a custom username prompt, enter the custom prompt in this field.
Custom Password Prompt	Optional field for use with the Cisco Catalyst 6500 series switch and Cisco 7600 series router only. With either device, if you have it configured to use a TACACS+ server for remote authentication, you can also configure it to display a custom password prompt during the login process rather than the default password prompt. If you have the device configured to use a custom password prompt, enter the custom prompt in this field.

Step 4 Do one of the following:

- Click **Next** to save your entries and import device information. A progress bar displays while ANM establishes a session with the chassis and collects information about the installed modules. When the information has been collected, ANM displays one of the following windows:
 - If no CSM devices or ACE or modules are associated with the chassis device, the All Devices table refreshes with the chassis information.
 - If CSM devices or ACE modules are associated with the chassis device, the Modules configuration window appears and displays information about the first detected module. To view the detected modules, continue to [Step 5](#).
- Click **Cancel** to exit the procedure without saving your entries and to return to the All Devices table. Clicking Cancel prevents device information from being imported and prevents ACE module discovery.

Step 5 In the Modules window, verify the information of the first detected chassis module as described in [Table 5-3](#) and use the **Next** and **Previous** buttons to navigate through the list of detected chassis modules.**Table 5-3** *Detected Modules in Imported Chassis Device*

Item	Description
Card Slot	Chassis IP address, detected module type, and chassis slot number. For example, 10.10.10.1:ACE:2.
Card Type	Version information about the detected module. For example, ACE v2.3. This field displays major release information only. For example, 8.2x might be supported by a module, but only 8.2 displays.
Module Has Been Imported Into ANM	Read only information to indicate that the module has already been imported (checked) or that it has not been imported (unchecked).
Operation To Perform	Drop down list to specify the action to take as follows: <ul style="list-style-type: none"> • Do Not Import (default setting) • Import • Perform Initial Setup and Import

Step 6 To import a displayed module, in the Operation to Perform field, choose one of the following:

- **Import**—ANM is to import the CSM device or ACE module. For the ACE module, ANM displays additional configuration fields when the Import option is selected. For both modules types, skip to [Step 7](#) after selecting **Import**.
- **Perform Initial Setup And Import**—(ACE module only) Allows you to perform initial setup manually required for ANM to communicate with the ACE module and imports ACE module configuration. Skip to [Step 8](#).



Note We recommend that you choose this option for ACE modules that are configured only with factory defaults.

Step 7 If you chose **Import** for a CSM device or ACE module, do one of the following:

- To import a CSM device, no further device information is required. Click **Next** or **Previous** to navigate to the next module to specify to import or click **Finish** to import the specified modules.
- To import an ACE module, perform the following steps:
 - a. In the Admin Context IP field, enter the module IP address.
 - b. In the User Name field, enter the username for accessing this module. Valid entries are unquoted text strings with a maximum of 24 characters. The default admin credentials are admin/admin.



Note For security reasons, we recommend that you change the username and password on your ACE device (and modules) after you import them. The security on your ACE module can be compromised because the administrative username and password are configured to be the same for every ACE module shipped from Cisco. See the [“Changing ACE Module Passwords” procedure on page 5-77](#).

- c. In the Password field, enter the password for accessing this module. Reenter the password in the Confirm field. Valid entries are unquoted text strings with a maximum of 64 characters. The default admin credentials are admin/admin.
- d. Click **Next** or **Previous** to navigate to the next module to specify to import or click **Finish** to import the specified modules.

Skip to [Step 10](#).

Step 8 If you chose **Perform Initial Setup And Import** for an ACE module, perform the following steps:

- a. In the Host Name field, enter a unique name for this ACE module. Valid entries are alphanumeric strings with no spaces and a maximum of 32 characters.
- b. In the Admin Context IP field, enter the IP address for this ACE module.
- c. In the Netmask field, from the drop-down list, choose the subnet mask to apply to this IP address.
- d. In the Gateway field, enter the IP address of the gateway router to use.
- e. In the VLAN field, choose the VLAN to which this module belongs.
- f. Check the Blade Is Configured With Factory Default Admin Credentials check box if the ACE module is currently configured with the default admin credentials (admin/admin).
- g. In the User Name field, enter the username for accessing this module. Valid entries are unquoted text strings with a maximum of 24 characters. The default admin credentials are admin/admin.

**Note**

For security reasons, we recommend that you change the username and password on your ACE after you import it. The security on your ACE module can be compromised because the administrative username and password are configured to be the same for every ACE shipped from Cisco. See the [“Changing ACE Module Passwords” procedure on page 5-77](#).

- h. In the Password field, enter the password for accessing this module. Reenter the password in the Confirm field. Valid entries are unquoted text strings with a maximum of 64 characters. The default admin credentials are admin/admin.

Step 9

Do one of the following:

- Click **OK** to save your entries and to continue with the device configuration. A progress bar reports status and the Device configuration window appears.
- Click **Cancel** to exit the procedure without importing ACE modules and to return to the All Devices table.

**Note**

Clicking Cancel in this window does not cancel the chassis importing process.

Step 10

(Optional) To confirm that the virtual contexts on the ACE module were successfully imported into ANM, do the following:

- a. Choose **Config > Devices**. The device tree appears.
- b. In the device tree, choose the chassis device and ACE module that you just imported. The Virtual Contexts table appears, listing the contexts for that device.
- c. Confirm that the contexts imported successfully:
 - If *OK* appears in the Config Status column, it means that the context imported successfully.
 - If *Import Failed* appears in the Config Status column, it means that the context did not import successfully.
- d. To synchronize the configurations for the context import that failed, choose the context, and then click **Sync**. ANM will synchronize the context by uploading it from the ACE device.

For more information on synchronizing virtual contexts, see the [“Creating Virtual Contexts” procedure on page 6-2](#).

**Note**

If you receive authentication errors or incorrect username/password errors when trying to import ACE devices, refer to the ACE documentation regarding username and password settings and limitations.

**Tip**

After you add an ACE module, see the [“Enabling a Setup Syslog for Autosync for Use With an ACE” section on page 5-27](#) to enable auto sync, which allows ANM to synchronization with the ACE CLI when ANM receives a syslog message from the ACE rather than wait the default polling period.

Relate Topics

- [Importing ACE Modules after the Host Chassis has been Imported, page 5-16](#)
- [Importing CSM Devices after the Host Chassis has been Imported, page 5-19](#)

- [Importing ACE Appliances, page 5-21](#)
- [Importing CSS Devices, page 5-22](#)
- [Importing GSS Devices, page 5-23](#)
- [Importing VMware vCenter Servers, page 5-24](#)
- [Removing Modules from the ANM Database, page 5-80](#)
- [Synchronizing Module Configurations, page 5-67](#)

Importing ACE Modules after the Host Chassis has been Imported

You can add ACE modules into the ANM database at any time after the host chassis been added.

Before You Begin

- Ensure that the module to be imported has booted successfully and is in OK/Pass state. To check the module state, enter the **show module** supervisor Cisco IOS CLI command.
- Note that time needed to import ACE modules depends on the number of modules and contexts that you are importing. For example, an ACE module with 20 virtual contexts takes longer than an ACE module with 5 contexts. While ANM imports the module, you cannot perform other activities in the same session. You can, however, establish a new session with the ANM server and perform activities on other devices, modules, or virtual contexts.
- If you receive authentication errors or incorrect username/password errors when you try to import an ACE module, see the ACE documentation regarding username and password settings and limitations.
- If you physically replace an ACE module in a chassis, you need to synchronize the chassis in ANM. We recommend you start by adjusting syslog settings to facilitate the ANM auto synchronization process as described in the [“Enabling a Setup Syslog for Autosync for Use With an ACE” section on page 5-27](#).

Guidelines and Restrictions

ANM 3.0 and greater releases do not support the importing of an ACE module that contains an A1(6.x) software release or an ACE appliance that contains an A1(7.x) or A1(8.x) software release. If you attempt to import an ACE that supports one of these releases, ANM displays a message to instruct you that it failed to import the unrecognized ACE configuration and that device discovery failed.

However, if you perform an ANM upgrade (for example, from ANM 2.2 to ANM 3.0), and the earlier ANM release contained an inventory with an ACE module that supported the A1(6x) software release or an ACE appliance that supported the A1(7.x) or A1(8.x) software release, ANM 3.0 (and greater) allows the A1(x) software release to reside in the ANM database and will support operations for the release. ANM prevents a new import of an ACE module or ACE appliance that contains the unsupported software version.

We strongly recommend that you upgrade your ACE module or ACE appliance to a supported ACE software release, and that you instruct ANM to recognize the updated release. See the [“Instructing ANM to Recognize an ACE Module Software Upgrade” section on page 5-71](#).

See the [Supported Device Tables for the Cisco Application Networking Manager](#) for a complete list of supported ACE module and ACE appliance software releases.

Prerequisites

The host chassis of the ACE module that you are adding has been imported (see the [“Importing Cisco IOS Host Chassis and Chassis Modules” section on page 5-11](#)).

Procedure

- Step 1** Choose **Config > Devices > All Devices**.
The All Devices table appears.
- Step 2** In the All Devices table, choose the host device that contains the ACE module you want to import and click **Modules**.
The Modules table appears, which displays a list of the installed modules.
- Step 3** In the Modules table, choose the module that you want to import and click **Import**.
The Modules configuration window appears.
- Step 4** In the Modules window, verify the information of the selected module as described in [Table 5-4](#).

Table 5-4 *Importing ACE Modules*

Item	Description
Card Slot	Chassis IP address, detected module type, and chassis slot number. For example, 10.10.10.1:ACE:2.
Card Type	Version information about the detected module. For example, ACE v2.3. This field displays major release information only. For example, 8.2x might be supported by a module, but only 8.2 displays.
Module Has Been Imported Into ANM	Read only information to indicate that the module has already been imported (checked) or that it has not been imported (unchecked).
Operation To Perform	Drop down list to specify the action to take as follows: <ul style="list-style-type: none"> Do Not Import (default setting) Import Perform Initial Setup and Import

- Step 5** To import a displayed module, in the Operation to Perform field, choose one of the following:
- Import**—ANM is to import the ACE module. ANM displays additional configuration fields when the Import option is selected. For both modules types, skip to [Step 6](#) after selecting **Import**.
 - Perform Initial Setup And Import**—Allows you to perform initial setup manually required for ANM to communicate with the ACE module and imports ACE module configuration. Skip to [Step 7](#).



Note We recommend that you choose this option for ACE modules that are configured only with factory defaults.

- Step 6** If you chose **Import**, perform the following steps:
- In the Admin Context IP field, enter the module IP address.
 - In the User Name field, enter the username for accessing this module. Valid entries are unquoted text strings with a maximum of 24 characters. The default admin credentials are admin/admin.



Note For security reasons, we recommend that you change the username and password on your ACE device (and modules) after you import them. The security on your ACE module can be compromised because the administrative username and password are configured to be the same for every ACE module shipped from Cisco. See the [“Changing ACE Module Passwords” procedure on page 5-77](#).

- c. In the Password field, enter the password for accessing this module. Reenter the password in the Confirm field. Valid entries are unquoted text strings with a maximum of 64 characters. The default admin credentials are admin/admin.
- d. Click **Next** or **Previous** to navigate to the next module to specify to import or click **Finish** to import the specified modules.

Skip to [Step 9](#).

Step 7 If you chose **Perform Initial Setup And Import**, perform the following steps:

- a. In the Host Name field, enter a unique name for this ACE module. Valid entries are alphanumeric strings with no spaces and a maximum of 32 characters.
- b. In the Admin Context IP field, enter the IP address for this ACE module.
- c. In the Netmask field, from the drop-down list, choose the subnet mask to apply to this IP address.
- d. In the Gateway field, enter the IP address of the gateway router to use.
- e. In the VLAN field, choose the VLAN to which this module belongs.
- f. Check the Blade Is Configured With Factory Default Admin Credentials check box if the ACE module is currently configured with the default admin credentials (admin/admin).
- g. In the User Name field, enter the username for accessing this module. Valid entries are unquoted text strings with a maximum of 24 characters. The default admin credentials are admin/admin.



Note For security reasons, we recommend that you change the username and password on your ACE after you import it. The security on your ACE module can be compromised because the administrative username and password are configured to be the same for every ACE shipped from Cisco. See the [“Changing ACE Module Passwords” procedure on page 5-77](#).

- h. In the Password field, enter the password for accessing this module. Reenter the password in the Confirm field. Valid entries are unquoted text strings with a maximum of 64 characters. The default admin credentials are admin/admin.

Step 8 Do one of the following:

- Click **OK** to save your entries and to continue with the device configuration. A progress bar reports status and the Device configuration window appears.
- Click **Cancel** to exit the procedure without importing ACE modules and to return to the All Devices table.



Note Clicking Cancel in this window does not cancel the chassis importing process.

Step 9 (Optional) To confirm that the virtual contexts on the ACE module were successfully imported into ANM, do the following:

- a. Choose **Config > Devices**. The device tree appears.

- b. In the device tree, choose the chassis device and ACE module that you just imported. The Virtual Contexts table appears, listing the contexts for that device.
- c. Confirm that the contexts imported successfully:
 - If *OK* appears in the Config Status column, it means that the context imported successfully.
 - If *Import Failed* appears in the Config Status column, it means that the context did not import successfully.
- d. To synchronize the configurations for the context import that failed, choose the context, and then click **Sync**. ANM will synchronize the context by uploading it from the ACE device.
For more information on synchronizing virtual contexts, see the [“Creating Virtual Contexts” procedure on page 6-2](#).

**Note**

If you receive authentication errors or incorrect username/password errors when trying to import ACE devices, refer to the ACE documentation regarding username and password settings and limitations.

**Tip**

After you add ACE devices, see the [“Enabling a Setup Syslog for Autosync for Use With an ACE” section on page 5-27](#) to enable auto sync, which allows ANM to synchronize with the ACE CLI when ANM receives a syslog message from the ACE rather than wait the default polling period.

Related Topics

- [Importing Cisco IOS Host Chassis and Chassis Modules, page 5-11](#)
- [Importing ACE Appliances, page 5-21](#)
- [Importing CSS Devices, page 5-22](#)
- [Importing GSS Devices, page 5-23](#)
- [Importing VMware vCenter Servers, page 5-24](#)
- [Removing Modules from the ANM Database, page 5-80](#)
- [Synchronizing Module Configurations, page 5-67](#)

Importing CSM Devices after the Host Chassis has been Imported

You can import CSM devices into the ANM database at any time after the host chassis or router has been imported.

**Note**

ANM assigns the device type CSM to both CSM and CSM-S devices. This assignment has to do with how ANM collects and assigns the information that it receives from the device and does not affect functionality. To differentiate between these devices, see the description information in the user interface.

Prerequisites

The host chassis of the CSM that you are adding has been imported (see the [“Importing Cisco IOS Host Chassis and Chassis Modules” section on page 5-11](#)).

Procedure

- Step 1** Choose **Config > Devices > All Devices**.
The All Devices table appears.
- Step 2** In the All Devices table, choose the host device that contains the CSM that you want to import, and then click **Modules**.
The Modules table appears.
- Step 3** In the Modules table, choose the CSM that you want to import, and then click **Import**.
The Modules configuration window appears.
- Step 4** Verify that the information is correct in the following read-only fields:
- Card Slot—The slot in the chassis in which the module resides.
 - Card Type—The device type; in this instance, CSM.
 - Module Has Been Imported Into ANM—The checkbox is checked to indicate that the module has already been imported or cleared to indicate that it has not been imported.
- Step 5** In the Operation to Perform field, choose **Import**.
- Step 6** Do one of the following:
- Click **OK** to save your entries. A progress bar reports status and the Modules table refreshes with updated information.
 - Click **Cancel** to exit the procedure without importing the device and to return to the Modules table.
-

Related Topics

- [Importing Cisco IOS Host Chassis and Chassis Modules, page 5-11](#)
- [Importing ACE Appliances, page 5-21](#)
- [Importing CSS Devices, page 5-22](#)
- [Importing GSS Devices, page 5-23](#)
- [Importing VMware vCenter Servers, page 5-24](#)
- [Removing Modules from the ANM Database, page 5-80](#)
- [Synchronizing Module Configurations, page 5-67](#)

Importing VSS 1440 Devices after the Host Chassis has been Imported

Catalyst 6500 Virtual Switching Systems (VSS) 1440 devices allow for the combination of two switches into a single, logical network entity from the network control plane and management perspectives. To the neighboring devices, the Cisco Virtual Switching System appears as a single, logical switch or router.

VSS devices will be discovered as normal Cisco IOS devices in ANM if the devices are already converted to virtual switch mode.

**Note**

ANM does not recognize failure scenarios as discussed in the “Configuring Virtual Switching System” section of the “*Catalyst 6500 Release 12.2SXH and Later Software Configuration Guide*” on Cisco.com at <http://www.cisco.com/en/US/docs/switches/lan/catalyst6500/ios/12.2SX/configuration/guide/vss.html#wp1062314>.

Related Topics

[Importing Cisco IOS Host Chassis and Chassis Modules, page 5-11](#)

Importing ACE Appliances

This section shows how to import an ACE appliance into ANM.

Procedure

-
- Step 1** Choose **Config > Devices > All Devices**.
The All Devices table appears.
- Step 2** In the All Devices table, choose the **Add** button.
The New Device window appears.
- Step 3** In New Device window, define the ACE appliance to import using the information in [Table 5-5](#).

Table 5-5 ACE Appliance Configuration Options

Field	Description
Name	Name assigned to the ACE appliance.
Model	Drop-down list to specify the device type. From the Model drop-down list, choose ACE 4710 (appliance).
Primary IP	ACE appliance IP address.
User Name	Username that has the administrator role.
Password	Password that corresponds to the username.
Confirm	Confirmation of the password.
Description	Brief device description.

- Step 4** Do one of the following:
- Click **OK** to save your entries. After ANM adds the specified device, the Primary Attributes window for the device appears.
 - Click **Cancel** to exit the procedure without importing the device and to return to the Modules table.
-

Related Topics

- [Importing Network Devices into ANM, page 5-10](#)
- [Importing Cisco IOS Host Chassis and Chassis Modules, page 5-11](#)

- [Importing CSS Devices, page 5-22](#)
- [Importing GSS Devices, page 5-23](#)
- [Importing VMware vCenter Servers, page 5-24](#)

Importing CSS Devices

This section shows how to import CSS devices into ANM.

Procedure

-
- Step 1** Choose **Config > Devices > All Devices**.
- The All Devices table appears.
- Step 2** In the All Devices table, choose the **Add** button.
- The New Device window appears.
- Step 3** In New Device window, define the CSS device to import using the information in [Table 5-6](#).

Table 5-6 CSS Configuration Options

Field	Description
Name	Name assigned to the device.
Model	Drop-down list to specify the device type. From the Model drop-down list, choose CSS .
Primary IP	Device IP address.
Access Protocol	Protocol that ANM is to use when communicating with the CSS. Choose one of the following: <ul style="list-style-type: none"> • Secure/SSH (default setting) • Telnet
User Name	Username that has the administrator role.
Password	Password that corresponds to the username.
Confirm	Confirmation of the password.
SNMP v2c Enabled	Checkbox to enable SNMP v2c.
Description	Brief device description.

- Step 4** Do one of the following:
- Click **OK** to save your entries. After ANM adds the specified device, the Primary Attributes window for the device appears (see the [“Configuring CSS Primary Attributes”](#) section on page 5-35).
 - Click **Cancel** to exit the procedure without importing the device and to return to the Modules table.
-

Related Topics

- [Importing Network Devices into ANM, page 5-10](#)
- [Importing Cisco IOS Host Chassis and Chassis Modules, page 5-11](#)
- [Importing ACE Appliances, page 5-21](#)

- [Importing GSS Devices, page 5-23](#)
- [Importing VMware vCenter Servers, page 5-24](#)

Importing GSS Devices

This section shows how to import GSS devices into ANM.

Guidelines and Restrictions

Follow these guidelines for importing GSS devices into ANM:

- You only need to import the primary GSSM into ANM—You are not required or permitted to add either the standby GSSM or GSS device. ANM communicates only with the primary GSSM for activation and suspension of DNS rules and virtual IP (VIP) answers and for collecting statistics.
- GSS graphical user interface (GUI) and CLI must have matching passwords—The username that you configure while adding a GSS device to ANM must be the same on both the GSS GUI and GSS CLI.
- Communication between ANM and the primary GSSM is accomplished using the GSS Communication Ethernet Interface—This interface is used for internal communication between the primary GSSM and the other GSS devices in the GSS cluster. Beginning with ANM 4.3, ANM uses Java Remote Method Invocation (RMI) only to communicate with GSS devices using software Version 3.3 or later versions. If the GSS device is using an earlier version of software and ANM cannot communicate with it using RMI, ANM uses Secure Shell (SSH).

[Table 5-7](#) lists the TCP ports that ANM uses to communicate with GSS devices.

Table 5-7 TCP Ports Used by ANM for GSS

Port	Description
22	SSH
2001	Java RMI
3009	Secure RMI



Note

When ANM uses SSH for GSS communication, terminal length settings are set to 0 during import, synchronization, and background polling. The previous terminal length settings that you had before import, synchronization, and background polling is performed are not preserved.

Procedure

- Step 1** Choose **Config > Devices > All Devices**.
The All Devices table appears.
- Step 2** In the All Devices table, choose the **Add** button.
The New Device window appears.
- Step 3** In New Device window, define the GSS device to import using the information in [Table 5-8](#).

Table 5-8 **GSS Configuration Options**

Field	Description
Name	Name assigned to the device.
Model	Drop-down list to specify the device type. From the Model drop-down list, choose GSS .
Primary IP	Device IP address.
User Name	Username that has the administrator role.
Password	Password that corresponds to the username.
Confirm	Confirmation of the password.
Enable Password	Password for remote authorization. When the GSS is configured for remote authorization with the enable command in the user privilege, then the enable password is not used.
Confirm	Confirmation of the enable password.
Description	Brief description for this device.

Step 4 Do one of the following:

- Click **OK** to save your entries. After ANM adds the specified device, the Primary Attributes window for the device appears (see the “[Configuring GSS Primary Attributes](#)” section on page 5-36).
- Click **Cancel** to exit the procedure without importing the device and to return to the Modules table.

Related Topics

- [Importing Network Devices into ANM, page 5-10](#)
- [Importing Cisco IOS Host Chassis and Chassis Modules, page 5-11](#)
- [Importing ACE Appliances, page 5-21](#)
- [Importing CSS Devices, page 5-22](#)
- [Importing VMware vCenter Servers, page 5-24](#)

Importing VMware vCenter Servers

This section shows how to import VMware vCenter Servers that are part of a VMware virtual datacenter containing virtual machines (VM). When you import a VMware vCenter Server, ANM discovers the following network entities associated with the server: datacenters, VMs, and hosts (VMware ESX servers).

During the VMware vCenter Server import process, you can enable the ANM plug-in that allows you to access ANM ACE real server functionality from a VMware vSphere Client. Registering the plug-in provides the client with a URL to access ANM and retrieve the required XML definition file. ANM uses HTTPS for communication with VMware vCenter Server.

Guidelines and Restrictions

This topic includes the following guidelines and restrictions:

- ANM does not recognize all the special characters that VMware allows you to use in a VM name. If you import a VMware vCenter Server containing VM names that use certain special characters, ANM encounters issues that affect the VM Mappings window (Config > Devices > vCenter > System > VM Mappings). This window shows how VMs map to real servers.

The issues associated with certain special characters in VM names are as follows:

- When a VM name contains a double quote (“), ANM is not able to display the VM Mappings window (a blank window displays).
- When a VM name contains a percent sign (%), backslash (\), or forward slash (/), ANM displays the VM name in the VM Mappings window; however, these special characters display as hex values (%25 for %, %5c for \, and %2f for /).

To avoid these issues, remove these special characters from the VM name before you use the following procedure to import the VMware vCenter Server in to ANM.

- ANM supports importing a VMware vCenter Server operating in standard mode only. You cannot import a vCenter Server operating in linked mode.

Procedure

-
- Step 1** Choose **Config > Devices > All Devices**.
The All Devices table appears.
- Step 2** In the All Devices table, choose the **Add** button.
The New Device window appears.
- Step 3** In New Device window, configure the VMware vCenter Server using the information in [Table 5-9](#).

Table 5-9 VMware vCenter Server Configuration Options

Field	Description
Name	Name assigned to the device.
Model	Drop-down list of available device types. From the Model drop-down list, choose vCenter .
Primary IP	VMware vCenter Server IP address.
HTTPS Port	Port that the VMware vCenter Server uses to communicate with ANM using HTTPS.
User Name	VMware vCenter Server username that has the administrator role or an equivalent role that has privilege on “Extension,” “Global->Manage custom attribute,” and “Global->Set custom attribute.”
Password	Password that corresponds to the VMware vCenter Server username.

Table 5-9 VMware vCenter Server Configuration Options (continued)

Field	Description
ANM vCenter Plug-in	<p>Registers the ANM plug-in when adding the VMware vCenter Server. Registering the plug-in provides the VMware vCenter Server and associated VMware vSphere Clients with a URL to access ANM and retrieve the required XML definition file. ANM uses HTTPS for communication with the VMware vCenter Server and vSphere Clients. When the plug-in is registered, you can access ANM ACE real server functionality from a VMware vSphere Client.</p> <p>Choose one of the following options:</p> <ul style="list-style-type: none"> • Import vCenter and register plug-in • Import vCenter and but do not register plug-in (default setting) <p>To register or unregister the ANM plug-in at a later time, see the “Registering or Unregistering the ANM Plug-in” section on page B-5.</p>
ANM Server	<p>DNS name or IP address of the ANM server that will be used by the VMware vCenter Server and vSphere Client. By default, ANM populates this field with the virtual IP address or hostname or all of the available IP addresses. If you enter a DNS name, make sure that the name can be resolved on the VMware vSphere Client side of the network.</p> <p> Note For ANM servers operating in an HA configuration, choose the shared alias IP address or VIP address for the HA pair so that the plug-in can still be used after an HA failover occurs.</p>

- Step 4** Do one of the following:
- Click **OK** to save your entries. After ANM adds the VMware vCenter Server, the Primary Attributes window for the VMware vCenter Server appears (see the [“Configuring VMware vCenter Server Primary Attributes”](#) section on page 5-41).
 - Click **Cancel** to exit the procedure without importing the device and to return to the Modules table.

Related Topics

- [Configuring VMware vCenter Server Primary Attributes, page 5-41](#)
- [Using the ANM Plug-In With Virtual Data Centers, page B-1](#)
- [Mapping Real Servers to VMware Virtual Machines, page 5-68](#)
- [Importing Network Devices into ANM, page 5-10](#)
- [Importing Cisco IOS Host Chassis and Chassis Modules, page 5-11](#)
- [Importing ACE Appliances, page 5-21](#)
- [Importing CSS Devices, page 5-22](#)
- [Importing GSS Devices, page 5-23](#)

Enabling a Setup Syslog for Autosync for Use With an ACE

You can set up auto synchronization to occur when ANM receives a syslog message from ACE devices. This feature allows a faster, more streamlined synchronization process between ANM and any out-of-band configuration changes. Rather than wait the default polling period, ANM will synchronize when a syslog message is received if you enable the Autosync feature.



Note ANM does not support Autosync for GSS devices.

Procedure

Step 1 Choose **Config > Devices**. From the device tree, select either an ACE module or an ACE appliance.

Step 2 Choose **Setup Syslog for Autosync**.

The Setup Syslog for Autosync window appears.

Step 3 Choose one or more virtual contexts for which you want to receive Autosync syslog messages.

Step 4 Click the **Setup Syslog** button.

A progress bar window appears.

The following CLI commands are sent to the enabled ACE devices:

```
logging enable
logging trap 2
logging device-id string <ACE-IP>/Admin
logging host <ANM-IP> udp/514
logging message 111008 level 2
```

Step 5 If the setup is successful, a checkbox with check mark will appear in the Setup Syslog for Autosync? column for each virtual context that you selected. If there are any errors, the errors will be shown in a popup window.

Discovering Large Numbers of Devices Using IP Discovery

The IP Discovery feature allows you to discover and import Cisco chassis and ACEs into the ANM database as follows:

1. Preparing devices for discovery. This process involves enabling SSH and XML over HTTPS and adding device credentials. See the [“Preparing Devices for IP Discovery”](#) section on page 5-28.
2. Discovering devices residing on your network. The ANM uses SSH, XML over HTTPS, and Telnet to discover its supported devices. When you run IP Discovery, you locate IP addresses of ACE chassis and appliances. See the [“Running IP Discovery to Identify Devices”](#) section on page 5-31.

After discovery, devices do not appear in the Devices table until device import is completed. To import a specific chassis into the ANM database, you need to enter IP and credentials information for the chassis and then import it and any associated modules. While this discovery method requires you to add more information initially, it provides more control over the discovery process.

3. Importing the device information into the ANM database to add the device into the Devices table. See the [“Importing Network Devices into ANM”](#) section on page 5-10.
4. After importing a module host device, such as a Catalyst 6500 series chassis, you can add ACE modules and CSMs into the ANM database. See the [“Importing ACE Modules after the Host Chassis has been Imported”](#) section on page 5-16 or the [“Importing CSM Devices after the Host Chassis has been Imported”](#) section on page 5-19.
5. After you start a discovery job, you can monitor its status. See the [“Monitoring IP Discovery Status”](#) section on page 5-33.

ANM offers multiple ways to accomplish some of these steps. For example, you can either run a discovery job to identify the available chassis, and then choose the ones to import, or you can import a specific chassis into the ANM database.

To add a chassis without running discovery, see the [“Importing Cisco IOS Host Chassis and Chassis Modules”](#) section on page 5-11.

See the [Supported Devices Table for Cisco Application Networking Manager](#) for more information about the devices that ANM supports.

This section includes the following topics:

- [Preparing Devices for IP Discovery](#), page 5-28
- [Running IP Discovery to Identify Devices](#), page 5-31
- [Monitoring IP Discovery Status](#), page 5-33

Preparing Devices for IP Discovery

This section describes how to prepare your Cisco devices for IP Discovery by enabling SSH and Telnet on each device and by configuring device SSH and Telnet credentials through ANM. These tasks enable ANM to communicate with the devices and collect data from them.



Caution

IP Discovery sends unencrypted credentials (Telnet and SNMP) to all devices on the specified subnet who respond to the associated ports. This is a potential security risk because credentials are broadcast out to one or more networks. IP Discovery may also find devices that cannot be imported or may not be able to locate devices that could be imported.

Guidelines and Restrictions

Network latency can prevent ANM from establishing a communication link with a device that you want to import. When ANM is providing the device with the device credentials (username and password), by default it waits two seconds after providing the device username for the password prompt to appear. The link times out when it takes longer than two seconds for the next prompt to appear. For information about possible causes of network latency that can create this issue and how to adjust the ANM timeout value, see the [“Modifying the ANM Timeout Setting to Compensate for Network Latency”](#) section on page 5-9.

Before You Begin

Ensure that you have enabled SSH and Telnet in your Cisco network devices by performing the tasks described in the following sections:

- [Enabling SSH or Telnet Access on Catalyst 6500 Series Switches and Cisco 7600 Series Routers](#), page 5-5
- [Enabling SSH Access and the HTTPS Interface on the ACE Module and Appliance](#), page 5-6

This section includes the following topics:

- [Configuring Device Access Credentials, page 5-29](#)
- [Modifying Credential Pools, page 5-30](#)

Configuring Device Access Credentials

You can add device credentials to ANM before running IP Discovery.

Procedure

-
- Step 1** Choose **Config > Tools > Credential Pool Management**.
The New Credential Pool window appears.
- Step 2** In the Name field, enter the name of the new credential pool.
- Step 3** Click **Save** to save this entry and to proceed with credentials configuration.
The configuration window appears.
- Step 4** Set the Telnet credentials as follows:
- Choose **Configuration > Telnet Credentials**. The Telnet Credentials table appears.
 - In the table, click **Add** to add a set of credentials to this credential pool, or choose an existing set of credentials, and click **Edit** to modify it.
 - Enter the credentials (see [Table 5-10](#)).

Table 5-10 *Telnet Credentials*

Field	Description
IP Address	Specific IP address in dotted-decimal notation or use an asterisk (*) as a wildcard character to identify a number of devices, such as 192.168.11.*.
User Name	Telnet username for the specified devices.
Password	Telnet password for the specified devices.
Confirm	Telnet password that you reenter.
Enable Password	Telnet enable password for the specified devices. ANM uses this password during the Catalyst 6500 series chassis and Catalyst 6500 Virtual Switching System (VSS) 1440 import process.
Confirm	Telnet enable password that you reenter.

- Do one of the following:
 - Click **OK** to save your entries and to return to the Telnet Credentials table.
 - Click **Cancel** to exit this procedure without saving your entries and to return to the Telnet Credentials table.
 - Click **Next** to deploy your entries and to add another set of Telnet credentials.
- Step 5** Set the SNMP credentials as follows:
- Choose **Configuration > SNMP Credentials**. The SNMP Credentials table appears.
 - Click **Add** to add a set of credentials to this credential pool, or choose an existing set of credentials, and click **Edit** to modify it.

- c. Enter the SNMP credentials (see [Table 5-11](#)).

Table 5-11 *SNMP Credentials*

Field	Description
IP Address	Specific IP address in dotted-decimal notation is used or an asterisk (*) is used as a wildcard character to identify a number of devices, such as 192.168.11.*.
Mode	Default version of SNMP is selected for this credential pool. Snmpv2 indicates that SNMP version 2 is to be used for this credential pool for the specified devices.
RO Community	SNMP read-only string for the specified devices. This entry is case sensitive.
Timeout	Time, in seconds, that the ANM is to wait for response from a device before performing the first retry.
Retries	Number of times that the ANM is to attempt to communicate with a device before declaring that the device has timed out.

Step 6 Do one of the following:

- Click **OK** to save your entries and to return to the SNMP Credentials table.
- Click **Cancel** to exit without saving your entries and to return to the SNMP Credentials table.
- Click **Next** to deploy your entries and to configure another set of SNMP credentials.

After establishing the Telnet and SNMP credentials, you are ready to run IP Discovery. See the “[Running IP Discovery to Identify Devices](#)” section on page 5-31.

Related Topics

- [Running IP Discovery to Identify Devices, page 5-31](#)
- [Configuring Device Access Credentials, page 5-29](#)
- [Discovering Large Numbers of Devices Using IP Discovery, page 5-27](#)

Modifying Credential Pools

You can modify existing Telnet or SNMP credentials.

Procedure

Step 1 Choose **Config > Tools > Credential Pool Management**.

The Credential Pools configuration window appears.

Step 2 Choose the credential pool that you want to modify.

The Edit Credential Pool configuration window appears.

Step 3 Click **Edit**.

Step 4 To modify the existing Telnet credentials, do the following:

- a. Choose **Configuration > Telnet Credentials**. The Telnet Credentials table appears.
- b. In the table, click **Add** to add a set of credentials to this credential pool, or choose an existing set of credentials, and click **Edit** to modify it.

- c. Enter the Telnet credentials (see [Table 5-10](#)).
- d. Do one of the following:
 - Click **OK** to save your entries and to return to the Telnet Credentials table.
 - Click **Cancel** to exit this procedure without saving your entries and to return to the Telnet Credentials table.
 - Click **Next** to deploy your entries and to add another set of Telnet credentials.

Step 5 To modify the existing SNMP credentials, do the following:

- a. Choose **Configuration > SNMP Credentials**. The SNMP Credentials table appears.
- b. Click **Add** to add a set of credentials to this credential pool, or choose an existing set of credentials, and click **Edit** to modify it.
- c. Enter the SNMP credentials (see [Table 5-11](#)).
- d. Do one of the following:
 - Click **OK** to save your entries and to return to the SNMP Credentials table.
 - Click **Cancel** to exit without saving your entries and to return to the SNMP Credentials table.
 - Click **Next** to deploy your entries and to configure another set of SNMP credentials.

Related Topics

- [Running IP Discovery to Identify Devices, page 5-31](#)
- [Configuring Device Access Credentials, page 5-29](#)
- [Discovering Large Numbers of Devices Using IP Discovery, page 5-27](#)

Running IP Discovery to Identify Devices

You can run IP Discovery to locate IP addresses of the Catalyst 6500 series chassis (hosting the ACE module), ACE appliance, and Catalyst 6500 Virtual Switching System (VSS) devices.

After establishing Telnet and SNMP credentials (see the [“Configuring Device Access Credentials” section on page 5-29](#)), use this procedure to identify chassis and ACEs on your network.



Caution

IP Discovery sends unencrypted credentials (Telnet and SNMP) to all devices on the specified subnet that respond to the associated ports. This is a potential security risk because credentials are broadcast out to one or more networks. IP Discovery may also find devices that cannot be imported or be unable to find devices that could be imported.

Before You Begin

For this procedure, you need the follow items:

- IP address for the discovery process.
- Applicable subnet mask.
- Valid credentials for this discovery (see the [“Configuring Device Access Credentials” section on page 5-29](#)).

- Verification that the devices have SSH enabled (see the [“Preparing Devices for IP Discovery” section on page 5-28](#)).

Procedure

Step 1 Choose **Config > Tools > IP Discovery**.

The Discovery Jobs table appears.



Tip If you already know the IP address of your devices, use the **Config > Devices > Add** function. See the [“Importing Network Devices into ANM” section on page 5-10](#).

Step 2 To create a discovery job, click **Add**.

The Discovery Jobs window appears.

Step 3 In the IP Address field, enter the IP address of a specific device in dotted-decimal notation such as 192.168.11.1.

Step 4 In the Netmask field, choose the subnet mask to be used. When you specify a subnet mask, the discovery process discovers all devices in the range of the IP address and its subnet mask. The default netmask is 255.255.255.0.



Note Choose a higher subnet mask only if you are certain that it is appropriate for your network and you understand the impact. If you choose the subnet mask for a class A or class B network, the discovery process becomes extensive and can take a substantial amount of time to complete.

Step 5 In the Credential Pool field, choose the credential pool to be used for this discovery.

Step 6 Click **Discover** to run discovery now or **Cancel** to exit this procedure without running discovery.

When you run IP Discovery, the Discovery Jobs table reflects the state of the discovery as it runs. The amount of time to finish a discovery job depends on the size of your network and network activity.

If necessary, click **Stop** to stop the discovery process. When the process has stopped, the Discovery Jobs table appears with the discovery job in the table with the state *Aborted*.



Tip Click **Refresh** during IP Discovery to see the number of devices found as the discovery process progresses.

Step 7 (Optional) View the discovery process status (see the [“Monitoring IP Discovery Status” section on page 5-33](#)).

Step 8 (Optional) Import ACE devices into the ANM when the discovery process is complete (see the [“Importing Network Devices into ANM” section on page 5-10](#)).

Related Topics

- [Creating Virtual Contexts, page 6-2](#)
- [Importing Network Devices into ANM, page 5-10](#)
- [Using Configuration Building Blocks, page 16-1](#)

Monitoring IP Discovery Status

You can monitor device discovery status after starting a discovery job.

Procedure

Step 1 Click **Config > Tools > IP Discovery**.

The Discovery Jobs table appears with the following information for each discovery job:

- IP address
- Subnet mask
- Start Time in the format *hh:mm:ss.nnn*
- End Time, if available, in the format *hh:mm:ss.nnn*
- Credential Pool being used
- State of the discovery job, such as *Running* or *Completed*
- Number of devices found

Step 2 Locate your discovery job to see its current status.

If necessary, click **Stop** to stop the discovery process. When the process has stopped, the Discovery Jobs table appears with the discovery job in the table with the state *Aborted*.

Step 3 When discovery is complete, choose the discovery job in the table. A list of the discovered devices appears below the Discovery Jobs table.

You can now populate the ANM with chassis and ACEs. See the [“Importing Network Devices into ANM” section on page 5-10](#).

Related Topics

- [Importing Network Devices into ANM, page 5-10](#)
- [Running IP Discovery to Identify Devices, page 5-31](#)
- [Information About Importing Devices, page 5-4](#)

Configuring Devices

This section describes how to configure the devices that you add to ANM and includes the following topics:

- [Configuring Device System Attributes, page 5-34](#)
- [Configuring Catalyst 6500 Series Chassis or Cisco 7600 Series Router Interfaces, page 5-41](#)
- [Managing Catalyst 6500 Series Chassis or Cisco 7600 Series Router VLANs, page 5-48](#)

**Note**

The ANM does not detect changes made to a chassis device through the CLI. Be sure to synchronize chassis configurations whenever chassis configuration has been modified via the CLI.

Configuring Device System Attributes

This section shows how to configure the device system attributes. For the CSM, CSS, and GSS devices, the system attributes consist of the primary attributes only. For the Catalyst 6500 series chassis, Catalyst 6500 Virtual Switching System (VSS) 1440 devices, and Cisco 7600 series routers, the system attributes also include the static route attributes.

This section includes the following topics:

- [Configuring CSM Primary Attributes](#)
- [Configuring CSS Primary Attributes](#)
- [Configuring GSS Primary Attributes](#)
- [Configuring Catalyst 6500 VSS 1440 Primary Attributes](#)
- [Configuring Catalyst 6500 Series Chassis and Cisco 7600 Series Router Primary Attributes](#)
- [Configuring Catalyst 6500 Series Chassis, Catalyst 6500 Virtual Switching System 1440 Devices, and Cisco 7600 Series Routers Static Routes](#)
- [Configuring VMware vCenter Server Primary Attributes](#)

Configuring CSM Primary Attributes

You can configure primary attributes for CSM devices.

Procedure

-
- Step 1** Choose **Config > Devices > All Devices**.
The device tree appears.
 - Step 2** In the device tree, choose the CSM that you want to configure, and then choose **System > Primary Attributes**.
The Primary Attributes window appears.
 - Step 3** In the Description field, enter a brief description of the module.
 - Step 4** Choose another CSM for high availability pairing from the Redundant Device field, which displays any other CSM devices that have been imported into ANM.

Step 5 Click **Deploy Now** to deploy this configuration on the CSM and save your entries to the running-configuration and startup-configuration files.

To exit this procedure without deploying your entries, choose another device in the device tree or in the object selector above the configuration pane.

Related Topics

- [Configuring Devices, page 5-34](#)
- [Importing ACE Modules after the Host Chassis has been Imported, page 5-16](#)

Configuring CSS Primary Attributes

You can configure primary attributes for CSS devices.

Procedure

Step 1 Choose **Config > Devices > All Devices**.

The All Devices table appears.

Step 2 In the All Devices table, choose the CSS that you want to configure, and then choose **System > Primary Attributes**.

The Primary Attributes window appears with information about the device.

Step 3 Configure the CSS using the information in [Table 5-12](#).



Note Most of the information is read directly from the device during the import process and cannot be changed using the ANM interface.

Table 5-12 CSS Primary Attributes Configuration Options

Field	Description
Description	Brief description for this device.
Device Type	Read-only field that has the device type in gray.
Use Telnet	Read-only field that will be checked if the device was imported using Telnet.
IP Address	Read-only field with the device IP address.
Redundant Device	Field that displays any other CSS devices that have been imported into the ANM database. Choose another CSS for high availability pairing.

Table 5-12 CSS Primary Attributes Configuration Options (continued)

Field	Description
SNMP v2c Enabled	<p>Checkbox to enable SNMP version 2c access. Uncheck the checkbox to disable this feature.</p> <p>If you enable this feature, in the SNMP Trap Community string field, enter the SNMP community string.</p>
SNMP v3 Enabled	<p>Checkbox to enable SNMP Version 3 access. Uncheck the checkbox to disable this feature.</p> <p>If you enable this feature, do the following:</p> <ol style="list-style-type: none"> 1. In the SNMP V3 User Name field, enter the SNMP username. 2. In the SNMP V3 Mode field, choose the level of security to be used when accessing the chassis: <ul style="list-style-type: none"> • NoAuthNoPriv—SNMP uses neither authentication nor encryption in its communications. • AuthNoPriv—SNMP uses authentication, but the data is not encrypted. 3. If you choose AuthNoPriv, do the following: <ol style="list-style-type: none"> a. In the SNMP V3 Auth Proto field, choose MD5 or DES to specify the authentication mechanism. b. In the SNMP V3 Auth Pass field, enter the user authentication password. Valid entries are unquoted text strings with no spaces and a maximum of 130 characters. c. In the Confirm field, reenter the user authentication password.

Step 4 Click **Deploy Now** to deploy this configuration on the CSS and to save your entries to the running-configuration and startup-configuration files.

To exit this procedure without deploying your entries, choose another device in the device tree or in the object selector above the configuration pane.

Related Topics

- [Configuring Devices, page 5-34](#)
- [Importing Network Devices into ANM, page 5-10](#)

Configuring GSS Primary Attributes

You can configure primary attributes for Cisco Global Site Selector devices.

Procedure

- Step 1** Choose **Config > Devices > All Devices**.
The All Devices table appears.
- Step 2** In the All Devices table, choose the GSS that you want to configure, and then choose **System > Primary Attributes**.
The Primary Attributes window appears with information about the device.
- Step 3** Configure the GSS using the information in [Table 5-13](#).

Table 5-13 GSS Primary Attributes Configuration Options

Field	Description
Description	Brief description for this device.
Device Type	Read-only field that has the device type, in this case GSS, in gray.
IP Address	Device IP address.

Step 4 (Optional) To update the IP address and/or password for the GSS on the ANM server only, click **Update IP Address/Password**.

The Update IP Address/Password window appears.



Note The password changes are for the ANM server only. The Password/Enable password on the device will not be changed.

Enter new credentials in the Update IP Address/Password window using the information in [Table 5-14](#).

Table 5-14 GSS Change IP Address and Password Options

Field	Description
Old Primary IP Address	Read-only field displaying the device IP address.
New Primary IP Address	IP address that you wish to have GSS associated with on the server.
Update	Available password update choices are as follows: <ul style="list-style-type: none"> • Both—Update both the password and enable passwords. • Enable Password Only—Update only the enable password. • Password Only—Update only the password.
New Password	New password.
Confirm New Password	New password that you reenter.
New Enable Password	New enable password.
Confirm New Enable Password	New enable password that you reenter.

Step 5 Do one of the following:

- Click **OK** to save any changes made to GSS server IP address or password to the ANM server.
- Click **Cancel**.

You return to the Primary Attributes Page.

Step 6 Click **Deploy Now** to deploy this configuration save your entries to the gslb-configuration file.

To exit this procedure without deploying your entries, choose another device in the device tree or in the object selector above the configuration pane.

Related Topics

- [Configuring Devices, page 5-34](#)
- [Importing ACE Appliances, page 5-21](#)

Configuring Catalyst 6500 VSS 1440 Primary Attributes

You can configure primary attributes for VSS devices.

Procedure

Step 1 Choose **Config > Devices > All Devices**.

The device tree appears.

Step 2 In the device tree, choose the device you want to configure, then choose **System > Primary Attributes**. The Primary Attributes window appears with information about the chassis.

Most of the information is read directly from the device during the import process and cannot be changed using the ANM interface. For example, a VSS-enabled checkbox will display as a read-only field. You can, however, add a description and configure the device for SNMPv2 or SNMPv3 access.



Note For the ACE devices in VSS, the slot number is represented in the format switch number/slot number.

Step 3 In the Description field, enter a brief description for the device.

Step 4 To enable SNMPv2c access, do the following:

- Check the SNMPv2c Enabled checkbox.
- In the SNMP Trap Community string field, enter the SNMP community string.

Step 5 Click **Deploy Now** to deploy this configuration on the ACE and save your entries to the running-configuration and startup-configuration files. You return to the All Devices table.

Related Topics

- [Displaying Chassis Interfaces and Configuring High-Level Interface Attributes, page 5-42](#)
- [Displaying Modules by Chassis, page 5-79](#)
- [Managing Catalyst 6500 Series Chassis or Cisco 7600 Series Router VLANs, page 5-48](#)

Configuring Catalyst 6500 Series Chassis and Cisco 7600 Series Router Primary Attributes

You can configure primary attributes for Catalyst 6500 series chassis and Cisco 7600 series routers.

Procedure

Step 1 Choose **Config > Devices > All Devices**.

The device tree appears.

Step 2 In the device tree, choose the device that you want to configure, and choose **System > Primary Attributes**.

The Primary Attributes window appears.

Most of the information is read directly from the device during the import process and cannot be changed using the ANM interface. However, you can add a description and configure the device for SNMPv2 or SNMPv3 access.

- Step 3** In the Description field, enter a brief description for the device.
- Step 4** To enable SNMPv2c access, do the following:
- a. Check the SNMPv2c Enabled checkbox.
 - b. In the SNMP Trap Community string field, enter the SNMP community string.
- Step 5** Click **Deploy Now** to deploy this configuration on the ACE and save your entries to the running-configuration and startup-configuration files. You return to the All Devices table.

Related Topics

- [Displaying Chassis Interfaces and Configuring High-Level Interface Attributes, page 5-42](#)
- [Displaying Modules by Chassis, page 5-79](#)
- [Managing Catalyst 6500 Series Chassis or Cisco 7600 Series Router VLANs, page 5-48](#)

Configuring Catalyst 6500 Series Chassis, Catalyst 6500 Virtual Switching System 1440 Devices, and Cisco 7600 Series Routers Static Routes

You can configure static routes for the Catalyst 6500 Series Chassis, Catalyst 6500 Virtual Switching System 1440 Devices, and Cisco 7600 Series Routers. Though interfaces can be shared across contexts, the ACE supports only static routes for virtual contexts. You can configure static routes for Catalyst 6500 series chassis, Catalyst 6500 Virtual Switching System (VSS) 1440 devices, and Cisco 7600 series routers.



Note After a device static route has been created, you can modify only its administrative distance.

Procedure

- Step 1** Choose **Config > Devices > All Devices**.
- The device tree appears.
- Step 2** In the device tree, choose the device that you want to configure, and choose **Network > Static Routes**.
- The Static Routes table appears.
- Step 3** In the Static Routes table, click **Add** to configure a new static route for the device, or choose an existing static route, and click **Edit** to modify it.
- The Static Routes configuration window appears.
- Step 4** In the Destination Prefix field, enter the IP address for the route.
- The address that you specify for the static route is the address that is in the packet before entering the ACE and performing network address translation.
- Step 5** In the Destination Prefix Mask field, choose the subnet for the static route.
- Step 6** In the Next Hop field, enter the IP address of the gateway router for the route.

The gateway address must be on the same network as a VLAN interface for the device.

Step 7 In the Admin Distance field, enter the administrative distance value of the route.

The administrative distance is the first criterion that a router uses to determine which routing protocol to use if two protocols provide route information for the same destination. The administrative distance is a measure of the trustworthiness of the source of the routing information.

A lower administrative distance value indicates that the protocol is more reliable. Valid entries are from 0 to 255, with lower numbers indicating greater reliability. For example, a static route has an administrative distance value of 1 while an unknown protocol has an administrative distance value of 255.

[Table 5-15](#) lists default distance values of the protocols that Cisco supports.

Table 5-15 Cisco Default Distance Value Table

Route Source	Administrative Distance Value
Connected interface	0
Static route	1
Enhanced Interior Gateway Routing Protocol (EIGRP) summary route	5
External Border Gateway Protocol (BGP)	20
Internal EIGRP	90
IGRP	100
OSPF (Open Shortest Path First)	110
Intermediate System-to-Intermediate System (IS-IS)	115
Routing Information Protocol (RIP)	120
Exterior Gateway Protocol (EGP)	140
On-Demand Routing (ODR)	160
External EIGRP	170
Internal BGP	200
Unknown	255

Step 8 Do one of the following:

- Click **Deploy Now** to deploy this configuration on the ACE and save your entries to the running-configuration and startup-configuration files. You return to the Static Route table.
- Click **Cancel** to exit the procedure without saving your entries and to return to the Static Route table.
- Click **Next** to deploy your entries and to add another static route.

Related Topics

- [Managing Catalyst 6500 Series Chassis or Cisco 7600 Series Router VLANs, page 5-48](#)
- [Displaying All Device VLANs, page 5-49](#)
- [Importing Network Devices into ANM, page 5-10](#)

Configuring VMware vCenter Server Primary Attributes

You can configure the primary attributes for a selected VMware vCenter Server.

Procedure

-
- Step 1** Choose **Config > Devices > All Devices**.
The device tree appears.
- Step 2** In the device tree, choose the VMware vCenter Server that you want to configure, and choose **System > Primary Attributes**.
The Primary Attributes window appears.
- Step 3** In the Primary Attributes window, configure the VMware vCenter Server primary attributes as described in [Table 5-16](#).

Table 5-16 VMware vCenter Server Primary Attributes

Item	Description
Description	Brief description for the VMware vCenter Server.
Version	VMware vCenter Server version number.
IP Address	IP address of the VMware vCenter Server.
HTTPS Port	Port number used by the VMware vCenter Server.
ANM vCenter Plug-in Registration Status	Current status of the ANM plug-in: <ul style="list-style-type: none"> • Registered • Not Registered For more information about ANM plug-in registration or to change the plug-in registration status, see the “Registering or Unregistering the ANM Plug-in” section on page B-5 .
ANM IP Address	IP address of the ANM server.

- Step 4** Click **Deploy Now** to deploy this configuration on the VMware vCenter Server and return to the All Devices table.
-

Related Topics

- [Importing VMware vCenter Servers, page 5-24](#)

Configuring Catalyst 6500 Series Chassis or Cisco 7600 Series Router Interfaces

This section shows how to configure the interface attributes for the Catalyst 6500 series chassis or Cisco 7600 series router.

This section includes the following topics:

- [Displaying Chassis Interfaces and Configuring High-Level Interface Attributes, page 5-42](#)
- [Configuring Access Ports, page 5-43](#)

- [Configuring Trunk Ports, page 5-44](#)
- [Configuring Switch Virtual Interfaces, page 5-45](#)
- [Configuring Routed Ports, page 5-46](#)

Displaying Chassis Interfaces and Configuring High-Level Interface Attributes

You can display a complete list of interfaces on a selected Catalyst 6500 series chassis or Cisco 7600 series router. From this display, you can configure the following high-level attributes for a specified interface: interface description, operating mode, and administrative state.

Procedure

-
- Step 1** Choose **Config > Devices > All Devices**.
- The device tree appears.
- Step 2** In the device tree, choose the device, and choose **Interfaces > Summary**.
- The Interfaces table appears, listing all interfaces on the device and related information as follows:
- Interface name
 - Description, if available
 - Configured state, such as Up or Down
 - Current operational state, if known
 - Mode of operation, such as Access, Routed, or Trunk
 - Interface hardware type
- Step 3** Choose the interface to configure, and click **Edit**.
- The configuration window appears.
- Step 4** Enter the following:
- a. In the Description field, enter a brief description of the interface.
 - b. In the Administrative State field, choose **Up** or **Down** to indicate whether the port should be up or down.
 - c. In the Mode field, choose the operational mode of the interface: **Trunk**, **Access**, or **Routed**.
 - d. Click **Apply** to save your changes or **Cancel** to exit the procedure without saving your changes.
- The Interfaces table appears.
-

Related Topics

- [Configuring Access Ports, page 5-43](#)
- [Configuring Trunk Ports, page 5-44](#)
- [Configuring Routed Ports, page 5-46](#)
- [Configuring Switch Virtual Interfaces, page 5-45](#)
- [Creating VLAN Groups, page 5-52](#)
- [Managing Catalyst 6500 Series Chassis or Cisco 7600 Series Router VLANs, page 5-48](#)

Configuring Access Ports

You can configure access port attributes for a selected device. An access port receives and sends traffic in native formats with no VLAN tagging. Traffic that arrives on an access port is assumed to belong to the VLAN assigned to the port. If an access port receives a tagged packet (Inter-Switch Link [ISL] or 802.1Q tagged), the packet is dropped, and the source address is not learned.

Procedure

- Step 1** Choose **Config > Devices > All Devices**.
- The device tree appears.
- Step 2** In the device tree, choose the device that you want to configure an access port for, and choose **Interfaces > Access Ports**.
- The Interfaces table appears.
- Step 3** From the Interfaces table, choose the port that you want to configure, and click **Edit**.
- The Access Ports configuration window appears.
- Step 4** In the Description field, enter a description for the port.
- Valid entries are unquoted text strings with a maximum of 240 characters including spaces.
- Step 5** In the Administrative State field, choose **Up** or **Down** to indicate whether the port should be up or down.
- Step 6** In the Speed field, either specify the speed at which the interface is to operate or that the interface is to automatically negotiate its speed:
- **Auto**—The interface is to automatically negotiate speed with the connected device.
 - **10 Mbps**—The interface is to operate at 10 Mbps.
 - **100 Mbps**—The interface is to operate at 100 Mbps.
 - **1000 Mbps**—The interface is to operate at 1000 Mbps.
- Step 7** In the Duplex Mode field, specify whether the interface is to automatically negotiate its duplex mode or use full- or half-duplex mode:
- **Auto**—The interface is to automatically negotiate duplex mode with the connected device.
 - **Full**—The interface is to operate in full-duplex mode. In this mode, two connected devices can send and receive traffic at the same time.
 - **Half**—The interface is to operate in half-duplex mode. In this mode, two connected devices can either send or receive traffic.
- Step 8** In the VLANs field, enter individual names for each VLAN to which the interface belongs.
- The allowable range is 1 to 4094.
- Step 9** Do one of the following:
- Click **Apply** to save your entries and to return to the Interfaces table.
 - Click **Cancel** to exit the procedure without saving your entries and to return to the Interfaces table.
-

Related Topics

- [Configuring Trunk Ports, page 5-44](#)
- [Configuring Switch Virtual Interfaces, page 5-45](#)

- [Configuring Routed Ports](#), page 5-46
- [Managing Catalyst 6500 Series Chassis or Cisco 7600 Series Router VLANs](#), page 5-48

Configuring Trunk Ports

You can configure trunk ports for a selected device. A trunk port carries the traffic of multiple VLANs and by default is a member of all VLANs in the VLAN database. Two types of trunk ports are as follows:

- In an Inter-Switch Link (ISL) trunk port, all received packets are expected to be encapsulated with an ISL header, and all transmitted packets are sent with an ISL header. Native (nontagged) frames received from an ISL trunk port are dropped.
- An IEEE 802.1Q trunk port supports simultaneous tagged and untagged traffic. An 802.1Q trunk port is assigned a default port VLAN ID or *native VLAN*, and all untagged traffic travels on the native VLAN. All untagged traffic and tagged traffic with a NULL VLAN ID are assumed to belong to the native VLAN. A packet with a VLAN ID that is equal to the outgoing port native VLAN is sent untagged. All other traffic is sent with a VLAN tag.

Procedure

-
- Step 1** Choose **Config > Devices > All Devices**.
The device tree appears.
- Step 2** In the device tree, choose the device that you want to configure, and choose **Interfaces > Trunk Ports**.
The Interfaces table appears.
- Step 3** In the Interfaces table, choose the port that you want to configure, and click **Edit**.
The Trunk Port configuration window appears.
- Step 4** Configure the port using the information in [Table 5-17](#).

Table 5-17 Trunk Port Configuration Attributes

Field	Description
Description	Description for the port. Valid entries are unquoted text strings with a maximum of 240 characters including spaces.
Administrative State	Up or Down to indicate whether the port should be up or down.
Speed	Speed at which the interface is to operate or that the interface is to automatically negotiate its speed: <ul style="list-style-type: none"> • Auto—The interface is to automatically negotiate speed with the connected device. • 10 Mbps—The interface is to operate at 10 Mbps. • 100 Mbps—The interface is to operate at 100 Mbps. • 1000 Mbps—The interface is to operate at 1000 Mbps.
Duplex Mode	Whether the interface is to automatically negotiate its duplex mode or use full-duplex or half-duplex mode: <ul style="list-style-type: none"> • Auto—The interface is to automatically negotiate duplex mode with the connected device. • Full—The interface is to operate in full-duplex mode. In this mode, two connected devices can send and receive traffic at the same time. • Half—The interface is to operate in half-duplex mode. In this mode, two connected devices can either send or receive traffic.

Table 5-17 Trunk Port Configuration Attributes (continued)

Field	Description
Trunk Mode	How the interface is to interact with neighboring interfaces: <ul style="list-style-type: none"> • Dynamic—The interface is to convert a link to a trunk link if the neighboring interface is set to trunk or desirable mode. • Dynamic Desirable—The interface is to actively attempt to convert a link to a trunk link. The interface becomes a trunk interface if the neighboring interface is set to trunk, desirable, or auto mode. • Static—The interface is to enter permanent trunking mode and to negotiate converting a link into a trunk link. The interface becomes a trunk interface even if the neighboring interface does not change.
Desired Encapsulation	Type of encapsulation to be used on the trunk port: <ul style="list-style-type: none"> • Dot1Q—The interface is to use 802.1Q encapsulation. • Negotiate—The interface is to negotiate with the neighboring interface to use ISL (Inter-Switch Link) (preferred) or 802.1Q encapsulation, depending on the configuration and capabilities of the neighboring interface. • ISL—The interface is to use ISL encapsulation.
Native VLAN	VLAN to use as the native VLAN for the trunk in 802.1Q trunking mode. VLAN 1 (1) is the default native VLAN.
VLANs	VLANs to which the interface belongs (allowable range is 1-4094). You can also enter ranges of VLANs, such as 101-120, 130.
Prune VLANs	VLANs that can be pruned (allowable range is 1-4094). VTP pruning blocks unneeded flooded traffic to VLANs on trunk ports that are included in this field. Only VLANs included in this field can be pruned. You can also specify ranges of VLANs that can be pruned, such as 75, 121-250, 351.

Step 5 Do one of the following:

- Click **Apply** to save your entries and to return to the Interfaces table.
- Click **Cancel** to exit the procedure without saving your entries and to return to the Interfaces table.

Related Topics

- [Configuring Access Ports, page 5-43](#)
- [Configuring Switch Virtual Interfaces, page 5-45](#)
- [Configuring Routed Ports, page 5-46](#)
- [Managing Catalyst 6500 Series Chassis or Cisco 7600 Series Router VLANs, page 5-48](#)

Configuring Switch Virtual Interfaces

You can configure a switch virtual interface on a Multilayer Switch Feature Card. A VLAN defined on the Multilayer Switch Feature Card (MSFC) is called a switch virtual interface (SVI). If you assign the VLAN used for the SVI to an ACE, then the MSFC routes between the ACE and other Layer 3 VLANs. By default, only one SVI can exist between an MSFC and an ACE. However, for multiple contexts, you might need to configure multiple SVIs for unique VLANs on each context.

Procedure

-
- Step 1** Choose **Config > Devices > All Devices**.
- The device tree appears.
- Step 2** In the device tree, choose the device that you want to configure, and choose **Interfaces > Switched Virtual Interfaces**.
- The Interfaces table appears.
- Step 3** In the Interfaces table, click **Add** to add a new SVI, or choose the interface you want to configure, and click **Edit**.
- The Switched Virtual Interfaces configuration window appears.
- Step 4** In the VLANs field, specify the VLAN to use in one of the following ways:
- To specify a new VLAN, choose the first radio button, and then enter a new VLAN.
 - To choose an existing VLAN, choose the second radio button, and choose one of the existing VLANs.
-  **Note** You cannot modify a VLAN for an existing SVI.
-
- Step 5** In the Description field, enter a description for the SVI. Valid entries are unquoted text strings with a maximum of 240 characters including spaces.
- Step 6** In the Administrative State field, choose **Up** or **Down** to indicate whether the SVI should be up or down.
- Step 7** In the IP Address field, enter the IP address to be used for the interface on the MSFC in dotted-decimal format.
- Step 8** In the Netmask field, choose the subnet mask to be used for the IP address.
- Step 9** Do one of the following:
- Click **Apply** to save your entries and to return to the Interfaces table.
 - Click **Cancel** to exit the procedure without saving your entries and to return to the Interfaces table.
-

Related Topics

- [Configuring Access Ports, page 5-43](#)
- [Configuring Trunk Ports, page 5-44](#)
- [Configuring Routed Ports, page 5-46](#)
- [Managing Catalyst 6500 Series Chassis or Cisco 7600 Series Router VLANs, page 5-48](#)

Configuring Routed Ports

You can configure routed ports on a specified device. A routed port is a physical port that acts like a port on a router; however, it does not have to be connected to a router. A routed port is not associated with a particular VLAN, as is an access port. A routed port behaves like a regular router interface, except that it does not support VLAN subinterfaces. Routed ports can be configured with a Layer 3 routing protocol. A routed port is a Layer 3 interface only and does not support Layer 2 protocols, such as Dynamic Trunking Protocol (DTP) and Spanning Tree Protocol (STP).

Procedure

- Step 1** Choose **Config > Devices > All Devices**.
The device tree appears.
- Step 2** In the device tree, choose the device that you want to configure, and choose **Interfaces > Routed Ports**.
The Interfaces table appears.
- Step 3** In the Interfaces table, choose the interface that you want to configure, and click **Edit**.
The Routed Ports configuration window appears.
- Step 4** In the Description field, enter a description for the interface. Valid entries are unquoted text strings with a maximum of 240 characters including spaces.
- Step 5** In the Administrative State field, choose **Up** or **Down** to indicate whether the interface should be up or down.
- Step 6** In the Speed field, either specify the speed at which the interface is to operate or that the interface is to automatically negotiate its speed:
- **Auto**—The interface is to automatically negotiate speed with the connected device.
 - **10 Mbps**—The interface is to operate at 10 Mbps.
 - **100 Mbps**—The interface is to operate at 100 Mbps.
 - **1000 Mbps**—The interface is to operate at 1000 Mbps.
- Step 7** In the Duplex Mode field, specify whether the interface is to automatically negotiate its duplex mode, or use full- or half-duplex mode:
- **Auto**—The interface is to automatically negotiate duplex mode with the connected device.
 - **Full**—The interface is to operate in full-duplex mode. In this mode, two connected devices can send and receive traffic at the same time.
 - **Half**—The interface is to operate in half-duplex mode. In this mode, two connected devices can either send or receive traffic.
- Step 8** In the IP Address field, enter the IP address to be used for the interface in dotted-decimal format.
- Step 9** In the Netmask field, choose the subnet mask to be used for the IP address.
- Step 10** Do one of the following:
- Click **Apply** to apply your entries and to return to the Interfaces table.
 - Click **Cancel** to exit the procedure without saving your entries and to return to the Interfaces table.
-

Related Topics

- [Configuring Trunk Ports, page 5-44](#)
- [Configuring Switch Virtual Interfaces, page 5-45](#)
- [Configuring Access Ports, page 5-43](#)
- [Managing Catalyst 6500 Series Chassis or Cisco 7600 Series Router VLANs, page 5-48](#)

Managing Catalyst 6500 Series Chassis or Cisco 7600 Series Router VLANs

You can add a VLANs and VLAN groups to a Catalyst 6500 series chassis or Cisco 7600 series router that you use when configuring the interfaces for an installed ACE module, which does not have any external physical interfaces. Instead, the ACE module uses internal VLAN interfaces. For information about configuring VLANs for use with virtual contexts, see the [“Configuring Virtual Context VLAN Interfaces” section on page 12-6](#). For more information about VLANs and their use with ACE modules, see the *Cisco Application Control Engine Module Routing and Bridging Configuration Guide*.

This section includes the following topics:

- [Adding Device VLANs, page 5-48](#)
- [Displaying All Device VLANs, page 5-49](#)
- [Configuring Device Layer 3 VLANs, page 5-51](#)
- [Configuring Device Layer 2 VLANs, page 5-50](#)
- [Displaying All Device VLANs, page 5-49](#)
- [Creating VLAN Groups, page 5-52](#)

Adding Device VLANs

You can add a VLAN to a Catalyst 6500 series chassis or Cisco 7600 series router.

Procedure

-
- Step 1** Choose **Config > Devices > All Devices**.
- The device tree appears.
- Step 2** In the device tree, choose the device that you want to configure, and choose **VLANs > Layer 2** or **VLANs > Layer 3**.
- The VLANs table appears.
- Step 3** From the VLANs table, click **Add**.
- The VLAN configuration window appears.
- Step 4** Configure the VLAN using the information in [Table 5-18](#).

Table 5-18 Device VLAN Configuration Attributes

Field	Description
VLAN	Unique identifier for the VLAN. Valid entries are from 1 to 4094.
Name	Name for the VLAN.
Description	Description for the VLAN. Valid entries are unquoted text strings with a maximum of 240 characters including spaces.
Access Ports	Access ports. From the Available Items list, click Add . To remove a port that you do not want to use, choose the port from the Selected Items list, and click Remove .
Trunk Ports	Trunk ports. From the Available Items list, click Add . To remove a port that you do not want to use, choose the port from the Selected Items list, and click Remove .

Table 5-18 Device VLAN Configuration Attributes (continued)

Field	Description
VTP Domain	Name of the VTP domain to which the VLAN belongs. A VTP domain is made up of one or more interconnected network devices that share the same VTP domain name. A network device can be configured to be in one and only one VTP domain.
IP Address	Field that appears for Layer 3 VLANs only. Enter the IP address to be used for the VLAN interface. Enter the IP address in dotted-decimal notation, such as 192.168.1.1.
Mask	Field that appears for Layer 3 VLANs only. Choose the subnet mask to apply to the IP address.

- Step 5** Do one of the following:
- Click **Apply** to apply your entries and to return to the VLAN Management table.
 - Click **Cancel** to exit the procedure without saving your entries and to return to the VLAN Management table.

Related Topics

- [Managing Catalyst 6500 Series Chassis or Cisco 7600 Series Router VLANs, page 5-48](#)
- [Configuring Device Layer 2 VLANs, page 5-50](#)
- [Configuring Device Layer 3 VLANs, page 5-51](#)
- [Displaying All Device VLANs, page 5-49](#)
- [Creating VLAN Groups, page 5-52](#)

Displaying All Device VLANs

You can display all configured VLANs on a Catalyst 6500 series chassis or Cisco 7600 series router.

Procedure

- Step 1** Choose **Config > Devices > All Devices**.
The device tree appears.
- Step 2** In the device tree, choose the device with VLANs that you want to display, and choose **VLANs > Summary**.
The VLANs table appears, listing all VLANs on the selected chassis and related information:
- VLAN number
 - Name given to the VLAN
 - VLAN type, such as Layer 2 or Layer 3
 - Number of access ports
 - Number of trunk ports

- VLAN Trunking Protocol (VTP) domain to which the VLAN belongs
-

Related Topics

- [Managing Catalyst 6500 Series Chassis or Cisco 7600 Series Router VLANs, page 5-48](#)
- [Configuring Device Layer 2 VLANs, page 5-50](#)
- [Configuring Device Layer 3 VLANs, page 5-51](#)
- [Displaying All Device VLANs, page 5-49](#)
- [Creating VLAN Groups, page 5-52](#)

Configuring Device Layer 2 VLANs

You can add or modify a Layer 2 VLAN on a Catalyst 6500 series chassis or Cisco 7600 series router.

Procedure

-
- Step 1** Choose **Config > Devices > All Devices**.
- The device tree appears.
- Step 2** In the device tree, choose the device that you want to configure a Layer 2 VLAN for, and choose **VLANs > Layer 2**.
- The VLANs table appears, listing all Layer 2 VLANs associated with the chassis.
- Step 3** Click **Add** to add a new VLAN, or choose an existing VLAN, and then click **Edit** to modify it.
- The VLAN configuration window appears.
- Step 4** Configure the VLAN using the information in [Table 5-18](#).
- Step 5** Do one of the following:
- Click **Apply** to apply your entries and to return to the VLAN Management table.
 - Click **Cancel** to exit the procedure without saving your entries and to return to the VLAN Management table.
-

Related Topics

- [Managing Catalyst 6500 Series Chassis or Cisco 7600 Series Router VLANs, page 5-48](#)
- [Adding Device VLANs, page 5-48](#)
- [Configuring Device Layer 3 VLANs, page 5-51](#)
- [Displaying All Device VLANs, page 5-49](#)
- [Creating VLAN Groups, page 5-52](#)

Configuring Device Layer 3 VLANs

You can add or modify a Layer 3 VLAN on a Catalyst 6500 series chassis or Cisco 7600 series router.

Procedure

- Step 1** Choose **Config > Devices > All Devices**.
The device tree appears.
- Step 2** In the device tree, choose the device that you want to configure a Layer 3 VLAN for, and choose **VLANs > Layer 3**.
The VLANs table appears, listing all Layer 3 VLANs associated with the chassis.
- Step 3** In the VLANs table, click **Add** to add a new VLAN, or choose an existing VLAN, and click **Edit** to modify it.
The VLAN configuration window appears.
- Step 4** Configure the VLAN using the information in [Table 5-18](#).
- Step 5** Do one of the following:
- Click **Apply** to apply your entries and to return to the VLAN Management table.
 - Click **Cancel** to exit the procedure without saving your entries and to return to the VLAN Management table.
-

Related Topics

- [Managing Catalyst 6500 Series Chassis or Cisco 7600 Series Router VLANs, page 5-48](#)
- [Information About Virtual Contexts, page 6-2](#)

Modifying Device VLANs

You can modify VLANs for a specific device.

Procedure

- Step 1** Choose **Config > Devices > All Devices**.
The device tree appears.
- Step 2** In the device tree, choose the device with the VLAN that you want to modify, and choose **VLANs > Layer 2** or **VLANs > Layer 3**.
The VLANs table appears.
- Step 3** Choose the VLAN you want to modify, and then click **Edit**.
The VLAN configuration window appears.
- Step 4** Modify the VLAN configuration using the information in [Table 5-18](#).
- Step 5** Do one of the following:
- Click **Apply** to save your entries and to return to the VLANs table.

- Click **Cancel** to exit the procedure without saving your entries and to return to the VLANs table.
-

Related Topics

- [Managing Catalyst 6500 Series Chassis or Cisco 7600 Series Router VLANs, page 5-48](#)
- [Displaying All Device VLANs, page 5-49](#)
- [Adding Device VLANs, page 5-48](#)
- [Creating VLAN Groups, page 5-52](#)

Creating VLAN Groups

You can create VLAN groups on a Catalyst 6500 series chassis or Cisco 7600 series router and assign each group an ACE module. For an ACE module to receive traffic from the Catalyst supervisor module and VSS devices, you must create VLAN groups on the supervisor module, and then assign the groups to the ACE module. When the VLANs are configured on the supervisor module to the ACE module, you can configure the VLANs on the ACE module.

You cannot assign the same VLAN to multiple groups; however, you can assign multiple groups to an ACE module. VLANs that you want to assign to multiple ACE modules, for example, can reside in a separate group from VLANs that are unique to each ACE module.

Procedure

- Step 1** Choose **Config > Devices > All Devices**.
- The device tree appears.
- Step 2** In the device tree, choose the device that you want to create a VLAN group for, and choose **VLANs > Groups**.
- The Groups table appears.
- Step 3** Click **Add** to add a new VLAN group, or choose an existing VLAN group, and click **Edit** to modify it.
- The Groups configuration window appears.
- Step 4** In the VLAN Group Id field, enter a unique numerical identifier for the VLAN group.
- Valid entries are unquoted number strings with any value between 1-65535. Available Module Slot numbers will appear underneath this field.
- Step 5** In the Module Slot Numbers field, select the ACE module(s) that you want to associate with the VLAN group.
- Step 6** Double click or the number, or single click the arrow to the right of the Available Modules field for the slot numbers to the Selected field.
- Step 7** In the VLANs field, enter the VLANs to be included in the VLAN group. Valid entries are individual names for each VLAN or ranges of VLANs (allowable range is 1-4094), such as 10, 50-110.
- Step 8** Do one of the following:
- Click **Deploy Now** to deploy this configuration on the ACE and save your entries to the running-configuration and startup-configuration files. You return to the Groups table.
 - Click **Cancel** to exit the procedure without saving your entries and to return to the Groups table.

- Click **Next** to deploy your entries and to add another VLAN group.
-

Related Topics

- [Managing Catalyst 6500 Series Chassis or Cisco 7600 Series Router VLANs, page 5-48](#)
- [Configuring Device Layer 3 VLANs, page 5-51](#)
- [Configuring Device Layer 2 VLANs, page 5-50](#)
- [Displaying All Device VLANs, page 5-49](#)

Configuring ACE Module and Appliance Role-Based Access Controls

ANM provides an interface to allow you to configure device Role-Based Access Control (RBAC) on the device only. The RBAC feature applies to ACE modules and appliances only and is applicable only on the device and is not enforced by ANM. If you want to set up authorization in ANM, go to **Admin > Role-Based Access Control**.

This section includes the following topics:

- [Configuring Device RBAC Users, page 5-53](#)
- [Configuring Device RBAC Roles, page 5-56](#)
- [Configuring Device RBAC Domains, page 5-61](#)

Configuring Device RBAC Users

ANM provides an interface that allows you to configure user access to your device through role-based access controls on the device only. This configuration is applicable only on the device and will not be enforced by ANM.

Use the Role-Based Access Control feature to specify the people that are allowed to log onto a device.

This section includes the following topics:

- [Guidelines for Managing Users, page 5-53](#)
- [Displaying a List of Device Users, page 5-54](#)
- [Configuring Device User Accounts, page 5-54](#)
- [Modifying Device User Accounts, page 5-55](#)
- [Deleting Device User Accounts, page 5-56](#)

Guidelines for Managing Users

Follow these guidelines for managing users:

- For users that you create in the Admin context, the default scope of access is for the entire ACE.
- If you do not assign a role to a new user, the default user role is Network-Monitor. For users that you create in other contexts, the default scope of access is the entire context.
- Users cannot log in until they are associated with a domain and a user role.

- You cannot delete roles and domains that are associated with an existing user.

Related Topics

- [Configuring Device RBAC Users, page 5-53](#)
- [Configuring ACE Module and Appliance Role-Based Access Controls, page 5-53](#)

Displaying a List of Device Users

You can display of list of users that can access an ACE context.

Procedure

Step 1 Choose **Config > Devices > context > Role-Based Access Control > Users**.

The Users table appears with the following fields:

- User Name
- Expiry Date
- Role
- Domains

Step 2 (Optional) You can use the options in this window to create a new user or modify or delete any existing user to which you have access (see [Table 5-19](#)).

Related Topics

- [Configuring Device RBAC Users, page 5-53](#)
- [Configuring ACE Module and Appliance Role-Based Access Controls, page 5-53](#)

Configuring Device User Accounts

You can add or modify a user account in a selected ACE context.



Note

This configuration is applicable only on the device or building block and is not enforced by ANM. To manipulate ANM RBAC, go to Admin > Role-Based Access Control.

Procedure

Step 1 Choose the item to configure:

- To configure a virtual context, choose **Config > Devices > context > Device RBAC > Users**.
- To configure a configuration building block, choose **Config > Global > Building Blocks > building_block > Role-Based Access Control > Users**.

A list of users appears.

Step 2 In the Users table, click **Add** to add a new user, or choose the user that you want to configure and click **Edit**.

The Users configuration window appears.

Step 3 Configure the user attributes using the information in [Table 5-19](#).

Table 5-19 *User Attributes*

Field	Description
User Name	Name by which the user is to be identified (up to 24 characters). Only letters, numbers, and an underscore can be used. The field is case sensitive.
Expiry Date	Date that user account expires (optional).
Password Entered As	Password for this user account. You can choose Clear Text or Encrypted Text.
Password	Password for the user account.
Confirm Password	Password for this account that you reenter.
Encryption	Password in either clear or encrypted text.
Role	Role that you customize or accept as an existing role. To enter the Role for this user, see the “Configuring Device User Roles” section on page 5-58. See Table 5-20 for details about setting up new roles.
Domains	Domains to which this user belongs. Use the Add and Remove buttons.

Step 4 Click **Deploy Now** to deploy this configuration on the ACE and save your entries to the running-configuration and startup-configuration files.

The Users table appears.

Related Topics

- [Configuring Device RBAC Users, page 5-53](#)
- [Configuring ACE Module and Appliance Role-Based Access Controls, page 5-53](#)

Modifying Device User Accounts

You can modify an existing user account in a selected ACE context.



Note

This configuration is applicable only on the device or building block and will not be enforced by ANM. To manipulate ANM RBAC, go to Admin > Role-Based Access Control.

Procedure

Step 1 Choose the item to configure:

- To configure a virtual context, choose **Config > Devices > context > Device RBAC > Users**.
- To configure a configuration building block, choose **Config > Global > Building Blocks > building_block > Role-Based Access Control > Users**.

A table of users, expiration dates, roles, and domains appears.

Step 2 Choose the user account that you want to modify.

Step 3 Click **Edit**.

Step 4 Modify any of the attributes in the table (see [Table 5-19](#)).

- Step 5** Click **Deploy Now** to deploy this configuration on the ACE and save your entries to the running-configuration and startup-configuration files.

The Users table appears.

Related Topics

- [Configuring Device RBAC Users, page 5-53](#)
- [Configuring ACE Module and Appliance Role-Based Access Controls, page 5-53](#)

Deleting Device User Accounts

You can delete an existing device RBAC user account in a selected ACE context.



Note

This configuration is applicable only on the device or building block and will not be enforced by ANM. To manipulate ANM RBAC, go to Admin > Role-Based Access Control.

Procedure

- Step 1** Choose the item to configure:
- To configure a virtual context, choose **Config > Devices > context > Device RBAC > Users**.
 - To configure a configuration building block, choose **Config > Global > Building Blocks > building_block > Role-Based Access Control > Users**.
- A table of users, roles, and domains appears.
- Step 2** In the table, choose the user account to delete, and click **Delete**.
- A confirmation window appears.
- Step 3** In the confirmation window, do one of the following:
- Click **OK** to remove the user account from the ANM database and return to the Users table.
 - Click **Cancel** to return to the Users table without deleting the user account.
-

Related Topics

- [Configuring Device RBAC Users, page 5-53](#)
- [Configuring ACE Module and Appliance Role-Based Access Controls, page 5-53](#)

Configuring Device RBAC Roles

This section shows how to configure RBAC roles and includes the following topics:

- [Guidelines for Managing User Roles, page 5-57](#)
- [Role Mapping in Device RBAC, page 5-57](#)
- [Configuring Device User Roles, page 5-58](#)
- [Modifying Device User Roles, page 5-60](#)

- [Deleting Device User Roles, page 5-60](#)

Guidelines for Managing User Roles

Follow these guidelines to manage user roles:

- Administrators can view and modify all roles.
- Other users can view only the roles assigned to them.
- You cannot change the default roles.
- Role permissions are different based on whether they were created in either an Admin context or in a user context. If you want to allow users to switch between contexts, ensure that they have a predefined role. If you want to restrict a user to only their home context, assign them a customized user role.
- Certain role features are available only to default roles, for example, an Admin role in the Admin context would have **changeto** and **system** permissions to perform tasks such as license management, resource class management, HA setup, and so on. User-created roles cannot use these features.

Related Topics

- [Role Mapping in Device RBAC, page 5-57](#)
- [Controlling Access to Cisco ANM, page 18-3](#)
- [Configuring Device RBAC Users, page 5-53](#)
- [Configuring Device RBAC Roles, page 5-56](#)
- [Configuring Device RBAC Domains, page 5-61](#)
- [How ANM Handles Role-Based Access Control, page 18-8](#)

Role Mapping in Device RBAC

When you are logged into a specific device RBAC, you see the tasks that you have been given permission to access. Features and menus that are not applicable for your role will not display.

Since the predefined roles encompass all the role types you may need, we encourage you to use them. If you choose to define your own roles, be aware that rules features are not a one-to-one mapping from a CLI feature to ANM menu task.

Defining the proper rules for your user-defined role will require you to create a mapping between the features in Device RBAC and the ANM menu tasks. For example, in order to manage virtual servers, you must choose the following six menu features (Real Servers, Server Farms, VIP, Probes, Loadbalance, NAT, and Interface) in your role.



Note

Certain features in ANM do not have a corresponding feature mapping on the CLI. For example, class maps and SNMP do not have a corresponding feature mapping. To modify these features, you need to choose a predefined role that contains at least one feature with the Modify permission on it.

Related Topics

- [How ANM Handles Role-Based Access Control, page 18-8](#)
- [Understanding Roles, page 18-6](#)

Configuring Device User Roles

You can edit the predefined roles, or you can create or edit user-defined roles. When you create a new role, you specify a name and description of the new role, and then choose the operations privileges for each task. You can also assign this role to one or more users.



Note

This configuration is applicable only on the device or building block and will not be enforced by the ANM. To manipulate the ANM RBAC, go to Admin > Role-Based Access Control.

Procedure

Step 1 Choose the item to configure:

- To configure a virtual context, choose **Config > Devices > context > Device RBAC > Roles**.
- To configure a configuration building block, choose **Config > Global > Building Blocks > building_block > Role-Based Access Control > Roles**.

A table of the defined roles and their settings appears.

Step 2 In the table, choose the type of configuration that you want to perform as follows:

- To add a new role, click **Add**, enter the attributes described in [Table 5-20](#), and then click **Deploy Now** to deploy this configuration on the ACE and save your entries to the running-configuration and startup-configuration files.

Table 5-20 **Role Attributes**

Attribute	Description
Name	Name of the role.
Description	Brief description of the role.

- To edit an existing role, choose the role, and click **Edit**.
The Roles configuration window appears.

Step 3 Click **Edit**.

The Rule table appears.

Step 4 In the Rule table, click **Add** to create rules for this role, or choose the rule that you want to configure, and click **Edit**.

See [Table 5-21](#) for rule attribute descriptions.

Table 5-21 Rule Attributes

Attribute	Description
Rule Number	Number assigned to this rule.
Permission	Permit or deny the specified operation.
Operation	Create, debug, modify ¹ , and monitor the specified feature.
Feature	<p>AAA, Access List, Change To Context, Config Copy, Connection, DHCP, Exec-Commands, Fault Tolerant, Inspect, Interface, Load Balance, NAT, PKI, Probe, Real Inservice, Routing, Real Server, Server Farm, SSL², Sticky, Syslog, and VIP.</p> <p>The Changeto feature allows you to move from the Admin context to another virtual context and maintain the same role with the same privileges in the new context that you had in the Admin context. This feature applies only to the Admin context and to the following ACE software versions:</p> <ul style="list-style-type: none"> • ACE module software Version A2(1.3) and later releases. • ACE appliance software Version A3(2.2) and later releases. <p>The Exec-commands feature enables all default custom role commands in the ACE. The default custom role commands are capture, debug, gunzip, mkdir, move, rmdir, tac-pac, untar, write, and undebg. This feature applies to both Admin and user contexts and to the following ACE software versions:</p> <ul style="list-style-type: none"> • ACE module software Version A2(1.3) and later releases. • ACE appliance software Version A3(2.2) and later releases.

1. Certain features are not available for certain operations. For modify, the following features cannot be used: Changeto, config-copy, DHCP, Exec-commands, NAT, real-inservice, routing, and syslog.
2. For all SSL-related operations, a user with a custom role should include the following two rules: A rule that includes the SSL feature, and a rule that includes the PKI feature.

Step 5 Click **Deploy Now** to update the rule for this role or click **Next** to deploy this rule and move to another rule.

Step 6 Click **Deploy Now** to update this role and save this configuration to the running-configuration and startup-configuration files.

Related Topics

- [Configuring Device RBAC Roles, page 5-56](#)
- [Configuring ACE Module and Appliance Role-Based Access Controls, page 5-53](#)

Modifying Device User Roles

You can modify any user-defined role.



Note

This configuration is applicable only on the device or building block and will not be enforced by ANM. To manipulate ANM RBAC, go to Admin > Role-Based Access Control.

Procedure

-
- Step 1** Choose the item to configure:
- To configure a virtual context, choose **Config > Devices > context > Device RBAC > Roles**.
 - To configure a configuration building block, choose **Config > Global > Building Blocks > building_block > Role-Based Access Control > Roles**.
- A table of the defined roles and their settings appears.
- Step 2** In the table, choose the role that you want to modify.
- Step 3** Click **Edit**. For details on updating role rules, see [Table 5-21](#).
- Step 4** Make the changes.
- For details on updating role rules, see the “[Adding, Editing, or Deleting Rules](#)” section on page 5-61.
- Step 5** Click **Deploy Now** to update the rules for this role and save this configuration to the running-configuration and startup-configuration files.
-

Related Topics

- [Configuring Device RBAC Roles, page 5-56](#)
- [Configuring ACE Module and Appliance Role-Based Access Controls, page 5-53](#)

Deleting Device User Roles

You can delete any user-defined roles.



Note

This configuration is applicable only on the device or building block and will not be enforced by ANM. To manipulate ANM RBAC, go to Admin > Role-Based Access Control.

Procedure

-
- Step 1** Choose the item to configure:
- To configure a virtual context, choose **Config > Devices > context > Device RBAC > Roles**.
 - To configure a configuration building block, choose **Config > Global > Building Blocks > building_block > Role-Based Access Control > Roles**.
- The Roles table appears.
- Step 2** In the Roles table, choose the role to delete, and click **Delete**.

- Step 3** Click **OK** to confirm the deletion.
- Users that have the deleted role no longer have that access.
-

Related Topics

- [Configuring Device RBAC Roles, page 5-56](#)
- [Configuring ACE Module and Appliance Role-Based Access Controls, page 5-53](#)

Adding, Editing, or Deleting Rules

You can change or delete rules to redefine what feature access a specific role contains.

**Note**

This configuration is applicable only on the device or building block and will not be enforced by ANM. To manipulate ANM RBAC, go to Admin > Role-Based Access Control.

Procedure

-
- Step 1** After selecting the user-defined role, click **Edit**.
- The Rule window appears.
- Step 2** Do one of the following:
- To create a new rule, click **Add**. Enter the rule information (see [Table 5-21 on page 5-59](#)), and then click **Deploy Now** to add the rule or **Next** to deploy this rule and add another rule.
 - To change an existing rule, choose a rule and click **Edit**. Click **Deploy Now** to save this rule to the running-configuration and startup-configuration files.
 - To remove rules from a role, choose the rules to remove, and click **Delete**. Click **OK** to confirm its deletion.
- Step 3** Click **Deploy Now** to deploy this configuration on the ACE and save your entries to the running-configuration and startup-configuration files.
-

Related Topics

- [Configuring Device RBAC Roles, page 5-56](#)
- [Configuring ACE Module and Appliance Role-Based Access Controls, page 5-53](#)

Configuring Device RBAC Domains

You can configure device RBAC domains.

This section includes the following topics:

- [Guidelines for Managing Domains, page 5-62](#)
- [Displaying Domains for a Device, page 5-62](#)
- [Configuring Device Domains, page 5-63](#)
- [Modifying Device Domains, page 5-65](#)

- [Deleting Device Domains, page 5-65](#)

Related Topics

- [Information About Device Management, page 5-2](#)
- [How ANM Handles Role-Based Access Control, page 18-8](#)
- [Configuring ACE Module and Appliance Role-Based Access Controls, page 5-53](#)

Guidelines for Managing Domains

Follow these guidelines for managing domains:

- Devices and their components must already be configured in order for them to be added to a domain.
- Domains are *logical* concepts. You do not delete a member of a domain when you delete the domain.
- The predefined default domain cannot be modified or deleted.
- Normally, a user is associated with the default domain, which allows the user to see all configurations within the context. When a user is configured with a customized domain, then the user can see only what is in the domain.

Related Topics

- [Configuring Device RBAC Domains, page 5-61](#)
- [Configuring ACE Module and Appliance Role-Based Access Controls, page 5-53](#)

Displaying Domains for a Device

You can display domains for a device.



Note

Your user role determines whether you can use this option.

Procedure

- Step 1** Choose the item to view:
- To view a domain for the device's virtual context, choose **Config > Devices > context > Device RBAC > Domains**.
 - To view a domain for a configuration building block, choose **Config > Global > Building Blocks > building block > Role-Based Access Control > Domains**.

The Domains table appears.

- Step 2** Expand the Domains table until you can see all the network domains.

- Step 3** Choose a domain to display the settings for that domain.

You can also perform these tasks from this window:

- [Configuring Device Domains, page 5-63](#)
 - [Modifying Device Domains, page 5-65](#)
 - [Deleting Device Domains, page 5-65](#)
-

Related Topics

- [Configuring Device RBAC Domains, page 5-61](#)
- [Configuring ACE Module and Appliance Role-Based Access Controls, page 5-53](#)

Configuring Device Domains

You can add or modify domains on a selected device, such as a Catalyst 6500 series chassis.

**Note**

This configuration is applicable only on the device or building block and will not be enforced by ANM. To manipulate ANM RBAC, go to Admin > Role-Based Access Control.

Procedure

Step 1 Choose the item to configure:

- To configure a virtual context, choose **Config > Devices > context > Device RBAC > Domains**.
- To configure a configuration building block, choose **Config > Global > Building Blocks > building_block > Role-Based Access Control > Domains**.

The Domains table appears.

Step 2 In the Domains table, choose the type of configuration that you want to perform:

- To add a new domain, click **Add**, enter the Domain Name, and then click **Deploy Now** to deploy this configuration on the ACE and save your entries to the running-configuration and startup-configuration files.
- To edit a domain, choose the domain that you want to configure, and then click **Edit**.

The Domain Object field appears below the Domain Name in the content area.

Step 3 Click **Edit** to enter the Domain Object table.

- Step 4** In the Domain Object table, choose the type of configuration that you want to perform:
- Click **Add** to create domain objects for this domain. See [Table 5-22](#) for Domain Object attributes.
 - To remove an object, choose the object that you want to remove, and then click **Delete**.

Table 5-22 Domain Attributes

Field	Description
Name	Field that appears when any specific object type is selected. Name of an existing object defined.
All Objects	Collection of objects in this domain. The following options may be available depending on your virtual context: <ul style="list-style-type: none"> • All • Access List EtherType • Access List Extended • Class Map • Interface VLAN • Interface BVI • Parameter Map • Policy Map • Probe • Real Server • Script • Server Farm • Sticky

- Step 5** Click **Deploy Now** to deploy this configuration on the ACE and save your entries to the running-configuration and startup-configuration files.

The Domains Edit window updates and displays the total object number next to the object name.

Related Topics

- [Configuring Device RBAC Domains, page 5-61](#)
- [Configuring ACE Module and Appliance Role-Based Access Controls, page 5-53](#)

Modifying Device Domains

You can change the settings in a domain.



Note

This configuration is applicable only on the device or building block and will not be enforced by ANM. To manipulate ANM RBAC, go to Admin > Role-Based Access Control.

Procedure

-
- Step 1** Choose the item to configure:
- To configure a virtual context, choose **Config > Devices > context > Device RBAC > Domains**.
 - To configure a configuration building block, choose **Config > Global > Building Blocks > building_block > Role-Based Access Control > Domains**.
- Step 2** Choose the domain that you want to edit.
- Step 3** Click **Edit**.
- The Edit Domain window appears.
- Step 4** Edit the object fields (see [Table 5-22](#)).
- Step 5** Click **Deploy Now** to deploy this configuration on the ACE and save your entries to the running-configuration and startup-configuration files.
-

Related Topics

- [Configuring Device RBAC Domains, page 5-61](#)
- [Configuring ACE Module and Appliance Role-Based Access Controls, page 5-53](#)

Deleting Device Domains

You can delete a network domain from ANM, and all the devices and subdomains that it contains.



Note

This configuration is applicable only on the device or building block and will not be enforced by ANM. To manipulate ANM RBAC, go to Admin > Role-Based Access Control.

Procedure

-
- Step 1** Choose the item to configure:
- To configure a virtual context, choose **Config > Devices > context > Device RBAC > Domains**.
 - To configure a configuration building block, choose **Config > Global > Building Blocks > building_block > Role-Based Access Control > Domains**.
- The Domains table appears.
- Step 2** In the Domains table, choose the domain that you want to delete.
- Step 3** Click **Delete**.
- A prompt asks you to confirm this action.

Step 4 Click **OK**.

The domain is removed from the ANM database.

Related Topics

- [Configuring Device RBAC Domains, page 5-61](#)
- [Configuring ACE Module and Appliance Role-Based Access Controls, page 5-53](#)

Managing Devices

This section describes how to manage devices.

This section includes the following topics:

- [Synchronizing Device Configurations, page 5-66](#)
- [Mapping Real Servers to VMware Virtual Machines, page 5-68](#)
- [Instructing ANM to Recognize an ACE Module Software Upgrade, page 5-71](#)
- [Configuring User-Defined Groups, page 5-72](#)
- [Changing Device Credentials, page 5-75](#)
- [Changing ACE Module Passwords, page 5-77](#)
- [Restarting Device Polling, page 5-78](#)
- [Displaying All Devices, page 5-78](#)
- [Displaying Modules by Chassis, page 5-79](#)
- [Removing Modules from the ANM Database, page 5-80](#)

Synchronizing Device Configurations

ANM provides three levels of synchronization. You can choose to synchronize from the device to ANM as follows:

- From the chassis level—Use this level when you want to synchronize Catalyst 6500 series chassis and module updates. See the [“Synchronizing Chassis Configurations” section on page 5-67](#).
- From the ACE module level—Use this level when you want to synchronize changes to your ACE or CSM modules, such as new virtual contexts. See the [“Synchronizing Module Configurations” section on page 5-67](#).
- From the virtual context level —Use this level in the Admin context to synchronize all current and new virtual contexts or at the user context level to synchronize a specific user context. See the [“Synchronizing Virtual Context Configurations” section on page 6-105](#).

**Caution**

If you see a difference in device information between what ANM displays and what you see by directly accessing the device through the CLI, ANM displays the data that is the least accurate. This condition can occur when the device is modified outside of ANM by using the CLI. We recommend that you synchronize the network devices up to the ANM using the synchronization option, which makes the ANM data more accurate.

Synchronizing Chassis Configurations

You can manually synchronize the configuration for Catalyst 6500 series switches, CSS devices, GSS devices and ACE appliances when there have been changes to a device that are not tracked in ANM.

**Note**

ANM does not support auto synchronization for the Catalyst 6500 series switches, Cisco 7600 series routers, CSM, CSS, GSS, or VSS devices. Be sure to synchronize configurations on these devices after import, and whenever their configurations have been modified through the CLI.

The following require synchronization:

- Upgrading chassis hardware or software
- Adding new modules to the chassis
- Removing a module from a chassis
- Rearranging modules within the chassis
- Upgrading module software
- Changing the chassis configuration using the CLI instead of the ANM

Procedure

Step 1 Choose **Config > Devices > All Devices**.

The All Devices table appears.

Step 2 In the All Devices table, choose the device with the configuration that you want to synchronize, and click **CLI Sync**.

A popup confirmation window appears asking you to confirm the synchronization.

Step 3 In the confirmation window, click **OK** to synchronize the configuration or **Cancel** to cancel the synchronization.

ANM displays the status while synchronization is in progress and returns to the All Devices table when synchronization is complete.

Related Topics

- [Configuring Devices, page 5-34](#)
- [Synchronizing Module Configurations, page 5-67](#)
- [Restarting Device Polling, page 5-78](#)

Synchronizing Module Configurations

You can synchronize configurations for ACE modules or CSM modules when changes are made that have not been tracked in ANM.

The following module changes require synchronization:

- Upgrading module software
- Changing the module configuration using the CLI instead of the ANM

Procedure

-
- Step 1** Choose **Config > Devices > All Devices**.
The All Devices table appears.
- Step 2** In the All Devices table, choose the chassis that contains the module with the configuration that you want to synchronize, and click **Modules**.
The Modules table appears.
- Step 3** In the Modules table, choose the module with the configuration you want to synchronize, and click **Sync**.
A popup confirmation window appears asking you to confirm the synchronization.
- Step 4** In the confirmation window, click **OK** to synchronize the configuration or **Cancel** to cancel the synchronization.
ANM displays the status while synchronization is in progress and returns to the Modules table when synchronization is complete.
-

Related Topics

- [Configuring Devices, page 5-34](#)
- [Managing Devices, page 5-66](#)
- [Synchronizing Device Configurations, page 5-66](#)

Mapping Real Servers to VMware Virtual Machines

This section describes how ANM maps ACE, CSS, CSM, or CSM-S real servers to VMware vCenter Server VMs when you integrate ANM with a VMware virtual data center. This section also shows how you can display and manage the mappings associated with a VMware vCenter Server.

**Note**

To map a real server to a VM, the real server must be associated with a server farm (see the [“Configuring Server Farms”](#) section on page 8-30).

ANM uses the following methods to map a real server to a VM:

- **IP Match**—ANM matching the real server IP addresses to the VM IP address. This is the default mapping method that ANM uses and requires the following items:
 - Before you import a VMware vCenter Server into ANM along with its associated VMs, configure a real server in ANM for each VM about to be imported with the vCenter Server. Configure each real server with the IP address of a VM. For more information, see the [“Configuring Real Servers”](#) section on page 8-5 and the [“Importing VMware vCenter Servers”](#) section on page 5-24.
 - ANM must be able to determine the IP address of a VM, which is accomplished by installing VMware Tools on the guest operating system (OS) of the VM.
- **Name Match**—ANM matches the real server name to the VM name. This is the backup mapping method that ANM uses if it cannot match any IP address for the VM. This method requires consistent use of the device names throughout the network.



Note For the CSM and CSM-S, the VM name must be in uppercase because the CSM and CSM-S real server names are always in upper case and the mapping is case sensitive though the CSM and CSM-S is case insensitive. From vSphere Client, you can change a VM name to uppercase by right-clicking on the VM in the VM tree and choosing **Rename**.

- **Override**—You specify the real server-to-VM mapping.
- **Ignore**—ANM ignores any mapping method.

ANM can detect when VMs are added or deleted to a VMware vCenter Server by listening to the server events or by polling the server. When a new VM is detected, ANM uses the IP match method to try and match the new VM with a real server.

Prerequisites

This topic includes the following prerequisites:

- Import the VMware vCenter Server into ANM (see the [“Importing VMware vCenter Servers” section on page 5-24](#)).
- Register the ANM plug-in with the VMware vCenter Servers that you want to view and manage.

Procedure

-
- Step 1** Choose **Config > Devices > All Devices**.
The All Devices table appears.
- Step 2** In the All Devices table, choose the VMware vCenter Server that contains the VMs that you want to display and map.
The Primary Attribute table appears.
- Step 3** Click **VM Mappings**.
The VM Mappings table appears. [Table 5-3](#) describes the information that displays in the VM Mappings table.

Table 5-23 VM Mappings Table

Item	Description
VM Name	Name of the VM associated with the selected VMware vCenter Server.
IP Address(es)	IP address of the VM.
Full Path	Path of the VM on the VMware vCenter Server.
Rule Currently Applied	Mapping rule applied: IP Match, Name Match, Override, or Ignore. This field is blank if ANM is unable to find a real server match for the VM. You can manually map a real server to the VM using the Edit Mapping feature (see Step 5).

Table 5-23 VM Mappings Table (continued)

Item	Description
ACE Real Server(s)	<p>ACE real server that the VM maps to on ANM.</p> <p>Note the following:</p> <ul style="list-style-type: none"> This field is blank if ANM is unable to find a real server match for the VM. You can manually map a real server to the VM using the Edit Mapping feature (see Step 5). If the VM has been deleted in the vCenter Server but ANM still has the mapping, a delete icon (red circle with an “x”) appears at the end of the real server ID. Click the icon to remove the mapping from the table.
Last Updated Time	Timestamp when the mapping information was obtained.

**Note**

If the VM Mappings window does not display or a VM name contains hex values rather than certain special characters, these conditions indicate that VM names associated with a vCenter Server that you imported in to ANM contain special characters that ANM does not recognize. For example, a VM name that contains a double quote (“”) prevents ANM from displaying the VM Mappings window. If a VM name contains a percent sign (%), backslash (\), or forward slash (/), ANM displays the VM name in the VM Mappings window; however, these special characters display as hex values (%25 for %, %5c for \, and %2f for /).

To correct these issues, remove the special characters from the VM names and then manually perform a CLI synchronization (see [Step 4](#)).

Step 4 (Optional) To update the displayed real server to VM mapping information, manually perform a CLI synchronization with the vCenter Server as follows:

- Choose **Config > Devices > All Devices**. The All Devices table appears.
- From the All Devices table, click the radio button associated with the desired vCenter Server.
- Click **CLI Sync**.

**Note**

You must perform this step to update the display if you import a Cisco device after you import an associated vCenter Server.

Step 5 (Optional) To change the mapping rule applied to a VM, in the VM Mappings window, check the checkbox next to the VM names to edit and click **Edit Mappings**.

The VM Mappings edit window appears, providing a list of the selected VMs and the mapping rule options.

Step 6 From the VM Mappings edit window, choose one of the following options from the Mapping Rule drop-down list:

- IP Match**—Map the VMs to ACE real servers based on matching IP addresses. Skip to [Step 8](#).
- Name Match**—Map the VMs to ACE real servers based on matching device names. Skip to [Step 8](#).
- Ignore**—Ignore any mapping rule and do not map the VM to an ACE real server. Skip to [Step 8](#).

- **Override**—Map the VMs the specified ACE real servers. This option is available only when you have one VM selected from the All Devices table (see [Step 2](#)). When you choose Override, ANM displays the Select Real Server(s) table of available ACE real servers that includes the device information, real server name, IP address, port number, and server farm to which the real server belongs.

Step 7 If you chose the Override mapping rule, do one or both of the following:

- Check the checkbox next to the real servers to map the selected real servers to the VM. To select all of the available real servers, check the Device checkbox located at the top of the table.
- Click **Add** to add a new real server. The Add a Real Server popup window appears. Define the new real server as described in [Table 5-24](#) and click **Deploy Now**.

Table 5-24 Adding a Real Server for VM Mapping

Item	Description
Real Server Name	Unique name for this server or accept the automatically incremented value in this field. Valid entries are unquoted text strings with no spaces and a maximum of 64 characters.
Real Server IP Address	Unique IP address in dotted-decimal format (such as 192.168.11.1). The IP address cannot be an existing virtual IP address (VIP).
Real Server Port	Port used for communication with the real server.
Real Server Weight	Weight to be assigned to this real server in a server farm. Valid entries are from 1 to 100, and the default is 8.
Real Server State	State of the real server when deployed: <ul style="list-style-type: none"> • In Service—The real server is in service. • Out Of Service—The real server is out of service.
ACE Virtual Context	Virtual context that is associated with the real server.
Serverfarm	Server farm to which the real server belongs.
Virtual Servers	Virtual server that is associated with the real server.

Step 8 In the VM Mappings window, click **OK** to save the new mapping rule or **Cancel** to cancel the change.

Related Topics

- [Configuring Real Servers, page 8-5](#)
- [Importing VMware vCenter Servers, page 5-24](#)
- [Configuring VMware vCenter Server Primary Attributes, page 5-41](#)

Instructing ANM to Recognize an ACE Module Software Upgrade

When you upgrade the software of an ACE module that has been imported to the ANM database, perform the procedure outlined in this section to enable ANM to recognize the updated release and display features and functions in the ANM GUI that are appropriate for the ACE module software upgrade.

For example, if an imported ACE module contains software Version A2(2.1), and you wish to upgrade to software Version A2(3.0) to take advantage of features such as backup and restore, you must perform the steps outlined below to instruct ANM to recognize the upgraded ACE module software version and

display the features and functions associated with this release. If you do not instruct ANM to recognize an ACE module software upgrade, the ACE module import will occur without issue but the new features and functions associated a specific ACE module software release will not appear in the ANM GUI.

Procedure

-
- Step 1** After you upgrade an ACE module software image, perform a CLI sync on the module's host device (see the [“Synchronizing Chassis Configurations”](#) section on page 5-67).
- Step 2** After you complete the CLI sync, whenever ANM detects an upgrade on an imported ACE module, ANM issues a warning to instruct you to perform a CLI sync on the ACE module to recognize the upgrade. Perform the procedure described in the [“Synchronizing Module Configurations”](#) section on page 5-67.

The ACE software upgrade sequence is completed.

Configuring User-Defined Groups

You can create logical groupings of virtual contexts or chassis for ease of management. These logical groups are known as *user-defined groups* and appear in the device tree (Config > Devices) in the folder named *Groups* for quick access.

Users can create their own groups, add and remove members, and assign group names that suit their environment and are meaningful to them.

This section includes the following topics:

- [Adding a User-Defined Group, page 5-72](#)
- [Modifying a User-Defined Group, page 5-73](#)
- [Duplicating a User-Defined Group, page 5-74](#)
- [Deleting a User-Defined Group, page 5-75](#)



Note

Device groups continue to display device information even after you remove that device from ANM, which allows the device group information to be easily reassociated if you reimport the device. The device name must remain the same.

Adding a User-Defined Group

You can add a user-defined group.

Procedure

-
- Step 1** Choose **Config > Devices > All Devices**.
The device tree appears.
- Step 2** In the device tree, choose **Groups**.
The Groups table appears.
- Step 3** Click **Add** to add a new group, or choose an existing group, and click **Edit** to modify it.

The Group configuration window appears.

- Step 4** In the Name field of the Group configuration window, enter a unique name for this group. Valid entries are unquoted text strings with no spaces and a maximum of 26 alphanumeric characters. The window identifies the objects by type and provides a search field for each:
- Virtual Context Members
 - Device Members
 - Module Members
 - CSM Members
- Step 5** To add objects to the group, for each object type, choose the object in the Available Items list, and click **Add**.
- The selected objects appear in the Selected Items list.
- To remove objects that you do not want to include, choose the objects in the Selected Items list, and click **Remove**. The items then appear in the Available Items list.
- To search for specific objects, enter a search string that contains the object name or part of the object name in the Search field, and then click **Search**. The Available Items list refreshes with the objects that meet the search criteria.
- Step 6** In the Description field, enter a description for this group.
- Step 7** Do one of the following:
- Click **Save** to accept your entries and to return to the Groups table.
 - Click **Cancel** to exit this procedure without saving your entries and to return to the Groups table.
-

Related Topics

- [Configuring User-Defined Groups, page 5-72](#)
- [Modifying a User-Defined Group, page 5-73](#)
- [Duplicating a User-Defined Group, page 5-74](#)
- [Deleting a User-Defined Group, page 5-75](#)

Modifying a User-Defined Group

You can change the members or the description of a user-defined group. You cannot change the name of an existing user-defined group.

Procedure

- Step 1** Choose **Config > Devices > All Devices**.
- The device tree appears.
- Step 2** In the device tree, click **Groups**.
- The Groups table appears.
- Step 3** In the Groups table, choose the group that you want to modify, and click **Edit**.
- The Group configuration window appears.

- Step 4** In each Members field of the Group configuration window, add or remove group members as follows:
- Choose the items that you want to add to this group in the Available Items list, and click **Add**.
 - Choose the items that you want to remove from this group in the Selected Items list, and click **Remove**.
- Step 5** In the Description field, modify the description as needed.
- Step 6** Do one of the following:
- Click **Save** to accept your entries and to return to the Groups table.
 - Click **Cancel** to exit this procedure without saving your entries and to return to the Groups table.
-

Related Topics

- [Configuring User-Defined Groups, page 5-72](#)
- [Adding a User-Defined Group, page 5-72](#)
- [Duplicating a User-Defined Group, page 5-74](#)
- [Deleting a User-Defined Group, page 5-75](#)

Duplicating a User-Defined Group

You can duplicate a user-defined group.

Procedure

-
- Step 1** Choose **Config > Devices > All Devices**.
- The device tree appears.
- Step 2** In the device tree, click **Groups**.
- The Groups table appears.
- Step 3** In the Groups table, choose the user-defined group that you want to duplicate, and click **Duplicate**.
- A popup window appears asking you to enter a new name.
- Step 4** In the popup window, type the new group name, and click **OK**.
- The Groups table refreshes and the duplicated group name appears in the list.
-

Related Topics

- [Configuring User-Defined Groups, page 5-72](#)
- [Adding a User-Defined Group, page 5-72](#)
- [Modifying a User-Defined Group, page 5-73](#)
- [Deleting a User-Defined Group, page 5-75](#)

Deleting a User-Defined Group

You can delete a user-defined group.

Procedure

- Step 1** Choose **Config > Devices > All Devices**.
- The device tree appears.
- Step 2** In the device tree, click **Groups**.
- The Groups table appears.
- Step 3** In the Groups table, choose the user-defined group that you want to remove, and click **Delete**.
- A popup confirmation window appears asking you to confirm the deletion.
- Step 4** In the popup confirmation window, do one of the following:
- Click **OK** to delete the selected user-defined group.
The Groups table refreshes and the deleted group no longer appears.
 - Click **Cancel** to exit this procedure without deleting the group.
The Groups table refreshes.
-

Related Topics

- [Configuring User-Defined Groups, page 5-72](#)
- [Adding a User-Defined Group, page 5-72](#)
- [Modifying a User-Defined Group, page 5-73](#)
- [Duplicating a User-Defined Group, page 5-74](#)

Changing Device Credentials

You can change the credentials associated with a device managed by ANM. Each device that you import into ANM has a device username and password associated with it that ANM uses to access the device. Some device types, such as the GSS, also have a device enable password associated with them. From ANM, you can change the device credentials in the ANM database to match a change made to the credentials on a device using the CLI. This feature allows you to change the device credentials without having to rediscover or reimport the device.

This procedure applies to the following device types that have been imported into ANM:

- ACE appliance
- Global Site Selector (GSS)
- Content Services Switch (CSS)
- Catalyst 6500 Virtual Switching System (VSS) 1440
- Catalyst 6500 series switch
- Cisco 7600 series router
- VMware vCenter Server

**Note**

To change the credentials of an ACE module, see the [“Changing ACE Module Passwords”](#) section on page 5-77.

Guidelines and Restrictions

This topic includes the following guidelines and restrictions:

- You can change a device username, password, or both.
- We recommend changing the device credentials on the device before changing the credentials on ANM.

**Caution**

To maintain communication between ANM and the device, it is important that whatever device credential change you make on the device, you make the same change on ANM.

Procedure

Step 1 Choose **Config > Devices > All Devices**.

The All Devices table appears.

Step 2 In the All Devices table, choose the device with the passwords that you want to update in ANM, and click **Update Credentials**.

The Update Credentials popup window appears.

Step 3 From the popup window, update the device credential using the information in [Table 5-25](#).

Table 5-25 **Update Device Credentials**

Field	Description
Username	Existing or new device username.
New Password	Existing or new device password.
Confirm New Password	Confirmation of the device password.
New Enable Password ¹	Existing or new device enable password.
Confirm Enable Password ¹	Confirmation of the device enable password.

1. GSS and Catalyst 6500 series switch only.

**Note**

All credential fields are mandatory, so even if you are updating the device password only, you must enter the current device username.

Step 4 Do one of the following:

- Click **OK** to save your changes to ANM. Do the following:
 - a. If you have not already made a similar change to the device credentials on the device, use the device CLI to make the changes now.
 - b. Perform a CLI synchronization to test communications between ANM and the device with the new credentials (see the [“Synchronizing Device Configurations”](#) section on page 5-66).

- Click **Cancel** to ignore any changes that you made and close the popup window.

Related Topics

- [Configuring Devices, page 5-34](#)
- [Managing Devices, page 5-66](#)
- [Changing ACE Module Passwords, page 5-77](#)

Changing ACE Module Passwords

You can change the ACE module username and password. All ACE modules shipped from Cisco are configured with the same administrative username and password. Because changing the module credentials can compromise network security, we recommend that you change the username and passwords after you import the module into the ANM database.

**Note**

This functionality is available only in Admin contexts.

Before You Begin

Import the ACE module into ANM and ensure that it is operational (see the [“Importing ACE Modules after the Host Chassis has been Imported”](#) section on page 5-16).

Procedure

-
- Step 1** Choose **Config > Devices > All Devices**.
- The device tree appears.
- Step 2** In the device tree, choose the chassis device containing the ACE module with the password that you want to change.
- The Primary Attributes window appears.
- Step 3** From the side menu, choose **System > Module/Slots**.
- The Modules table appears.
- Step 4** In the Modules table, choose the module with the password that you want to change and click **Update Credentials**.
- The Modules configuration window appears.
- Step 5** In the Card Slot field, confirm that the correct module is selected.
- Step 6** In the Card Type field, confirm that the correct version appears.
- Step 7** In the Module Has Been Imported Into ANM field, confirm that the checkbox is checked to indicate that the module has been imported. This is a read-only field.
- Step 8** From the Operation To Perform drop-down list, choose **Update Credentials**.
- Step 9** In the User Name field, enter the existing module username or enter a new username.
- Step 10** In the New Password field, enter the existing device password or enter a new password.
- Valid passwords are unquoted text strings with a maximum of 64 characters.
- Step 11** In the Confirm field, verify the password that you entered in the New Password field.

Step 12 Do one of the following:

- Click **OK** to save your changes to ANM. Do the following:
 - a. If you have not already made a similar change to the device credentials on the device, use the device CLI to make the changes now.
 - b. Perform a CLI synchronization to test communications between ANM and the device with the new credentials (see the “[Synchronizing Device Configurations](#)” section on page 5-66).
 - Click **Cancel** to exit the procedure without saving your entries and to return to the Modules table.
-

Related Topics

- [Importing ACE Modules after the Host Chassis has been Imported](#), page 5-16
- [Configuring Devices](#), page 5-34
- [Managing Devices](#), page 5-66
- [Changing Device Credentials](#), page 5-75

Restarting Device Polling

You can restart monitoring on a device that has stopped or failed to start.

Procedure

Step 1 Choose **Config > Devices > All Devices**.

The All Devices table appears.

Step 2 In the All Devices table, choose the device whose monitoring has stopped or failed, and click **Restart Polling**.

The All Devices table refreshes with updated polling status. For a description of the various polling status variables, see [Table 5-26 on page 5-79](#).

If ANM cannot monitor the selected device, it displays an error message stating the reason.

Related Topics

- [Configuring Devices](#), page 5-34

Displaying All Devices

You can display all devices that have been imported into the ANM database.

Procedure

Step 1 Choose **Config > Devices**.

The device tree appears.

Step 2 In the device tree, choose **All Devices**.

The All Devices table displays information for the devices being managed by the ANM (see [Table 5-26](#)).

Table 5-26 *All Devices Table Attributes*

Field	Description
Name	Name assigned to the device.
Type	Type of the device, such as Chassis, ACE 4710, or CSS.
Version	Version of the software running on the device, if available.
IP Address	Device IP address.
Polling Status	Current polling status of the device: <ul style="list-style-type: none"> • Missing SNMP Credentials—SNMP credentials are not configured for this device; therefore, statistics are not collected. Add SNMPv2C credentials to fix this error. • Not Polled—SNMP polling has not started. Add SNMP V2C credentials to fix this error. • Monitoring Not Supported—This status appears at the device level only and applies to Catalyst 6500 series chassis, Cisco 7600 series routers, and ACE appliances. • Polling Failed—SNMP polling failed due to some internal error. Try enabling the SNMP collection again. • Polling Started—No action is required; everything is working properly. Polling states will display the activity. • Polling Timed Out—SNMP polling has timed out. This situation might occur if the wrong credentials were configured or an internal error exists, such as the SNMP protocol is configured incorrectly or the destination is not reachable. Verify that SNMP credentials are correct. If the problem persists, enable SNMP collection again. • Unknown—SNMP polling is not working due to one of the above-mentioned conditions. Check the SNMPv2C credential configuration.

Related Topics

- [Importing Network Devices into ANM, page 5-10](#)
- [Configuring Catalyst 6500 Series Chassis and Cisco 7600 Series Router Primary Attributes, page 5-38](#)
- [Displaying Chassis Interfaces and Configuring High-Level Interface Attributes, page 5-42](#)

Displaying Modules by Chassis

You can display all modules on a specific chassis.

Procedure

Step 1 Choose **Config > Devices > All Devices**.

The All Devices table appears.

Step 2 In the All Devices table, choose the chassis containing the modules that you want to view, and click **Modules**.

The Modules table appears, listing all modules on that chassis with the following information:

- Slot number
- Service module model
- Module type, such as Cisco Content Switching Module (CSM), ACE module and version, or other modules, such as supervisor modules
- Serial number
- Module operational state, such as Up, Powered Off, or Not Imported
- Version of software the module is running
- Brief description
- For ACE modules, the number of virtual contexts configured on the module
- For VSS devices, a Virtual Switch number column indicating the switch, slot, and port number. For example, command interface 1/5/4 specifies port 4 of the switching module in slot 5 of switch 1.

Depending on the type of module selected, such as CSM or ACE modules, the following options are available from this window:

- **Import**—Imports a CSM or ACE module that resides in the selected chassis but has not been imported into the ANM database. For more information, see the [“Importing ACE Modules after the Host Chassis has been Imported”](#) section on page 5-16 or the [“Importing CSM Devices after the Host Chassis has been Imported”](#) section on page 5-19.
- **Change Card Password**—Changes the administrative password on an ACE module that has been imported into the ANM database. For more information, see the [“Changing ACE Module Passwords”](#) section on page 5-77.
- **Do Not Manage**—Removes a selected ACE module from the ANM database. For more information, see the [“Removing Modules from the ANM Database”](#) section on page 5-80.

Step 3 (Optional) To display the modules of another chassis, choose another chassis in the device tree or use the chassis selector field at the top of the window.

Related Topics

- [Importing ACE Modules after the Host Chassis has been Imported, page 5-16](#)
- [Importing CSM Devices after the Host Chassis has been Imported, page 5-19](#)
- [Displaying Chassis Interfaces and Configuring High-Level Interface Attributes, page 5-42](#)
- [Managing Catalyst 6500 Series Chassis or Cisco 7600 Series Router VLANs, page 5-48](#)

Removing Modules from the ANM Database

You can remove a module from the ANM database.



Note

If you physically replace an ACE module in a chassis, you need to synchronize the chassis in the ANM. See the [“Synchronizing Chassis Configurations”](#) section on page 5-67 for more information.

Procedure

- Step 1** Choose **Config > Devices > All Devices**.
The All Devices table appears.
- Step 2** In the All Devices table, choose the device containing the module that you want to remove, and click **Modules**.
The Modules table appears.
- Step 3** In the Modules table, choose the module that you want to remove from ANM management, and click **Do Not Manage**.
The Modules configuration window appears.
- Step 4** In the Modules configuration window, confirm the information in the following fields:
- Card Slot
 - Card Type
 - Module Has Been Imported Into ANM
- Step 5** In the Operation To Perform field, choose **Do Not Manage**.
- Step 6** Do one of the following:
- Click **OK** to confirm removal of the module.
The Modules table refreshes and the removed module appears with the state Not Imported.
You can import the module again when desired (see the [“Importing ACE Modules after the Host Chassis has been Imported”](#) section on page 5-16).
 - Click **Cancel** to exit the procedure without removing the ACE module and to return to the Modules table.
-

Related Topics

- [Importing Network Devices into ANM, page 5-10](#)
- [Changing ACE Module Passwords, page 5-77](#)

Replacing an ACE Module Managed by ANM

This section describes the process that you must follow when replacing an ACE module that is currently managed by ANM. You may need to replace an ACE module to perform a hardware upgrade or replace a device associated with a Return Materials Authorization (RMA).

The procedures in this section show how to replace an ACE module using either the preferred method, which uses the ANM GUI, or the alternate method, which uses a combination of the ACE CLI and the ANM GUI.

Guidelines and Restrictions

This topic includes the following guidelines and restrictions:

- The replacement process includes creating a backup of the ACE module being removed and installing the backup on the replacement module. The final step is to run a script that maps the domain attributes that were mapped to the old ACE module serial number to the new module serial number. These domain attributes include items such as real servers, virtual servers, user groups, custom groups, mobile favorites, and so forth.



Caution

When replacing your ACE module, it is important that you complete the entire replacement procedure before attempting to edit the properties of any domain. Editing the domains before running the script that remaps existing domain attributes to the new ACE module serial number can result in the attributes being removed.

- If you currently use an ACE10 or ACE20 module, you must upgrade to the ACE30 module with ACE software Version A5(1.0) to use the new features associated with the A5(1.0) release in ANM 5.1. For more information about a module upgrade, see the *Cisco Application Control Engine (ACE30) Module Installation Note*.



Caution

When replacing an ACE module that is part of a redundant pair providing high availability, be sure that the ACE module being replaced is operating in the standby state and not in the active state. Replacing an active redundant ACE module is a service-affecting operation.

The state information is displayed in the HA State and HA Autosync fields when you choose Config > Devices > *virtual_context*. Force a switchover if needed to place the ACE module in the standby state before you replace it.

Prerequisites

To perform the procedures in this section, you need a copy of the *Cisco Application Control Engine (ACE30) Module Installation Note* which you can obtain on Cisco.com.

This section includes the following topics:

- [Using the Preferred Method to Replace an ACE Module, page 5-82](#)
- [Using the Alternate Method to Replace an ACE Module, page 5-84](#)

Using the Preferred Method to Replace an ACE Module

You can replace an ACE module currently managed by ANM by using the ANM GUI-based method.



Note For details about any of the ANM GUI functions discussed in the following procedure, click **Help** to display the context-sensitive help associated with the current GUI window.

Procedure

- Step 1** From the ANM GUI, create a backup the ACE module that you are replacing using one of the following methods:
- Choose **Config > Devices > context > System > Backup / Restore**. The Backup/Restore window appears.
 - Choose **Config > Global > All Backups**. The Backup window appears.



Note The Backup/Restore feature requires ACE module software Version A2(3.0) or later.

Save or copy the backup to a network location.

- Step 2** Record the module serial number of the ACE module being replaced, which you will need in Step 11. To obtain the module serial number, choose **Config > Devices > All Devices**, click the chassis that contains the module being replaced, and click **Modules**.
- Step 3** From the Cisco IOS host chassis, remove the ACE module that you want to replace (see the *Cisco Application Control Engine (ACE30) Module Installation Note*).
- Step 4** From the ANM GUI, perform a CLI synchronization with the Cisco IOS host chassis.



Note When you perform the CLI synchronization, all the threshold groups associated with the removed ACE module are deleted.

Do the following:

- a. Choose **Config > Devices > All Devices**. The Device Management window appears.
- b. From the Device Management window, click the radio button associated with the host chassis.
- c. Click **CLI Sync**.

A message similar to the following appears:

```
Warning: The module has been removed: serial#=SAL1413E2YK
```

- Step 5** From the Cisco IOS host chassis, insert the replacement (new) ACE module into the chassis (see the *Cisco Application Control Engine (ACE30) Module Installation Note*).
- Step 6** Using the CLI, verify that the software on the replacement ACE is equal to or greater than the software version used in the original ACE.
- Upgrade the ACE software on the new device if needed. After the upgrade, reboot the ACE module and verify that it is running with the correct software image to ensure that ANM can recognize it.
- Step 7** From the ANM GUI, do the following to perform a CLI synchronization with the Cisco IOS host chassis by doing the following:
- a. Choose **Config > Devices > All Devices**. The Device Management window appears.
 - b. From the Device Management window, click the radio button associated with the host chassis.

- c. Click **CLI Sync**.

A message similar to the following appears:

```
The module has been added: serial#=#SAD140102XR
```

Record the new ACE module serial number, which you will need for Step 11.

- Step 8** From the Device Management window, import the replacement module in to ANM as follows:
- a. Click the radio button associated with the host chassis and click **Modules**. The Modules window appears.
 - b. From the Modules window, click the radio button associated with the replacement module and click **Import**. The Module configuration window appears.
 - c. From the configuration window, choose **Perform Initial Setup and Import** from the Operation To Perform drop-down list and enter the module configuration information that you recorded in Step 2.
 - d. Click **OK** to save the module configuration information.
- Step 9** Install a license in the replacement module that is consistent with the removed module by choosing **Config > Devices > chassis > module > Admin > System > Licenses**. The Licenses window appears.
- Step 10** Copy and restore the saved ACE configuration to the replacement module by choosing **Config > Devices > chassis > module > Admin > System > Backup / Restore**.



Note The Backup/Restore feature requires ACE module software Version A2(3.0) or later.

- Step 11** Remap the ANM objects mapped to the old ACE module serial number to the new ACE module serial number as follows:
- a. Enter the following command to list the module serial numbers that are unassociated with a device in ANM:
anm-RMA-helper-query
Verify that the list includes the serial number of the old ACE module that you recorded in [Step 2](#).
 - b. Enter the following command to map the objects to the new ACE module serial number:
anm-RMA-helper-replace
 - c. Follow the prompts that appear to log in to ANM and specify the old ACE module serial number recorded in [Step 2](#) and the new module serial number recorded in [Step 7](#).
-

Related Topics

- [Importing ACE Modules after the Host Chassis has been Imported, page 5-16](#)

Using the Alternate Method to Replace an ACE Module

This procedure describes the alternate method for replacing an ACE module currently managed by ANM. This method uses a combination of the ACE CLI and ANM GUI during the replacement process. To see the preferred method for replacing an ACE module, see the [“Using the Preferred Method to Replace an ACE Module”](#) section on page 5-82.

**Note**

For details about using the ACE CLI to perform the procedures discussed in the following procedure, see the *Cisco Application Control Engine (ACE30) Module Installation Note*.

For details about any ANM GUI function discussed in the following procedure, click **Help** to display the context-sensitive help associated with the current GUI window.

Procedure

-
- Step 1** Referring to the *Cisco Application Control Engine (ACE30) Module Installation Note*, do the following:
- SSH in to the ACE and backup all contexts from the Admin context (requires ACE module software Version A2(3.0) or later).
 - Copy the backup to a network location (requires ACE module software Version A2(3.0) or later).
 - Obtain and record the old module serial number using the **show hardware** command. You will need the serial number in Step 4.
 - From the Cisco IOS host chassis, remove the ACE module that you want to replace.
 - From the Cisco IOS host chassis, insert the replacement ACE module into the chassis.
 - Verify that the software on the replacement ACE is equal to or greater than the software version used in the original ACE. Upgrade the ACE software on the new device if needed.
 - SSH in to the chassis and session in to the new ACE module.
 - Configure basic ACE module connectivity.
 - Obtain and record the new module serial number using the **show hardware** command.
 - Copy and install necessary licenses.
 - Copy and restore the ACE backup.
- Step 2** From the ANM GUI, delete the Cisco IOS host chassis that hosts the replacement ACE module as follows:
- Choose **Config > Devices > All Devices**. The Device Management window appears.
 - Click the radio button associated with the chassis in which the module was replaced.
 - Click **Delete**.
- Step 3** From the Device Management window, import the Cisco IOS host chassis and associated chassis modules, including the replacement ACE module by clicking **Add**. The Add New Device window appears; complete the required chassis and module information.
- Step 4** Remap the ANM objects mapped to the old ACE module serial number to the new ACE module serial number as follows:
- Enter the following command to list the module serial numbers that are unassociated with a device in ANM:
anm-RMA-helper-query
Verify that the list includes the serial number of the old ACE module that you recorded in [Step 1c](#).
 - Enter the following command to map the objects to the new ACE module serial number:
anm-RMA-helper-replace

- c. Follow the prompts that appear to log in to ANM and specify the old ACE module serial number recorded in [Step 1c](#) and the new module serial number.
-

Related Topics

- [Importing ACE Modules after the Host Chassis has been Imported, page 5-16](#)



CHAPTER 6

Configuring Virtual Contexts

Date: 3/28/12

This chapter describes how to configure and manage the Cisco Application Control Engine (ACE) using Cisco Application Networking Manager (ANM).



Note

When naming ACE objects (such as a real server, virtual server, parameter map, class map, health probe, and so on), enter an alphanumeric string of 1 to 64 characters, which can include the following special characters: underscore (_), hyphen (-), dot (.), and asterisk (*). Spaces are not allowed.

If you are using ANM with an ACE module or ACE appliance and you configure a named object at the ACE CLI, keep in mind that ANM does not support all of the special characters that the ACE CLI allows you to use when configuring a named object. If you use special characters that ANM does not support, you may not be able to import or manage the ACE using ANM.

This chapter includes the following sections:

- [Information About Virtual Contexts, page 6-2](#)
- [Creating Virtual Contexts, page 6-2](#)
- [Configuring Virtual Contexts, page 6-8](#)
- [Configuring Virtual Context System Attributes, page 6-13](#)
- [Configuring Virtual Context Primary Attributes, page 6-14](#)
- [Configuring Virtual Context Syslog Settings, page 6-19](#)
- [Configuring SNMP for Virtual Contexts, page 6-27](#)
- [Applying a Policy Map Globally to All VLAN Interfaces, page 6-35](#)
- [Managing ACE Licenses, page 6-36](#)
- [Using Resource Classes, page 6-43](#)
- [Using Global Resource Classes, page 6-46](#)
- [Using Local Resource Classes, page 6-51](#)
- [Using the Configuration Checkpoint and Rollback Service, page 6-54](#)
- [Performing Device Backup and Restore Functions, page 6-59](#)
- [Performing Global Device Backup and Copy Functions, page 6-68](#)
- [Configuring Security with ACLs, page 6-78](#)

- [Configuring Object Groups, page 6-89](#)
- [Managing ACLs, page 6-99](#)
- [Configuring Virtual Context Expert Options, page 6-101](#)
- [Comparing Context and Building Block Configurations, page 6-101](#)
- [Managing Virtual Contexts, page 6-103](#)

Information About Virtual Contexts

Virtual contexts use the concept of virtualization to partition your ACE into multiple virtual devices or contexts. Each context contains its own set of policies, interfaces, resources, and administrators. This feature enables you to more closely and efficiently manage resources, users, and the services you provide to your customers.

There are two types of virtual contexts; the admin context and the user context. The ACE comes preconfigured with the default Admin context, which you can modify but you cannot delete. From the Admin context, you can create user contexts. You also use the Admin context to configure High Availability (HA or fault tolerance between ACE devices), configure resource classes, and manage ACE licenses.



Note

If you restore the ANM database from a backup repository and if a virtual context that is in the repository has been removed from the device, ANM removes that context from the database and the context does not appear in the ANM interface.

Related Topics

- [Creating Virtual Contexts, page 6-2](#)
- [Configuring Virtual Contexts, page 6-8](#)
- [Deleting Virtual Contexts, page 6-107](#)
- [Comparing Context and Building Block Configurations, page 6-101](#)
- [Restarting Virtual Context Polling, page 6-108](#)
- [Managing Virtual Contexts, page 6-103](#)

Creating Virtual Contexts

You can create virtual contexts.



Note

You must have the ability to create virtual contexts in your role and an Admin context in your domain before you can create virtual contexts. For more information about configuring roles and domains, see the “[Managing User Roles](#)” section on page 18-25 and the “[Managing Domains](#)” section on page 18-32.

Procedure

- Step 1** Choose **Config > Devices**, and choose the ACE to which you want to add a virtual context. The Virtual Contexts table appears.

Step 2 In the Virtual Contexts table, click **Add**.

The New Virtual Context window appears.

Step 3 Configure the virtual context using the information in [Table 6-1](#).

Click **Basic Settings**, **Management Settings**, or **More Setting** to access the additional configuration attributes. By default, ANM hides the Management Settings and More Settings groups of configuration attributes until you specify a VLAN identifier in the Management Settings group.



Note Fields and information related to IPv6 require ACE module and ACE appliance software Version A5(1.0) or later.

Table 6-1 Virtual Context Configuration Attributes

Field	Description
Basic Settings	
Name	Unique name for the virtual context. Valid entries are unquoted text strings with no spaces and a maximum of 64 alphanumeric characters. This field is read-only for existing contexts.
Device	Device to associate with this context. This field appears for new contexts only.
Description	Brief description of the virtual context. Enter a description as an unquoted text string with a maximum of 240 alphanumeric characters.
Module	Field that appears when a chassis contains multiple ACE modules and for new contexts only. Choose the module to associate with this context.
Resource Class	Resource class that this virtual context is to use.
Allocated VLANs	Number of a VLAN or a range of VLANs used by the traffic that the context is to receive. You can specify VLANs in any of the following ways: <ul style="list-style-type: none"> For a single VLAN, enter an integer from 2 to 4096. For multiple, nonsequential VLANs, use comma-separated entries, such as 101, 201, 302. For a range of VLANs, use the format <beginning-VLAN>-<ending-VLAN>, such as 101-150. Note VLANs cannot be modified in an Admin context.
Default Gateway IP for IPv4	IPv4 address of the default gateway. Use a comma-separated list to specify multiple IP addresses, such as 192.168.65.1, 192.168.64.2. Default static routes with a netmask and IP address of 0.0.0.0 previously configured on the ACE appear in this field.

Table 6-1 Virtual Context Configuration Attributes (continued)

Field	Description
Default Gateway IP for IPv6	<p>Field that appears only for ACE module and ACE appliance software Version A5(1.0) or later. IPv6 address of the default gateway or choose the forward VLAN interface or BVI, as follows:</p> <ul style="list-style-type: none"> IPv6 Address field—Enter the address of the gateway router (the next-hop address for this route). Then, use the right arrow to move it to the Selected field. You can enter a maximum of eight addresses including a selected VLAN or BVI through the Outgoing Interfaces setting. <p>Default static routes with a prefix and IP address of ::0 previously configured on the ACE appear in the Selected field.</p> <ul style="list-style-type: none"> Outgoing Interfaces—Select either VLAN or BVI used for the link-local address only. And then select the Interface Number for the VLAN or BVI.
Enable High Availability	<p>Context to be used in a high availability (HA) group.</p> <p>Note This field is unavailable if the associated FT interface is not configured or if the ACE peer is not known. See Chapter 13, “Configuring High Availability” for details on ACE HA groups.</p>
Management Settings	
VLAN Id	<p>VLAN number that you want to assign to the management interface. Valid values are from 2 to 4094. The VLAN ID should be available in the allocated VLAN interface list. By default, all devices are assigned to VLAN1, known as the default VLAN.</p> <p> Note You must enter a VLAN ID before the other Management Settings attribute fields are enabled for configuring.</p>
VLAN Description	Description for the management interface. Enter an unquoted text string that contains a maximum of 240 alphanumeric characters including spaces.
Interface Mode	<p>Topology that reflects the relationship of the selected ACE virtual context to the real servers in the network:</p> <ul style="list-style-type: none"> Routed—The ACE virtual context acts as a router between the client-side network and the server-side network. In this topology, every real server for the application must be routed through the ACE virtual context, either by setting the default gateway on each real server to the virtual context server-side VLAN interface address, or by using a separate router with appropriate routes configured between the ACE virtual context and the real servers. Bridged—The virtual ACE bridges two VLANs—a client-side VLAN and a real-server VLAN—on the same subnet using a bridged virtual interface (BVI). The real server routing does not change to accommodate the ACE virtual context. Instead the virtual ACE transparently handles traffic to and from the real servers.
Management IP	<p>IPv4 address that is to be used for remote management of the context.</p> <p>Note ANM considers an interface as a management interface if it has a management policy map associated with the VLAN interface. See the “Configuring Virtual Context VLAN Interfaces” section on page 12-6.</p>
Management Netmask	Subnet mask to apply to this IP address.
Alias IP Address	IP address of the alias this interface is associated with.
Peer IP Address	IP address of the remote peer.

Table 6-1 Virtual Context Configuration Attributes (continued)

Field	Description
Access Permission	<p>List of source IP addresses that are allowed on the management interface:</p> <ul style="list-style-type: none">• Allow All—Allows all configured client source IP addresses on the management interface as the network traffic matching criteria.• Deny All—Denies all configured client source IP addresses on the management interface as the network traffic matching criteria.• Match—Displays the Match Conditions table, where you specify the match criteria that the ACE is to use for traffic on the management interface.

Table 6-1 Virtual Context Configuration Attributes (continued)

Field	Description
Match Conditions	<p>Match Conditions table that appears when you choose Match as the Access Permission selection.</p> <p>To add or modify the protocols allowed on this management VLAN, do the following:</p> <ol style="list-style-type: none"> 1. Click Add to choose a protocol for the management interface, or choose an existing protocol entry listed in the Match Conditions table and click Edit to modify it. 2. In the Protocol drop-down list, choose a protocol: <ul style="list-style-type: none"> – HTTP—Specifies the Hypertext Transfer Protocol (HTTP). – HTTPS—Specifies the secure (SSL) Hypertext Transfer Protocol (HTTP) for connectivity with the ANM interface using port 443. – ICMP— Specifies the Internet Control Message Protocol (ICMP) for Internet Protocol version 4 (IPv4). – ICMPv6—Option that appears only for ACE module and ACE appliance software Version A5(1.0) or later. Specifies the Internet Control Message Protocol version 6 (ICMPv6) for Internet Protocol version 6 (IPv6). – – KALAP-UDP—Specifies the Keepalive Appliance Protocol over UDP. – SNMP—Specifies the Simple Network Management Protocol (SNMP). <p> Note If SNMP is not selected, ANM will not be able to poll the context.</p> <ul style="list-style-type: none"> – SSH—Specifies a Secure Shell (SSH) connection to the ACE. – TELNET—Specifies a Telnet connection to the ACE. – XML-HTTPS—Specifies HTTPS as the transfer protocol for sending and receiving XML documents between the ACE appliance and a Network Management System (NMS) using port 10443. This option is available for ACE appliances only. <ol style="list-style-type: none"> 3. In the Allowed From field, specify the matching criteria for the client source IP address: <ul style="list-style-type: none"> – Any—Specifies any client source address for the management traffic classification. – Source Address—Specifies a client source host IP address and subnet mask as the network traffic matching criteria. An ICMPv6 source address only accepts an IPv6 address. IPv6 requires ACE module and ACE appliance software Version A5(1.0) or later. – Source Netmask—Select a subnet mask. This field is not applicable for ICMPv6. – Source Prefix Length—(ICMPv6 only) Enter the prefix length, a value from 1 to 128. 4. Click OK to accept the protocol selection (or click Cancel to exit without accepting your entries). <p>Note To remove a protocol from the management VLAN, choose the entry in the Match Conditions table, and click Delete.</p>
Enable SNMP Get	Check box that you can check to add an SNMP Get community string to enable SNMP polling on this context.

Table 6-1 Virtual Context Configuration Attributes (continued)

Field	Description
SNMP v2c Read-Only Community String	Field that appears when you check the Enable SNMP Get check box. Enter the SNMPv2c read-only community string to be used as the SNMP Get community string.
Enable SNMP Trap	Check box that you can check to add an SNMP community string for ANM to receive traps from this context.
SNMP Community	Field that appears when you check the Enable SNMP Trap check box. Enter the SNMP version 1 or 2c read-only community string or the SNMP version 3 user name that is to be used as the SNMP trap.
Enable Syslog Notification	Check box that you can check to enable syslog logging or uncheck to disable syslog logging.
Add Admin User	Check box that you can check to add a user with an administrator role and default-domain access.
User Name	Field that appears when you check the Add Admin User check box. Specifies the name by which the user is to be identified (up to 24 characters). Only letters, numbers, and underscore can be used. The field is case sensitive.
Password	Field that appears when you check the Add Admin User check box. Enter the password for the Admin user account.
Confirm Password	Field that appears when you check the Add Admin User check box. Reenter the password for the Admin user account.
More Settings	
Switch Mode	Feature that applies only to the ACE module A2(1.1), ACE appliance A4(1.0), or later releases of either device type. Choose Switch Mode to change the way that the ACE processes TCP connections that are not destined to a VIP or that do not have any policies associated with their traffic. For such traffic, the ACE still creates connection objects, but processes the connections as stateless connections, which means that they do not undergo any TCP normalization checks. With this option enabled, the ACE also creates stateless connections for non-SYN TCP packets if they satisfy all other configured requirements. This process ensures that a long-lived persistent connection passes through the ACE successfully (even if it times out) by being reestablished by any incoming packet related to the connection. By default, these stateless connections time out after 2 hours and 15 minutes unless you configure the inactivity timeout otherwise in a parameter map. When a stateless connection times out, the ACE does not send a TCP RST packet but silently closes the connection. Even though these connections are stateless, the TCP RST and FIN-ACK flags are honored and the connections are closed when the ACE sees these flags in the received packets.
Building Block To Apply	Configuration building block to apply to this context.

Step 4 Do one of the following:

- Click **Deploy Now** to deploy this context and save this configuration to the running-configuration and startup-configuration files. The window refreshes and you can continue with virtual context configuration (see the “[Configuring Virtual Contexts](#)” section on page 6-8).
- Click **Cancel** to exit this procedure without saving your entries. The Virtual Contexts table appears.

Related Topics

- [Information About Virtual Contexts, page 6-2](#)
- [Configuring Virtual Contexts, page 6-8](#)

Configuring Virtual Contexts

After creating a virtual context, you can configure it. Configuring a virtual context involves configuring a number of attributes, grouped into *configuration subsets*.

The options that appear when you choose Config > Devices > *context* depend on the following:

- Type of ACE device associated with the context: ACE module or ACE appliance.
- Role associated with your account, such as Admin, Network-Admin, or SSL-Admin.
- Context that you are configuring; an Admin context or a user context.

[Table 6-2](#) describes configuration options for Admin contexts for ACE modules and ACE appliances although not all options are available for both types of devices.

[Table 6-3](#) identifies the configuration options that are available for each ACE device type.

**Note**

You cannot modify a virtual context when its CLI Sync Status is in the *Import Failed* state. You must synchronize the context before you can make changes to it. You can view CLI Sync Status and synchronize contexts from the Virtual Contexts table (Config > Devices > *ACE*).

Table 6-2 Virtual Context Configuration Options

Configuration Subset	Description	Related Topics
System	<p>The System configuration subset includes the following:</p> <ul style="list-style-type: none"> • Primary attributes such as building block, resource class, and VLAN options • Syslog attributes that allow you to identify the type and severity of syslog messages that are to be logged, the syslog log host, log messages, and log rate limits • SNMP attributes • Global policy maps for all VLANs on a virtual context • ACE license attributes that allow you to view, install, remove, update, and copy licenses for ACE hardware • Resource classes that allow you to manage virtual context access to individual ACE devices • Checkpoint (snapshot in time) of a known stable running configuration • Back up or restore the configuration and dependencies of an entire ACE or of a particular virtual context <p>Note ACE licenses and resource classes can be configured in an Admin context only.</p>	<ul style="list-style-type: none"> • Configuring Virtual Context Primary Attributes, page 6-14 • Configuring Virtual Context Syslog Settings, page 6-19 • Configuring SNMP for Virtual Contexts, page 6-27 • Applying a Policy Map Globally to All VLAN Interfaces, page 6-35 • Managing ACE Licenses, page 6-36 • Using Resource Classes, page 6-43 • Using the Configuration Checkpoint and Rollback Service, page 6-54 • Performing Device Backup and Restore Functions, page 6-59 • Performing Global Device Backup and Copy Functions, page 6-68
Load Balancing	<p>Load-balancing attributes allow you to do the following:</p> <ul style="list-style-type: none"> • Configure virtual servers, real servers, and server farms for load balancing • Establish the predictor method and return code checking • Implement sticky groups for session persistence • Configure parameter maps to combine related actions for policy maps • Configure NAT so that only one address for the entire network to the outside world is advertised • Configure a secure keepalive-appliance protocol (KAL-AP) associated with a virtual context to enable communication between the ACE and a Global Site Selector (GSS) 	<ul style="list-style-type: none"> • Information About Load Balancing, page 7-1 • Configuring Virtual Servers, page 7-2 • Configuring Server Farms, page 8-30 • Configuring Health Monitoring for Real Servers, page 8-51 • Configuring Sticky Groups, page 9-7 • Configuring Parameter Maps, page 10-1 • Configuring VLAN Interface NAT Pools, page 12-26 • Configuring Secure KAL-AP, page 8-77

Table 6-2 Virtual Context Configuration Options (continued)

Configuration Subset	Description	Related Topics
SSL	<p>Secure Sockets Layer (SSL) configuration options allow you to import and export SSL certificates and keys, set up SSL parameter maps and chain group parameters, generate certificate signing requests for submission to a certificate authority, authenticate peer certificates, and configure certificate revocation lists for use during client authentication.</p> <p>Note You cannot configure all SSL options in a building block. Instead, configure them in an Admin virtual context.</p>	<ul style="list-style-type: none"> • Configuring SSL, page 11-1 • Using SSL Certificates, page 11-5 • Using SSL Keys, page 11-10 • Generating CSRs, page 11-26 • Configuring SSL Parameter Maps, page 11-18 • Configuring SSL Chain Group Parameters, page 11-23 • Configuring SSL Proxy Service, page 11-27 • Configuring SSL Authentication Groups, page 11-31 • Configuring CRLs for Client Authentication, page 11-33
Security	<p>Security configuration options enable you to create access control lists, set access control list (ACL) attributes, resequence ACLs, delete ACLs, and configure object groups.</p>	<ul style="list-style-type: none"> • Configuring Security with ACLs, page 6-78 • Creating ACLs, page 6-79 • Configuring Object Groups, page 6-89
Network	<p>Network configuration options allow you to configure the following:</p> <ul style="list-style-type: none"> • VLAN interfaces • Bridged-group virtual interfaces (BVI) • Network Address Translation (NAT) pools for a VLAN interface • Static routes • Dynamic host configuration protocol (DHCP) relay agents • Port channel interfaces • Gigabit Ethernet interfaces • Over 8,000 static network address translation (NAT) configurations 	<ul style="list-style-type: none"> • Configuring Virtual Context VLAN Interfaces, page 12-6 • Configuring Virtual Context BVI Interfaces, page 12-19 • Configuring VLAN Interface NAT Pools, page 12-26 • Configuring Virtual Context Static Routes, page 12-28 • Configuring Virtual Context BVI Interfaces, page 12-19 • Configuring Port-Channel Interfaces for the ACE Appliance, page 12-35 • Configuring Gigabit Ethernet Interfaces on the ACE Appliance, page 12-32 • Configuring Static VLANs for Over 8000 Static NAT Configurations, page 12-31
High Availability	<p>High availability (HA) attributes allow you to configure two ACE devices for fault-tolerant redundancy and the tracking and detection of failures for timely switchover.</p> <p>Note You can set up high availability in an Admin context only.</p>	<ul style="list-style-type: none"> • Configuring ACE High Availability, page 13-14 • Configuring ACE High Availability Peers, page 13-15 • Configuring ACE High Availability Groups, page 13-17

Table 6-2 Virtual Context Configuration Options (continued)

Configuration Subset	Description	Related Topics
HA Tracking and Failure Detection	HA tracking and failure detection attributes allow you to configure tracking processes that can help ensure reliable fault tolerance.	<ul style="list-style-type: none"> • ACE High Availability Tracking and Failure Detection Overview, page 13-23 • Tracking ACE VLAN Interfaces for High Availability, page 13-24 • Tracking Hosts for High Availability, page 13-25 • Configuring ACE HSRP Groups, page 13-29
Role-Based Access Control	<p>Role-based access control (RBAC) attributes allow you to configure RBAC for individual virtual contexts.</p> <p>Note Virtual context RBAC is separate from ANM RBAC. For information about ANM RBAC, see the “How ANM Handles Role-Based Access Control” section on page 18-8.</p>	<ul style="list-style-type: none"> • Configuring Device RBAC Users, page 5-53 • Configuring Device RBAC Roles, page 5-56 • Configuring Device RBAC Domains, page 5-61
Expert	Expert attributes allow you to configure traffic policies and configure optimization action lists.	<ul style="list-style-type: none"> • Configuring Virtual Context Class Maps, page 14-6 • Configuring Virtual Context Policy Maps, page 14-32 • Configuring an HTTP Optimization Action List, page 15-3

Table 6-3 Configuration Options by Device Type

Menu Option	ACE Device Type		Related Topic
	ACE Module	ACE 4710 Appliance	
System			
Primary Attributes	X	X	Configuring Virtual Context Primary Attributes , page 6-14
Syslog	X	X	Configuring Virtual Context Syslog Settings , page 6-19
SNMP	X	X	Configuring SNMP for Virtual Contexts , page 6-27
Global Policies	X	X	Applying a Policy Map Globally to All VLAN Interfaces , page 6-35
Licenses	X	X	Managing ACE Licenses , page 6-36
Application Acceleration and Optimization	–	X	Configuring Global Application Acceleration and Optimization , page 15-9
Resource Classes	X	X	Using Resource Classes , page 6-43
Checkpoints	X	X	Using the Configuration Checkpoint and Rollback Service , page 6-54
Backup/Restore	X	X	Performing Device Backup and Restore Functions , page 6-59

Table 6-3 Configuration Options by Device Type (continued)

Menu Option	ACE Device Type		Related Topic
	ACE Module	ACE 4710 Appliance	
Load Balancing			
Virtual Servers	X	X	Configuring Virtual Servers, page 7-2
Real Servers	X	X	Configuring Real Servers, page 8-5
Server Farms	X	X	Configuring Server Farms, page 8-30
Health Monitoring	X	X	Configuring Health Monitoring for Real Servers, page 8-51
Stickiness	X	X	Configuring Sticky Groups, page 9-7
HTTP Parameter Maps	X	X	Configuring HTTP Parameter Maps, page 10-9
Connection Parameter Maps	X	X	Configuring Connection Parameter Maps, page 10-3
Optimization Parameter Maps	–	X	Configuring Optimization Parameter Maps, page 10-12
Generic Parameter Maps	X	X	Configuring Generic Parameter Maps, page 10-8
RTSP Parameter Maps	X	X	Configuring RTSP Parameter Maps, page 10-20
SIP Parameter Maps	X	X	Configuring SIP Parameter Maps, page 10-21
Skinny Parameter Maps	X	X	Configuring Skinny Parameter Maps, page 10-23
Secure KAL-AP	X	X	Configuring Secure KAL-AP, page 8-77
SSL			
Setup Sequence	X	X	SSL Setup Sequence, page 11-4
Certificates	X	X	Using SSL Certificates, page 11-5
Keys	X	X	Using SSL Keys, page 11-10
Parameter Map	X	X	Configuring SSL Parameter Maps, page 11-18
Chain Group Parameters	X	X	Configuring SSL Chain Group Parameters, page 11-23
CSR Parameters	X	X	Configuring SSL CSR Parameters, page 11-24
Proxy Service	X	X	Configuring SSL Proxy Service, page 11-27
Auth Group Parameters	X	X	Configuring SSL Authentication Groups, page 11-31
Certificate Revocation Lists (CRLs)	X	X	Configuring CRLs for Client Authentication, page 11-33
Security			
ACLs	X	X	Creating ACLs, page 6-79
Object Groups	X	X	Configuring Object Groups, page 6-89
Network			
Port Channel Interfaces	–	X	Configuring Port-Channel Interfaces for the ACE Appliance, page 12-35
Gigabit Ethernet Interfaces	–	X	Configuring Gigabit Ethernet Interfaces on the ACE Appliance, page 12-32
VLAN Interfaces	X	X	Configuring Virtual Context VLAN Interfaces, page 12-6
BVI Interfaces	X	X	Configuring Virtual Context BVI Interfaces, page 12-19

Table 6-3 Configuration Options by Device Type (continued)

Menu Option	ACE Device Type		Related Topic
	ACE Module	ACE 4710 Appliance	
NAT Pools	X	X	Configuring VLAN Interface NAT Pools, page 12-26
Static Routes	X	X	Configuring Virtual Context Static Routes, page 12-28
Global IP DHCP	X	X	Configuring Global IP DHCP, page 12-29
Static NAT Overwrite	X	–	Configuring Static VLANs for Over 8000 Static NAT Configurations, page 12-31
NAT Pools	X	X	Configuring VLAN Interface NAT Pools, page 12-26
High Availability			
Setup	X	X	Configuring ACE High Availability Peers, page 13-15
HA Tracking And Failure Detection			
Interfaces	X	X	Tracking ACE VLAN Interfaces for High Availability, page 13-24
Hosts	X	X	Tracking Hosts for High Availability, page 13-25
HSRP Groups	X	X	Configuring ACE HSRP Groups, page 13-29
Role-Based Access Control			
Users	X	X	Configuring Device RBAC Users, page 5-53
Roles	X	X	Configuring Device RBAC Roles, page 5-56
Domains	X	X	Configuring Device RBAC Domains, page 5-61
Expert			
Class Maps	X	X	Configuring Virtual Context Class Maps, page 14-6
Policy Maps	X	X	Configuring Virtual Context Policy Maps, page 14-32
Action List	X	X	Configuring an HTTP Header Modify Action List, page 14-85 Configuring an HTTP Optimization Action List, page 15-3

Configuring Virtual Context System Attributes

This section shows how to configure the ACE virtual context system attributes, which are as follows:

- Virtual context primary attributes—See [Configuring Virtual Context Primary Attributes, page 6-14](#).
- Syslog
 - [Configuring Virtual Context Syslog Settings, page 6-19](#)
 - [Configuring Syslog Log Hosts, page 6-23](#)
 - [Configuring Syslog Log Messages, page 6-24](#)
 - [Configuring Syslog Log Rate Limits, page 6-26](#)
- SNMP
 - [Configuring SNMP for Virtual Contexts, page 6-27](#)
 - [Configuring SNMPv2c Communities, page 6-28](#)

- [Configuring SNMPv3 Users](#), page 6-29
- [Configuring SNMP Trap Destination Hosts](#), page 6-32
- [Configuring SNMP Notification](#), page 6-33
- Global policy maps for all VLANs on a virtual context—See [Applying a Policy Map Globally to All VLAN Interfaces](#), page 6-35.
- ACE licenses—See [Managing ACE Licenses](#), page 6-36.
- ACE resource classes—See [Using Resource Classes](#), page 6-43.

For ACE appliances, you can also configure global application acceleration and optimization. See the “[Configuring Global Application Acceleration and Optimization](#)” section on page 15-9.

Configuring Virtual Context Primary Attributes

Primary attributes allow you to configure essential information for each virtual context including a name, VLANs, a management IP address, and allowed protocols. After providing this information, you can configure other attributes, such as interfaces, load-balancing, or SSL. For a complete list of the configurable items, see the “[Configuring Virtual Contexts](#)” section on page 6-8.

Procedure

Step 1 Choose **Config > Devices > context > System > Primary Attributes**.

The Primary Attributes configuration window appears.

Step 2 In the Primary Attributes configuration window, enter the primary attributes for this virtual context using the information in [Table 6-4](#).

Certain attribute fields are read-only for existing contexts.

Click **Basic Settings**, **Management Settings**, or **More Setting** to access the additional configuration attributes. By default, ANM hides these groups of configuration attributes.



Note Fields and information related to IPv6 require ACE module and ACE appliance software Version A5(1.0) or later.

Table 6-4 Primary Attributes Configuration Attributes

Field	Description
Basic Settings	
Name	Unique name for the virtual context. This field is read-only for existing contexts.
Description	Brief description of the virtual context. Enter a description as an unquoted text string with a maximum of 240 alphanumeric characters.
Resource Class	Resource class that this virtual context is to use. Click View to see the details of the selected resource class (Resource, Minimum, and Maximum).

Table 6-4 Primary Attributes Configuration Attributes (continued)

Field	Description
Allocated VLANs	<p>Number of a VLAN or a range of VLANs that contain traffic for the context to receive. You can specify VLANs in any of the following ways:</p> <ul style="list-style-type: none"> For a single VLAN, enter an integer from 2 to 4096. For multiple, nonsequential VLANs, use comma-separated entries, such as 101, 201, 302. For a range of VLANs, use the format <i><beginning-VLAN>-<ending-VLAN></i>, such as 101-150. <p>Note VLANs cannot be modified in an Admin context.</p> <p>This field is read-only if configured for existing contexts.</p>
Default Gateway IP for IPv4	<p>IPv4 address of the default gateway. Use a comma-separated list to specify multiple IP addresses, such as 192.168.65.1, 192.168.64.2.</p> <p>Default static routes with a netmask and IP address of 0.0.0.0 previously configured on the ACE appear in this field.</p>
Default Gateway IP for IPv6	<p>Field that appears only for ACE module and ACE appliance software Version A5(1.0) or later. IPv6 address of the default gateway or choose the forward VLAN interface or BVI, as follows:</p> <ul style="list-style-type: none"> IPv6 Address field—Enter the address of the gateway router (the next-hop address for this route). Then, use the right arrow to move it to the Selected field. You can enter a maximum of eight addresses including a selected VLAN or BVI through the Outgoing Interfaces setting. <p>Default static routes with a prefix and IP address of ::0 previously configured on the ACE appear in the Selected field.</p> <ul style="list-style-type: none"> Outgoing Interfaces—Select either VLAN or BVI used for the link-local address only. And then select the Interface Number for the VLAN or BVI.
Enable High Availability	<p>Context for use in a high availability (HA) group.</p> <p>Note This field is unavailable if the associated FT interface is not configured or if the ACE peer is not known. See Chapter 13, “Configuring High Availability” for details on ACE HA groups.</p>
Management Settings	
VLAN Id	<p>VLAN number that you want to assign to the management interface. Valid values are from 2 to 4094. By default, all devices are assigned to VLAN1, known as the default VLAN.</p> <p>ANM identifies the management class maps and policy maps associated with the selected VLAN ID assigned to the management interface.</p> <p>This field is read-only if configured for existing contexts.</p>
VLAN Description	<p>Description for the management interface. Enter an unquoted text string that contains a maximum of 240 alphanumeric characters including spaces.</p>

Table 6-4 Primary Attributes Configuration Attributes (continued)

Field	Description
Interface Mode	<p>Topology that reflects the relationship of the selected ACE virtual context to the real servers in the network:</p> <ul style="list-style-type: none"> • Routed—The ACE virtual context acts as a router between the client-side network and the server-side network. In this topology, every real server for the application must be routed through the ACE virtual context, either by setting the default gateway on each real server to the virtual context server-side VLAN interface address, or by using a separate router with appropriate routes configured between the ACE virtual context and the real servers. • Bridged—The virtual ACE bridges two VLANs—a client-side VLAN and a real-server VLAN—on the same subnet using a bridged virtual interface (BVI). In this case, the real server routing does not change to accommodate the ACE virtual context. Instead, the virtual ACE transparently handles traffic to and from the real servers. <p>This field is read-only if configured for existing contexts.</p>
Management IP	<p>IPv4 address that is to be used for remote management of the context.</p> <p>Note ANM considers an interface as a management interface if it has a management policy map associated with the VLAN interface. See the “Configuring Virtual Context VLAN Interfaces” section on page 12-6.</p>
Management Netmask	Subnet mask to apply to this IP address.
Alias IP Address	IP address of the alias this interface is associated with.
Peer IP Address	IP address of the remote peer.
Access Permission	<p>List of source IP addresses that are allowed on the management interface:</p> <ul style="list-style-type: none"> • Allow All—Allows all configured client source IP addresses on the management interface as the network traffic matching criteria. • Deny All—Denies all configured client source IP addresses on the management interface as the network traffic matching criteria. • Match—Displays the Match Conditions table, where you specify the match criteria that the ACE is to use for traffic on the management interface.

Table 6-4 Primary Attributes Configuration Attributes (continued)

Field	Description
Match Conditions	<p>Match Conditions table that appears when you choose Match as the Access Permission selection.</p> <p>To add or modify the protocols allowed on this management VLAN, do the following:</p> <ol style="list-style-type: none"> Click Add to choose a protocol for the management interface, or choose an existing protocol entry listed in the Match Conditions table and click Edit to modify it. In the Protocol drop-down list, choose a protocol: <ul style="list-style-type: none"> HTTP—Specifies the Hypertext Transfer Protocol (HTTP). HTTPS—Specifies the secure (SSL) Hypertext Transfer Protocol (HTTP) for connectivity with the ANM interface using port 443. ICMP—Specifies the Internet Control Message Protocol (ICMP) for Internet Protocol version 4 (IPv4) ICMPv6—Option that appears only for ACE module and ACE appliance software Version A5(1.0) or later. Specifies the Internet Control Message Protocol version 6 (ICMPv6) for Internet Protocol version 6 (IPv6). KALAP-UDP—Specifies the Keepalive Appliance Protocol over UDP. SNMP—Specifies the Simple Network Management Protocol (SNMP). <p> Note If SNMP is not selected, ANM cannot poll the context.</p> <ul style="list-style-type: none"> SSH—Specifies a Secure Shell (SSH) connection to the ACE. TELNET—Specifies a Telnet connection to the ACE. XML-HTTPS—Specifies HTTPS as the transfer protocol for sending and receiving XML documents between the ACE appliance and a Network Management System (NMS) using port 10443. This option is available for ACE appliances only. <ol style="list-style-type: none"> In the Allowed From field, specify the matching criteria for the client source IP address: <ul style="list-style-type: none"> Any—Specifies any client source address for the management traffic classification. Source Address—Specifies a client source host IP address and subnet mask as the network traffic matching criteria. Click OK to accept the protocol selection (or click Cancel to exit without accepting your entries). <p>Note To remove a protocol from the management VLAN, choose the entry in the Match Conditions table, and click Delete.</p>
Enable SNMP Get	<p>Check box to add an SNMP Get community string to enable SNMP polling on this context. This field is read-only if configured for existing contexts.</p>
SNMP v2c Read-Only Community String	<p>Field that appears when you check the Enable SNMP Get check box.</p> <p>Enter the SNMPv2c read-only community string to be used as the SNMP Get community string.</p> <p>This field is read-only if configured for existing contexts.</p>

Table 6-4 Primary Attributes Configuration Attributes (continued)

Field	Description
Enable SNMP Trap	Check box to add an SNMP community string for ANM to receive traps from this context. This field is read-only if configured for existing contexts.
SNMP Community	Field that appears when you check the Enable SNMP Trap check box. Enter the SNMPv1 or SNMPv2c read-only community string or the SNMPv3 user name that is to be used as the SNMP trap. This field is read-only if configured for existing contexts.
Enable Syslog Notification	Check box to either enable or disable syslog logging.
More Settings	
Switch Mode	Feature that applies only to the ACE module A2(1.1), ACE appliance A4(1.0), or later releases of either device type. Choose Switch Mode to change the way that the ACE processes TCP connections that are not destined to a VIP or that do not have any policies associated with their traffic. For such traffic, the ACE still creates connection objects but processes the connections as stateless connections, which means that they do not undergo any TCP normalization checks. With this option enabled, the ACE also creates stateless connections for non-SYN TCP packets if they satisfy all other configured requirements. This process ensures that a long-lived persistent connection passes through the ACE successfully (even if it times out) by being reestablished by any incoming packet related to the connection. By default, these stateless connections time out after 2 hours and 15 minutes unless you configure the inactivity timeout otherwise in a parameter map. When a stateless connection times out, the ACE does not send a TCP RST packet but silently closes the connection. Even though these connections are stateless, the TCP RST and FIN-ACK flags are honored and the connections are closed when the ACE sees these flags in the received packets.
Shared VLAN Host Id	Field that is available in the Admin context only. Specific bank of MAC addresses that the ACE uses. Enter a number from 1 to 16. Be sure to configure different bank numbers for multiple ACEs.
Regex Compilation Timeout (minutes)	Timeout setting for regular expression (regex) compilation. When you configure a regex and its compilation is longer than the configured timeout, the ACE stops the regex compilation. Enter a value from 1 to 500 minutes. The default timeout is 60 minutes. This option is available only in the Admin context.
Building Block To Apply	Configuration building block to apply to this context. For information about building blocks, see Chapter 16, "Using Configuration Building Blocks."

- Step 3** Click **Deploy Now** to deploy this configuration on the ACE and save your entries to the running-configuration and startup-configuration files. You return to the Virtual Contexts table.

Related Topics

- [Information About Virtual Contexts, page 6-2](#)
- [Configuring Virtual Context VLAN Interfaces, page 12-6](#)
- [Configuring Virtual Context BVI Interfaces, page 12-19](#)
- [Configuring Virtual Context Syslog Settings, page 6-19](#)
- [Configuring Traffic Policies, page 14-1](#)

Configuring Virtual Context Syslog Settings

ANM uses syslog logging to send log messages to a process that logs messages to designated locations asynchronously to the processes that generated the messages.

Procedure

- Step 1** Choose the item to configure:
- To configure a virtual context, choose **Config > Devices > context > System > Syslog**.
 - To configure a configuration building block, choose **Config > Global > All Building Blocks > building_block > System > Syslog**.
- The Syslog configuration window appears.
- Step 2** In the Syslog configuration window, enter the syslog logging attributes in the displayed fields (see [Table 6-6](#)).
- All fields that require you to choose syslog severity levels use the values in [Table 6-5](#).

Table 6-5 Syslog Logging Levels

Severity	Description
0-Emergency	Unusable system
1-Critical	Critical condition
2-Warning	Warning condition
3-Alert	Immediate action required
4-Error	Error condition
5-Notification	Normal but significant condition
6-Information	Informational message only
7-Debug	Appears only during debugging

The severity level that you specify indicates that you want syslog messages at that level and the more severe levels. For example, if you specify Error, syslog displays Error, Critical, Alert, and Emergency messages.



Note Setting all syslog levels to Debug during normal operations can degrade overall performance.

Table 6-6 Virtual Context Syslog Configuration Attributes

Field	Description	Action
Enable Syslog	Option that determines whether syslog logging is enabled or disabled.	Check the check box to enable syslog logging or clear the check box to disable syslog logging.
Facility	Syslog daemon that uses the specified syslog facility to determine how to process the messages it receives. Syslog servers file or direct messages based on the facility number in the message. For more information on the syslog daemon and facility levels, see your syslog daemon documentation.	Enter the facility appropriate for your network. Valid entries are 0 (LOCAL0) through 23 (LOCAL7). The default for ACE is 20 (LOCAL4).
Buffered Level	Option that enables system logging to a local buffer and limits the messages sent to the buffer based on severity.	Choose the desired level for sending system log messages to a local buffer. By default, logging to a buffer is disabled on the ACE.
Console Level	Option that specifies the maximum level for system log messages sent to the console.	Choose the desired level for sending system log messages to the console. By default, ACE does not display syslog messages during console sessions. Note Logging to the console can degrade system performance. We recommend that you log messages to the console only when you are testing or debugging problems. Do not use this option when the network is busy, because it can reduce ACE performance.
History Level	Option that specifies the maximum level for system log messages sent as traps to an SNMP network management station.	Choose the desired level for sending system log messages as traps to an SNMP network management station. By default, the ACE does not send traps and inform requests to an SNMP network management station.
Monitor Level	Option that specifies the maximum level for system log messages sent to a remote connection using Secure Shell (SSH) or Telnet on the ACE.	Choose the desired level for sending system log messages to a remote connection using SSH or Telnet on the ACE. By default, logging to a remote connection using SSH or Telnet is disabled on the ACE. Note You must enable remote access on the ACE and establish a remote connection using the SSH or Telnet protocol from a PC for this option to work.

Table 6-6 Virtual Context Syslog Configuration Attributes (continued)

Field	Description	Action
Persistence Level	Option that specifies the maximum level for system log messages sent to Flash memory.	Choose the desired level for sending system log messages to Flash memory. By default, logging to Flash memory is disabled on the ACE. Note We recommend that you use a lower severity level, such as 3, because logging at a high rate to Flash memory on the ACE might impact performance.
Trap Level	Option that specifies the maximum level for system log messages sent to a syslog server.	Choose the desired level for sending system log messages to a syslog server. By default, logging to a syslog server is disabled on the ACE.
Supervisor Level	Option that specifies the maximum level for system log messages sent to the supervisor module on the Catalyst 6500 series chassis. Note This option does not appear for ACE appliances or ACE 4710-type configuration building blocks.	Choose the desired level for sending system log messages to the supervisor module on the Catalyst 6500 series chassis. Note We recommend that you use a lower severity level, such as 3, because logging at a high rate to the supervisor module might impact performance of the Catalyst 6500 series chassis.
Queue Size	Option that specifies the size of the queue for storing syslog messages in the message queue while they await processing.	Enter the desired queue size. Valid entries are from 0 to 8192 messages. The default is 80 messages.
Enable Timestamp	Option that determines whether syslog messages should include the date and time that the message was generated.	Choose the check box to enable time stamps on syslog messages or clear the check box to disable time stamps on syslog messages. By default, time stamps are not included on syslog messages.
Enable Standby	Option that determines whether or not logging is enabled or disabled on the failover standby ACE. When enabled: <ul style="list-style-type: none"> This feature causes twice the message traffic on the syslog server. The standby ACE syslog messages remain synchronized if failover occurs. 	Choose the check box to enable logging on the failover standby ACE or clear the check box to disable logging on the failover standby ACE.
Enable Fastpath Logging	Option that determines whether or not connection setup and teardown messages are logged.	Check the check box to enable the logging of setup and teardown messages or clear the check box to disable the logging of setup and teardown messages. By default, the ACE does not log connection startup and teardown messages.

Table 6-6 Virtual Context Syslog Configuration Attributes (continued)

Field	Description	Action
Reject New Connection When TCP Queue Full	Option that indicates whether or not the ACE rejects new connections when the TCP queue is full.	<p>This option is not applicable to ACE 4710 appliances running image A3(x.x).</p> <p>Check the check box to reject new connections when the syslog daemon can no longer reach the TCP syslog server.</p> <p>Clear the check box to disable this feature.</p> <p>This option is enabled by default.</p>
Reject New Connection When Rate Limit Reached	Option that indicates whether or not the ACE rejects new connections when the syslog message rate is reached.	<p>This option is not applicable to ACE 4710 appliances running image A3(x.x).</p> <p>Check the check box to reject new connections when the syslog message rate is reached.</p> <p>Clear the check box to disable this feature.</p> <p>This option is disabled by default.</p>
Reject New Connection When Control Plane Buffer Full	Option that indicates whether or not the ACE rejects new connections when the syslog daemon buffer is full.	<p>This option is not applicable to ACE 4710 appliances running image A3(x.x).</p> <p>Check the check box to reject new connections when the syslog daemon buffer is full.</p> <p>This option is disabled by default.</p>
Device Id Type	<p>Option that specifies the type of unique device identifier to be included in syslog messages sent to the syslog server.</p> <p>The device identifier does not appear in EMBLEM-formatted messages, SNMP traps, or on the ACE console, management session, or buffer.</p>	<p>Choose the type of device identifier to use:</p> <ul style="list-style-type: none"> • Any String—Text string that you specify to uniquely identify the syslog messages sent from the ACE. If you choose this option, enter the text string to use in the Logging Device Id field. • Context Name—Name of the current virtual context used to uniquely identify the syslog messages sent from the ACE. • Host Name—Hostname of the ACE used to uniquely identify the syslog messages sent from the ACE. • Interface—IP address of the interface used to uniquely identify the syslog messages sent from the ACE. If you choose this option, enter the name of the interface in the Device Interface Name field. • Undefined—No identifier is used.

Table 6-6 Virtual Context Syslog Configuration Attributes (continued)

Field	Description	Action
Device Interface Name	Field that appears when the Device ID Type is Interface. This option specifies the interface to be used to uniquely identify syslog messages sent from the ACE.	Enter the device interface name to use to uniquely identify syslog messages sent from the ACE. Valid entries are 1 to 64 characters with no spaces. Syslog messages sent to an external server contain the IP address of the interface specified, regardless of which interface that the ACE uses to send the log data to the external server.
Logging Device Id	Field that appears when the Device ID Type is Any String. This option specifies the text string to use to uniquely identify syslog messages sent from the ACE.	Enter a text string that uniquely identifies the syslog messages sent from the ACE. The maximum string length is 64 characters without spaces. Do not use the following characters: & (ampersand), ' (single quote), " (double quote), < (less than), > (greater than), or ? (question mark).

Step 3 Do the following:

- For virtual contexts, click **Deploy Now** to deploy this configuration on the ACE and save your entries to the running-configuration and startup-configuration files, or choose another option to exit the procedure without saving your entries.
- For configuration building blocks, click **Save** to save your entries or **Cancel** to exit the procedure without saving your entries.

Related Topics

- [Configuring Syslog Log Hosts, page 6-23](#)
- [Configuring Syslog Log Messages, page 6-24](#)
- [Configuring Syslog Log Rate Limits, page 6-26](#)

Configuring Syslog Log Hosts

You can configure syslog log hosts. After configuring basic syslog characteristics (see the “[Configuring Virtual Context Syslog Settings](#)” section on page 6-19), you can configure the log host, log messages, and log rate limits.

Procedure**Step 1** Choose the item to configure:

- To configure a virtual context, choose **Config > Devices > context > System > Syslog**.
- To configure a configuration building block, choose **Config > Global > All Building Blocks > building_block > System > Syslog**.

The Syslog configuration window appears.

Step 2 In the Syslog configuration window, click the **Log Host** tab.

The Log Host table appears.

Step 3 In the Log Host table, click **Add** to add a new log host, or choose an existing log host, and click **Edit** to modify it.

The New Log Host configuration window appears.

Step 4 In the New Log Host configuration window IP Address field, enter the IP address of the host to use as the syslog server.

Step 5 In the Protocol field, choose TCP or UDP as the protocol to use.

Step 6 In the Protocol Port field, enter the number of the port that the syslog server listens to for syslog messages.

Valid entries are from 1 to 65535. The default port for TCP is 1470 and for UDP it is 514.

Step 7 Check the Default UDP check box, which appears if TCP is selected in the Protocol field ([Step 5](#)), to specify that the ACE is to default to UDP if the TCP transport fails to communicate with the syslog server.

Uncheck this check box to prevent the ACE from defaulting to UDP if the TCP transport fails.

Step 8 In the Format field, choose one of the following:

- **N/A** if you do not want to use EMBLEM-format logging.
- **Emblem** to enable EMBLEM-format logging for each syslog server.

If you use Cisco Resource Manager Essentials (RME) software to collect and process syslog messages on your network, enable EMBLEM-format logging so that RME can handle them.

Similarly, UDP needs to be enabled because the Cisco Resource Manager Essentials (RME) syslog analyzer supports only UDP syslog messages.

Step 9 Do one of the following:

- **Deploy Now** to immediately deploy this configuration on the ACE and save your entries to the running-configuration and startup-configuration files. This option appears for virtual contexts.
- **OK** to save your entry. This option appears for configuration building blocks.
- **Cancel** to exit the procedure without saving your entries and to return to the Log Host table.
- **Next** to configure another syslog host.

Related Topics

- [Configuring Virtual Context Syslog Settings, page 6-19](#)
- [Configuring Syslog Log Messages, page 6-24](#)
- [Configuring Syslog Log Rate Limits, page 6-26](#)

Configuring Syslog Log Messages

You can configure syslog log messages. After configuring basic syslog characteristics (see the [“Configuring Virtual Context Syslog Settings” section on page 6-19](#)), you can configure the log host, log messages, and log rate limits.

Procedure

Step 1 Choose the item to configure:

- To configure a virtual context, choose **Config > Devices > context > System > Syslog**.
- To configure a configuration building block, choose **Config > Global > All Building Blocks > building_block > System > Syslog**.

The Syslog configuration window appears.

Step 2 In the Syslog configuration window, click the **Log Message** tab.

The Log Message table appears.

Step 3 In the Log Message table, click **Add** to add a new entry to this table, or choose an existing entry, and click **Edit** to modify it.

The Log Message configuration window appears.

Step 4 In the Message Id field, choose the system log message ID of the syslog messages that are to be sent to the syslog server or that are not to be sent to the syslog server.

Step 5 Check the **Enable State** check box to enable logging for the specified message ID or uncheck it to disable logging for the specified message ID.

If you check the Enable State check box, the Log Level field appears.

Step 6 In the Log Level field, choose the desired level of syslog messages to be sent to the syslog server, using the levels identified in [Table 6-5](#).

Step 7 Do one of the following:

- Click **Deploy Now** to immediately deploy this configuration on the ACE and save your entries to the running-configuration and startup-configuration files. This option appears for virtual contexts.
- Click **OK** to save your entry. This option appears for configuration building blocks.
- Click **Cancel** to exit the procedure without saving your entries and to return to the Log Message table.
- Click **Next** to deploy your entries and to configure additional syslog message entries for this virtual context.

Related Topics

- [Configuring Virtual Contexts, page 6-8](#)
- [Configuring Virtual Context Syslog Settings, page 6-19](#)
- [Configuring Syslog Log Hosts, page 6-23](#)
- [Configuring Syslog Log Rate Limits, page 6-26](#)

Configuring Syslog Log Rate Limits

You can configure syslog log rate limits after configuring basic syslog characteristics (see the “Configuring Virtual Context Syslog Settings” section on page 6-19).

Procedure

-
- Step 1** Choose the item to configure:
- To configure a virtual context, choose **Config > Devices > context > System > Syslog**.
 - To configure a configuration building block, choose **Config > Global > All Building Blocks > building_block > System > Syslog**.
- The Syslog configuration window appears.
- Step 2** Click the **Log Rate Limit** tab.
- The Log Rate Limit table appears.
- Step 3** In the Log Rate Limit table, click **Add** to add a new entry to this table, or choose an existing entry, and click **Edit** to modify it.
- The Log Rate Limit configuration window appears.
- Step 4** In the Type field of the Log Rate Limit configuration window, choose the method by which syslog messages are to be limited:
- **Level**—Syslog messages are limited by syslog level. In the Level field, choose the level of syslog messages to be sent to the syslog server, using the levels identified in [Table 6-5](#).
 - **Message**—Syslog messages are limited by message identification number. In the Message Id field, choose the syslog message ID for those messages you want to suppress reporting.
- Step 5** Check the **Unlimited** check box to apply no limits to system message logging or uncheck it to apply limits to system message logging.
- If you uncheck the Unlimited check box, the Rate and Time Interval fields appear.
- Step 6** (Optional) If you uncheck the Unlimited check box, specify the limits to apply to system message logging as follows:
- a. In the Rate field, enter the number at which the system log messages are to be limited. When this limit is reached, the ACE rejects new syslog messages. Valid entries are from 0 to 2147483647.
 - b. In the Time Interval (Seconds) field, enter the length of time (in seconds) over which the system message logs are to be limited. For example, if you enter 42 in the Rate field and 60 in the Time Interval field, the ACE rejects any syslog messages that arrive after the first 42 messages in that 60-second period. Valid entries are from 0 to 2147483647 seconds.
- Step 7** Do one of the following:
- Click **Deploy Now** to immediately deploy this configuration on the ACE and save your entries to the running-configuration and startup-configuration files. This option appears for virtual contexts.
 - Click **OK** to save your entry. This option appears for configuration building blocks.
 - Click **Cancel** to exit the procedure without saving your entries and to return to the Log Rate Limit table.
 - Click **Next** to deploy your entries and to add another entry to the Log Rate Limit table.
-

Related Topics

- [Configuring Virtual Contexts, page 6-8](#)
- [Configuring Virtual Context Syslog Settings, page 6-19](#)
- [Configuring Syslog Log Hosts, page 6-23](#)
- [Configuring Syslog Log Messages, page 6-24](#)

Configuring SNMP for Virtual Contexts

This section describes how to configure the SNMP attributes for a virtual context and contains the following topics:

- [Configuring Basic SNMP Attributes, page 6-27](#)
- [Configuring SNMPv2c Communities, page 6-28](#)
- [Configuring SNMPv3 Users, page 6-29](#)
- [Configuring SNMP Trap Destination Hosts, page 6-32](#)
- [Configuring SNMP Notification, page 6-33](#)

Configuring Basic SNMP Attributes

You can configure the basic SNMP attributes for use with a virtual context.

Procedure

-
- Step 1** Choose the item to configure:
- To configure a virtual context, choose **Config > Devices > context > System > SNMP**.
 - To configure a configuration building block, choose **Config > Global > All Building Blocks > building_block > System > SNMP**.
- The SNMP configuration window appears.
- Step 2** In the SNMP configuration window, configure the basic SNMP attributes using the information in [Table 6-7](#).

Table 6-7 *SNMP Attributes*

Field	Description
Contact Information	Contact information for the SNMP server as a text string with a maximum of 240 characters including spaces. In addition to a name, you might want to include a phone number or email address. If spaces are included, add quotation marks at the beginning and end of the entry.
Location	Physical location of the system as a text string with a maximum of 240 characters including spaces. If spaces are included, add quotation marks at the beginning and end of the entry.
Unmask Community	Checkbox that allows you to unmask the snmpCommunityName and snmpCommunitySecurityName OIDs of the SNMP-COMMUNITY-MIB. By default, they are masked (check box is unchecked). Check the checkbox to unmask them.

Table 6-7 SNMP Attributes (continued)

Field	Description
Trap Source Interface	VLAN that identifies the interface from which SNMP traps originate.
IETF Trap	Check box to enable the ACE to send linkUp and linkDown traps with the IETF standard IF-MIB (RFC 2863) variable bindings, consisting of ifIndex, ifAdminStatus, and ifOperStatus. Uncheck the check box to not allow the ACE to send linkUp and linkDown traps with the IETF standard IF-MIB (RFC 2863) variable bindings. Instead, the ACE sends Cisco var-binds by default.

- Step 3** Do one of the following:
- For virtual contexts, click **Deploy Now** to deploy this configuration on the ACE and save your entries to the running-configuration and startup-configuration files, or choose another configuration option to exit the procedure without saving your entries.
 - For configuration building blocks, click **OK** to save your entries or choose another configuration option to exit the procedure without saving your entries.
- Step 4** If you chose Deploy Now in [Step 3](#), configure the SNMP device access credentials as described in the [“Configuring Device Access Credentials”](#) section on page 5-29.

Related Topics

- [Configuring Virtual Contexts, page 6-8](#)
- [Configuring SNMPv2c Communities, page 6-28](#)
- [Configuring SNMPv3 Users, page 6-29](#)
- [Configuring SNMP Trap Destination Hosts, page 6-32](#)
- [Configuring SNMP Notification, page 6-33](#)

Configuring SNMPv2c Communities

You can configure SNMP communities for a virtual context or configuration building block after configuring basic SNMP information for a virtual context (see the [“Configuring Basic SNMP Attributes”](#) section on page 6-27).



Note

All SNMP communities in ANM are read-only communities and all communities belong to the group *network monitors*.

Assumption

You have configured at least one SNMP contact (see the [“Configuring Basic SNMP Attributes”](#) section on page 6-27).

Procedure

- Step 1** Choose the item to configure:
- To configure a virtual context, choose **Config > Devices > context > System > SNMP**.

- To configure a configuration building block, choose **Config > Global > All Building Blocks > building_block > System > SNMP**.

The SNMP configuration window appears.

Step 2 In the SNMP configuration window, click the **SNMPv2c Configuration** tab.

The SNMPv2c Configuration table appears.

Step 3 From the SNMPv2c Configuration table, configure a read-only community string as follows:

- To make “public” the read-only community string, click the associated radio button and click **Deploy Now**. By default, this radio button is selected.
- To create a read-only community string, do the following:
 - a. In the SNMPv2c Configuration table, click **Add** to add an SNMPv2c read-only community string. The New SNMPv2c Configuration window appears.



Note You cannot modify an existing SNMPv2c community string. Instead, delete the existing SNMP v2c community string, and then add a new one.

- b. In the Read-Only Community field of the New SNMPv2c Configuration window, enter the SNMPv2c read-only community name.

Valid entries are unquoted text strings with no spaces and a maximum of 32 characters.

- c. Do one of the following:
 - Click **Deploy Now** to immediately deploy this configuration on the ACE and save your entries to the running-configuration and startup-configuration files. This option appears for virtual contexts.
 - Click **OK** to save your entry. This option appears for configuration building blocks.
 - Click **Cancel** to exit this procedure without saving your entry and to return to the SNMP v2c Community String table.
 - Click **Next** to deploy your entry and to configure another SNMP community string. The window refreshes and you can enter another community string.

Related Topics

- [Configuring Virtual Contexts, page 6-8](#)
- [Configuring Basic SNMP Attributes, page 6-27](#)
- [Configuring SNMPv3 Users, page 6-29](#)
- [Configuring SNMP Trap Destination Hosts, page 6-32](#)
- [Configuring SNMP Notification, page 6-33](#)

Configuring SNMPv3 Users

You can configure SNMP version 3 users for a virtual context or configuration building block after configuring basic SNMP information for a virtual context (see the “[Configuring Basic SNMP Attributes](#)” section on page 6-27).

Assumption

You have configured at least one SNMP contact (see the “[Configuring Basic SNMP Attributes](#)” section on page 6-27).

Procedure

-
- Step 1** Choose the item to configure:
- To configure a virtual context, choose **Config > Devices > context > System > SNMP**.
 - To configure a configuration building block, choose **Config > Global > All Building Blocks > building_block > System > SNMP**.
- The SNMP configuration window appears.
- Step 2** In the SNMP configuration window, click the **SNMPv3 Configuration** tab.
- The SNMP v3 Configuration table appears.
- Step 3** In the SNMP v3 Configuration table, click **Add** to add users, or choose an existing entry in the SNMPv3 Configuration table, and click **Edit** to modify it.
- The SNMP v3 Configuration window appears.
- Step 4** In the SNMP v3 Configuration window, enter SNMP user attributes using the information in [Table 6-8](#).

Table 6-8 *SNMP User Configuration Attributes*

Field	Description
User Name	SNMP username. Valid entries are unquoted text strings with no spaces and a maximum of 24 characters.
Authentication Algorithm	Authentication algorithm to be used for this user: <ul style="list-style-type: none"> N/A—No authentication algorithm is used. Message Digest 5 (MD5)—Message Digest 5 is used as the authentication mechanism. Secure Hash Algorithm (SHA)—Secure Hash Algorithm is used as the authentication mechanism.
Authentication Password	Field that appears if you choose an authentication algorithm. Enter the authentication password for this user. Valid entries are unquoted text strings with no spaces. This password can have a minimum of 8 characters. If use of a localized key is disabled or N/A, you can enter a maximum of 64 characters. If use of a localized key is enabled, you can enter a maximum of 130 characters. The ACE automatically updates the password for the CLI user with the SNMP authentication password.
Confirm	Field that appears if you choose an authentication algorithm. Reenter the authentication password.
Localized	Field that appears if you choose an authentication algorithm. Specify whether or not the password is in localized key format for security encryption: <ul style="list-style-type: none"> N/A—This option is not configured. False—The password is not in localized key format for encryption. True—The password is in localized key format for encryption.

Table 6-8 *SNMP User Configuration Attributes (continued)*

Field	Description
Privacy	Field that appears if you choose an authentication algorithm. Specify whether or not encryption attributes are to be configured for this user: <ul style="list-style-type: none"> • N/A—This option is not configured. • False—Encryption parameters are not to be configured for this user. • True—Encryption parameters are to be configured for this user.
AES 128	Field that appears if you set Privacy to True. Indicate whether the 128-byte Advanced Encryption standard (AES) algorithm is to be used for privacy. AES is a symmetric cipher algorithm and is one of the privacy protocols for SNMP message encryption. Choices are as follows: <ul style="list-style-type: none"> • N/A—This option is not configured. • False—AES 128 is not used for privacy. • True—AES 128 is used for privacy.
Privacy Password	Field that appears if you set Privacy to True. Enter the user encryption password. This password can have a minimum of 8 characters. If the passphrases are specified in clear text, you can enter a maximum of 64 characters. If use of a localized key is enabled, you can enter a maximum of 130 characters. Spaces are not allowed.
Confirm	Field that appears if you set Privacy to True. Reenter the privacy password.

Step 5 Do one of the following:

- Click **Deploy Now** to immediately deploy this configuration on the ACE and save your entries to the running-configuration and startup-configuration files. This option appears for virtual contexts.
- Click **OK** to save your entries. This option appears for configuration building blocks.
- Click **Cancel** to exit this procedure without saving your entries and to return to the SNMP v3 Configuration table.
- Click **Next** to deploy your entries and to add another entry to the SNMP v3 Configuration table. The window refreshes and you can enter another SNMP v3 user.

Related Topics

- [Configuring Virtual Contexts, page 6-8](#)
- [Configuring Basic SNMP Attributes, page 6-27](#)
- [Configuring SNMPv2c Communities, page 6-28](#)
- [Configuring SNMP Trap Destination Hosts, page 6-32](#)
- [Configuring SNMP Notification, page 6-33](#)

Configuring SNMP Trap Destination Hosts

You can configure SNMP trap destination hosts for a virtual context after configuring basic SNMP information for a virtual context (see the “[Configuring Basic SNMP Attributes](#)” section on page 6-27).

To receive SNMP notifications you must configure the following attributes:

- At least one SNMP trap destination host.
- At least one type of notification (see the “[Configuring SNMP Notification](#)” section on page 6-33).

Assumption

You have configured at least one SNMP contact (see the “[Configuring Basic SNMP Attributes](#)” section on page 6-27).

Procedure

-
- Step 1** Choose the item to configure:
- To configure a virtual context, choose **Config > Devices > context > System > SNMP**.
 - To configure a configuration building block, choose **Config > Global > All Building Blocks > building_block > System > SNMP**.
- The SNMP configuration window appears.
- Step 2** In the SNMP configuration window, click the **Trap Destination Host** tab.
- The Trap Destination Host table appears.
- Step 3** In the Trap Destination Host table, click **Add** to add a host, or choose an existing entry in the table, and **Edit** to modify it.
- The Trap Destination Host configuration window appears.
- Step 4** In the IP Address field of the Trap Destination Host configuration window, enter the IP address of the server that is to receive SNMP notifications.
- Enter the address in dotted-decimal format, such as 192.168.11.1.
- Step 5** In the Port field, enter the port to use.
- The default port is 162.
- Step 6** In the Version field, choose the version of SNMP used to send traps:
- **V1**—SNMPv1 is used to send traps. This option is not available for use with SNMP inform requests.
 - **V2c**—SNMPv2c is used to send traps.
 - **V3**—SNMPv3 is used to send traps. This version is the most secure model because it allows packet encryption.
- Step 7** In the Community field, enter the SNMP community string or username to be sent with the notification operation.
- Valid entries are unquoted text strings with no spaces and a maximum of 32 characters.
- Step 8** Do one of the following:
- Click **Deploy Now** to immediately deploy this configuration on the ACE and save your entries to the running-configuration and startup-configuration files. This option appears for virtual contexts.
 - Click **OK** to save your entries. This option appears for configuration building blocks.

- Click **Cancel** to exit this procedure without saving your entries and to return to the Trap Destination Host table.
 - Click **Next** to deploy your entries and to add another entry to the Trap Destination Host table. The window refreshes and you can add another trap destination host.
-

Related Topics

- [Configuring Virtual Contexts, page 6-8](#)
- [Configuring Basic SNMP Attributes, page 6-27](#)
- [Configuring SNMPv2c Communities, page 6-28](#)
- [Configuring SNMPv3 Users, page 6-29](#)
- [Configuring SNMP Notification, page 6-33](#)

Configuring SNMP Notification

You can configure SNMP notification for a virtual context after configuring basic SNMP information for a virtual context (see the “[Configuring Basic SNMP Attributes](#)” section on page 6-27).

To receive SNMP notifications you must configure the following attributes:

- At least one SNMP trap destination host (see the “[Configuring SNMP Trap Destination Hosts](#)” section on page 6-32).
- At least one type of notification.

Assumptions

- You have configured at least one SNMP contact (see the “[Configuring Basic SNMP Attributes](#)” section on page 6-27).
- At least one SNMP server host has been configured (see the “[Configuring SNMP Trap Destination Hosts](#)” section on page 6-32).

Procedure

- Step 1** Choose the item to configure:
- To configure a virtual context, choose **Config > Devices > context > System > SNMP**.
 - To configure a configuration building block, choose **Config > Global > All Building Blocks > building_block > System > SNMP**.
- The SNMP configuration window appears.
- Step 2** In the SNMP configuration window, click the **SNMP Notification** tab.
- The SNMP Notification table appears.
- Step 3** In the SNMP Notification table, click **Add** to add a new entry, or choose an existing entry in the table, and click **Edit** to modify it.
- The SNMP Notification configuration window appears.

Step 4 In the Options field of the SNMP Notification configuration window, choose the type of notifications to be sent to the SNMP host.

Some options are available only in the Admin context.



Note When configuring SNMP notification for ACE appliances, we recommend that you choose the more specific options. For example, choose Slb real or Slb vserver instead of Slb to ensure that the correct commands are issued on the ACE appliance.

Choices are as follows:

- **License**—SNMP license notifications are to be sent. This option is available only in the Admin context.
- **SLB**—Server load-balancing notifications are to be sent.
- **SLB Real Server**—Notifications of real server state changes are to be sent.
- **SLB Virtual Server**—Notifications of virtual server state changes are to be sent.
- **SNMP**—SNMP notifications are to be sent.
- **SNMP Authentication**—Notifications of incorrect community strings in SNMP requests are to be sent.
- **SNMP Cold-Start**—SNMP agent restart notifications are to be sent after a cold restart (full power cycle) of the ACE. This option is available only in the Admin context.
- **SNMP Link-Down**—Notifications are to be sent when a VLAN interface is down.
- **SNMP Link-Up**—Notifications are to be sent when a VLAN interface is up.
- **Syslog**—Error message notifications (Cisco Syslog MIB) are to be sent.
- **Virtual Context**—Virtual context notifications are to be sent.

Step 5 Do one of the following:

- Click **Deploy Now** to immediately deploy this configuration on the ACE and save your entries to the running-configuration and startup-configuration files. This option appears for virtual contexts.
- Click **OK** to save your entries. This option appears for configuration building blocks.
- Click **Cancel** to exit this procedure without saving your selection and to return to the SNMP Notification table.
- Click **Next** to deploy your entries and to add another entry to the SNMP Notification table. The window refreshes and you can choose another SNMP notification option.

Related Topics

- [Configuring Virtual Contexts, page 6-8](#)
- [Configuring Basic SNMP Attributes, page 6-27](#)
- [Configuring SNMPv2c Communities, page 6-28](#)
- [Configuring SNMPv3 Users, page 6-29](#)
- [Configuring SNMP Trap Destination Hosts, page 6-32](#)

Applying a Policy Map Globally to All VLAN Interfaces

You can apply a policy map globally to all VLAN interfaces in a selected context or configuration building block.

To apply a policy map to a specific context VLAN interface only, see the Input Policies attribute in the “[Configuring Virtual Context VLAN Interfaces](#)” section on page 12-6.



Note You cannot modify a policy map that is currently applied to an interface. To modify an applied policy map, you must first remove (delete) it from the interface, make the required modifications, and then apply it to the interface again.

Assumption

A Layer 3/Layer 4 or Management policy map has been configured for the selected context or building block. For more information, see the “[Configuring Virtual Context Policy Maps](#)” section on page 14-32.

Procedure

- Step 1** Choose the item to configure:
- To configure a virtual context, choose **Config > Devices > context > System > Global Policies**.
 - To configure a configuration building block, choose **Config > Global > All Building Blocks > building_block > System > Global Policies**.
- The Global Policies table appears.
- Step 2** In the Global Policies table, click **Add** to add a new global policy.
- The New Global Policy window appears.
- Step 3** In the Policy Map field of the New Global Policy window, choose an existing policy map that you want to apply to all VLANs in this context.



Note The Direction field displays the value “input” and cannot be modified.

- Step 4** Do one of the following:
- Click **Deploy Now** to immediately deploy this configuration on the ACE and save your entries to the running-configuration and startup-configuration files. This option appears for virtual contexts.
 - Click **OK** to save your entries. This option appears for configuration building blocks.
 - Click **Cancel** to exit the procedure without saving your entries and to return to the Global Policies table.
 - Click **Next** to deploy your entries and to configure another global policy.

Related Topics

- [Information About Virtual Contexts](#), page 6-2
- [Configuring Virtual Context Primary Attributes](#), page 6-14
- [Configuring Virtual Context VLAN Interfaces](#), page 12-6

- [Configuring Virtual Context Syslog Settings](#), page 6-19
- [Configuring Traffic Policies](#), page 14-1

Managing ACE Licenses



Note

This functionality is available for only Admin contexts.

Cisco offers licenses for ACE modules and appliances that allow you to increase the number of default contexts, bandwidth, and SSL transactions per second (TPS). For more information about these licenses, see the Cisco Application Control Engine documentation on Cisco.com.

If you install ACE licenses to increase the number of virtual contexts that you can create and manage on a device, you need to ensure that the installed ANM licenses support the increased number of virtual contexts. For example, if you install an upgrade ACE device license that allows you to create and manage 20 virtual contexts on the device, you must purchase and install the appropriate ANM license before you can manage the additional contexts using ANM. For more information about using and managing ANM licenses, see the [“Using ANM License Manager to Manage ANM Server or Demo Licenses”](#) section on page 18-54.

You can view, install, remove, or update ACE device licenses using ANM.

This section includes the following topics:

- [Viewing ACE Licenses](#), page 6-36
- [Installing ACE Licenses](#), page 6-37
- [Uninstalling ACE Licenses](#), page 6-39
- [Updating ACE Licenses](#), page 6-40
- [Displaying the File Contents of a License](#), page 6-42

Viewing ACE Licenses



Note

This functionality is available for only Admin contexts.

You can view the licenses that are currently installed on an ACE.

Procedure

-
- Step 1** Choose **Config > Devices**.
- The device tree appears.
- Step 2** In the device tree, choose the Admin context with the ACE licenses that you want to view, and click **System > Licenses**.
- The following license tables appear:
- License Status Table—Provides a summary of the license status for the ACE, including:
 - SSL transactions per second

- Number of supported virtual contexts
- ACE bandwidth in gigabits per second

For ACE appliances (all versions) and ACE module version A4(1.0) and later, it also displays the following:

- Compression performance in megabits or gigabits per second
- Web optimization in the number of connections per second
- Installed License Files Table—Lists all installed licenses with their filenames, vendors, and expiration dates.

Related Topics

- [Managing ACE Licenses, page 6-36](#)
- [Installing ACE Licenses, page 6-37](#)
- [Uninstalling ACE Licenses, page 6-39](#)
- [Updating ACE Licenses, page 6-40](#)
- [Displaying the File Contents of a License, page 6-42](#)

Installing ACE Licenses



Note

This functionality is available for only Admin contexts.

You can install an ACE license on the device after you copy the license from a remote network server to the disk0: file system in Flash memory on the ACE. You can use the ANM to perform both processes from a single dialog box. If you previously copied the license to disk0: on the ACE by using the **copy disk0:** CLI command, you can use this dialog box to install the new license or upgrade license on your ACE.

Assumption

This topic assumes the following:

- You have received the proper software license key for the ACE.
- ACE licenses are available on a remote server for importing to the ACE, or you have received the software license key and have copied the license file to the disk0: filesystem on the ACE using the **copy disk0:** CLI command. See either the *Cisco Application Control Engine Module Administration Guide* or *Cisco 4700 Series Application Control Engine Appliance Administration Guide* for details.

Procedure

Step 1 Choose **Config > Devices**.

The device tree appears.

Step 2 In the device tree, choose the Admin context that you want to import and install a license for, and click **System > Licenses**.

The following license tables appear:

- License Status Table—Provides a summary of the license status for the ACE, including:
 - SSL transactions per second
 - Number of supported virtual contexts
 - ACE bandwidth in gigabits per second

For ACE appliances (all versions) and ACE module version A4(1.0) and later, it also displays the following:

- Compression performance in megabits or gigabits per second
- Web optimization in the number of connections per second
- Installed License Files Table—Lists all installed licenses with their filenames, vendors, and expiration dates.

Step 3 Click **Install**.

The Install an ACE License dialog box appears.

Step 4 (Optional) If the license currently exists on the ACE disk0: file system in Flash memory, do the following:

- a. In the Select an Option to Locate a License File section of the dialog box, click the **Select a license file on the ACE** option.
- b. In the Select a License File on the Device (disk0) section of the dialog box, from the drop-down list, choose the name of the license file.
- c. Go to Step 10.

Step 5 (Optional) If the license must be copied to the disk0: file system in Flash memory, in the Select an Option to Locate a License File section of the dialog box, click the **Import a license file from remote system** option. Go to Step 6.

Step 6 In the Protocol To Connect To Remote System field, choose the protocol to be used to import the license file from the remote server to the ACE as follows:

- If you choose FTP, the User Name and Password fields appear. Go to Step 7.
- If you choose SFTP, the User Name and Password fields appear. Go to Step 7.
- If you choose TFTP, go to Step 8.

Step 7 (Optional) If you choose FTP or SFTP, do the following:

- a. In the User Name field, enter the username of the account on the network server.
- b. In the Password field, enter the password for the user account.

Step 8 In the Remote System IP Address field, enter the host IP address of the remote server.

For example, your entry might be 192.168.11.2.

Step 9 In the License Path In Remote System field, enter the host path and filename of the license file on the remote server in the format */path/filename* where:

- *path* represents the directory path of the license file on the remote server.
- *filename* represents the filename of the license file on the remote server.

For example, your entry might resemble */usr/bin/ACE-VIRT-020.lic*.

Step 10 Do one of the following:

- Click **Install** to accept your entries and to install the license file.

- Click **Cancel** to exit this procedure without installing the license file and to return to the Licenses table.

Step 11 (Optional) After installing an ACE license, we recommend that you manually synchronize the ACE Admin context with the CLI to ensure that ANM accurately displays the monitored resource usage information (Monitor > Devices > ACE > Resource Usage > Connections).

For information about synchronizing the Admin context, see the [“Synchronizing Virtual Context Configurations”](#) section on page 6-105.

Related Topics

- [Managing ACE Licenses, page 6-36](#)
- [Viewing ACE Licenses, page 6-36](#)
- [Uninstalling ACE Licenses, page 6-39](#)
- [Updating ACE Licenses, page 6-40](#)
- [Displaying the File Contents of a License, page 6-42](#)

Uninstalling ACE Licenses



Note

This functionality is available for Admin contexts only.

You can remove ACE licenses.



Caution

Removing licenses can affect the ACE bandwidth or performance. For detailed information on the effect of license removal on the ACE, see the Cisco Application Control Engine documentation on Cisco.com.

Procedure

Step 1 Choose **Config > Devices**.

The device tree appears.

Step 2 In the device tree, choose the Admin context with the license that you want to remove, and click **System > Licenses**.

Step 3 In the Installed License Files table, choose the license to be removed.

Step 4 Click **Uninstall**.

A dialog box appears, asking you to confirm the license removal process.



Note

Before continuing, confirm that you have selected the correct license to be removed. When you click **OK** in the confirmation window, you cannot stop the removal process.



Note

Removing licenses can affect the number of contexts, ACE bandwidth, or SSL TPS (transactions per second). Be sure you understand the effect on your environment before removing the license.

Step 5 Click **OK** to confirm the removal or **Cancel** to stop the removal process.

If you click **OK**, a status window appears with the status of license removal. When the license has been removed, the License table refreshes without the deleted license.

Step 6 (Optional) After uninstalling an ACE license, we recommend that you manually synchronize the ACE Admin context with the CLI to ensure that ANM accurately displays the monitored resource usage information (Monitor > Devices > ACE > Resource Usage > Connections).

For information about synchronizing the Admin context, see the [“Synchronizing Virtual Context Configurations”](#) section on page 6-105.

Related Topics

- [Managing ACE Licenses, page 6-36](#)
- [Installing ACE Licenses, page 6-37](#)
- [Viewing ACE Licenses, page 6-36](#)
- [Updating ACE Licenses, page 6-40](#)
- [Displaying the File Contents of a License, page 6-42](#)

Updating ACE Licenses



Note

This functionality is available for Admin contexts only.

You can convert demonstration licenses to permanent licenses and to upgrade permanent licenses to increase the number of virtual contexts.

Assumption

This topic assumes the following:

- You have received the updated software license key for the ACE.
- ACE licenses are available on a remote server for importing to the ACE, or you have received the updated software license key and have copied the license file to the disk0: filesystem on the ACE using the **copy disk0:** CLI command. See either the *Cisco Application Control Engine Module Administration Guide* or *Cisco 4700 Series Application Control Engine Appliance Administration Guide* for details.

Procedure

Step 1 Choose **Config > Devices**.

The device tree appears.

Step 2 In the device tree, choose the Admin context with the license that you want to update, and click **System > Licenses**.

The following license tables appear:

- License Status Table—Provides a summary of the license status for the ACE, including:
 - SSL transactions per second

- Number of supported virtual contexts
- ACE bandwidth in gigabits per second

For ACE appliances (all versions) and ACE module version A4(1.0) and later, it also displays the following:

- Compression performance in megabits or gigabits per second
- Web optimization in the number of connections per second
- Installed License Files Table—Lists all installed licenses with their filenames, vendors, and expiration dates.

Step 3 Choose the license to be updated, and click **Update**.

The Update License dialog box appears.

Step 4 (Optional) If the update license currently exists on the ACE disk0: file system in Flash memory, do the following:

- In the Select an Option to Locate a License File section of the dialog box, click the **Select a license file on the ACE** option.
- In the Select a License File on the Device (disk0) section of the dialog box, choose the name of the update license file from the drop-down list.
- Go to Step 10.

Step 5 (Optional) If the update license must be copied to the disk0: file system in Flash memory, in the Select an Option to Locate a License File section of the dialog box, click the **Import a license file from remote system** option. Go to Step 6.

Step 6 In the Protocol To Connect To Remote System field, choose the protocol to be used to import the update license file from the remote server to the ACE as follows:

- If you choose FTP, the User Name and Password fields appear. Go to Step 7.
- If you choose SFTP, the User Name and Password fields appear. Go to Step 7.
- If you choose TFTP, go to Step 8.

Step 7 (Optional) If you choose FTP or SFTP, do the following:

- In the User Name field, enter the username of the account on the network server.
- In the Password field, enter the password for the user account.

Step 8 In the Remote System IP Address field, enter the host IP address of the remote server.

For example, your entry might be 192.168.11.2.

Step 9 In the Licence Path In Remote System field, enter the host path and filename of the license file on the remote server in the format */path/filename* where:

- *path* represents the directory path of the license file on the remote server.
- *filename* represents the filename of the license file on the remote server.

For example, your entry might be */usr/bin/ACE-VIRT-020.lic*.

Step 10 Do one of the following:

- Click **Update** to update the license and to return to the License table. The License table displays the updated information.
- Click **Cancel** to exit this procedure without updating the license and to return to the License table.

- Step 11** (Optional) After updating an ACE license, recommend that you manually synchronize the ACE Admin context with the CLI to ensure that ANM accurately displays the monitored resource usage information (Monitor > Devices > ACE > Resource Usage > Connections).

For information about synchronizing the Admin context, see the [“Synchronizing Virtual Context Configurations” section on page 6-105](#).

Related Topics

- [Managing ACE Licenses, page 6-36](#)
- [Installing ACE Licenses, page 6-37](#)
- [Viewing ACE Licenses, page 6-36](#)
- [Uninstalling ACE Licenses, page 6-39](#)
- [Displaying the File Contents of a License, page 6-42](#)

Displaying the File Contents of a License



Note This functionality is available for only Admin contexts.

You can display file content information about ACE licenses.

Procedure

-
- Step 1** Choose **Config > Devices**.
- The device tree appears.
- Step 2** Choose the Admin context with the license information that you want to view, and choose **System > Licenses**.
- The following two license tables appear:
- License Status Table—Provides a summary of the license status for the ACE, including the supported features and capabilities.
 - Installed License Files Table—Lists all installed licenses with their filenames, vendors, and expiration dates.
- Step 3** Choose the installed license file with the information that you want to display, and click **View**.
- ANM displays the output of the **show license file** CLI command.
- For example:
- ```
SERVER this_host ANY
VENDOR cisco
INCREMENT ACE-AP-C-2000-LIC cisco 1.0 permanent 1 \
NOTICE="<LicFileID>lic.conf</LicFileID><LicLineID>0</LicLineID> \
<PAK>dummyPak</PAK>" SIGN=BBBDC344EAE8
```
- Step 4** Click **Close** when you finish viewing the license file information.
-

**Related Topics**

- [Managing ACE Licenses, page 6-36](#)
- [Installing ACE Licenses, page 6-37](#)
- [Viewing ACE Licenses, page 6-36](#)
- [Uninstalling ACE Licenses, page 6-39](#)

## Using Resource Classes

Resource classes are the means by which you manage virtual context access to ACE resources, such as concurrent connections or bandwidth rate. ACE devices are preconfigured with a default resource class that is applied to the Admin context and any user context upon creation. The default resource class is configured to allow a context to operate within a range that can vary from no resource access (0%) to complete resource access (100%). When you use the default resource class with multiple contexts, you run the risk of oversubscribing ACE resources. This means that the ACE permits all contexts to have full access to all resources on a first-come, first-served basis. When a resource is utilized to its maximum limit, the ACE denies additional requests made by any context for that resource.

To avoid oversubscribing resources and to help guarantee access to a resource by any context, you can create customized resource classes that you associate with one or more contexts. A context becomes a member of the resource class when you make the association. Creating a resource class allows you to set limits on the minimum and maximum amounts of each ACE resource that a member context is entitled to use. You define the minimum and maximum values as a percentage of the whole. For example, you can create a resource class that allows its member contexts access to no less than 25% of the total number of SSL connections that the ACE supports.

You can limit and manage the allocation of the following ACE resources:

- ACL memory
- Buffers for syslog messages and TCP out-of-order (OOO) segments
- Concurrent connections (through-the-ACE traffic)
- Management connections (to-the-ACE traffic)
- Proxy connections
- Set resource limit as a rate (number per second)
- Regular expression (regexp) memory
- SSL connections
- Sticky entries
- Static or dynamic network address translations (Xlates)

When you discover ACE devices, the ANM detects the resource class information and imports it with other device information. If an ACE is not configured for a resource class, it inherits the resource class configuration of the virtual context it is associated with. If an ACE does have a resource class configuration but it differs from one configured in the ANM, the discrepancy is logged as an anomaly but otherwise has no impact on the import process or the ACE.

[Table 6-9 on page 6-45](#) identifies and defines the resources that you can establish for resource classes.

**Related Topics**

- [Global and Local Resource Classes, page 6-44](#)

- [Resource Allocation Constraints, page 6-44](#)
- [Using Global Resource Classes, page 6-46](#)
- [Displaying Local Resource Class Use on Virtual Contexts, page 6-54](#)

## Global and Local Resource Classes

ANM provides two levels of resource classes for ACE devices that operate independently of each other:

- Local or device-specific resource classes
- Global resource classes

Local resource classes are initially imported from the ACE during the import process and appear in the ANM interface in the Admin virtual context where they can be managed, modified, or deleted by an Admin user. An Admin user can also create new, local resources classes by using ANM. Choose **Config > Devices > Admin\_context > System > Resource Classes** to add, view, or modify local resource classes.

Global resource classes are managed separately from local resource classes and require manual deployment to a specific ACE using the Admin virtual context before they take effect. If you deploy a global resource class to an ACE that does not have a resource class with the same name, ANM creates a new local resource class with the same name and properties as the global resource class. If you deploy a global resource class to an ACE that already has a resource class with the same name, ANM replaces the properties of the local resource class with the properties from the global resource class. Choose **Config > Global > All Resource Classes** to add, view, modify, audit, or delete global resource classes.

### Related Topics

- [Using Resource Classes, page 6-43](#)
- [Resource Allocation Constraints, page 6-44](#)
- [Using Global Resource Classes, page 6-46](#)
- [Using Local Resource Classes, page 6-51](#)
- [Auditing Resource Classes, page 6-49](#)

## Resource Allocation Constraints

The following resources are critical for maintaining connectivity to the Admin context:

- Rate Bandwidth
- Rate Management Traffic
- Rate SSL Connections
- Rate Connections
- Management Connections
- Concurrent Connections



### Caution

If you allocate 100 percent of these resources to a resource class and then apply the resource class to virtual contexts, connectivity to the Admin context can be lost.

We recommend that you create a resource class specifically for the Admin context and apply it to the context so that you can maintain IP connectivity.

**Table 6-9**      **Resource Class Attributes**

| Resource                 | Definition                                                                                                                                                                                                                                                                                                                                                                  |
|--------------------------|-----------------------------------------------------------------------------------------------------------------------------------------------------------------------------------------------------------------------------------------------------------------------------------------------------------------------------------------------------------------------------|
| Default                  | Default percentage used for any resource parameter not explicitly set.                                                                                                                                                                                                                                                                                                      |
| Acceleration Connections | Option that is available ACE appliances only.<br>Percentage of application acceleration connections.                                                                                                                                                                                                                                                                        |
| ACL Memory               | Percentage of memory allocated for ACLs.                                                                                                                                                                                                                                                                                                                                    |
| Concurrent Connections   | Percentage of simultaneous connections.<br><b>Note</b> If you consume all Concurrent Connections by allocating 100 percent to virtual contexts, IP connectivity to the Admin context can be lost.                                                                                                                                                                           |
| HTTP Compression         | Percentage of compression for HTTP data.<br><b>Note</b> This option appears for ACE appliances (all versions) and ACE module version A4(1.0) and later only.                                                                                                                                                                                                                |
| Management Connections   | Percentage of management connections.<br><b>Note</b> If you consume all Management Connections by allocating 100 percent to virtual contexts, IP connectivity to the Admin context can be lost.                                                                                                                                                                             |
| Proxy Connections        | Percentage of proxy connections.                                                                                                                                                                                                                                                                                                                                            |
| Regular Expression       | Percentage of regular expression memory.                                                                                                                                                                                                                                                                                                                                    |
| Sticky                   | Percentage of entries in the sticky table.<br><b>Note</b> (Pre ACE version A4(1.0) module or appliance only) You must configure a minimum value for sticky to allocate resources for sticky entries; the sticky software receives no resources under the unlimited setting.                                                                                                 |
| Xlates                   | Percentage of network and port address translations entries.                                                                                                                                                                                                                                                                                                                |
| Buffer Syslog            | Percentage of the syslog buffer.                                                                                                                                                                                                                                                                                                                                            |
| Rate Inspect Connection  | Percentage of application protocol inspection connections.                                                                                                                                                                                                                                                                                                                  |
| Rate Bandwidth           | Percentage of context throughput. This attribute limits the total ACE throughput in bytes per second for one or more contexts.<br><b>Note</b> If you consume all Rate Bandwidth by allocating 100 percent to virtual contexts, IP connectivity to the Admin context can be lost.<br><br>The maximum bandwidth rate per context is determined by your ACE bandwidth license. |
| Rate Connections         | Percentage of connections of any kind.<br><b>Note</b> If you consume all Rate Connections by allocating 100 percent to virtual contexts, IP connectivity to the Admin context can be lost.                                                                                                                                                                                  |
| Rate Management Traffic  | Percentage of management traffic connections.<br><b>Note</b> If you consume all Rate Management Traffic by allocating 100 percent to virtual contexts, IP connectivity to the Admin context can be lost.                                                                                                                                                                    |

**Table 6-9** Resource Class Attributes (continued)

| Resource             | Definition                                                                                                                                                                            |
|----------------------|---------------------------------------------------------------------------------------------------------------------------------------------------------------------------------------|
| Rate SSL Connections | Percentage of SSL connections.<br><b>Note</b> If you consume all Rate SSL Connections by allocating 100percent to virtual contexts, IP connectivity to the Admin context can be lost. |
| Rate Syslog          | Percentage of syslog messages per second.                                                                                                                                             |
| Rate MAC Miss        | Percentage of messages destined for the ACE that are sent to the control plane when the encapsulation is not correct in packets.                                                      |

**Related Topics**

- [Using Global Resource Classes, page 6-46](#)
- [Configuring Global Resource Classes, page 6-46](#)
- [Configuring Local Resource Classes, page 6-52](#)
- [Auditing Resource Classes, page 6-49](#)
- [Deploying Global Resource Classes, page 6-48](#)

## Using Global Resource Classes

Resource classes are used when provisioning services, establishing virtual contexts, managing devices, and monitoring virtual context resource consumption.

Defining a new global resource class does not automatically update all configurations. A global resource class is applied only when the resource class is deployed to a specific Admin virtual context on an ACE.

This section includes the following topics:

- [Configuring Global Resource Classes, page 6-46](#)
- [Deploying Global Resource Classes, page 6-48](#)
- [Auditing Resource Classes, page 6-49](#)
- [Modifying Global Resource Classes, page 6-50](#)
- [Deleting Global Resource Classes, page 6-51](#)

## Configuring Global Resource Classes

You can create a new global resource class and optionally deploy it on an ACE by using the Admin virtual context.

**Caution**

If you allocate 100 percent of these resources to a resource class and then apply the resource class to virtual contexts, connectivity to the Admin context can be lost. For more information, see the [“Resource Allocation Constraints”](#) section on page 6-44.

## Procedure

- 
- Step 1** Choose **Config > Global > All Resource Classes**.
- The Resource Classes table appears.
- Step 2** In the Resource Classes table, click **Add** to create a new resource class.
- The New Resource Class configuration window appears.
- Step 3** In the Name field of the New Resource Class configuration window, enter a unique name for this resource class.
- Valid entries are unquoted text strings with no spaces and a maximum of 64 characters.
- Step 4** In the Description field, enter a brief description for this resource class.
- Valid entries are unquoted text strings with a maximum of 240 alphanumeric characters.
- Step 5** To use the same values for each resource, in the All row, enter the following information (see [Table 6-9](#) for a description of the resources):
- In the Min. field, enter the minimum percentage of each resource that you want to allocate to this resource class. Valid entries are numbers from 0 to 100 including those numbers with decimals.
  - In the Max. field, choose the maximum percentage of each resource that you want to allocate to this resource class as follows:
    - Equal To Min—The maximum percentage allocated for each resource is equal to the minimum specified in the Min. field.
    - Unlimited—There is no upper limit on the percentage of each resource that can be allocated for this resource class.
- Step 6** To use different values for the resources, for each resource, choose the method for allocating resources:
- Choose **Default** to use the values specified in [Step 5](#).
  - Choose **Min** to enter a specific minimum value for the resource.
- Step 7** If you chose Min, do the following:
- In the Min. field, enter the minimum percentage of this resource you want to allocate to this resource class. For example, for ACL memory, enter **10** in the Min. field to indicate that you want to allocate a minimum of 10 percent of the available ACL memory to this resource class.
  - In the Max. field, choose the maximum percentage of the resource that you want to allocate to this resource class:
    - Equal To Min—The maximum percentage allocated for this resource is equal to the minimum specified in the Min. field.
    - Unlimited—There is no upper limit on the percentage of the resource that can be allocated for this resource class.
- Step 8** To deploy the resource class to an Admin context, do the following:
- Click **Admin VCs To Deploy To** to expand the configuration subset.
  - In the Available Items list, choose the desired Admin context, and click **Add**. The items appear in the Selected Items list.
- In the Selected Items list, choose a context to remove and click **Remove**. The items appear in the Available Items list.
- Step 9** Do one of the following:
- Click **OK** to save your entries and to return to the Resource Classes table.

- Click **Cancel** to exit this procedure without saving your entries and to return to the Resource Classes table.
- 

**Related Topics**

- [Using Resource Classes, page 6-43](#)
- [Modifying Global Resource Classes, page 6-50](#)
- [Deleting Global Resource Classes, page 6-51](#)
- [Auditing Resource Classes, page 6-49](#)

## Deploying Global Resource Classes

You can apply a global resource class to Admin contexts on selected ACE devices. If you deploy a global resource class to an ACE that already has a resource class with the same name, ANM replaces the properties of the local resource class with the properties from the global resource class. If you deploy a global resource class to an ACE that does not have a resource class with the same name, ANM creates a new local resource class with the same name and properties as the global resource class.

**Assumptions**

This topic assumes the following:

- At least one global resource class exists.
- At least one ACE has been imported into the ANM.

**Procedure**

---

- Step 1** Choose **Config > Global > All Resource Classes**.  
The Resource Classes table appears.
- Step 2** In the Resource Classes table, choose the global resource class that you want to apply to an ACE, and click **Edit**.  
The Edit Resource Class configuration window appears.
- Step 3** In the Available Items list of the Edit Resource Class configuration window, choose the context that you want to apply this global resource class to, and click **Add**.  
The item appears in the Selected Items list.  
To remove contexts, choose them in the Selected Items list, and click **Remove**. The items appear in the Available Items list.
- Step 4** Do one of the following:
- Click **OK** to save your entries and to return to the Resource Classes table. The context is updated with the resource class configuration.
  - Click **Cancel** to exit this procedure without saving your entries and to return to the Resource Classes table.
-



**Related Topics**

- [Using Resource Classes, page 6-43](#)
- [Modifying Global Resource Classes, page 6-50](#)
- [Using Local Resource Classes, page 6-51](#)
- [Configuring Local Resource Classes, page 6-52](#)

## Auditing Resource Classes

You can display any discrepancies that exist between the global resource class and the local resource class on the context after you apply a global resource class to an Admin context. Discrepancies occur when either global or context resource class attributes are modified independently of one another after the global resource class has been applied.

**Procedure**

---

**Step 1** Choose **Config > Global > All Resource Classes**.

The Resource Classes table appears.

**Step 2** In the Resource Classes table, choose the resource class that you want to audit, and click **Audit**.

ANM identifies the differences between the selected resource class and the Admin contexts being managed by ANM and displays the results in the Audit Differences table in a separate window. The table uses the following conventions:

- If the selected resource class has not been applied to an Admin context, the Admin context is listed with the comment “Resource class not defined.”
- If the selected resource class has been applied to an Admin context, but there are no differences between the global and local resource classes, the context does not appear in the table.
- If the selected resource class has been applied to an Admin context and there are differences between the global and local resource classes, the context appears in the table with the following information:
  - The resource attribute that has different values in the global and local resource classes.
  - The settings for the resource attribute in the local resource class.
  - The settings for the resource attribute in the global resource class.

The values displayed use the format *min - max* where *min* represents the minimum percentage configured for this attribute and *max* represents the maximum percentage configured for this attribute, such as 8% - 8% or 5% - 100%.

**Step 3** Do one of the following:

- Click **Close** to close this window and return to the Resource Classes table.
  - Click **Refresh** to update the information in the Audit Differences table.
- 

**Related Topics**

- [Using Global Resource Classes, page 6-46](#)
- [Using Local Resource Classes, page 6-51](#)
- [Configuring Global Resource Classes, page 6-46](#)

- [Configuring Local Resource Classes, page 6-52](#)

## Modifying Global Resource Classes

You can modify an existing global resource class. The changes are not applied to virtual contexts previously associated with the resource class. ANM only applies updated resource class properties to virtual contexts that are associated with the resource class going forward.



### Caution

If you allocate 100 percent of these resources to a resource class and then apply the resource class to virtual contexts, connectivity to the Admin context can be lost. For more information, see the [“Resource Allocation Constraints”](#) section on page 6-44.

### Procedure

- Step 1** Choose **Config > Global > All Resource Classes**.  
The Resource Classes table appears.
  - Step 2** Choose the resource class that you want to modify, and click **Edit**.  
The Edit Resource Class configuration window appears.
  - Step 3** In the Edit Resource Class configuration window, modify the values as desired.  
For details on setting values, see the [“Configuring Global Resource Classes”](#) section on page 6-46. For descriptions of the resources, see [Table 6-9](#).
  - Step 4** To deploy the modified resource class to an Admin context, do the following:
    - a. Click **Admin VCs To Deploy To** to expand the configuration subset.
    - b. Choose the desired context in the Available Items list, and click **Add**. The item appears in the Selected Items list.
-  **Note** ANM only applies the updated resource class to contexts that you choose and add to the Selected Items list. It does not apply the modified resource class to contexts previously associated with the resource class.
- Step 5** Do one of the following:
    - Click **OK** to save your entries, apply them to the selected contexts, and return to the Resource Classes table.
    - Click **Cancel** to exit this procedure without saving your entries and to return to the Resource Classes table.

### Related Topics

- [Using Resource Classes, page 6-43](#)
- [Using Global Resource Classes, page 6-46](#)
- [Modifying Global Resource Classes, page 6-50](#)
- [Auditing Resource Classes, page 6-49](#)

- [Deleting Global Resource Classes, page 6-51](#)

## Deleting Global Resource Classes

You can remove global resource classes from the ANM database. Because global resource classes are managed separately from local resource classes, deleting a global resource class does not affect local resource classes deployed on individual contexts.

### Procedure

- 
- Step 1** Choose **Config > Global > All Resource Classes**.  
The Resource Classes table appears.
- Step 2** In the Resource Classes table, choose the resource class that you want to remove, and click **Delete**.  
A confirmation popup window appears, asking you to confirm the deletion.
- Step 3** Click **OK** to delete the resource class or **Cancel** to retain the resource class.  
The Resource Classes table refreshes with the updated information.
- 

### Related Topics

- [Using Resource Classes, page 6-43](#)
- [Using Global Resource Classes, page 6-46](#)
- [Modifying Global Resource Classes, page 6-50](#)
- [Auditing Resource Classes, page 6-49](#)

## Using Local Resource Classes

You can create local resource classes in ANM as follows:

- During the import process, from any ACE with a previously configured resource class. These resource classes appear in the ANM in the Admin virtual context associated with the imported ACE.
- By an Admin user in ANM using the local Resource Class configuration option (Config > Devices > Admin\_context > System > Resource Classes).
- By creating a global resource class (Config > Global > All Resource Classes) and applying it to an Admin context.



### Note

Local resource class configuration options are available in Admin contexts only.

This section includes the following topics:

- [Configuring Local Resource Classes, page 6-52](#)
- [Deleting Local Resource Classes, page 6-53](#)
- [Displaying Local Resource Class Use on Virtual Contexts, page 6-54](#)

## Configuring Local Resource Classes



### Note

This functionality is available in Admin contexts only.

You can create or modify a local resource class for use within the selected Admin context.

### Procedure

- 
- Step 1** Choose **Config > Devices > Admin\_context > System > Resource Classes**.
- The Resource Classes table appears.
- Step 2** In the Resource Classes table, click **Add** to create a new local resource class or choose an existing resource class, and click **Edit** to modify it.
- The Resource Class configuration window appears.
- Step 3** In the Name field of the Resource Class configuration window, enter a unique name for this resource class.
- Valid entries are unquoted text strings with no spaces and a maximum of 64 characters.
- Step 4** To use the same values for each resource, in the All row, enter the following information (see [Table 6-9](#) for a description of the resources):
- a. In the Min. field, enter the minimum percentage of each resource that you want to allocate to this resource class. Valid entries are numbers from 0 to 100 including those numbers with decimals.
  - b. In the Max. field, choose the maximum percentage of each resource that you want to allocate to this resource class:
    - Equal To Min—The maximum percentage allocated for each resource is equal to the minimum specified in the Min. field.
    - Unlimited—There is no upper limit on the percentage of each resource that can be allocated for this resource class.
- Step 5** To use different values for the resources, for each resource, choose one of the following methods for allocating resources:
- Choose **Default** to use the values specified in [Step 5](#).
  - Choose **Min** to enter a specific minimum value for the resource.
- Step 6** (Optional) If you chose Min, do the following:
- a. In the Min. field, enter the minimum percentage of this resource you want to allocate to this resource class. For example, for ACL memory, enter **10** in the Min. field to indicate that you want to allocate a minimum of 10 percent of the available ACL memory to this resource class.
  - b. In the Max. field, choose the maximum percentage of the resource that you want to allocate to this resource class:
    - **Equal To Min**—The maximum percentage allocated for this resource is equal to the minimum specified in the Min. field.
    - **Unlimited**—There is no upper limit on the percentage of the resource that can be allocated for this resource class.

- Step 7** When you finish allocating resources for this resource class, do one of the following:
- Click **OK** to save your entries and to return to the Resource Classes table. The resource class can now be applied to other virtual contexts on the same ACE.
  - Click **Cancel** to exit this procedure without saving your entries and to return to the Resource Classes table.
- 

**Related Topics**

- [Using Resource Classes, page 6-43](#)
- [Using Local Resource Classes, page 6-51](#)
- [Displaying Local Resource Class Use on Virtual Contexts, page 6-54](#)
- [Deleting Local Resource Classes, page 6-53](#)

## Deleting Local Resource Classes

You can delete a local resource class. Because of the possible impact on virtual contexts of deleting a local resource class, you cannot delete a resource class that is associated with a virtual context. To display a resource class's current deployment, see the [“Displaying Local Resource Class Use on Virtual Contexts”](#) section on page 6-54.

**Procedure**

- 
- Step 1** Choose **Config > Devices > Admin\_context > System > Resource Classes**.
- The Resource Classes table lists all local resource classes and the number of virtual contexts using each resource class.
- Step 2** Confirm that the resource class that you want to delete is not deployed on any virtual contexts.
- You cannot delete a resource class that is deployed on a context.
- To identify the contexts using a specific resource class, see the [“Displaying Local Resource Class Use on Virtual Contexts”](#) section on page 6-54.
- Step 3** Choose the resource class that you want to remove, and click **Delete**.
- A confirmation popup window appears, asking you to confirm the deletion.
- Step 4** Click **OK** to delete the resource class or **Cancel** to retain the resource class.
- The Resource Classes table refreshes with the updated information.
- 

**Related Topics**

- [Using Resource Classes, page 6-43](#)
- [Configuring Local Resource Classes, page 6-52](#)
- [Displaying Local Resource Class Use on Virtual Contexts, page 6-54](#)

## Displaying Local Resource Class Use on Virtual Contexts

You can display local resource class usage on all virtual contexts on an ACE.

### Procedure

- 
- Step 1** Choose **Config > Devices**.  
The device tree appears.
- Step 2** In the device tree, choose the ACE with the resource class usage that you want to display.  
The Virtual Contexts table appears, listing all contexts on the selected ACE and the resource class in use for each context.
- Step 3** (Optional) In the Virtual Contexts table, click the Resource Class column heading to sort the table by resource class.
- 

### Related Topics

- [Using Resource Classes, page 6-43](#)
- [Configuring Local Resource Classes, page 6-52](#)
- [Deleting Local Resource Classes, page 6-53](#)

## Using the Configuration Checkpoint and Rollback Service

At some point, you may want to modify your ACE running configuration. If you run into a problem with the modified configuration, you may need to reboot your ACE. To prevent having to reboot your ACE after unsuccessfully modifying a running configuration, you can create a checkpoint (a snapshot in time) of a known stable running configuration before you begin to modify it. If you encounter a problem with the modifications to the running configuration, you can roll back the configuration to the previous stable configuration checkpoint.



### Note

Before you upgrade your ACE software, we strongly recommend that you create a checkpoint in your running configuration. For ACE module A2(3.0) and later releases only, use the backup function to create a backup of the running configuration (see the [“Performing Device Backup and Restore Functions”](#) section on page 6-59).

The ACE allows you to make a checkpoint configuration at the context level. The ACE stores the checkpoint for each context in a hidden directory in Flash memory. If, after you make configuration changes that modify the current running configuration, when you roll back the checkpoint, the ACE causes the running configuration to revert to the checkpointed configuration.

This section includes the following topics:

- [Creating a Configuration Checkpoint, page 6-55](#)
- [Deleting a Configuration Checkpoint, page 6-56](#)
- [Rolling Back a Running Configuration, page 6-56](#)
- [Displaying Checkpoint Information, page 6-57](#)

- [Comparing a Checkpoint to the Running Configuration, page 6-58](#)

## Creating a Configuration Checkpoint

You can create a configuration checkpoint for a specific context. The ACE supports a maximum of 10 checkpoints for each context.

### Assumption

This topic assumes the following:

- Make sure that the current running configuration is stable and is the configuration that you want to make as a checkpoint. If you change your mind after creating the checkpoint, you can delete it (see the “[Deleting a Configuration Checkpoint](#)” section on page 6-56).
- The ACE-Admin, ANM-Admin, and Org-Admin predefined roles have access to the configuration checkpoint function.
- A custom role defined with the task ANM Inventory > Virtual Context/Create or ANM Inventory > Virtual Context/Modify has the required privileges to create a configuration checkpoint.
- A checkpoint will not include the SSL keys/certificates, probe scripts, and licenses.
- Adding a checkpoint from an ACE context directly will not trigger an autosynchronization on ANM for that context.

### Procedure

**Step 1** Choose **Config > Devices > context > System > Checkpoints**.

The Checkpoints table appears.

For descriptions of the checkpoints, see [Table 6-10](#).

**Table 6-10**      **Checkpoints Table**

| Field             | Description                                           |
|-------------------|-------------------------------------------------------|
| Name              | Unique identifier of the checkpoint.                  |
| Size (In Bytes)   | Size of the configuration checkpoint, shown in bytes. |
| Date (Created On) | Date that the configuration checkpoint was created.   |

**Step 2** In the Checkpoints table, click the **Create Checkpoint** button.

The Create Checkpoint dialog box appears.

**Step 3** In the Checkpoint Name field of the Create Checkpoint dialog box, specify a unique identifier for the checkpoint.

Enter a text string with no spaces and a maximum of 25 alphanumeric characters.

If the checkpoint already exists, you are prompted to use a different name.

**Step 4** Do one of the following:

- Click **OK** to save your configuration checkpoint. You return to the Checkpoints table and the new checkpoint appears in the table.

- Click **Cancel** to exit the procedure without saving the configuration checkpoint and to return to the Checkpoints table.
- 

**Related Topics**

- [Using the Configuration Checkpoint and Rollback Service, page 6-54](#)
- [Deleting a Configuration Checkpoint, page 6-56](#)
- [Rolling Back a Running Configuration, page 6-56](#)
- [Displaying Checkpoint Information, page 6-57](#)
- [Comparing a Checkpoint to the Running Configuration, page 6-58](#)

## Deleting a Configuration Checkpoint

You can delete a checkpoint. Deleting a checkpoint from an ACE context directly will not trigger an autosynchronization to occur on ANM for that context.

**Prerequisite**

Before you perform this procedure, make sure that you want to delete the checkpoint. Once you click the Trash icon, the ACE removes the checkpoint from Flash memory.

**Procedure**

- 
- Step 1** To choose a virtual context that you want to create a configuration checkpoint, choose **Config > Devices > context > System > Checkpoints**.

The Checkpoints table appears.

- Step 2** In the Checkpoints table, choose the radio button to the left of any table entry, and click the **Trash** icon to delete the checkpoint.
- 

**Related Topics**

- [Using the Configuration Checkpoint and Rollback Service, page 6-54](#)
- [Creating a Configuration Checkpoint, page 6-55](#)
- [Rolling Back a Running Configuration, page 6-56](#)
- [Displaying Checkpoint Information, page 6-57](#)
- [Comparing a Checkpoint to the Running Configuration, page 6-58](#)

## Rolling Back a Running Configuration

You can roll back the current running configuration of a context to the previously checkpointed running configuration.



### Procedure

---

**Step 1** Choose **Config > Devices > context > System > Checkpoints**.

The Checkpoints table appears.

**Step 2** Choose the radio button to the left of the checkpoint that you wish to roll back, and click **Rollback**.

ANM displays a confirmation popup window to warn you about this change and to instruct you that the rollback operation may take longer depending on the differences detected between the two configurations.



### Note

---

ANM synchronizes the device after performing a rollback. This synchronization may take some time.

---

### Related Topics

- [Using the Configuration Checkpoint and Rollback Service, page 6-54](#)
- [Creating a Configuration Checkpoint, page 6-55](#)
- [Deleting a Configuration Checkpoint, page 6-56](#)
- [Displaying Checkpoint Information, page 6-57](#)
- [Comparing a Checkpoint to the Running Configuration, page 6-58](#)

## Displaying Checkpoint Information

You can display checkpoint configuration information.

### Procedure

---

**Step 1** Choose **Config > Devices > context > System > Checkpoints**.

The Checkpoints table appears.

**Step 2** In the Checkpoints table, choose the radio button of the checkpoint that you want to display, and click **Details**.

A popup window appears in which ANM uses the ACE **s how checkpoint detail name** CLI command to display the configuration of the specified checkpoint (see [Figure 6-1](#)).

Figure 6-1 show checkpoint detail CLI Command Dialog Box

```

show checkpoint detail Test1
no ft auto-sync startup-config
logging trap 6
logging history 6
logging buffered 6
logging persistent 0
logging monitor 6
logging host 10.77.240.124 tcp/214 format emblem default-udp
resource-class 123
 limit-resource all minimum 0.00 maximum unlimited
resource-class 1234
 limit-resource all minimum 0.00 maximum unlimited
resource-class Rajan
 limit-resource all minimum 0.00 maximum unlimited
 limit-resource buffer-syslog minimum 4.00 maximum equal-to-min
 limit-resource prog-connections minimum 7.00 maximum equal-to-min
 limit-resource http-comp minimum 9.45 maximum equal-to-min
resource-class Rajesh
 limit-resource all minimum 0.00 maximum unlimited
 limit-resource rate-bandwidth minimum 0.01 maximum unlimited
 limit-resource st105 minimum 3.00 maximum equal-to-min
resource-class compression
 limit-resource all minimum 0.00 maximum unlimited
resource-class compress1ast
 limit-resource all minimum 0.00 maximum unlimited
resource-class global
 limit-resource all minimum 10.00 maximum unlimited
resource-class local
 limit-resource all minimum 10.00 maximum equal-to-min
resource-class raj
 limit-resource all minimum 0.00 maximum unlimited
resource-class sticky
 limit-resource all minimum 0.00 maximum unlimited
 limit-resource sticky minimum 10.00 maximum equal-to-min
resource-class test1aak
 limit-resource all minimum 10.00 maximum unlimited
resource-class test_0c_1
 limit-resource all minimum 25.00 maximum unlimited
 limit-resource act-memory minimum 10.00 maximum unlimited
resource-class test_0c_2
 limit-resource all minimum 11.00 maximum unlimited
 limit-resource x1ast minimum 27.00 maximum unlimited
resource-class test_0
 limit-resource all minimum 0.00 maximum unlimited
 limit-resource act-memory minimum 3.00 maximum unlimited
 limit-resource acc-connections minimum 23.00 maximum unlimited
resource-class testtest
 limit-resource all minimum 4.00 maximum unlimited
boot system image:c4710ac-h2-A3_2_5_4c.bin
peer hostname DM-47
hostname DM-4c
shared-vlan-hostid 15
interface gigabitEthernet 1/1
 switchport access vlan 2
 no shutdown
info:fae.mlab1@ethernet_1.0

```

**Step 3** From the popup window, click **Close** to exit the window and return to the Checkpoints table.

### Related Topics

- [Using the Configuration Checkpoint and Rollback Service, page 6-54](#)
- [Creating a Configuration Checkpoint, page 6-55](#)
- [Deleting a Configuration Checkpoint, page 6-56](#)
- [Rolling Back a Running Configuration, page 6-56](#)
- [Comparing a Checkpoint to the Running Configuration, page 6-58](#)

## Comparing a Checkpoint to the Running Configuration



### Note

This feature requires ACE module and ACE appliance software Version A4(1.0) or later.

You can have ANM compare and display the differences between a specified checkpoint and the ACE's current running configuration.

### Procedure

**Step 1** Choose **Config > Devices > context > System > Checkpoints**.

The Checkpoints table appears.

**Step 2** In the Checkpoints table, choose the radio button of the checkpoint that you want to compare to the current running configuration, and click **Compare**.

A popup window appears in which ANM uses the ACE **compare name** CLI command to display the differences between the running configuration and the specified checkpoint. The items that display in red are in the current running configuration and will be removed if you roll back to the checkpoint. The items that display in green are not in the current running configuration and will be added during the rollback.

**Step 3** From the popup window, click **Close** to the window and return to the Checkpoints table.

---

#### Related Topics

- [Using the Configuration Checkpoint and Rollback Service, page 6-54](#)
- [Creating a Configuration Checkpoint, page 6-55](#)
- [Deleting a Configuration Checkpoint, page 6-56](#)
- [Rolling Back a Running Configuration, page 6-56](#)
- [Displaying Checkpoint Information, page 6-57](#)

## Performing Device Backup and Restore Functions



#### Note

The backup and restore functions are available only for the ACE module A2(3.0), ACE appliance 4(1.0), and later releases of either device type.

---

The backup and restore functions allow you to back up or restore the configuration and dependencies of an entire ACE or of a particular virtual context. Configuration dependencies are those files that are required to exist on the ACE so that a configuration can be applied to it. Such files include health-monitoring scripts, SSL certificates, SSL keys, and so on. This feature allows you to back up and restore the following configuration files and dependencies:

- Running-configuration files
- Startup-configuration files
- Checkpoints
- SSL files (SSL certificates and keys)
- Health-monitoring scripts
- Licenses



#### Note

The backup feature does not back up the sample SSL certificate and key pair files.

---

Typical uses for this feature are as follows:

- Back up a configuration for later use
- Recover a configuration that was lost because of a software failure or user error
- Restore configuration files to a new ACE when a hardware failure resulted in a Return Merchandise Authorization (RMA) of the old ACE
- Transfer the configuration files to a different ACE

The backup and restore functions are supported in both the Admin and virtual contexts. If you perform these functions in the Admin context, you can back up or restore the configuration files for either the Admin context only or for all contexts in the ACE. If you perform these functions in a virtual context, you can back up or restore the configuration files only for that context. Both the backup and the restore functions run asynchronously (in the background).

**Note**

To perform the back up or copy functions on multiple ACEs simultaneously, see the [“Performing Global Device Backup and Copy Functions”](#) section on page 6-68

**Archive Naming Conventions**

Context archive files have the following naming convention format:

*Hostname\_ctxname\_timestamp.tgz*

The filename fields are as follows:

- *Hostname*—Name of the ACE. If the hostname contains special characters, the ACE uses the default hostname “switch” in the filename. For example, if the hostname is Active@~!#\$%^, then the ACE assigns the following filename: switch\_Admin\_2009\_08\_30\_15\_45\_17.tgz
- *ctxname*—Name of the context. If the context name contains special characters, the ACE uses the default context name “context” in the filename. For example, if the context name is Test!123\*, then the ACE assigns the following filename: switch\_context\_2009\_08\_30\_15\_45\_17.tgz
- *timestamp*—Date and time that the ACE created the file. The time stamp has the following 24 hour format: *YYYY\_MM\_DD\_hh\_mm\_ss*

An example is as follows:

ACE-1\_ctx1\_2009\_05\_06\_15\_24\_57.tgz

If you back up the entire ACE, the archive filename does not include the *ctxname* field. So, the format is as follows:

*Hostname\_timestamp.tgz*

An example is as follows:

ACE-1\_2009\_05\_06\_15\_24\_57.tgz

**Archive Directory Structure and Filenames**

The ACE uses a flat directory structure for the backup archive. The ACE provides file extensions for the individual files that it backs up so that you can identify the types of files easily when restoring an archive. All files are stored in a single directory that is tarred and GZIPed as follows:

```
ACE-1_Ctx1_2009_05_06_07_24_57.tgz
ACE-1_Ctx1_2009_05_06_07_24_57\
 context_name-running
 context_name-startup
 context_name-chkpt_name.chkpt
 context_name-cert_name.cert
 context_name-key_name.key
 context_name-script_name.tcl
 context_name-license_name.lic
```

**Guidelines and Limitations**

The backup and restore functions have the following configuration guidelines and limitations:

- Store the backup archive on disk0: in the context of the ACE where you intend to restore the files. Use the Admin context for a full backup and the corresponding context for user contexts.
- When you back up the running-configuration file, the ACE uses the output of the **show running-configuration** CLI command as the basis for the archive file.
- The ACE backs up only exportable certificates and keys.
- License files are backed up only when you back up the Admin context.
- Use a pass phrase to back up SSL keys in encrypted form. Remember the pass phrase or write it down and store it in a safe location. When you restore the encrypted keys, the ACE prompts you for the pass phrase to decrypt the keys. If you do not use a pass phrase when you back up the SSL keys, the ACE restores the keys with AES-256 encryption using OpenSSL software.
- Only probe scripts that reside in disk0: need to be backed up. The prepackaged probe scripts in the probe: directory are always available. When you perform a backup, the ACE automatically identifies and backs up the scripts in disk0: that are required by the configuration.
- The ACE does not resolve any other dependencies required by the configuration during a backup except for scripts that reside in disk0:. For example, if you configured SSL certificates in an SSL proxy in the running-configuration file, but you later deleted the certificates, the backup proceeds anyway as if the certificates still existed.
- To perform a restore operation, you must have the admin RBAC feature in your user role. ANM-admin and ORG-admin have access to this feature by default. Custom roles with the ANM Inventory and Virtual Context role tasks set to create or modify can also access this feature.
- When you instruct the ACE to restore the archive for the entire ACE, it restores the Admin context completely first, and then it restores the other contexts. The ACE restores all dependencies before it restores the running configuration. The order in which the ACE restores dependencies is as follows:
  - License files
  - SSL certificates and key files
  - Health-monitoring scripts
  - Checkpoints
  - Startup-configuration file
  - Running-configuration file
- When you restore the ACE, previously installed license files are uninstalled and the license files in the backup file are installed in their place.
- In a redundant configuration, if the archive that you want to restore is different from the peer configurations in the FT group, redundancy may not operate properly after the restore.
- You can restore a single context from a full backup archive provided that:
  - You execute the restore operation in the context that you want to restore
  - All files dependencies for the context exist in the full backup archive
- To enable ANM to synchronize the CLI after a successful restore, do not navigate from the Backup / Restore page until the Latest Restore status changes from In Progress to Success. If you navigate to another page before the restore process is complete, the CLI will not synchronize until you return to the Backup / Restore page.

### Defaults

Table 6-11 lists the default settings for the backup and restore function parameters.

**Table 6-11** Default Backup and Restore Parameters

| Parameter                  | Default                                                                                                                                                                                                                                                                                                                      |
|----------------------------|------------------------------------------------------------------------------------------------------------------------------------------------------------------------------------------------------------------------------------------------------------------------------------------------------------------------------|
| Backed up files            | By default the ACE backs up the following files in the current context: <ul style="list-style-type: none"> <li>• Running-configuration file</li> <li>• Startup-configuration file</li> <li>• Checkpoints</li> <li>• SSL certificates</li> <li>• SSL keys</li> <li>• Health-monitoring scripts</li> <li>• Licenses</li> </ul> |
| SSL key restore encryption | None                                                                                                                                                                                                                                                                                                                         |

This section includes the following topics:

- [Backing Up Device Configuration and Dependencies, page 6-62](#)
- [Restoring Device Configuration and Dependencies, page 6-66](#)

## Backing Up Device Configuration and Dependencies

You can create a backup of an ACE configuration and its dependencies.



### Note

When you perform the backup process from the Admin context, you can either back up the Admin context files only or you can back up the Admin context and all user contexts. When you back up from a user context, you back up the current context files only and cannot back up the ACE licenses.



### Note

If your web browser supports the Remember Passwords option and you enable this option, the web browser may fill in the Username and Password fields for user authentication. By default, these fields should be empty. You can change the username and password fields from whatever the web browser inserts into the two fields.

### Procedure

**Step 1** Choose **Config > Devices > context > System > Backup / Restore**.

The Backup / Restore table appears and displays the latest backup and restore statistics.



### Note

To refresh the table content at any time, click **Poll Now**.

**Note**

When you choose the Backup / Restore operation, ANM must poll a context if that context has not been accessed previously for this operation. The polling operation, which is necessary to obtain the latest backup and restore information, can cause a delay in the display time of the Backup / Restore table.

The Backup / Restore fields are described in [Table 6-12](#).

**Table 6-12 Backup / Restore Fields**

| Field                 | Description                                                                                                                                                                                                                                                                                                        |
|-----------------------|--------------------------------------------------------------------------------------------------------------------------------------------------------------------------------------------------------------------------------------------------------------------------------------------------------------------|
| <b>Latest Backup</b>  |                                                                                                                                                                                                                                                                                                                    |
| Backup Archive        | Name of the last *.tgz file created that contains the backup files.                                                                                                                                                                                                                                                |
| Type                  | Type of backup: Context or Full (all contexts).                                                                                                                                                                                                                                                                    |
| Start-time            | Date and time that the last backup began.                                                                                                                                                                                                                                                                          |
| Finished-time         | Date and time that the last backup ended.                                                                                                                                                                                                                                                                          |
| Status                | Status of the last context to be backed up: Success, In Progress, or Failed. Click the status link to view status details.                                                                                                                                                                                         |
| Current vc            | Name of the last context in the backup process.                                                                                                                                                                                                                                                                    |
| Completed             | Number of context backups completed compared to the total number of context backup requests.<br>For example: <ul style="list-style-type: none"> <li>• 2/2 = Two context backups completed/Two context backups requested</li> <li>• 0/1 = No context backup completed/One context backup requested</li> </ul>       |
| <b>Latest Restore</b> |                                                                                                                                                                                                                                                                                                                    |
| Backup Archive        | Name of the *.tgz file used in during the restore process.                                                                                                                                                                                                                                                         |
| Type                  | Type of restore: Context or Full (all contexts).                                                                                                                                                                                                                                                                   |
| Start-time            | Date and time that the last restore began.                                                                                                                                                                                                                                                                         |
| Finished-time         | Date and time that the last restore ended.                                                                                                                                                                                                                                                                         |
| Status                | Status of the last restore: Success, In Progress, or Failed. Click the status to view status details.                                                                                                                                                                                                              |
| Current vc            | Name of the last context in the restore process.                                                                                                                                                                                                                                                                   |
| Completed             | Number of context restores completed compared to the total number of context restore requests.<br>For example: <ul style="list-style-type: none"> <li>• 2/2 = Two context restores completed/Two context restores requested</li> <li>• 0/1 = No context restore completed/One context restore requested</li> </ul> |

**Step 2** Click **Backup**.

The Backup window appears.

**Step 3** In the Backup window, click the radio button of the location where the ACE is to save the backup files:

- **Backup config on ACE (disk0:)**—This is the default. Go to Step 9.
- **Backup config on ACE (disk0:) and then copy to remote system**—The Remote System attributes step appears. Go to Step 4.

- Step 4** Click the radio button of the transfer protocol to use:
- **FTP**—File Transfer Protocol
  - **SFTP**—Secure File Transfer Protocol
  - **TFTP**—Trivial File Transfer Protocol
- Step 5** In the Username field, enter the username that the remote server requires for user authentication. This field appears for FTP and SFTP only.
- Step 6** In the Password field, enter the password that the remote server requires for user authentication. This field appears for FTP and SFTP only.
- Step 7** In the IP Address field, enter the IP address of the remote server.
- Step 8** In the Backup File Path in Remote System field, enter the full path for the remote server.
- Step 9** Check the **Backup All Contexts** checkbox if you want the ACE to create a backup that contains the files of the Admin context and every user context or uncheck the check box to create a backup of the Admin context files only.
- This field appears for the Admin context only.
- Step 10** Indicate the components to exclude from the backup process: Checkpoints or SSL Files.
- To exclude a component, double-click on it in the Available box to move it to the Selected box. You can also use the right and left arrows to move selected items between the two boxes.



---

**Caution** If you exclude the SSL Files component and then restore the ACE using this archived backup, these files are removed from the ACE. To save these files prior to performing a restore with this backup, use the **crypto export** CLI command to export the keys to a remote server and use the **copy** CLI command to copy the license files to disk0: as .tar files.

---

- Step 11** In the Pass Phrase field, enter the pass phrase that you specify to encrypt the backed up SSL keys. Enter the pass phrase as an unquoted text string with no spaces and a maximum of 40 alphanumeric characters. If you enter a pass phrase but exclude the SSL files from the archive, the ACE does not use the pass phrase.
- Step 12** Click **OK** to begin the backup process.
- The following actions occur depending on where ANM saves the files:
- disk0: only—ANM permits continued GUI functionality during the backup process and polls the ACE for the backup status, which it displays on the Backup / Restore page.
  - disk0: and a remote server— ANM suspends GUI operation and displays a “Please Wait” message in the Backup dialog box until the process is complete. During this process, ANM instructs the ACE to create and save the backup file locally to disk0: and then place a copy of the file on the specified remote server.
- Step 13** In the Backup / Restore page, click **Poll Now** or click the browser refresh button to ensure that the latest backup statistics are displayed, and then click on the Status link (**Success**, **In Progress**, or **Failed**) located in the Latest Backup column to view details of the backup operation.
- If the backup status is either Success or In Progress, then the Show Backup Status Detail popup window appears and displays a list of the files successfully backed up. When the backup status is In Progress, ANM polls the ACE every 2 minutes to retrieve the latest status information and then it automatically



updates the status information displayed. The polling continues until ANM receives a status of either Success or Failed. If the backup status is Failed, then the Show Backup Errors popup window appears, displaying the reason for the failed backup attempt.

---

**Related Topics**

- [Performing Device Backup and Restore Functions, page 6-59](#)
- [Restoring Device Configuration and Dependencies, page 6-66](#)
- [Performing Global Device Backup and Copy Functions, page 6-68](#)

## Restoring Device Configuration and Dependencies

You can restore an ACE configuration and its dependencies using a backup file.



### Caution

The restore operation clears any existing SSL certificate and key-pair files, license files, and checkpoints in a context before it restores the backup archive file. If your configuration includes SSL files or checkpoints and you excluded them when you created the backup archive, those files will no longer exist in the context after you restore the backup archive. To preserve any existing exportable SSL certificate and key files in the context, before you execute the restore operation, export the certificates and keys that you want to keep to an FTP, SFTP, or TFTP server by using the CLI and the **crypto export** command. After you restore the archive, import the SSL files into the context. For details on exporting and importing SSL certificate and key pair files using the CLI, see the *Cisco Application Control Engine Module SSL Configuration Guide*.

You can also use the `exclude` option of the `restore` command to instruct the ACE not to clear the SSL files in `disk0:` and to ignore the SSL files in the backup archive when the ACE restores the backup.



### Note

If your web browser supports the Remember Passwords option and you enable this option, the web browser may fill in the Username and Password fields for user authentication. By default, these fields should be empty. You can change the username and password fields from whatever the web browser inserts into the two fields.

### Prerequisites

If you are going to restore the Admin context files plus all user context files, use a backup file that was created from the Admin context with the Backup All Contexts checkbox checked (see the “[Backing Up Device Configuration and Dependencies](#)” section on page 6-62).

### Procedure

**Step 1** Choose **Config > Devices > context > System > Backup / Restore**.

The Backup / Restore table appears.



**Note** To refresh the table content at any time, click **Poll Now**.



**Note** When you perform the restore process from the Admin context, you can either restore the Admin context files only or you can restore the Admin context files plus all user context files. When you perform the restore process from a user context, you can restore the current context files only.

The Backup / Restore fields are described in [Table 6-12](#).

**Step 2** Click **Restore**.

The Restore window appears.

- Step 3** In the Restore window, click the desired radio button to specify the location where the backup files are located saved:
- **Choose a backup file on the ACE (disk0:)**—This is the default. Go to Step 9.
  - **Choose a backup file from remote system**—The Remote System attributes step appears. Go to Step 4.
- Step 4** Click the radio button of the transfer protocol to use:
- **FTP**—File Transfer Protocol
  - **SFTP**—Secure File Transfer Protocol
  - **TFTP**—Trivial File Transfer Protocol
- Step 5** In the Username field, enter the username that the remote file system requires for user authentication. This field appears for FTP and SFTP only.
- Step 6** In the Password field, enter the password that the remote file system requires for user authentication. This field appears for FTP and SFTP only.
- Step 7** In the IP Address field, enter the IP address of the remote server.
- Step 8** In the Backup File Path in Remote System field, enter the full path of the backup file, including the backup filename, to be copied from the remote server.
- Step 9** Check the **Restore All Contexts** checkbox if you want the ACE to restore the files for every context or uncheck the checkbox to restore the Admin context files only.
- This field appears for the Admin context only.
- Step 10** Check the **Exclude SSL Files** checkbox if you want to preserve the SSL files currently loaded on the ACE and not use the backup file's SSL files.

**Caution**

---

The restore function deletes all SSL files currently loaded on the ACE unless you check the Exclude SSL Files option. If you do not check this option, the restore functions loads the SSL files included in the backup file. If the backup files does not include SSL files, the ACE will not have any SSL files loaded on it when the restore process is complete. You will then need to import copies of the SSL files from a remote server.

---

- Step 11** In the Pass Phrase field, enter the pass phrase that is used to encrypt the backed up SSL keys in the archive.
- Enter the pass phrase as an unquoted text string with no spaces and a maximum of 40 alphanumeric characters. The Pass Phrase field does not appear when you check the Exclude SSL Files checkbox.
- Step 12** Click **OK** to begin the restore process.

The following actions occur depending on where ANM retrieves the backup files:

- **disk0: only**—ANM permits continued GUI functionality during the restore process and polls the ACE for the backup status, which it displays on the Backup / Restore page.

**Note**

---

To enable ANM to synchronize the CLI after a successful restore, do not navigate from the Backup / Restore window until the Latest Restore status changes from In Progress to Success. If you navigate to another window before the restore process is complete, the CLI will not synchronize until you return to the Backup / Restore window.

---

- disk0: and a remote server— ANM suspends GUI operation and displays a “Please Wait” message in the Restore dialog box until the process is complete. During this process, ANM instructs the ACE to copy the backup file from the specified remote server to disk0: on the ACE and then apply the backup file to the context.

**Step 13** In the Backup / Restore page, click **Poll Now** or click the browser refresh button to ensure that the latest restore statistics are displayed, then click on the Status link (**Success**, **In Progress**, or **Failed**) located in the Latest Backup column to view details of the restore operation.

If the restore status is either Success or In Progress, then the Show Restore Status Detail popup window appears and displays a list of the files successfully restored. When the restore status is In Progress, ANM polls the ACE every 2 minutes to retrieve the latest status information and then it automatically updates the status information displayed. The polling continues until ANM receives a status of either Success or Failed. If the restored status is Failed, then the Show Restored Errors popup window appears, displaying the reason for the failed restore attempt.

#### Related Topics

- [Performing Device Backup and Restore Functions, page 6-59](#)
- [Backing Up Device Configuration and Dependencies, page 6-62](#)
- [Performing Global Device Backup and Copy Functions, page 6-68](#)

## Performing Global Device Backup and Copy Functions



#### Note

The global backup and copy functions are available for the ACE module A2(3.0), ACE appliance A4(1.0), and later releases of either device type.

The global backup and copy functions allow you to either back up the configuration and dependencies of multiple ACEs simultaneously or copy existing backup configuration files from disk0: of multiple ACEs to a remote server. Configuration dependencies are those files that are required to exist on the ACE so that a configuration can be applied to it. Such files include health-monitoring scripts, SSL certificates, SSL keys, and so on. This feature allows you to back up and restore the following configuration files and dependencies:

- License files
- Running-configuration files
- Startup-configuration files
- Checkpoints
- SSL files (SSL certificates and keys)
- Health-monitoring scripts

During the backup, each ACE saves its configuration files locally to disk0: in a single directory that is tarred and GZipped. For more information about the backup function, including guidelines and restrictions, see the “[Performing Device Backup and Restore Functions](#)” section on page 6-59.

This section includes the following topics:

- [Backing Up Multiple Device Configuration and SSL Files, page 6-69](#)
- [Associating a Global Backup Schedule with a Device, page 6-71](#)

- [Managing Global Backup Schedules, page 6-73](#)
- [Copying Existing Tarded Backup Files to a Remote Server, page 6-77](#)

## Backing Up Multiple Device Configuration and SSL Files

You can back up the configuration and SSL files for multiple ACEs simultaneously.



### Note

If your web browser supports the Remember Passwords option and you enable this option, the web browser may fill in the Username and Password fields for user authentication. By default, these fields should be empty. You can change the username and password fields from whatever the web browser inserts into the two fields.

### Procedure

**Step 1** Choose **Config > Global > All Backups**.

The Backups table appears and displays a list of the available ACEs.



### Note

To refresh the table content at any time, click **Poll Now**.



### Note

When you choose the All Backups operation, ANM must poll all Admin contexts that have not been accessed previously for this operation. The polling operation, which is necessary to obtain the latest backup and restore information, can cause a delay in the display time of the Backups table.

The Backups fields are described in [Table 6-13](#).

**Table 6-13**      **Backups Fields**

| Field                 | Description                                                                                                                                                     |
|-----------------------|-----------------------------------------------------------------------------------------------------------------------------------------------------------------|
| Name                  | Name of the ACE.                                                                                                                                                |
| Management IPs        | Management interface IP addresses. When there are multiple IP addresses, they display as shown in the following example: 10.77.241.18/10.77.241.28/10.77.241.38 |
| Latest Backup Time    | Date and time that the last backup occurred.                                                                                                                    |
| Latest Backup Status  | Status of the last backup attempt: Success, In Progress, or Failed. Click the status link to view status details.                                               |
| Latest Restore Time   | Date and time that the last restore occurred.                                                                                                                   |
| Latest Restore Status | Status of the last restore attempt: Success, In Progress, or Failed. Click the status link to view status details.                                              |
| Last Poll Time        | Date and time that ANM last polled the device for backup statistics.                                                                                            |
| Schedules             | Backup schedule associated with the ACE.                                                                                                                        |

**Step 2** In the Backups table, check the checkbox of the ACE or ACEs to back up.



**Note** To choose all of the ACEs, check the Name checkbox.

**Step 3** Click **Backup**.

The Backup on devices dialog box appears.

**Step 4** In the Backup on devices dialog box, check the Backup All Contexts checkbox if you want each ACE to create a backup that contains the files of its Admin context and every user context or uncheck the checkbox to create a backup of the Admin context files only.

**Step 5** Indicate the components that you want to exclude from the backup process: Checkpoints or SSL Files. To exclude a component, click on it in the Available box and then click Add (right arrow) to move it to the Selected box. Use Remove (left arrow) to move items from the Selected box back to the Available box if needed.



**Caution** If you exclude the SSL Files component and then restore the ACE using this archived backup, these files are removed from the ACE. To save these files prior to performing a restore with this backup, use the **crypto export** CLI command to export the keys to a remote server and use the **copy** CLI command to copy the license files to disk0: as .tar files.

**Step 6** In the Pass Phrase field, enter the pass phrase that you specify to encrypt the backed up SSL keys.

Enter the pass phrase as an unquoted text string with no spaces and a maximum of 40 alphanumeric characters. If you enter a pass phrase but excluded the SSL files from the archive, the ACE does not use the pass phrase.

**Step 7** Click **OK** to begin the backup.

**Step 8** In the Backups page, click **Poll Now** or click the browser refresh button to ensure that the latest statistics are displayed, and then click on the Status link (**Success**, **In Progress**, or **Failed**) located in the Latest Backup Status column to view details of the backup.

If the backup status is either Success or In Progress, then the Show Backup Status Detail popup window appears and displays a list of the files successfully backed up. When the backup status is In Progress, ANM polls each ACE every 2 minutes to retrieve the latest status information and then it automatically updates the status information displayed. The polling continues until ANM receives a status of either Success or Failed.

If the backup status is Failed, then the Show Backup Errors popup window appears, displaying the reason for the failed backup attempt.

#### Related Topics

- [Associating a Global Backup Schedule with a Device, page 6-71](#)
- [Managing Global Backup Schedules, page 6-73](#)
- [Copying Existing Tarred Backup Files to a Remote Server, page 6-77](#)
- [Performing Device Backup and Restore Functions, page 6-59](#)

## Associating a Global Backup Schedule with a Device

You can schedule ANM to perform a global backup either as a one-time operation at some future time or on a regular basis. You do this by creating a backup schedule and then associating the schedule with one or more ACE devices.

### Procedure

---

**Step 1** Choose **Config > Global > All Backups**.

The Backups table appears and displays a list of the available ACEs (see [Table 6-13](#)).

**Step 2** In the Backups table, check the checkbox of the ACEs that you want to schedule for backups.

When you choose multiple devices to schedule a backup, ANM checks to ensure that the following attributes match between the devices:

- Schedules currently associated with the devices
- Remote location details
- Protocol used to connect to the remote location
- Pass phrase used to encrypt the backed up SSL keys
- Specified components to exclude

If these attributes do not match between the selected devices, ANM displays an error message and does not allow you to continue scheduling a global backup. For example, if the attributes of the selected devices do not match, ANM displays an error message such as:

One or more field values do not match in the selected devices. Select only devices that have matching field values.

**Step 3** Click **Schedule Backup**.

The Scheduled Backup popup window appears, which includes a list of the devices that you selected and backup schedule parameters that you must configure.

**Step 4** From the Scheduled Backup popup window, configure the scheduled backup parameters as shown in [Table 6-14](#).

Table 6-14 Scheduling a Backup

| Item                                                         | Description                                                                                                                                                                                                                                                                                                                                                                                                                                                                                                                                                                                                                                                                                                                                                                                                                                                                                                                                                                                                                                                                                            |
|--------------------------------------------------------------|--------------------------------------------------------------------------------------------------------------------------------------------------------------------------------------------------------------------------------------------------------------------------------------------------------------------------------------------------------------------------------------------------------------------------------------------------------------------------------------------------------------------------------------------------------------------------------------------------------------------------------------------------------------------------------------------------------------------------------------------------------------------------------------------------------------------------------------------------------------------------------------------------------------------------------------------------------------------------------------------------------------------------------------------------------------------------------------------------------|
| Schedule                                                     | <p>Associate one or more backup schedule with the devices by performing one or both of the following:</p> <ul style="list-style-type: none"> <li>• To associate an existing schedule listed in the Available box, double-click the schedule to move it to the Selected box. You can also use the arrow buttons to move selected schedules between the Available and Selected boxes.</li> <li>• To create a backup schedule for the devices, click <b>Create</b>. The fields for creating a new schedule appear in the Schedule section. Assign a unique name to the schedule, define the schedule's operating parameters, and click <b>OK</b>. The new schedule is added to the Selected box.</li> </ul> <p>For more information about creating a schedule, see the <a href="#">“Creating a Backup Schedule” section on page 6-73</a>.</p> <p>To display the current settings of schedule in the Selected box, choose the schedule and click <b>View</b>. The schedule details display in the Schedules section. You cannot modify the settings. Click <b>Cancel</b> to close the details display.</p> |
| Backup a file on ACE (disk0:) and then copy to remote system | <p>Configure where the backup is to be saved remotely as follows:</p> <ol style="list-style-type: none"> <li>a. Specify the file transfer protocol to use by clicking one of the following radio buttons: <ul style="list-style-type: none"> <li>• FTP</li> <li>• SFTP</li> <li>• TFTP</li> </ul> </li> <li>b. In the Username text box, enter the username associated with the remote server.</li> <li>c. In the Password text box, enter the password associated with the username.</li> <li>d. In the IP Address text box, enter the remote server IP address.</li> <li>e. In the Backup File Path in Remote System text box, enter the full path for the backup file on the remote server.</li> </ol>                                                                                                                                                                                                                                                                                                                                                                                              |
| Backup on devices                                            | <p>Define the items to back up as follows:</p> <ol style="list-style-type: none"> <li>a. Indicate the components that you want to exclude from the backup process: Checkpoints or SSL Files. Double-click an item to move it to the Selected box. You can also use the arrow buttons to move an item between the Available and Selected boxes.</li> <li>b. Enter the pass phrase that you specify to encrypt the backed up SSL keys.<br/>Enter the pass phrase as an unquoted text string with no spaces and a maximum of 40 alphanumeric characters. If you enter a pass phrase but excluded the SSL files from the archive, the ACE does not use the pass phrase.</li> </ol> <p> <b>Note</b> The Backup All Contexts checkbox is checked by default to create a backup that contains the files of the Admin context and every user context on the ACE. You cannot change this setting.</p>                                                                                                                        |

**Step 5** From the Scheduled Backup popup window, do one of the following:



- Click **OK** to save the scheduled backup configuration, close the popup window, and return to the Backups window, which now displays the associated backup schedule with the ACE.
- Click **Cancel** to ignore the scheduled backup information, close the popup window, and return to the Backups window.

#### Related Topics

- [Managing Global Backup Schedules, page 6-73](#)
- [Creating a Backup Schedule, page 6-73](#)
- [Updating an Existing Backup Schedule, page 6-76](#)
- [Backing Up Multiple Device Configuration and SSL Files, page 6-69](#)

## Managing Global Backup Schedules

You can create multiple schedules that allow ANM to perform a global backup at the time specified in a particular schedule. You assign each schedule a name and then configure it with a set of parameters that specify when ANM is to perform the backup. For example, you can create a schedule that has ANM create a weekly backup every Tuesday at 1:00AM. After you create the schedule, you can apply it to one or more devices. If you change the schedule's configuration, such as the day of the week when the backup is made, the change is applied the devices that use the schedule.

This section includes the following topics:

- [Creating a Backup Schedule, page 6-73](#)
- [Updating an Existing Backup Schedule, page 6-76](#)
- [Deleting a Backup Schedule, page 6-76](#)

### Creating a Backup Schedule

You can create a backup schedule that you can apply to one or more devices.

#### Procedure

- Step 1** Choose **Config > Global > All Schedules**.

The Schedules table appears and displays the information described in [Table 6-15](#).

**Table 6-15** All Schedules Fields

| Item | Description                                                                              |
|------|------------------------------------------------------------------------------------------|
| Name | Schedule name.                                                                           |
| Type | Schedule type: Once, Daily, Weekly, or Monthly.                                          |
| Date | Date that ANM performs a backup. This column applies the schedule type of the type Once. |
| Time | Time of day when ANM performs the backup.                                                |

Table 6-15 All Schedules Fields

| Item               | Description                                                                                                                                                                                                                                                                                                                                                                                                                                                                                                                                                                                                                                                                                                                                                                                                                                                                                                               |
|--------------------|---------------------------------------------------------------------------------------------------------------------------------------------------------------------------------------------------------------------------------------------------------------------------------------------------------------------------------------------------------------------------------------------------------------------------------------------------------------------------------------------------------------------------------------------------------------------------------------------------------------------------------------------------------------------------------------------------------------------------------------------------------------------------------------------------------------------------------------------------------------------------------------------------------------------------|
| Daily Recurrence   | <p>Indicates the following depending on schedule type:</p> <ul style="list-style-type: none"> <li>Daily schedule—Number of days between backups. For example, a value of 4 in this field indicates that ANM performs one backup every 4 days. When N/A appears in this field for the type Daily, the schedule is configured to perform a daily backup everyday (Monday–Sunday). In this case, the days are listed in the Week Days column.</li> <li>Monthly schedule—Day of the month when the backup is to occur. For example, a value of 3 indicates that the backup occurs on the third day of each month. When N/A appears in this field for the type Monthly, the schedule is configured to perform a monthly backup on the occurrence of a particular day of the week. For example, you can schedule the backup for the second Sunday of each month, in which case, Sun appears in the Week Days column.</li> </ul> |
| Weekly Recurrence  | <p>Indicates the following depending on schedule type:</p> <ul style="list-style-type: none"> <li>Weekly schedule—This value is always 1 for any configured weekly schedule and indicates that a backup will occur every week on the indicated days (see Week Days).</li> <li>Monthly schedule—Week of the month when the backup is to occur. For example, a value of 3 indicates that the backup occurs on the third week of each month.</li> </ul>                                                                                                                                                                                                                                                                                                                                                                                                                                                                      |
| Monthly Recurrence | Number of times the monthly schedule occurs.                                                                                                                                                                                                                                                                                                                                                                                                                                                                                                                                                                                                                                                                                                                                                                                                                                                                              |
| Week Days          | <p>Indicates the days of the week when ANM performs a backup depending on the schedule type:</p> <ul style="list-style-type: none"> <li>Weekly schedule—Days of the week when the backup occurs.</li> <li>Monthly schedule—Day of the week when the backup occurs. The Weekly Recurrence value indicates which monthly occurrence of the specified week day that the backup occurs. For example, if Weekly Recurrence value is 3 and the Week Days value is Sunday, then the monthly backup occurs every third Sunday of the month.</li> </ul>                                                                                                                                                                                                                                                                                                                                                                            |
| Devices            | Name of the ACEs associated with the schedule. ANM adds devices to this field after you associate the schedule with an ACE backup (see the <a href="#">“Backing Up Multiple Device Configuration and SSL Files” section on page 6-69</a> ).                                                                                                                                                                                                                                                                                                                                                                                                                                                                                                                                                                                                                                                                               |

**Step 2** From the Schedules table window, click **Create Schedule**.

The Create Schedule popup window appears.

**Step 3** From the Create Schedule popup window, create and configure the new backup schedule as described in [Table 6-16](#).

**Table 6-16** Create Schedule Fields

| Item           | Description                                                                                                                                                                                                                                                                                                                                                                                                                                                                                                                                                                                                                                                                                                                                                                                                                                                                                                                                                                                                                                                                                                                                                                                                                                                                                                                                                                                                                                                                                                                                                                                                                                                                                                                                                                                                                                                          |
|----------------|----------------------------------------------------------------------------------------------------------------------------------------------------------------------------------------------------------------------------------------------------------------------------------------------------------------------------------------------------------------------------------------------------------------------------------------------------------------------------------------------------------------------------------------------------------------------------------------------------------------------------------------------------------------------------------------------------------------------------------------------------------------------------------------------------------------------------------------------------------------------------------------------------------------------------------------------------------------------------------------------------------------------------------------------------------------------------------------------------------------------------------------------------------------------------------------------------------------------------------------------------------------------------------------------------------------------------------------------------------------------------------------------------------------------------------------------------------------------------------------------------------------------------------------------------------------------------------------------------------------------------------------------------------------------------------------------------------------------------------------------------------------------------------------------------------------------------------------------------------------------|
| Name           | Unique schedule name.                                                                                                                                                                                                                                                                                                                                                                                                                                                                                                                                                                                                                                                                                                                                                                                                                                                                                                                                                                                                                                                                                                                                                                                                                                                                                                                                                                                                                                                                                                                                                                                                                                                                                                                                                                                                                                                |
| Schedule types | <p>Schedule types that you can create to specify when a backup is to occur. Choose one of the following:</p> <ul style="list-style-type: none"> <li>• <b>Once:</b> Specifies a one-time backup as follows: <ul style="list-style-type: none"> <li>– <b>Date:</b> Date that ANM performs a backup. Use the calendar tool to select the date</li> <li>– <b>Time:</b> Time of day when ANM performs the backup.</li> </ul> </li> <li>• <b>Daily:</b> Specifies a daily schedule as follows: <ul style="list-style-type: none"> <li>– <b>Time:</b> Time of day when ANM performs the backup.</li> <li>– <b>Repeat:</b> Specifies how often the schedule is repeated as follows: <ul style="list-style-type: none"> <li>- <b>Every:</b> Specifies the number of days between backups.</li> <li>- <b>Everyday (Mon-Sun):</b> Specifies that a backup is performed each day.</li> </ul> </li> </ul> </li> <li>• <b>Weekly:</b> Specifies a weekly schedule as follows: <ul style="list-style-type: none"> <li>– <b>Time:</b> Time of day when ANM performs the backup.</li> <li>– <b>Repeat Every week on:</b> Specifies the days of the week that the backup is performed.</li> </ul> </li> <li>• <b>Monthly:</b> Specifies a monthly schedule as follows: <ul style="list-style-type: none"> <li>– <b>Time:</b> Time of day when ANM performs the backup.</li> <li>– <b>Repeat:</b> <ul style="list-style-type: none"> <li>- <b>Day (number) of every month:</b> Specifies the day of the month when the backup is to occur. For example, you can schedule a backup for 15th day of the month.</li> <li>- <b>Occurrence of the day (name) of every month:</b> Specifies the occurrence of a weekday during the month when the backup is performed. For example, you can schedule a backup to occur every second Saturday of the month.</li> </ul> </li> </ul> </li> </ul> |

**Step 4** Do one of the following:

- Click **OK** to save the backup schedule, close the popup window, and return to the Schedules window. The Schedules window displays the new schedule.
- Click **Cancel** to close the popup window without saving your information and return to the Schedules window.

**Related Topics**

- [Managing Global Backup Schedules, page 6-73](#)
- [Updating an Existing Backup Schedule, page 6-76](#)
- [Deleting a Backup Schedule, page 6-76](#)
- [Associating a Global Backup Schedule with a Device, page 6-71](#)

## Updating an Existing Backup Schedule

You can update an existing backup schedule. When you update a schedule that is currently associated with devices, the changes that you make to the schedule affect the associated devices.



### Caution

Modifying an existing schedule affects the backup schedule of any device currently associated with the schedule.

### Procedure

**Step 1** Choose **Config > Global > All Schedules**.

The Schedules window appears and displays the information described in [Table 6-15](#).

**Step 2** From the Schedules window, click the radio button of the backup schedule to update and click **Update Schedule**.

The Update Schedule popup window appears.

**Step 3** From the Update Schedule popup window, update backup schedule as described in [Table 6-16](#).



**Note** You cannot modify the schedule name.

**Step 4** From the Update Schedule popup window, do one of the following:

- Click **OK** to save your changes, close the popup window, and return to the Schedules window.
- Click **Cancel** to close the po-up window without saving your changes and return to the Schedules window.

### Related Topics

- [Managing Global Backup Schedules, page 6-73](#)
- [Creating a Backup Schedule, page 6-73](#)
- [Deleting a Backup Schedule, page 6-76](#)
- [Associating a Global Backup Schedule with a Device, page 6-71](#)

## Deleting a Backup Schedule

You can delete an existing global backup schedule.



### Caution

Deleting a backup schedule removes the schedule from any device currently associated with it.

### Procedure

**Step 1** Choose **Config > Global > All Schedules**.

The Schedules window appears and displays the information described in [Table 6-15](#).

- Step 2** From the Schedules window, click the radio button of the backup schedule to delete and click **Delete**. The Delete Confirmation popup window appears.
- Step 3** From the Delete Confirmation popup window, do one of the following:
- Click **OK** to delete the schedule, close the popup window, and return to the Schedules window. The schedule is removed from the list of schedules.
  - Click **Cancel** to ignore the delete request, close the popup window, and return to the Schedules window.
- 

#### Related Topics

- [Managing Global Backup Schedules, page 6-73](#)
- [Creating a Backup Schedule, page 6-73](#)
- [Associating a Global Backup Schedule with a Device, page 6-71](#)

## Copying Existing Tared Backup Files to a Remote Server

You can copy an existing back up file from disk0: to a remote server. During the global backup process, each ACE creates a tared file containing its backup files and saves it locally on disk0:. You can use ANM to simultaneously copy these tarred files from multiple ACEs to a remote server.



#### Note

If your web browser supports the Remember Passwords option and you enable this option, the web browser may fill in the Username and Password fields for user authentication. By default, these fields should be empty. You can change the username and password fields from whatever the web browser inserts into the two fields.

---

#### Procedure

---

- Step 1** Choose **Config > Global > All Backups**.  
The Backups table appears and displays a list of the available ACEs.



**Note** To refresh the table content at any time, click **Poll Now**.

---

The Backups fields are described in [Table 6-13](#).

- Step 2** In the Backups table, check the checkbox of the ACE or ACEs to perform the copy function.



**Note** To choose all of the ACEs, check the Name checkbox.

---

- Step 3** Click **Copy**.  
The Copy backup files to a remote system dialog box appears.

- Step 4** In the Copy backup files to a remote system dialog box, choose the backup file to copy from the selected device.

This option appears only when you have selected a specific device for the copy operation in Step 2. If you selected multiple devices in Step 2, then each device copies its latest successful backup file to the remote server.

**Step 5** Click the radio button of the transfer protocol to use.

- **FTP**—File Transfer Protocol
- **SFTP**—Secure File Transfer Protocol
- **TFTP**—Trivial File Transfer Protocol

**Step 6** In the Username field, enter the username that the remote server requires for user authentication. This field appears for FTP and SFTP only.

**Step 7** In the Password field, enter the password that the remote server requires for user authentication. This field appears for FTP and SFTP only.

**Step 8** In the IP Address field, enter the IP address of the remote server.

**Step 9** In the Backup File Path in Remote System field, enter the full path for the remote server.

**Step 10** Click **OK** to begin the copy process.

ANM copies the backup files from each device to the remote server. A popup message displays to indicate whether a copy operation was successful or failed.

#### Related Topics

- [Backing Up Multiple Device Configuration and SSL Files, page 6-69](#)
- [Performing Device Backup and Restore Functions, page 6-59](#)

## Configuring Security with ACLs

An access control list (ACL) consists of a series of statements called ACL entries that collectively define the network traffic profile. Each entry permits or denies network traffic (inbound and outbound) to the parts of your network specified in the entry. In addition to an action element (permit or deny), each entry also contains a filter element based on criteria such as the source address, the destination address, the protocol, or the protocol-specific parameters. An implicit “deny all” entry exists at the end of every ACL, so you must configure an ACL on every interface where you want to permit connections; otherwise, the ACE denies all traffic on the interface.

ACLs provide basic security for your network by allowing you to control network connection setups rather than processing each packet. Such ACLs are commonly referred to as *security ACLs*.

You can configure ACLs as parts of other features; for example, security, network address translation (NAT), or server load balancing (SLB). The ACE merges these individual ACLs into one large ACL called a *merged ACL*. The ACL compiler then parses the merged ACL and generates the ACL lookup mechanisms. A match on this merged ACL can result in multiple actions. You can add, modify, or delete entries to an ACL already in the summary table, or add a new ACL to the list.

When you use ACLs, you may want to permit all email traffic on a circuit, but block FTP traffic. You can also use ACLs to allow one client to access a part of the network and prevent another client from accessing that same area.

When configuring ACLs, you must apply an ACL to an interface to control traffic on that interface. Applying an ACL on an interface assigns the ACL and its entries to that interface.

You can apply only one extended ACL to each direction (inbound or outbound) of an interface. You can also apply the same ACL on multiple interfaces. You can apply EtherType ACLs in only the inbound direction and on only Layer 2 interfaces.

**Note**

By default, all traffic is denied by the ACE unless explicitly allowed. Only traffic that is explicitly allowed in an ACL can pass. All other traffic is denied.

This section includes the following topics:

- [Creating ACLs, page 6-79](#)
- [Setting Extended ACL Attributes, page 6-82](#)
- [Resequencing Extended ACLs, page 6-87](#)
- [Setting EtherType ACL Attributes, page 6-87](#)
- [Displaying ACL Information and Statistics, page 6-89](#)

## Creating ACLs

You can create an ACL.

**Note**

By default, the ACE denies all traffic unless explicitly allowed. Only traffic that is explicitly allowed in an ACL can pass. All other traffic is denied.

### Procedure

**Step 1**

Choose the item to configure:

- To configure a virtual context, choose **Config > Devices > *context* > Security > ACLs**.
- To configure a configuration building block, choose **Config > Global > All Building Blocks > *building\_block* > Security > ACLs**.

The ACLs table appears listing the existing ACLs. The ACL fields are described in [Table 6-17](#).

**Note**

Fields and information related to IPv6 require ACE module and ACE appliance software Version A5(1.0) or later.

Table 6-17 ACLs Table

| Field       | Description                                                                                                                                                                                                                                                                                                                                                                                                                                                                                                                                                                                                                                                                                                                                                                                                                                                                                                                                  |
|-------------|----------------------------------------------------------------------------------------------------------------------------------------------------------------------------------------------------------------------------------------------------------------------------------------------------------------------------------------------------------------------------------------------------------------------------------------------------------------------------------------------------------------------------------------------------------------------------------------------------------------------------------------------------------------------------------------------------------------------------------------------------------------------------------------------------------------------------------------------------------------------------------------------------------------------------------------------|
| Name        | Unique identifier for the ACL. Valid entries are unquoted text strings with a maximum of 64 alphanumeric characters.                                                                                                                                                                                                                                                                                                                                                                                                                                                                                                                                                                                                                                                                                                                                                                                                                         |
| Type        | Identifies the following ACL attributes: <ul style="list-style-type: none"> <li>• ACL type: <ul style="list-style-type: none"> <li>– Extended—Allows you to specify both the source and the destination IP addresses of traffic and the protocol and the action to be taken. For more information see the “<a href="#">Setting Extended ACL Attributes</a>” section on page 6-82.</li> <li>– EtherType—This ACL controls network access for non-IP traffic based on its EtherType. An EtherType is a subprotocol identifier. For more information, see the “<a href="#">Setting EtherType ACL Attributes</a>” section on page 6-87.</li> </ul> </li> <li>• (ACE module and ACE appliance software Version A5(1.0) or later only) IP address type: <ul style="list-style-type: none"> <li>– IPv4—This ACL controls network access for IPv4 traffic.</li> <li>– IPv6—This ACL controls network access for IPv6 traffic.</li> </ul> </li> </ul> |
| #           | ACL line number for extended type ACL entries.                                                                                                                                                                                                                                                                                                                                                                                                                                                                                                                                                                                                                                                                                                                                                                                                                                                                                               |
| Action      | Action to be taken (permit/deny).                                                                                                                                                                                                                                                                                                                                                                                                                                                                                                                                                                                                                                                                                                                                                                                                                                                                                                            |
| Protocol    | Protocol number or service object group to apply to this ACL entry.                                                                                                                                                                                                                                                                                                                                                                                                                                                                                                                                                                                                                                                                                                                                                                                                                                                                          |
| Source      | Source IPv6 or IPv4 address (and source netmask with port number if configured for extended type ACL) or source network object group (if configured) that is being applied to this ACL entry. IPv6 requires ACE module and ACE appliance software Version A5(1.0) or later.                                                                                                                                                                                                                                                                                                                                                                                                                                                                                                                                                                                                                                                                  |
| Destination | Destination IPv6 or IPv4 address (and destination netmask with port number if configured for extended type ACL) or destination network object group (if configured) that is applied to this ACL entry. IPv6 requires ACE module and ACE appliance software Version A5(1.0) or later.                                                                                                                                                                                                                                                                                                                                                                                                                                                                                                                                                                                                                                                         |
| ICMP        | Whether or not this ACL uses ICMP (Internet Control Message Protocol). For more information, see <a href="#">Table 6-20</a> .                                                                                                                                                                                                                                                                                                                                                                                                                                                                                                                                                                                                                                                                                                                                                                                                                |
| Interface   | VLAN interfaces associated with this ACL. For example in24,4033:24out where “in” denotes the input direction and “out” denotes the output direction.                                                                                                                                                                                                                                                                                                                                                                                                                                                                                                                                                                                                                                                                                                                                                                                         |
| Remark      | Comments for this ACL. Valid entries are unquoted text strings with a maximum of 100 characters. You can enter leading spaces at the beginning of the text or special characters. Trailing spaces are ignored.                                                                                                                                                                                                                                                                                                                                                                                                                                                                                                                                                                                                                                                                                                                               |

**Step 2** In the ACLs table, do one of the following:

- To view full details of an ACL inline, click the plus sign to the left of any table entry.
- To create an ACL, click **Add**.
- To modify an ACL, choose the radio button to the left of any table entry, and click **Edit**.
- To delete an ACL, choose the radio button to the left of any table entry, and click **Trash**.

If you choose create, the New Access List window appears.

If you choose modify, the Edit ACL or Edit ACL entry window appears based on the selected radio button to the left of any table entry.



**Step 3** Add or edit required fields as described in [Table 6-18](#).



**Note**

Fields and information related to IPv6 require ACE module and ACE appliance software Version A5(1.0) or later.

**Table 6-18** *ACL Configuration Attributes*

| Field                                                                                                                | Description                                                                                                                                                                                                                                                                                                                                                                                                                                                                                                                                              |
|----------------------------------------------------------------------------------------------------------------------|----------------------------------------------------------------------------------------------------------------------------------------------------------------------------------------------------------------------------------------------------------------------------------------------------------------------------------------------------------------------------------------------------------------------------------------------------------------------------------------------------------------------------------------------------------|
| <b>ACL Properties</b>                                                                                                |                                                                                                                                                                                                                                                                                                                                                                                                                                                                                                                                                          |
| Name                                                                                                                 | Unique identifier for the ACL. Valid entries are unquoted text strings with a maximum of 64 alphanumeric characters.                                                                                                                                                                                                                                                                                                                                                                                                                                     |
| Type                                                                                                                 | Type of ACL: <ul style="list-style-type: none"> <li>Extended—Allows you to specify both the source and the destination IP addresses of traffic, the protocol, and the action to be taken. For more information see the <a href="#">“Setting Extended ACL Attributes”</a> section on page 6-82.</li> <li>EtherType—This ACL controls network access for non-IP traffic based on its EtherType. An EtherType is a subprotocol identifier. For more information see the <a href="#">“Setting EtherType ACL Attributes”</a> section on page 6-87.</li> </ul> |
| IP Address Type                                                                                                      | Field that appears only for ACE module and ACE appliance software Version A5(1.0) or later, which supports IPv4 and IPv6. Type of IP address: IPv4 or IPv6.                                                                                                                                                                                                                                                                                                                                                                                              |
| Remark                                                                                                               | Comments that you want to include for this ACL. Valid entries are unquoted text strings with a maximum of 100 characters. You can enter leading spaces at the beginning of the text or special characters. Trailing spaces are ignored.                                                                                                                                                                                                                                                                                                                  |
| <b>ACL Entries</b>                                                                                                   |                                                                                                                                                                                                                                                                                                                                                                                                                                                                                                                                                          |
| Entry Attributes                                                                                                     | Line number, action and protocol/service object group drop-down list. For information about setting these attributes, see the <a href="#">“Setting Extended ACL Attributes”</a> section on page 6-82 or the <a href="#">“Setting EtherType ACL Attributes”</a> section on page 6-87.                                                                                                                                                                                                                                                                     |
| Source                                                                                                               | This field contains the following information for Extended ACLs only: Source IPv6 address and prefix length, IPv4 address with port number (if configured) and netmask, or source network object group (if configured) that is being applied to this ACL entry. For information about setting this attribute, see the <a href="#">“Setting Extended ACL Attributes”</a> section on page 6-82.<br>IPv6 requires ACE module and ACE appliance software Version A5(1.0) or later.                                                                           |
| Destination                                                                                                          | This field contains the following information for Extended ACLs only: Destination IPv6 address and prefix length, IPv4 address with port number (if configured) and netmask, or destination network object group (if configured) that is being applied to this ACL entry. For information about setting this attribute, see the <a href="#">“Setting Extended ACL Attributes”</a> section on page 6-82.<br>IPv6 requires ACE module and ACE appliance software Version A5(1.0) or later.                                                                 |
| Add To Table button                                                                                                  | Button to add multiple ACL entries, one at a time before clicking <b>Deploy</b> .                                                                                                                                                                                                                                                                                                                                                                                                                                                                        |
| Remove From Table button                                                                                             | Button to remove multiple ACL entries, one at a time before clicking <b>Deploy</b> .                                                                                                                                                                                                                                                                                                                                                                                                                                                                     |
| <ul style="list-style-type: none"> <li>Input/Output Direction</li> <li>Currently Assigned (ACL:Direction)</li> </ul> | Field that allows you to associate the ACL with one or more interfaces allowing only one input and one output ACL for each interface. The top left checkbox under the Interfaces section allows you to choose and apply to all interfaces “access-group input.”                                                                                                                                                                                                                                                                                          |

**Note**

To add, modify, or delete Object Groups go to the [“Configuring Object Groups” section on page 6-89](#).

**Step 4**

Do one of the following:

- Click **Deploy** to deploy this newly created ACL entries along with VLAN interface assignments that were configured.
- Click **Cancel** to exit this procedure without saving your entries and to return to the ACLs table.

**Related Topics**

- [Configuring Security with ACLs, page 6-78](#)
- [Setting EtherType ACL Attributes, page 6-87](#)
- [Setting Extended ACL Attributes, page 6-82](#)
- [Resequencing Extended ACLs, page 6-87](#)
- [Editing or Deleting ACLs, page 6-100](#)
- [Displaying ACL Information and Statistics, page 6-89](#)

## Setting Extended ACL Attributes

You can configure extended ACL attributes that allows you to specify both the source and the destination IP addresses of traffic and the protocol and the action to be taken.

For TCP, UDP, and ICMP connections, you do not need to also apply an ACL on the destination interface to allow returning traffic, because the ACE allows all returning traffic for established connections.

**Note**

By default, all traffic is denied by the ACE unless explicitly allowed. Only traffic that is explicitly allowed in an ACL can pass. All other traffic is denied.

**Note**

The ACE does not explicitly support standard ACLs. To configure a standard ACL, specify the destination address as **any** and do not specify the ports in an extended ACL.

**Procedure****Step 1**

Choose the item to configure:

- To configure a virtual context, choose **Config > Devices > context > Security > ACLs**.
- To configure a configuration building block, choose **Config > Global > All Building Blocks > building\_block > Security > ACLs**.

The ACLs table appears, listing the existing ACLs.

**Step 2**

In the ACLs table, click **Add**.

The New Access List configuration window appears.

**Step 3**

Click **Add** to add an entry to the table, or choose an existing entry and click **Edit** to modify it.

- Step 4** In the ACL Properties pane, do the following:
- Enter the ACL name.
  - For the ACL type, choose **Extended**.
  - For the IP address type, choose either **IPv4** or **IPv6**. This field appears only for ACE module and ACE appliance software Version A5(1.0) or later, which supports IPv4 and IPv6.
  - (Optional) In the Remark text box, enter comments that you want to include for this ACL. Valid entries are unquoted text strings with a maximum of 100 characters. You can enter leading spaces at the beginning of the text or special characters. Trailing spaces are ignored.
- Step 5** Configure extended ACL entries using the information in [Table 6-19](#).



**Note** Fields and information related to IPv6 require ACE module and ACE appliance software Version A5(1.0) or later.

**Table 6-19** Extended ACL Configuration Options

| Field                      | Description                                                                                                                                                                                                                                                                                                                                                                                                                                                                                                                                                                                                                                                                                                                                                                       |
|----------------------------|-----------------------------------------------------------------------------------------------------------------------------------------------------------------------------------------------------------------------------------------------------------------------------------------------------------------------------------------------------------------------------------------------------------------------------------------------------------------------------------------------------------------------------------------------------------------------------------------------------------------------------------------------------------------------------------------------------------------------------------------------------------------------------------|
| <b>Entry Attributes</b>    |                                                                                                                                                                                                                                                                                                                                                                                                                                                                                                                                                                                                                                                                                                                                                                                   |
| Line Number                | Number that specifies the position of this entry in the ACL. The position of an entry affects the lookup order of the entries in an ACL. To change the sequence of existing extended ACLs, see the <a href="#">“Resequencing Extended ACLs”</a> section on page 6-87.                                                                                                                                                                                                                                                                                                                                                                                                                                                                                                             |
| Action                     | Action to be taken: Permit or Deny.                                                                                                                                                                                                                                                                                                                                                                                                                                                                                                                                                                                                                                                                                                                                               |
| Service Object Group       | Option that is not applicable to ACE modules running 3.0(0)A1(x) and ACE 4710 appliances running image A1(x).<br>Choose a service object group to apply to this ACL.                                                                                                                                                                                                                                                                                                                                                                                                                                                                                                                                                                                                              |
| Protocol                   | Protocol or protocol number to apply to this ACL entry. <a href="#">Table 6-20</a> lists common protocol names and numbers.                                                                                                                                                                                                                                                                                                                                                                                                                                                                                                                                                                                                                                                       |
| ICMP Type                  | This field appears only when the selected protocol type is ICMP. Choose the ICMP type. <a href="#">Table 6-23</a> lists common ICMP types and numbers. <a href="#">Table 6-24</a> lists common ICMPv6 types and numbers.                                                                                                                                                                                                                                                                                                                                                                                                                                                                                                                                                          |
| ICMP Message Code Operator | This field appears only when the selected protocol type is ICMP. Choose one of the following operands to use when comparing message codes for this service object: <ul style="list-style-type: none"> <li><b>Equal To</b>—The message code must be the same as the number in the Message Code field.</li> <li><b>Greater Than</b>—The message code must be greater than the number in the Message Code field.</li> <li><b>Less Than</b>—The message code must be less than the number in the Message Code field.</li> <li><b>Not Equal To</b>—The message code must not equal the number in the Message Code field.</li> <li><b>Range</b>—The message code must be within the range of codes specified by the Min. Message Code field and the Max. Message Code field.</li> </ul> |
| ICMP Message Code          | This field appears only when the selected protocol type is ICMP and the ICMP Message Code Operator is set to one of the following: Equal To, Greater Than, Less Than, or Not Equal To. Enter the ICMP message code for this service object.                                                                                                                                                                                                                                                                                                                                                                                                                                                                                                                                       |

Table 6-19 Extended ACL Configuration Options (continued)

| Field                    | Description                                                                                                                                                                                                                                                                                                                                                                                                                                                                                                                                                                                                                                                                                                                                                                                                                                                                                                                                                                        |
|--------------------------|------------------------------------------------------------------------------------------------------------------------------------------------------------------------------------------------------------------------------------------------------------------------------------------------------------------------------------------------------------------------------------------------------------------------------------------------------------------------------------------------------------------------------------------------------------------------------------------------------------------------------------------------------------------------------------------------------------------------------------------------------------------------------------------------------------------------------------------------------------------------------------------------------------------------------------------------------------------------------------|
| ICMP Min. Message Code   | These fields appear only when the selected protocol type is ICMP and the ICMP Message Code Operator is set to Range.<br><br>Enter the beginning and ending value for a range of services for this service object. Valid entries are integers from 0 to 255. The minimum value must be less than the maximum value.                                                                                                                                                                                                                                                                                                                                                                                                                                                                                                                                                                                                                                                                 |
| ICMP Max. Message Code   |                                                                                                                                                                                                                                                                                                                                                                                                                                                                                                                                                                                                                                                                                                                                                                                                                                                                                                                                                                                    |
| <b>Source</b>            |                                                                                                                                                                                                                                                                                                                                                                                                                                                                                                                                                                                                                                                                                                                                                                                                                                                                                                                                                                                    |
| Source Network           | <p>Network traffic being received from the source network to the ACE:</p> <ul style="list-style-type: none"> <li>Any—Choose the <b>Any</b> radio button to indicate that network traffic from any source is allowed.</li> <li>IP/Netmask—(IPv4 address type) Use this field to limit access to a specific source IP address. Enter the source IP address that is allowed for this ACL. Enter a specific source IP address and choose its subnet mask.</li> <li>IP/Prefix-length—(IPv6 address type) Use this field to limit access to a specific source IP address. Enter the source IPv6 address that is allowed for this ACL and its prefix length. IPv6 requires ACE module and ACE appliance software Version A5(1.0) or later.</li> <li>Network Object Group—Choose a source network object group to apply to this ACL.</li> </ul> <p><b>Note</b> This option is not applicable to ACE modules running release 3.0(0)A1(x) and ACE 4710 appliances running release A1(x).</p> |
| Source Port Operator     | <p>Field that appears if you choose TCP or UDP in the Protocol field.</p> <p>Choose the operand to use to compare source port numbers:</p> <ul style="list-style-type: none"> <li><b>Equal To</b>—The source port must be the same as the number in the Source Port Number field.</li> <li><b>Greater Than</b>—The source port must be greater than the number in the Source Port Number field.</li> <li><b>Less Than</b>—The source port must be less than the number in the Source Port Number field.</li> <li><b>Not Equal To</b>—The source port must not equal the number in the Source Port Number field.</li> <li><b>Range</b>—The source port must be within the range of ports specified by the Lower Source Port Number field and the Upper Source Port Number field.</li> </ul>                                                                                                                                                                                         |
| Source Port Number       | <p>Field that appears if you choose one of the following the Source Port Operator field: Equal To, Greater Than, Less Than, or Not Equal To.</p> <p>Enter the port name or number from which you want to permit or deny access. For a list of ports, see the <a href="#">“ANM Ports Reference”</a> section on page A-1.</p>                                                                                                                                                                                                                                                                                                                                                                                                                                                                                                                                                                                                                                                        |
| Lower Source Port Number | <p>Field that appears if you choose Range in the Source Port Operator field.</p> <p>Enter the number of the lowest port from which you want to permit or deny access. Valid entries are from 0 to 65535. The number in this field must be less than the number entered in the Upper Source Port Number field.</p>                                                                                                                                                                                                                                                                                                                                                                                                                                                                                                                                                                                                                                                                  |
| Upper Source Port Number | <p>Field that appears if you choose Range in the Source Port Operator field.</p> <p>Enter the port number of the upper port from which you want to permit or deny access. Valid entries are from 0 to 65535. The number in this field must be greater than the number entered in the Lower Source Port Number field.</p>                                                                                                                                                                                                                                                                                                                                                                                                                                                                                                                                                                                                                                                           |

Table 6-19 Extended ACL Configuration Options (continued)

| Field                         | Description                                                                                                                                                                                                                                                                                                                                                                                                                                                                                                                                                                                                                                                                                                                                                                                                                                                                                                                                                                                                                                         |
|-------------------------------|-----------------------------------------------------------------------------------------------------------------------------------------------------------------------------------------------------------------------------------------------------------------------------------------------------------------------------------------------------------------------------------------------------------------------------------------------------------------------------------------------------------------------------------------------------------------------------------------------------------------------------------------------------------------------------------------------------------------------------------------------------------------------------------------------------------------------------------------------------------------------------------------------------------------------------------------------------------------------------------------------------------------------------------------------------|
| <b>Destination</b>            |                                                                                                                                                                                                                                                                                                                                                                                                                                                                                                                                                                                                                                                                                                                                                                                                                                                                                                                                                                                                                                                     |
| Destination Network           | <p>Network traffic being transmitted to the destination network from the ACE:</p> <ul style="list-style-type: none"> <li>• <b>Any</b>—Choose the Any radio button to indicate that network traffic to any destination is allowed.</li> <li>• <b>IP/Netmask</b>—(IPv4 address type) Use this field to limit access to a specific destination IP address. Enter the source IP address that is allowed for this ACL. Enter a specific destination IP address and choose its subnet mask.</li> <li>• <b>IP/Prefix-length</b>—(IPv6 address type) Use this field to limit access to a specific destination IP address. Enter the destination IPv6 address that is allowed for this ACL and its prefix length. IPv6 requires ACE module and ACE appliance software Version A5(1.0) or later.</li> <li>• <b>Network Object Group</b>—Choose a destination network object group to apply to this ACL.</li> </ul> <p><b>Note</b> This option is not applicable to ACE modules running release 3.0(0)A1(x) and ACE 4710 appliances running release A1(x).</p> |
| Destination Port Operator     | <p>Field that appears if you choose TCP or UDP in the Protocol field.</p> <p>Choose the operand to use to compare destination port numbers:</p> <ul style="list-style-type: none"> <li>• <b>Equal To</b>—The destination port must be the same as the number in the Destination Port Number field.</li> <li>• <b>Greater Than</b>—The destination port must be greater than the number in the Destination Port Number field.</li> <li>• <b>Less Than</b>—The destination port must be less than the number in the Destination Port Number field.</li> <li>• <b>Not Equal To</b>—The destination port must not equal the number in the Destination Port Number field.</li> <li>• <b>Range</b>—The destination port must be within the range of ports specified by the Lower Destination Port Number field and the Upper Destination Port Number field.</li> </ul>                                                                                                                                                                                    |
| Destination Port Number       | <p>Field that appears if you choose one of the following in the Destination Port Operator field: Equal To, Greater Than, Less Than, or Not Equal To.</p> <p>Enter the port name or number from which you want to permit or deny access. For a list of ports and keywords, see the <a href="#">“ANM Ports Reference” section on page A-1</a>.</p>                                                                                                                                                                                                                                                                                                                                                                                                                                                                                                                                                                                                                                                                                                    |
| Lower Destination Port Number | <p>Field that appears if you choose Range in the Destination Port Operator field.</p> <p>Enter the number of the lowest port to which you want to permit or deny access. Valid entries are from 0 to 65535. The number in this field must be less than the number entered in the Upper Destination Port Number field.</p>                                                                                                                                                                                                                                                                                                                                                                                                                                                                                                                                                                                                                                                                                                                           |
| Upper Destination Port Number | <p>Field that appears if you choose Range in the Destination Port Operator field.</p> <p>Enter the port number of the upper port to which you want to permit or deny access. Valid entries are from 0 to 65535. The number in this field must be greater than the number entered in the Lower Destination Port Number field.</p>                                                                                                                                                                                                                                                                                                                                                                                                                                                                                                                                                                                                                                                                                                                    |

**Table 6-20 Protocol Names and Numbers**

| Protocol Name <sup>1</sup> | Protocol Number | Description                                 |
|----------------------------|-----------------|---------------------------------------------|
| AH                         | 51              | Authentication Header                       |
| EIGRP                      | 88              | Enhanced IGRP                               |
| ESP                        | 50              | Encapsulated Security Payload               |
| GRE                        | 47              | Generic Routing Encapsulation               |
| ICMP                       | 1               | Internet Control Message Protocol           |
| ICMPv6 <sup>2</sup>        | 58              | Internet Control Message Protocol version 6 |
| IGMP                       | 2               | Internet Group Management Protocol          |
| IP                         | 0               | Internet Protocol                           |
| IP-In-IP                   | 4               | IP-In-IP Layer 3 Tunneling Protocol         |
| OSPF                       | 89              | Open Shortest Path First                    |
| PIM                        | 103             | Protocol Independent Multicast              |
| TCP                        | 6               | Transmission Control Protocol               |
| UDP                        | 17              | User Datagram Protocol                      |

1. For a complete list of all protocols and their numbers, see the Internet Assigned Numbers Authority available at [www.iana.org/numbers/](http://www.iana.org/numbers/)

2. ICMPv6 is not available for an IPv4 service object group.

**Step 6** In the Extended configuration pane, do one of the following:

- Click **Deploy Now** to immediately deploy this configuration on the ACE and save your entries to the running-configuration and startup-configuration files. This option appears for virtual contexts.
- Click **OK** to save your entries. This option appears for configuration building blocks.
- Click **Cancel** to exit without saving your entries and to return to the Extended table.
- Click **Next** to deploy your entries and to add another entry to the Extended table.

**Step 7** (Optional) Associate any VLAN interface to this ACL if required and do one of the following:

- Click **Deploy** to immediately deploy this configuration.
- Click **Cancel** to exit without saving your entries and to return to the ACL Summary table.

#### Related Topics

- [Configuring Security with ACLs, page 6-78](#)
- [Creating ACLs, page 6-79](#)
- [Setting EtherType ACL Attributes, page 6-87](#)
- [Resequencing Extended ACLs, page 6-87](#)
- [Editing or Deleting ACLs, page 6-100](#)
- [Displaying ACL Information and Statistics, page 6-89](#)

## Resequencing Extended ACLs

You can change the sequence of entries in an Extended ACL.



---

**Note** EtherType ACL entries cannot be resequenced.

---

### Procedure

---

**Step 1** Choose the item to configure:

- To configure a virtual context, choose **Config > Devices > context > Security > ACLs**.
- To configure a configuration building block, choose **Config > Global > All Building Blocks > building\_block > Security > ACLs**.

The ACLs table appears, listing the existing ACLs.

**Step 2** In the ACLs table, choose the Extended ACL that you want to renumber, and click the **Resequence** icon that appears to the left of the filter field.

The ACL Line Number Resequence window appears.

**Step 3** In the Start field of the ACL Line Number Resequence window, enter the number that is to be assigned to the first entry in the ACL.

Valid entries are from 1 to 2147483647.

**Step 4** In the Increment field, enter the number that is to be added to each entry in the ACL after the first entry.

Valid entries are from 1 to 2147483647.

**Step 5** Do one of the following:

- Click **Resequence** to save your entries and to return to the ACLs table.
  - Click **Cancel** to exit this procedure without saving your entries and to return to the ACLs table.
- 

### Related Topics

- [Configuring Security with ACLs, page 6-78](#)
- [Creating ACLs, page 6-79](#)
- [Setting EtherType ACL Attributes, page 6-87](#)
- [Setting Extended ACL Attributes, page 6-82](#)
- [Editing or Deleting ACLs, page 6-100](#)
- [Displaying ACL Information and Statistics, page 6-89](#)

## Setting EtherType ACL Attributes

You can configure an ACL that controls traffic based on its EtherType, which is a subprotocol identifier. EtherType ACLs support Ethernet V2 frames. EtherType ACLs do not support 802.3-formatted frames because they use a length field instead of a type field. The only exception is a bridge protocol data units (BPDU), which is SNAP encapsulated. The ACE is designed to handle BPDUs.

**Note**

By default, all traffic is denied by the ACE unless explicitly allowed. Only traffic that is explicitly allowed in an ACL can pass. All other traffic is denied.

**Procedure**

**Step 1** Choose the item to configure:

- To configure a virtual context, choose **Config > Devices > context > Security > ACLs**.
- To configure a configuration building block, choose **Config > Global > All Building Blocks > building\_block > Security > ACLs**.

The ACLs table appears, listing the existing ACLs.

**Step 2** In the ACLs table, click **Add**.

The New Access List configuration window appears.

**Step 3** In the ACL Properties pane, do the following:

- In the Name text box, enter the ACL name.
- For the Type, choose **EtherType**.
- For the IP Address Type, choose **IPv4**. This field appears only for ACE module and ACE appliance software Version A5(1.0) or later, which supports IPv4 and IPv6.

**Note**

You cannot use IPv6 with an EtherType ACL.

**Step 4** Choose one of the following radio buttons:

- **Deny** to indicate that the ACE is to block connections.
- **Permit** to indicate that the ACE is to allow connections.

**Step 5** In the Protocol field, choose one of the following the drop-down list for this ACL:

- **Any**—Specifies any EtherType.
- **BPDU**—Specifies bridge protocol data units. The ACE receives trunk port (Cisco proprietary) BPDUs because ACE ports are trunk ports. Trunk BPDUs have VLAN information inside the payload, so the ACE modifies the payload with the outgoing VLAN if you allow BPDUs. If you configure redundancy, you must allow BPDUs on both interfaces with an EtherType ACL to avoid bridging loops. For information about configuring redundancy, see the [“Understanding ACE Redundancy” section on page 13-6](#).
- **IPv6**—Specifies Internet Protocol version 6.
- **MPLS**—Specifies Multi-Protocol Label Switching. The MPLS selection applies to both MPLS unicast and MPLS multicast traffic. If you allow MPLS, ensure that Label Distribution Protocol (LDP) and Tag Distribution Protocol (TDP) TCP connections are established through the ACE by configuring both MPLS routers connected to the ACE to use the IP address on the ACE interface as the router-id for LDP or TDP sessions. LDP and TDP allow MPLS routers to negotiate the labels (addresses) used to forward packets.

**Step 6** Click **Add to Table** and add one or more ACL entries if required repeating Steps 4 and 5 as needed.

**Step 7** (Optional) Associate any VLAN interface to this ACL if required and do one of the following:

- Click **Deploy** to immediately deploy this configuration. This option appears for virtual contexts.



- Click **Cancel** to exit without saving your entries and to return to the ACL Summary table.
- 

#### Related Topics

- [Configuring Security with ACLs, page 6-78](#)
- [Creating ACLs, page 6-79](#)
- [Setting Extended ACL Attributes, page 6-82](#)
- [Resequencing Extended ACLs, page 6-87](#)
- [Editing or Deleting ACLs, page 6-100](#)
- [Displaying ACL Information and Statistics, page 6-89](#)

## Displaying ACL Information and Statistics

You can display information and statistics for a particular ACL by using the **Details** button.

#### Procedure

---

- Step 1** Choose **Config > Devices > context > Security > ACLs**.
- The ACLs table appears listing the existing ACLs.
- Step 2** In the ACLs table, choose an ACL, and click **Details**.
- The **show access-list access-list detail** CLI command output appears. For details about the displayed output fields, see either the *Cisco ACE Module Security Configuration Guide* or the *Cisco ACE 4700 Series Appliance Security Configuration Guide*, Chapter 1, “Configuring Security Access Control Lists.”
- Step 3** Click **Update Details** to refresh the output for the **show access-list access-list detail** CLI command.
- Step 4** Click **Close** to return to the ACLs table.

#### Related Topics

- [Configuring Security with ACLs, page 6-78](#)
- [Creating ACLs, page 6-79](#)
- [Setting Extended ACL Attributes, page 6-82](#)
- [Resequencing Extended ACLs, page 6-87](#)
- [Editing or Deleting ACLs, page 6-100](#)

## Configuring Object Groups

You can configure object groups that you can associate with ACLs. An **object group** is a logical grouping of objects such as hosts (servers and clients), services, and networks. When you create an object group, you choose a type, such as network or service, and then specify the objects that belong to the groups. In all, there are four types of object groups: Network, protocol, service, and ICMP-type.

After you configure an object group, you can include it in ACLs, thereby including all objects within that group and reducing overall configuration size.

This section includes the following topics:

- [Creating or Editing an Object Group, page 6-90](#)
- [Configuring IP Addresses for Object Groups, page 6-91](#)
- [Configuring Subnet Objects for Object Groups, page 6-92](#)
- [Configuring Protocols for Object Groups, page 6-93](#)
- [Configuring TCP/UDP Service Parameters for Object Groups, page 6-94](#)
- [Configuring ICMP Service Parameters for an Object Group, page 6-97](#)

## Creating or Editing an Object Group

You can create a object group or edit an existing one.

### Procedure

- Step 1** Choose the item to configure:
- To configure a virtual context, choose **Config > Devices > context > Security > Object Groups**.
  - To configure a configuration building block, choose **Config > Global > All Building Blocks > building\_block > Security > Object Groups**.



**Note** Object groups are available for only ACE modules and ACE module configuration building blocks.

The Object Groups table appears, listing existing object groups.

- Step 2** In the Object Groups table, click **Add** to create a new object group, or choose an existing object group, and click **Edit** to modify it.

The Object Groups configuration window appears.



**Note** The object group definition attributes for Protocol Selection and Service Parameter cannot be edited once defined for an object group. To edit these values, delete the object group definition and then add it again with the desired settings.

- Step 3** In the Name field of the Object Groups configuration window, enter a unique name for this object group. Valid entries are unquoted text strings with no spaces and a maximum of 64 alphanumeric characters.

- Step 4** In the Description field, enter a brief description for the object group.

- Step 5** In the Type field, choose the type of object group that you are creating:
- **Network**—The object group is based on a group of hosts or subnet IP addresses.
  - **Service**—The object group is based on TCP or UDP protocols and ports, or ICMP types, such as echo or echo-reply.

- Step 6** Do one of the following:
- Click **Deploy Now** to immediately deploy this configuration on the ACE and save your entries to the running-configuration and startup-configuration files. This option appears for virtual contexts.
  - Click **OK** to save your entries. This option appears for configuration building blocks.

- Click **Cancel** to exit without saving your entries and to return to the Object Groups table.
- Click **Next** to deploy your entries and to add another entry to the Object Groups table.

If you click **Deploy Now** or **OK**, the window refreshes with tables additional configuration options.

**Step 7** Configure objects for the object group as follows:

- For network-type object groups, options include:
  - [Configuring IP Addresses for Object Groups, page 6-91](#)
  - [Configuring Subnet Objects for Object Groups, page 6-92](#)
- For service-type object groups, options include:
  - [Configuring Protocols for Object Groups, page 6-93](#)
  - [Configuring TCP/UDP Service Parameters for Object Groups, page 6-94](#)
  - [Configuring ICMP Service Parameters for an Object Group, page 6-97](#)

## Configuring IP Addresses for Object Groups

You can specify host IP addresses for network-type object groups.



### Note

Fields and information related to IPv6 require ACE module and ACE appliance software Version A5(1.0) or later.

### Procedure

**Step 1** Choose the item to configure:

- To configure a virtual context, choose **Config > Devices > context > Security > Object Groups**.
- To configure a configuration building block, choose **Config > Global > All Building Blocks > building\_block > Security > Object Groups**.

The Object Groups table appears, listing the existing object groups.

**Step 2** In the Object Groups table, choose the object group that you want to configure host IP addresses for, and click the **Host Setting For Object Group** tab.

The Host Setting for Object Group table appears.

**Step 3** In the Host Setting for Object Group table, click **Add** to add an entry to this table.

**Step 4** Enter the host IP address as follows:

- For ACE module sand ACE appliances using a software version earlier than A5(1.0), enter the IPv4 address of a host to include in this group.
- For ACE module sand ACE appliances using software Version A5(1.0) or later, choose either of the following IP address types:
  - **IPv4**—A host with an IPv4 IP address. In the IPv4 Address field, enter the IP address of a host to include in this group.
  - **IPv6**—A host with an IPv6 IP address. In the IPv6 Address field, enter the IP address of a host to include in this group.

- Step 5** Do one of the following:
- Click **Deploy Now** to immediately deploy this configuration on the ACE and save your entries to the running-configuration and startup-configuration files. This option appears for virtual contexts.
  - Click **OK** to save your entries. This option appears for configuration building blocks.
  - Click **Cancel** to exit this procedure without saving your entries.
  - Click **Next** to deploy your entries and to add another entry to the Host Setting table.
- 

#### Related Topics

- [Configuring Object Groups, page 6-89](#)
- [Configuring Subnet Objects for Object Groups, page 6-92](#)
- [Configuring Protocols for Object Groups, page 6-93](#)
- [Configuring TCP/UDP Service Parameters for Object Groups, page 6-94](#)
- [Configuring ICMP Service Parameters for an Object Group, page 6-97](#)

## Configuring Subnet Objects for Object Groups

You can specify subnet objects for a network-type object group.



#### Note

Fields and information related to IPv6 require ACE module and ACE appliance software Version A5(1.0) or later.

---

#### Procedure

---

- Step 1** Choose the item to configure:
- To configure a virtual context, choose **Config > Devices > context > Security > Object Groups**.
  - To configure a configuration building block, choose **Config > Global > All Building Blocks > building\_block > Security > Object Groups**.
- The Object Groups table appears, listing the existing object groups.
- Step 2** In the Object Groups table, choose the object group that you want to configure subnet objects for, and click the **Network Setting For Object Group** tab.
- The Network Setting for Object Group table appears.
- Step 3** Click **Add** to add an entry to this table.
- Step 4** Enter the subnet object IP address as follows:
- For ACE module sand ACE appliances using a software version earlier than A5(1.0), enter an IPv4 address that, with the subnet mask, defines the subnet object.
  - For ACE module sand ACE appliances using software Version A5(1.0) or later, in the IP Address Type field, choose one of the following:
    - **IPv4**—A subnet object with an IPv4 IP address.
    - **IPv6**—A object with an IPv6 IP address. In the IPv6 Address field, enter the IP address.
- Step 5** Depending on the IP address type that you chose, do one of the following:

- For IPv4, in the IPv4 Address field, enter the IP address. In the Netmask field, select the subnet mask for this subnet object.
- For IPv6, in the IPv6 Address field, enter the IP address. In the Network Prefix Length field, enter the prefix length for this object.

**Step 6** Do one of the following:

- Click **Deploy Now** to immediately deploy this configuration on the ACE and save your entries to the running-configuration and startup-configuration files. This option appears for virtual contexts.
- Click **OK** to save your entries. This option appears for configuration building blocks.
- Click **Cancel** to exit this procedure without saving your entries.
- Click **Next** to deploy your entries and to add another entry to the Network Setting table.

---

#### Related Topics

- [Configuring Object Groups, page 6-89](#)
- [Configuring IP Addresses for Object Groups, page 6-91](#)
- [Configuring Protocols for Object Groups, page 6-93](#)
- [Configuring TCP/UDP Service Parameters for Object Groups, page 6-94](#)
- [Configuring ICMP Service Parameters for an Object Group, page 6-97](#)

## Configuring Protocols for Object Groups

You can specify protocols for a service-type object group.

#### Procedure

---

**Step 1** Choose the item to configure:

- To configure a virtual context, choose **Config > Devices > context > Security > Object Groups**.
- To configure a configuration building block, choose **Config > Global > All Building Blocks > building\_block > Security > Object Groups**.

The Object Groups table appears, listing the existing object groups.

**Step 2** In the Object Groups table, choose an existing service-type object group, and click the **Protocol Selection** tab.

The Protocol Selection table appears.

**Step 3** In the Protocol Selection table, click **Add** to add an entry to this table.

**Step 4** In the Protocol Number field, choose the protocol or protocol number to add to this object group.

See [Table 6-20](#) for common protocols and their numbers.

**Step 5** Do one of the following:

- Click **Deploy Now** to immediately deploy this configuration on the ACE and save your entries to the running-configuration and startup-configuration files. This option appears for virtual contexts.
- Click **OK** to save your entries. This option appears for configuration building blocks.
- Click **Cancel** to exit this procedure without saving your entries.

- Click **Next** to deploy your entries and to add another entry to the Protocol Selection table.

#### Related Topics

- [Configuring Object Groups, page 6-89](#)
- [Configuring IP Addresses for Object Groups, page 6-91](#)
- [Configuring Subnet Objects for Object Groups, page 6-92](#)
- [Configuring TCP/UDP Service Parameters for Object Groups, page 6-94](#)
- [Configuring ICMP Service Parameters for an Object Group, page 6-97](#)

## Configuring TCP/UDP Service Parameters for Object Groups

You can add TCP or UDP service objects to a service-type object group.

#### Procedure

- Step 1** Choose the item to configure:
- To configure a virtual context, choose **Config > Devices > context > Security > Object Groups**.
  - To configure a configuration building block, choose **Config > Global > All Building Blocks > building\_block > Security > Object Groups**.
- The Object Groups table appears, listing the existing object groups.
- Step 2** In the Object Groups table, choose an existing service-type object group, and click the **TCP/UDP Service Parameters** tab.
- The TCP/UDP Service Parameters table appears.
- Step 3** Click **Add** to add an entry to this table.
- Step 4** Configure TCP or UDP service objects using the information in [Table 6-21](#).

**Table 6-21** TCP and UDP Service Parameters

| Field                | Description                                                                                                                                                                                                                                                                                                                                                                                                                                                                                                                                                                                                                                             |
|----------------------|---------------------------------------------------------------------------------------------------------------------------------------------------------------------------------------------------------------------------------------------------------------------------------------------------------------------------------------------------------------------------------------------------------------------------------------------------------------------------------------------------------------------------------------------------------------------------------------------------------------------------------------------------------|
| Protocol             | Protocol for this service object: <ul style="list-style-type: none"> <li>• TCP—TCP is the protocol for this service object.</li> <li>• TCP And UDP—Both TCP and UDP are the protocols for this service object.</li> <li>• UDP—UDP is the protocol for this service object.</li> </ul>                                                                                                                                                                                                                                                                                                                                                                   |
| Source Port Operator | Operand to use when comparing source port numbers for this service object: <ul style="list-style-type: none"> <li>• Equal To—The source port must be the same as the number in the Source Port field.</li> <li>• Greater Than—The source port must be greater than the number in the Source Port field.</li> <li>• Less Than—The source port must be less than the number in the Source Port field.</li> <li>• Not Equal To—The source port must not equal the number in the Source Port field.</li> <li>• Range—The source port must be within the range of ports specified by the Lower Source Port field and the Upper Source Port field.</li> </ul> |

**Table 6-21** TCP and UDP Service Parameters (continued)

| Field                     | Description                                                                                                                                                                                                                                                                                                                                                                                                                                                                                                                                                                                                                                                                                                                    |
|---------------------------|--------------------------------------------------------------------------------------------------------------------------------------------------------------------------------------------------------------------------------------------------------------------------------------------------------------------------------------------------------------------------------------------------------------------------------------------------------------------------------------------------------------------------------------------------------------------------------------------------------------------------------------------------------------------------------------------------------------------------------|
| Source Port               | Field that appears if you choose Equal To, Greater Than, Less Than, or Not Equal To in the Source Port Operator field.<br>Enter the source port name or number for this service object.                                                                                                                                                                                                                                                                                                                                                                                                                                                                                                                                        |
| Lower Source Port         | Field that appears if you choose Range in the Source Port Operator field.<br>Enter the number that is the beginning value for a range of services for this service object. Valid entries are from 0 to 65535. The number in this field must be less than the number entered in the Upper Source Port field.                                                                                                                                                                                                                                                                                                                                                                                                                    |
| Upper Source Port         | Field that appears if you choose Range in the Source Port Operator field.<br>Enter the number that is the ending value for a range of services for this service object. Valid entries are from 0 to 65535. The number in this field must be greater than the number entered in the Lower Source Port field.                                                                                                                                                                                                                                                                                                                                                                                                                    |
| Destination Port Operator | Operand to use when comparing destination port numbers: <ul style="list-style-type: none"> <li>• <b>Equal To</b>—The destination port must be the same as the number in the Destination Port field.</li> <li>• <b>Greater Than</b>—The destination port must be greater than the number in the Destination Port field.</li> <li>• <b>Less Than</b>—The destination port must be less than the number in the Destination Port field.</li> <li>• <b>Not Equal To</b>—The destination port must not equal the number in the Destination Port field.</li> <li>• <b>Range</b>—The destination port must be within the range of ports specified by the Lower Destination Port field and the Upper Destination Port field.</li> </ul> |
| Destination Port          | Field that appears if you choose Equal To, Greater Than, Less Than, or Not Equal To in the Destination Port Operator field.<br>Enter the destination port name or number for this service object.                                                                                                                                                                                                                                                                                                                                                                                                                                                                                                                              |
| Lower Destination Port    | Field that appears if you choose Range in the Destination Port Operator field.<br>Enter the number that is the beginning value for a range of services for this service object. Valid entries are from 0 to 65535. The number in this field must be less than the number entered in the Upper Destination Port field.                                                                                                                                                                                                                                                                                                                                                                                                          |
| Upper Destination Port    | Field that appears if you choose Range in the Destination Port Operator field.<br>Enter the number that is the ending value for a range of services for this service object. Valid entries are from 0 to 65535. The number in this field must be greater than the number entered in the Lower Destination Port field.                                                                                                                                                                                                                                                                                                                                                                                                          |

**Step 5** Do one of the following:

- Click **Deploy Now** to immediately deploy this configuration on the ACE and save your entries to the running-configuration and startup-configuration files. This option appears for virtual contexts.
- Click **OK** to save your entries. This option appears for configuration building blocks.
- Click **Cancel** to exit this procedure without saving your entries.
- Click **Next** to deploy your entries and to add another entry to the TCP/UDP Service Parameters table.

**Related Topics**

- [Configuring Object Groups, page 6-89](#)
- [Configuring IP Addresses for Object Groups, page 6-91](#)
- [Configuring Subnet Objects for Object Groups, page 6-92](#)
- [Configuring Protocols for Object Groups, page 6-93](#)
- [Configuring ICMP Service Parameters for an Object Group, page 6-97](#)



## Configuring ICMP Service Parameters for an Object Group

You can add ICMP service parameters to a service-type object group.

### Procedure

- Step 1** Choose the item to configure:
- To configure a virtual context, choose **Config > Devices > context > Security > Object Groups**.
  - To configure a configuration building block, choose **Config > Global > All Building Blocks > building\_block > Security > Object Groups**.
- The Object Groups table appears, listing the existing object groups.
- Step 2** In the Object Groups table, choose an existing service-type object group, and click the **ICMP Service Parameters** tab.
- The ICMP Service Parameters table appears.
- Step 3** Click **Add** to add an entry to this table.
- Step 4** Configure ICMP type objects using the information in [Table 6-22](#).

**Table 6-22** ICMP Type Service Parameters

| Field                 | Description                                                                                                                                                                                                                                                                                                                                                                                                                                                                                                                                                                                                                                                                        |
|-----------------------|------------------------------------------------------------------------------------------------------------------------------------------------------------------------------------------------------------------------------------------------------------------------------------------------------------------------------------------------------------------------------------------------------------------------------------------------------------------------------------------------------------------------------------------------------------------------------------------------------------------------------------------------------------------------------------|
| ICMP Version          | Field that appears for ACE module and ACE appliance software Version A5(1.0) or later. Internet Control Message Protocol (ICMP) version. Choose one of the following radio buttons: <ul style="list-style-type: none"> <li>ICMP—ICMP for Internet Protocol version 4 (IPv4).</li> <li>ICMPv6—ICMP version 6 (ICMPv6) for Internet Protocol version 6 (IPv6).</li> </ul>                                                                                                                                                                                                                                                                                                            |
| ICMP Type             | ICMP type or number for this service object. <a href="#">Table 6-23</a> lists common ICMP types and numbers. <a href="#">Table 6-24</a> lists the ICMPv6 types and numbers.                                                                                                                                                                                                                                                                                                                                                                                                                                                                                                        |
| Message Code Operator | Operand to use when comparing message codes for this service object: <ul style="list-style-type: none"> <li><b>Equal To</b>—The message code must be the same as the number in the Message Code field.</li> <li><b>Greater Than</b>—The message code must be greater than the number in the Message Code field.</li> <li><b>Less Than</b>—The message code must be less than the number in the Message Code field.</li> <li><b>Not Equal To</b>—The message code must not equal the number in the Message Code field.</li> <li><b>Range</b>—The message code must be within the range of codes specified by the Min Message Code field and the Max. Message Code field.</li> </ul> |
| Message Code          | Field that appears if you choose one of the following in the Message Code Operator field: Equal To, Greater Than, Less Than, or Not Equal To.<br>Enter the ICMP message code for this service object.                                                                                                                                                                                                                                                                                                                                                                                                                                                                              |

**Table 6-22** *ICMP Type Service Parameters (continued)*

| Field             | Description                                                                                                                                                                                                                                                                                                |
|-------------------|------------------------------------------------------------------------------------------------------------------------------------------------------------------------------------------------------------------------------------------------------------------------------------------------------------|
| Min. Message Code | Field that appears if you choose Range in the Message Code Operator field.<br>Enter the number that is the beginning value for a range of services for this service object. Valid entries are from 0 to 255. The number in this field must be less than the number entered in the Max Message Code field.  |
| Max. Message Code | Field that appears if you choose Range in the Message Code Operator field.<br>Enter the number that is the ending value for a range of services for this service object. Valid entries are from 0 to 255. The number in this field must be greater than the number entered in the Min. Message Code field. |

**Table 6-23** *ICMP Type Numbers and Names*

| Number | ICMP Type Name       |
|--------|----------------------|
| 0      | Echo-Reply           |
| 3      | Unreachable          |
| 4      | Source-Quench        |
| 5      | Redirect             |
| 6      | Alternate-Address    |
| 8      | Echo                 |
| 9      | Router-Advertisement |
| 10     | Router-Solicitation  |
| 11     | Time-Exceeded        |
| 12     | Parameter-Problem    |
| 13     | Timestamp-Request    |
| 14     | Timestamp-Reply      |
| 15     | Information-Request  |
| 16     | Information-Reply    |
| 17     | Address-Mask-Request |
| 18     | Address-Mask-Reply   |
| 31     | Conversion-Error     |
| 32     | Mobile-Redirect      |

**Table 6-24** *ICMPv6 Type Numbers and Names*

| Number | ICMPv6 Type Name    |
|--------|---------------------|
| 128    | Echo                |
| 129    | Echo-Reply          |
| 140    | Information-Reply   |
| 139    | Information-Request |

**Table 6-24** ICMPv6 Type Numbers and Names (continued)

| Number | ICMPv6 Type Name  |
|--------|-------------------|
| 4      | Parameter-Problem |
| 137    | Redirect          |
| 3      | Time-Exceeded     |
| 30     | Traceroute        |
| 1      | Unreachable       |

**Step 5** Do one of the following:

- Click **Deploy Now** to immediately deploy this configuration on the ACE and save your entries to the running-configuration and startup-configuration files. This option appears for virtual contexts.
- Click **OK** to save your entries. This option appears for configuration building blocks.
- Click **Cancel** to exit this procedure without saving your entries.
- Click **Next** to deploy your entries and to add another entry to the ICMP Service Parameters table.

#### Related Topics

- [Configuring Object Groups, page 6-89](#)
- [Configuring IP Addresses for Object Groups, page 6-91](#)
- [Configuring Subnet Objects for Object Groups, page 6-92](#)
- [Configuring Protocols for Object Groups, page 6-93](#)
- [Configuring TCP/UDP Service Parameters for Object Groups, page 6-94](#)

## Managing ACLs

This section describes how to manage ACLs.

This section includes the following topics:

- [Viewing All ACLs by Context, page 6-99.](#)
- [Editing or Deleting ACLs, page 6-100.](#)

### Viewing All ACLs by Context

You can display ACLs that have been configured.

#### Procedure

**Step 1** Choose **Config > Devices**.

The device tree appears.

**Step 2** In the device tree, choose the virtual context with the ACLs that you want to view, and choose **Security > ACLs**.

The ACLs table appears, listing the existing ACLs in that context with their name, their type (Extended or EtherType), and all details (such as Action, Protocol, Interface information).

- Step 3** To display all of the ACLs for a given table entry, click the plus sign to the left of that entry.
- Step 4** To display all of the ACLs for all of the entries, click **Expand All** on the Add/Edit/Delete row.
- Step 5** To collapse all of the ACLs for all of the entries, click **Collapse All** on the Add/Edit/Delete row.

#### Related Topics

- [Configuring Security with ACLs, page 6-78](#)
- [Creating ACLs, page 6-79](#)
- [Setting EtherType ACL Attributes, page 6-87](#)
- [Setting Extended ACL Attributes, page 6-82](#)
- [Editing or Deleting ACLs, page 6-100](#)

## Editing or Deleting ACLs

You can delete or edit an ACL or any of its subentries.

#### Considerations

- You cannot mix IPv6 and IPv4 access-list entries in the same ACL.



**Note** IPv6 requires ACE module and ACE appliance software Version A5(1.0) or later.

- Before you change the IP address type (IPv4/IPv6) for an existing ACL, you must remove the entries that are not applicable to the new IP address type.
- If you change the ACL protocol, the ACE removes all of the existing settings for the ACL.

#### Procedure

- Step 1** Choose the item to edit or delete as follows:
  - Choose **Config > Devices > context > Security > ACLs**.
  - Choose **Config > Global > All Building Blocks > building\_block > Security > ACLs**.

The ACLs table appears, listing the existing ACLs.
- Step 2** In the ACLs table, choose the radio button to the left of the ACL that you want to Edit or Delete. Expand entries if necessary by clicking the plus sign to the left of any ACL entry until you see the subentry ACL for which you are looking, or click the **Expand All** icon to view all ACLs and subentries.
- Step 3** Do one of the following:
  - If you are editing an ACL or one of its entries, click **Edit** and go to [Step 4](#).
  - If you are deleting an ACL or one of its entries, click **Delete** and go to [Step 5](#).
- Step 4** Edit the entry using the summary information listed in [Table 6-18](#) if needed, and click **Deploy** when done.

**Step 5** Click **Delete**.

A confirmation popup window appears asking you to confirm the deletion. If you click **OK**, the ACLs table refreshes without the deleted ACL.

---

**Related Topics**

- [Creating ACLs, page 6-79](#)
- [Setting EtherType ACL Attributes, page 6-87](#)
- [Setting Extended ACL Attributes, page 6-82](#)
- [Resequencing Extended ACLs, page 6-87](#)

## Configuring Virtual Context Expert Options

The ANM virtual context Expert configuration options allow you to do the following:

- Establish traffic policies for virtual servers by classifying types of network traffic and then applying the appropriate rules and actions for handling the traffic. See the “[Configuring Traffic Policies](#)” section on page 14-1.
- Compare a virtual context configuration with a tagged configuration building block that has been applied to the context. See the “[Comparing Context and Building Block Configurations](#)” section on page 6-101.
- For ACE modules and ACE appliances, configure HTTP header modify action lists. See the “[Configuring an HTTP Header Modify Action List](#)” section on page 14-85.
- For ACE appliances, configure optimization action lists. See the “[Configuring an HTTP Optimization Action List](#)” section on page 15-3.

## Comparing Context and Building Block Configurations

ANM allows you to compare the current configuration of a virtual context that has had a tagged configuration building block applied to it with the settings of the applied building block. Discrepancies between these configurations can occur when you configure the virtual context after applying the building block instead of modifying and tagging the building block, then applying the updated building block to the virtual context.

The ANM auditing process identifies the discrepancies by configuration category (such as policy maps or SNMP) and groups them accordingly.

You can identify discrepancies between an ANM tagged building block and a virtual context that previously had the building block applied to it.

**Assumption**

The virtual context has had a tagged building block applied to it.

**Procedure**

- 
- Step 1** Choose **Config > Devices > context > Expert > Building Block Audit**.

The Building Block Audit window appears with the Comparison Results table, listing any discrepancies between the configurations.

**Step 2** In the Building Block Audit window, identify the discrepancies as follows:

- Click **All** at the top of the results tree. The Comparison Results table displays all discrepancies. The values that follow the word All, such as 2c 5d 3a, indicate differences between the virtual context configuration and the building block configuration. These values use the format *n<difference>* where *n* represents the number of differences between the configurations and *<difference>* represents the type of difference. The possible results are as follows:
  - *nc* (changed) indicates the number of items with settings that have changed or differ from the settings in the building block. For example, 2c indicates that two configuration options in the context currently have different settings or values than those settings or values in the applied building block.
  - *nd* (deleted) indicates the number of items that were in the applied building block that do not exist in the current context configuration. For example, 5d indicates that five configuration options that were in the applied building block do not exist in the current context configuration.
  - *na* (added) indicates the number of items that are in the current context configuration that were not in the applied building block. For example, 3a indicates that three configuration options that were not in the applied building block have been added to the context configuration.
- Click a folder in the results tree. The Comparison Results table displays the discrepancies for that configuration category, such as SNMP or class maps.
- Click an item within a folder. The Comparison Results table displays the differences for that specific attribute.

**Step 3** In the Comparison Results table, when viewing results, you can do one of the following:

- Filter the results by entering a complete or partial string in one or more of the input fields at the top of the columns, then clicking **Go**.
  - Sort the results in ascending or descending order by clicking a column heading.
- 

#### Related Topics

- [Configuring Virtual Contexts, page 6-8](#)
- [Managing Virtual Contexts, page 6-103](#)
- [Using Configuration Building Blocks, page 16-1](#)

# Managing Virtual Contexts

You can perform the following administrative actions on virtual contexts.

This section includes the following topics:

- [Displaying All Virtual Contexts, page 6-103](#)
- [Synchronizing Virtual Context Configurations, page 6-105](#)
- [Managing Syslog Settings for Autosynchronization, page 6-105](#)
- [Editing Virtual Contexts, page 6-106](#)
- [Deleting Virtual Contexts, page 6-107](#)
- [Upgrading Virtual Contexts, page 6-107](#)
- [Restarting Virtual Context Polling, page 6-108](#)
- [Comparing Context and Building Block Configurations, page 6-101](#)

## Displaying All Virtual Contexts

You can display some or all virtual contexts being managed by ANM.

### Procedure

**Step 1** Choose **Config > Devices > All VC**.

The All Virtual Contexts table appears with the information described in [Table 6-25](#).

**Table 6-25** All Virtual Contexts Table

| Field                       | Description                                                                                                                                                                                                                                                                                                                                                                                                                                                                                                                                                                                                                                                                                                                                                                                                                                                                                                                                                            |
|-----------------------------|------------------------------------------------------------------------------------------------------------------------------------------------------------------------------------------------------------------------------------------------------------------------------------------------------------------------------------------------------------------------------------------------------------------------------------------------------------------------------------------------------------------------------------------------------------------------------------------------------------------------------------------------------------------------------------------------------------------------------------------------------------------------------------------------------------------------------------------------------------------------------------------------------------------------------------------------------------------------|
| Name                        | Context name including chassis and slot.                                                                                                                                                                                                                                                                                                                                                                                                                                                                                                                                                                                                                                                                                                                                                                                                                                                                                                                               |
| Resource Class              | Resource class applied to the context.                                                                                                                                                                                                                                                                                                                                                                                                                                                                                                                                                                                                                                                                                                                                                                                                                                                                                                                                 |
| Management IPs              | List of IP addresses used for remote management of the context.                                                                                                                                                                                                                                                                                                                                                                                                                                                                                                                                                                                                                                                                                                                                                                                                                                                                                                        |
| Building Block              | Configuration building block applied to the context.                                                                                                                                                                                                                                                                                                                                                                                                                                                                                                                                                                                                                                                                                                                                                                                                                                                                                                                   |
| CLI Sync Status             | Administrative configuration status of the context as follows: <ul style="list-style-type: none"> <li>• Import Failed—The context did not import successfully. This problem could have occurred when the device was added to ANM or when the context was synchronized. Synchronize the context so that you can manage it (<b>Config &gt; Devices &gt; ACE &gt; context &gt; Sync</b>).</li> <li>• OK—The context is synchronized with the ACE CLI.</li> <li>• Out of Sync—The context is managed by the ANM but the configuration for the context on the device differs from the configuration managed by the ANM. For information on synchronizing contexts, see the “<a href="#">Synchronizing Virtual Context Configurations</a>” section on page 6-105.</li> <li>• Unprovisioned—The context has been removed from the ACE using the CLI but has not been removed from ANM. To remove unprovisioned contexts, synchronize the associated Admin context.</li> </ul> |
| Last CLI Sync Status Change | Time stamp of the last CLI synchronization with ANM.                                                                                                                                                                                                                                                                                                                                                                                                                                                                                                                                                                                                                                                                                                                                                                                                                                                                                                                   |

Table 6-25 All Virtual Contexts Table (continued)

| Field             | Description                                                                                                                                                                                                                                                                                                                                                                                                                                                                                                                                                                                                                                                                                                                                                                                                                                                                                                                                                                                                                                                                                                                                                                                                                                                                                                                                                                                                                          |
|-------------------|--------------------------------------------------------------------------------------------------------------------------------------------------------------------------------------------------------------------------------------------------------------------------------------------------------------------------------------------------------------------------------------------------------------------------------------------------------------------------------------------------------------------------------------------------------------------------------------------------------------------------------------------------------------------------------------------------------------------------------------------------------------------------------------------------------------------------------------------------------------------------------------------------------------------------------------------------------------------------------------------------------------------------------------------------------------------------------------------------------------------------------------------------------------------------------------------------------------------------------------------------------------------------------------------------------------------------------------------------------------------------------------------------------------------------------------|
| ACE HA State      | <p>High availability state of the context. If the context is configured for high availability, the current state of the context with regard to high availability:</p> <ul style="list-style-type: none"> <li>• Active—The context is actively processing flows for the HA pair.</li> <li>• Standby Cold—Either the fault-tolerant VLAN is down, but the peer ACE is still alive, or the configuration or application state synchronization failed.</li> <li>• Standby Bulk—The context is waiting to receive information from its active peer context.</li> <li>• Standby Hot—The context has all the state information that it needs to statefully assume the active state if a switchover occurs.</li> <li>• Standby Warm—Allows the configuration and state synchronization process to continue on a best-effort basis when you upgrade or downgrade the ACE software.</li> </ul>                                                                                                                                                                                                                                                                                                                                                                                                                                                                                                                                                 |
| ACE HA Peer       | Identifier of the ACE high availability peer.                                                                                                                                                                                                                                                                                                                                                                                                                                                                                                                                                                                                                                                                                                                                                                                                                                                                                                                                                                                                                                                                                                                                                                                                                                                                                                                                                                                        |
| ACE HA Peer State | Current state of the context with regard to high availability on the ACE peer. See the states listed for the ACE HA State field.                                                                                                                                                                                                                                                                                                                                                                                                                                                                                                                                                                                                                                                                                                                                                                                                                                                                                                                                                                                                                                                                                                                                                                                                                                                                                                     |
| Polling Status    | <p>Current polling status of the context:</p> <ul style="list-style-type: none"> <li>• Missing SNMP Credentials—SNMP credentials are not configured for this virtual context; statistics are not collected. Add SNMPv2c credentials to fix this error.</li> <li>• Not Polled—SNMP polling has not started. This problem might occur when the virtual context is first created from ANM and the SNMP credentials are not configured. Add SNMPv2c credentials to fix this error.</li> <li>• Not Supported—This status appears at the device level only and applies to Catalyst 6500 series chassis, Cisco 7600 series routers, and ACE appliances.</li> <li>• Polling Failed—SNMP polling failed due to some internal error. Try restarting polling to enable SNMP collection again.</li> <li>• Polling Started—No action is required. Everything is working properly. Polling states will display activity.</li> <li>• Polling Timed Out—SNMP polling has timed out. This problem might occur if the wrong credentials were configured or might be caused by an internal error (such as SNMP was configured incorrectly or the destination is not reachable). Verify that SNMP credentials are correct. If the problem persists, restart polling to enable SNMP collection again.</li> <li>• Unknown—SNMP polling is not working due to one of the above-mentioned conditions. Check the SNMPv2c credential configuration.</li> </ul> |

**Step 2** Use the object selector to view all virtual contexts or only those contexts on a specific device.

#### Related Topics

- [Restarting Virtual Context Polling, page 6-108](#)
- [Enabling Polling on All Devices, page 17-47](#)
- [Synchronizing Virtual Context Configurations, page 6-105](#)



## Synchronizing Virtual Context Configurations

You can synchronize the configurations for a virtual context. ANM allows you to synchronize the configuration information residing on an ACE with the configuration information maintained by the ANM server for the same device. When ANM synchronizes a context, it uploads the configuration from the device to the ANM server. In accordance with your role-based permission level, the ANM Status bar displays the number of virtual contexts that are not synchronized with the ACE CLI against the total number of virtual contexts and the number of failed synchronization attempts.

You should synchronize contexts for the following reasons:

- You configure the ACE directly via the CLI instead of using the ANM interface. The CLI Sync Status is *Out of Sync* in the Virtual Contexts table (**Config > Devices > ACE**) if the configurations for a virtual context differ.
- A context has been removed from the ACE using the CLI, reflected by the CLI Sync Status *Unprovisioned* in the Virtual Contexts table. In this situation, you need to synchronize the Admin context to remove the unprovisioned context.
- A context has not successfully been imported into ANM during discovery or a Sync operation, reflected by the CLI Sync Status *Import Failed* in the Virtual Contexts table. In this situation, you need to synchronize the context before you can modify its configuration.
- You recently installed or uninstalled a license on an ACE using either ANM or the CLI. Synchronize the Admin context of the ACE with the CLI.

### Procedure

---

- Step 1** Choose **Config > Devices**.  
The device tree appears.
- Step 2** In the device tree, choose either **All VC** or the ACE with the virtual context configuration that you want to synchronize.  
The Virtual Contexts table appears.
- Step 3** In the Virtual Contexts table, choose the virtual context with the configuration that you want to synchronize, and click **CLI Sync**.  
The verification popup window appears, asking you to verify the synchronization request.
- Step 4** In the verification popup window, click **Yes**.  
Synchronization begins and the Virtual Contexts table refreshes when synchronization is complete.
- 

### Related Topics

- [Configuring Auto Sync Settings, page 18-61](#)
- [Editing Virtual Contexts, page 6-106](#)
- [Restarting Virtual Context Polling, page 6-108](#)
- [Comparing Context and Building Block Configurations, page 6-101](#)

## Managing Syslog Settings for Autosynchronization

You can configure ANM to receive syslog messages for a virtual context.

Setting autosynchronization to occur upon receipt of a device syslog message allows a faster, more streamlined synchronization process between ANM and any out-of-band configuration changes. Instead of waiting the default polling period, ANM will synchronize when a syslog message is received if Setup Syslog for Autosync is enabled.

### Procedure

---

**Step 1** Choose **Config > Devices > Virtual Context Management > Setup Syslog for Autosync**.

The Setup Syslog for Autosync window appears.

**Step 2** In the Setup Syslog for Autosync window, choose either **All VC** or the ACE with the virtual context configuration that you want to receive Autosync syslog messages

**Step 3** Click **Setup Syslog**.

A progress bar window appears.

A checkbox with a checkmark appears in the Setup Syslog for Autosync? column for each virtual context and ACE device you checked.

**Step 4** Click the **Setup Syslog** button.

The following CLI commands are sent to the enabled devices:

```
logging enable
logging trap 2
logging device-id string <ACE-IP>/Admin
logging host <ANM-IP> udp/514
logging message 111008 level 2
```

---

### Related Topics

- [Synchronizing Virtual Context Configurations, page 6-105](#)
- [Restarting Virtual Context Polling, page 6-108](#)

## Editing Virtual Contexts

You can modify the configuration of an existing virtual context.

### Procedure

---

**Step 1** Choose **Config > Devices**.

The device tree appears.

**Step 2** In the device tree, choose the virtual context, then choose the configuration attributes that you want to modify.

For information on configuration options, see the [“Configuring Virtual Contexts” section on page 6-8](#).

**Step 3** Do one of the following:

- Click **OK** to save your entries.
  - Click **Cancel** to exit the procedure without saving your entries.
-

**Related Topics**

- [Information About Virtual Contexts, page 6-2](#)
- [Configuring Virtual Contexts, page 6-8](#)

## Deleting Virtual Contexts

You can remove an existing virtual context.

**Note**

If you remove a virtual context using the CLI, the CLI Sync Status for the virtual context appears as Unprovisioned in the Virtual Contexts table (Config > Devices > ACE). To remove the unprovisioned virtual context from the ANM, either synchronize the Admin virtual context (see the “[Synchronizing Virtual Context Configurations](#)” section on page 6-105) or delete the virtual context by selecting the virtual context, then clicking **Delete**.

**Procedure**

- 
- Step 1** Choose **Config > Devices**.
- The device tree appears.
- Step 2** In the device tree, choose the virtual context that you want to configure, and click **Delete** in either the device pane or the configuration pane.
- A confirmation popup window appears, asking you to confirm the deletion.
- Step 3** Do one of the following:
- Click **OK** to delete the selected context. The device tree refreshes and the deleted context no longer appears.
  - Click **Cancel** to exit this procedure and to retain the selected context.
- 

**Related Topics**

- [Configuring Virtual Contexts, page 6-8](#)
- [Comparing Context and Building Block Configurations, page 6-101](#)

## Upgrading Virtual Contexts

You can apply a different resource class, configuration building block, or VLAN to a virtual context.

**Procedure**

- 
- Step 1** Choose **Config > Devices**.
- The device tree appears.
- Step 2** In the device tree, choose the virtual context that you want to upgrade, and choose **System > Primary Attributes**.
- The Edit Virtual Context window appears.

- Step 3** In the Resource Class field of the Edit Virtual Context window, choose the resource class that you want to apply to the context.



**Note** If you attempt to apply a resource class that could consume the resources required to maintain IP connectivity to the Admin context, you will see an error message and the resource class will not be applied. We recommend that you first apply a resource class to the Admin context that will prevent its resources from being allocated to other contexts. For more information, see the [“Resource Allocation Constraints” section on page 6-44](#).

- Step 4** In the Tagged Building Block To Apply field, choose the building block to apply to this virtual context.

- Step 5** In the Allocate-Interface VLANs field, enter the number of a VLAN or a range of VLANs so that the context can receive the associated traffic.

You can specify VLANs as follows:

- For a single VLAN, enter an integer from 2 to 4096.
- For multiple, nonsequential VLANs, use comma-separated entries, such as 101,201,302.
- For a range of VLANs, use the format *<beginning-VLAN>-<ending-VLAN>*, such as 101-150.



**Note** You cannot modify VLANs in an Admin context.

- Step 6** In the Description field, enter a brief description for this context.

- Step 7** Click **Deploy Now** to deploy this configuration on the ACE and save your entries to the running-configuration and startup-configuration files.

The window refreshes with updated information.

To exit this procedure without saving your entries, choose another item in the menu bar or device tree. A popup window appears, confirming that you have not saved your entries.

#### Related Topics

- [Information About Virtual Contexts, page 6-2](#)
- [Configuring Virtual Contexts, page 6-8](#)

## Restarting Virtual Context Polling

You can restart monitoring and enable SNMP collection on a single context that has stopped or failed to start.



**Note** To restart polling and enable SNMP collection on all virtual contexts, choose **Monitor > Settings > Global Polling Configuration**, and configure global polling attributes using the information in the [“Enabling Polling on All Devices” section on page 17-47](#).

#### Procedure

- Step 1** Choose **Config > Devices**.

The device tree appears.

**Step 2** In the device tree, choose the ACE associated with the virtual context with stopped or failed polling. The Virtual Contexts table appears.

**Step 3** In the Virtual Contexts table, choose the context with the stopped or failed polling, and click **Restart Polling**.

If the ANM cannot monitor the selected context, it displays an error message stating the reason.

---

#### Related Topics

- [Information About Virtual Contexts, page 6-2](#)
- [Configuring Virtual Contexts, page 6-8](#)
- [Enabling Polling on All Devices, page 17-47](#)





# CHAPTER 7

## Configuring Virtual Servers

---

**Date:** 3/28/12

This chapter describes how to configure virtual servers for load balancing on the Cisco Application Control Engine (ACE) using Cisco Application Networking Manager (ANM).



**Note**

---

When naming ACE objects (such as a real server, virtual server, parameter map, class map, health probe, and so on), enter an alphanumeric string of 1 to 64 characters, which can include the following special characters: underscore (\_), hyphen (-), dot (.), and asterisk (\*). Spaces are not allowed.

If you are using ANM with an ACE module or ACE appliance and you configure a named object at the ACE CLI, keep in mind that ANM does not support all of the special characters that the ACE CLI allows you to use when configuring a named object. If you use special characters that ANM does not support, you may not be able to import or manage the ACE using ANM.

---

This chapter includes the following sections:

- [Information About Load Balancing, page 7-1](#)
- [Configuring Virtual Servers, page 7-2](#)
- [Managing Virtual Servers, page 7-66](#)
- [Deploying Virtual Servers, page 7-86](#)

## Information About Load Balancing

Server load balancing (SLB) is the process of deciding to which server a load balancer should send a client request for service. For example, a client request can consist of an HTTP GET for a web page or an FTP GET to download a file. The load balancer selects the server that can successfully fulfill the client request and in the shortest amount of time without overloading either the server or the server farm as a whole.

Depending on the load-balancing algorithm or predictor that you configure, the ACE performs a series of checks and calculations to determine the server that can best service each client request. The ACE bases server selection on several factors, including the server with the fewest connections with respect to load, source or destination address, cookies, URLs, or HTTP headers.

ANM allows you to configure load balancing using:

- Virtual servers—See [Configuring Virtual Servers, page 7-2](#).

- Real servers—See [Configuring Real Servers, page 8-5](#).
- Server farms—See [Configuring Server Farms, page 8-30](#).
- Predictor methods—See [Configuring the Predictor Method for Server Farms, page 8-39](#)
- Health probes—See [Configuring Health Monitoring for Real Servers, page 8-51](#)
- Sticky groups—See [Configuring Sticky Groups, page 9-7](#).
- Parameter maps—See [Configuring Parameter Maps, page 10-1](#).

## Configuring Virtual Servers

In a load-balancing environment, a virtual server is a construct that allows multiple physical servers to appear as one for load-balancing purposes. A virtual server is bound to physical services running on real servers in a server farm and uses IP address and port information to distribute incoming client requests to the servers in the server farm according to a specified load-balancing algorithm.

You use class maps to configure a virtual server address and definition. The load-balancing predictor algorithms (for example, round-robin, least connections, and so on) determine the servers to which the ACE sends connection requests.

This section includes the following topics:

- [Virtual Server Configuration and ANM, page 7-2](#)
- [Information About Using ANM to Configure Virtual Servers, page 7-4](#)
- [Virtual Server Usage Guidelines, page 7-5](#)
- [Virtual Server Testing and Troubleshooting, page 7-6](#)
- [Virtual Server Configuration Procedure, page 7-7](#)

## Virtual Server Configuration and ANM

This section identifies the constraints and framework used by ANM for virtual server configuration.

In ANM, a virtual server has the following attributes:

- A single Layer 3/Layer 4 match condition

You can specify only a single IP address (or single IP address range if an IPv4 netmask or IPv6 prefix length is used), with only a single port (or port range). A single match condition greatly simplifies and aids virtual server configuration.



**Note** IPv6 requires ACE module and ACE appliance software Version A5(1.0) or later.

- A default Layer 7 action
- A Layer 7 policy map
- A Layer 3/Layer 4 class map
- A single multimatch policy map, a class-map match, and an action

Virtual server attributes also include the following:

- The virtual server multimatch policy map is associated with an interface or is global.



- The name of the virtual server is derived from the name of the Layer 3/Layer 4 class map.

Example 7-1 shows the minimum configuration statements required for a virtual server.

### Example 7-1 Minimum Configuration Required for a Virtual Server

#### IPv4 Configuration

```
class-map match-all Example_VIP
 2 match virtual-address 10.10.10.10 tcp eq www
policy-map type loadbalance first-match Example_VIP-l7slb
 class class-default
 forward
policy-map multi-match int10
 class Example_VIP
 loadbalance policy Example_VIP-l7slb

interface vlan 10
 ip address 192.168.65.37 255.255.255.0
 service-policy input int10
 no shutdown
```

#### IPv6 Configuration (Requires ACE module and ACE appliance software Version A5(1.0) or later)

```
class-map match-all Example2_VIP
 2 match virtual-address 2001:DB8:10::5 tcp eq www
policy-map type loadbalance first-match Example2_VIP-l7slb
 class class-default
 forward
policy-map multi-match int11
 class Example2_VIP
 loadbalance policy Example2_VIP-l7slb

interface vlan 10
 ip address 2001:DB8:10::21/64
 service-policy input int11
 no shutdown
```

Note the following items regarding the ANM and virtual servers:

- **Additional configuration options**

The Virtual Server configuration window allows you to configure additional items for a functional VIP. These items include server farms, sticky groups, real servers, probes, parameter maps, inspection, class maps, and inline match conditions. Because too many items on a window can be overwhelming, not all configuration options appear on the Virtual Server configuration window, such as sticky statics or backup real servers. These options are available elsewhere in the ANM interface instead of on the Virtual Server configuration window.

- **Configuration options and roles**

To support and maintain the separation of roles, some objects cannot be configured using the Virtual Server configuration window. These objects include SSL certificates, SSL keys, NAT pools, interface IP addresses, and ACLs. Providing these options as separate configuration options in the ANM interface ensures that a user who can view or modify virtual servers or aspects of virtual servers cannot create or delete virtual servers.

- **Changes to virtual servers using the CLI or Expert options can prevent further modifications in the Virtual Server configuration window**

If you create a virtual server using the Virtual Server configuration window, modify it using the CLI or Expert options (Config > Devices > Expert), and then attempt to modify it again using the Virtual Server configuration window, error messages will be displayed and you will not be able to modify the virtual server.

- **Changes to virtual server IP address type is not allowed**

When creating a virtual server, you choose whether to use the IPv4 or IPv6 address type. You cannot change the IP address type of an existing virtual server. If you need to change the IP address type, you must create a new virtual server.



---

**Note** IPv6 requires ACE module and ACE appliance software Version A5(1.0) or later.

---

#### Related Topics

- [Configuring Virtual Servers, page 7-2](#)
- [Information About Using ANM to Configure Virtual Servers, page 7-4](#)
- [Virtual Server Usage Guidelines, page 7-5](#)
- [Virtual Server Testing and Troubleshooting, page 7-6](#)
- [Virtual Server Configuration Procedure, page 7-7](#)

## Information About Using ANM to Configure Virtual Servers

Follow these guidelines when using ANM to configure virtual servers:

- **Virtual server configuration windows**

The ANM Virtual Server configuration windows are designed to aid you in configuring virtual servers by presenting configuration options that are relevant to your choices. For example, the protocols that you select in the Properties configuration subset determine the other configuration subsets that appear.

- **Use the virtual server configuration method that suits you**

The ANM Virtual Server configuration windows simplify the process of creating, modifying, and deploying virtual servers by displaying those options that you are most likely to use. In addition, as you specify attributes for a virtual server, such as protocols, the interface refreshes with related configuration options, such as Protocol Inspection or Application Acceleration and Optimization, which speeds virtual server configuration and deployment.

While Virtual Server configuration windows remove some configuration complexities, they have a few constraints that the Expert configuration options do not. If you are comfortable using the CLI, you can use the Expert options (such as Config > Devices > *context* > Expert > Class Maps or Policy or Config > Devices > *context* > Load Balancing > Parameter Maps to configure more complex attributes of virtual servers, traffic policies, and parameter maps.

- **Synchronizing virtual server configurations**

If you configure a virtual server using the CLI and then use the Sync option (Config > Devices > ACE > Sync) to synchronize configurations, the configuration that appears in ANM for the virtual server might not display all configuration options for that virtual server. The configuration that appears in ANM depends on a number of items, such as the protocols configured in class maps or the rules defined for policy maps.

For example, if you configure a virtual server on the CLI that includes a class map that can match any protocol, you will not see the virtual server Application Acceleration and Optimization configuration subset in ANM.

- **Modifying shared objects**

Modifying an object that is used by multiple virtual servers, such as a server farm, real server, or parameter map, could impact the other virtual servers. See the “[Shared Objects and Virtual Servers](#)” section on page 7-9 for more information about modifying objects used by multiple virtual servers.

#### Related Topics

- [Configuring Virtual Servers, page 7-2](#)
- [Virtual Server Configuration and ANM, page 7-2](#)
- [Virtual Server Usage Guidelines, page 7-5](#)
- [Virtual Server Testing and Troubleshooting, page 7-6](#)
- [Virtual Server Configuration Procedure, page 7-7](#)

## Virtual Server Usage Guidelines

The Virtual Server configuration window provides you with numerous configuration options. However, instead of setting every option in one pass, configure your virtual server in stages. The first stage should always be to establish basic “pass through” connectivity with simple load balancing and include minimal additional features. This level of setup should verify that ports, VLANs, interfaces, SSL termination (if applicable), and real servers have been set up properly, enabling basic connectivity.

After you establish this level of connectivity, additional virtual server features will be easier to configure and troubleshoot.

Common features to add to a working basic virtual server include:

- Health monitoring probes
- Session persistence (sticky)
- Additional real servers to a server farm
- Application protocol inspection
- Application acceleration and optimization (ACE appliance only)

[Table 7-1](#) identifies and describes virtual server configuration subsets with links to related topics for configuration information.

#### Related Topics

- [Configuring Virtual Servers, page 7-2](#)
- [Virtual Server Configuration and ANM, page 7-2](#)
- [Virtual Server Testing and Troubleshooting, page 7-6](#)
- [Virtual Server Configuration Procedure, page 7-7](#)

## Virtual Server Testing and Troubleshooting

As outlined in the “[Virtual Server Usage Guidelines](#)” section on page 7-5, first set up a basic virtual server that only enables connectivity and simple load balancing, such as round-robin between two real servers. Next, use a client, such as a web browser, to send a request from the client network to the virtual server's VIP address. If the request is successful, you can now make changes or add virtual server features.

If the request is not successful, begin virtual server troubleshooting as outlined in the following sequence:

1. Wait and retry your request after a minute or two, especially if the existing ACE configuration is large. It can take seconds or even minutes for configuration changes to affect how traffic is handled by ACE.
2. Click the **Details** button in the lower right of the Virtual Server page. The Details button displays the output of the **show service-policy** CLI command.
3. Verify that the VIP State in the **show service-policy** CLI command output is **INSERVICE**. If the VIP state is not **INSERVICE**, this may indicate the following:
  - The virtual server has been manually disabled in the configuration.
  - The real servers are all unreachable from ACE or manually disabled. If all of a virtual server's real servers are out of service due to one of those reasons, the virtual server itself will be marked **Out Of Service**.
4. Verify the Hit Count in the **show service-policy** CLI command output. Hit Count shows the number of requests received by ACE. This value should increase for each request attempted by your client. If the hit count does not increase with each request, this indicates that the request is not reaching your virtual server configuration.

This could be a problem with:

- A physical connection.
- VLAN or VLAN interface configuration.
- Missing or incorrect ACL applied to the client interface.
- Incorrect IP address (that is, a VIP that is not valid on the selected VLANs for the virtual server, or a VIP that is not accessible to your client).

If the Hit Count value increases but no response is received (Server Pkt Count does not increase), the problem is more likely to be in the connectivity between the ACE and the backend real servers. This issue is typically caused by one or more of the following problems:

- You are working on a one-armed configuration (that is, do not plan to change routing for your real servers) and have not selected an appropriate NAT pool for your virtual server to use with source NAT.
- A different routing problem (for example, server traffic does not know how to get back to the ACE).
- Addressing problem (for example, you have an incorrect real server address, or the real server is not accessible to ACE due to network topology).

**Note**

Hit count can increase by more than one, even if you make only a single request from your web browser, because retrieving a typical web page makes many requests from the client to the server.

**Related Topics**

- [Configuring Virtual Servers, page 7-2](#)
- [Virtual Server Configuration and ANM, page 7-2](#)
- [Virtual Server Usage Guidelines, page 7-5](#)
- [Virtual Server Configuration Procedure, page 7-7](#)

## Virtual Server Configuration Procedure

You can add virtual servers to the ANM for load-balancing purposes.

**Assumptions**

This topic assumes the following:

- Depending on the protocol to be used for the virtual server, parameter maps need to be defined.
- For SSL service, SSL certificates, keys, and chain groups, parameter maps must be configured.

**Guidelines and Restrictions**

ANM does not support CSM DNS virtual servers. If you create this type of virtual server, ANM issues an error message if you attempt to use ANM to activate or suspend it.

**Procedure**

---

**Step 1** Choose **Config > Devices > context > Load Balancing > Virtual Servers**.

The Virtual Servers table appears. For details about the information that displays, see “[Displaying Virtual Servers by Context](#)” section on page 7-65.

**Step 2** In the Virtual Servers table, click **Poll Now** to instruct ANM to poll the devices and display the current values.

**Step 3** Click **OK** when prompted if you want to poll the devices for data now.

**Step 4** Click **Add** to add a new virtual server, or choose an existing virtual server and click **Edit** to modify it.

The Virtual Server configuration window appears with a number of configuration subsets. The subsets that you see depend on whether you use the Basic View or the Advanced View and entries that you make in the Properties subset. Change views by using the View object selector at the top of the configuration pane.

[Table 7-1](#) identifies and describes virtual server configuration subsets with links to related topics for configuration information.

**Note**

The protocols that are available depend on the ACE device that you are configuring. For a list of the protocols available for each ACE device type, see [Table 7-2](#).

---

**Table 7-1 Virtual Server Configuration Subsets**

| <b>Configuration Subset</b>               | <b>Description</b>                                                                                                                                                                                                                                                                                                                                                                                                                                                                                                        | <b>Related Topics</b>                                                                |
|-------------------------------------------|---------------------------------------------------------------------------------------------------------------------------------------------------------------------------------------------------------------------------------------------------------------------------------------------------------------------------------------------------------------------------------------------------------------------------------------------------------------------------------------------------------------------------|--------------------------------------------------------------------------------------|
| Properties                                | Subset that allows you to specify basic virtual server characteristics, such as the virtual server name, IP address, protocol, port, and VLANs.                                                                                                                                                                                                                                                                                                                                                                           | <a href="#">Configuring Virtual Server Properties, page 7-11</a>                     |
| SSL Termination                           | Subset that appears when TCP is the selected protocol and Other or HTTPS is the application protocol.<br><br>This subset allows you to configure the virtual server to act as an SSL proxy server and terminate SSL sessions between it and its clients.                                                                                                                                                                                                                                                                  | <a href="#">Configuring Virtual Server SSL Termination, page 7-17</a>                |
| Protocol Inspection                       | Subset that appears in the Advanced View for: <ul style="list-style-type: none"> <li>TCP with FTP, HTTP, HTTPS, Real Time Streaming Protocol (RTSP), or Session Initiated Protocol (SIP)</li> <li>UDP with Domain Name System (DNS) or SIP</li> </ul> This subset appears in the Basic view for TCP with FTP.<br><br>This subset allows you to configure the virtual server so that it can verify protocol behavior and identify unwanted or malicious traffic passing through the ACE on selected application protocols. | <a href="#">Configuring Virtual Server Protocol Inspection, page 7-18</a>            |
| Application Acceleration And Optimization | Subset that appears only for ACE appliances. It appears in the Advanced View when HTTP or HTTPS is the selected application protocol.<br><br>This subset allows you to configure application acceleration and optimization options for HTTP or HTTPS traffic.                                                                                                                                                                                                                                                             | <a href="#">Configuring Application Acceleration and Optimization, page 7-53</a>     |
| L7 Load-Balancing                         | Subset that appears only in the Advanced View for these protocols: <ul style="list-style-type: none"> <li>TCP with Generic, HTTP, HTTPS, RTSP, or SIP</li> <li>UDP with Generic, RADIUS, or SIP</li> </ul> This subset allows you to configure Layer 7 load-balancing options, such as: <ul style="list-style-type: none"> <li>Server farms/real servers</li> <li>Health monitoring probes</li> <li>Stickiness</li> <li>SSL initiation</li> </ul>                                                                         | <a href="#">Configuring Virtual Server Layer 7 Load Balancing, page 7-30</a>         |
| Default L7 Load-Balancing Action          | Subset that allows you to establish the default Layer 7 load-balancing actions for all network traffic that does not meet previously specified match conditions including the SSL initiation configuration.                                                                                                                                                                                                                                                                                                               | <a href="#">Configuring Virtual Server Default Layer 7 Load Balancing, page 7-50</a> |
| NAT                                       | Subset that allows you to set up Name Address Translation (NAT) for the virtual server.                                                                                                                                                                                                                                                                                                                                                                                                                                   | <a href="#">Configuring Virtual Server NAT, page 7-63</a>                            |

- Step 5** Do one of the following:
- Click **Deploy Now** to deploy the configuration on the ACE and save your entries to the running-configuration and startup-configuration files.
  - Click **Cancel** to exit the procedure without saving your entries and to return to the Virtual Servers table.
  - Click **Deploy Later** to save your entries and apply them at a later time.
- Step 6** (Optional) To display statistics and status information for an existing virtual server, from the Virtual Servers table, choose a virtual server and click **Details**.

A popup window appears that displays the detailed virtual server information (see the “[Displaying Virtual Server Statistics and Status Information](#)” section on page 7-65 for details).



**Note** This feature requires ACE module software Version A2(1.2), ACE appliance software Version A3(2.1), or later versions of either software. An error displays with earlier software versions.

#### Related Topics

- [Configuring Virtual Servers, page 7-2](#)
- [Virtual Server Configuration and ANM, page 7-2](#)
- [Virtual Server Usage Guidelines, page 7-5](#)
- [Information About Using ANM to Configure Virtual Servers, page 7-4](#)
- [Shared Objects and Virtual Servers, page 7-9](#)
- [Displaying Virtual Servers by Context, page 7-65](#)
- [Displaying Virtual Server Statistics and Status Information, page 7-65](#)
- [Managing Virtual Servers, page 7-66](#)
- [Deploying Virtual Servers, page 7-86](#)
- [Understanding Roles, page 18-6](#)

## Shared Objects and Virtual Servers

A shared object is one that is used by multiple virtual servers.

The following examples are shared objects:

- Action lists
- Class maps
- Parameter maps
- Real servers
- Server farms
- SSL services
- Sticky groups

Because these objects are shared, modifying an object's configuration in one virtual server can impact other virtual servers that use the same object.

### Configuring Shared Objects

ANM offers the following options for shared objects in virtual server configuration windows (Config > Devices > *context* > Load Balancing > Virtual Servers):

- **View**—Displays the object's configuration. The window refreshes with read-only fields and the following three buttons.
- **Cancel**—Closes the read-only view and to return to the previous window.
- **Edit**—Enables you to modify the selected object's configuration. The window refreshes with fields that can be modified, except for the Name field which remains read-only.



---

**Note** Before changing a shared object's configuration, make sure that you understand the effect of the changes on other virtual servers using the same object. As an alternative, consider using the Duplicate option instead.

---

- **Duplicate**—Enables you to create a new object with the same configuration as the selected object. The window refreshes with configurable fields. In the Name field, enter a unique name for the new object, and then modify the configuration as desired. This option allows you to create a new object without impacting other virtual servers using the same object.

### Deleting Virtual Servers with Shared Objects

If you create a virtual server and include shared objects in its configuration, deleting the virtual server does not delete the associated shared objects. This action ensures that other virtual servers using the same shared objects are not impacted.

### Related Topics

- [Managing Virtual Servers, page 7-66](#)
- [Virtual Server Protocols by Device Type, page 7-11](#)
- [Configuring Virtual Server Properties, page 7-11](#)
- [Configuring Virtual Server SSL Termination, page 7-17](#)
- [Configuring Virtual Server Protocol Inspection, page 7-18](#)
- [Configuring Virtual Server Layer 7 Load Balancing, page 7-30](#)
- [Configuring Virtual Server Default Layer 7 Load Balancing, page 7-50](#)
- [Configuring Application Acceleration and Optimization, page 7-53](#)
- [Configuring Virtual Server NAT, page 7-63](#)



## Virtual Server Protocols by Device Type

The protocols that are available for a virtual server depend on the ACE device that you are configuring. [Table 7-2](#) lists the protocols available for each device type.

**Table 7-2** Virtual Server Protocols for ACE Modules and Devices

| Protocol   | ACE Modules | ACE Appliance |
|------------|-------------|---------------|
| Any        | X           | X             |
| <b>TCP</b> |             |               |
| FTP        | X           | X             |
| Generic    | X           | X             |
| HTTP       | X           | X             |
| HTTPS      | X           | X             |
| Other      | X           | X             |
| RTSP       | X           | X             |
| RDP        | X           | X             |
| SIP        | X           | X             |
| <b>UDP</b> |             |               |
| DNS        | X           | X             |
| Generic    | X           | X             |
| Other      | X           | X             |
| RADIUS     | X           | X             |
| SIP        | X           | X             |

### Related Topics

- [Configuring Virtual Servers, page 7-2](#)
- [Configuring Virtual Server Properties, page 7-11](#)
- [Managing Virtual Servers, page 7-66](#)

## Configuring Virtual Server Properties

You can configure virtual server properties.

### Procedure

- 
- Step 1** Choose **Config > Devices > context > Load Balancing > Virtual Servers**.  
The Virtual Servers table appears.
- Step 2** In the Virtual Servers table, click **Poll Now** to instruct ANM to poll the devices and display the current values, and click **OK** when prompted if you want to poll the devices for data now.
- Step 3** Click **Add** to add a new virtual server, or choose an existing virtual server and click **Edit** to modify it.

The Virtual Server configuration window appears. The Properties configuration subset is open by default.

The fields that you see in the Properties configuration subset depend on whether you are using Advanced View or Basic View:

- To configure Advanced View properties, go to [Step 4](#).
- To configure Basic View properties, go to [Step 5](#).

**Step 4** In the Advanced View, configure the virtual server properties by entering the information in [Table 7-3](#).



**Note** Fields and information related to IPv6 require ACE module and ACE appliance software Version A5(1.0) or later.

**Table 7-3** Virtual Server Properties – Advanced View

| Field                    | Description                                                                                                                                                                                                                                                                                                                                                                                                                                                                                                                                                                                                         |
|--------------------------|---------------------------------------------------------------------------------------------------------------------------------------------------------------------------------------------------------------------------------------------------------------------------------------------------------------------------------------------------------------------------------------------------------------------------------------------------------------------------------------------------------------------------------------------------------------------------------------------------------------------|
| Virtual Server Name      | Name for the virtual server.                                                                                                                                                                                                                                                                                                                                                                                                                                                                                                                                                                                        |
| IP Address Type          | Field that appears only for ACE module and ACE appliance software Version A5(1.0) or later, which supports IPv4 and IPv6. Choose the address type of the virtual server: <b>IPv4</b> or <b>IPv6</b> .                                                                                                                                                                                                                                                                                                                                                                                                               |
| Virtual IP Address       | IP address for the virtual server.                                                                                                                                                                                                                                                                                                                                                                                                                                                                                                                                                                                  |
| Virtual IP Mask          | (IPv4 address type only) Subnet mask to apply to the virtual server IP address.                                                                                                                                                                                                                                                                                                                                                                                                                                                                                                                                     |
| Virtual IP Prefix Length | (IPv6 address type only) Enter the prefix length to apply to the virtual server IP address. The default length for the prefix is 128. IPv6 requires ACE module and ACE appliance software Version A5(1.0) or later.                                                                                                                                                                                                                                                                                                                                                                                                 |
| Transport Protocol       | Protocol that the virtual server supports: <ul style="list-style-type: none"> <li>• <b>Any</b>—The virtual server is to accept connections using any IP protocol.</li> <li>• <b>TCP</b>—The virtual server is to accept connections that use TCP.</li> <li>• <b>UDP</b>—The virtual server is to accept connections that use UDP.</li> </ul>                                                                                                                                                                                                                                                                        |
| Application Protocol     | Field that appears if TCP or UDP is selected. The application protocols that are available depend on the type of ACE being configured.<br>Choose the application protocol to be supported by the virtual server. <a href="#">Table 7-2</a> identifies the available protocols for each ACE device type.<br><b>Note</b> This field is read-only if you are editing an existing virtual server. ANM does not allow changes between protocols that require a change to the Layer 7 server load-balancing policy map. You need to delete the virtual server and create a new one with the desired application protocol. |
| Port                     | Field that appears for any TCP or UDP protocol.<br>Enter the port to be used for the specified protocol. Valid entries are from 0 to 65535 or a range of integers, such as 10-20. Enter 0 (zero) to indicate all ports.<br>For a complete list of protocols and ports, see the Internet Assigned Numbers Authority available at <a href="http://www.iana.org/numbers/">www.iana.org/numbers/</a>                                                                                                                                                                                                                    |
| All VLANs                | Check box that enables support of incoming traffic from all VLANs. Uncheck the check box to support incoming traffic from specific VLANs only.                                                                                                                                                                                                                                                                                                                                                                                                                                                                      |

Table 7-3 Virtual Server Properties – Advanced View (continued)

| Field                     | Description                                                                                                                                                                                                                                                                                                                                                                                                                                                                                                                                                                                                                                                                                                                                                                                                                                                                                                         |
|---------------------------|---------------------------------------------------------------------------------------------------------------------------------------------------------------------------------------------------------------------------------------------------------------------------------------------------------------------------------------------------------------------------------------------------------------------------------------------------------------------------------------------------------------------------------------------------------------------------------------------------------------------------------------------------------------------------------------------------------------------------------------------------------------------------------------------------------------------------------------------------------------------------------------------------------------------|
| VLAN                      | <p>Field appears if the All VLANs check box is unchecked.</p> <p>In the Available Items list, choose the VLANs to use for incoming traffic, and click <b>Add</b>. The items appear in the Selected Items list.</p> <p>To remove VLANs, choose them in the Selected Items lists, and click <b>Remove</b>. The items appear in the Available Items list.</p> <p><b>Note</b> You cannot change the VLAN for a virtual server once it is specified. Instead, delete the virtual server and create a new one with the desired VLAN.</p>                                                                                                                                                                                                                                                                                                                                                                                  |
| Connection Parameter Maps | <p>Field that appears if TCP is the selected protocol.</p> <p>Choose an existing connection parameter map or click <b>*New*</b> to create a new one as follows:</p> <ul style="list-style-type: none"> <li>If you chose an existing parameter map, you can view, modify, or duplicate the existing configuration. See the “<a href="#">Shared Objects and Virtual Servers</a>” section on page 7-9 for more information about modifying shared objects.</li> <li>If you click <b>*New*</b>, the Connection Parameter Maps configuration pane appears. Configure the connection parameter map as described in <a href="#">Table 10-2</a>.</li> </ul> <p><b>Note</b> Click <b>More Settings</b> to access the additional Connection Parameter Maps configuration attributes. By default, ANM hides the default Connection Parameter Maps configuration attributes and the attributes which are not commonly used.</p> |
| DNS Parameter Maps        | <p>Field that appears if DNS is the selected protocol over UDP.</p> <p>Choose an existing DNS parameter map or click <b>*New*</b> to create a new one as follows:</p> <ul style="list-style-type: none"> <li>If you chose an existing parameter map, you can view, modify, or duplicate the existing configuration. See the “<a href="#">Shared Objects and Virtual Servers</a>” section on page 7-9 for more information about modifying shared objects.</li> <li>If you click <b>*New*</b>, the DNS Parameter Maps configuration pane appears. Configure the DNS parameter map as described in <a href="#">Table 10-11</a>.</li> </ul>                                                                                                                                                                                                                                                                            |
| Generic Parameter Maps    | <p>Field that appears if Generic is the selected application protocol over TCP or UDP.</p> <p>Choose an existing Generic parameter map or click <b>*New*</b> to create a new one as follows:</p> <ul style="list-style-type: none"> <li>If you chose an existing parameter map, you can view, modify, or duplicate the existing configuration. See the “<a href="#">Shared Objects and Virtual Servers</a>” section on page 7-9 for more information about modifying shared objects.</li> <li>If you click <b>*New*</b>, the Generic Parameter Maps configuration pane appears. Configure the Generic parameter map as described in <a href="#">Table 10-4</a>.</li> </ul>                                                                                                                                                                                                                                          |
| HTTP Parameter Maps       | <p>Field appears if HTTP or HTTPS is the selected application protocol.</p> <p>Choose an existing HTTP parameter map or click <b>*New*</b> to create a new one as follows:</p> <ul style="list-style-type: none"> <li>If you chose an existing parameter map, you can view, modify, or duplicate the existing configuration. See the “<a href="#">Shared Objects and Virtual Servers</a>” section on page 7-9 for more information about modifying shared objects.</li> <li>If you click <b>*New*</b>, the HTTP Parameter Maps configuration pane appears. Configure the HTTP parameter map as described in <a href="#">Table 10-5</a>.</li> </ul>                                                                                                                                                                                                                                                                  |

Table 7-3 Virtual Server Properties – Advanced View (continued)

| Field                         | Description                                                                                                                                                                                                                                                                                                                                                                                                                                                                                                                                                                                                                                                                                                                                                                                                                                                                                                                                                                                                                                                                                                                                                                                                                                                                                                                                                                                                                                                                                                                                                                                                                                                                                                                               |
|-------------------------------|-------------------------------------------------------------------------------------------------------------------------------------------------------------------------------------------------------------------------------------------------------------------------------------------------------------------------------------------------------------------------------------------------------------------------------------------------------------------------------------------------------------------------------------------------------------------------------------------------------------------------------------------------------------------------------------------------------------------------------------------------------------------------------------------------------------------------------------------------------------------------------------------------------------------------------------------------------------------------------------------------------------------------------------------------------------------------------------------------------------------------------------------------------------------------------------------------------------------------------------------------------------------------------------------------------------------------------------------------------------------------------------------------------------------------------------------------------------------------------------------------------------------------------------------------------------------------------------------------------------------------------------------------------------------------------------------------------------------------------------------|
| RTSP Parameter Maps           | <p>Field that appears if RTSP is the selected application protocol over TCP.</p> <p>Choose an existing RTSP parameter map or click <b>*New*</b> to create a new one as follows:</p> <ul style="list-style-type: none"> <li>• If you chose an existing parameter map, you can view, modify, or duplicate the existing configuration. See the <a href="#">“Shared Objects and Virtual Servers” section on page 7-9</a> for more information about modifying shared objects.</li> <li>• If you click <b>*New*</b>, the RTSP Parameter Maps configuration pane appears. Configure the RTSP parameter map as described in <a href="#">Table 10-8</a>.</li> </ul>                                                                                                                                                                                                                                                                                                                                                                                                                                                                                                                                                                                                                                                                                                                                                                                                                                                                                                                                                                                                                                                                               |
| KAL-AP-TAG Name               | <p>Feature that is supported only for the ACE module software Version A2(2.0), ACE appliance software Version A4(1.0), and later versions for both device types. The KAL-AP-TAG feature allows the Cisco Global Site Selector (GSS) proprietary KAL-AP protocol to extract load and availability information from the ACE when a firewall is positioned between the GSS and the ACE. This feature allows you to configure a tag (name) per VIP for a maximum of 4096 tags on an ACE. This feature does not replace the tag per domain feature. For more information about this feature, see the <i>Release Note for the Cisco Application Control Engine Module (Software Version A2(2.0))</i> or the <i>Cisco Application Control Engine Module Server Load-Balancing Configuration Guide (Software Version A2(3.0))</i>, the Configuring Health Monitoring chapter.</p> <p>In the KAL-AP-TAG Name field, enter the name as an unquoted text string with no spaces and a maximum of 76 alphanumeric characters.</p> <p>The following scenarios are not supported and will result in an error:</p> <ul style="list-style-type: none"> <li>• You cannot configure a tag name for a VIP that already has a tag configuration as part of a different policy configuration.</li> <li>• You cannot associate the same tag name with more than one VIP.</li> <li>• You cannot associate the same tag name with a domain and a VIP.</li> <li>• You cannot assign two different tags to two different Layer 3 class maps that have the same VIP, but different port numbers. The KAL-AP protocol considers these class maps to have the same VIP and calculates the load for both Layer 3 rules together when the GSS queries the VIP.</li> </ul> |
| KAL-AP-Primary-Out-Of-Service | <p>Feature that is supported only for ACE module software Version A2(3.1), ACE appliance software Version A4(1.0), and later versions of either device type. Check the checkbox to enable the ACE to notify a Global Site Selector (GSS) that the primary server farm is down when the backup server farm is in use. Uncheck the checkbox to disable this feature.</p> <p>By default, when you configure a redirect server farm as a backup server farm on the ACE and the primary server farm fails, the backup server farm redirects client requests to another data center; however, the VIP remains in the INSERVICE state.</p> <p>When you configure the ACE to communicate with a GSS, it provides information for server availability. When a backup server is in use after the primary server farm is down, this feature enables the ACE to inform the GSS that the VIP for the primary server farm is out of service by returning a load value of 255. The GSS recognizes that the primary server farm is down and sends future DNS requests with the IP address of the other data center.</p>                                                                                                                                                                                                                                                                                                                                                                                                                                                                                                                                                                                                                                   |

Table 7-3 Virtual Server Properties – Advanced View (continued)

| Field         | Description                                                                                                                                                                                                                                                                                                                                                                                                                                                                                                                                                                                                                                                                                                                                                                                                                                                                                                                                                                                                                                                                                                                                      |
|---------------|--------------------------------------------------------------------------------------------------------------------------------------------------------------------------------------------------------------------------------------------------------------------------------------------------------------------------------------------------------------------------------------------------------------------------------------------------------------------------------------------------------------------------------------------------------------------------------------------------------------------------------------------------------------------------------------------------------------------------------------------------------------------------------------------------------------------------------------------------------------------------------------------------------------------------------------------------------------------------------------------------------------------------------------------------------------------------------------------------------------------------------------------------|
| ICMP Reply    | <p>Virtual server response to ICMP ECHO requests as follows:</p> <ul style="list-style-type: none"> <li>• <b>None</b>—The virtual server is not to send ICMP ECHO-REPLY responses to ICMP requests.</li> <li>• <b>Active</b>—The virtual server is to send ICMP ECHO-REPLY responses only if the configured VIP is active.</li> <li>• <b>Always</b>—The virtual server is always to send ICMP ECHO-REPLY responses to ICMP requests.</li> <li>• <b>Primary Inservice</b>—The virtual server is to reply to an ICMP ping only if the primary server farm state is UP, regardless of the state of the backup server farm. If this option is selected and the primary server farm state is DOWN, the ACE discards the ICMP request and the request times out.</li> </ul>                                                                                                                                                                                                                                                                                                                                                                            |
| VIP Advertise | <p>Field that appears for ACE modules only.</p> <p>This option allows the ACE to advertise the IP address of the virtual server as the host route. Choose the desired VIP advertise option as follows:</p> <ul style="list-style-type: none"> <li>• <b>None</b>—The ACE does not advertise the IP address of the virtual server as the host route.</li> <li>• <b>Active</b>—The ACE advertises the IP address of the virtual server as the host route only if there is at least one active real server in the server farm.</li> <li>• <b>Always</b>—The ACE always advertises the IP address of the virtual server as the host route.</li> <li>• <b>Active-Metric</b>—The ACE advertises the IP address of the virtual server as the host route if the following occurs: <ul style="list-style-type: none"> <li>• There is at least one active real server in the server farm.</li> <li>• A distance metric is specified for the route in the Distance field.</li> </ul> </li> <li>• <b>Always-Metric</b>—The ACE advertises the IP address of the virtual server as the host route, using the distance metric in the Distance field.</li> </ul> |
| Distance      | <p>Field that appears for ACE modules only.</p> <p>This field appears if you chose Active-Metric or Always-Metric in the VIP Advertise field. Enter the <b>administrative distance</b> to be included in the routing table. Valid entries are integers from 1 to 254.</p>                                                                                                                                                                                                                                                                                                                                                                                                                                                                                                                                                                                                                                                                                                                                                                                                                                                                        |
| Status        | <p>Operating state of the virtual server as follows:</p> <ul style="list-style-type: none"> <li>• <b>In Service</b>—Enables the virtual server for load-balancing operations.</li> <li>• <b>Out Of Service</b>—Disables the virtual server for load-balancing operations.</li> </ul>                                                                                                                                                                                                                                                                                                                                                                                                                                                                                                                                                                                                                                                                                                                                                                                                                                                             |

**Step 5** In the Basic View, configure virtual server properties by entering the information in [Table 7-4](#).



**Note**

Fields and information related to IPv6 require ACE module and ACE appliance software Version A5(1.0) or later.

**Table 7-4** Virtual Server Properties – Basic View

| Field                | Description                                                                                                                                                                                                                                                                                                                                                                                                                                                                                                                                                                                                         |
|----------------------|---------------------------------------------------------------------------------------------------------------------------------------------------------------------------------------------------------------------------------------------------------------------------------------------------------------------------------------------------------------------------------------------------------------------------------------------------------------------------------------------------------------------------------------------------------------------------------------------------------------------|
| Virtual Server Name  | Name for the virtual server.                                                                                                                                                                                                                                                                                                                                                                                                                                                                                                                                                                                        |
| IP Address Type      | Field that appears only for ACE module and ACE appliance software Version A5(1.0) or later, which supports IPv4 and IPv6. Choose the address type of the virtual server: <b>IPv4</b> or <b>IPv6</b> .                                                                                                                                                                                                                                                                                                                                                                                                               |
| Virtual IP Address   | IP address for the virtual server.                                                                                                                                                                                                                                                                                                                                                                                                                                                                                                                                                                                  |
| Transport Protocol   | Protocol that the virtual server supports as follows: <ul style="list-style-type: none"> <li>Any—The virtual server accepts connections using any IP protocol.</li> <li>TCP—The virtual server accepts connections that use TCP.</li> <li>UDP—The virtual server accepts connections that use UDP.</li> </ul>                                                                                                                                                                                                                                                                                                       |
| Application Protocol | Field that appears if TCP or UDP is selected. The application protocols that are available depend on the type of ACE being configured.<br>Choose the application protocol to be supported by the virtual server. <a href="#">Table 7-2</a> identifies the available protocols for each ACE device type.<br><b>Note</b> This field is read-only if you are editing an existing virtual server. ANM does not allow changes between protocols that require a change to the Layer 7 server load-balancing policy map. You need to delete the virtual server and create a new one with the desired application protocol. |
| Port                 | Field that appears for any specific TCP or UDP protocol.<br>Enter the port to be used for the specified protocol. Valid entries are from 0 to 65535 or a range of integers, such as 10-20. Enter 0 (zero) to indicate all ports.<br>For a complete list of all protocols and ports, see the Internet Assigned Numbers Authority available at <a href="http://www.iana.org/numbers/">www.iana.org/numbers/</a>                                                                                                                                                                                                       |
| All VLANs            | Check box that enables support of incoming traffic from all VLANs. Uncheck the check box to support incoming traffic from specific VLANs only.                                                                                                                                                                                                                                                                                                                                                                                                                                                                      |
| VLAN                 | Field that appears if the All VLANs check box is unchecked.<br>In the Available Items list, choose the VLANs to use for incoming traffic, and click <b>Add</b> . The items appear in the Selected Items list.<br>To remove VLANs, choose them in the Selected Items lists, and click <b>Remove</b> . The items appear in the Available Items list.<br><b>Note</b> You cannot change the VLAN for a virtual server once it is specified. Instead, delete the virtual server and create a new one with the desired VLAN.                                                                                              |

**Step 6** Do one of the following:

- Click **Deploy Now** to deploy the configuration on the ACE and save your entries to the running-configuration and startup-configuration files.
- Click **Cancel** to exit the procedure without saving your entries.
- Click **Deploy Later** to save your entries and apply them at a later time.

#### Related Topics

- [Configuring Virtual Servers, page 7-2](#)

- [Configuring Virtual Server SSL Termination, page 7-17](#)

## Configuring Virtual Server SSL Termination

You can configure virtual server SSL termination service, which allows the virtual server to act as an SSL proxy server and terminate SSL sessions between it and its clients.

### Assumption

Make sure that a virtual server has been configured for HTTPS over TCP or Other over TCP in the Properties configuration subset. For more information, see the [“Configuring Virtual Server Properties” section on page 7-11](#).

### Procedure

- 
- Step 1** Choose **Config > Devices > context > Load Balancing > Virtual Servers**.
- The Virtual Servers table appears.
- Step 2** In the Virtual Servers table, choose the virtual server that you want to configure for SSL termination, and click **Edit**.
- The Virtual Server configuration window appears.
- Step 3** In the Virtual Server configuration window, click **SSL Termination**.
- The Proxy Service Name field appears.
- Step 4** In the Proxy Service Name field, choose an existing SSL termination service, or choose **\*New\*** to create a new SSL proxy service, and do one of the following:
- If you chose an existing SSL service, the window refreshes and allows you to view, modify, or duplicate the existing configuration. See the [“Shared Objects and Virtual Servers” section on page 7-9](#) for more information about modifying shared objects.
  - If you chose **\*New\***, the Proxy Service configuration subset appears.
- Step 5** Configure the SSL service using the information in [Table 7-5](#).
- For more information about SSL, see the [“Configuring SSL” section on page 11-1](#).

**Table 7-5** Virtual Server SSL Attributes

| Field           | Description                                                                                                                                                                                                                                                                                                         |
|-----------------|---------------------------------------------------------------------------------------------------------------------------------------------------------------------------------------------------------------------------------------------------------------------------------------------------------------------|
| Name            | Name for this SSL proxy service. Valid entries are alphanumeric strings with a maximum of 26 characters.                                                                                                                                                                                                            |
| Keys            | SSL key pair to use during the SSL handshake for data encryption.                                                                                                                                                                                                                                                   |
| Certificates    | SSL certificate to use during the SSL handshake.                                                                                                                                                                                                                                                                    |
| Chain Groups    | Chain group to use during the SSL handshake.                                                                                                                                                                                                                                                                        |
| Auth Groups     | SSL authentication group to associate with this proxy server service.                                                                                                                                                                                                                                               |
| CRL Best-Effort | Option that appears if you chose an authentication group in the Auth Groups field.<br>Check the check box to allow the ANM to search client certificates for the service to determine if it contains a CRL in the extension and retrieve the value, if it exists.<br>Uncheck the check box to disable this feature. |

**Table 7-5** Virtual Server SSL Attributes (continued)

| Field          | Description                                                                                                                                        |
|----------------|----------------------------------------------------------------------------------------------------------------------------------------------------|
| CRL Name       | Option that appears if the CRL Best-Effort check box is clear.<br>Choose the Certificate Revocation List the ANM is to use for this proxy service. |
| Parameter Maps | SSL parameter map to associate with this proxy server service.                                                                                     |

**Step 6** Do one of the following:

- Click **Deploy Now** to deploy this configuration on the ACE and save your entries to the running-configuration and startup-configuration files.
- Click **Cancel** to exit this procedure without saving your entries.
- Click **Deploy Later** to save your entries and apply them at a later time.

#### Related Topics

- [Configuring Virtual Servers, page 7-2](#)
- [Configuring Virtual Server Properties, page 7-11](#)

## Configuring Virtual Server Protocol Inspection

You can configure protocol inspection on a virtual server, which allows the virtual server to verify protocol behavior and identify unwanted or malicious traffic passing through the ACE.

In the Advanced View, protocol inspection configuration is available for the following virtual server protocol configurations:

- TCP with FTP, HTTP, HTTPS, RTSP, or SIP
- UDP with DNS or SIP

In the Basic View, protocol inspection configuration is available for TCP with FTP.

See [Table 7-2](#) for a list of protocols by ACE device type.

#### Assumption

Make sure that a virtual server has been configured to use one of the protocols that supports protocol inspection in the Properties configuration subset. See the “[Configuring Virtual Server Properties](#)” section on [page 7-11](#) for information on configuring these protocols.

#### Procedure

**Step 1** Choose the item to configure:

- To configure a virtual server, choose **Config > Devices > context > Load Balancing > Virtual Servers**.
- To configure a configuration building block, choose **Config > Global > All Building Blocks > building\_block > Load Balancing > Virtual Servers**.

The Virtual Servers table appears.



- Step 2** In the Virtual Servers table, choose the virtual server that you want to configure for protocol inspection, and click **Edit**.  
The Virtual Server configuration window appears.
- Step 3** Click **Protocol Inspection**.  
The Enable Inspect check box appears.
- Step 4** Check the **Enable Inspect** check box to enable inspection on the specified traffic or uncheck it to disable inspection on this traffic.  
By default, the ACE allows all request methods.
- Step 5** (Optional) If you checked the Enable Inspect check box, configure additional inspection options using the information in [Table 7-6](#).

**Table 7-6 Protocol Inspection Configuration Options**

| Protocol | Action                                                                                                                                                                                                                                                                                                                                                                                                                                                                                                                                                                                                                                                                                                                                                                                                                                                                                                                                                                                       |
|----------|----------------------------------------------------------------------------------------------------------------------------------------------------------------------------------------------------------------------------------------------------------------------------------------------------------------------------------------------------------------------------------------------------------------------------------------------------------------------------------------------------------------------------------------------------------------------------------------------------------------------------------------------------------------------------------------------------------------------------------------------------------------------------------------------------------------------------------------------------------------------------------------------------------------------------------------------------------------------------------------------|
| DNS      | In the length field, enter the maximum length of the DNS packet in bytes as defined in the Length field. If you do not enter a value in this field, the DNS packet size is not checked.                                                                                                                                                                                                                                                                                                                                                                                                                                                                                                                                                                                                                                                                                                                                                                                                      |
| FTP      | <ol style="list-style-type: none"> <li>a. Check the <b>Use Strict</b> check box to specify that the virtual server is to perform enhanced inspection of FTP traffic and enforce compliance with RFC standards. Uncheck the check box to specify that the virtual server is not to perform enhanced FTP inspection.</li> <li>b. (Optional) If you checked the Use Strict check box, in the Blocked FTP Commands field, identify the commands that are to be denied by the virtual server. See <a href="#">Table 14-8</a> for more information about the FTP commands. <ul style="list-style-type: none"> <li>• Choose the commands that are to be blocked by the virtual server in the Available Items list, and click <b>Add</b>. The commands appear in the Selected Items list.</li> <li>• To remove commands that you do not want to be blocked, choose them in the Selected Items list, and click <b>Remove</b>. The commands appear in the Available Items list.</li> </ul> </li> </ol> |

Table 7-6 Protocol Inspection Configuration Options (continued)

| Protocol      | Action                                                                                                                                                                                                                                                                                                                                                                                                                                                                                                                                                                                                                                                                                                                                                                                                                                                                                                                                                                                                                                                                                                                                                                                                                                                                                                                                                                                                                                                                                                                                                                                                                                                                                                                                                                                                                                         |
|---------------|------------------------------------------------------------------------------------------------------------------------------------------------------------------------------------------------------------------------------------------------------------------------------------------------------------------------------------------------------------------------------------------------------------------------------------------------------------------------------------------------------------------------------------------------------------------------------------------------------------------------------------------------------------------------------------------------------------------------------------------------------------------------------------------------------------------------------------------------------------------------------------------------------------------------------------------------------------------------------------------------------------------------------------------------------------------------------------------------------------------------------------------------------------------------------------------------------------------------------------------------------------------------------------------------------------------------------------------------------------------------------------------------------------------------------------------------------------------------------------------------------------------------------------------------------------------------------------------------------------------------------------------------------------------------------------------------------------------------------------------------------------------------------------------------------------------------------------------------|
| HTTP or HTTPS | <p>a. Check the <b>Logging Enabled</b> check box to enable monitoring of Layer 3 and Layer 4 traffic. When enabled, this feature logs every URL request that is sent in the specified class of traffic, including the source or destination IP address and the URL that is accessed. Uncheck the check box to disable monitoring of Layer 3 and Layer 4 traffic.</p> <p>b. In the Policy subset, click <b>Add</b> to add a new match condition and action, or choose an existing match condition and action and click <b>Edit</b> to modify it. The Policy configuration pane appears.</p> <p>c. In the Matches field, choose an existing class map or <b>*New*</b> or <b>*Inline Match*</b> to configure new match criteria for protocol inspection.</p> <p>If you chose an existing class map, the window refreshes and allows you to view, modify, or duplicate the selected class map. See the “<a href="#">Shared Objects and Virtual Servers</a>” section on <a href="#">page 7-9</a> for more information about modifying shared objects.</p> <p>d. Configure match criteria and related actions using the information in <a href="#">Table 7-7</a>.</p> <p>e. Do one of the following:</p> <ul style="list-style-type: none"> <li>• Click <b>OK</b> to save your entries. The Conditions table refreshes with the new entry.</li> <li>• Click <b>Cancel</b> to exit the Policy subset without saving your entries.</li> </ul> <p>f. In the Default Action field, choose the default action that the virtual server is to take when specified match conditions for protocol inspection are not met:</p> <ul style="list-style-type: none"> <li>• <b>Permit</b>—The specified HTTP traffic is to be received by the virtual server.</li> <li>• <b>Reset</b>—The specified HTTP traffic is to be denied by the virtual server.</li> </ul> |

Table 7-6 Protocol Inspection Configuration Options (continued)

| Protocol | Action                                                                                                                                                                                                                                                                                                                                                                                                                                                                                                                                                                                                                                                                                                                                                                                                                                                                                                                                                                                                                                                                                                                                                                                                                                                                                                                                                                                                                                                                                                                                                                                                                                                                                                                                                                                                                                                                                                                                                                                                                                                                                                                                                                                                                                                                                                                                                                                                                                                                                                                                                                                                                                                                                                                                                                                                                                                                                                                                                                                                                                                                                                                                                                                                                                                                                                                                                                                                                                                                                                     |
|----------|------------------------------------------------------------------------------------------------------------------------------------------------------------------------------------------------------------------------------------------------------------------------------------------------------------------------------------------------------------------------------------------------------------------------------------------------------------------------------------------------------------------------------------------------------------------------------------------------------------------------------------------------------------------------------------------------------------------------------------------------------------------------------------------------------------------------------------------------------------------------------------------------------------------------------------------------------------------------------------------------------------------------------------------------------------------------------------------------------------------------------------------------------------------------------------------------------------------------------------------------------------------------------------------------------------------------------------------------------------------------------------------------------------------------------------------------------------------------------------------------------------------------------------------------------------------------------------------------------------------------------------------------------------------------------------------------------------------------------------------------------------------------------------------------------------------------------------------------------------------------------------------------------------------------------------------------------------------------------------------------------------------------------------------------------------------------------------------------------------------------------------------------------------------------------------------------------------------------------------------------------------------------------------------------------------------------------------------------------------------------------------------------------------------------------------------------------------------------------------------------------------------------------------------------------------------------------------------------------------------------------------------------------------------------------------------------------------------------------------------------------------------------------------------------------------------------------------------------------------------------------------------------------------------------------------------------------------------------------------------------------------------------------------------------------------------------------------------------------------------------------------------------------------------------------------------------------------------------------------------------------------------------------------------------------------------------------------------------------------------------------------------------------------------------------------------------------------------------------------------------------------|
| RTSP     | There are no protocol-specific inspection options for RTSP.                                                                                                                                                                                                                                                                                                                                                                                                                                                                                                                                                                                                                                                                                                                                                                                                                                                                                                                                                                                                                                                                                                                                                                                                                                                                                                                                                                                                                                                                                                                                                                                                                                                                                                                                                                                                                                                                                                                                                                                                                                                                                                                                                                                                                                                                                                                                                                                                                                                                                                                                                                                                                                                                                                                                                                                                                                                                                                                                                                                                                                                                                                                                                                                                                                                                                                                                                                                                                                                |
| SIP      | <p>a. In the Actions subset, click <b>Add</b> to add a new match condition and action, or choose an existing match condition and action, and click <b>Edit</b> to modify it. The Actions configuration pane appears.</p> <p>b. In the Matches field, choose an existing class map or <b>*New*</b> or <b>*Inline Match*</b> to configure new match criteria for protocol inspection.</p> <p>If you chose an existing class map, the window refreshes and allows you to view, modify, or duplicate the selected class map. See the “<a href="#">Shared Objects and Virtual Servers</a>” section on <a href="#">page 7-9</a> for more information about modifying shared objects.</p> <p>c. Configure match criteria and related actions using the information in <a href="#">Table 7-9</a>.</p> <p>d. In the Action field, choose the action that the virtual server is to take when the specified match conditions are met:</p> <ul style="list-style-type: none"> <li>– <b>Drop</b>—The specified SIP traffic is discarded by the virtual server.</li> <li>– <b>Permit</b>—The specified SIP traffic is received by the virtual server.</li> <li>– <b>Reset</b>—The specified SIP traffic is denied by the virtual server.</li> </ul> <p>e. Do one of the following:</p> <ul style="list-style-type: none"> <li>– Click <b>OK</b> to save your entries. The Conditions table refreshes with the new entry.</li> <li>– Click <b>Cancel</b> to exit the Conditions subset without saving your entries and to return to the Conditions table.</li> </ul> <p>f. In the SIP Parameter Map field, choose an existing parameter map or choose <b>*New*</b> to configure a new one.</p> <p>If you chose an existing parameter map, the window refreshes and allows you to view, modify, or delete the selected parameter map. See the “<a href="#">Shared Objects and Virtual Servers</a>” section on <a href="#">page 7-9</a> for more information about modifying shared objects.</p> <p>g. Configure SIP parameter map options using the information in <a href="#">Table 10-9</a>.</p> <p>h. In the Secondary Connection Parameter Map field, choose an existing parameter map or choose <b>*New*</b> to configure a new one.</p> <p>If you chose an existing parameter map, the window refreshes and allows you to view, modify, or delete the selected parameter map. See the “<a href="#">Shared Objects and Virtual Servers</a>” section on <a href="#">page 7-9</a> for more information about modifying shared objects.</p> <p>i. Configure secondary connection parameter map options using the information in <a href="#">Table 10-2</a>.</p> <p>j. In the Default Action field, choose the default action that the virtual server is to take when specified match conditions for SIP protocol inspection are not met:</p> <ul style="list-style-type: none"> <li>– <b>Drop</b>—The specified SIP traffic is discarded by the virtual server.</li> <li>– <b>Permit</b>—The specified SIP traffic is received by the virtual server.</li> <li>– <b>Reset</b>—The specified SIP traffic is denied by the virtual server.</li> </ul> <p>k. Check the <b>Logging Enabled</b> check box to enable monitoring of Layer 3 and Layer 4 traffic. When enabled, this feature logs every URL request that is sent in the specified class of traffic, including the source or destination IP address and the URL that is accessed. Uncheck the check box to disable monitoring of Layer 3 and Layer 4 traffic.</p> |

**Table 7-7 HTTP and HTTPS Protocol Inspection Match Criteria Configuration**

| Selection          | Action                                                                                                                                                                                                                                                                                                                                                                                                                                                                                                                                                                                                                                                                                                                                                                                                                                                                                                                                                                                                                                                                                                                                                                                                                                                                                                                                                                      |
|--------------------|-----------------------------------------------------------------------------------------------------------------------------------------------------------------------------------------------------------------------------------------------------------------------------------------------------------------------------------------------------------------------------------------------------------------------------------------------------------------------------------------------------------------------------------------------------------------------------------------------------------------------------------------------------------------------------------------------------------------------------------------------------------------------------------------------------------------------------------------------------------------------------------------------------------------------------------------------------------------------------------------------------------------------------------------------------------------------------------------------------------------------------------------------------------------------------------------------------------------------------------------------------------------------------------------------------------------------------------------------------------------------------|
| Existing class map | <p><b>a.</b> Click <b>View</b> to review the match condition information for the selected class map.</p> <p><b>b.</b> Do one of the following:</p> <ul style="list-style-type: none"> <li>– Click <b>Cancel</b> to continue without making changes and to return to the previous window.</li> <li>– Click <b>Edit</b> to modify the existing configuration.</li> <li>– Click <b>Duplicate</b> to create a new class map with the same attributes without affecting other virtual servers using the same class map.</li> </ul> <p>See the “<a href="#">Shared Objects and Virtual Servers</a>” section on page 7-9 for information about modifying shared objects.</p> <p><b>c.</b> In the Action field, choose the action that the virtual server is to perform on the traffic if it matches the specified match criteria:</p> <ul style="list-style-type: none"> <li>– <b>Permit</b>—The specified traffic is received by the virtual server if it meets the specified deep inspection match criteria.</li> <li>– <b>Reset</b>—The specified traffic is denied by the virtual server, which then sends a TCP reset message to the client or server to close the connection.</li> </ul>                                                                                                                                                                                     |
| *New*              | <p><b>a.</b> In the Name field, specify a unique name for this class map.</p> <p><b>b.</b> In the Match field, choose the method to be used to evaluate multiple match statements when multiple match conditions exist:</p> <ul style="list-style-type: none"> <li>– <b>Any</b>—A match exists if at least one of the match conditions is satisfied.</li> <li>– <b>All</b>—A match exists only if all match conditions are satisfied.</li> </ul> <p><b>c.</b> In the Conditions table, click <b>Add</b> to add a new set of conditions, or choose an existing entry, and click <b>Edit</b> to modify it. The Type field appears.</p> <p><b>d.</b> In the Type field, choose the type of condition that is to be met for protocol inspection.</p> <p><b>e.</b> Provide condition-specific criteria using the information in <a href="#">Table 7-8</a>.</p> <p><b>f.</b> In the Action field, choose the action that the virtual server is to perform on the traffic if it matches the specified match criteria:</p> <ul style="list-style-type: none"> <li>– <b>Permit</b>—The specified traffic is received by the virtual server if it meets the specified deep inspection match criteria.</li> <li>– <b>Reset</b>—The specified traffic is denied by the virtual server, which then sends a TCP reset message to the client or server to close the connection.</li> </ul> |
| *Inline Match*     | <p><b>a.</b> In the Conditions Type field, choose the type of inline match condition that is to be met for protocol inspection.</p> <p><b>b.</b> Provide condition-specific criteria using the information in <a href="#">Table 7-8</a>.</p> <p><b>c.</b> In the Action field, choose the action that the virtual server is to perform on the traffic if it matches the specified match criteria:</p> <ul style="list-style-type: none"> <li>– <b>Permit</b>—The specified traffic is received by the virtual server if it meets the specified deep inspection match criteria.</li> <li>– <b>Reset</b>—The specified traffic is denied by the virtual server, which then sends a TCP reset message to the client or server to close the connection.</li> </ul>                                                                                                                                                                                                                                                                                                                                                                                                                                                                                                                                                                                                              |

**Table 7-8 HTTP and HTTPS Protocol Inspection Conditions and Options**

| Condition                 | Description                                                                                                                                                                                                                                                                                                                                                                                                                                                                                                                                                                                                                                                                                                                                                                                                                                                                                                                                                                                                                                                                                                                                                                                                                                                                                                                                                                                                                                                                                                                                                                                                                                                                                                                                                                                                                                                                                                          |
|---------------------------|----------------------------------------------------------------------------------------------------------------------------------------------------------------------------------------------------------------------------------------------------------------------------------------------------------------------------------------------------------------------------------------------------------------------------------------------------------------------------------------------------------------------------------------------------------------------------------------------------------------------------------------------------------------------------------------------------------------------------------------------------------------------------------------------------------------------------------------------------------------------------------------------------------------------------------------------------------------------------------------------------------------------------------------------------------------------------------------------------------------------------------------------------------------------------------------------------------------------------------------------------------------------------------------------------------------------------------------------------------------------------------------------------------------------------------------------------------------------------------------------------------------------------------------------------------------------------------------------------------------------------------------------------------------------------------------------------------------------------------------------------------------------------------------------------------------------------------------------------------------------------------------------------------------------|
| Content                   | <p>Specific content contained within the HTTP entity-body to be used for application inspection decisions.</p> <ol style="list-style-type: none"> <li>a. In the Content Expression field, enter the content that is to be matched. Valid entries are alphanumeric strings from 1 to 255 characters.</li> <li>b. In the Content Offset field, enter the number of bytes to be ignored starting with the first byte of the Message body, after the empty line (CR,LF,CR,LF) between the headers and the body of the message. Valid entries are from 1 to 255 bytes.</li> </ol>                                                                                                                                                                                                                                                                                                                                                                                                                                                                                                                                                                                                                                                                                                                                                                                                                                                                                                                                                                                                                                                                                                                                                                                                                                                                                                                                         |
| Content Length            | <p>Content parse length is used for application inspection decisions.</p> <ol style="list-style-type: none"> <li>a. In the Content Length Operator field, choose the operand to use to compare content length: <ul style="list-style-type: none"> <li>– <b>Equal To</b>—The content length must equal the number in the Content Length Value field.</li> <li>– <b>Greater Than</b>—The content length must be greater than the number in the Content Length Value field.</li> <li>– <b>Less Than</b>—The content length must be less than the number in the Content Length Value field.</li> <li>– <b>Range</b>—The content length must be within the range specified in the Content Length Lower Value field and the Content Length Higher Value field.</li> </ul> </li> <li>b. Enter values to apply for content length comparison: <ul style="list-style-type: none"> <li>– If you chose Equal To, Greater Than, or Less Than in the Content Length Operator field, the Content Length Value field appears. In the Content Length Value field, enter the number of bytes for comparison. Valid entries are from 0 to 4294967295.</li> <li>– If you chose Range in the Content Length Operator field, the Content Length Lower Value and the Content Length Higher Value fields appear: <ol style="list-style-type: none"> <li>1. In the Content Length Lower Value field, enter the lowest number of bytes to be used for this match condition. Valid entries are from 0 to 4294967295. The number in this field must be less than the number entered in the Content Length Higher Value field.</li> <li>2. In the Content Length Higher Value field, enter the highest number of bytes to be used for this match condition. Valid entries are from 0 to 4294967295. The number in this field must be greater than the number entered in the Content Length Lower Value field.</li> </ol> </li> </ul> </li> </ol> |
| Content Type Verification | <p>Verification of MIME-type messages with the header MIME-type is to be used for application inspection decisions. This option verifies that the header MIME-type value is in the internal list of supported MIME-types and that the header MIME-type matches the content in the data or body portion of the message.</p>                                                                                                                                                                                                                                                                                                                                                                                                                                                                                                                                                                                                                                                                                                                                                                                                                                                                                                                                                                                                                                                                                                                                                                                                                                                                                                                                                                                                                                                                                                                                                                                           |

Table 7-8 HTTP and HTTPS Protocol Inspection Conditions and Options (continued)

| Condition        | Description                                                                                                                                                                                                                                                                                                                                                                                                                                                                                                                                                                                                                                                                                                                                                                                                                                                                                                                                                                                                                                                                                                                                                                                                                                                                                                                                                                                                                                                                                                                                                                                                                                                                                                                                                                                                                                                                                                                                                                                                                                                                                                                                                                                                                                                                                   |
|------------------|-----------------------------------------------------------------------------------------------------------------------------------------------------------------------------------------------------------------------------------------------------------------------------------------------------------------------------------------------------------------------------------------------------------------------------------------------------------------------------------------------------------------------------------------------------------------------------------------------------------------------------------------------------------------------------------------------------------------------------------------------------------------------------------------------------------------------------------------------------------------------------------------------------------------------------------------------------------------------------------------------------------------------------------------------------------------------------------------------------------------------------------------------------------------------------------------------------------------------------------------------------------------------------------------------------------------------------------------------------------------------------------------------------------------------------------------------------------------------------------------------------------------------------------------------------------------------------------------------------------------------------------------------------------------------------------------------------------------------------------------------------------------------------------------------------------------------------------------------------------------------------------------------------------------------------------------------------------------------------------------------------------------------------------------------------------------------------------------------------------------------------------------------------------------------------------------------------------------------------------------------------------------------------------------------|
| Header           | <p>Name and value in an HTTP header are used for application inspection decisions.</p> <ul style="list-style-type: none"> <li>a. In the Header field, choose one of the predefined HTTP headers to match, or choose HTTP Header to specify a different HTTP header.</li> <li>b. If you chose HTTP Header, in the Header Name field, enter the name of the HTTP header to match. Valid entries are unquoted text strings with no spaces and a maximum of 64 alphanumeric characters.</li> <li>c. In the Header Value field, enter the header-value expression string to compare against the value in the specified field in the HTTP header. Valid entries are text strings with a maximum of 255 alphanumeric characters. The ACE supports regular expressions for matching. Header expressions allow spaces, provided that the spaces are escaped or quoted. All headers in the header map must be matched. See <a href="#">Table 14-33</a> for a list of the supported characters that you can use in regular expressions.</li> </ul>                                                                                                                                                                                                                                                                                                                                                                                                                                                                                                                                                                                                                                                                                                                                                                                                                                                                                                                                                                                                                                                                                                                                                                                                                                                       |
| Header Length    | <p>Length of the header in the HTTP message used for application inspection decisions.</p> <ul style="list-style-type: none"> <li>a. In the Header Length Type field, specify whether HTTP header request or response messages are to be used for application inspection decisions: <ul style="list-style-type: none"> <li>– <b>Request</b>—HTTP header request messages are to be checked for header length.</li> <li>– <b>Response</b>—HTTP header response messages are to be checked for header length.</li> </ul> </li> <li>b. In the Header Length Operator field, choose the operand to be used to compare header length: <ul style="list-style-type: none"> <li>– <b>Equal To</b>—The header length must equal the number in the Header Length Value field.</li> <li>– <b>Greater Than</b>—The header length must be greater than the number in the Header Length Value field.</li> <li>– <b>Less Than</b>—The header length must be less than the number in the Header Length Value field.</li> <li>– <b>Range</b>—The header length must be within the range specified in the Header Length Lower Value field and the Header Length Higher Value field.</li> </ul> </li> <li>c. Enter values to apply for header length comparison: <ul style="list-style-type: none"> <li>– If you chose Equal To, Greater Than, or Less Than in the Header Length Operator field, the Header Length Value field appears. In the Header Length Value field, enter the number of bytes for comparison. Valid entries are from 0 to 255.</li> <li>– If you chose Range in the Header Length Operator field, the Header Length Lower Value and the Header Length Higher Value fields appear: <ol style="list-style-type: none"> <li>1. In the Header Length Lower Value field, enter the lowest number of bytes to be used for this match condition. Valid entries are from 0 to 255. The number in this field must be less than the number entered in the Header Length Higher Value field.</li> <li>2. In the Header Length Higher Value field, enter the highest number of bytes to be used for this match condition. Valid entries are from 1 to 255. The number in this field must be greater than the number entered in the Header Length Lower Value field.</li> </ol> </li> </ul> </li> </ul> |
| Header MIME Type | <p>Multipurpose Internet Mail Extension (MIME) message types are used for application inspection decisions.</p> <p>In the Header MIME Type field, choose the MIME message type to use for this match condition.</p>                                                                                                                                                                                                                                                                                                                                                                                                                                                                                                                                                                                                                                                                                                                                                                                                                                                                                                                                                                                                                                                                                                                                                                                                                                                                                                                                                                                                                                                                                                                                                                                                                                                                                                                                                                                                                                                                                                                                                                                                                                                                           |

Table 7-8 HTTP and HTTPS Protocol Inspection Conditions and Options (continued)

| Condition         | Description                                                                                                                                                                                                                                                                                                                                                                                                                                                                                                                                                                                                                                                                                                                                                                                                                                                                                                                                                                                                                                |
|-------------------|--------------------------------------------------------------------------------------------------------------------------------------------------------------------------------------------------------------------------------------------------------------------------------------------------------------------------------------------------------------------------------------------------------------------------------------------------------------------------------------------------------------------------------------------------------------------------------------------------------------------------------------------------------------------------------------------------------------------------------------------------------------------------------------------------------------------------------------------------------------------------------------------------------------------------------------------------------------------------------------------------------------------------------------------|
| Port Misuse       | <p>Misuse of port 80 (or any other port running HTTP) to be used for application inspection decisions. Choose the application category to use for this match condition as follows:</p> <ul style="list-style-type: none"> <li>• <b>IM</b>—Instant messaging applications are to be checked.</li> <li>• <b>P2P</b>—Peer-to-peer applications are to be checked.</li> <li>• <b>Tunneling</b>—Tunneling applications are to be checked.</li> </ul>                                                                                                                                                                                                                                                                                                                                                                                                                                                                                                                                                                                            |
| Request Method    | <p>A request method is to be used for protocol inspection decisions. By default, ACEs allow all request and extension methods. This option allows you to configure protocol inspection decisions based on compliance to request methods defined in RFC 2616 and by HTTP extension methods.</p> <p>a. Choose the type of request method to use for this match condition:</p> <ul style="list-style-type: none"> <li>– <b>Ext</b>—An HTTP extension method is to be used.</li> </ul> <div style="border: 1px solid black; padding: 5px; margin: 5px 0;"> <p> <b>Note</b> The list of available HTTP extension methods from which to choose varies depending on the version of software installed in the ACE.</p> </div> <ul style="list-style-type: none"> <li>– <b>RFC</b>—The request method defined in RFC 2616 is to be used.</li> </ul> <p>b. In the Request Method field, choose the request method that is to be inspected.</p>                      |
| Strict HTTP       | Compliance with HTTP RFC 2616 to be used for application inspection decisions.                                                                                                                                                                                                                                                                                                                                                                                                                                                                                                                                                                                                                                                                                                                                                                                                                                                                                                                                                             |
| Transfer Encoding | <p>An HTTP transfer-encoding type to be used for application inspection decisions. The transfer-encoding general-header field indicates the type of transformation, if any, that has been applied to the HTTP message body to safely transfer it between the sender and the recipient.</p> <p>In the Transfer Encoding field, choose the type of encoding that is to be checked:</p> <ul style="list-style-type: none"> <li>• <b>Chunked</b>—The message body is transferred as a series of chunks.</li> <li>• <b>Compress</b>—The encoding format that is produced by the UNIX file compression program <i>compress</i>.</li> <li>• <b>Deflate</b>—The .zlib format that is defined in RFC 1950 in combination with the DEFLATE compression mechanism described in RFC 1951.</li> <li>• <b>Gzip</b>—The encoding format that is produced by the file compression program GZIP (GNU zip) as described in RFC 1952.</li> <li>• <b>Identity</b>—The default (identity) encoding which does not require the use of transformation.</li> </ul> |

Table 7-8 HTTP and HTTPS Protocol Inspection Conditions and Options (continued)

| Condition  | Description                                                                                                                                                                                                                                                                                                                                                                                                                                                                                                                                                                                                                                                                                                                                                                                                                                                                                                                                                                                                                                                                                                                                                                                                                                                                                                                                                                                                                                                                                                                                                                                                                                                                                                                                                       |
|------------|-------------------------------------------------------------------------------------------------------------------------------------------------------------------------------------------------------------------------------------------------------------------------------------------------------------------------------------------------------------------------------------------------------------------------------------------------------------------------------------------------------------------------------------------------------------------------------------------------------------------------------------------------------------------------------------------------------------------------------------------------------------------------------------------------------------------------------------------------------------------------------------------------------------------------------------------------------------------------------------------------------------------------------------------------------------------------------------------------------------------------------------------------------------------------------------------------------------------------------------------------------------------------------------------------------------------------------------------------------------------------------------------------------------------------------------------------------------------------------------------------------------------------------------------------------------------------------------------------------------------------------------------------------------------------------------------------------------------------------------------------------------------|
| URL        | <p>URL names to be used for application inspection decisions.</p> <p>In the URL field, enter a URL or a portion of a URL to match. Valid entries are URL strings from 1 to 255 alphanumeric characters and include only the portion of the URL following <code>www.hostname.domain</code>. For example, in the URL <code>www.anydomain.com/latest/whatsnew.html</code>, include only <code>/latest/whatsnew.html</code>.</p>                                                                                                                                                                                                                                                                                                                                                                                                                                                                                                                                                                                                                                                                                                                                                                                                                                                                                                                                                                                                                                                                                                                                                                                                                                                                                                                                      |
| URL Length | <p>URL length to be used for application inspection decisions.</p> <p><b>a.</b> In the URL Length Operator field, choose the operand to use to compare URL length:</p> <ul style="list-style-type: none"> <li>- <b>Equal To</b>—The URL length must equal the number in the URL Length Value field.</li> <li>- <b>Greater Than</b>—The URL length must be greater than the number in the URL Length Value field.</li> <li>- <b>Less Than</b>—The URL length must be less than the number in the URL Length Value field.</li> <li>- <b>Range</b>—The URL length must be within the range specified in the URL Length Lower Value field and the URL Length Higher Value field.</li> </ul> <p><b>b.</b> Enter values to apply for URL length comparison:</p> <ul style="list-style-type: none"> <li>- If you chose Equal To, Greater Than, or Less Than in the URL Length Operator field, the URL Length Value field appears. In the URL Length Value field, enter the value for comparison. Valid entries are from 1 to 65535 bytes.</li> <li>- If you chose Range in the URL Length Operator field, the URL Length Lower Value and the URL Length Higher Value fields appear: <ul style="list-style-type: none"> <li>1. In the URL Length Lower Value field, enter the lowest number of bytes to be used for this match condition. Valid entries are from 1 to 65535. The number in this field must be less than the number entered in the URL Length Higher Value field.</li> <li>2. In the URL Length Higher Value field, enter the highest number of bytes to be used for this match condition. Valid entries are from 1 to 65535. The number in this field must be greater than the number entered in the URL Length Lower Value field.</li> </ul> </li> </ul> |



**Table 7-9 SIP Protocol Inspection Match Criteria Configuration**

| Selection          | Action                                                                                                                                                                                                                                                                                                                                                                                                                                                                                                                                                                                                                                                                                                                                                                                                                                                                                                                                                                                                                                                                                                                                                                                                          |
|--------------------|-----------------------------------------------------------------------------------------------------------------------------------------------------------------------------------------------------------------------------------------------------------------------------------------------------------------------------------------------------------------------------------------------------------------------------------------------------------------------------------------------------------------------------------------------------------------------------------------------------------------------------------------------------------------------------------------------------------------------------------------------------------------------------------------------------------------------------------------------------------------------------------------------------------------------------------------------------------------------------------------------------------------------------------------------------------------------------------------------------------------------------------------------------------------------------------------------------------------|
| Existing class map | <p>a. Click <b>View</b> to review the match condition information for the selected class map.</p> <p>b. Do one of the following:</p> <ul style="list-style-type: none"> <li>– Click <b>Cancel</b> to continue without making changes and to return to the previous window.</li> <li>– Click <b>Edit</b> to modify the existing configuration.</li> <li>– Click <b>Duplicate</b> to create a new class map with the same attributes without affecting other virtual servers using the same class map.</li> </ul> <p>See the “<a href="#">Shared Objects and Virtual Servers</a>” section on page 7-9 for more information about modifying shared objects.</p> <p>c. In the Action field, choose the action that the virtual server is to perform on the traffic if it matches the specified match criteria:</p> <ul style="list-style-type: none"> <li>– <b>Drop</b>—The specified traffic is to be dropped by the virtual server.</li> <li>– <b>Permit</b>—The specified traffic is to be received by the virtual server.</li> <li>– <b>Reset</b>—The specified traffic is to be denied by the virtual server, which then sends a TCP reset message to the client or server to close the connection.</li> </ul> |
| *New*              | <p>a. In the Name field, specify a unique name for this class map.</p> <p>b. In the Conditions table, click <b>Add</b> to add a new set of conditions, or choose an existing entry, and click <b>Edit</b> to modify it. The Type field appears.</p> <p>c. In the Type field, choose the type of condition that is to be met for protocol inspection.</p> <p>d. Provide condition-specific criteria using the information in <a href="#">Table 7-10</a>.</p> <p>e. In the Action field, choose the action that the virtual server is to perform on the traffic if it matches the specified match criteria:</p> <ul style="list-style-type: none"> <li>– <b>Drop</b>—The specified traffic is to be dropped by the virtual server.</li> <li>– <b>Permit</b>—The specified traffic is to be received by the virtual server.</li> <li>– <b>Reset</b>—The specified traffic is to be denied by the virtual server, which then sends a TCP reset message to the client or server to close the connection.</li> </ul>                                                                                                                                                                                                  |
| *Inline Match*     | <p>a. In the Conditions Type field, choose the type of inline match condition that is to be met for protocol inspection.</p> <p><a href="#">Table 7-10</a> describes the types of conditions and their related configuration options.</p> <p>b. Provide condition-specific criteria using the information in <a href="#">Table 7-10</a>.</p> <p>c. In the Action field, choose the action that the virtual server is to perform on the traffic if it matches the specified match criteria:</p> <ul style="list-style-type: none"> <li>– <b>Drop</b>—The specified traffic is to be dropped by the virtual server.</li> <li>– <b>Permit</b>—The specified traffic is to be received by the virtual server.</li> <li>– <b>Reset</b>—The specified traffic is to be denied by the virtual server, which then sends a TCP reset message to the client or server to close the connection.</li> </ul>                                                                                                                                                                                                                                                                                                                 |

**Table 7-10 SIP Protocol Inspection Conditions and Options**

| Condition          | Description                                                                                                                                                                                                                                                                                                                                                                                                                                                                                                                                                                                                                                                                                                                    |
|--------------------|--------------------------------------------------------------------------------------------------------------------------------------------------------------------------------------------------------------------------------------------------------------------------------------------------------------------------------------------------------------------------------------------------------------------------------------------------------------------------------------------------------------------------------------------------------------------------------------------------------------------------------------------------------------------------------------------------------------------------------|
| Called Party       | <p>Destination or called party specified in the URI of the SIP To header used for SIP protocol inspection decisions.</p> <p>In the Called Party field, enter a regular expression that identifies the called party in the URI of the SIP To header for this match condition. Valid entries are unquoted text strings with no spaces and a maximum of 255 alphanumeric characters. The ACE supports regular expressions for matching string expressions. <a href="#">Table 14-33</a> lists the supported characters that you can use for matching string expressions.</p>                                                                                                                                                       |
| Calling Party      | <p>Source or caller specified in the URI of the SIP From header used for SIP protocol inspection decisions.</p> <p>In the Calling Party field, enter a regular expression that identifies the calling party in the URI of the SIP From header for this match condition. Valid entries are unquoted text strings with no spaces and a maximum of 255 alphanumeric characters. The ACE supports regular expressions for matching string expressions. <a href="#">Table 14-33</a> lists the supported characters that you can use for matching string expressions.</p>                                                                                                                                                            |
| IM Subscriber      | <p>IM (instant messaging) subscriber used for application inspection decisions.</p> <p>In the IP Subscriber field, enter a regular expression that identifies the IM subscriber for this match condition. Valid entries are unquoted text strings with no spaces and a maximum of 255 alphanumeric characters. The ACE supports regular expressions for matching string expressions. <a href="#">Table 14-33</a> lists the supported characters that you can use for matching string expressions.</p>                                                                                                                                                                                                                          |
| Message Path       | <p>SIP inspection that allows you to filter messages coming from or transiting through certain SIP proxy servers. The ACE maintains a list of the unauthorized SIP proxy IP addresses or URLs in the form of regular expressions and checks this list against the VIA header field in each SIP packet.</p> <p>In the Message Path field, enter a regular expression that identifies the SIP proxy server for this match condition. Valid entries are unquoted text strings with no spaces and a maximum of 255 alphanumeric characters. The ACE supports regular expressions for matching string expressions. <a href="#">Table 14-33</a> lists the supported characters that you can use for matching string expressions.</p> |
| SIP Content Length | <p>SIP message body content length used for SIP protocol inspection decisions.</p> <p>To specify SIP traffic based on SIP message body length:</p> <ol style="list-style-type: none"> <li>a. In the Content Operator field, confirm that Greater Than is selected.</li> <li>b. In the Content Length field, enter the maximum size of a SIP message body in bytes that the ACE is to allow without performing SIP protocol inspection. If a SIP message exceeds the specified value, the ACE performs SIP protocol inspection as defined in an associated policy map. Valid entries are from 0 to 65534 bytes.</li> </ol>                                                                                                      |
| SIP Content Type   | <p>Content type in the SIP message body used for SIP protocol inspection decisions.</p> <p>In the Content Type field, enter a regular expression that identifies the content type in the SIP message body to use for this match condition. Valid entries are unquoted text strings with no spaces and a maximum of 255 alphanumeric characters. The ACE supports regular expressions for matching string expressions. <a href="#">Table 14-33</a> lists the supported characters that you can use for matching string expressions.</p>                                                                                                                                                                                         |
| SIP Request Method | <p>SIP request method used for application inspection decisions.</p> <p>In the Request Method field, choose the request method that is to be inspected.</p>                                                                                                                                                                                                                                                                                                                                                                                                                                                                                                                                                                    |

**Table 7-10** SIP Protocol Inspection Conditions and Options (continued)

| Condition   | Description                                                                                                                                                                                                                                                                                                                                                                                                                                                                                                                                                                                                                                                                                                                                                                                                                                                                                                                                                                                                                                                                                                                                                                                                                              |
|-------------|------------------------------------------------------------------------------------------------------------------------------------------------------------------------------------------------------------------------------------------------------------------------------------------------------------------------------------------------------------------------------------------------------------------------------------------------------------------------------------------------------------------------------------------------------------------------------------------------------------------------------------------------------------------------------------------------------------------------------------------------------------------------------------------------------------------------------------------------------------------------------------------------------------------------------------------------------------------------------------------------------------------------------------------------------------------------------------------------------------------------------------------------------------------------------------------------------------------------------------------|
| Third Party | <p>Condition that indicates that the SIP is to allow users to register other users on their behalf by sending REGISTER messages with different values in the From and To header fields. This process can pose a security threat if the REGISTER message is actually a Deregister message. A malicious user could cause a DoS (denial-of-service) attack by deregistering all users on their behalf. To prevent this security threat, you can specify a list of privileged users who can register or unregister someone else on their behalf. The ACE maintains the list as a regex table. If you configure this policy, the ACE drops REGISTER messages with mismatched From and To headers and a From header value that does not match any of the privileged user IDs.</p> <p>In the Third Party Registration Entities field, enter a regular expression that identifies a privileged user who is authorized for third-party registrations. Valid entries are unquoted text strings with no spaces and a maximum of 255 alphanumeric characters. The ACE supports regular expressions for matching string expressions. <a href="#">Table 14-33</a> lists the supported characters that you can use for matching string expressions.</p> |
| URI Length  | <p>Condition that indicates that the ACE is to validate the length of SIP URIs or Tel URIs. A SIP URI is a user identifier that a calling party (source) uses to contact the called party (destination). A Tel URI is a telephone number that identifies the endpoint of a SIP connection. For more information about SIP URIs and Tel URIs, see RFC 2534 and RFC 3966, respectively.</p> <p>To filter SIP traffic based on URIs, do the following:</p> <ol style="list-style-type: none"> <li>a. In the URI Type field, choose the type of URI to be used: <ul style="list-style-type: none"> <li>– <b>SIP URI</b>—The calling party URI is to be used for this match condition.</li> <li>– <b>Tel URI</b>—A telephone number is to be used for this match condition.</li> </ul> </li> <li>b. In the URI Operator field, confirm that Greater Than is selected.</li> <li>c. In the URI Length field, enter the maximum length of the SIP URI or Tel URI in bytes. Valid entries are from 0 to 254 bytes.</li> </ol>                                                                                                                                                                                                                     |

**Step 6** Do one of the following:

- Click **Deploy Now** to deploy this configuration on the ACE and save your entries to the running-configuration and startup-configuration files.
- Click **Cancel** to exit this procedure without saving your entries.
- Click **Deploy Later** to save your entries and deploy the configuration at a later time.

**Related Topics**

- [Configuring Virtual Server Properties, page 7-11](#)
- [Configuring Virtual Server SSL Termination, page 7-17](#)
- [Configuring Virtual Server Layer 7 Load Balancing, page 7-30](#)
- [Managing Virtual Servers, page 7-66](#)

## Configuring Virtual Server Layer 7 Load Balancing

You can configure Layer 7 load balancing on a virtual server. In the Advanced View, Layer 7 load balancing is available for virtual servers configured with one of the following protocol combinations:

- TCP with Generic, FTP, HTTP, HTTPS, RDP, RTSP, or SIP
- UDP with Generic, DNS, RADIUS, or SIP

See the “[Configuring Virtual Server Properties](#)” section on page 7-11 for information about configuring these protocols.

[Table 7-2](#) identifies the protocols that are available for each type of ACE device.

### Assumption

Make sure that a virtual server has been configured with one of the following protocol combinations:

- TCP with Generic, FTP, HTTP, HTTPS, RDP, RTSP, or SIP
- UDP with Generic, DNS, RADIUS, or SIP

For more information, see the “[Configuring Virtual Server Properties](#)” section on page 7-11.

### Procedure

- 
- Step 1** Choose **Config > Devices > context > Load Balancing > Virtual Servers**.  
The Virtual Servers table appears.
- Step 2** In the Virtual Servers table, choose the virtual server that you want to configure for Layer 7 load balancing, and click **Edit**.  
The Virtual Server configuration window appears.
- Step 3** In the Virtual Server configuration window, click **L7 Load-Balancing**.  
The Layer 7 Load-Balancing Rule Match table appears.
- Step 4** In the Rule Match table, click **Add** to add a new match condition and action, or choose an existing match condition and action, and click **Edit** to modify it.  
The Rule Match configuration pane appears.
- Step 5** In the Rule Match field of the Rule Match configuration pane, choose an existing class map or **\*New\*** or **\*Inline Match\*** to configure new match criteria for Layer 7 load balancing, and do one of the following:
- If you chose an existing class map, click **View** to review, modify, or duplicate the existing configuration. See the “[Shared Objects and Virtual Servers](#)” section on page 7-9 for more information about modifying shared objects.
  - If you click **\*New\*** or **\*Inline Match\***, the Rule Match configuration pane appears.

**Step 6** Configure match criteria using the information in [Table 7-11](#).

**Table 7-11** Layer 7 Load-Balancing Match Criteria Configuration

| Selection          | Action                                                                                                                                                                                                                                                                                                                                                                                                                                                                                                                                                                                                                                                                                                                                                                                                                                                                                                                                                                                                                                                                                                                                                                                                                                                                                                                                                                                                                                                                  |
|--------------------|-------------------------------------------------------------------------------------------------------------------------------------------------------------------------------------------------------------------------------------------------------------------------------------------------------------------------------------------------------------------------------------------------------------------------------------------------------------------------------------------------------------------------------------------------------------------------------------------------------------------------------------------------------------------------------------------------------------------------------------------------------------------------------------------------------------------------------------------------------------------------------------------------------------------------------------------------------------------------------------------------------------------------------------------------------------------------------------------------------------------------------------------------------------------------------------------------------------------------------------------------------------------------------------------------------------------------------------------------------------------------------------------------------------------------------------------------------------------------|
| Existing class map | <p><b>a.</b> Click <b>View</b> to review the match condition information for the selected class map.</p> <p><b>b.</b> Do one of the following:</p> <ul style="list-style-type: none"> <li>– Click <b>Cancel</b> to continue without making changes and to return to the previous window.</li> <li>– Click <b>Edit</b> to modify the existing configuration.</li> <li>– Click <b>Duplicate</b> to create a new class map with the same attributes without affecting other virtual servers using the same class map.</li> </ul> <p>See the “<a href="#">Shared Objects and Virtual Servers</a>” section on page 7-9 for more information about modifying shared objects.</p>                                                                                                                                                                                                                                                                                                                                                                                                                                                                                                                                                                                                                                                                                                                                                                                              |
| *New*              | <p><b>a.</b> In the Name field, enter a unique name for this class map.</p> <p><b>b.</b> In the Match field, choose the method to be used to evaluate multiple match statements when multiple match conditions exist:</p> <ul style="list-style-type: none"> <li>– <b>match-any</b>—A match exists if at least one of the match conditions is satisfied.</li> <li>– <b>match-all</b>—A match exists only if all match conditions are satisfied.</li> </ul> <p><b>c.</b> In the Conditions table, click <b>Add</b> to add a new set of conditions, or choose an existing entry and click <b>Edit</b> to modify it.</p> <p><b>d.</b> In the Type field, choose the match condition and configure any of these protocol-specific options:</p> <ul style="list-style-type: none"> <li>– For Generic protocol options, see <a href="#">Table 14-9</a>.</li> <li>– For HTTP and HTTPS protocol options, see <a href="#">Table 7-12</a>.</li> <li>– For RADIUS protocol options, see <a href="#">Table 14-10</a>.</li> <li>– For RTSP protocol options, see <a href="#">Table 14-11</a>.</li> <li>– For SIP protocol options, see <a href="#">Table 14-12</a>.</li> </ul> <p><b>e.</b> Do one of the following:</p> <ul style="list-style-type: none"> <li>– Click <b>OK</b> to accept your entries and to return to the Conditions table.</li> <li>– Click <b>Cancel</b> to exit this procedure without saving your entries and to return to the Conditions table.</li> </ul> |
| *Inline Match*     | <p>In the Conditions Type field, choose the type of inline match condition and configure any protocol-specific options:</p> <ul style="list-style-type: none"> <li>• For Generic protocol options, see <a href="#">Table 14-9</a>.</li> <li>• For HTTP and HTTPS protocol options, see <a href="#">Table 7-12</a>.</li> <li>• For RADIUS protocol options, see <a href="#">Table 14-10</a>.</li> <li>• For RTSP protocol options, see <a href="#">Table 14-11</a>.</li> <li>• For SIP protocol options, see <a href="#">Table 14-12</a>.</li> </ul>                                                                                                                                                                                                                                                                                                                                                                                                                                                                                                                                                                                                                                                                                                                                                                                                                                                                                                                     |

**Table 7-12 Layer 7 HTTP/HTTPS Load-Balancing Conditions and Options**

| Match Condition | Action                                                                                                                                                                                                                                                                                                                                                                                                                                                                                                                                                                                                                                                                                                                                                                                                                                                                                                                                                                                                                                                                                                                                                                                                                                                                                                          |
|-----------------|-----------------------------------------------------------------------------------------------------------------------------------------------------------------------------------------------------------------------------------------------------------------------------------------------------------------------------------------------------------------------------------------------------------------------------------------------------------------------------------------------------------------------------------------------------------------------------------------------------------------------------------------------------------------------------------------------------------------------------------------------------------------------------------------------------------------------------------------------------------------------------------------------------------------------------------------------------------------------------------------------------------------------------------------------------------------------------------------------------------------------------------------------------------------------------------------------------------------------------------------------------------------------------------------------------------------|
| Class Map       | <p>Existing class map used for the match condition.</p> <p>In the Class Map field, choose the class map to be used.</p>                                                                                                                                                                                                                                                                                                                                                                                                                                                                                                                                                                                                                                                                                                                                                                                                                                                                                                                                                                                                                                                                                                                                                                                         |
| HTTP Content    | <p>Specific content contained within the HTTP entity-body used to establish a match condition.</p> <ol style="list-style-type: none"> <li data-bbox="391 468 1464 531">a. In the Content Expression field, enter the content that is to be matched. Valid entries are alphanumeric strings from 1 to 255 characters.</li> <li data-bbox="391 541 1464 636">b. In the Content Offset field, enter the number of bytes to be ignored starting with the first byte of the Message body, after the empty line (CR,LF,CR,LF) between the headers and the body of the message. Valid entries are from 1 to 255.</li> </ol>                                                                                                                                                                                                                                                                                                                                                                                                                                                                                                                                                                                                                                                                                            |
| HTTP Cookie     | <p>HTTP cookies used for the match condition.</p> <ol style="list-style-type: none"> <li data-bbox="391 699 1464 762">a. In the Cookie Name field, enter a unique cookie name. Valid entries are unquoted text strings with no spaces and a maximum of 64 alphanumeric characters.</li> <li data-bbox="391 772 1464 898">b. In the Cookie Value field, enter a unique cookie value expression. Valid entries are unquoted text strings with no spaces and a maximum of 255 alphanumeric characters. The ACE supports regular expressions for matching string expressions. <a href="#">Table 14-33</a> lists the supported characters that you can use for matching string expressions.</li> <li data-bbox="391 909 1464 1035">c. Check the Secondary Cookie Matching check box to indicate that the ACE is to use both the cookie name and the cookie value to satisfy this match condition. Clear this check box to indicate that the ACE is to use either the cookie name or the cookie value to satisfy this match condition.</li> </ol>                                                                                                                                                                                                                                                                     |
| HTTP Header     | <p>HTTP header and corresponding value used to establish match conditions.</p> <ol style="list-style-type: none"> <li data-bbox="391 1098 1464 1318">a. In the Header Name field, specify the header in one of the following ways: <ul style="list-style-type: none"> <li data-bbox="443 1140 1464 1245">– To specify an HTTP header that is not one of the standard HTTP headers, click the first radio button and enter the HTTP header name in the Header Name field. Enter an unquoted text string with no spaces and a maximum of 64 characters.</li> <li data-bbox="443 1255 1464 1318">– To specify one of the standard HTTP headers, click the second radio button and choose the desired HTTP header from the list.</li> </ul> </li> <li data-bbox="391 1329 1464 1518">b. In the Header Value field, enter the header-value expression string to compare against the value in the specified field in the HTTP header. Valid entries are text strings with a maximum of 255 alphanumeric characters. The ACE supports regular expressions for matching. Header expressions allow spaces, provided that the spaces are escaped or quoted. All headers in the header map must be matched. <a href="#">Table 14-33</a> lists the supported characters that you can use in regular expressions.</li> </ol> |

**Table 7-12** Layer 7 HTTP/HTTPS Load-Balancing Conditions and Options (continued)

| Match Condition | Action                                                                                                                                                                                                                                                                                                                                                                                                                                                                                                                                                                                                                                                                                                                                                                                                                                                                                                                                                                                                                                                                                                                                                                                                                                      |
|-----------------|---------------------------------------------------------------------------------------------------------------------------------------------------------------------------------------------------------------------------------------------------------------------------------------------------------------------------------------------------------------------------------------------------------------------------------------------------------------------------------------------------------------------------------------------------------------------------------------------------------------------------------------------------------------------------------------------------------------------------------------------------------------------------------------------------------------------------------------------------------------------------------------------------------------------------------------------------------------------------------------------------------------------------------------------------------------------------------------------------------------------------------------------------------------------------------------------------------------------------------------------|
| HTTP URL        | <p>Condition that indicates that the ACE is to perform regular expression matching against the received packet data from a particular connection based on the HTTP URL string.</p> <ol style="list-style-type: none"> <li>In the URL Expression field, enter a URL, or portion of a URL, to match. Valid entries are URL strings from 1 to 255 alphanumeric characters. Include only the portion of the URL following www.hostname.domain in the match statement. For example, in the URL www.anydomain.com/latest/whatsnew.html, include only /latest/whatsnew.html. To match the www.anydomain.com portion, the URL string can take the form of a URL regular expression. The ACE supports regular expressions for matching URL strings. <a href="#">Table 14-33</a> lists the supported characters that you can use in regular expressions.</li> <li>In the Method Expression field, enter the HTTP method to match. Valid entries are unquoted text strings with no spaces and a maximum of 15 alphanumeric characters. The method can either be one of the standard HTTP 1.1 method names (OPTIONS, GET, HEAD, POST, PUT, DELETE, TRACE, or CONNECT) or a text string that must be matched exactly (for example, CORVETTE).</li> </ol> |
| Source Address  | <p>Client source IP address used for the match condition.</p> <ol style="list-style-type: none"> <li>In the Source Address field, enter the source IP address of the client. Enter the IP address in dotted-decimal notation (for example, 192.168.11.2).</li> <li>In the Source Netmask field, choose the subnet mask to apply to the source IP address.</li> </ol>                                                                                                                                                                                                                                                                                                                                                                                                                                                                                                                                                                                                                                                                                                                                                                                                                                                                        |

- Step 7** In the Primary Action field, choose the action that the virtual server is to perform on the traffic if it matches the specified match criteria:
- **Drop**—Client requests for content are to be discarded when match conditions are met. Continue with [Step 12](#).
  - **Forward**—Client requests for content are to be forwarded without performing load balancing on the requests when match conditions are met. Continue with [Step 12](#).
  - **Load Balance**—Client requests for content are to be directed to a server farm when match conditions are met. Continue with [Step 9](#).
  - **Sticky**—Client requests for content are to be handled by a sticky group when match conditions are met. Continue with [Step 10](#).
- Step 8** (Optional) From the HTTP Header Modify Action List drop-down list, choose an existing Action List or choose **New** to display the Action List configuration table and create a new one. For more information, see the “[Configuring an HTTP Header Modify Action List](#)” section on page 14-85.
- Step 9** (Optional) If you chose Load Balance as the primary action, do the following:
- In the Server Farm field, choose the primary server farm to use for load balancing, or choose **\*New\*** to configure a new server farm (see [Table 7-13](#)).
- If you chose an existing object in this field, you can view, modify, or duplicate the selected object’s existing configuration. See the “[Shared Objects and Virtual Servers](#)” section on page 7-9 for more information about modifying shared objects in virtual servers.



**Note** To display statistics and status information for an existing server farm, choose a server farm in the list, and click **Details**. ANM accesses the **show serverfarm name detail** CLI command to display detailed server farm information. See the “[Displaying Server Farm Statistics and Status Information](#)” section on page 8-48.

- b. In the Backup Server Farm field, choose the server farm to act as the backup server farm for load balancing if the primary server farm is unavailable, or choose **\*New\*** to configure a new backup server farm (see [Table 7-13](#)).



**Note** Fields and information related to IPv6 require ACE module and ACE appliance software Version A5(1.0) or later.

If you chose an existing object in this field, you can view, modify, or duplicate the selected object’s existing configuration. See the “[Shared Objects and Virtual Servers](#)” section on page 7-9 for more information about modifying shared objects in virtual servers.

**Table 7-13** *New Server Farm Attributes*

| Field       | Description                                                                                                                                                                                                                                                                                                                                                                                                                                                                                                                                                                                                                                                                                                                                                                                                                                                                                                                                                                                                                                                                                                                                                                                                                                                                                                                                           |
|-------------|-------------------------------------------------------------------------------------------------------------------------------------------------------------------------------------------------------------------------------------------------------------------------------------------------------------------------------------------------------------------------------------------------------------------------------------------------------------------------------------------------------------------------------------------------------------------------------------------------------------------------------------------------------------------------------------------------------------------------------------------------------------------------------------------------------------------------------------------------------------------------------------------------------------------------------------------------------------------------------------------------------------------------------------------------------------------------------------------------------------------------------------------------------------------------------------------------------------------------------------------------------------------------------------------------------------------------------------------------------|
| Name        | Unique name for the server farm. Valid entries are unquoted text strings with no spaces and a maximum of 64 characters.                                                                                                                                                                                                                                                                                                                                                                                                                                                                                                                                                                                                                                                                                                                                                                                                                                                                                                                                                                                                                                                                                                                                                                                                                               |
| Type        | Type of server farm: <ul style="list-style-type: none"> <li>• <b>Host</b>—A typical server farm that consists of real servers that provide content and services to clients. By default, if you configure a backup server farm and all real servers in the primary server farm go down, the primary server farm fails over to the backup server farm. Use the following options to specify thresholds for failover and returning to service. <ol style="list-style-type: none"> <li>1. In the Partial-Threshold Percentage field, enter the minimum percentage of real servers in the primary server farm that must remain active for the server farm to stay up. If the percentage of active real servers falls below this threshold, the ACE takes the server farm out of service. Valid entries are from 0 to 99.</li> <li>2. In the Back Inservice field, enter the percentage of real servers in the primary server farm that must be active again for the ACE to place the server farm back into service. Valid entries are from 0 to 99. The value in this field should be larger than the value in the Partial Threshold Percentage field.</li> </ol> </li> <li>• <b>Redirect</b>—A server farm that consists only of real servers that redirect client requests to alternate locations specified in the real server configuration.</li> </ul> |
| Fail Action | Action that the ACE takes if any real server in the server farm fails: <ul style="list-style-type: none"> <li>• <b>N/A</b>—Indicates that the ACE is to take no action if any server in the server farm fails.</li> <li>• <b>Purge</b>—Indicates that the ACE is to remove connections to a real server if that real server in the server farm fails. The ACE sends a reset command to both the client and the server that failed.</li> <li>• <b>Reassign</b>—Indicates that the ACE reassign the existing server connections to the backup real server (if configured) if the real server fails after you enter this command. If a backup real server has not been configured for the failing server, this selection leaves the existing connections untouched in the failing real server.</li> </ul>                                                                                                                                                                                                                                                                                                                                                                                                                                                                                                                                                |



Table 7-13 New Server Farm Attributes (continued)

| Field                            | Description                                                                                                                                                                                                                                                                                                                                                                                                                                                                                                                                                                                                                                                                                                                                                                                                                                                                                                                                                                                                                                                                                                                                                                                                                                                                                                                                                                                                                                                                                                                                                                                                                                                                                                                                                                                                                                                                                                                                                                                                                                                                                                                                                                                                                                                                                                                                                                                                                                                                                                                                                                                                                                                                                                                                                                                                                                                                                                                                                                                                                                                                                                                                                                                                                                                                                                                                                                                                                                                                                                                                                                                                                                                                                                                          |
|----------------------------------|--------------------------------------------------------------------------------------------------------------------------------------------------------------------------------------------------------------------------------------------------------------------------------------------------------------------------------------------------------------------------------------------------------------------------------------------------------------------------------------------------------------------------------------------------------------------------------------------------------------------------------------------------------------------------------------------------------------------------------------------------------------------------------------------------------------------------------------------------------------------------------------------------------------------------------------------------------------------------------------------------------------------------------------------------------------------------------------------------------------------------------------------------------------------------------------------------------------------------------------------------------------------------------------------------------------------------------------------------------------------------------------------------------------------------------------------------------------------------------------------------------------------------------------------------------------------------------------------------------------------------------------------------------------------------------------------------------------------------------------------------------------------------------------------------------------------------------------------------------------------------------------------------------------------------------------------------------------------------------------------------------------------------------------------------------------------------------------------------------------------------------------------------------------------------------------------------------------------------------------------------------------------------------------------------------------------------------------------------------------------------------------------------------------------------------------------------------------------------------------------------------------------------------------------------------------------------------------------------------------------------------------------------------------------------------------------------------------------------------------------------------------------------------------------------------------------------------------------------------------------------------------------------------------------------------------------------------------------------------------------------------------------------------------------------------------------------------------------------------------------------------------------------------------------------------------------------------------------------------------------------------------------------------------------------------------------------------------------------------------------------------------------------------------------------------------------------------------------------------------------------------------------------------------------------------------------------------------------------------------------------------------------------------------------------------------------------------------------------------------|
| Failaction Reassign Across Vlans | <p>Option that is available only for the ACE module A2(3.0), ACE appliance A4(1.0), and later releases of either device type. This field appears only when the L7 Load-Balancing Action parameters are set as follows: Primary Action: LoadBalance; ServerFarm: New; Fail Action: Reassign.</p> <p>Check the check box to specify that the ACE reassigns the existing server connections to the backup real server on a different VLAN interface (commonly referred to as a bypass VLAN) if the real server fails. If a backup real server has not been configured for the failing server, this option has no effect and leaves the existing connections untouched in the failing real server.</p> <p>Note the following configuration requirements and restrictions when you enable this option:</p> <ul style="list-style-type: none"> <li>• Enable the Transparent option (see the next Field) to instruct the ACE not to use NAT to translate the ACE VIP address to the server IP address. The Failaction Reassign Across Vlans option is intended for use in stateful firewall load balancing (FWLB) on your ACE, where the destination IP address for the connection coming in to the ACE is for the end-point real server, and the ACE reassigns the connection so that it is transmitted through a different next hop.</li> <li>• Enable the MAC Sticky option on all server-side interfaces to ensure that packets that are going to and coming from the same server in a flow will traverse the same firewalls or stateful devices (see the “<a href="#">Configuring Virtual Context VLAN Interfaces</a>” section on page 12-6).</li> <li>• Configure the Predictor Hash Address option. See <a href="#">Table 7-14</a> for the supported predictor methods and configurable attributes for each predictor method.</li> <li>• You must configure identical policies on the primary interface and the backup-server interface. The backup interface must have the same feature configurations as the primary interface.</li> <li>• If you configure a policy on the backup-server interface that is different from the policies on the primary-server interface, that policy will be effective only for new connections. The reassigned connection will always have only the primary-server interface policies.</li> <li>• Interface-specific features (for example, NAT, application protocol inspection, outbound ACLs, or SYN cookie) are not supported.</li> <li>• You cannot reassign connections to the failed real server after it comes back up. This restriction also applies to same-VLAN backup servers.</li> <li>• Real servers must be directly connected to the ACE. This requirement also applies to same-VLAN backup server.</li> <li>• You must disable sequence number randomization on the firewall (see the “<a href="#">Configuring Connection Parameter Maps</a>” section on page 10-3).</li> <li>• Probe configurations should be similar on both ACEs and the interval values should be low. For example, if you configure a high interval value on ACE-1 and a low interval value on ACE-2, the reassigned connections may become stuck because of the probe configuration mismatch. ACE-2 with the low interval value will detect the primary server failure first and will reassign all its incoming connections to the backup-server interface VLAN. ACE-1 with the high interval value may not detect the failure before the primary server comes back up and will still point to the primary server.</li> </ul> <p>To minimize packet loss, we recommend the following probe parameter values on both ACEs: Interval: 2, Faildetect: 2, Passdetect interval: 2, and Passdetect count: 5.</p> |

Table 7-13 New Server Farm Attributes (continued)

| Field                    | Description                                                                                                                                                                                                                                                                                                                                                                                                                                                                                                                                                                                                                                                                                                                                                                                                                                                                                                                                                                                                                                                                                                                                                                                                                                                                                                                                                                                                                                    |
|--------------------------|------------------------------------------------------------------------------------------------------------------------------------------------------------------------------------------------------------------------------------------------------------------------------------------------------------------------------------------------------------------------------------------------------------------------------------------------------------------------------------------------------------------------------------------------------------------------------------------------------------------------------------------------------------------------------------------------------------------------------------------------------------------------------------------------------------------------------------------------------------------------------------------------------------------------------------------------------------------------------------------------------------------------------------------------------------------------------------------------------------------------------------------------------------------------------------------------------------------------------------------------------------------------------------------------------------------------------------------------------------------------------------------------------------------------------------------------|
| Transparent              | <p>Field that appears only for real servers identified as host servers.</p> <p>Specify whether network address translation from the VIP address to the server IP is to occur. Check the check box to specify that network address translation from the VIP address to the server IP address is to occur. Uncheck the check box to specify that network address translation from the VIP address to the server IP address is not to occur.</p>                                                                                                                                                                                                                                                                                                                                                                                                                                                                                                                                                                                                                                                                                                                                                                                                                                                                                                                                                                                                  |
| Dynamic Workload Scaling | <p>Option that is available only with ACE software Version A4(2.0) or later release on either device type (appliance or module). Field that appears only for host server farms.</p> <p>Allows the ACE to burst traffic to remote VMs when the average CPU usage, memory usage, or both of the local VMs has reached it's specified maximum threshold value. The ACE stops bursting traffic to the remote VMs when the average CPU and/or memory usage of the local VMs has dropped to it's specified minimum threshold value. This option requires that you have the ACE configured for Dynamic Workload Scaling using a Nexus 7000, VM Controller, and VM probe (see the <a href="#">“Configuring Dynamic Workload Scaling”</a> section on page 8-26).</p> <p>Click one of the following radio button options:</p> <ul style="list-style-type: none"> <li>• N/A—Not applicable (default).</li> <li>• Local—The ACE can use the VM Controller local VMs only for load balancing (bursting is not allowed).</li> <li>• Burst—Enables the ACE to burst traffic to a remote VMs when needed.</li> </ul> <p>When you choose Burst, the VM Probe Name field displays along with a list of available VM probes. Choose an available VM probe or click <b>Add</b> to display the Health Monitoring popup window and create a new VM probe or edit an existing one (see the <a href="#">“Configuring Health Monitoring”</a> section on page 8-49).</p> |
| Fail-On-All              | <p>Field that appears for host server farms only.</p> <p>By default, real servers that you configure in a server farm inherit the probes that you configure directly on that server farm. When you configure multiple probes on a server farm, the real servers in the server farm use an OR logic with respect to the probes, which means that if one of the probes configured on the server farm fails, all the real servers in that server farm fail and enter the PROBE-FAILED state.</p> <p>With AND logic, if one server farm probe fails, the real servers in the server farm remain in the OPERATIONAL state. If all the probes associated with the server farm fail, then all the real servers in that server farm fail and enter the PROBE-FAILED state. You can also configure AND logic for probes that you configure directly on real servers in a server farm. For more information, see the command in server farm host real server configuration mode.</p> <p>Check this check box to configure the real servers in a server farm to use AND logic with respect to multiple server farm probes.</p> <p>The Fail On All function is applicable to all probe types.</p>                                                                                                                                                                                                                                                          |

Table 7-13 New Server Farm Attributes (continued)

| Field                              | Description                                                                                                                                                                                                                                                                                                                                                                                                                                                                                                                                                                                                                                                                                                                                                                                                                                                                                                                                                                                                                                                                                                                                                                                                                                                                                                                                                                                                                                                                                                                                                                                                                                                                                         |
|------------------------------------|-----------------------------------------------------------------------------------------------------------------------------------------------------------------------------------------------------------------------------------------------------------------------------------------------------------------------------------------------------------------------------------------------------------------------------------------------------------------------------------------------------------------------------------------------------------------------------------------------------------------------------------------------------------------------------------------------------------------------------------------------------------------------------------------------------------------------------------------------------------------------------------------------------------------------------------------------------------------------------------------------------------------------------------------------------------------------------------------------------------------------------------------------------------------------------------------------------------------------------------------------------------------------------------------------------------------------------------------------------------------------------------------------------------------------------------------------------------------------------------------------------------------------------------------------------------------------------------------------------------------------------------------------------------------------------------------------------|
| Inband-Health Check                | <p>Option that is available only for the ACE module A4(1.0), ACE appliance A4(1.0), and later releases of either device type. Field that appears only for host server farms.</p> <p>By default, the ACE monitors the health of all real servers in a configuration through the use of ARPs and health probes. However, there is latency period between when the real server goes down and when the ACE becomes aware of the state. The inband health monitoring feature allows the ACE to monitor the health of the real servers in the server farm through the following connection failures:</p> <ul style="list-style-type: none"> <li>• For TCP, resets (RSTs) from the server or SYN timeouts.</li> <li>• For UDP, ICMP Host, Network, Port, Protocol, and Source Route unreachable messages.</li> </ul> <p>When you configure the failure-count threshold and the number of these failures exceeds the threshold within the reset-time interval, the ACE immediately marks the server as failed, takes it out of service, and removes it from load balancing. The server is not considered for load balancing until the optional resume-service interval expires.</p> <p>The Inband-Health Check attributes are as follows:</p> <ul style="list-style-type: none"> <li>• Count—Tracks the total number of TCP or UDP failures, and increments the counters.</li> <li>• Log—Logs a syslog error message when the number of events reaches the threshold value that you set for the Connection Failure Threshold Count attribute.</li> <li>• Remove—Logs a syslog error message when the number of events reaches the configured threshold and removes the real server from service.</li> </ul> |
| Connection Failure Threshold Count | <p>This field appears only when the Inband-Health Check is set to Log or Remove.</p> <p>Enter the maximum number of connection failures that a real server can exhibit in the reset-time interval before ACE marks the real server as failed. Valid entries are as follows:</p> <ul style="list-style-type: none"> <li>• ACE appliance—Integers from 1 to 4294967295</li> <li>• ACE module—Integers from 4 to 4294967295</li> </ul>                                                                                                                                                                                                                                                                                                                                                                                                                                                                                                                                                                                                                                                                                                                                                                                                                                                                                                                                                                                                                                                                                                                                                                                                                                                                 |
| Reset Timeout (Milliseconds)       | <p>This field appears only when the Inband-Health Check is set to Log or Remove.</p> <p>Enter the number of milliseconds for the reset-time interval. Valid entries are integers from 100 to 300000. The default interval is 100.</p> <p>This interval starts when the ACE detects a connection failure. If the connection failure threshold is reached during this interval, the ACE generates a syslog message. If you configure the Remove attribute, the ACE also removes the real server from service.</p> <p>Changing the setting of this option affects the behavior of the real server, as follows:</p> <ul style="list-style-type: none"> <li>• When the real server is in the OPERATIONAL state, even if several connection failures have occurred, the new reset-time interval takes effect the next time that a connection error occurs.</li> <li>• When the real server in the INBAND-HM-FAILED state, the new reset-time interval takes effect the next time that a connection error occurs after the server transitions to the OPERATIONAL state.</li> </ul>                                                                                                                                                                                                                                                                                                                                                                                                                                                                                                                                                                                                                         |

**Table 7-13** *New Server Farm Attributes (continued)*

| Field                    | Description                                                                                                                                                                                                                                                                                                                                                                                                                                                                                                                                                                                                                                                                                                                                                                                                                                                                                                                                                                                                                                                                                                                                                                                                                                                                                                                                                                                                                                                                                                                                                                                                                                                                                                                                                                                                                                                                                                                                                                          |
|--------------------------|--------------------------------------------------------------------------------------------------------------------------------------------------------------------------------------------------------------------------------------------------------------------------------------------------------------------------------------------------------------------------------------------------------------------------------------------------------------------------------------------------------------------------------------------------------------------------------------------------------------------------------------------------------------------------------------------------------------------------------------------------------------------------------------------------------------------------------------------------------------------------------------------------------------------------------------------------------------------------------------------------------------------------------------------------------------------------------------------------------------------------------------------------------------------------------------------------------------------------------------------------------------------------------------------------------------------------------------------------------------------------------------------------------------------------------------------------------------------------------------------------------------------------------------------------------------------------------------------------------------------------------------------------------------------------------------------------------------------------------------------------------------------------------------------------------------------------------------------------------------------------------------------------------------------------------------------------------------------------------------|
| Resume Service (Seconds) | <p>Field that appears only when the Inband-Health Check is set to Remove.</p> <p>Enter the number of seconds after a server has been marked as failed to reconsider it for sending live connections. Valid entries are integers from 30 to 3600. The default setting is 0. The setting of this option affects the behavior of the real server in the inband failed state, as follows:</p> <ul style="list-style-type: none"> <li>• When this field is not configured and has the default setting of 0, the real server remains in the failed state until you manually suspend and then reactivate it.</li> <li>• When this field is not configured and has the default setting of 0 and then you configure this option with an integer between 30 and 3,600, the failed real server immediately transitions to the Operational state.</li> <li>• When you configure this field and then increase the value, the real server remains in the failed state for the duration of the previously-configured value. The new value takes effect the next time the real server transitions to the failed state.</li> <li>• When you configure this field and then decrease the value, the failed real server immediately transitions to the Operational state.</li> <li>• When you configure this field with an integer between 30 and 3,600 and then reset it to the default of 0, the real server remains in the failed state for the duration of the previously-configured value. The default setting takes effect the next time the real server transitions to the failed state. Then the real server remains in the failed state until you manually suspend and then reactivate it.</li> <li>• When you change this field within the reset-time interval the real server in the OPERATIONAL with several connection failures, the new threshold interval takes effect the next time that a connection error occurs, even if it occurs within the current reset-time interval.</li> </ul> |
| Predictor                | <p>Method for selecting the next server in the server farm to respond to client requests. Round Robin is the default predictor method for a server farm.</p> <p>See <a href="#">Table 7-14</a> for the supported predictor methods and configurable attributes for each predictor method.</p>                                                                                                                                                                                                                                                                                                                                                                                                                                                                                                                                                                                                                                                                                                                                                                                                                                                                                                                                                                                                                                                                                                                                                                                                                                                                                                                                                                                                                                                                                                                                                                                                                                                                                        |

Table 7-13 New Server Farm Attributes (continued)



| Field  | Description                                                                                                                                                                                                                                                                                                                                                                                                                                                                                                                                                                                                                                                                                                                                                                                                                                                                                                                                                                                                                                                                                                                                                                                                                                                                                                                                                                                                                                                                                                                                                                                                                                                                                                                                                                                                                                                                                                                                                                                                                                                                                                                                                                                                                                                                                                                                                                                                                                                                                                                                                                                                                                                                                                                                                                                                                                                                                                                                                                                                                                                                                                                                                                                                                                                                                                                                                                                                                                                                                                                                                                                                                                                                                                                                                                                                                                                                                                                                            |
|--------|--------------------------------------------------------------------------------------------------------------------------------------------------------------------------------------------------------------------------------------------------------------------------------------------------------------------------------------------------------------------------------------------------------------------------------------------------------------------------------------------------------------------------------------------------------------------------------------------------------------------------------------------------------------------------------------------------------------------------------------------------------------------------------------------------------------------------------------------------------------------------------------------------------------------------------------------------------------------------------------------------------------------------------------------------------------------------------------------------------------------------------------------------------------------------------------------------------------------------------------------------------------------------------------------------------------------------------------------------------------------------------------------------------------------------------------------------------------------------------------------------------------------------------------------------------------------------------------------------------------------------------------------------------------------------------------------------------------------------------------------------------------------------------------------------------------------------------------------------------------------------------------------------------------------------------------------------------------------------------------------------------------------------------------------------------------------------------------------------------------------------------------------------------------------------------------------------------------------------------------------------------------------------------------------------------------------------------------------------------------------------------------------------------------------------------------------------------------------------------------------------------------------------------------------------------------------------------------------------------------------------------------------------------------------------------------------------------------------------------------------------------------------------------------------------------------------------------------------------------------------------------------------------------------------------------------------------------------------------------------------------------------------------------------------------------------------------------------------------------------------------------------------------------------------------------------------------------------------------------------------------------------------------------------------------------------------------------------------------------------------------------------------------------------------------------------------------------------------------------------------------------------------------------------------------------------------------------------------------------------------------------------------------------------------------------------------------------------------------------------------------------------------------------------------------------------------------------------------------------------------------------------------------------------------------------------------------------|
| Probes | <p>Health monitoring probes to use:</p> <ul style="list-style-type: none"> <li>To include a probe that you want to use for health monitoring, choose it in the Available list, and click <b>Add</b>. The probe appears in the Selected list.</li> </ul> <p>The redirect real server probe list contains only configured probes of the type Is Routed, which means that the ACE routes the probe address according to the ACE internal routing table (see the <a href="#">“Configuring Health Monitoring”</a> section on page 8-49).</p> <hr/> <p> <b>Note</b> You can associate both IPv6 and IPv4 probes to a server farm. IPv6 requires ACE module and ACE appliance software Version A5(1.0) or later.</p> <hr/> <p> <b>Note</b> The list of available probes does not include VM health monitoring probes. To choose a VM probe for monitoring local VM usage, see the <a href="#">Dynamic Workload Scaling</a> field.</p> <hr/> <ul style="list-style-type: none"> <li>To remove a probe that you do not want to use for health monitoring, choose it in the Selected list, and click <b>Remove</b>. The probe appears in the Available list.</li> <li>To specify a sequence for probe use, choose probes in the Selected list, and click <b>Up</b> or <b>Down</b> until you have the desired sequence.</li> <li>To view the configuration for an existing probe, choose a probe in the list on the right, and click <b>View</b> to review its configuration.</li> <li>To display statistics and status information for an existing probe, choose a probe in the list on the right, and click <b>Details</b>. ANM accesses the <b>show probe name detail</b> CLI command to display detailed probe information. See the <a href="#">“Displaying Health Monitoring Statistics and Status Information”</a> section on page 8-77.</li> </ul> <p>To add a new probe, click <b>Create</b>. See the <a href="#">“Configuring Health Monitoring for Real Servers”</a> section on page 8-51 for details on adding a new health monitoring probe and defining attributes for the specific probe type. In addition to the probe attributes that you set as described in the <a href="#">“Configuring Health Monitoring for Real Servers”</a> section on page 8-51, set the following probe configuration parameters in the Probes section under Server Farm as described as follows:</p> <ul style="list-style-type: none"> <li>Expect Addresses—To configure expect addresses for a DNS probe, in the IPv4/IPv6 Address field, enter the IP address that the ACE is to expect as a server response to a DNS request. You can enter multiple addresses in this field; however, you cannot mix IPv4 and IPv6 addresses.</li> </ul> <hr/> <p> <b>Note</b> IPv6 requires ACE module and ACE appliance software Version A5(1.0) or later.</p> <hr/> <ul style="list-style-type: none"> <li>Probe Headers—To configure probe headers for either an HTTP or HTTPS probe, in the Probe Headers field enter the name of the HTTP header and the value to be matched using the format <i>header_name=header_value</i> where: <ul style="list-style-type: none"> <li><i>header_name</i> represents the HTTP header name the probe is to use. Valid entries are unquoted text strings with no spaces and a maximum of 64 alphanumeric characters. You can specify predefined header or any custom header name provided that it does not exceed the maximum length limit.</li> <li><i>header_value</i> represents the string to assign to the header field. Valid entries are text strings with a maximum of 255 characters. If the string includes spaces, enclose the string with quotes.</li> </ul> </li> </ul> |

Table 7-13 New Server Farm Attributes (continued)

| Field                 | Description                                                                                                                                                                                                                                                                                                                                                                                                                                                                                                                                                                                                                                                                                                                                                                                                                                                                                                                                                                                                                                                                                                                                                                                                                                                                                                                                                                                                           |
|-----------------------|-----------------------------------------------------------------------------------------------------------------------------------------------------------------------------------------------------------------------------------------------------------------------------------------------------------------------------------------------------------------------------------------------------------------------------------------------------------------------------------------------------------------------------------------------------------------------------------------------------------------------------------------------------------------------------------------------------------------------------------------------------------------------------------------------------------------------------------------------------------------------------------------------------------------------------------------------------------------------------------------------------------------------------------------------------------------------------------------------------------------------------------------------------------------------------------------------------------------------------------------------------------------------------------------------------------------------------------------------------------------------------------------------------------------------|
| Probes<br>(continued) | <ul style="list-style-type: none"> <li>• Probe Expect Status—To configure probe expect status for an FTP, HTTP, HTTPS, RTSP, SIP-TCP, SIP-UDP, or SMTP probe, in the Probe Expect Status field enter the following information:               <ul style="list-style-type: none"> <li>• To configure a single expect status code, enter the minimum expect status code for this probe followed by the same expect status code that you entered as the minimum. Valid entries are from 0 to 999.</li> <li>• To configure a range of expect status codes, enter the lower limit of the range of status codes followed by the upper limit of the range of status codes. The maximum expect status code must be greater than or equal to the value specified for the minimum expect status code. Valid entries are from 0 to 999.</li> </ul> </li> <li>• SNMP OID Table—To configure the SNMP OID for an SNMP probe, see the <a href="#">“Configuring an OID for SNMP Probes”</a> section on page 8-76.</li> </ul> <p>After you add a probe, you can modify the attributes for a health probe from the Health Monitoring table (Config &gt; Virtual Contexts &gt; <i>context</i> &gt; Load Balancing &gt; Health Monitoring) as described in the <a href="#">“Configuring Health Monitoring for Real Servers”</a> section on page 8-51. You can also delete an existing health probe from the Health Monitoring table.</p> |

Table 7-13 New Server Farm Attributes (continued)

| Field        | Description                                                                                                                                                                                                                                                                                                                                                                                                                                                                                                                                                                                                                                                                                                                                                                                                                                                                                                                                                                                                                                                                                                                                                                                                                                                                                                                                                                                                                                                                                                                                                                                                                                                                                                                                                                                                                                                                                                                                                                                                                                                                                                                                                                                                                                                                                                                                                                                                                                                                                                                                                                                                                                                                                                                                                                                                                                                                                                                                                                                                                                                                                                                                                                                                                                                                                                                                                                                                                                                                                                                                                                                                                                                                                                                                                                                                                                                                          |
|--------------|--------------------------------------------------------------------------------------------------------------------------------------------------------------------------------------------------------------------------------------------------------------------------------------------------------------------------------------------------------------------------------------------------------------------------------------------------------------------------------------------------------------------------------------------------------------------------------------------------------------------------------------------------------------------------------------------------------------------------------------------------------------------------------------------------------------------------------------------------------------------------------------------------------------------------------------------------------------------------------------------------------------------------------------------------------------------------------------------------------------------------------------------------------------------------------------------------------------------------------------------------------------------------------------------------------------------------------------------------------------------------------------------------------------------------------------------------------------------------------------------------------------------------------------------------------------------------------------------------------------------------------------------------------------------------------------------------------------------------------------------------------------------------------------------------------------------------------------------------------------------------------------------------------------------------------------------------------------------------------------------------------------------------------------------------------------------------------------------------------------------------------------------------------------------------------------------------------------------------------------------------------------------------------------------------------------------------------------------------------------------------------------------------------------------------------------------------------------------------------------------------------------------------------------------------------------------------------------------------------------------------------------------------------------------------------------------------------------------------------------------------------------------------------------------------------------------------------------------------------------------------------------------------------------------------------------------------------------------------------------------------------------------------------------------------------------------------------------------------------------------------------------------------------------------------------------------------------------------------------------------------------------------------------------------------------------------------------------------------------------------------------------------------------------------------------------------------------------------------------------------------------------------------------------------------------------------------------------------------------------------------------------------------------------------------------------------------------------------------------------------------------------------------------------------------------------------------------------------------------------------------------------|
| Real Servers | <p>Table that allows you to add, modify, remove, or change the order of real servers.</p> <ol style="list-style-type: none"> <li>a. Choose an existing server, or click <b>Add</b> to add a server to the server farm and do one of the following: <ul style="list-style-type: none"> <li>– If you chose an existing server, you can view, modify, or duplicate the server’s existing configuration. See the “<a href="#">Shared Objects and Virtual Servers</a>” section on page 7-9 for more information about modifying shared objects.</li> <li>– If you click <b>Add</b>, the window refreshes so you can enter server information.</li> </ul> </li> <li>b. In the Name field, specify the name of the real server in one of the following ways: <ul style="list-style-type: none"> <li>– To identify a new real server, click the first radio button, and then enter the name of the real server in the adjoining field.</li> <li>– To specify an existing real server, click the second radio button, and then choose one of the real servers listed.</li> </ul> </li> <li>c. In the IP Address Type field, choose <b>IPv4</b> or <b>IPv6</b>. This field appears only for ACE module and ACE appliance software Version A5(1.0) or later, which supports IPv4 and IPv6.</li> <li>d. In the IP Address field, enter the IP address of the real server.</li> <li>e. In the Port field, enter the port number to be used for server port address translation (PAT). Valid entries are from 1 to 65535.</li> <li>f. In the Weight field, enter the weight to assign to this server in the server farm. Valid entries are from 1 to 100, and the default is 8.</li> <li>g. In the Redirection Code field, choose the appropriate redirection code. This field appears only for real servers identified as redirect servers. <ul style="list-style-type: none"> <li>– <b>N/A</b>—Indicates that the webhost redirection code is not defined.</li> <li>– <b>301</b>—Indicates that the requested resource has been moved permanently. For future references to this resource, the client should use one of the returned URIs.</li> <li>– <b>302</b>—Indicates that the requested resource has been found, but has been moved temporarily to another location. For future references to this resource, the client should use the request URI because the resource may be moved to other locations from time to time.</li> </ul> </li> <li>h. In the Web Host Redirection field, enter the URL string used to redirect requests to another server. This field appears only for real servers identified as redirect servers. Enter the URL and port used to redirect requests to another server. Valid entries are in the form <code>http://host.com:port</code> where host is the name of the server and port is the port to be used. Valid host entries are unquoted text strings with no spaces and a maximum of 255 characters. Valid port numbers are from 1 to 65535. <p>The relocation string supports the following special characters:</p> <ul style="list-style-type: none"> <li>– <code>%h</code>—Inserts the hostname from the request Host header</li> <li>– <code>%p</code>—Inserts the URL path string from the request</li> </ul> </li> <li>i. In the Rate Bandwidth field, enter the real server bandwidth limit in bytes per second. Valid entries are from 1 to 30000000 bytes.</li> <li>j. In the Rate Connection field, enter the limit for connections per second (valid entries are from 1 to 350000) and do one of the following: <ul style="list-style-type: none"> <li>– Click <b>OK</b> to accept your entries and add this real server to the server farm. The table refreshes with updated information.</li> <li>– Click <b>Cancel</b> to exit this procedure without saving your entries and to return to the Real Servers table.</li> </ul> </li> </ol> |

Table 7-13 New Server Farm Attributes (continued)

| Field | Description                                                                                                                                                                                                                                                                                                                                                                                                                                                                                                                                                                                                                                                                                                                                                                                                                                                                                                                                                                                                                                                                                                                                                                                                                                                                                                                                                                                                                                                                                                                                                                                                                                            |
|-------|--------------------------------------------------------------------------------------------------------------------------------------------------------------------------------------------------------------------------------------------------------------------------------------------------------------------------------------------------------------------------------------------------------------------------------------------------------------------------------------------------------------------------------------------------------------------------------------------------------------------------------------------------------------------------------------------------------------------------------------------------------------------------------------------------------------------------------------------------------------------------------------------------------------------------------------------------------------------------------------------------------------------------------------------------------------------------------------------------------------------------------------------------------------------------------------------------------------------------------------------------------------------------------------------------------------------------------------------------------------------------------------------------------------------------------------------------------------------------------------------------------------------------------------------------------------------------------------------------------------------------------------------------------|
|       | <p>k. In the State field, choose the administrative state of this server as follows:</p> <ul style="list-style-type: none"> <li>– <b>In Service</b>—The server is to be placed in use as a destination for server load balancing.</li> <li>– <b>In Service Standby</b>—The server is a backup server and remains inactive unless the primary server fails. If the primary server fails, the backup server becomes active and starts accepting connections.</li> <li>– <b>Out Of Service</b>—The server is not to be placed in use by a server load balancer as a destination for client connections.</li> </ul> <p>l. In the Fail-On-All field, check this check box to configure a real server to remain in the OPERATIONAL state unless all probes associated with it fail (AND logic). The Fail-On-All function is applicable to all probe types. Fail-On-All is applicable only for host real servers.</p> <p>m. Do one of the following:</p> <ul style="list-style-type: none"> <li>– Click <b>OK</b> to accept your entries and add this real server to the server farm. The table refreshes with updated information.</li> <li>– Click <b>Cancel</b> to exit this procedure without saving your entries and to return to the Real Servers table.</li> </ul> <p>To display statistics and status information for an existing real server, choose a real server in the list, and then click <b>Details</b>. ANM accesses the <b>show rserver name detail</b> CLI command to display detailed real server information. See the “<a href="#">Displaying Real Server Statistics and Status Information</a>” section on <a href="#">page 8-9</a>.</p> |

Table 7-14 Predictor Methods and Attributes

| Predictor Method | Description / Action                                                                                                                                                                                                                                                                                                                                                                                                                                                                                                                                                                                                                                                                                                                                                                                         |
|------------------|--------------------------------------------------------------------------------------------------------------------------------------------------------------------------------------------------------------------------------------------------------------------------------------------------------------------------------------------------------------------------------------------------------------------------------------------------------------------------------------------------------------------------------------------------------------------------------------------------------------------------------------------------------------------------------------------------------------------------------------------------------------------------------------------------------------|
| Hash Address     | <p>Method that indicates that the ACE is to select the server using a hash value based on the source or destination IP address.</p> <p>To configure the hash address predictor method, do the following:</p> <p>a. In the Mask Type field, indicate whether server selection is based on the source IP address or the destination IP address:</p> <ul style="list-style-type: none"> <li>– <b>N/A</b>—Indicates that this option is not defined.</li> <li>– <b>Destination</b>—Indicates that the server is selected based on the destination IP address.</li> <li>– <b>Source</b>—Indicates that the server is selected based on the source IP address.</li> </ul> <p>b. In the IP Netmask field, choose the subnet mask to apply to the address. If none is specified, the default is 255.255.255.255.</p> |



**Table 7-14** Predictor Methods and Attributes (continued)



|              |                                                                                                                                                                                                                                                                                                                                                                                                                                                                                                                                                                                                                                                                                                                                                                                                                                                                                                                                                                                                                                                                                                                                                                                                                                                                                                                                                                                                                                                                                                                                                                                                                                                                                                                                                                                                                                                                                                                                                                                                                                                                                                                                                                                                                                                                                                                                                                                                                                                                                                                                                                                                                                                                                                                                                                                                                                                                               |
|--------------|-------------------------------------------------------------------------------------------------------------------------------------------------------------------------------------------------------------------------------------------------------------------------------------------------------------------------------------------------------------------------------------------------------------------------------------------------------------------------------------------------------------------------------------------------------------------------------------------------------------------------------------------------------------------------------------------------------------------------------------------------------------------------------------------------------------------------------------------------------------------------------------------------------------------------------------------------------------------------------------------------------------------------------------------------------------------------------------------------------------------------------------------------------------------------------------------------------------------------------------------------------------------------------------------------------------------------------------------------------------------------------------------------------------------------------------------------------------------------------------------------------------------------------------------------------------------------------------------------------------------------------------------------------------------------------------------------------------------------------------------------------------------------------------------------------------------------------------------------------------------------------------------------------------------------------------------------------------------------------------------------------------------------------------------------------------------------------------------------------------------------------------------------------------------------------------------------------------------------------------------------------------------------------------------------------------------------------------------------------------------------------------------------------------------------------------------------------------------------------------------------------------------------------------------------------------------------------------------------------------------------------------------------------------------------------------------------------------------------------------------------------------------------------------------------------------------------------------------------------------------------------|
| Hash Content | <p>Method that indicates that the ACE is to select the server by using a hash value based on the specified content string of the HTTP packet body.</p> <p><b>a.</b> In the Begin Pattern field, enter the beginning pattern of the content string and the pattern string to match before hashing. If you do not specify a beginning pattern, the ACE starts parsing the HTTP body immediate following the offset byte. You cannot configure different beginning and ending patterns for different server farms that are part of the same traffic classification.</p> <p>Valid entries are unquoted text strings with no spaces and a maximum of 255 alphanumeric characters. The ACE supports regular expressions for matching string expressions. <a href="#">Table 14-33</a> lists the supported characters that you can use for matching string expressions.</p> <p><b>b.</b> In the End Pattern field, enter the pattern that marks the end of hashing. If you do not specify either a length or an end pattern, the ACE continues to parse the data until it reaches the end of the field or the end of the packet, or until it reaches the maximum body parse length. You cannot configure different beginning and ending patterns for different server farms that are part of the same traffic classification.</p> <p>Valid entries are unquoted text strings with no spaces and a maximum of 255 alphanumeric characters. The ACE supports regular expressions for matching string expressions. <a href="#">Table 14-33</a> lists the supported characters that you can use for matching string expressions.</p> <p><b>c.</b> In the Length (Bytes) field, enter the length in bytes of the portion of the content (starting with the byte after the offset value) that the ACE uses for sticking the client to the server. Valid entries are from 1 to 1000 bytes.</p> <p>The offset and length can vary from 0 to 1000 bytes. If the payload is longer than the offset but shorter than the offset plus the length of the payload, the ACE sticks the connection based on that portion of the payload starting with the byte after the offset value and ending with the byte specified by the offset plus the length. The total of the offset and the length cannot exceed 1000.</p> <p> <b>Note</b> You cannot specify both the length and the end-pattern options for a Hash Content predictor.</p> <p><b>d.</b> In the HTTP Content Offset (Bytes) field, enter the portion of the content that the ACE uses to stick the client on a particular server by indicating the bytes to ignore starting with the first byte of the payload. Valid entries are from 0 to 999 bytes. The default is 0, which indicates that the ACE does not exclude any portion of the content.</p> |
| Hash Cookie  | <p>Method that indicates that the ACE is to select the server by using a hash value based on the cookie name.</p> <p>In the Cookie Name field, enter a cookie name in the form of an unquoted text string with no spaces and a maximum of 64 characters.</p>                                                                                                                                                                                                                                                                                                                                                                                                                                                                                                                                                                                                                                                                                                                                                                                                                                                                                                                                                                                                                                                                                                                                                                                                                                                                                                                                                                                                                                                                                                                                                                                                                                                                                                                                                                                                                                                                                                                                                                                                                                                                                                                                                                                                                                                                                                                                                                                                                                                                                                                                                                                                                  |
| Hash Header  | <p>Method that indicates that the ACE is to select the server by using a hash value based on the header name.</p> <p>In the Header Name field, choose the HTTP header to be used for server selection as follows:</p> <ul style="list-style-type: none"> <li>• To specify an HTTP header that is not one of the standard HTTP headers, click the first radio button and enter the HTTP header name in the Header Name field. Valid entries are unquoted text strings with no spaces and a maximum of 64 characters.</li> <li>• To specify one of the standard HTTP headers, click the second radio button, and then choose one of the HTTP headers from the list.</li> </ul>                                                                                                                                                                                                                                                                                                                                                                                                                                                                                                                                                                                                                                                                                                                                                                                                                                                                                                                                                                                                                                                                                                                                                                                                                                                                                                                                                                                                                                                                                                                                                                                                                                                                                                                                                                                                                                                                                                                                                                                                                                                                                                                                                                                                  |

Table 7-14 Predictor Methods and Attributes (continued)

|              |                                                                                                                                                                                                                                                                                                                                                                                                                                                                                                                                                                                                                                                                                                                                                                                                                                                                                                                                                                                                                                                                                                                                                                                                                                                                                                                                                                                                                                                                                                                                                                                                                                                                                                                                                                                                                                                                                                                                                                                                                                                                                                                                                                                                                                                                                                                                                                                                                                                                                                                                                                                                                                                                                                                                                                                                                                                                                                                                                          |
|--------------|----------------------------------------------------------------------------------------------------------------------------------------------------------------------------------------------------------------------------------------------------------------------------------------------------------------------------------------------------------------------------------------------------------------------------------------------------------------------------------------------------------------------------------------------------------------------------------------------------------------------------------------------------------------------------------------------------------------------------------------------------------------------------------------------------------------------------------------------------------------------------------------------------------------------------------------------------------------------------------------------------------------------------------------------------------------------------------------------------------------------------------------------------------------------------------------------------------------------------------------------------------------------------------------------------------------------------------------------------------------------------------------------------------------------------------------------------------------------------------------------------------------------------------------------------------------------------------------------------------------------------------------------------------------------------------------------------------------------------------------------------------------------------------------------------------------------------------------------------------------------------------------------------------------------------------------------------------------------------------------------------------------------------------------------------------------------------------------------------------------------------------------------------------------------------------------------------------------------------------------------------------------------------------------------------------------------------------------------------------------------------------------------------------------------------------------------------------------------------------------------------------------------------------------------------------------------------------------------------------------------------------------------------------------------------------------------------------------------------------------------------------------------------------------------------------------------------------------------------------------------------------------------------------------------------------------------------------|
| Hash Layer 4 | <p>Method that indicates that the ACE is to select the server by using a Layer 4 generic protocol load-balancing method. Use this predictor to load balance packets from protocols that are not explicitly supported by the ACE.</p> <p><b>a.</b> In the Begin Pattern field, enter the beginning pattern of the Layer 4 payload and the pattern string to match before hashing. If you do not specify a beginning pattern, the ACE starts parsing the HTTP body immediate following the offset byte. You cannot configure different beginning and ending patterns for different server farms that are part of the same traffic classification.</p> <p>Valid entries are unquoted text strings with no spaces and a maximum of 255 alphanumeric characters. The ACE supports regular expressions for matching string expressions. <a href="#">Table 14-33</a> lists the supported characters that you can use for matching string expressions.</p> <p><b>b.</b> In the End Pattern field, enter the pattern that marks the end of hashing. If you do not specify either a length or an end pattern, the ACE continues to parse the data until it reaches the end of the field or the end of the packet, or until it reaches the maximum body parse length. You cannot configure different beginning and ending patterns for different server farms that are part of the same traffic classification.</p> <p>Valid entries are unquoted text strings with no spaces and a maximum of 255 alphanumeric characters. The ACE supports regular expressions for matching string expressions. <a href="#">Table 14-33</a> lists the supported characters that you can use for matching string expressions.</p> <p><b>c.</b> In the Length (Bytes) field, enter the length in bytes of the portion of the payload (starting with the byte after the offset value) that the ACE uses for sticking the client to the server. Valid entries are from 1 to 1000 bytes.</p> <p>The offset and length can vary from 0 to 1000 bytes. If the payload is longer than the offset but shorter than the offset plus the length of the payload, the ACE sticks the connection based on that portion of the payload starting with the byte after the offset value and ending with the byte specified by the offset plus the length. The total of the offset and the length cannot exceed 1000.</p> <p> <b>Note</b> You cannot specify both the length and end-pattern options for a Hash Layer 4 predictor.</p> <p><b>d.</b> In the HTTP Content Offset (Bytes) field, enter the portion of the content that the ACE uses to stick the client on a particular server by indicating the bytes to ignore starting with the first byte of the payload. Valid entries are from 0 to 999 bytes. The default is 0, which indicates that the ACE does not exclude any portion of the content.</p> |
| Hash URL     | <p>Method that indicates that the ACE is to select the server using a hash value based on the URL. Use this method to load balance firewalls.</p> <p>Enter values in one or both of the pattern fields:</p> <ul style="list-style-type: none"> <li>• In the URL Begin Pattern field, enter the beginning pattern of the URL and the pattern string to parse.</li> <li>• In the URL End Pattern field, enter the ending pattern of the URL and the pattern string to parse.</li> </ul> <p>Valid entries for these fields are unquoted text strings with no spaces and a maximum of 255 alphanumeric characters for each pattern you configure.</p>                                                                                                                                                                                                                                                                                                                                                                                                                                                                                                                                                                                                                                                                                                                                                                                                                                                                                                                                                                                                                                                                                                                                                                                                                                                                                                                                                                                                                                                                                                                                                                                                                                                                                                                                                                                                                                                                                                                                                                                                                                                                                                                                                                                                                                                                                                        |

**Table 7-14** Predictor Methods and Attributes (continued)

|                   |                                                                                                                                                                                                                                                                                                                                                                                                                                                                                                                                                                                                                                                                                                                                                                                                                                                                                                                                                                                                                                                                                                                                                                                                                                                                                                                                                                                                                                                                                                                                                                                                                                                                                                                                                                                                                                                                                                                                                                                                                                                                                                                                                                                                                                  |
|-------------------|----------------------------------------------------------------------------------------------------------------------------------------------------------------------------------------------------------------------------------------------------------------------------------------------------------------------------------------------------------------------------------------------------------------------------------------------------------------------------------------------------------------------------------------------------------------------------------------------------------------------------------------------------------------------------------------------------------------------------------------------------------------------------------------------------------------------------------------------------------------------------------------------------------------------------------------------------------------------------------------------------------------------------------------------------------------------------------------------------------------------------------------------------------------------------------------------------------------------------------------------------------------------------------------------------------------------------------------------------------------------------------------------------------------------------------------------------------------------------------------------------------------------------------------------------------------------------------------------------------------------------------------------------------------------------------------------------------------------------------------------------------------------------------------------------------------------------------------------------------------------------------------------------------------------------------------------------------------------------------------------------------------------------------------------------------------------------------------------------------------------------------------------------------------------------------------------------------------------------------|
| Least Bandwidth   | <p>Method that indicates that the ACE is to select the server with the least amount of network traffic over a specified sampling period.</p> <ol style="list-style-type: none"> <li>a. In the Assess Time field, enter the number of seconds for which the ACE is to collect traffic information. Valid entries are from 1 to 10 seconds.</li> <li>b. In the Least Bandwidth Samples field, enter the number of samples over which you want to weight and average the results of the probe query to calculate the final load value. Valid entries are 1, 2, 4, 8, and 16 (values from 1 to 16 that are also a power of 2).</li> </ol>                                                                                                                                                                                                                                                                                                                                                                                                                                                                                                                                                                                                                                                                                                                                                                                                                                                                                                                                                                                                                                                                                                                                                                                                                                                                                                                                                                                                                                                                                                                                                                                            |
| Least Connections | <p>Method that indicates that the ACE is to select the server with the fewest number of connections.</p> <p>In the Slowstart Duration field, enter the slow-start value to be applied to this predictor method. Valid entries are from 1 to 65535, where 1 is the slowest ramp-up value.</p> <p>The slow-start mechanism is used to avoid sending a high rate of new connections to servers that you have just put into service.</p>                                                                                                                                                                                                                                                                                                                                                                                                                                                                                                                                                                                                                                                                                                                                                                                                                                                                                                                                                                                                                                                                                                                                                                                                                                                                                                                                                                                                                                                                                                                                                                                                                                                                                                                                                                                             |
| Least Loaded      | <p>Method that indicates that the ACE is to select the server with the lowest load based on information from SNMP probes.</p> <ol style="list-style-type: none"> <li>a. In the SNMP Probe Name field, choose the name of the SNMP probe to use.</li> <li>b. In the Auto Adjust field, configure the autoadjust feature to assign a maximum load value of 16000 to that server to prevent it from being flooded with new incoming connections. The ACE periodically adjusts this load value based on feedback from the server's SNMP probe and other configured options. Options include: <ul style="list-style-type: none"> <li>– <b>Average</b>—Instructs the ACE to apply the average load of the server farm to a real server whose load reaches zero. The average load is the running average of the load values across all real servers in the server farm. This is the default setting.</li> <li>– <b>Maxload</b>—Instructs the ACE to apply the maximum load of the server farm to a real server whose load reaches zero.</li> </ul> <p>The maxload option requires the following ACE software versions:</p> <ul style="list-style-type: none"> <li>- ACE appliance—A3(2.7) or A4(1.0) or later</li> <li>- ACE module—A2(2.4), A2(3.2), or A4(1.0) or later</li> </ul> <p>If you choose the maxload option and the ACE does not support the option, ANM issues a command parse error message.</p> <ul style="list-style-type: none"> <li>– <b>Off</b>—Instructs the ACE to send all new connections to the server that has a load of zero until the next load update arrives from the SNMP probe for this server. There may be times when you want the ACE to send all new connections to a real server whose load is zero.</li> </ul> </li> <li>c. In the Weight Connection field, check the check box to instruct the ACE to use the current connection count in the final load calculation for a real server. When you configure this option, the ACE includes the current connection count in the total load calculation for each real server in a server farm. Uncheck the check box to reset the behavior of the ACE to the default of excluding the current connection count from the load calculation.</li> </ol> |

**Table 7-14** Predictor Methods and Attributes (continued)

|             |                                                                                                                                                                                                                                                                                                                                                                                                                                                                                                                                                                                                                                                                                                                                                                                                                                                                                                                                                                                                                                                                                                                                                                                                                                                                                                                                                                                                                                                                                                                   |
|-------------|-------------------------------------------------------------------------------------------------------------------------------------------------------------------------------------------------------------------------------------------------------------------------------------------------------------------------------------------------------------------------------------------------------------------------------------------------------------------------------------------------------------------------------------------------------------------------------------------------------------------------------------------------------------------------------------------------------------------------------------------------------------------------------------------------------------------------------------------------------------------------------------------------------------------------------------------------------------------------------------------------------------------------------------------------------------------------------------------------------------------------------------------------------------------------------------------------------------------------------------------------------------------------------------------------------------------------------------------------------------------------------------------------------------------------------------------------------------------------------------------------------------------|
| Response    | <p>Method that indicates that the ACE is to select the server with the lowest response time for a requested response-time measurement.</p> <p><b>a.</b> In the Response Type field, choose the type of measurement to use:</p> <ul style="list-style-type: none"> <li>– <b>App-Req-To-Resp</b>—The response time from when the ACE sends an HTTP request to a server to the time that the ACE receives a response from the server for that request.</li> <li>– <b>Syn-To-Close</b>—The response time from when the ACE sends a TCP SYN to a server to the time that the ACE receives a CLOSE from the server.</li> <li>– <b>Syn-To-Synack</b>—The response time from when the ACE sends a TCP SYN to a server to the time that the ACE receives a SYN-ACK from the server.</li> </ul> <p><b>b.</b> In the Response Samples field, enter the number of samples over which you want to average the results of the response-time measurement. Valid entries are 1, 2, 4, 8, and 16 (values from 1 to 16 that are also a power of 2).</p> <p><b>c.</b> In the Weight Connection field, check the check box to instruct the ACE to use the current connection count in the final load calculation for a real server. When you configure this option, the ACE includes the current connection count in the total load calculation for each real server in a server farm. Uncheck the check box to reset the behavior of the ACE to the default of excluding the current connection count from the load calculation.</p> |
| Round Robin | <p>Method that indicates that the ACE is to select the next server in the list of servers based on server weight. This is the default predictor method.</p>                                                                                                                                                                                                                                                                                                                                                                                                                                                                                                                                                                                                                                                                                                                                                                                                                                                                                                                                                                                                                                                                                                                                                                                                                                                                                                                                                       |

**Step 10** (Optional) If you chose Sticky as the primary action, in the Sticky Group field, choose an existing sticky group or click **\*New\*** to add a new sticky group ([Table 7-15](#)).



**Note** Fields and information related to IPv6 require ACE module and ACE appliance software Version A5(1.0) or later.



**Note** If you chose an existing sticky group, you can view, modify, or duplicate the selected object's existing configuration. See the [“Shared Objects and Virtual Servers”](#) section on page 7-9 for more information about modifying shared objects in virtual servers.

Table 7-15 Sticky Group Attributes

| Field              | Description                                                                                                                                                                                                                                                                                                                                                                                                                                                                                                                                                                                                                                                                                                                                                                                                                                                                                                                                                                                                                                                                                                                                                                                                                                                                                                                                                                                                                                                                                                                                                                                                                                                                                                                                                                                                                                                                                                                                                                                                                                                                                                                                                                                                                                                                                                                                                                                                                                                                                                                                                                                                                                                                                                                                                                                                                                                                                                                                                                                                                                                                                                                                                                                                                                                                                           |
|--------------------|-------------------------------------------------------------------------------------------------------------------------------------------------------------------------------------------------------------------------------------------------------------------------------------------------------------------------------------------------------------------------------------------------------------------------------------------------------------------------------------------------------------------------------------------------------------------------------------------------------------------------------------------------------------------------------------------------------------------------------------------------------------------------------------------------------------------------------------------------------------------------------------------------------------------------------------------------------------------------------------------------------------------------------------------------------------------------------------------------------------------------------------------------------------------------------------------------------------------------------------------------------------------------------------------------------------------------------------------------------------------------------------------------------------------------------------------------------------------------------------------------------------------------------------------------------------------------------------------------------------------------------------------------------------------------------------------------------------------------------------------------------------------------------------------------------------------------------------------------------------------------------------------------------------------------------------------------------------------------------------------------------------------------------------------------------------------------------------------------------------------------------------------------------------------------------------------------------------------------------------------------------------------------------------------------------------------------------------------------------------------------------------------------------------------------------------------------------------------------------------------------------------------------------------------------------------------------------------------------------------------------------------------------------------------------------------------------------------------------------------------------------------------------------------------------------------------------------------------------------------------------------------------------------------------------------------------------------------------------------------------------------------------------------------------------------------------------------------------------------------------------------------------------------------------------------------------------------------------------------------------------------------------------------------------------------|
| Group Name         | Unique identifier for the sticky group. You can either accept the automatically incremented entry that was provided or you can enter your own. Valid entries are unquoted text strings with no spaces and a maximum of 64 alphanumeric characters.                                                                                                                                                                                                                                                                                                                                                                                                                                                                                                                                                                                                                                                                                                                                                                                                                                                                                                                                                                                                                                                                                                                                                                                                                                                                                                                                                                                                                                                                                                                                                                                                                                                                                                                                                                                                                                                                                                                                                                                                                                                                                                                                                                                                                                                                                                                                                                                                                                                                                                                                                                                                                                                                                                                                                                                                                                                                                                                                                                                                                                                    |
| Type               | <p>Method to be used when establishing sticky connections and configure any type-specific attributes:</p> <p><b>Note</b> The available selections listed in the Type drop-down list will vary depending on your selection for Application Protocol in the Properties configuration subset (see <a href="#">Table 7-2</a>). For example, if you chose HTTP or HTTPS as the application protocol, only IP Netmask, HTTP Cookie, HTTP Header, and HTTP Content appear as selections in the Type drop-down list.</p> <ul style="list-style-type: none"> <li>• <b>HTTP Content</b>—The virtual server is to stick client connections to the same real server based on a string in the data portion of the HTTP packet. See <a href="#">Table 9-2</a> for additional configuration options.</li> <li>• <b>HTTP Cookie</b>—The virtual server is either to learn a cookie from the HTTP header of a client request or to insert a cookie in the Set-Cookie header of the response from the server to the client, and then use the learned cookie to provide stickiness between the client and server for the duration of the transaction. See <a href="#">Table 9-3</a> for additional configuration options.</li> <li>• <b>HTTP Header</b>—The virtual server is to stick client connections to the same real server based on HTTP headers. See <a href="#">Table 9-4</a> for additional configuration options.</li> <li>• <b>IP Netmask</b>—The virtual server is to stick a client to the same server for multiple subsequent connections as needed to complete a transaction using the client source IPv4 address, the destination IPv4 address, or both. See <a href="#">Table 9-5</a> for additional configuration options.</li> </ul> <p><b>Note</b> If an organization uses a megaproxy to load balance client requests across multiple proxy servers when a client connects to the Internet, the source IP address is no longer a reliable indicator of the true source of the request. In this situation, you can use cookies or another sticky method to ensure session persistence.</p> <ul style="list-style-type: none"> <li>• <b>V6 Prefix</b>—(Requires ACE module and ACE appliance software Version A5(1.0) or later) Indicates that the virtual server is to stick a client to the same server for multiple subsequent connections as needed to complete a transaction using the client source IPv6 address, the destination IPv6 address, or both. See <a href="#">Table 9-6</a> for additional configuration options.</li> <li>• <b>Layer 4 Payload</b>—The virtual server is to stick client connections to the same real server based on a string in the payload portion of the Layer 4 protocol packet. See <a href="#">Table 9-7</a> for additional configuration options.</li> <li>• <b>RADIUS</b>—The virtual server is to stick client connections to the same real server based on a RADIUS attribute.</li> <li>• <b>RTSP Header</b>—The virtual server is to stick client connections to the same real server based on the RTSP Session header field. <a href="#">Table 9-9</a> for additional configuration options.</li> <li>• <b>SIP Header</b>—The virtual server is to stick client connections to the same real server based on the SIP Call-ID header field.</li> </ul> |
| Sticky Server Farm | Existing server farm that is to act as the primary server farm for this sticky group. You can choose <b>*New*</b> to create a new server farm. If you chose <b>*New*</b> , configure the server farm using the information in <a href="#">Table 7-13</a> .                                                                                                                                                                                                                                                                                                                                                                                                                                                                                                                                                                                                                                                                                                                                                                                                                                                                                                                                                                                                                                                                                                                                                                                                                                                                                                                                                                                                                                                                                                                                                                                                                                                                                                                                                                                                                                                                                                                                                                                                                                                                                                                                                                                                                                                                                                                                                                                                                                                                                                                                                                                                                                                                                                                                                                                                                                                                                                                                                                                                                                            |
| Backup Server Farm | Existing server farm that is to act as the backup server farm this sticky group. You can choose <b>*New*</b> to create a new server farm. If you chose <b>*New*</b> , configure the server farm using the information in <a href="#">Table 7-13</a> .                                                                                                                                                                                                                                                                                                                                                                                                                                                                                                                                                                                                                                                                                                                                                                                                                                                                                                                                                                                                                                                                                                                                                                                                                                                                                                                                                                                                                                                                                                                                                                                                                                                                                                                                                                                                                                                                                                                                                                                                                                                                                                                                                                                                                                                                                                                                                                                                                                                                                                                                                                                                                                                                                                                                                                                                                                                                                                                                                                                                                                                 |

Table 7-15 Sticky Group Attributes (continued)

| Field                                | Description                                                                                                                                                                                                                                                                                                                                                                                                                                                                                        |
|--------------------------------------|----------------------------------------------------------------------------------------------------------------------------------------------------------------------------------------------------------------------------------------------------------------------------------------------------------------------------------------------------------------------------------------------------------------------------------------------------------------------------------------------------|
| Aggregate State                      | Check box to indicate that the state of the primary server farm is to be tied to the state of all real servers in the server farm and in the backup server farm, if configured. The ACE declares the primary server farm down if all real servers in the primary server farm and all real servers in the backup server farm are down.<br><br>Uncheck the check box if the state of the primary server farm is not to be tied to all real servers in the server farm and in the backup server farm. |
| Sticky Enabled On Backup Server Farm | Check box to indicate that the backup server farm is sticky. Uncheck the check box if the backup server farm is not sticky.                                                                                                                                                                                                                                                                                                                                                                        |
| Replicate On HA Peer                 | Check box to indicate that the virtual server is to replicate sticky table entries on the backup server farm. If a failover occurs and this option is selected, the new active server farm can maintain the existing sticky connections.<br><br>Uncheck the check box to indicate that the virtual server is not to replicate sticky table entries on the backup server farm.                                                                                                                      |
| Timeout (Minutes)                    | Number of minutes that the virtual server keeps the sticky information for a client connection in the sticky table after the latest client connection terminates. Valid entries are from 1 to 65535; the default is 1440 minutes (24 hours).                                                                                                                                                                                                                                                       |
| Timeout Active Connections           | Check box to specify that the virtual server is to time out sticky table entries even if active connections exist after the sticky timer expires.<br><br>Uncheck the check box to specify that the virtual is not to time out sticky table entries even if active connections exist after the sticky timer expires. This behavior is the default.                                                                                                                                                  |

**Step 11** (Optional) If you are using the ACE appliance (all versions) or ACE module version A4(1.0) and later, in the Compression Method field, choose the HTTP compression method to indicate how the ACE appliance is to compress packets when a client request indicates that the client browser is capable of packet compression.

By default, HTTP compression is disabled in the ACE. When you configure HTTP compression using the ACE, the appliance compresses data in the HTTP GET responses from the real servers. The ACE does not compress HTTP requests from clients or the HTTP headers in the server responses.



**Note** By default, the ACE appliance supports HTTP compression at rates of 100 megabits per second (Mbps). Installing an optional HTTP compression license allows you to increase this value to a maximum of 2 Gbps. See the *Cisco 4700 Series Application Control Engine Appliance Administration Guide* for information on ACE licensing options.

Options are as follows:

- **Gzip**—Specifies the gzip compression format as the method to use when the client browser supports both the deflate and gzip compression methods. Gzip is the file format for compression described in RFC1952.
- **Deflate**—Specifies the deflate compression format as the method to use when the client browser supports both the deflate and gzip compression methods. Deflate is the data format for compression described in RFC1951.
- **N/A**—HTTP compression is disabled.

When configuring HTTP compression, we recommend that you exclude the following MIME types from HTTP compression: “.gif”, “.css”, “.js”, “.class”, “.jar”, “.cab”, “.txt”, “.ps”, “.vbs”, “.xsl”, “.xml”, “.pdf”, “.swf”, “.jpg”, “.jpeg”, “.jpe”, or “.png”.

When you enable HTTP compression, the ACE compresses the packets using the following default compression parameter values:

- Mime type—All text formats (text/\*).
- Minimum size—512 bytes.
- User agent—None.

**Step 12** In the SSL Initiation field, choose an existing service or choose **\*New\*** to create a new service, and do one of the following:

- If you chose an existing SSL service, you can view, modify, or duplicate the existing configuration. See the “[Shared Objects and Virtual Servers](#)” section on page 7-9 for more information about modifying shared objects.
- If you chose **\*New\***, configure the service using the information in [Table 7-5](#). For more information about SSL, see the “[Configuring SSL](#)” section on page 11-1.

**Step 13** In the Insert HTTP Headers field, enter the name of the HTTP header and the value to be matched using the *header\_name=header\_value* format where:

- *header\_name* represents the name of the HTTP header to insert in the client HTTP request. Valid entries are unquoted text strings with no spaces and a maximum of 64 alphanumeric characters. You can specify predefined header or any custom header name provided that it does not exceed the maximum length limit.
- *header\_value* represents the expression string to compare against the value in the specified field in the HTTP header. Valid entries are text strings with a maximum of 255 alphanumeric characters. The ACE supports regular expressions for matching. Header expressions allow spaces, provided that the spaces are escaped or quoted. All headers in the header map must be matched. [Table 14-33](#) lists the supported characters that you can use in regular expressions.

For example, you might enter **Host=www.cisco.com**.

**Step 14** Do one of the following:

- Click **OK** to save your entries and to return to the Rule Match table.
- Click **Cancel** to exit this procedure without saving your entries and to return to the Rule Match table.

**Step 15** If you are adding Rule Match entries for a new virtual server and you want to modify the sequence of rules in the L7 Load Balancing section of the Virtual Server configuration page, click **Up** or **Down** to change the order of the entries in the Rule Match table.



**Note** The Up and Down buttons are not available for an existing virtual server, only for a new virtual server. To reorder the entries in the Rule Match table for an existing virtual server, go to Config > Expert > Policy Maps and choose the Layer 7 load balancing policy map, delete the rule entry that you want to reorder, and then add it again by using the Insert Before option to put it in the correct order. See the “[Configuring Rules and Actions for Policy Maps](#)” section on page 14-34 for details.

**Step 16** Do one of the following:

- Click **Deploy Now** to deploy this configuration on the ACE and save your entries to the running-configuration and startup-configuration files.
- Click **Cancel** to exit this procedure without saving your entries.

- Click **Deploy Later** to save your entries and apply them at a later time.
- 

#### Related Topics

- [Configuring Virtual Servers, page 7-2](#)
- [Configuring Virtual Server Properties, page 7-11](#)
- [Configuring Virtual Server SSL Termination, page 7-17](#)
- [Configuring Virtual Server Protocol Inspection, page 7-18](#)

## Configuring Virtual Server Default Layer 7 Load Balancing

You can configure default Layer 7 load-balancing actions for all network traffic that does not meet previously specified match conditions.

#### Assumption

Make sure that a virtual server has been configured in the Properties configuration subset. For more information, see the [“Configuring Virtual Server Properties” section on page 7-11](#). See the [“Configuring Virtual Servers” section on page 7-2](#) for information on configuring a virtual server.

#### Procedure

---

- Step 1** Choose **Config > Devices > context > Load Balancing > Virtual Servers**.
- The Virtual Servers table appears.
- Step 2** In the Virtual Servers table, choose the virtual server that you want to configure for default Layer 7 load balancing, and click **Edit**.
- The Virtual Server configuration window appears.
- Step 3** In the Virtual Server configuration window, click **Default L7 Load-Balancing Action**.
- The Default L7 Load-Balancing Action configuration pane appears.
- Step 4** In the Primary Action field of the Default L7 Load-Balancing Action configuration pane, choose the default action that the virtual server is to take in response to client requests for content when specified match conditions are not met:
- **Drop**—Client requests that do not meet specified match conditions are to be discarded. Continue with [Step 9](#).
  - **Forward**—Client requests that do not meet specified match conditions are to be forwarded without performing load balancing on the requests. Continue with [Step 9](#).
  - **Load Balance**—Client requests for content are to be directed to a server farm. Continue with [Step 6](#).
  - **Sticky**—Client requests for content are to be handled by a sticky group when match conditions are met. Continue with [Step 7](#).
- Step 5** (Optional) From the HTTP Header Modify Action List drop-down list, choose an existing Action List or choose **New** to display the Action List configuration table and create a new one. For more information, see the [“Configuring an HTTP Header Modify Action List” section on page 14-85](#).



**Step 6** (Optional) If you chose Load Balance as the primary action, do the following:

- a. In the Server Farm field, choose the primary server farm to use for load balancing, or choose **\*New\*** to configure a new server farm (see [Table 7-13](#)).



---

**Note** To display statistics and status information for an existing server farm, choose a server farm in the list, and then click **Details**. ANM accesses the **show serverfarm name detail** CLI command to display detailed server farm information. See the [“Displaying Server Farm Statistics and Status Information”](#) section on page 8-48.

---

- b. In the Backup Server Farm field, choose the server farm to act as the backup server farm for load balancing if the primary server farm is unavailable, or choose **\*New\*** to configure a new backup server farm (see [Table 7-13](#)).



---

**Note** If you chose an existing object in either field, you can view, modify, or duplicate the selected object’s existing configuration. See the [“Shared Objects and Virtual Servers”](#) section on page 7-9 for more information about modifying shared objects in virtual servers.

---

**Step 7** (Optional) If you chose Sticky as the primary action, in the Sticky Group field, choose an existing sticky group or click **\*New\*** to add a new sticky group (see [Table 7-15](#)).



---

**Note** If you chose an existing sticky group, you can view, modify, or duplicate the selected object’s existing configuration. See the [“Shared Objects and Virtual Servers”](#) section on page 7-9 for more information about modifying shared objects in virtual servers.

---

**Step 8** (Optional) If you are using the ACE appliance (all versions) or ACE module version A4(1.0) and later, in the Compression Method field, choose the HTTP compression method to indicate how the ACE appliance is to compress packets when a client request indicates that the client browser is capable of packet compression.

By default, HTTP compression is disabled in the ACE. When you configure HTTP compression using the ACE, the appliance compresses data in the HTTP GET responses from the real servers. The ACE does not compress HTTP requests from clients or the HTTP headers in the server responses.



---

**Note** By default, the ACE appliance supports HTTP compression at rates of 100 megabits per second (Mbps). Installing an optional HTTP compression license allows you to increase this value to a maximum of 2 Gbps. See the *Cisco 4700 Series Application Control Engine Appliance Administration Guide* for information on ACE licensing options.

---

Options are as follows:

- **Deflate**—Specifies the deflate compression format as the method to use when the client browser supports both the deflate and gzip compression methods. deflate, the data format for compression described in RFC1951.
- **Gzip**—Specifies the gzip compression format as the method to use when the client browser supports both the deflate and gzip compression methods. Gzip is the file format for compression described in RFC1952.
- **N/A**—HTTP compression is disabled.



---

**Note** If you enable the Gzip or Deflate compression format, ANM automatically inserts a L7 Load Balance Primary Action to exclude the MIME types listed above. However, if you disable HTTP compression later on, you will need to remove the auto-inserted Load Balance Primary Action.

---

When you enable HTTP compression, the ACE compresses the packets using the following default compression parameter values:

- Mime type—All text formats (text/\*).
- Minimum size—512 bytes.
- User agent—None.

- Step 9** In the SSL Initiation field, choose an existing service or choose **\*New\*** to create a new service:
- If you chose an existing SSL service, you can view, modify, or duplicate the existing configuration. See the “[Shared Objects and Virtual Servers](#)” section on page 7-9 for more information about modifying shared objects.
  - If you chose **\*New\***, configure the service using the information in [Table 7-5](#). For more information about SSL, see the “[Configuring SSL](#)” section on page 11-1.
- Step 10** In the Insert HTTP Headers field, enter the name of the HTTP header and the value to be matched using the *header\_name=header\_value* format where:
- *header\_name* represents the name of the HTTP header to insert in the client HTTP request. Valid entries are unquoted text strings with no spaces and a maximum of 64 alphanumeric characters. You can specify predefined header or any custom header name provided that it does not exceed the maximum length limit.
  - *header\_value* represents the expression string to compare against the value in the specified field in the HTTP header. Valid entries are text strings with a maximum of 255 alphanumeric characters. The ACE supports regular expressions for matching. Header expressions allow spaces, provided that the spaces are escaped or quoted. All headers in the header map must be matched. [Table 14-33](#) lists the supported characters that you can use in regular expressions.

For example, you might enter **Host=www.cisco.com**.

- Step 11** Do one of the following:
- Click **Deploy Now** to deploy this configuration on the ACE and save your entries to the running-configuration and startup-configuration files.
  - Click **Cancel** to exit this procedure without saving your entries and to return to the Virtual Servers table.
  - Click **Deploy Later** to save your entries and apply the configuration at a later time.
- 

#### Related Topics

- [Configuring Virtual Server Properties, page 7-11](#)
- [Configuring Virtual Server SSL Termination, page 7-17](#)
- [Configuring Virtual Server Protocol Inspection, page 7-18](#)
- [Configuring Virtual Server Layer 7 Load Balancing, page 7-30](#)

# Configuring Application Acceleration and Optimization

**Note**

This option is available only for ACE appliances and only in the Advanced View.

You can configure acceleration and optimization on virtual servers that are configured on ACE appliances. The ACE appliance includes configuration options that allow you to accelerate enterprise applications, resulting in increased employee productivity, enhanced customer retention, and increased online revenues. The application acceleration functions of the ACE appliance apply several optimization technologies to accelerate Web application performance. This application acceleration functionality enables enterprises to optimize network performance and improve access to critical business information. It also accelerates the performance of Web applications, including customer relationship management (CRM), portals, and online collaboration by up to 10 times.

See the “[Configuring Application Acceleration and Optimization](#)” section on page 15-1 or the *Cisco 4700 Series Application Control Engine Appliance Application Acceleration and Optimization Configuration Guide* for more information about application acceleration and optimization.

**Assumption**

Make sure that a virtual server has been configured on an ACE appliance with HTTP or HTTPS as the application protocol. See the “[Configuring Virtual Servers](#)” section on page 7-2 for information about configuring a virtual server.

**Procedure**

- 
- Step 1** Choose **Config > Devices > context > Load Balancing > Virtual Servers**.
- The Virtual Servers table appears.
- Step 2** In the Virtual Servers table, choose the virtual server that you want to configure for optimization, and click **Edit**.
- The Virtual Server configuration window appears.
- Step 3** In the Virtual Server configuration window, click **Application Acceleration And Optimization**.
- The Application Acceleration And Optimization configuration pane appears.
- Step 4** In the Configuration field of the Application Acceleration And Optimization configuration pane, choose the method that you want to use to configure application acceleration and optimization:
- **EZ**—Use standard acceleration and optimization options. Continue with [Step 5](#).
  - **Custom**—Associate specific match criteria, actions, and parameter maps for application acceleration and optimization for the virtual server. If you choose this option, continue with [Step 6](#) through [Step 14](#).
- Step 5** (Optional) If you chose EZ, the Latency Optimization (FlashForward) and Bandwidth Optimization (Delta) fields appear.
- Do the following:
- a. Check the **Latency Optimization (FlashForward)** check box to specify that the ACE appliance is to use bandwidth reduction and download acceleration techniques to objects embedded within HTML pages. Uncheck the check box to specify that the ACE appliance is not to employ these techniques to objects embedded within HTML pages. Latency optimization corresponds to FlashForward functionality. For more information about FlashForward functionality, see the “[Optimization Overview](#)” section on page 15-2.

- b. Check the **Bandwidth Optimization (Delta)** check box to specify that the ACE appliance is to dynamically update client browser caches with content differences, or deltas. Uncheck the check box to specify that the ACE appliance is not to dynamically update client browser caches. Bandwidth optimization corresponds to action list Delta optimization. For more information about configuring Delta optimization, see the “[Optimization Overview](#)” section on page 15-2 and the “[Configuring an HTTP Optimization Action List](#)” section on page 15-3.
- c. Continue with [Step 14](#).
- Step 6** (Optional) If you chose Custom, the Actions configuration pane appears with a table listing match criteria and actions.
- Click **Add** to add an entry to this table or choose an existing entry, and click **Edit** to modify it. The configuration pane refreshes with the available configuration options.
- Step 7** In the Apply Building Block field, choose one of these configuration building blocks for the type of optimization that you want to configure, or leave the field blank to configure optimization without a building block:
- **Bandwidth Optimization**—Maximizes bandwidth for Web-based traffic.
  - **Latency Optimization for Embedded Objects**—Reduces the latency associated with embedded objects in Web-based traffic.
  - **Latency Optimization for Embedded Images**—Reduces the latency associated with embedded images in Web-based traffic.
  - **Latency Optimization for Containers**—Reduces the latency associated with Web containers.
- If you chose one of the building blocks, the Rule Match configuration subset displays the configuration options with selections based on the building block chosen. You can accept the entries as they are or modify them.
- If you do not choose a building block, additional configuration options appear depending on the features you enable.
- Step 8** In the Rule Match field, choose an existing class map or click **\*New\*** to specify new match criteria, and do one of the following:
- If you chose an existing class map, you can view, modify, or duplicate the existing configuration. See the “[Shared Objects and Virtual Servers](#)” section on page 7-9 for more information about modifying shared objects.
  - If you click **\*New\***, the window refreshes so that you can enter new match criteria.
- Step 9** Configure match criteria using the information in [Table 7-16](#).

**Table 7-16** Optimization Match Criteria Configuration

| Field | Description/Action                        |
|-------|-------------------------------------------|
| Name  | Unique name for this match criteria rule. |

**Table 7-16 Optimization Match Criteria Configuration (continued)**

| Field      | Description/Action                                                                                                                                                                                                                                                                                                                                                                                                                                                                                                                    |
|------------|---------------------------------------------------------------------------------------------------------------------------------------------------------------------------------------------------------------------------------------------------------------------------------------------------------------------------------------------------------------------------------------------------------------------------------------------------------------------------------------------------------------------------------------|
| Match      | Method to be used to evaluate multiple match statements when multiple match conditions exist: <ul style="list-style-type: none"> <li>• <b>match-any</b>—A match exists if at least one of the match conditions is satisfied.</li> <li>• <b>match-all</b>—A match exists only if all match conditions are satisfied.</li> </ul>                                                                                                                                                                                                        |
| Conditions | Field that allows you to add a new set of conditions or choose an existing entry. Click <b>Add</b> to add a new set of conditions, or choose an existing entry and click <b>Edit</b> to modify it: <ol style="list-style-type: none"> <li>In the Type field, choose the match condition to be used, then configure any condition-specific options using the information in <a href="#">Table 7-12</a>.</li> <li>Click <b>OK</b> to save your entries, or <b>Cancel</b> to exit this procedure without saving your entries.</li> </ol> |

- Step 10** In the Actions field, choose an existing action list to use for optimization or click **\*New\*** to create a new action list, and do one of the following:
- If you chose an existing action list, you can view, modify, or duplicate the existing configuration. See the “[Shared Objects and Virtual Servers](#)” section on [page 7-9](#) for more information about modifying shared objects.
  - If you click **\*New\***, the window refreshes so you can configure an action list.
- Step 11** Configure the action list using the information in [Table 7-17](#).

**Table 7-17 Optimization Action List Configuration Options**

| Field            | Description                                                                                                                                                                                                                                                                                                                                                                                                                                                    |
|------------------|----------------------------------------------------------------------------------------------------------------------------------------------------------------------------------------------------------------------------------------------------------------------------------------------------------------------------------------------------------------------------------------------------------------------------------------------------------------|
| Action List Name | Unique name for the action list. Valid entries are unquoted text strings with a maximum of 64 alphanumeric characters.                                                                                                                                                                                                                                                                                                                                         |
| Enable Delta     | Check box that enables delta optimization for the specified URLs. Delta optimization that dynamically updates client browser caches directly with content differences, or deltas, resulting in faster page downloads.<br>Uncheck the check box to disable this feature.<br>If you are configuring optimization without a building block, additional options appear. Configure these options using the information in <a href="#">Table 7-18</a> .              |
| Enable AppScope  | Check box that enables AppScope performance monitoring for use with the ACE appliance. AppScope runs on the Management Console of the optional Cisco AVS 3180A Management Station and measures end-to-end application performance.<br>Uncheck the check box to disable this feature.<br>If you are configuring optimization without a building block, additional options appear. Configure these options using the information in <a href="#">Table 7-18</a> . |

Table 7-17 Optimization Action List Configuration Options (continued)

| Field              | Description                                                                                                                                                                                                                                                                                                                                                                                                                                                                                                                                                                                                                                                                                                                                                                                                                                                                                                                                               |
|--------------------|-----------------------------------------------------------------------------------------------------------------------------------------------------------------------------------------------------------------------------------------------------------------------------------------------------------------------------------------------------------------------------------------------------------------------------------------------------------------------------------------------------------------------------------------------------------------------------------------------------------------------------------------------------------------------------------------------------------------------------------------------------------------------------------------------------------------------------------------------------------------------------------------------------------------------------------------------------------|
| Flash Forward      | <p>Feature that reduces bandwidth usage and accelerates embedded object downloading by combining local object storage with dynamic renaming of embedded objects, which enforces object freshness within the parent HTML page.</p> <p>Choose how the ACE appliance is to implement FlashForward:</p> <ul style="list-style-type: none"> <li>• <b>N/A</b>—This feature is not enabled.</li> <li>• <b>Flash Forward</b>—FlashForward is to be enabled for the specified URLs and embedded objects are to be transformed.</li> <li>• <b>Flash Forward Object</b>—FlashForward static caching is to be enabled for the objects that the corresponding URLs refer to, such as Cascading Style Sheets (CSS), JPEG, and GIF files.</li> </ul> <p>If you are configuring without a building block and chose either FlashForward or FlashForward Object, an addition option appears. Configure this option using the information in <a href="#">Table 7-18</a>.</p> |
| Cache Dynamic      | <p>Check box that enables Adaptive Dynamic Caching for the specified URLs even if the expiration settings in the response indicate that the content is dynamic. The expiration of cache objects is controlled by the cache expiration settings based on time or server load.</p> <p>Uncheck the check box to disable this feature.</p>                                                                                                                                                                                                                                                                                                                                                                                                                                                                                                                                                                                                                    |
| Cache Forward      | <p>Field that specifies how the ACE appliance is to implement cache forwarding:</p> <ul style="list-style-type: none"> <li>• <b>N/A</b>—This feature is not enabled.</li> <li>• <b>With Wait</b>—Cache forwarding is enabled with the wait option for the specified URLs. If the object has expired but the maximum cache TTL time period has not yet expired, the ACE appliance sends a request to the origin server for the object. Users requesting this page continue to receive content from the cache during this time but must wait for the object to be updated before their request is satisfied. When the fresh object is returned, it is sent to the requesting user and the cache is updated.</li> <li>• <b>Without Wait</b>—Cache forwarding is enabled without the wait option.</li> </ul>                                                                                                                                                  |
| Dynamic Entity Tag | <p>Check box that specifies that the ACE appliance is to implement just-in-time object acceleration for embedded objects not able to be cached. This feature enables the acceleration of embedded objects not able to be cached, which results in improved application response time. When enabled, this feature eliminates the need for users to download objects not able to be cached on each request.</p> <p>Uncheck the check box to disable this feature.</p>                                                                                                                                                                                                                                                                                                                                                                                                                                                                                       |

**Step 12** (Optional) If you are configuring optimization without a building block, additional options appear when you enable specific features.

Configure the additional options using the information in [Table 7-18](#).

**Table 7-18 Application Acceleration and Optimization Additional Configuration Options**

| Field                                           | Description                                                                                                                                                                                                                                                                                                                                                                                                                                                                                                                                                                                                                                                                                                                                                                                                                                    |
|-------------------------------------------------|------------------------------------------------------------------------------------------------------------------------------------------------------------------------------------------------------------------------------------------------------------------------------------------------------------------------------------------------------------------------------------------------------------------------------------------------------------------------------------------------------------------------------------------------------------------------------------------------------------------------------------------------------------------------------------------------------------------------------------------------------------------------------------------------------------------------------------------------|
| Response Codes To Ignore (Comma Separated)      | Comma-separated list of HTTP response codes for which the response body must not be read. For example, an entry of 302 indicates that the ACE is to ignore the response body of a 302 (redirect) response from the origin server. Valid entries are unquoted text strings with a maximum of 64 alphanumeric characters.                                                                                                                                                                                                                                                                                                                                                                                                                                                                                                                        |
| Set Browse Freshness Period                     | Method that the ACE is to use to determine the freshness of objects in the client's browser: <ul style="list-style-type: none"> <li>• <b>N/A</b>—This option is not configured.</li> <li>• <b>Disable Browser Object Freshness Control</b>—Browser freshness control is not to be used.</li> <li>• <b>Set Freshness Similar To Flash Forward Objects</b>—The ACE is to set freshness similar to that used for FlashForwarded objects, and to use the values specified in the <i>Maximum Time for Cache Time-To-Live</i> and <i>Minimum Time For Cache Time-To-Live</i> fields.</li> </ul>                                                                                                                                                                                                                                                      |
| Duration For Browser Freshness (Seconds)        | Field that appears if the Set Browser Freshness Period option is not configured.<br>Enter the number of seconds that objects in the client's browser are considered fresh. Valid entries are 0 to 2147483647 seconds.                                                                                                                                                                                                                                                                                                                                                                                                                                                                                                                                                                                                                          |
| <b>Enable Delta Options</b>                     |                                                                                                                                                                                                                                                                                                                                                                                                                                                                                                                                                                                                                                                                                                                                                                                                                                                |
| Max. For Post Data To Scan For Logging (kBytes) | Maximum number of kilobytes of POST data the ACE is to scan for parameters for the purpose of logging transaction parameters in the statistics log.<br>Valid entries are 0 to 1000 KB.                                                                                                                                                                                                                                                                                                                                                                                                                                                                                                                                                                                                                                                         |
| Base File Anonymous Level                       | Feature that enables the ACE to create and deliver condensed base files that contain only information that is common to a large set of users. No information unique to a particular user, or across a very small subset of users, is included in anonymous base files.<br><br>Information that is common to a large set of users is generally not confidential or user-specific. Conversely, information that is unique to a specific user or a small set of users is generally confidential or user-specific.<br><br>Enter the value for base file anonymity for the all-user condensation method. Valid entries are from 0 to 50; the default value of 0 disables the base file anonymity feature.                                                                                                                                           |
| Cache-Key Modifier Expression                   | Unique identifier that is used to identify a cached object to be served to a client, replacing a trip to the origin server. The cache key modifier feature allows you to modify the canonical form of a URL; that is, the portion before “?” in a URL. For example, the canonical URL of <code>http://www.xyz.com/somepage.asp?action=browse&amp;level=2</code> is <code>http://www.xyz.com/somepage.asp</code> .<br><br>Enter a regular expression containing embedded variables as described in <a href="#">Table 7-19</a> . The ACE transforms URLs specified in class maps for this virtual server with the expression and variable entered here.<br><br>Valid entries are unquoted text strings with no spaces and a maximum of 255 alphanumeric characters. If the string includes spaces, enclose the string with quotation marks (“”). |

**Table 7-18 Application Acceleration and Optimization Additional Configuration Options (continued)**

| Field                                                | Description                                                                                                                                                                                                                                                                                                                                                                                                                                                                                                                                                                                                                                                                                                                                                    |
|------------------------------------------------------|----------------------------------------------------------------------------------------------------------------------------------------------------------------------------------------------------------------------------------------------------------------------------------------------------------------------------------------------------------------------------------------------------------------------------------------------------------------------------------------------------------------------------------------------------------------------------------------------------------------------------------------------------------------------------------------------------------------------------------------------------------------|
| Min. Time For Cache Time-To-Live (Seconds)           | <p>Minimum number of seconds that an object without an explicit expiration time should be considered fresh in the ACE cache. This value specifies the minimum time that content can be cached. If the ACE is configured for FlashForward optimization, this value should normally be 0. If the ACE is configured for dynamic caching, this value should indicate how long the ACE should cache the page. (See <a href="#">Table 7-17</a> for information about these configuration options.)</p> <p>Valid entries are 0 to 2147483647 seconds.</p>                                                                                                                                                                                                             |
| Max. Time For Cache Time-To-Live (Seconds)           | <p>Maximum number of seconds that an object without an explicit expiration time should be considered fresh in the ACE cache. Valid entries are 0 to 2147483647 seconds.</p>                                                                                                                                                                                                                                                                                                                                                                                                                                                                                                                                                                                    |
| Cache Time-To-Live Duration (%)                      | <p>Percent of an object's age at which an embedded object without an explicit expiration time is considered fresh.</p> <p>Valid entries are 0 to 100 percent.</p>                                                                                                                                                                                                                                                                                                                                                                                                                                                                                                                                                                                              |
| Expression To Modify Cache Key Query Parameter       | <p>Feature that allows you to modify the query parameter of a URL; that is, the portion after "?" in a URL. For example, the query parameter portion of <code>http://www.xyz.com/somepage.asp?action=browse&amp;level=2</code> is <code>action=browse&amp;level=2</code>.</p> <p>Enter a regular expression containing embedded variables as described in <a href="#">Table 7-19</a>. The ACE transforms URLs specified in class maps for this virtual server with the expression and variable entered here. If no string is specified, the query parameter portion of the URL is used as the default value for this portion of the cache key.</p> <p>Valid entries are unquoted text strings with no spaces and a maximum of 255 alphanumeric characters.</p> |
| Canonical URL Expressions                            | <p>Canonical URL feature to eliminate the "?" and any characters that follow to identify the general part of the URL. This general URL is then used to create the base file. In this way, the ACE maps multiple URLs to a single canonical URL.</p> <p>Enter a comma-separated list of parameter expander functions as defined in <a href="#">Table 7-19</a> to identify the URLs to associate with this parameter map.</p> <p>Valid entries are unquoted text strings with a maximum of 255 alphanumeric characters.</p>                                                                                                                                                                                                                                      |
| Enable Cacheable Content Optimization                | <p>Check box that enables delta optimization of content that can be cached. This feature allows the ACE to detect content that can be cached and perform delta optimization on it.</p> <p>Uncheck the check box to disable this feature.</p>                                                                                                                                                                                                                                                                                                                                                                                                                                                                                                                   |
| Enable Delta Optimization On First Visit To Web Page | <p>Check box that enables condensation on the first visit to a Web page. Uncheck the check box to disable this feature.</p>                                                                                                                                                                                                                                                                                                                                                                                                                                                                                                                                                                                                                                    |
| Min. Page Size For Delta Optimization (Bytes)        | <p>Minimum page size, in bytes, that can be condensed. Valid entries are from 1 to 250000 bytes.</p>                                                                                                                                                                                                                                                                                                                                                                                                                                                                                                                                                                                                                                                           |
| Max. Page Size For Delta Optimization (Bytes)        | <p>Maximum page size, in bytes, that can be condensed. Valid entries are from 1 to 250000 bytes.</p>                                                                                                                                                                                                                                                                                                                                                                                                                                                                                                                                                                                                                                                           |



**Table 7-18** Application Acceleration and Optimization Additional Configuration Options (continued)

| Field                                          | Description                                                                                                                                                                                                                                                                                                                                                                                                                                                                                                                                             |
|------------------------------------------------|---------------------------------------------------------------------------------------------------------------------------------------------------------------------------------------------------------------------------------------------------------------------------------------------------------------------------------------------------------------------------------------------------------------------------------------------------------------------------------------------------------------------------------------------------------|
| Set Default Client Script                      | Scripting language that the ACE is to recognize on condensed content pages: <ul style="list-style-type: none"> <li>• <b>N/A</b>—Indicates that this option is not configured.</li> <li>• <b>Javascript</b>—Indicates that the default scripting language is JavaScript.</li> <li>• <b>Visual Basic Script</b>—Indicates that the default scripting language is Visual Basic.</li> </ul>                                                                                                                                                                 |
| Exclude Iframes From Delta Optimization        | Check box to specify that delta optimization is not to be applied to IFrames (inline frames). Uncheck the check box to indicate that delta optimization is to be applied to IFrames.                                                                                                                                                                                                                                                                                                                                                                    |
| Exclude Non-ASCII Data From Delta Optimization | Check box to specify that delta optimization is not to be applied to non-ASCII data. Uncheck the check box to indicate that delta optimization is to be applied to non-ASCII data.                                                                                                                                                                                                                                                                                                                                                                      |
| Exclude JavaScripts From Delta Optimization    | Check box to specify that delta optimization is not to be applied to JavaScript. Uncheck the check box to indicate that delta optimization is to be applied to JavaScript.                                                                                                                                                                                                                                                                                                                                                                              |
| MIME Types To Exclude From Delta Optimization  | <ol style="list-style-type: none"> <li>In the first field, enter a comma-separated list of the MIME (Multipurpose Internet Mail Extension) type messages that are not to have delta optimization applied, such as image/Jpeg, text/html, application/msword, or audio/mpeg. See the “<a href="#">Supported MIME Types</a>” section on page 10-26 for a list of supported MIME types.</li> <li>Click <b>Add</b> to add the entry to the list box on the right. You can position the entries in the list box by using the Up and Down buttons.</li> </ol> |
| Remove HTML META Elements From Documents       | Check box to specify that HTML META elements are to be removed from documents to prevent them from being condensed. Uncheck the check box to indicate that HTML META elements are not to be removed from documents.                                                                                                                                                                                                                                                                                                                                     |
| Rebase Delta Optimization Threshold (%)        | Delta threshold, expressed as a percent, when rebasing is to be triggered. This entry represents the size of a page delta relative to total page size, expressed as a percent. This entry triggers rebasing when the delta response size exceeds the threshold as a percentage of base file size.<br>Valid entries are 0 to 10000 percent.                                                                                                                                                                                                              |
| Rebase Flash Forward Threshold (%)             | Threshold, expressed as a percent, when rebasing is to be triggered based on the percent of FlashForwarded URLs in the response. This entry triggers rebasing when the difference between the percentages of FlashForwarded URLs in the delta response and the base file exceeds the threshold.<br>Valid entries are 0 to 10000 percent.                                                                                                                                                                                                                |
| Rebase History Size (Pages)                    | Number of pages to be stored before the ACE resets all rebase control parameters to zero and starts over. This option prevents the base file from becoming too rigid.<br>Valid entries are 10 to 2147483647.                                                                                                                                                                                                                                                                                                                                            |
| Rebase Modify Cool-Off Period (Seconds)        | Number of seconds after the last modification before performing a rebase.<br>Valid entries are 1 to 14400 seconds (4 hours).                                                                                                                                                                                                                                                                                                                                                                                                                            |
| Rebase Reset Period (Seconds)                  | Period of time, in seconds, for performing a meta data refresh.<br>Valid entries are 1 to 900 seconds (15 minutes).                                                                                                                                                                                                                                                                                                                                                                                                                                     |

**Table 7-18 Application Acceleration and Optimization Additional Configuration Options (continued)**

| Field                               | Description                                                                                                                                                                                                                                                                                                                                                                                                                                                                                                                                                                                                                                                                                                                                                                                                                                                                                                                                                                                                                                                                    |
|-------------------------------------|--------------------------------------------------------------------------------------------------------------------------------------------------------------------------------------------------------------------------------------------------------------------------------------------------------------------------------------------------------------------------------------------------------------------------------------------------------------------------------------------------------------------------------------------------------------------------------------------------------------------------------------------------------------------------------------------------------------------------------------------------------------------------------------------------------------------------------------------------------------------------------------------------------------------------------------------------------------------------------------------------------------------------------------------------------------------------------|
| UTF-8 Character Set Threshold       | <p>Number of 8-bit Unicode Transformation Format (UTF-8) characters that need to appear on a page to create a UTF-8 character set page. The UTF-8 character set is an international standard that allows Web pages to display non-ASCII or non-English multibyte characters. It can represent any universal character in the Unicode standard and is backwards compatible with ASCII.</p> <p>Valid entries are from 1 to 1,000,000.</p>                                                                                                                                                                                                                                                                                                                                                                                                                                                                                                                                                                                                                                        |
| Server Load Threshold Trigger (%)   | <p>Threshold, expressed as a percent, at which the TTL for cached objects is to be changed. The server load threshold trigger indicates that the time-to-live (TTL) period for cached objects is to be based dynamically on server load. With this method, TTL periods increase if the current response time from the origin sever is greater than the average response time and decrease if the current response time from the origin server is less than the average response time when the difference in response times exceeds a specified threshold amount.</p> <p>Valid entries are from 0 to 100 percent.</p>                                                                                                                                                                                                                                                                                                                                                                                                                                                           |
| Server Load Time-To-Live Change (%) | <p>Percentage by which the cache TTL is to be increased or decreased when the server load threshold trigger is met. This option specifies the percentage by which the cache TTL is increased or decreased in response to a change in server load. For example, if this value is set to 20 and the current TTL for a response is 300 seconds, and if the current server response times exceeds the trigger threshold, the cache TTL for the response is raised to 360 seconds.</p> <p>Valid entries are from 0 to 100 percent.</p>                                                                                                                                                                                                                                                                                                                                                                                                                                                                                                                                              |
| Delta Optimization Mode             | <p>Method by which delta optimization is to be implemented:</p> <ul style="list-style-type: none"> <li>• <b>N/A</b>—Indicates that a delta optimization mode is not configured.</li> <li>• <b>Enable The All-User Mode For Delta Optimization</b>—Indicates that the ACE is to generate the delta against a single base file that is shared by all users of the URL. This option is usable in most cases if the structure of a page is common across all users, and the disk space overhead is minimal.</li> <li>• <b>Enable The Per-User Mode For Delta Optimization</b>—Indicates that the ACE is to generate the delta against a base file that is created specifically for that user. This option is useful when page contents, including layout elements, are different for each user, and delivers the highest level of condensation. However, this increases disk space requirements because a copy of the base page that is delivered to each user is cached. This option is useful when privacy is required because base pages are not shared among users.</li> </ul> |
| <b>Enable Appscope Options</b>      |                                                                                                                                                                                                                                                                                                                                                                                                                                                                                                                                                                                                                                                                                                                                                                                                                                                                                                                                                                                                                                                                                |
| Appscope Optimize Rate (%)          | <p>Percentage of all requests or sessions to be sampled for performance with acceleration (or optimization) applied. All applicable optimizations for the class will be performed. Valid entries are from 0 to 100 percent, with a default of 10 percent. The sum of this value and the value entered in the Passthrough Rate Percent field must not exceed 100.</p>                                                                                                                                                                                                                                                                                                                                                                                                                                                                                                                                                                                                                                                                                                           |
| Appscope Passthrough Rate (%)       | <p>Percentage of all requests or sessions to be sampled for performance without optimization. No optimizations for the class will be performed. Valid entries are from 0 to 100, with a default of 10 percent. The sum of this value and the value entered in the Optimize Rate Percent field must not exceed 100.</p>                                                                                                                                                                                                                                                                                                                                                                                                                                                                                                                                                                                                                                                                                                                                                         |

**Table 7-18** Application Acceleration and Optimization Additional Configuration Options (continued)

| Field                                        | Description                                                                                                                                                                                                                                                                                                                                                                                                                                                                                                                                                                                                                                                                                                 |
|----------------------------------------------|-------------------------------------------------------------------------------------------------------------------------------------------------------------------------------------------------------------------------------------------------------------------------------------------------------------------------------------------------------------------------------------------------------------------------------------------------------------------------------------------------------------------------------------------------------------------------------------------------------------------------------------------------------------------------------------------------------------|
| Max Number For Parameter Summary Log (Bytes) | Maximum number of bytes that are to be logged for each parameter value in the parameter summary of a transaction log entry in the statistics log. If a parameter value exceeds this limit, it is truncated at the specified limit. Valid entries are 0 to 10,000 bytes.                                                                                                                                                                                                                                                                                                                                                                                                                                     |
| Specify String For Grouping Requests         | <p>String that the ACE is to use to sort requests for AppScope reporting. The string can contain a URL regular expression that defines a set of URLs in which URLs that differ only by their query parameters are to be treated as separate URLs in AppScope reports.</p> <p>For example, to define a string that is used to identify the URLs <code>http://server/catalog.asp?region=asia</code> and <code>http://server/catalog.asp?region=america</code> as two separate reporting categories, you would enter <b><code>http_query_param(region)</code></b>.</p> <p>Valid entries contain 1 to 255 characters and can contain the parameter expander functions listed in <a href="#">Table 7-19</a>.</p> |

[Table 7-19](#) lists the parameter expander functions that you can use.

**Table 7-19** Parameter Expander Functions

| Variable                           | Description                                                                                                                                                                                                                                                                                                                                                                                                                                                                                                                                                                                                                                                                                                                                                                                                                                                                                                                                                                            |
|------------------------------------|----------------------------------------------------------------------------------------------------------------------------------------------------------------------------------------------------------------------------------------------------------------------------------------------------------------------------------------------------------------------------------------------------------------------------------------------------------------------------------------------------------------------------------------------------------------------------------------------------------------------------------------------------------------------------------------------------------------------------------------------------------------------------------------------------------------------------------------------------------------------------------------------------------------------------------------------------------------------------------------|
| <code>\$(number)</code>            | <p>Expands to the corresponding matching subexpression (by <i>number</i>) in the URL pattern. Subexpressions are marked in a URL pattern using parentheses (). The numbering of the subexpressions begins with 1 and is the number of the left-parenthesis “(“ counting from the left. You can specify any positive integer for the number. <code>\$(0)</code> matches the entire URL. For example, if the URL pattern is <code>((http://server/.*)(.*/)a.jsp</code>, and the URL that matches it is <code>http://server/main/sub/a.jsp?category=shoes&amp;session=99999</code>, then the following are correct:</p> <p><code>\$(0)</code> = <code>http://server/main/sub/a.jsp</code><br/> <code>\$(1)</code> = <code>http://server/main/sub/</code><br/> <code>\$(2)</code> = <code>http://server/main</code><br/> <code>\$(3)</code> = <code>sub</code></p> <p>If the specified subexpression does not exist in the URL pattern, then the variable expands to the empty string.</p> |
| <code>\$http_query_string()</code> | <p>Expands to the value of the whole query string in the URL. For example, if the URL is <code>http://myhost/dohis?param1=value1&amp;param2=value2</code>, then the following is correct:</p> <p><code>\$http_query_string()</code> = <code>param1=value1&amp;param2=value2</code></p> <p>This function applies to both GET and POST requests.</p>                                                                                                                                                                                                                                                                                                                                                                                                                                                                                                                                                                                                                                     |

Table 7-19 Parameter Expander Functions (continued)

| Variable                                                                                                                                                                                                                                                                                                                                                                                                                                                                                                            | Description                                                                                                                                                                                                                                                                                                                                                                                                                                                                                       |
|---------------------------------------------------------------------------------------------------------------------------------------------------------------------------------------------------------------------------------------------------------------------------------------------------------------------------------------------------------------------------------------------------------------------------------------------------------------------------------------------------------------------|---------------------------------------------------------------------------------------------------------------------------------------------------------------------------------------------------------------------------------------------------------------------------------------------------------------------------------------------------------------------------------------------------------------------------------------------------------------------------------------------------|
| <p><code>\$http_query_param(query-param-name)</code></p> <p>The obsolete syntax is also supported:<br/><code>\$param(query-param-name)</code></p>                                                                                                                                                                                                                                                                                                                                                                   | <p>Expands to the value of the named query parameter (case-sensitive). For example, if the URL is <code>http://server/main/sub/a.jsp?category=shoes&amp;session=99999</code>, then the following are correct:</p> <pre>\$http_query_param(category) = shoes \$http_query_param(session) = 99999</pre> <p>If the specified parameter does not exist in the query, then the variable expands to the empty string. This function applies to both GET and POST requests.</p>                          |
| <code>\$http_cookie(cookie-name)</code>                                                                                                                                                                                                                                                                                                                                                                                                                                                                             | Evaluates to the value of the named cookie. For example, <code>\$http_cookie(cookiexyz)</code> . The cookie name is case-sensitive.                                                                                                                                                                                                                                                                                                                                                               |
| <code>\$http_header(request-header-name)</code>                                                                                                                                                                                                                                                                                                                                                                                                                                                                     | Evaluates to the value of the specified HTTP request header. In the case of multivalued headers, it is the single representation as specified in the HTTP specification. For example, <code>\$http_header(user-agent)</code> . The HTTP header name is not case-sensitive.                                                                                                                                                                                                                        |
| <code>\$http_method()</code>                                                                                                                                                                                                                                                                                                                                                                                                                                                                                        | Evaluates to the HTTP method used for the request, such as GET or POST.                                                                                                                                                                                                                                                                                                                                                                                                                           |
| <p>Boolean Functions:</p> <p><code>\$http_query_param_present(query-param-name)</code><br/> <code>\$http_query_param_notpresent(query-param-name)</code><br/> <code>\$http_cookie_present(cookie-name)</code><br/> <code>\$http_cookie_notpresent(cookie-name)</code><br/> <code>\$http_header_present(request-header-name)</code><br/> <code>\$http_header_notpresent(request-header-name)</code><br/> <code>\$http_method_present(method-name)</code><br/> <code>\$http_method_notpresent(method-name)</code></p> | <p>Evaluates to a Boolean value: True or False, depending on the presence or absence of the element in the request. The elements are a specific query parameter (<i>query-param-name</i>), a specific cookie (<i>cookie-name</i>), a specific request header (<i>request-header-name</i>), or a specific HTTP method (<i>method-name</i>). All identifiers are case-sensitive except for the HTTP request header name.</p>                                                                        |
| <code>\$regex_match(param1, param2)</code>                                                                                                                                                                                                                                                                                                                                                                                                                                                                          | <p>Evaluates to a Boolean value: True if the two parameters match and False if they do not match. The two parameters can be any two expressions, including regular expressions, that evaluate to two strings. For example, this function:</p> <pre>\$regex_match(\$http_query_param(URL), .*Store\.asp.*)</pre> <p>compares the query URL with the regular expression string <code>.*Store\.asp.*</code>.</p> <p>If the URL matches this regular expression, this function evaluates to True.</p> |

- Step 13** When you finish configuring match criteria and actions, do one of the following:
- Click **OK** to save your entries and to return to the Rule Match and Actions table.
  - Click **Cancel** to exit this procedure without saving your entries and to return to the Rule Match and Actions table.
- Step 14** When you finish configuring virtual server properties, do one of the following:
- Click **Deploy Now** to deploy this configuration on the ACE and save your entries to the running-configuration and startup-configuration files. The ACE appliance validates the action list configuration and deploys it.
  - Click **Cancel** to exit this procedure without saving your entries and to return to the Virtual Servers table.
  - Click **Deploy Later** to save your entries and apply the configuration at a later time.
- 

#### Related Topics

- [Optimization Traffic Policies and Typical Configuration Flow, page 15-2](#)
- [Configuring Traffic Policies for HTTP Optimization, page 15-6](#)
- [Configuring Virtual Server Protocol Inspection, page 7-18](#)
- [Configuring Virtual Server Layer 7 Load Balancing, page 7-30](#)
- [Configuring Virtual Server Default Layer 7 Load Balancing, page 7-50](#)

## Configuring Virtual Server NAT

You can configure Name Address Translation (NAT) for virtual servers.

#### Assumptions

This topic assumes the following:

- Make sure that a virtual server has been configured in the Properties configuration subset. For more information, see the “[Configuring Virtual Server Properties](#)” section on page 7-11
- Make sure that a VLAN has been configured. See the “[Configuring Virtual Context VLAN Interfaces](#)” section on page 12-6 for information on configuring a VLAN interface.
- Make sure that at least one NAT pool has been configured on a VLAN interface. See the “[Configuring VLAN Interface NAT Pools](#)” section on page 12-26 for information on configuring a NAT pool.

#### Procedure

---

- Step 1** Choose **Config > Devices > context > Load Balancing > Virtual Servers**.  
The Virtual Servers table appears.
- Step 2** In the Virtual Servers table, choose the virtual server you want to configure for NAT, and click **Edit**.  
The Virtual Server configuration window appears.
- Step 3** In the Virtual Server configuration window, click **NAT**.  
The NAT table appears.

- Step 4** In the NAT table, click **Add** to add an entry, or choose an existing entry and click **Edit** to modify it.
- Step 5** In the VLAN drop-down list, choose the VLAN that you want to use for NAT.  
VLANs that have previously been defined for NAT do not appear in this list. VLAN numbers provide an indication of available NAT pools.
- Step 6** In the NAT Pool ID drop-down list, choose the NAT pool that you want to associate with the selected VLAN.

Note the following about the NAT pool ID selections:

NAT Pool IDs (Begin IP - End IP: Netmask: PAT) appear in a format that provides the details of the beginning and ending IP address range, netmask, and the PAT enabled or disabled setting. For example:

```
2 (10.77.241.2 - 10.77.241.15: 255.255.255.192: PAT Enabled).
```

If the NAT pool had previously been associated but is no longer defined, then it appears as “<NAT\_POOL\_ID> (Warning: Undefined NAT Pool)”. For example:

```
2 (Warning: Undefined NAT Pool)
```

For more information about NAT pools, see the “[Configuring VLAN Interface NAT Pools](#)” section on [page 12-26](#).

- Step 7** Do one of the following:
- Click **OK** to save your entries and to return to the NAT table. The NAT table refreshes with the new entry.
  - Click **Cancel** to exit the procedure without saving your entries and to return to the NAT table.
- Step 8** When you finish configuring virtual server properties, do one of the following:
- Click **Deploy Now** to deploy this configuration on the ACE and save your entries to the running-configuration and startup-configuration files.
  - Click **Cancel** to exit this procedure without saving your entries and to return to the Virtual Servers table.
  - Click **Deploy Later** to save your entries and apply the configuration at a later time.

---

#### Related Topics

- [Configuring Virtual Servers, page 7-2](#)
- [Configuring Virtual Server Properties, page 7-11](#)
- [Configuring Virtual Server SSL Termination, page 7-17](#)
- [Configuring Virtual Server Protocol Inspection, page 7-18](#)
- [Configuring Virtual Server Layer 7 Load Balancing, page 7-30](#)
- [Configuring Virtual Server Default Layer 7 Load Balancing, page 7-50](#)

## Displaying Virtual Servers by Context

You can display all virtual servers associated with a virtual context.

### Procedure

- 
- Step 1** Choose **Config > Devices**.  
The device tree appears.
- Step 2** In the device tree, choose the context associated with the virtual servers that you want to display, and choose **Load Balancing > Virtual Servers**.  
[Table 7-20](#) describes the information that displays.

**Table 7-20** *Virtual Servers Window*

| Field             | Description                                                                  |
|-------------------|------------------------------------------------------------------------------|
| Name              | Virtual server name.                                                         |
| Configured State  | Current configured state, such as In Service or Out Of Service.              |
| Operational State | Current operating state (if known), such as In Service or Out Of Service.    |
| Last Polled       | Date and time that ANM last polled the virtual server for backup statistics. |
| VIP Address       | Virtual server IP address.                                                   |
| Port              | Port that the virtual server uses for TCP or UDP.                            |
| VLANs             | Associated VLANs.                                                            |
| Server Farms      | Associated server farms.                                                     |
| Owner             | Owner and context in which the virtual server was created                    |

---

### Related Topics

- [Configuring Virtual Servers, page 7-2](#)
- [Managing Virtual Servers, page 7-66](#)
- [Displaying Detailed Virtual Server Information, page 7-81](#)
- [Displaying Virtual Servers, page 7-81](#)

## Displaying Virtual Server Statistics and Status Information

You can display virtual server statistics and status information for a particular virtual server by using the **Details** button.

### Procedure

- 
- Step 1** Choose **Config > Devices > context > Load Balancing > Virtual Servers**.  
The Virtual Servers table appears.

**Step 2** From the Virtual Servers table, choose a virtual server and click **Details**.

A popup window appears that displays the **show service-policy** *policy\_name* **class-map** *class\_name* **detail** CLI command output. For details about the displayed fields, see either the *Cisco ACE Module Server Load-Balancing Configuration Guide* or the *Cisco ACE 4700 Series Appliance Server Load-Balancing Configuration Guide*.



**Note** This feature requires ACE module software Version A2(1.2), ACE appliance software Version A3(2.1), or later versions of either software. An error displays with earlier software versions.

**Step 3** Click **Update Details** to refresh the window information.

**Step 4** Click **Close** to return to the Virtual Servers table.

#### Related Topics

- [Configuring Virtual Servers, page 7-2](#)
- [Managing Virtual Servers, page 7-66](#)
- [Displaying Detailed Virtual Server Information, page 7-81](#)
- [Displaying Virtual Servers, page 7-81](#)

## Managing Virtual Servers

This section shows how to display and manage the virtual servers from the Virtual Servers window (Config > Operations > Virtual Servers). This window provides you with information about each virtual server configured on ANM (see the “[Displaying Virtual Servers](#)” section on page 7-81) and provides access to function buttons that allow you to perform tasks such as activate or suspend a virtual server, display a virtual server topology map, or display connection statistics graphs.

This section also shows how to display and manage GSS VIP answers (Config > Operations > GSS VIP Answers) and GSS DNS rules (Config > Operations > GSS DNS Rules).

#### Guidelines and Restrictions

The Virtual Servers, GSS VIP Answers, and GSS DNS Rules Operations windows contain a Rows per page option that includes an All setting for displaying all related configured items in one window. Use the All setting for viewing purposes only. ANM does not allow you to perform any operation from an Operations window if you have more than 200 items selected. For example, if you use the All option to display and select more than 200 virtual servers and then attempt to perform the suspend operation, ANM cancels the request and displays an error message.

This section includes the following topics:

- [Managing Virtual Server Groups, page 7-67](#)
- [Activating Virtual Servers, page 7-71](#)
- [Suspending Virtual Servers, page 7-72](#)
- [Managing GSS VIP Answers, page 7-73](#)
- [Activating and Suspending DNS Rules Governing GSS Load Balancing, page 7-75](#)
- [Managing GSS VIP Answer and DNS Rule Groups, page 7-76](#)



- [Displaying Detailed Virtual Server Information, page 7-81](#)
- [Displaying Virtual Servers, page 7-81](#)
- [Using the Virtual Server Connection Statistics Graph, page 7-84](#)
- [Using the Virtual Server Topology Map, page 7-85](#)
- [Understanding CLI Commands Sent from Virtual Server Table, page 7-86](#)

## Managing Virtual Server Groups

This section describes how to organize virtual servers into groups, which allows you to display and manage a specific group of virtual servers without having to filter the virtual server display. When creating a group, you specify whether the group is available to just you or is available globally to all ANM users.

The virtual server group feature is available from the virtual servers operations window (Config > Operations > Virtual Servers), which contains the Groups option for managing object groups. [Figure 7-1](#) shows the Groups icon with the following available options for managing object groups:

- Create New Group—Adds a new group.
- Edit Group—Modifies an existing group. This option displays only after you select a group to display in Group mode.
- Exit Group Mode—Changes the display from the group mode display to the display of all virtual servers. This option displays only after you select a group and the display enters the Group mode.
- Saved Groups—Lists the currently configured groups along with each group’s privilege level (local or global) and owner. From this view, you can choose a group to display or delete a group.

**Figure 7-1** Object Grouping for Virtual Servers

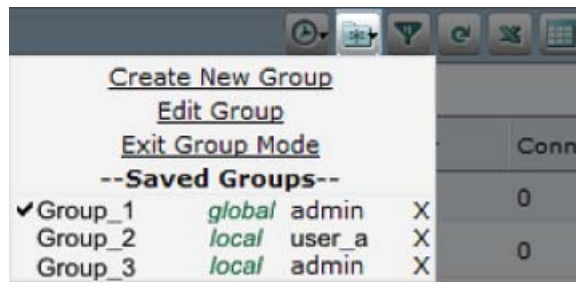

### Guidelines and Restrictions

Object grouping guidelines and restrictions are as follows:

- When you create a global group, other users can see the group if they have access to at least one object within the group. This rule does not apply to the admin user or a user with the anm-admin role because they have visibility to all global groups.
- To edit or delete a group, you must be the group owner, a user with the anm-admin role, or the admin user.
- When you delete a locally authenticated user from the ANM database, ANM deletes all the global and user-specific groups that the user created. However, when you delete a *remotely authorized* user from the remote AAA server database, ANM does not delete the groups that the user created. In this case, you must manually delete the user’s groups.

This section includes the following topics:

- [Creating a Virtual Server Group, page 7-68](#)
- [Editing or Copying a Virtual Server Group, page 7-69](#)
- [Displaying a Virtual Server Group, page 7-70](#)
- [Deleting a Virtual Server Group, page 7-70](#)

## Creating a Virtual Server Group

You can create a virtual server group.

### Procedure

- 
- Step 1** Choose **Config > Operations > Virtual Servers**.  
The Virtual Servers table appears.
- Step 2** Click the **Groups** icon located above the Virtual Servers table.  
The Groups menu appears below the icon (see [Figure 7-1](#)).
- Step 3** From the Groups menu, choose **Create New Group**.  
The display enters the edit mode and the Creating a New Group table appears with the list of the available virtual servers.
- Step 4** From the Creating a New Group table, check the check box next to the virtual servers that you want to include in the group.
- Step 5** (Optional) Check the **Hide unselected** check box to display only the virtual servers that you have chosen. Uncheck the check box to display all the available virtual servers.
- Step 6** Do one of the following:
- Click **Save as** to save the group information. The Create Group popup window appears.  
From the popup window, do the following:
    - a. In the Group Name text box, enter a name for the group. Enter 1 to 64 alphanumeric characters. Special characters and spaces are allowed.
    - b. Choose the availability of the group by clicking one of the following radio buttons:
      - **This user only (local)**—Only you can view, modify, or delete the group.
      - **All users (global)**—All ANM users can view the group if they have permission to view at least one of the virtual servers associated with the group. A user with the admin or anm-admin can view all groups and can also edit or delete any group.
    - c. Do one of the following:
      - Click **Save** to save the group information. The Create Group popup window closes and the Viewing Group table appears, displaying the new group's name and associated virtual servers.  
To exit Group mode and return to the Virtual Servers table, click the **Groups** icon and click **Exit Group Mode** from the Groups menu.
      - Click **Cancel** to close the Create Group popup window without saving any information and return to the Creating a New Group table.

- Click **Back to View** to exit the Group display mode and return to the Virtual Servers table.
- 

#### Related Topics

- [Managing Virtual Server Groups, page 7-67](#)
- [Editing or Copying a Virtual Server Group, page 7-69](#)
- [Displaying a Virtual Server Group, page 7-70](#)
- [Deleting a Virtual Server Group, page 7-70](#)

## Editing or Copying a Virtual Server Group

You can edit a virtual server group or create a copy of a virtual server group under a different name.

### Procedure

---

- Step 1** Choose **Config > Operations > Virtual Servers**.  
The Virtual Servers table appears.
- Step 2** Click the **Groups** icon located above the Virtual Servers table.  
The Groups menu appears below the icon (see [Figure 7-1](#)).
- Step 3** From the Groups menu, choose the group that you want to edit.  
The Viewing Group table appears, displaying the selected group's name and associated virtual servers.
- Step 4** Click the **Groups** icon again and from the Groups menu, choose **Edit Group**.  
The Editing Group table appears, displaying the complete list of available virtual servers with the virtual servers currently associated with the group highlighted and checked.
- Step 5** Modify the group as needed by adding (check) or removing (uncheck) virtual servers as needed. Skip this step if you only want to save a copy of the current group under a different name.
- Step 6** Do one of the following:
- Click **Save** to save the changes and return to the Viewing Group table, where you can view the changes.
  - Click **Save as** to save the configuration under a new group name. The Create Group popup window appears.  
From the popup window, do the following:
    - a. In the Group Name text box, enter a name for the group. Enter 1 to 64 alphanumeric characters. Special characters and spaces are allowed.
    - b. Choose the availability of the group by clicking one of the following radio buttons:
      - **This user only (local)**—Only you can view, modify, or delete the group.
      - **All users (global)**—All ANM users can view the group if they have permission to view at least one of the virtual servers associated with the group. The admin user or a user with the anm-admin role can view all global groups and can also edit or delete these groups.
    - c. Do one of the following:
      - Click **Save** to save the group information. The Create Group popup window closes and the Viewing Group table appears, displaying the new group's name and associated virtual servers.

- Click **Cancel** to close the Create Group popup window without saving any information and to return to the Creating a New Group table.

Click **Back to View** to exit the edit mode and return to the Group mode.

- Step 7** (Optional) To exit Group mode and return to the Virtual Servers table, click the **Groups** icon and click **Exit Group Mode** from the Groups menu.
- 

#### Related Topics

- [Managing Virtual Server Groups, page 7-67](#)
- [Creating a Virtual Server Group, page 7-68](#)
- [Displaying a Virtual Server Group, page 7-70](#)
- [Deleting a Virtual Server Group, page 7-70](#)

## Displaying a Virtual Server Group

You can display the list of virtual servers associated with a virtual server group.

#### Procedure

---

- Step 1** Choose **Config > Operations > Virtual Servers**.  
The Virtual Servers table appears.
- Step 2** Click the **Groups** icon located above the Virtual Servers table.  
The Groups menu appears below the icon (see [Figure 7-1](#)).
- Step 3** From the Groups menu, choose the group that you want to display.  
The Viewing Group table appears, displaying the selected group's name and associated virtual servers.
- Step 4** (Optional) To exit Group mode and return to the Virtual Servers table, click the **Groups** icon and click **Exit Group Mode** from the Groups menu.
- 

#### Related Topics

- [Managing Virtual Server Groups, page 7-67](#)
- [Creating a Virtual Server Group, page 7-68](#)
- [Editing or Copying a Virtual Server Group, page 7-69](#)
- [Deleting a Virtual Server Group, page 7-70](#)

## Deleting a Virtual Server Group

You can delete a virtual server group. Deleting a virtual server group does not delete the group's associated virtual servers from the ANM database.

### Procedure

---

- Step 1** Choose **Config > Operations > Virtual Servers**.  
The Virtual Servers table appears.
- Step 2** Click the **Groups** icon located above the Virtual Servers table.  
The Groups menu appears below the icon (see [Figure 7-1](#)).
- Step 3** From the Groups menu, click **X** (delete) next to the group that you want to delete.  
The Delete Group confirmation popup window appears.
- Step 4** From the Delete Group confirmation popup window, do one of the following:
- Click **Delete** to removes the virtual server group.
  - Click **Cancel** to ignore the deletion request.
- 

### Related Topics

- [Managing Virtual Server Groups, page 7-67](#)
- [Creating a Virtual Server Group, page 7-68](#)
- [Editing or Copying a Virtual Server Group, page 7-69](#)
- [Displaying a Virtual Server Group, page 7-70](#)

## Activating Virtual Servers

You can activate a virtual server.



### Note

A missing operation or Admin state on a CSM or CSS device most likely means that the community string was not enabled on those devices. If the community string is not enabled on a CSM or CSS device, and any kind of operation is performed on those devices, it will not succeed, and ANM will not provide any kind of indication.

- For CSM devices, you must enable the community string of the Catalyst 6500 series chassis.
  - For CSS devices, you must enable the community string of the CSS device itself.
- 

### Guidelines and Restrictions

ANM does not support CSM DNS virtual servers. If you create this type of virtual server, ANM issues an error message if you attempt to use ANM to activate or suspend it.

### Procedure

---

- Step 1** Choose **Config > Operations > Virtual Servers**.  
The Virtual Servers table appears.
- Step 2** (Optional) To display only the virtual servers of a specific virtual server group, do the following:
- a. Click the **Groups** icon located above the Virtual Servers table. The Groups menu appears below the icon (see [Figure 7-1](#)).

b. From the Groups menu, choose the group to display.

**Step 3** In the Virtual Servers table, choose the virtual server that you want to activate, and click **Activate**.

The server is activated and the window refreshes with updated information in the Configured State column.

#### Related Topics

- [Managing Virtual Servers, page 7-66](#)
- [Displaying Virtual Servers, page 7-81](#)
- [Suspending Virtual Servers, page 7-72](#)

## Suspending Virtual Servers

You can suspend a virtual server.



#### Note

A missing operation or Admin state on a CSM or CSS device most likely means that the community string was not enabled on those devices. If the community string is not enabled on a CSM or CSS device, and any kind of operation is performed on those devices, it will not succeed, and ANM will not provide any kind of indication.

- For CSM devices, you must enable the community string of the Catalyst 6500 series chassis.
- For CSS devices, you must enable the community string of the CSS device itself.

#### Guidelines and Restrictions

ANM does not support CSM DNS virtual servers. If you create this type of virtual server, ANM issues an error message if you attempt to use ANM to activate or suspend it.

#### Procedure

**Step 1** Choose **Config > Operations > Virtual Servers**.

The Virtual Servers table appears.

**Step 2** (Optional) To display only the virtual servers of a specific virtual server group, do the following:

- Click the **Groups** icon located above the Virtual Servers table. The Groups menu appears below the icon (see [Figure 7-1](#)).
- From the Groups menu, choose the group to display.

**Step 3** In the Virtual Servers table, choose the virtual server that you want to suspend, and click **Suspend**.

The Suspend Virtual Server window appears.

**Step 4** In the Reason field of the Suspend Virtual Server window, enter the reason for this action.

You might enter a trouble ticket, an order ticket, or a user message.



**Note** Do not enter a password in this field.

#### Related Topics

- [Managing Virtual Servers, page 7-66](#)
- [Displaying Virtual Servers, page 7-81](#)
- [Activating Virtual Servers, page 7-71](#)

## Managing GSS VIP Answers

This section describes how to manage GSS VIP answers. In a GSS network, the term *answers* refers to resources that respond to content queries. When you create an answer using the primary Global Site Selector Manager (PGSSM), you are simply identifying a resource on your GSS network to which queries can be directed and that can provide your user's D-proxy with the address of a valid host to serve their request.

Virtual IP (VIP) addresses associated with an SLB such as the Cisco CSS, Cisco CSM, Cisco IOS-compliant SLB, LocalDirector, or a Web server are types of answers that are specified in the ANM user interface in the GSS VIP Answers table found in ANM under Configuration > Operations. Use this procedure to poll, activate, or suspend GSS VIP answers.

#### Prerequisites

Make sure that you have established GSS VIP answers using the PGSSM.

#### Procedure

**Step 1** Choose **Config > Operations > GSS VIP Answers**.

The GSS Answers table appears. For a list of fields available, see [Table 7-21](#).

**Table 7-21** GSS Answer Table

| Field                           | Description                                                                                                                |
|---------------------------------|----------------------------------------------------------------------------------------------------------------------------|
| Multiple Row Selection Checkbox | Check box that selects all entries at the same time, or you can check line items individually.                             |
| IP Address                      | VIP answer IP address.                                                                                                     |
| Name                            | VIP answer name.                                                                                                           |
| Config State                    | VIP answer configured status.                                                                                              |
| PGSSM Oper State                | Operational status as shown on the primary GSS manager (PGSSM).                                                            |
| Answer Group                    | Answer group names to which the VIP answer belong.                                                                         |
| Location                        | Logical groupings for GSS resources that correspond to geographical entities such as a city, data center, or content site. |
| Device                          | Primary GSS device name on ANM.                                                                                            |
| PGSSM Time                      | Last operational status update time on the primary GSS.                                                                    |

- Step 2** (Optional) To display only the answers of a specific GSS VIP Answer group, do the following:
- a. Click the **Groups** icon located above the DNS Rules table. The Groups menu appears below the icon (see [Figure 7-1](#)).
  - b. From the Groups menu, choose the group to display.
- Step 3** In the GSS Answers table, check the check boxes to the left of the answers that you want to poll, activate, or suspend.
- Step 4** Do one of the following:
- Click **Active/Suspended** hyperlink to view the VIP answer details across the GSS node(s). A popup window appears listing all nodes associated with the VIP, operational state, hit count, and timestamp for each node.
  - Click **Poll Now** to query the chosen resource to verify it is still active.

**Note**

If you click **Poll Now** immediately after you click **Activate** or **Suspend**, you might not get the VIP answer operational status on the PGSSM that reflects your most recent configuration. It might be necessary to click Poll Now two or three times in succession to get an accurate result.

The ability of Cisco License Manager to update the VIP answer operational status and statistics accurately in detailed GSS statistics window might depend on the polling interval that has been configured on the GSS. The polling interval can be configured directly on the GSS device. (The default is 5 minutes.) Depending on the interval, it can take 5 minutes or more for the ANM server to show an accurate result.

- Click **Activate** to reactivate a GSS answer.
- Click **Suspend** to temporarily stop the GSS from using an associated answer.

If you clicked **Activate** or **Suspend**, a dialog box prompts for a Reason. Acceptable text consists of any characters or nothing at all.

- Step 5** Do one of the following:
- Click **Deploy Now** to complete Activation or Suspension.
  - Click **Cancel** to cancel the Activation or Suspension operation.

**Related Topics**

- [Managing GSS VIP Answer and DNS Rule Groups, page 7-76](#)
- [Information About Load Balancing, page 7-1](#)
- [Activating and Suspending DNS Rules Governing GSS Load Balancing, page 7-75](#)



## Activating and Suspending DNS Rules Governing GSS Load Balancing

You can activate or suspend DNS rules associated with your GSS VIP answers table. The DNS rules table in Configuration > Operations navigation tree specifies actions for the GSS to take when it receives a request from a known source (a member of a source address list) for a known hosted domain (a member of a domain list).

The DNS rule specifies which response (answer) is given to the requesting user's local DNS host (D-proxy) and how that answer is chosen. One of a variety of balance methods is used to determine the best response to the request, based on the status and load of the GSS host devices.

### Prerequisites

Make sure that you have established GSS VIP answers and DNS rules using the PGSSM.

### Procedure

**Step 1** Choose **Config > Operations > DNS Rules**.

The DNS Rules table appears. For a list of fields available, see [Table 7-22](#).

**Table 7-22** DNS Rules Table

| Field                           | Description                                                                                                                                                                                                                   |
|---------------------------------|-------------------------------------------------------------------------------------------------------------------------------------------------------------------------------------------------------------------------------|
| Multiple Row Selection Checkbox | Check box that selects all entries at the same time, or you can check line items individually.                                                                                                                                |
| Name                            | Name of the DNS rule.                                                                                                                                                                                                         |
| Source Address                  | Collection of IP addresses or address blocks for known client DNS proxies (or D-proxies).                                                                                                                                     |
| Domains                         | Domain list name containing one or more domain names that point to content for which the GSS is acting as the authoritative DNS server and for which you wish to use the GSS technology to balance traffic and user requests. |
| Config State                    | DNS rules configured status, either Active or Suspended.                                                                                                                                                                      |
| Answer Group                    | Lists of GSS resources that are candidates to respond to DNS queries received from a user for a hosted domain.                                                                                                                |
| Owner                           | Owner names, providing a simple way to organize and identify groups of related GSS resources.                                                                                                                                 |
| Device                          | Primary GSS device name on ANM.                                                                                                                                                                                               |
| PGSSM Time                      | Last operational status update time on the GSS.                                                                                                                                                                               |

**Step 2** (Optional) To display only the rules of a specific DNS Rules group, do the following:

- a. Click the **Groups** icon located above the DNS Rules table. The Groups menu appears below the icon (see [Figure 7-1](#)).
- b. From the Groups menu, choose the group to display.

**Step 3** In the DNS Rules table, check the checkbox to the left of the rules that you want to activate or suspend.

**Step 4** Click the **Activate** or **Suspend** button.

A dialog box prompts for a Reason. Acceptable text consists of any characters or none at all.

**Step 5** Do one of the following:

- Click **Deploy Now** to complete Activation or Suspension.

- Click **Cancel** to cancel the Activation or Suspension operation.

#### Related Topics

- [Managing GSS VIP Answer and DNS Rule Groups, page 7-76](#)
- [Information About Load Balancing, page 7-1](#)
- [Managing GSS VIP Answers, page 7-73](#)

## Managing GSS VIP Answer and DNS Rule Groups

This section describes how to organize GSS VIP answers or DNS rules into groups, which allows you to display and manage a specific group of VIP answers or DNS rules without having to filter the display. When creating a group, you specify whether the group is available to just you or is available globally to all ANM users.

The GSS object grouping feature is available from the following operations windows:

- Answer VIPs (Config > Operations > GSS VIP Answers)
- DNS Rules (Config > Operations > GSS DNS Rules)

These windows contain the Groups option for managing object groups. [Figure 7-2](#) shows the Groups icon with the following available options for managing object groups:

- Create New Group—Adds a new group.
- Edit Group—Modifies an existing group. This option displays only after you select a group to display in Group mode.
- Exit Group Mode—Changes the display from the Group mode display to the display of all VIP answers or DNS rules. This option displays only after you select a group and the display enters the Group mode.
- Saved Groups—Lists the currently configured groups with each group's privilege level (local or global) and owner. From this view, you can choose a group to display or delete a group.

**Figure 7-2** Object Grouping for GSS VIP Answers and DNS Rules

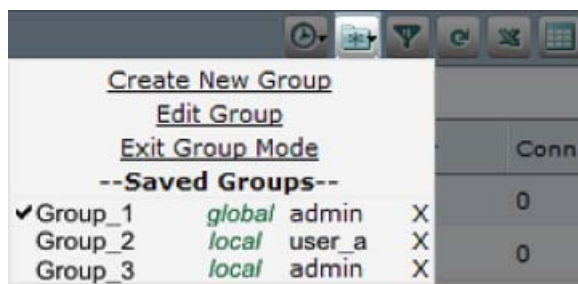

#### Guidelines and Restrictions

Object grouping guidelines and restrictions are as follows:

- When you create a global group, other users can see the group if they have access to at least one object within the group. This rule does not apply to the admin user or a user with the anm-admin role because they have visibility to all global groups.

- To edit or delete a group, you must be the group owner, a user with the `anm-admin` role, or the admin user.
- When you delete a locally authenticated user from the ANM database, ANM deletes all the global and user-specific groups that the user created. However, when you delete a *remotely authorized* user from the remote AAA server database, ANM does not delete the groups that the user created. In this case, you must manually delete the user's groups.

This section includes the following topics:

- [Creating a VIP Answer or DNS Rule Group, page 7-77](#)
- [Editing or Copying a VIP Answer or DNS Rule Group, page 7-78](#)
- [Displaying a VIP Answer or DNS Rule Group, page 7-79](#)
- [Deleting a VIP Answer or DNS Rule Group, page 7-80](#)

## Creating a VIP Answer or DNS Rule Group

You can create a GSS answer VIP or DNS rule group.

### Procedure

- 
- Step 1** Choose one of the following depending on the group type that you want to create:
- **Config > Operations > GSS VIP Answers.**
  - **Config > Operations > GSS DNS Rules**
- Depending on your choice, either the Answer VIPs or DNS Rules object table appears.
- Step 2** Click the **Groups** icon located above the objects table.
- The Groups menu appears below the icon (see [Figure 7-2](#)).
- Step 3** From the Groups menu, choose **Create New Group**.
- The display enters the edit mode and the Creating a New Group table appears with the list of the available GSS VIP answer or DNS rule objects.
- Step 4** From the Creating a New Group table, check the check box next to the GSS objects that you want to include in the group.
- Step 5** (Optional) Check the **Hide unselected** check box to display only the GSS objects that you have chosen. Uncheck the check box to display all the available GSS objects.
- Step 6** Do one of the following:
- Click **Save as** to save the group information. The Create Group popup window appears.
- From the popup window, do the following:
- a. In the Group Name text box, enter a name for the group. Enter 1 to 64 alphanumeric characters. Special characters and spaces are allowed.
  - b. Choose the availability of the group by clicking one of the following radio buttons:
    - **This user only (local)**—Only you can view, modify, or delete the group.
    - **All users (global)**—All ANM users can view the group if they have permission to view at least one of the GSS objects associated with the group. A user with the admin or anm-admin can view all groups and can also edit or delete any group.
  - c. Do one of the following:

- Click **Save** to save the group information. The Create Group popup window closes and the Viewing Group table appears, displaying the new group's name and associated objects.  
To exit Group mode and return to the Real Servers table, click the **Groups** icon and click **Exit Group Mode** from the Groups menu.
- Click **Cancel** to close the Create Group popup window without saving any information and to return to the Creating a New Group table.
- Click **Back to View** to exit the Group display mode and return to the objects table

---

#### Related Topics

- [Managing GSS VIP Answer and DNS Rule Groups, page 7-76](#)
- [Editing or Copying a VIP Answer or DNS Rule Group, page 7-78](#)
- [Displaying a VIP Answer or DNS Rule Group, page 7-79](#)
- [Deleting a VIP Answer or DNS Rule Group, page 7-80](#)
- [Managing GSS VIP Answers, page 7-73](#)
- [Activating and Suspending DNS Rules Governing GSS Load Balancing, page 7-75](#)

## Editing or Copying a VIP Answer or DNS Rule Group

You can edit a GSS VIP answer or DNS rule group or create a copy of a group under a different name.

#### Procedure

- 
- Step 1** Choose one of the following depending on the group type that you want to edit or copy:
- **Config > Operations > GSS VIP Answers.**
  - **Config > Operations > GSS DNS Rules**
- Depending on your choice, either the Answer VIPs or DNS Rules object table appears.
- Step 2** Click the **Groups** icon located above the objects table.  
The Groups menu appears below the icon (see [Figure 7-2](#)).
- Step 3** From the Groups menu, choose the group that you want to edit.  
The Viewing Group table appears, displaying the selected group's name and associated GSS VIP answer or DNS rule objects.
- Step 4** Click the **Groups** icon again and from the Groups menu, choose **Edit Group**.  
The Editing Group table appears, displaying the complete list of available objects with the objects currently associated with the group highlighted and checked.
- Step 5** Modify the group as needed by adding (check) or removing (uncheck) objects as needed. Skip this step if you only want to save a copy of the current group under a different name.
- Step 6** Do one of the following:
- Click **Save** to save the changes and return to the Viewing Group table, where you can view the changes.
  - Click **Save as** to save the configuration under a new group name. The Create Group popup window appears.

From the popup window, do the following:

- a. In the Group Name text box, enter a name for the group. Enter 1 to 64 alphanumeric characters. Special characters and spaces are allowed.
  - b. Choose the availability of the group by clicking one of the following radio buttons:
    - **This user only (local)**—Only you can view, modify, or delete the group.
    - **All users (global)**—All ANM users can view the group if they have permission to view at least one of the real servers associated with the group. The admin user or a user with the anm-admin role can view all global groups and can also edit or delete these groups.
  - c. Do one of the following:
    - Click **Save** to save the group information. The Create Group popup window closes and the Viewing Group table appears, displaying the new group's name and associated objects.
    - Click **Cancel** to close the Create Group popup window without saving any information and to return to the Creating a New Group table.
- Click **Back to View** to exit the edit mode and return to the Group mode.

**Step 7** (Optional) To exit Group mode and return to the GSS objects table, click the **Groups** icon and click **Exit Group Mode** from the Groups menu.

---

#### Related Topics

- [Managing GSS VIP Answer and DNS Rule Groups, page 7-76](#)
- [Creating a VIP Answer or DNS Rule Group, page 7-77](#)
- [Displaying a VIP Answer or DNS Rule Group, page 7-79](#)
- [Deleting a VIP Answer or DNS Rule Group, page 7-80](#)
- [Managing GSS VIP Answers, page 7-73](#)
- [Activating and Suspending DNS Rules Governing GSS Load Balancing, page 7-75](#)

## Displaying a VIP Answer or DNS Rule Group

You can display the list of GSS objects associated with a VIP answer or DNS rule group.

#### Procedure

---

**Step 1** Choose one of the following depending on the group type that you want to edit or copy:

- **Config > Operations > GSS VIP Answers.**
- **Config > Operations > GSS DNS Rules**

Depending on your choice, either the Answer VIPs or DNS Rules object table appears.

**Step 2** Click the **Groups** icon located above the objects table.

The Groups menu appears below the icon (see [Figure 7-2](#)).

**Step 3** From the Groups menu, choose the group that you want to display.

The Viewing Group table appears, displaying the selected group's name and associated objects.

- Step 4** (Optional) To exit Group mode and return to the GSS objects table, click the **Groups** icon and click **Exit Group Mode** from the Groups menu.
- 

#### Related Topics

- [Managing GSS VIP Answer and DNS Rule Groups, page 7-76](#)
- [Creating a VIP Answer or DNS Rule Group, page 7-77](#)
- [Editing or Copying a VIP Answer or DNS Rule Group, page 7-78](#)
- [Deleting a VIP Answer or DNS Rule Group, page 7-80](#)
- [Managing GSS VIP Answers, page 7-73](#)
- [Activating and Suspending DNS Rules Governing GSS Load Balancing, page 7-75](#)

## Deleting a VIP Answer or DNS Rule Group

You can delete a GSS VIP answer or DNS rule group. Deleting a group does not delete the group's associated objects from the ANM database.

#### Procedure

---

- Step 1** Choose one of the following depending on the group type that you want to edit or copy:
- **Config > Operations > GSS VIP Answers.**
  - **Config > Operations > GSS DNS Rules**
- Depending on your choice, either the Answer VIPs or DNS Rules object table appears.
- Step 2** Click the **Groups** icon located above the objects table.  
The Groups menu appears below the icon (see [Figure 7-2](#)).
- Step 3** From the Groups menu, click **X** (delete) next to the group that you want to delete.  
The Delete Group confirmation popup window appears.
- Step 4** From the Delete Group confirmation popup window, do one of the following:
- Click **Delete** to remove the selected group.
  - Click **Cancel** to ignore the deletion request.
- 

#### Related Topics

- [Managing GSS VIP Answer and DNS Rule Groups, page 7-76](#)
- [Creating a VIP Answer or DNS Rule Group, page 7-77](#)
- [Editing or Copying a VIP Answer or DNS Rule Group, page 7-78](#)
- [Displaying a VIP Answer or DNS Rule Group, page 7-79](#)
- [Activating and Suspending DNS Rules Governing GSS Load Balancing, page 7-75](#)

## Displaying Detailed Virtual Server Information

You can display detailed information about the state of a virtual server.

### Procedure

- 
- Step 1** Choose **Config > Operations > Virtual Servers**.
- The Virtual Servers table appears.
- Step 2** (Optional) To display only the virtual servers of a specific virtual server group, do the following:
- Click the **Groups** icon located above the Virtual Servers table. The Groups menu appears below the icon (see [Figure 7-1](#)).
  - From the Groups menu, choose the group to display.
- Step 3** In the Virtual Servers table, choose the virtual server whose configuration details that you want to display.
- Click the hyperlinked entry for that virtual server that appears in the Operational State column.
- The Details window appears with the following information:
- Current operational status
  - Description, if one was entered
  - Configured interfaces, such as VLANs
  - Configured service policies including:
    - Configured class maps, detailed by type (such as load balancing or inspection)
    - States of configured options, indicated by word (ACTIVE, DISABLED, OUTFSERVICE) and color (green, orange/yellow, and red)
    - Associated policy maps with details on their type and action (L7 loadbalance, serverfarm)
    - Statistics regarding connections and counts
- 

### Related Topics

- [Configuring Virtual Servers, page 7-2](#)
- [Displaying Virtual Servers by Context, page 7-65](#)
- [Displaying Virtual Server Statistics and Status Information, page 7-65](#)
- [Managing Virtual Servers, page 7-66](#)

## Displaying Virtual Servers

You can display all virtual servers.

### Procedure

- 
- Step 1** Choose **Config > Operations > Virtual Servers**.
- The Virtual Servers table appears. [Table 7-23](#) describes the Virtual Servers table information.

Table 7-23 Virtual Server Table Fields





| Item                     | Description                                                                                                                                                                                                                                                                                                                                                                                                                                                                                                                                                                                                                                                                                                                                                                                                                                       |
|--------------------------|---------------------------------------------------------------------------------------------------------------------------------------------------------------------------------------------------------------------------------------------------------------------------------------------------------------------------------------------------------------------------------------------------------------------------------------------------------------------------------------------------------------------------------------------------------------------------------------------------------------------------------------------------------------------------------------------------------------------------------------------------------------------------------------------------------------------------------------------------|
| Name                     | Server farm name sorted by virtual context.                                                                                                                                                                                                                                                                                                                                                                                                                                                                                                                                                                                                                                                                                                                                                                                                       |
| Policy Map               | Associated policy map.                                                                                                                                                                                                                                                                                                                                                                                                                                                                                                                                                                                                                                                                                                                                                                                                                            |
| IP Address:Protocol:Port | Server farm IP address, protocol, and port used for communications.                                                                                                                                                                                                                                                                                                                                                                                                                                                                                                                                                                                                                                                                                                                                                                               |
| HA                       | <p>Indicators that display when the virtual server is part of a high availability pair. The indicators are as follows:</p> <ul style="list-style-type: none"> <li>• Asterisk (*)—The virtual server is associated with an HA pair and the HA configuration is complete.</li> <li>• Red dash (-)—The virtual server is associated with an HA pair; however, the HA configuration is incomplete. Typically, the HA pair are not properly configured for HA or only one of the devices has been imported into ANM. Ensure that both devices are imported into ANM and that they are configured as described in the <a href="#">“Configuring ACE High Availability”</a> section on page 13-14.</li> </ul> <p>The table displays HA pair virtual servers together in the same row and they remain together no matter how you sort the information.</p> |
| SLB Device               | Associated ACE IP address and context.                                                                                                                                                                                                                                                                                                                                                                                                                                                                                                                                                                                                                                                                                                                                                                                                            |
| Admin                    | <p>Administrative state of the virtual server: Up or Down.</p> <p> <b>Note</b> For a CSM device, the virtual server Admin State is derived from the Operational State. In this case, the Operational State may display an Out of Service condition when the virtual server is configured to be Inservice (if all of the real servers are out of service).</p>                                                                                                                                                                                                                                                                                                                                                                                                    |
| Oper                     | <p>Operational state of the virtual server: Up or Down.</p> <p>(ACE devices only) To display detailed information about the virtual server in a popup window, click the linked state value in this column. For more information about this popup window, see the <a href="#">“Displaying Virtual Server Statistics and Status Information”</a> section on page 7-65.</p> <p> <b>Note</b> The display virtual server details feature requires ACE module software Version A2(1.2), ACE appliance software Version A3(2.1), or later versions of either software. An error displays with earlier software versions.</p>                                                                                                                                          |
| DWS                      | <p>Operating state of Dynamic Workload Scaling for the virtual server, which can be:</p> <ul style="list-style-type: none"> <li>• N/A—Not applicable; the server farms associated with the virtual server are not configured to use Dynamic Workload Scaling.</li> <li>• Local—At least one server farm associated the virtual server is configured to use Dynamic Workload Scaling, but the ACE is sending traffic to the VM Controller’s local VMs only.</li> <li>• Expanded—At least one server farm associated the virtual server is configured to use Dynamic Workload Scaling and the ACE is sending traffic to the VM Controller’s local and remote VMs.</li> </ul>                                                                                                                                                                        |



Table 7-23 Virtual Server Table Fields (continued)

| Item        | Description                                                                                                                                                                                                                                                                                                                                                                                                                                                                                                                                      |
|-------------|--------------------------------------------------------------------------------------------------------------------------------------------------------------------------------------------------------------------------------------------------------------------------------------------------------------------------------------------------------------------------------------------------------------------------------------------------------------------------------------------------------------------------------------------------|
| Conn        | <p>Number of active connections.</p> <p> <b>Note</b> This column is populated for ACE appliances. For ACE devices, the Active Connections column displays N/A for older versions of the ACE appliance and module.</p>                                                                                                                                                                                                                                           |
| Stat Age    | Age of the statistical information.                                                                                                                                                                                                                                                                                                                                                                                                                                                                                                              |
| Serverfarms | <p>Associated server farms.</p> <p> <b>Note</b> If you have the Details popup window feature enabled, click the value in this column to open the Details popup window and display detailed information about the server farm. By default, this feature is disabled. For information about enabling or disabling this feature, see the <a href="#">“Enabling the ACE Server Farm Details Popup Window Option for Virtual Servers”</a> section on page 18-65.</p> |
| VLANs       | Associated VLANs.                                                                                                                                                                                                                                                                                                                                                                                                                                                                                                                                |

You can activate or suspend virtual servers from this table and obtain additional information about the state of the virtual server.

**Step 2** (Optional) Use the display toggle button (  ) located above the table to control which virtual servers ANM displays as follows:

- Show ANM recognized Virtual Servers—Displays only virtual servers that match ANM’s virtual server definition (see the [“Virtual Server Configuration and ANM”](#) section on page 7-2).
- Show all Virtual Servers—Displays virtual servers that match ANM’s virtual server definition and those that do not match this definition but that ANM can recognize as virtual servers using SNMP polling.



**Note** The display toggle button displays only when you have the “Display All Virtual Servers in Monitoring & Operations page” advanced setting feature enabled (see the [“Managing the Display of Virtual Servers in the Operations and Monitoring Windows”](#) section on page 18-66).

**Step 3** (Optional) To display only the virtual servers of a specific virtual server group, do the following:

- Click the **Groups** icon located above the Virtual Servers table. The Groups menu appears below the icon (see [Figure 7-1](#)).
- From the Groups menu, choose the group to display.

You can activate or suspend virtual servers from this table and obtain additional information about the state of the virtual server.

#### Related Topics

- [Activating Virtual Servers, page 7-71](#)
- [Suspending Virtual Servers, page 7-72](#)

- [Managing Virtual Server Groups, page 7-67](#)
- [Displaying Detailed Virtual Server Information, page 7-81](#)
- [Displaying Virtual Server Statistics and Status Information, page 7-65](#)
- [Displaying Virtual Servers by Context, page 7-65](#)

## Using the Virtual Server Connection Statistics Graph

You can display real time and historical statistical information about the connections of a virtual server. ANM displays the information in graph or chart form. This feature also allows you to compare similar connection information across multiple virtual servers.

### Procedure

- 
- Step 1** Choose **Config > Operations > Virtual Servers**.
- The Virtual Servers table appears. You can activate or suspend virtual servers from this table and obtain additional information about the state of the virtual server.
- Step 2** (Optional) To display only the virtual servers of a specific virtual server group, do the following:
- Click the **Groups** icon located above the Virtual Servers table. The Groups menu appears below the icon (see [Figure 7-1](#)).
  - From the Groups menu, choose the group to display.
- Step 3** In the Virtual Servers table, check the check box next to server whose connection information you want to display, and click **Graph**.
- You can choose up to four virtual servers if you want to compare statistical data.
- The Virtual Server Graph window appears, displaying the default graph for each selected virtual server. For details about using the graph feature, see the [“Configuring Historical Trend and Real Time Graphs for Devices”](#) section on page 17-48.
- Step 4** Click **Exit** to return to the Virtual Server widow.
- 

### Related Topics

- [Configuring Historical Trend and Real Time Graphs for Devices, page 17-48](#)
- [Activating Virtual Servers, page 7-71](#)
- [Suspending Virtual Servers, page 7-72](#)
- [Managing Virtual Server Groups, page 7-67](#)
- [Displaying Detailed Virtual Server Information, page 7-81](#)
- [Displaying Virtual Servers, page 7-81](#)
- [Using the Virtual Server Topology Map, page 7-85](#)
- [Displaying Virtual Server Statistics and Status Information, page 7-65](#)
- [Displaying Virtual Servers by Context, page 7-65](#)

## Using the Virtual Server Topology Map

You can display the nodes on your network based on the virtual server that you select.

### Procedure

---

**Step 1** Choose **Config > Operations > Virtual Servers**.

The Virtual Servers table appears.

**Step 2** (Optional) To display only the virtual servers of a specific virtual server group, do the following:

- a. Click the **Groups** icon located above the Virtual Servers table. The Groups menu appears below the icon (see [Figure 7-1](#)).
- b. From the Groups menu, choose the group to display.

**Step 3** Use the display toggle button (  ) to ensure that the Virtual Servers table is set to Show ANM Recognized Virtual Servers.



---

**Note** The topology map feature is not available when the Virtual Server table is set to Show All Virtual Servers (for more information, see the [“Displaying Virtual Servers”](#) section on page 7-81).

---

**Step 4** In the Virtual Servers table, choose the server whose topology map you want to display, and click **Topology**.

The ANM Topology map appears. The map includes several tools for navigating the network map and zooming in and out. For details about using the map tools, see the [“Displaying Network Topology Maps”](#) section on page 17-68.

**Step 5** Click **Exit** to return to the Virtual Server widow.

---

### Related Topics

- [Suspending Virtual Servers, page 7-72](#)
- [Managing Virtual Server Groups, page 7-67](#)
- [Displaying Detailed Virtual Server Information, page 7-81](#)
- [Displaying Virtual Servers, page 7-81](#)
- [Using the Virtual Server Connection Statistics Graph, page 7-84](#)
- [Displaying Virtual Server Statistics and Status Information, page 7-65](#)
- [Displaying Virtual Servers by Context, page 7-65](#)

## Understanding CLI Commands Sent from Virtual Server Table

Table 7-24 displays the CLI commands dispatched to the device for a given Virtual Servers table option, and is sorted by device.

**Table 7-24** CLI Commands Deployed from Virtual Servers Table

| Command                           | Sample CLI Sent                                                                    |
|-----------------------------------|------------------------------------------------------------------------------------|
| <b>ACE Modules and Appliances</b> |                                                                                    |
| Virtual Server Activate           | <pre>policy-map multi-match int25   class VIP3     loadbalance vip inservice</pre> |
| Virtual Server Suspend            | <pre>policy-map multi-match int25 class VIP3 no loadbalance vip inservice</pre>    |
| <b>CSMs</b>                       |                                                                                    |
| Virtual Server Activate           | <pre>vserver APP1   inservice</pre>                                                |
| Virtual Server Suspend            | <pre>vserver APP1   no inservice</pre>                                             |
| <b>CSS Devices</b>                |                                                                                    |
| Virtual Server Activate           | <pre>owner hm   content LB   active</pre>                                          |
| Virtual Server Suspend            | <pre>owner hm   content LB   suspend</pre>                                         |

## Deploying Virtual Servers

You can deploy virtual servers on your network at times that are convenient and appropriate for your environment. For example, if your site prefers to make changes to the network during a specific time each night, you can modify and save virtual server configurations during the day and then deploy them when appropriate.

This section includes the following topics:

- [Deploying a Virtual Server, page 7-87](#)
- [Displaying All Staged Virtual Servers, page 7-87](#)
- [Modifying Deployed Virtual Servers, page 7-88](#)
- [Modifying Staged Virtual Servers, page 7-88](#)

## Deploying a Virtual Server

You can deploy virtual servers on your network at times that are convenient and appropriate for your environment. For example, if your site prefers to make changes to the network during a specific time each night, you can modify and save virtual server configurations during the day and then deploy them when appropriate.

### Procedure

- 
- Step 1** Choose **Config > Deploy**.  
The Staged Objects table appears.
- Step 2** From the Staged Objects table, choose the virtual server that you want to deploy on your network, and click **Deploy**.  
The virtual server is deployed and the table refreshes with updated information.
- 

### Related Topics

- [Configuring Virtual Servers, page 7-2](#)
- [Displaying All Staged Virtual Servers, page 7-87](#)
- [Modifying Staged Virtual Servers, page 7-88](#)

## Displaying All Staged Virtual Servers

You can display all objects that have been configured but have not yet been deployed on your network.

### Procedure

- 
- Step 1** Do one of the following:
- Choose **Config > Deploy**.  
The Staged Objects table appears listing the following:
    - Virtual server name
    - Device ID and virtual context
    - Time the virtual server was created
    - User who last modified the object
    - Time the object was last updated
  - Choose **Config > Devices > context > Load Balancing > Virtual Servers**.  
The Virtual Servers table appears. Virtual servers with configurations that have not been deployed appear with the status Not Deployed in the Configured State column.
- 

### Related Topics

- [Configuring Virtual Servers, page 7-2](#)

- [Deploying a Virtual Server, page 7-87](#)
- [Modifying Staged Virtual Servers, page 7-88](#)
- [Modifying Deployed Virtual Servers, page 7-88](#)

## Modifying Deployed Virtual Servers

You can modify the configuration of a deployed virtual server.

### Procedure

---

- Step 1** Choose **Config > Devices > context > Load Balancing > Virtual Servers**.  
The Virtual Servers table appears.
- Step 2** In the Virtual Servers table, choose the virtual server you want to modify, and click **Edit**.  
The Virtual Server configuration window appears.
- Step 3** In the Virtual Server configuration window, modify the virtual server's configuration as desired.  
See [Table 7-1](#) for virtual server configuration options.
- Step 4** When you are done modifying the configuration, do one of the following:
- Click **Deploy Now** to immediately deploy this configuration on the ACE and save your entries to the running-configuration and startup-configuration files.
  - Click **Cancel** to exit this procedure without saving your entries and to return to the Virtual Servers table.
- 

### Related Topics

- [Managing Virtual Servers, page 7-66](#)
- [Displaying All Staged Virtual Servers, page 7-87](#)
- [Activating Virtual Servers, page 7-71](#)
- [Suspending Virtual Servers, page 7-72](#)

## Modifying Staged Virtual Servers

You can modify the configuration of a staged virtual server.

### Procedure

---

- Step 1** Choose **Config > Deploy**.  
The Staged Objects table appears, listing those virtual servers that have not yet been deployed in the network.
- Step 2** From the Staged Objects table, choose the virtual server you want to modify, and click **Edit**.  
The Virtual server configuration window appears.
- Step 3** In the Virtual server configuration window, modify the virtual server configuration as desired.

See [Table 7-1](#) for virtual server configuration options.

**Step 4** When you are done modifying the configuration, do one of the following:

- Click **Deploy Now** to immediately deploy this configuration on the ACE and save your entries to the running-configuration and startup-configuration files.
  - Click **Cancel** to exit this procedure without saving your entries and to return to the Virtual Servers table.
  - Click **Deploy Later** to save your entries and apply this configuration at a later time.
- 

#### Related Topics

- [Deploying a Virtual Server, page 7-87](#)
- [Displaying All Staged Virtual Servers, page 7-87](#)
- [Activating Virtual Servers, page 7-71](#)







## CHAPTER 8

# Configuring Real Servers and Server Farms

---

**Date:** 3/28/12

This chapter describes how to configure real servers and server farms on the Cisco Application Control Engine (ACE) using Cisco Application Networking Manager (ANM).



**Note**

When naming ACE objects (such as a real server, virtual server, parameter map, class map, health probe, and so on), enter an alphanumeric string of 1 to 64 characters, which can include the following special characters: underscore (\_), hyphen (-), dot (.), and asterisk (\*). Spaces are not allowed.

If you are using ANM with an ACE module or ACE appliance and you configure a named object at the ACE CLI, keep in mind that ANM does not support all of the special characters that the ACE CLI allows you to use when configuring a named object. If you use special characters that ANM does not support, you may not be able to import or manage the ACE using ANM.

---

This chapter includes the following sections:

- [Information About Server Load Balancing, page 8-1](#)
- [Configuring Real Servers, page 8-5](#)
- [Managing Real Servers, page 8-9](#)
- [Configuring Dynamic Workload Scaling, page 8-26](#)
- [Configuring Server Farms, page 8-30](#)
- [Configuring Health Monitoring, page 8-49](#)
- [Configuring Secure KAL-AP, page 8-77](#)

## Information About Server Load Balancing

Server load balancing (SLB) is the process of deciding to which server a load-balancing device should send a client request for service. For example, a client request can consist of an HTTP GET for a Web page or an FTP GET to download a file. The job of the load balancer is to select the server that can successfully fulfill the client request and do so in the shortest amount of time without overloading either the server or the server farm as a whole.

Depending on the load-balancing algorithm or predictor that you configure, the ACE performs a series of checks and calculations to determine the server that can best service each client request. The ACE bases server selection on several factors, including the server with the fewest connections with respect to load, source or destination address, cookies, URLs, or HTTP headers.

ANM allows you to configure load balancing using:

- Virtual servers—See [Configuring Virtual Servers, page 7-2](#).
- Real servers—See [Configuring Real Servers, page 8-5](#).
- Dynamic Workload Scaling—See [Configuring Dynamic Workload Scaling, page 8-26](#).
- Server farms—See [Configuring Server Farms, page 8-30](#).
- Sticky groups—See [Configuring Sticky Groups, page 9-7](#).
- Parameter maps—See [Configuring Parameter Maps, page 10-1](#).

For more information about SLB as configured and performed by the ACE, see:

- [Configuring Virtual Servers, page 7-2](#)
- [Load-Balancing Predictors, page 8-2](#)
- [Real Servers, page 8-3](#)
- [Dynamic Workload Scaling Overview, page 8-4](#)
- [Server Farms, page 8-5](#)
- [Configuring Health Monitoring, page 8-49](#)
- [TCL Scripts, page 8-50](#)
- [Configuring Stickiness, page 9-1](#)

This section includes the following topics:

- [Load-Balancing Predictors, page 8-2](#)
- [Real Servers, page 8-3](#)
- [Server Farms, page 8-5](#)

## Load-Balancing Predictors

The ACE uses the following predictors to select the best server to satisfy a client request:

- Hash Address—Selects the server using a hash value based on either the source or destination IP address, or both. Use these predictors for firewall load balancing (FWLB).



**Note** FWLB allows you to scale firewall protection by distributing traffic across multiple firewalls on a per-connection basis. All packets belonging to a particular connection must go through the same firewall. The firewall then allows or denies transmission of individual packets across its interfaces. For more information about configuring FWLB on the ACE, see the *Cisco 4700 Series Application Control Engine Appliance Server Load-Balancing Configuration Guide*.

- Hash Content— Selects the server by using a hash value based on the specified content string of the HTTP packet body
- Hash Cookie—Selects the server using a hash value based on a cookie name.
- Hash Header—Selects the server using a hash value based on the HTTP header name.

- Hash Layer4—Selects the server using a Layer 4 generic protocol load-balancing method.
- Hash URL—Selects the server using a hash value based on the requested URL.

You can specify a beginning pattern and an ending pattern to match in the URL. Use this predictor method to load-balance cache servers. Cache servers perform better with the URL hash method because you can divide the contents of the caches evenly if the traffic is random enough. In a redundant configuration, the cache servers continue to work even if the active ACE switches over to the standby ACE. For information about configuring redundancy, see the [“Configuring High Availability” section on page 13-1](#).

- Least Bandwidth—Selects the server with the least amount of network traffic or a specified sampling period. Use this type for server farms with heavy traffic, such as downloading video clips.
- Least Connections—Selects the server with the fewest number of active connections based on server weight. For the least connection predictor, you can configure a slow-start mechanism to avoid sending a high rate of new connections to servers that you have just put into service.
- Least Loaded—Selects the server with the lowest load as determined by information from SNMP probes.
- Response—Selects the server with the lowest response time for a specific response-time measurement.
- Round Robin—Selects the next server in the list of real servers based on server weight (weighted roundrobin). Servers with a higher weight value receive a higher percentage of the connections. This is the default predictor.

**Note**

The different hash predictor methods do not recognize the weight value that you configure for real servers. The ACE uses the weight that you assign to real servers only in the round-robin and least-connections predictor methods.

**Related Topics**

[Configuring the Predictor Method for Server Farms, page 8-39](#)

## Real Servers

To provide services to clients, you configure real servers on the ACE. Real servers can be dedicated physical servers or VMware virtual machines (VMs) that you configure in groups called server farms.

**Note**

VMs that you define as real servers can be VMs associated with a VMware vCenter Server that you import into ANM (see the [“Importing VMware vCenter Servers” section on page 5-24](#)) and VMs that the ACE recognizes when configured for Dynamic Workload Scaling (see the [“Configuring Dynamic Workload Scaling” section on page 8-26](#)).

Real servers provide client services such as HTTP or XML content, website hosting, FTP file uploads or downloads, redirection for web pages that have moved to another location, and so on. You identify real servers with names and characterize them with IP addresses, connection limits, and weight values. The ACE also allows you to configure backup servers in case a server is taken out of service for any reason.

After you create and name a real server on the ACE, you can configure several parameters, including connection limits, health probes, and weight. You can assign a weight to each real server based on its relative importance to other servers in the server farm. The ACE uses the server weight value for the

weighted round-robin and the least-connections load-balancing predictors. The load-balancing predictor algorithms (for example, roundrobin, least connections, and so on) determine the servers to which the ACE sends connection requests. For a listing and brief description of the load-balancing predictors, see the “[Load-Balancing Predictors](#)” section on page 8-2.

The ACE uses traffic classification maps (class maps) within policy maps to identify traffic that meets defined criteria and to apply specific actions to that traffic based on the SLB configuration.

If a primary real server fails, the ACE takes that server out of service and no longer includes it in load-balancing decisions. If you configured a backup server for the real server that failed, the ACE redirects the primary real server connections to the backup server. For information about configuring a backup server, see the “[Configuring Virtual Server Layer 7 Load Balancing](#)” section on page 7-30.

The ACE can take a real server out of service for the following reasons:

- Probe failure
- ARP timeout
- Neighbor Discovery (ND) failure (IPv6 only, which requires ACE module and ACE appliance software Version A5(1.0) or later)
- Specifying Out Of Service as the administrative state of a real server
- Specifying Inservice Standby as the administrative state of a real server

The Out Of Service and Inservice Standby selections both provide the graceful shutdown of a server.

#### Related Topics

- [Configuring Real Servers](#), page 8-5
- [Configuring Health Monitoring for Real Servers](#), page 8-51

## Dynamic Workload Scaling Overview



#### Note

---

Dynamic Workload Scaling requires ACE module or appliance software Version A4(2.0) or later and a pair of the Cisco Nexus 7000 Series switches with Overlay Transport Virtualization (OTV) technology.

---

The ACE Dynamic Workload Scaling (DWS) feature permits on-demand access to remote resources, such as VMs, that you own or lease from an Internet service provider or cloud service provider. This feature uses Cisco Nexus 7000 Series switches with OTV to create a Data Center Interconnect (DCI) on a Layer 2 link over an existing IP network between geographically distributed data centers (see [Figure 1-1](#)). The local data center Cisco Nexus 7000 Series switch contains an OTV forwarding table that lists the MAC addresses of the Layer 2 extended virtual private network (VPN) and identifies the addresses as either local or remote.

When you configure the ACE for DWS, the ACE uses an XML query to poll the Cisco Nexus 7000 Series switch and obtain the OTV forwarding table information to determine the locality of the VMs (local or remote). The ACE also uses a health monitor probe that it sends to the local VMware vCenter Server to monitor the load of the local VMs based on CPU usage, memory usage, or both. When the average CPU and/or memory usage of the local VMs reaches its configured maximum threshold value, the ACE bursts traffic to the remote VMs. The ACE stops bursting traffic to the remote VMs when local VM usage drops below its configured minimum threshold value.

To use DWS, you configure the ACE to connect to the Data Center Interconnect device (Cisco Nexus 7000 Series switch) and the VMware Controller associated with the local and remote VMs. You also configure the ACE with the probe type VM to monitor a server farm's local VM CPU and memory usage, which determines when the ACE bursts traffic to the remote VMs (see the [“Configuring Dynamic Workload Scaling”](#) section on page 8-26).

For more details on this feature, see the *Cisco 4700 Series Application Control Engine Appliance Server Load-Balancing Configuration Guide*.

## Server Farms

Typically, in data centers, servers are organized into related groups called *server farms*. Servers within server farms often contain identical content (referred to as mirrored content) so that if one server becomes inoperative, another server can take its place immediately. Also, having mirrored content allows several servers to share the load of increased demand during important local or international events, such as the Olympic Games. This phenomenon of a sudden large demand for content is called a *flash crowd*.

After you create and name a server farm, you can add existing real servers to it and configure other server farm parameters, such as the load-balancing predictor, server weight, backup server, health probe, and so on. For a listing and brief description of load-balancing predictors, see the [“Load-Balancing Predictors”](#) section on page 8-2.

### Related Topics

[Configuring Server Farms, page 8-30](#)

## Configuring Real Servers

Real servers are dedicated physical servers that are typically configured in groups called server farms. These servers provide services to clients, such as HTTP or XML content, streaming media (video or audio), TFTP or FTP services, and so on. When configuring real servers, you assign names to them and specify IP addresses, connection limits, and weight values.

The ACE uses traffic classification maps (class maps) within policy maps to filter specified traffic and to apply specific actions to that traffic based on the load-balancing configuration. A load-balancing predictor algorithm (such as round-robin or least connections) determines the servers to which the ACE sends connection requests. For information about configuring class maps, see the [“Configuring Virtual Context Class Maps”](#) section on page 14-6.

This section includes the following topics:

- [Configuring Load Balancing on Real Servers, page 8-6](#)
- [Displaying Real Server Statistics and Status Information, page 8-9](#)

## Configuring Load Balancing on Real Servers

You can configure load balancing on real servers.

### Procedure

- 
- Step 1** Choose **Config > Devices > context > Load Balancing > Real Servers**.  
The Real Servers table appears.
- Step 2** In the Real Servers table, click **Poll Now** to instruct ANM to poll the devices and display the current values, and click **OK** when prompted if you want to poll the devices for data now.
- Step 3** Click **Add** to add a new real server, or choose a real server you want to modify and click **Edit**.  
The Real Servers configuration window appears.
- Step 4** In the Real Servers configuration window, configure the server using the information in [Table 8-1](#).



---

**Note** Fields and information related to IPv6 require ACE module and ACE appliance software Version A5(1.0) or later.

---

**Table 8-1 Real Server Attributes**

| Field             | Description                                                                                                                                                                                                                                                                                                                                                                                       |
|-------------------|---------------------------------------------------------------------------------------------------------------------------------------------------------------------------------------------------------------------------------------------------------------------------------------------------------------------------------------------------------------------------------------------------|
| Name              | Field that allows you to either enter a unique name for this server or accept the automatically incremented value in this field. Valid entries are unquoted text strings with no spaces and a maximum of 64 characters.                                                                                                                                                                           |
| Type              | Type of server: <ul style="list-style-type: none"> <li>• <b>Host</b>—The real server provides content and services to clients.</li> <li>• <b>Redirect</b>—The server redirects traffic to a new location.</li> </ul>                                                                                                                                                                              |
| State             | State of the real server: <ul style="list-style-type: none"> <li>• <b>In Service</b>—The real server is in service.</li> <li>• <b>Out Of Service</b>—The real server is out of service.</li> </ul>                                                                                                                                                                                                |
| Description       | Brief description for this real server. Valid entries are strings of up to 240 characters. Spaces and special characters are allowed.                                                                                                                                                                                                                                                             |
| IP Address Type   | Field that appears only for ACE module and ACE appliance software Version A5(1.0) or later, which supports IPv4 and IPv6. These selections appear only for real servers specified as hosts.<br>Select the IP address type of this real server: <ul style="list-style-type: none"> <li>• IPv6—The real server has an IPv6 address.</li> <li>• IPv4—The real server has an IPv4 address.</li> </ul> |
| IPv6/IPv4 Address | For ACE module and ACE appliance software versions earlier than A5(1.0), this field does not include the IP version number. This field appears for only real servers specified as hosts.<br>Enter a unique IP address as indicated by the IP Address Type field. The IP address cannot be of an existing virtual IP address (VIP), real server or interface in the context.                       |

Table 8-1 Real Server Attributes (continued)



| Field            | Description                                                                                                                                                                                                                                                                                                                                                                                                                                                                                                                                                                                                                                                                                                                                                                                                                                                                                                                                                                                                                                                                                                                                                                                                                                                                                                                                                                                                                                                                                                                                                                                                                                                           |
|------------------|-----------------------------------------------------------------------------------------------------------------------------------------------------------------------------------------------------------------------------------------------------------------------------------------------------------------------------------------------------------------------------------------------------------------------------------------------------------------------------------------------------------------------------------------------------------------------------------------------------------------------------------------------------------------------------------------------------------------------------------------------------------------------------------------------------------------------------------------------------------------------------------------------------------------------------------------------------------------------------------------------------------------------------------------------------------------------------------------------------------------------------------------------------------------------------------------------------------------------------------------------------------------------------------------------------------------------------------------------------------------------------------------------------------------------------------------------------------------------------------------------------------------------------------------------------------------------------------------------------------------------------------------------------------------------|
| Fail-On-All      | <p>Field that appears only for real servers identified as host servers.</p> <p>By default, real servers with multiple probes configured for them have an OR logic associated with them, which means that if one of the real server probes fails, the real server fails and enters the PROBE-FAILED state.</p> <p>Check this checkbox to configure a real server to remain in the OPERATIONAL state unless all probes associated with it fail (AND logic).</p> <p>The Fail-On-All function is applicable to all probe types.</p>                                                                                                                                                                                                                                                                                                                                                                                                                                                                                                                                                                                                                                                                                                                                                                                                                                                                                                                                                                                                                                                                                                                                       |
| Min. Connections | <p>Minimum number of connections to be allowed on this server before the ACE starts sending connections again after it has exceeded the Max. Connections limit. This value must be less than or equal to the Max. Connections value. By default, this value is equal to the Max. Connections value. Valid entries are from 2 to 4000000.</p>                                                                                                                                                                                                                                                                                                                                                                                                                                                                                                                                                                                                                                                                                                                                                                                                                                                                                                                                                                                                                                                                                                                                                                                                                                                                                                                          |
| Max. Connections | <p>Maximum number of active connections allowed on this server. When the number of connections exceeds this value, the ACE stops sending connections to this server until the number of connections falls below the Min. Connections value. Valid entries are from 2 to 4000000, and the default is 4000000.</p>                                                                                                                                                                                                                                                                                                                                                                                                                                                                                                                                                                                                                                                                                                                                                                                                                                                                                                                                                                                                                                                                                                                                                                                                                                                                                                                                                      |
| Weight           | <p>Field that appears only for real servers identified as hosts.</p> <p>Enter the weight to be assigned to this real server in a server farm. Valid entries are from 1 to 100, and the default is 8.</p>                                                                                                                                                                                                                                                                                                                                                                                                                                                                                                                                                                                                                                                                                                                                                                                                                                                                                                                                                                                                                                                                                                                                                                                                                                                                                                                                                                                                                                                              |
| Probes           | <p>Field that appears only as follows:</p> <ul style="list-style-type: none"> <li>For all host real servers. The Available probe list contains all configured probe types.</li> <li>For redirect real servers configured on ACE devices that use the following software versions: <ul style="list-style-type: none"> <li>ACE module: A2(3.x) and later releases</li> <li>ACE appliance: A3(x) and later releases</li> </ul> </li> </ul> <p>The redirect real server Available probe list contains only configured probes of the type Is Routed, which means that the ACE routes the probe address according to the ACE internal routing table (see the “<a href="#">Configuring Health Monitoring for Real Servers</a>” section on page 8-51).</p> <p>In the Probes field, choose the probes to use for health monitoring in the Available Items list, and click <b>Add</b>. The probes appear in the Selected Items list.</p> <p> <b>Note</b> The probe must have the same IP address type (IPv6 or IPv4) as the real server. For example, you cannot configure an IPv6 probe to an IPv4 real server. IPv6 requires ACE module and ACE appliance software Version A5(1.0) or later.</p> <p> <b>Note</b> The list of available probes does not include VM probes used to monitor local VM usage.</p> <p>To remove probes that you do not want to use for health monitoring, choose them in the Selected Items list, and click <b>Remove</b>. The probes appear in the Available probe list.</p> |

Table 8-1 Real Server Attributes (continued)

| Field                | Description                                                                                                                                                                                                                                                                                                                                                                                                                                                                                                                                                                                                                                                                                                                                                                       |
|----------------------|-----------------------------------------------------------------------------------------------------------------------------------------------------------------------------------------------------------------------------------------------------------------------------------------------------------------------------------------------------------------------------------------------------------------------------------------------------------------------------------------------------------------------------------------------------------------------------------------------------------------------------------------------------------------------------------------------------------------------------------------------------------------------------------|
| Web Host Redirection | <p>URL string used to redirect requests to another server. This field appears only for real servers identified as redirect servers. Enter the URL and port used to redirect requests to another server.</p> <p>Valid entries are in the form <code>http://host.com:port</code> where <i>host</i> is the name of the server and <i>port</i> is the port to be used. Valid host entries are unquoted text strings with no spaces and a maximum of 255 characters. Valid port numbers are from 1 to 65535.</p> <p>The relocation string supports the following special characters:</p> <ul style="list-style-type: none"> <li>• <code>%h</code>—Inserts the hostname from the request Host header</li> <li>• <code>%p</code>—Inserts the URL path string from the request</li> </ul> |
| Redirection Code     | <p>Field that appears only for real servers identified as redirect servers.</p> <p>Choose the appropriate redirection code:</p> <ul style="list-style-type: none"> <li>• <b>N/A</b>—Webhost redirection code is not defined.</li> <li>• <b>301</b>—Requested resource has been moved permanently. For future references to this resource, the client should use one of the returned URIs.</li> <li>• <b>302</b>—Requested resource has been found, but has been moved temporarily to another location. For future references to this resource, the client should use the request URI because the resource may be moved to other locations from time to time.</li> </ul>                                                                                                           |
| Rate Bandwidth       | <p>Bandwidth rate is the number of bytes per second and applies to the network traffic exchanged between the ACE and the real server in both directions.</p> <p>Specify the real server bandwidth limit in bytes per second. Valid entries are from 2 to 300000000. The default is 300000000.</p>                                                                                                                                                                                                                                                                                                                                                                                                                                                                                 |
| Rate Connection      | <p>Connection rate is the number of connections per second received by the ACE and applies only to new connections destined to a real server.</p> <p>Specify the limit for connections per second. Valid entries are from 2 to 350000. The default is 350000.</p>                                                                                                                                                                                                                                                                                                                                                                                                                                                                                                                 |

**Step 5** Do one of the following:

- Click **Deploy Now** to deploy this configuration on the ACE and save your entries to the running-configuration and startup-configuration files.
- Click **Cancel** to exit the procedure without saving your entries and to return to the Real Servers table.
- Click **Next** to deploy your entries and to configure another real server.

**Step 6** To display statistics and status information for an existing real server, choose a real server from the Real Servers table, then click **Details**. The `show rserver name detail` CLI command output appears. See the “[Displaying Real Server Statistics and Status Information](#)” section on page 8-9 for details.

#### Related Topics

- [Managing Real Servers, page 8-9](#)
- [Configuring Health Monitoring for Real Servers, page 8-51](#)
- [Configuring Server Farms, page 8-30](#)



- [Configuring Sticky Groups, page 9-7](#)

## Displaying Real Server Statistics and Status Information

You can display statistics and status information for a particular real server.

### Procedure

- 
- Step 1** Choose **Config > Devices > context > Load Balancing > Real Servers**.  
The Real Servers table appears.
- Step 2** In the Real Servers table, choose a real server from the Real Servers table, and click **Details**.  
The **show rserver name detail** CLI command output appears. For details on the displayed output fields, see either the *Cisco ACE Module Server Load-Balancing Configuration Guide* or the *Cisco ACE 4700 Series Appliance Server Load-Balancing Configuration Guide*, Chapter 2, Configuring Real Servers and Server Farms.
- Step 3** Click **Update Details** to refresh the output for the **show rserver name detail** CLI command. The new information appears in a separate panel with a new timestamp; both the old and the new real server statistics and status information appear side-by-side to avoid overwriting the last updated information.
- Step 4** Click **Close** to return to the Real Servers table.
- 

### Related Topics

- [Configuring Real Servers, page 8-5](#)
- [Managing Real Servers, page 8-9](#)
- [Displaying Real Servers, page 8-18](#)

## Managing Real Servers

This section shows how to display and manage the real servers from the Real Servers window (Config > Operations > Real Servers). This window provides you with information about each real server configured on ANM (see the “[Displaying Real Servers](#)” section on page 8-18) and provides access to function buttons that allow you to perform tasks such as activate or suspend a real server, display a real server topology map, or display connection statistics graphs.

### Guidelines and Restrictions

The Real Servers window contains a Rows per page option that includes an All setting for displaying all configured real servers in one window. Use the All setting for viewing purposes only. ANM does not allow you to perform any operation from this window if you have more than 200 real servers selected. For example, if you use the All option to display and select more than 200 real servers and then attempt to perform the suspend operation, ANM cancels the request and displays an error message.

This section includes the following topics:

- [Managing Real Server Groups, page 8-10](#)
- [Activating Real Servers, page 8-14](#)
- [Suspending Real Servers, page 8-15](#)

- [Modifying Real Server Weight Value](#), page 8-17
- [Displaying Real Servers](#), page 8-18
- [Using the Real Server Connection Statistics Graph](#), page 8-22
- [Using the Real Server Topology Map](#), page 8-23
- [CLI Commands Sent from the Real Server Table](#), page 8-23
- [Server Weight Ranges](#), page 8-25

## Managing Real Server Groups

This section describes how to organize real servers into groups, which allows you to display and manage a specific group of real servers without having to filter the real server display. When creating a group, you specify whether the group is available to just you or is available globally to all ANM users.

The real server group feature is available from the real servers operations window (Config > Operations > Real Servers), which contains the Groups option for managing object groups. [Figure 8-1](#) shows the Groups icon with the following available options for managing object groups:

- Create New Group—Adds a new group.
- Edit Group—Modifies an existing group. This option displays only after you select a group to display in Group mode.
- Exit Group Mode—Changes the display from the specific group display to the display of all real servers. This option displays only after you select a group and the display enters the Group mode.
- Saved Groups—Lists the currently configured groups with each group's privilege level (local or global) and owner. From this view, you can choose a group to display or delete a group.

**Figure 8-1** Object Grouping for Real Servers

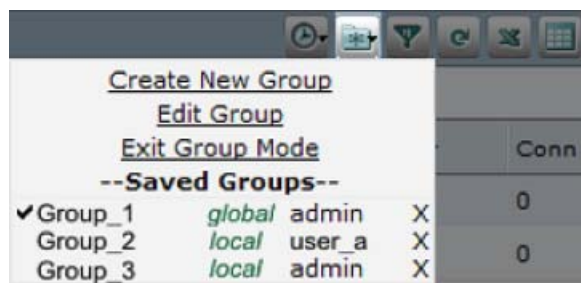

### Guidelines and Restrictions

This topic includes the following guidelines and restrictions:

- When you create a global group, other users can see the group if they have access to at least one object within the group. This rule does not apply to the admin user or a user with the anm-admin role because they have visibility to all global groups.
- To edit or delete a group, you must be the group owner, a user with the anm-admin role, or the admin user.

- When you delete a locally authenticated user from the ANM database, ANM deletes all the global and user-specific groups that the user created. However, when you delete a *remotely authorized* user from the remote AAA server database, ANM does not delete the groups that the user created. In this case, you must manually delete the user's groups.

This section includes the following topics:

- [Creating a Real Server Group, page 8-11](#)
- [Editing or Copying a Real Server Group, page 8-12](#)
- [Displaying a Real Server Group, page 8-13](#)
- [Deleting a Real Server Group, page 8-13](#)

## Creating a Real Server Group

You can create a real server group.

### Procedure

- 
- Step 1** Choose **Config > Operations > Real Servers**.
- The Real Servers table appears.
- Step 2** Click the **Groups** icon located above the Real Servers table.
- The Groups menu appears below the icon (see [Figure 8-1](#)).
- Step 3** From the Groups menu, choose **Create New Group**.
- The display enters the edit mode and the Creating a New Group table appears with the list of the available real servers.
- Step 4** From the Creating a New Group table, check the check box next to the real servers that you want to include in the group.
- Step 5** (Optional) Check the **Hide unselected** check box to display only the real servers that you have chosen. Uncheck the check box to display all the available real servers.
- Step 6** Do one of the following:
- Click **Save as** to save the group information. The Create Group popup window appears.  
From the popup window, do the following:
    - a. In the Group Name text box, enter a name for the group. Enter 1 to 64 alphanumeric characters. Special characters and spaces are allowed.
    - b. Choose the availability of the group by clicking one of the following radio buttons:
      - **This user only (local)**—Only you can view, modify, or delete the group.
      - **All users (global)**—All ANM users can view the group if they have permission to view at least one of the real servers associated with the group. A user with the admin or anm-admin can view all groups and can also edit or delete any group.
    - c. Do one of the following:
      - Click **Save** to save the group information. The Create Group popup window closes and the Viewing Group table appears, displaying the new group's name and associated real servers.  
To exit Group mode and return to the Real Servers table, click the **Groups** icon and click **Exit Group Mode** from the Groups menu.

- Click **Cancel** to close the Create Group popup window without saving any information and to return to the Creating a New Group table.
- Click **Back to View** to exit the Group mode and return to the Virtual Servers table.

---

#### Related Topics

- [Managing Real Server Groups, page 8-10](#)
- [Editing or Copying a Real Server Group, page 8-12](#)
- [Displaying a Real Server Group, page 8-13](#)
- [Deleting a Real Server Group, page 8-13](#)

## Editing or Copying a Real Server Group

You can edit a real server group or create a copy of a real server group under a different name.

#### Procedure

- 
- Step 1** Choose **Config > Operations > Real Servers**.
- The Real Servers table appears.
- Step 2** Click the **Groups** icon located above the Real Servers table.
- The Groups menu appears below the icon (see [Figure 8-1](#)).
- Step 3** From the Groups menu, choose the group that you want to edit.
- The Viewing Group table appears, displaying the selected group's name and associated real servers.
- Step 4** Click the **Groups** icon again and from the Groups menu, choose **Edit Group**.
- The Editing Group table appears, displaying the complete list of available real servers with the real servers currently associated with the group highlighted and checked.
- Step 5** Modify the group as needed by adding (check) or removing (uncheck) real servers as needed. Skip this step if you only want to save a copy of the current group under a different name.
- Step 6** Do one of the following:
- Click **Save** to save the changes and return to the Viewing Group table, where you can view the changes.
  - Click **Save as** to save the configuration under a new group name. The Create Group popup window appears.
 

From the popup window, do the following:

    - a. In the Group Name text box, enter a name for the group. Enter 1 to 64 alphanumeric characters. Special characters and spaces are allowed.
    - b. Choose the availability of the group by clicking one of the following radio buttons:
      - **This user only (local)**—Only you can view, modify, or delete the group.
      - **All users (global)**—All ANM users can view the group if they have permission view at least one of the real servers associated with the group. The admin user or a user with the anm-admin role can view all global groups and can also edit or delete these groups.
    - c. Do one of the following:

- Click **Save** to save the group information. The Create Group popup window closes and the Viewing Group table appears, displaying the new group's name and associated real servers.
- Click **Cancel** to close the Create Group popup window without saving any information and to return to the Creating a New Group table.

Click **Back to View** to exit the edit mode and return to the Group mode.

**Step 7** (Optional) To exit Group mode and return to the Real Servers table, click the **Groups** icon and click **Exit Group Mode** from the Groups menu.

---

#### Related Topics

- [Managing Real Server Groups, page 8-10](#)
- [Creating a Real Server Group, page 8-11](#)
- [Displaying a Real Server Group, page 8-13](#)
- [Deleting a Real Server Group, page 8-13](#)

## Displaying a Real Server Group

You can display the list of real servers associated with a real server group.

#### Procedure

---

- Step 1** Choose **Config > Operations > Real Servers**.
- The Real Servers table appears.
- Step 2** Click the **Groups** icon located above the Real Servers table.
- The Groups menu appears below the icon (see [Figure 8-1](#)).
- Step 3** From the Groups menu, choose the group that you want to display.
- The Viewing Group table appears, displaying the selected group's name and associated real servers.
- Step 4** (Optional) To exit Group mode and return to the Real Servers table, click the **Groups** icon and click **Exit Group Mode** from the Groups menu.
- 

#### Related Topics

- [Managing Real Server Groups, page 8-10](#)
- [Creating a Real Server Group, page 8-11](#)
- [Editing or Copying a Real Server Group, page 8-12](#)
- [Deleting a Real Server Group, page 8-13](#)

## Deleting a Real Server Group

You can delete a real server group. Deleting a real server group does not delete the group's associated real servers from the ANM database.

**Procedure**

- 
- Step 1** Choose **Config > Operations > Real Servers**.  
The Real Servers table appears.
- Step 2** Click the **Groups** icon located above the Real Servers table.  
The Groups menu appears below the icon (see [Figure 8-1](#)).
- Step 3** From the Groups menu, click **X** (delete) next to the group that you want to delete.  
The Delete Group confirmation popup window appears.
- Step 4** From the Delete Group confirmation popup window, do one of the following:
- Click **Delete** to removes the real server group.
  - Click **Cancel** to ignore the deletion request.
- 

**Related Topics**

- [Managing Real Server Groups, page 8-10](#)
- [Creating a Real Server Group, page 8-11](#)
- [Editing or Copying a Real Server Group, page 8-12](#)
- [Displaying a Real Server Group, page 8-13](#)

## Activating Real Servers

You can activate a real server.

**Note**

If you are using the ANM plug-in for vCenter Server to access ANM, see the “[Activating Real Servers Using vSphere Client](#)” section on page B-15.

---

**Procedure**

- 
- Step 1** Choose **Config > Operations > Real Servers**.  
The Real Servers table appears.
- Step 2** (Optional) To display only the real servers of a specific real server group, do the following:
- a. Click the **Groups** icon located above the Real Servers table. The Groups menu appears below the icon (see [Figure 8-1](#)).
  - b. From the Groups menu, choose the group to display.
- Step 3** From the Real Servers table, choose the servers that you want to activate, and click **Activate**.  
The Activate Server window appears.
- Step 4** In the Reason field of the Activate Server window, enter a reason for this action.  
You might enter a trouble ticket, an order ticket, or a user message.



---

**Note** Do not enter a password in this field.

---

**Step 5** Do one of the following:

- Click **OK** to activate the server and to return to the Real Servers table. The server appears in the table with the status Inservice.
  - Click **Cancel** to exit this procedure without activating the server and to return to the Real Servers table.
- 

#### Related Topics

- [Managing Real Servers, page 8-9](#)
- [Managing Real Server Groups, page 8-10](#)
- [Suspending Real Servers, page 8-15](#)
- [Displaying Real Servers, page 8-18](#)
- [Using the Real Server Connection Statistics Graph, page 8-22](#)
- [Using the Real Server Topology Map, page 8-23](#)

## Suspending Real Servers

You can suspend a real server.



---

**Note** If you are using the ANM plug-in for vCenter Server to access ANM, see the [“Suspending Real Servers Using vSphere Client”](#) section on page B-16.

---

#### Procedure

---

**Step 1** Choose **Config > Operations > Real Servers**.

The Real Servers table appears.

**Step 2** (Optional) To display only the real servers of a specific real server group, do the following:

- a. Click the **Groups** icon located above the Real Servers table. The Groups menu appears below the icon (see [Figure 8-1](#)).
- b. From the Groups menu, choose the group to display.

**Step 3** In the Real Servers table, choose the server that you want to suspend, and click **Suspend**.

The Suspend Real Servers window appears.

**Step 4** In the Reason field of the Suspend Real Servers window, enter the reason for this action.

You might enter a trouble ticket, an order ticket, or a user message.



---

**Note** Do not enter a password in this field.

---

**Step 5** From the Suspend Real Servers Type drop-down list, choose one of the following:

- **Graceful**—When executed on a primary server, the ACE gracefully shuts down the server with sticky connections as follows:
  - Tears down existing non-TCP connections to the server
  - Allows current TCP connections to complete
  - Allows new sticky connections for existing server connections that match entries in the sticky database
  - Load balances all new connections (other than the matching sticky connections mentioned above) to the other servers in the server farm

When executed on a backup real server, the ACE places the backup server in service standby mode.



**Note**

For the CSS, when the device is in the In Service admin state and you perform a graceful suspend operation, ANM saves the last known non-zero service (or real server) weight, and then sets the weight to zero. ANM references the saved weight when performing an Activate operation. If the current weight is zero, and a non-zero weight has been saved for that service (or real server), the Activate operation also sets the weight to the saved value.

To allow ANM to save and reset the weight value when gracefully suspending and then activating the CSS, you must have the device configured to permit SNMP traffic. For each device type, see the corresponding configuration guide to configure the device to permit SNMP traffic.

When the CSS is in the In Service Standby admin state and you perform a graceful suspend operation, ANM does not set the weight to zero.



**Note**

Graceful suspend and suspend options vary by device type. For the commands deployed by the device type when these options are selected, see the “[CLI Commands Sent from the Real Server Table](#)” section on page 8-23.

- **Suspend**—The ACE resets all non-TCP connections to the server. For TCP connections, existing flows are allowed to complete before the ACE takes the real server out of service. No new connections are allowed. The ACE resets all Secure Sockets Layer (SSL) connections to the real server.
- **Suspend and Clear Connections**—Performs the tasks described for Suspend and clears the existing connections to this server.

**Step 6** Do one of the following:

- Click **Deploy Now** to suspend the server and to return to the Real Servers table. The server appears in the table with the status Out Of Service.
- Click **Cancel** to exit this procedure without suspending the server and to return to the Real Servers table.

**Related Topics**

- [Managing Real Servers, page 8-9](#)
- [Managing Real Server Groups, page 8-10](#)



- [Activating Real Servers, page 8-14](#)
- [Displaying Real Servers, page 8-18](#)
- [Using the Real Server Connection Statistics Graph, page 8-22](#)
- [Using the Real Server Topology Map, page 8-23](#)

## Modifying Real Server Weight Value

You can modify the weight value assigned to a real server that defines the connection capacity of the server in relation to the other real servers. The ACE uses the weight value that you specify for a server in the weighted round-robin and least-connections load-balancing predictors. Servers with a higher configured weight value have a higher priority with respect to connections than servers with a lower weight. For example, a server with a weight of 5 would receive five connections for every one connection for a server with a weight of 1.



### Note

If you are using the ANM plug-in for vCenter Server to access ANM, see the [“Modifying Real Server Weight Value Using vSphere Client” section on page B-18](#).

### Procedure

- 
- Step 1** Choose **Config > Operations > Real Servers**.  
The Real Servers table appears.
- Step 2** (Optional) To display only the real servers of a specific real server group, do the following:
- Click the **Groups** icon located above the Real Servers table. The Groups menu appears below the icon (see [Figure 8-1](#)).
  - From the Groups menu, choose the group to display.
- Step 3** In the Real Servers table, choose the servers whose configuration you want to modify, and click **Change Weight** below the table to the right of Activate and Suspend.  
The Change Weight Real Servers window appears.
- Step 4** In the Change Weight Real Servers window, enter the following information for the selected server:
- Reason for change such as trouble ticket, order ticket or user message.
- 
- ### Note
- Do not enter a password in this field.
- Weight value (for allowable ranges for each device type, see [Table 8-5](#)).
- Step 5** Do one of the following:
- Click **Deploy Now** to accept your entries and to return to the Real Servers table. The server appears in the table with the updated information.
  - Click **Cancel** to exit this procedure without saving your entries and to return to the Real Servers table.
-

**Related Topics**

- [Managing Real Servers, page 8-9](#)
- [Managing Real Server Groups, page 8-10](#)
- [Activating Real Servers, page 8-14](#)
- [Displaying Real Servers, page 8-18](#)
- [Using the Real Server Connection Statistics Graph, page 8-22](#)
- [Using the Real Server Topology Map, page 8-23](#)

## Displaying Real Servers

You can display the list of real servers configured on ANM with information specific to each server.

**Procedure**

**Step 1** Choose **Config > Operations > Real Servers**.

The Real Servers table appears, which contains the information described in [Table 8-2](#).



**Note** In the table, N/A indicates that either the information is not available from the database or that it is not being collected using SNMP.

**Table 8-2** Real Server Table Fields

| Item       | Description                                                                                                                                                                                                                                                                                                                                                                                                                                                                                                                                                                                                                                                                                                                                          |
|------------|------------------------------------------------------------------------------------------------------------------------------------------------------------------------------------------------------------------------------------------------------------------------------------------------------------------------------------------------------------------------------------------------------------------------------------------------------------------------------------------------------------------------------------------------------------------------------------------------------------------------------------------------------------------------------------------------------------------------------------------------------|
| Name       | <p>Real server name.</p> <p>For CSM real servers only, if you have the reverse DNS lookup feature enabled, ANM displays the DNS name of the CSM real server in this field. ANM learns and updates the DNS names during the following operations:</p> <ul style="list-style-type: none"> <li>• CSM import</li> <li>• CSM CLI synchronization</li> <li>• ANM restart</li> </ul> <p>By default, the reverse DNS lookup feature is disabled. You can enable it by modifying the ANM properties file and restarting ANM as follows:</p> <ol style="list-style-type: none"> <li><code>echo "cisco.anm.enable-csm-dns-lookup=true" &gt;&gt; /opt/CSCOanm/etc/cs-config.properties</code></li> <li><code>/opt/CSCOanm/bin/anm-tool restart</code></li> </ol> |
| IP address | Real server IP address.                                                                                                                                                                                                                                                                                                                                                                                                                                                                                                                                                                                                                                                                                                                              |
| Port       | Port used by the real server for communications.                                                                                                                                                                                                                                                                                                                                                                                                                                                                                                                                                                                                                                                                                                     |

**Table 8-2** Real Server Table Fields (continued)

| Item       | Description                                                                                                                                                                                                                                                                                                                                                                                                                                                                                                                                                                                                                                                                                                                                                                                                                           |
|------------|---------------------------------------------------------------------------------------------------------------------------------------------------------------------------------------------------------------------------------------------------------------------------------------------------------------------------------------------------------------------------------------------------------------------------------------------------------------------------------------------------------------------------------------------------------------------------------------------------------------------------------------------------------------------------------------------------------------------------------------------------------------------------------------------------------------------------------------|
| VM         | <p>Virtual machine indicator that specifies if the real server is a VMware vCenter Server virtual machine (Yes) or is not a virtual machine (-).</p> <p>If the indicator state is Yes, you can click this link to open the Virtual Machine Details popup window to display statistical information about the VM. ANM polls the VM on a regular basis to update the displayed information.</p> <p>Click <b>OK</b> to close the popup window and return to the Real Servers table.</p>                                                                                                                                                                                                                                                                                                                                                  |
| Vservers   | Associated virtual servers.                                                                                                                                                                                                                                                                                                                                                                                                                                                                                                                                                                                                                                                                                                                                                                                                           |
| HA         | <p>Indicators that display when the real server is part of a high availability pair. The indicators are as follows:</p> <ul style="list-style-type: none"> <li>• Asterisk (*)—The real server is associated with an HA pair and the HA configuration is complete.</li> <li>• Red dash (-)—The real server is associated with an HA pair; however, the HA configuration is incomplete. Typically, the HA pair are not properly configured for HA or only one of the devices has been imported into ANM. Ensure that both devices are imported into ANM and that they are configured as described in the <a href="#">“Configuring ACE High Availability”</a> section on page 13-14.</li> </ul> <p>The table displays HA pair real servers together in the same row and they remain together no matter how you sort the information.</p> |
| SLB Device | Name of the server load-balancing device.                                                                                                                                                                                                                                                                                                                                                                                                                                                                                                                                                                                                                                                                                                                                                                                             |
| Admin      | Administrative state of the real server: In Service, Out Of Service, or In Service Standby.                                                                                                                                                                                                                                                                                                                                                                                                                                                                                                                                                                                                                                                                                                                                           |

Table 8-2 Real Server Table Fields (continued)

| Item | Description                                                                                                                                                                                                                                                                                                                                                                                                                                                                                                                                                                                                                                                                                                                                                                                                                                                                                                                                                                                                                                                                                                                                                                                                                                                                                                                                                                                                                                                                                                                                                                                                                                                                                                                                                                                                                                                                                                                                                                                                                                                                                                                                                                                                                                                                                                                                                                                                                                                                                                                                                        |
|------|--------------------------------------------------------------------------------------------------------------------------------------------------------------------------------------------------------------------------------------------------------------------------------------------------------------------------------------------------------------------------------------------------------------------------------------------------------------------------------------------------------------------------------------------------------------------------------------------------------------------------------------------------------------------------------------------------------------------------------------------------------------------------------------------------------------------------------------------------------------------------------------------------------------------------------------------------------------------------------------------------------------------------------------------------------------------------------------------------------------------------------------------------------------------------------------------------------------------------------------------------------------------------------------------------------------------------------------------------------------------------------------------------------------------------------------------------------------------------------------------------------------------------------------------------------------------------------------------------------------------------------------------------------------------------------------------------------------------------------------------------------------------------------------------------------------------------------------------------------------------------------------------------------------------------------------------------------------------------------------------------------------------------------------------------------------------------------------------------------------------------------------------------------------------------------------------------------------------------------------------------------------------------------------------------------------------------------------------------------------------------------------------------------------------------------------------------------------------------------------------------------------------------------------------------------------------|
| Oper | <p>Operational state of the real server. Possible states are as follows:</p> <ul style="list-style-type: none"> <li>• Failed—Server has failed and is not retried for the amount of time specified by its retry timer.</li> <li>• Inband probe failed—Server has failed the inband Health Probe agent.</li> <li>• Inservice—Server is in use as a destination for server load-balancing client connections.</li> <li>• Inservice standby—Server is the backup real server, which remains inactive unless the primary real server fails.</li> <li>• Operation wait—Server is ready to become operational but is waiting for the associated redirect virtual server to be in service.</li> <li>• Out of service—Server is not in use by a server load balancer as a destination for client connections.</li> <li>• Probe failed—Server load-balancing probe to this server has failed. No new connections are assigned to this server until a probe to this server succeeds.</li> <li>• Probe testing—Server has received a test probe from the server load balancer.</li> <li>• Ready to test —Server has failed and its retry timer has expired; test connections will begin flowing to it soon.</li> <li>• Return code failed—Server has been disabled because it returned an HTTP code that matched a configured value.</li> <li>• Test wait—Server is ready to be tested. This state is applicable only when the server is used for HTTP redirect load balancing.</li> <li>• Testing—Server has failed and has been given another test connection. The success of this connection is not known.</li> <li>• Throttle: DFP —DFP has lowered the weight of the server to throttle level; no new connections are assigned to the server until DFP raises its weight.</li> <li>• Throttle: max clients—Server has reached its maximum number of allowed clients.</li> <li>• Throttle: max connections —Server has reached its maximum number of connections and is no longer being given connections.</li> <li>• Unknown—State of the server is not known.</li> </ul> <p> <b>Note</b> If you have the Details popup window feature enabled, click the value in this column to open the Details popup window and display detailed information about the real server. By default, this feature is disabled. For information about enabling or disabling this feature, see the <a href="#">“Enabling the ACE Real Server Details Popup Window Option”</a> section on page 18-64.</p> |
| Conn | Number of current connections.                                                                                                                                                                                                                                                                                                                                                                                                                                                                                                                                                                                                                                                                                                                                                                                                                                                                                                                                                                                                                                                                                                                                                                                                                                                                                                                                                                                                                                                                                                                                                                                                                                                                                                                                                                                                                                                                                                                                                                                                                                                                                                                                                                                                                                                                                                                                                                                                                                                                                                                                     |
| Wt   | Current server weight.                                                                                                                                                                                                                                                                                                                                                                                                                                                                                                                                                                                                                                                                                                                                                                                                                                                                                                                                                                                                                                                                                                                                                                                                                                                                                                                                                                                                                                                                                                                                                                                                                                                                                                                                                                                                                                                                                                                                                                                                                                                                                                                                                                                                                                                                                                                                                                                                                                                                                                                                             |

**Table 8-2** Real Server Table Fields (continued)

| Item        | Description                                                                                                                                                                                                                                                                                                                                                                                                                                                                                                                                                                                                                                                                                                                                                                                                                                                                                                                                                     |
|-------------|-----------------------------------------------------------------------------------------------------------------------------------------------------------------------------------------------------------------------------------------------------------------------------------------------------------------------------------------------------------------------------------------------------------------------------------------------------------------------------------------------------------------------------------------------------------------------------------------------------------------------------------------------------------------------------------------------------------------------------------------------------------------------------------------------------------------------------------------------------------------------------------------------------------------------------------------------------------------|
| Locality    | <p>Item that pertains only to ACE software Version A4(2.0) or later releases on either device type (appliance or module). Locality also requires that you have the ACE configured for Dynamic Workload Scaling (see the <a href="#">“Configuring Dynamic Workload Scaling”</a> section on page 8-26).</p> <p>Location of the real server, which must be a VM and not a physical server. Possible locality states are as follows:</p> <ul style="list-style-type: none"> <li>• N/A—Not available; the ACE cannot determine if the real server is local or remote. A possible cause for this issue is that Dynamic Workload Scaling is not configured correctly.</li> <li>• Local—The real server is located in the local network.</li> <li>• Remote—The real server is located in the remote network. The ACE bursts traffic to this server when the CPU and/or memory usage of the local real servers reaches the specified maximum threshold value.</li> </ul> |
| Stat Age    | Age of the statistical information.                                                                                                                                                                                                                                                                                                                                                                                                                                                                                                                                                                                                                                                                                                                                                                                                                                                                                                                             |
| Server Farm | Associated server farm.                                                                                                                                                                                                                                                                                                                                                                                                                                                                                                                                                                                                                                                                                                                                                                                                                                                                                                                                         |

- Step 2** (Optional) To display only the real servers of a specific real server group, do the following:
- Click the **Groups** icon located above the Real Servers table. The Groups menu appears below the icon (see [Figure 8-1](#)).
  - From the Groups menu, choose the group to display.
- Step 3** (Optional) Use the function buttons located at the bottom of the window to activate or suspend a real server, change the weight assigned to a real server, and so forth. [Table 8-3](#) describes the check box and function button options.

**Table 8-3** Real Server Window Check Box and Function Button Options

| Check Box/Function Button | Description                                                                                                                                                                       |
|---------------------------|-----------------------------------------------------------------------------------------------------------------------------------------------------------------------------------|
| Poll Now                  | Function button that updates the displayed information.                                                                                                                           |
| Activate                  | Function button that activates a suspended real server (see the <a href="#">“Activating Real Servers”</a> section on page 8-14).                                                  |
| Suspend                   | Function button that suspends an active real server (see the <a href="#">“Suspending Real Servers”</a> section on page 8-15).                                                     |
| Change Weight             | Function button used to change the weight assigned to a real server (see the <a href="#">“Server Weight Ranges”</a> section on page 8-25).                                        |
| Graph                     | Function button that displays the statistics graph for a selected real server (see the <a href="#">“Using the Real Server Connection Statistics Graph”</a> section on page 8-22). |
| Topology                  | Function button that displays the topology map for a selected real server (see the <a href="#">“Using the Real Server Topology Map”</a> section on page 8-23).                    |

- Step 4** (Optional) To identify any SNMP-related issues, select the real server’s virtual context in the object selector. If there are problems with SNMP, the SNMP status appears in the upper right above the content pane.

**Related Topics**

- [Displaying Real Server Statistics and Status Information, page 8-9](#)
- [Using the Real Server Connection Statistics Graph, page 8-22](#)
- [Managing Real Server Groups, page 8-10](#)
- [Using the Real Server Topology Map, page 8-23](#)
- [Activating Real Servers, page 8-14](#)
- [Suspending Real Servers, page 8-15](#)
- [Modifying Real Server Weight Value, page 8-17](#)
- [Enabling the ACE Real Server Details Popup Window Option, page 18-64](#)
- [Filtering Entries, page 1-14](#)

## Using the Real Server Connection Statistics Graph

You can display real time and historical statistical information about the connections of a real server. ANM displays the information in graph or chart form. This feature also allows you to compare similar connection information across multiple real servers.

**Procedure**

---

**Step 1** Choose **Config > Operations > Real Servers**.

The Real Servers table appears.

**Step 2** (Optional) To display only the real servers of a specific real server group, do the following:

- a. Click the **Groups** icon located above the Real Servers table. The Groups menu appears below the icon (see [Figure 8-1](#)).
- b. From the Groups menu, choose the group to display.

**Step 3** In the Real Servers table, check the check box next to server whose connection information you want to display, and click **Graph**.

You can choose up to four real servers if you want to compare statistical data.

The Real Server Graph window appears, displaying the default graph for each selected real server. For details about using the graph feature, see the [“Configuring Historical Trend and Real Time Graphs for Devices”](#) section on page 17-48.

---

**Related Topics**

- [Managing Real Server Groups, page 8-10](#)
- [Activating Real Servers, page 8-14](#)
- [Suspending Real Servers, page 8-15](#)
- [Modifying Real Server Weight Value, page 8-17](#)
- [Displaying Real Servers, page 8-18](#)
- [Using the Real Server Topology Map, page 8-23](#)

## Using the Real Server Topology Map

You can display the nodes on your network based on the real server that you select.

### Procedure

- 
- Step 1** Choose **Config > Operations > Real Servers**.  
The Real Servers table appears.
- Step 2** (Optional) To display only the real servers of a specific real server group, do the following:
- Click the **Groups** icon located above the Real Servers table. The Groups menu appears below the icon (see [Figure 8-1](#)).
  - From the Groups menu, choose the group to display.
- Step 3** In the Real Servers table, choose the server whose topology map you want to display, and click **Topology**.  
The ANM Topology map appears. The map includes several tools for navigating the network map and zooming in and out. For details about using the map tools, see the [“Displaying Network Topology Maps” section on page 17-68](#).
- Step 4** Click **Exit** to return to the Real Server widow.
- 

### Related Topics

- [Managing Real Server Groups, page 8-10](#)
- [Activating Real Servers, page 8-14](#)
- [Suspending Real Servers, page 8-15](#)
- [Modifying Real Server Weight Value, page 8-17](#)
- [Displaying Real Servers, page 8-18](#)
- [Using the Real Server Connection Statistics Graph, page 8-22](#)

## CLI Commands Sent from the Real Server Table

[Table 8-4](#) displays the CLI commands dispatched to the device for a given Real Servers table option and is sorted by device type.

**Table 8-4** CLI Commands Deployed from the Real Servers Table

| Command                           | Sample CLI Sent                                    |
|-----------------------------------|----------------------------------------------------|
| <b>ACE Modules and Appliances</b> |                                                    |
| Real Server Activation            | serverfarm host sf1<br>rserver rs1 80<br>inservice |

**Table 8-4** CLI Commands Deployed from the Real Servers Table (continued)

| Command                                   | Sample CLI Sent                                                                                                                  |
|-------------------------------------------|----------------------------------------------------------------------------------------------------------------------------------|
| Real Server Graceful Suspend              | serverfarm host sf1<br>rserver rs1 80<br>inservice standby                                                                       |
| Real Server Suspend                       | serverfarm host sf1<br>rserver rs1 80<br>no inservice                                                                            |
| Real Server Suspend and Clear Connections | serverfarm host sf1<br>rserver rs1 80<br>no inservice<br>clear conn rserver rs1 80 serverfarm sf1                                |
| Real Server Change Weight                 | serverfarm host sf1<br>rserver rs1 80<br>weight 2                                                                                |
| <b>CSMs</b>                               |                                                                                                                                  |
| Real Server Activation                    | serverfarm host sf1<br>real 10.10.10.10 80<br>inservice                                                                          |
| Real Server Graceful Suspend              | serverfarm host sf1<br>real 10.10.10.10 80<br>inservice standby                                                                  |
| Real Server Suspend                       | serverfarm host sf1<br>real 10.10.10.10 80<br>no inservice                                                                       |
| Real Server Suspend and Clear Connections | serverfarm host sf1<br>real 10.10.10.10 80<br>no inservice<br>clear module contentSwitchingModule 3 connections real 10.10.10.10 |
| Real Server Change Weight                 | serverfarm host sf1<br>rserver 10.10.10.10 80<br>weight 2                                                                        |
| <b>CSM Named Real Commands Sent</b>       |                                                                                                                                  |
| Real Server Activation                    | serverfarm host sf1<br>real name rs1 80<br>inservice                                                                             |
| Real Server Graceful Suspend              | serverfarm host sf1<br>real name rs1 80<br>inservice standby                                                                     |



**Table 8-4** CLI Commands Deployed from the Real Servers Table (continued)

| Command                                   | Sample CLI Sent                                                                                                                          |
|-------------------------------------------|------------------------------------------------------------------------------------------------------------------------------------------|
| Real Server Suspend                       | <pre>serverfarm host sf1     real name rs1 80     no inservice</pre>                                                                     |
| Real Server Suspend and Clear Connections | <pre>serverfarm host sf1     real name rs1 80     no inservice  clear module contentSwitchingModule 3 connections real 10.10.10.10</pre> |
| Real Server Change Weight                 | <pre>serverfarm host sf1     real name rs1 80     weight 2</pre>                                                                         |
| <b>CSS Devices</b>                        |                                                                                                                                          |
| Real Server Activation                    | <pre>service myReal7     active</pre>                                                                                                    |
| Real Server Graceful Suspend              | <pre>service myReal7     weight 0</pre>                                                                                                  |
| Real Server Suspend                       | <pre>service myReal7     suspend</pre>                                                                                                   |
| Real Server Suspend and Clear Connections | <pre>service myReal7     suspend</pre>                                                                                                   |
| Real Server Change Weight                 | <pre>service myReal7     weight 2</pre>                                                                                                  |

## Server Weight Ranges

Table 8-5 displays the allowable server weight ranges by device type.

**Table 8-5** Real Servers Table Server Weight Ranges

| Device Type                | Valid Weight Configurations |
|----------------------------|-----------------------------|
| ACE Appliances and Modules | 1 to 100                    |
| CSMs                       | 0 to 100                    |
| CSS Devices                | 0 to 10                     |

# Configuring Dynamic Workload Scaling

**Note**

Dynamic Workload Scaling requires ACE software Version A4(2.0) or later release on either device type (appliance or module).

This section describes how to configure the ACE Dynamic Workload Scaling (DWS) feature, which enables an ACE to burst traffic to a remote pool of VMs when the average CPU and/or memory usage of the local VMs has reached a specified maximum threshold value. When the usage drops below a specified minimum threshold value, the ACE stops bursting traffic to the remote VMs.

**Note**

To enable the ACE to use the VMs associated with DWS for load balancing, you must configure them as real servers on the ACE (see the [“Configuring Real Servers”](#) section on page 8-5).

For more information about DWS, see the [“ANM Overview”](#) section on page 1-1 and the [“Dynamic Workload Scaling Overview”](#) section on page 8-4.

## Prerequisites

DWS requires the following configuration elements:

- An ACE with software Version A4(2.0) or later and configured with the following items:
  - Nexus 7000 Series switch—XML interface IP address of the local Cisco Nexus 7000 Series switch that the ACE polls to obtain VM location information (local or remote). You can define up to two switch profiles per Admin context depending on the ACE software version (see [Guidelines and Restrictions](#)). For information about defining a switch profile, see the [“Configuring and Verifying a Cisco Nexus 7000 Series Switch Connection”](#) section on page 8-27.
- VMware vCenter Server 4.0 or later.
- Multiple local and remote VMs configured as real servers and associated with server farms configured on the ACE.
- ACE backend interface MTU set to 1430 or less to accommodate DCI encapsulation and the Don't Fragment (DF) bit is automatically set on the DCI link. For details about setting the ACE MTU, see the *Cisco 4700 Series Application Control Engine Appliance Routing and Bridging Configuration Guide*.

**Note**

The Nexus 7000 Series switch must be configured for DCI/OTV in the local data center and in the remote data center. For details about configuring a Nexus 7000 for DCI/OTV, see the *Cisco Nexus 7000 NX-OS OTV Configuration Guide, Release 5.x*.

- VM Controller—IP address of the VM Controller (also known as VMware vCenter Server) that the ACE sends a health probe to monitor usage of the local VMs associated with a server farm.
- VM probe—Probe that the ACE sends to the VM Controller to monitor local VM usage based on CPU usage, memory usage, or both (see the [“Configuring Health Monitoring”](#) section on page 8-49).
- Server Farms—Groups of networked real servers (physical servers and VMs) that provide content delivery (see the [“Configuring Server Farms”](#) section on page 8-30).

This section includes the following topics:

- [Configuring and Verifying a Cisco Nexus 7000 Series Switch Connection, page 8-27](#)
- [Configuring and Verifying a VM Controller Connection, page 8-29](#)

## Configuring and Verifying a Cisco Nexus 7000 Series Switch Connection



### Note

This feature requires ACE software Version A4(2.0) or later release on either device type (appliance or module).

You can configure an ACE with the Cisco Nexus 7000 Series switch attributes required to allow the ACE to communicate with the switch using SSH. When configured for DWS, the ACE uses the Nexus 7000 Series switch to obtain VM location information (local or remote).

You can also use this procedure to edit the attributes of an existing Nexus 7000 Series switch profile or remove a switch profile.

### Guidelines and Restrictions

The number of Nexus 7000 Series switch profiles that you can define per ACE Admin context is as follows:

- ACE software Version A4(2.0) to A5(1.1)—One switch profile only.
- ACE software Version A5(1.2) or later—Up to two switch profiles.

### Procedure

**Step 1** Choose **Config > Devices > Admin\_context > Load Balancing > Dynamic Workload Scaling > Nexus 7000 Setup**.

The Nexus 7000 Setup pane appears.



### Note

If existing Nexus 7000 Series switch profiles already exist, the Name field lists their profile names in drop-down list on the right. Multiple switch profiles requires ACE software Version A5(1.2) or later.

**Step 2** From the Nexus 7000 Setup pane, do one of the following:

- To define a new Nexus 7000 series switch profile, do the following:
  - a. From the Name field, click the text box radio button if it is not already selected and enter a Nexus 7000 name with a maximum of 64 characters. See the [Note](#) at the beginning of this chapter for ACE object naming specifications.
  - b. From the Primary IP field, enter the Nexus 7000 XML interface IP address in dotted-decimal format (such as 192.168.11.1).
  - c. From the User Name field, enter the username that the ACE uses for access and authentication on the Nexus 7000 Series switch. Valid entries are unquoted text strings with a maximum of 64 characters with no spaces.



---

**Note** The user must have either the vdc-admin or network-admin role to receive the Nexus 7000 Series switch output for the VM location information in XML format.

---

d. From the Password field, enter the password that the ACE uses for authentication on the Nexus 7000 Series switch. Valid entries are unquoted text strings with a maximum of 64 characters with no spaces.

e. From the Confirm field, reenter the password and go to [Step 3](#).

- To edit an existing Nexus 7000 Series switch profile, do the following:
  - a. From the Name field, click the radio button for the drop down list that contains the list of existing switch profile names.
  - b. From the drop down list, choose the switch profile to edit. The current profile attributes display.
  - c. Edit the profile fields as described in the procedure above for creating a new profile and go to [Step 3](#).

**Step 3** Click **Deploy Now** to deploy this configuration on the ACE and save your entries to the running-configuration and startup-configuration files.



---

**Note** Configuring the ACE for DWS also requires configuring the ACE with the VM Controller information (see the [“Configuring and Verifying a VM Controller Connection”](#) section on [page 8-29](#)) and configuring a VM health probe (see the [“Configuring Health Monitoring”](#) section on [page 8-49](#)).

---

**Step 4** (Optional) Click **Details** to verify connectivity between the ACE and the Nexus 7000 Series switch. The ACE **show nexus-device device\_name detail** CLI command output displays in a popup window and includes information such as the device name, IP address, and connection information. For more information about the command output, see the *Cisco 4700 Series Application Control Engine Appliance Server Load-Balancing Configuration Guide*.

**Step 5** (Optional) Click **Delete** to delete the currently configured Cisco Nexus 7000 series switch.



---

**Caution** If the ACE is currently configured for DWS, deleting the Nexus 7000 Series switch disables the feature.

---

#### Related Topics

- [Configuring and Verifying a VM Controller Connection, page 8-29](#)
- [Configuring Health Monitoring, page 8-49](#)
- [Configuring Dynamic Workload Scaling, page 8-26](#)
- [Dynamic Workload Scaling Overview, page 8-4](#)
- [Configuring Real Servers, page 8-5](#)
- [Configuring Load Balancing Using Server Farms, page 8-31](#)

## Configuring and Verifying a VM Controller Connection



**Note** This feature requires ACE software Version A4(2.0) or later release on either device type (appliance or module).

You can configure an ACE with the VM Controller (VMware vCenter Server) attributes required to allow the ACE to communicate with the VM Controller to obtain local VM load information.

### Guidelines and Restrictions

Configure only one VM Controller per ACE Admin context.

### Prerequisites

The ACE is configured to communicate with the local Cisco Nexus 7000 Series switch that enables the ACE to discover the locality of the VM Controller VMs (see the [“Configuring and Verifying a Cisco Nexus 7000 Series Switch Connection”](#) section on page 8-27).

### Procedure

- Step 1** Choose **Config > Devices > Admin\_context > Load Balancing > Dynamic Workload Scaling > VM Controller Setup**.
- The VM Controller Setup pane appears.
- Step 2** From the VM Controller Setup pane, define the VM Controller using the information in [Table 8-6](#).

**Table 8-6** VM Controller Setup

| Field     | Description                                                                                                                                                                                                                                         |
|-----------|-----------------------------------------------------------------------------------------------------------------------------------------------------------------------------------------------------------------------------------------------------|
| Name      | VM Controller name (see the <a href="#">Note</a> at the beginning of this chapter for ACE object naming specifications).                                                                                                                            |
| URL       | IP address or URL for the VM Controller web services API agent. The URL must point to the VM Controller software development kit (SDK). For example, https://1.2.3.4/sdk. Enter up to 255 characters.                                               |
| User Name | Username that the ACE uses for access and authentication on the VM Controller. The user must have a read-only role at least or a role with a read privilege. Valid entries are unquoted text strings with a maximum of 64 characters and no spaces. |
| Password  | Password that the ACE uses for authentication on the VM Controller. Valid entries are unquoted text strings with a maximum of 64 characters and no spaces.<br>Reenter the password in the Confirm field.                                            |

- Step 3** Click **Deploy Now** to deploy this configuration on the ACE and save your entries to the running-configuration and startup-configuration files.



**Note** Configuring the ACE for Dynamic Workload Scaling also requires configuring the ACE with the Nexus 7000 information (see the [“Configuring and Verifying a Cisco Nexus 7000 Series Switch Connection”](#) section on page 8-27) and configuring a VM health probe (see the [“Configuring Health Monitoring”](#) section on page 8-49).

- Step 4** (Optional) Click **Details** to verify connectivity between the ACE and the remote VM Controller. The ACE **show vm-controller device\_name detail** CLI command output displays in a popup window and includes information such as the VM Controller status, IP address, and connection information.
- Step 5** (Optional) Click **Delete** to delete the currently configured VM Controller.



---

**Note** If the ACE is currently configured for Dynamic Workload Scaling, you must delete the associated VM health probe before you can delete the VM controller (see the “[Configuring Health Monitoring](#)” section on page 8-49).

---

#### Related Topics

- [Configuring and Verifying a Cisco Nexus 7000 Series Switch Connection](#), page 8-27
- [Configuring Health Monitoring](#), page 8-49
- [Configuring Dynamic Workload Scaling](#), page 8-26
- [Dynamic Workload Scaling Overview](#), page 8-4
- [Configuring Real Servers](#), page 8-5
- [Configuring Load Balancing Using Server Farms](#), page 8-31

## Configuring Server Farms

You can configure load balancing using server farms, which are groups of networked real servers (physical servers and VMs) that contain the same content and that typically reside in the same physical location in a data center.

Websites often include groups of servers configured in a server farm. Load-balancing software distributes client requests for content or services among the real servers based on the configured policy and traffic classification, server availability and load, and other factors. If one server goes down, another server can take its place and continue to provide the same content to the clients who requested it.

#### Guidelines and Restrictions

- With Dynamic Workload Scaling configured on the ACE, the real servers that are VMs can also reside in a remote datacenter (see the “[Configuring Dynamic Workload Scaling](#)” section on page 8-26).
- A server farm can support a mix of IPv6 and IPv4 real servers, and can be associated with both IPv6 and IPv4 probes. IPv6 requires ACE module and ACE appliance software Version A5(1.0) or later.

This section includes the following topics:

- [Configuring Load Balancing Using Server Farms](#), page 8-31
- [Adding Real Servers to a Server Farm](#), page 8-37
- [Configuring the Predictor Method for Server Farms](#), page 8-39
- [Configuring Server Farm HTTP Return Error-Code Checking](#), page 8-46
- [Displaying All Server Farms](#), page 8-48
- [Displaying Server Farm Statistics and Status Information](#), page 8-48

## Configuring Load Balancing Using Server Farms

### Procedure

- Step 1** Choose **Config > Devices > context > Load Balancing > Server Farms**.  
The Server Farms table appears.
- Step 2** In the Server Farms table, click **Poll Now** to instruct ANM to poll the devices and display the current values, and click **OK** when prompted if you want to poll the devices for data now.
- Step 3** Click **Add** to add a new server farm, or choose an existing server farm and click **Edit**.  
The Server Farms configuration window appears.
- Step 4** In the Server Farms configuration window, configure the server farm using the information in [Table 8-7](#).

**Table 8-7** Server Farm Attributes

| Field       | Description                                                                                                                                                                                                                                                                                                                                                                                                                                                                                                                                                                                                                                                                                                                                                                                      |
|-------------|--------------------------------------------------------------------------------------------------------------------------------------------------------------------------------------------------------------------------------------------------------------------------------------------------------------------------------------------------------------------------------------------------------------------------------------------------------------------------------------------------------------------------------------------------------------------------------------------------------------------------------------------------------------------------------------------------------------------------------------------------------------------------------------------------|
| Name        | Unique name for this server farm or accept the automatically incremented value in this field. Valid entries are unquoted text strings with no spaces and a maximum of 64 characters.                                                                                                                                                                                                                                                                                                                                                                                                                                                                                                                                                                                                             |
| Type        | Type of server farm as follows: <ul style="list-style-type: none"> <li>• <b>Host</b>—Server farm consists of real servers that provide content and services to clients.</li> <li>• <b>Redirect</b>—Server farm consists only of real servers that redirect client requests to alternate locations specified in the real server configuration. (See the “<a href="#">Configuring Real Servers</a>” section on page 8-5.)</li> </ul>                                                                                                                                                                                                                                                                                                                                                               |
| Description | Brief description for this server farm. Valid entries are unquoted alphanumeric text strings with no spaces and a maximum of 240 characters.                                                                                                                                                                                                                                                                                                                                                                                                                                                                                                                                                                                                                                                     |
| Fail Action | Action that the ACE is to take with respect to connections if any real server in the server farm fails: <ul style="list-style-type: none"> <li>• <b>N/A</b>—The ACE is to take no action if any server in the server farm fails.</li> <li>• <b>Purge</b>—The ACE is to remove connections to a real server if that real server in the server farm fails. The ACE sends a reset command to both the client and the server that failed.</li> <li>• <b>Reassign</b>—The ACE is to reassign the existing server connections to the backup real server (if configured) if the real server fails after you enter this command. If a backup real server has not been configured for the failing server, this selection leaves the existing connections untouched in the failing real server.</li> </ul> |

Table 8-7 Server Farm Attributes (continued)

| Field                            | Description                                                                                                                                                                                                                                                                                                                                                                                                                                                                                                                                                                                                                                                                                                                                                                                                                                                                                                                                                                                                                                                                                                                                                                                                                                                                                                                                                                                                                                                                                                                                                                                                                                                                                                                                                                                                                                                                                                                                                                                                                                                                                                                                                                                                                                                                                                                                                                                                                                                                                                                                                                                                                                                                                                                                                                                                                                                                                                                                                                                                                                                                                                                                                                                                                                                                                                                                                                                                                                                                                                                                                                                                                                   |
|----------------------------------|-----------------------------------------------------------------------------------------------------------------------------------------------------------------------------------------------------------------------------------------------------------------------------------------------------------------------------------------------------------------------------------------------------------------------------------------------------------------------------------------------------------------------------------------------------------------------------------------------------------------------------------------------------------------------------------------------------------------------------------------------------------------------------------------------------------------------------------------------------------------------------------------------------------------------------------------------------------------------------------------------------------------------------------------------------------------------------------------------------------------------------------------------------------------------------------------------------------------------------------------------------------------------------------------------------------------------------------------------------------------------------------------------------------------------------------------------------------------------------------------------------------------------------------------------------------------------------------------------------------------------------------------------------------------------------------------------------------------------------------------------------------------------------------------------------------------------------------------------------------------------------------------------------------------------------------------------------------------------------------------------------------------------------------------------------------------------------------------------------------------------------------------------------------------------------------------------------------------------------------------------------------------------------------------------------------------------------------------------------------------------------------------------------------------------------------------------------------------------------------------------------------------------------------------------------------------------------------------------------------------------------------------------------------------------------------------------------------------------------------------------------------------------------------------------------------------------------------------------------------------------------------------------------------------------------------------------------------------------------------------------------------------------------------------------------------------------------------------------------------------------------------------------------------------------------------------------------------------------------------------------------------------------------------------------------------------------------------------------------------------------------------------------------------------------------------------------------------------------------------------------------------------------------------------------------------------------------------------------------------------------------------------------|
| Failaction Reassign Across Vlans | <p>Option that is available only for the ACE module A2(3.0), ACE appliance A4(1.0), and later releases of either device type. This field appears only when the Fail Action is set to Reassign.</p> <p>Check the check box to specify that the ACE reassigns the existing server connections to the backup real server on a different VLAN interface (commonly referred to as a bypass VLAN) if the real server fails. If a backup real server has not been configured for the failing server, this option has no effect and leaves the existing connections untouched in the failing real server.</p> <p>Note the following configuration requirements and restrictions when you enable this option:</p> <ul style="list-style-type: none"> <li>• Enable the Transparent option (see the next Field) to instruct the ACE not to use NAT to translate the ACE VIP address to the server IP address. The Failaction Reassign Across Vlans option is intended for use in stateful firewall load balancing (FWLB) on your ACE, where the destination IP address for the connection coming in to the ACE is for the end-point real server, and the ACE reassigns the connection so that it is transmitted through a different next hop.</li> <li>• Enable the MAC Sticky option on all server-side interfaces to ensure that packets that are going to and coming from the same server in a flow will traverse the same firewalls or stateful devices (see the <a href="#">“Configuring Virtual Context VLAN Interfaces”</a> section on page 12-6).</li> <li>• Configure the Predictor Hash Address option after you add the serverfarm (see the <a href="#">“Configuring the Predictor Method for Server Farms”</a> section on page 8-39).</li> <li>• You must configure identical policies on the primary interface and the backup-server interface. The backup interface must have the same feature configurations as the primary interface.</li> <li>• If you configure a policy on the backup-server interface that is different from the policies on the primary-server interface, that policy will be effective only for new connections. The reassigned connection will always have only the primary-server interface policies.</li> <li>• Interface-specific features (for example, NAT, application protocol inspection, outbound ACLs, or SYN cookie) are not supported.</li> <li>• You cannot reassign connections to the failed real server after it comes back up. This restriction also applies to same-VLAN backup servers.</li> <li>• Real servers must be directly connected to the ACE. This requirement also applies to same-VLAN backup server.</li> <li>• You must disable sequence number randomization on the firewall (see the <a href="#">“Configuring Connection Parameter Maps”</a> section on page 10-3).</li> <li>• Probe configurations should be similar on both ACEs and the interval values should be low. For example, if you configure a high interval value on ACE-1 and a low interval value on ACE-2, the reassigned connections may become stuck because of the probe configuration mismatch. ACE-2 with the low interval value will detect the primary server failure first and will reassign all its incoming connections to the backup-server interface VLAN. ACE-1 with the high interval value may not detect the failure before the primary server comes back up and will still point to the primary server.</li> </ul> <p>To minimize packet loss, we recommend the following probe parameter values on both ACEs: Interval: 2, Faildetect: 2, Passdetect interval: 2, and Passdetect count: 5.</p> |



Table 8-7 Server Farm Attributes (continued)

| Field                    | Description                                                                                                                                                                                                                                                                                                                                                                                                                                                                                                                                                                                                                                                                                                                                                                                                                                                                                                                                                                                                                                                                                                                                                                                                                                                                                                                                                                    |
|--------------------------|--------------------------------------------------------------------------------------------------------------------------------------------------------------------------------------------------------------------------------------------------------------------------------------------------------------------------------------------------------------------------------------------------------------------------------------------------------------------------------------------------------------------------------------------------------------------------------------------------------------------------------------------------------------------------------------------------------------------------------------------------------------------------------------------------------------------------------------------------------------------------------------------------------------------------------------------------------------------------------------------------------------------------------------------------------------------------------------------------------------------------------------------------------------------------------------------------------------------------------------------------------------------------------------------------------------------------------------------------------------------------------|
| Transparent              | <p>Field that appears only for host server farms.</p> <p>Specify whether network address translation from the VIP address to the server IP is to occur. Check the check box to indicate that network address translation from the VIP address to the server IP address is to occur. Uncheck the check box to indicate that network address translation from the VIP address to the server IP address is not to occur.</p>                                                                                                                                                                                                                                                                                                                                                                                                                                                                                                                                                                                                                                                                                                                                                                                                                                                                                                                                                      |
| Dynamic Workload Scaling | <p>Option that is available only for ACE software Version A4(2.0) or later release on either device type (appliance or module). Field that appears only for host server farms.</p> <p>Allows the ACE to burst traffic to remote VMs when the average CPU or memory usage of the local VMs has reached its specified maximum threshold value. The ACE stops bursting traffic to the remote VMs when the average CPU or memory usage of the local VMs has dropped below its specified minimum threshold value. This option requires that you have the ACE configured for Dynamic Workload Scaling using a Nexus 7000, VM Controller, and VM probe (see the <a href="#">“Configuring Dynamic Workload Scaling”</a> section on page 8-26).</p> <p>Click one of the following radio button options:</p> <ul style="list-style-type: none"> <li>• N/A—Not applicable (default).</li> <li>• Local—Restricts the ACE to use of local VMs only for server load balancing.</li> <li>• Burst—Enables the ACE to burst traffic to remote VMs when needed.</li> </ul> <p>When you choose Burst, the VM Probe Name field displays along with a list of available VM probes. Choose an available VM probe or click <b>Add</b> to display the Health Monitoring popup window and create or edit a VM probe (see the <a href="#">“Configuring Health Monitoring”</a> section on page 8-49).</p> |
| Fail-On-All              | <p>Field that appears only for host server farms.</p> <p>By default, real servers that you configure in a server farm inherit the probes that you configure directly on that server farm. When you configure multiple probes on a server farm, the real servers in the server farm use an OR logic with respect to the probes, which means that if one of the probes configured on the server farm fails, all the real servers in that server farm fail and enter the PROBE-FAILED state. With AND logic, if one server farm probe fails, the real servers in the server farm remain in the operational state. If all the probes associated with the server farm fail, then all the real servers in that server farm fail and enter the PROBE-FAILED state.</p> <p>Check this check box to configure the real servers in a server farm to use AND logic with respect to multiple server farm probes.</p> <p>The Fail-On-All function is applicable to all probe types.</p>                                                                                                                                                                                                                                                                                                                                                                                                     |



Table 8-7 Server Farm Attributes (continued)

| Field                              | Description                                                                                                                                                                                                                                                                                                                                                                                                                                                                                                                                                                                                                                                                                                                                                                                                                                                                                                                                                                                                                                                                                                                                                                                                                                                                                                                                                                                                                                                                                                                                                                                                                                                                                         |
|------------------------------------|-----------------------------------------------------------------------------------------------------------------------------------------------------------------------------------------------------------------------------------------------------------------------------------------------------------------------------------------------------------------------------------------------------------------------------------------------------------------------------------------------------------------------------------------------------------------------------------------------------------------------------------------------------------------------------------------------------------------------------------------------------------------------------------------------------------------------------------------------------------------------------------------------------------------------------------------------------------------------------------------------------------------------------------------------------------------------------------------------------------------------------------------------------------------------------------------------------------------------------------------------------------------------------------------------------------------------------------------------------------------------------------------------------------------------------------------------------------------------------------------------------------------------------------------------------------------------------------------------------------------------------------------------------------------------------------------------------|
| Inband-Health Check                | <p>Option that is available only for the ACE module A4(1.0), ACE appliance A4(1.0), and later releases of either device type. Field that appears only for host server farms.</p> <p>By default, the ACE monitors the health of all real servers in a configuration through the use of ARPs and health probes. However, there is latency period between when the real server goes down and when the ACE becomes aware of the state. The inband health monitoring feature allows the ACE to monitor the health of the real servers in the server farm through the following connection failures:</p> <ul style="list-style-type: none"> <li>• For TCP, resets (RSTs) from the server or SYN timeouts.</li> <li>• For UDP, ICMP Host, Network, Port, Protocol, and Source Route unreachable messages.</li> </ul> <p>When you configure the failure-count threshold and the number of these failures exceeds the threshold within the reset-time interval, the ACE immediately marks the server as failed, takes it out of service, and removes it from load balancing. The server is not considered for load balancing until the optional resume-service interval expires.</p> <p>The Inband-Health Check attributes are as follows:</p> <ul style="list-style-type: none"> <li>• Count—Tracks the total number of TCP or UDP failures, and increments the counters.</li> <li>• Log—Logs a syslog error message when the number of events reaches the threshold value that you set for the Connection Failure Threshold Count attribute.</li> <li>• Remove—Logs a syslog error message when the number of events reaches the configured threshold and removes the real server from service.</li> </ul> |
| Connection Failure Threshold Count | <p>This field appears only when the Inband-Health Check is set to Log or Remove.</p> <p>Enter the maximum number of connection failures that a real server can exhibit in the reset-time interval before ACE marks the real server as failed. Valid entries are as follows:</p> <ul style="list-style-type: none"> <li>• ACE appliance—1 to 4294967295</li> <li>• ACE module—4 to 4294967295</li> </ul>                                                                                                                                                                                                                                                                                                                                                                                                                                                                                                                                                                                                                                                                                                                                                                                                                                                                                                                                                                                                                                                                                                                                                                                                                                                                                             |
| Reset Timeout (Milliseconds)       | <p>This field appears only when the Inband-Health Check is set to Log or Remove.</p> <p>Enter the number of milliseconds for the reset-time interval. Valid entries are integers from 100 to 300000. The default interval is 100.</p> <p>This interval starts when the ACE detects a connection failure. If the connection failure threshold is reached during this interval, the ACE generates a syslog message. If you configure the <b>remove</b> keyword, the ACE also removes the real server from service.</p> <p>Changing the setting of this option affects the behavior of the real server, as follows:</p> <ul style="list-style-type: none"> <li>• When the real server is in the OPERATIONAL state, even if several connection failures have occurred, the new reset-time interval takes effect the next time that a connection error occurs.</li> <li>• When the real server in the INBAND-HM-FAILED state, the new reset-time interval takes effect the next time that a connection error occurs after the server transitions to the OPERATIONAL state.</li> </ul>                                                                                                                                                                                                                                                                                                                                                                                                                                                                                                                                                                                                                    |

Table 8-7 Server Farm Attributes (continued)

| Field                        | Description                                                                                                                                                                                                                                                                                                                                                                                                                                                                                                                                                                                                                                                                                                                                                                                                                                                                                                                                                                                                                                                                                                                                                                                                                                                                                                                                                                                                                                                                                                                                                                                                                                                                                                                                                                                                                                                                                                                                                                          |
|------------------------------|--------------------------------------------------------------------------------------------------------------------------------------------------------------------------------------------------------------------------------------------------------------------------------------------------------------------------------------------------------------------------------------------------------------------------------------------------------------------------------------------------------------------------------------------------------------------------------------------------------------------------------------------------------------------------------------------------------------------------------------------------------------------------------------------------------------------------------------------------------------------------------------------------------------------------------------------------------------------------------------------------------------------------------------------------------------------------------------------------------------------------------------------------------------------------------------------------------------------------------------------------------------------------------------------------------------------------------------------------------------------------------------------------------------------------------------------------------------------------------------------------------------------------------------------------------------------------------------------------------------------------------------------------------------------------------------------------------------------------------------------------------------------------------------------------------------------------------------------------------------------------------------------------------------------------------------------------------------------------------------|
| Resume Service (Seconds)     | <p>Field that appears only when the Inband-Health Check is set to Remove.</p> <p>Enter the number of seconds after a server has been marked as failed to reconsider it for sending live connections. Valid entries are integers from 30 to 3600. The default setting is 0. The setting of this option affects the behavior of the real server in the inband failed state, as follows:</p> <ul style="list-style-type: none"> <li>• When this field is not configured and has the default setting of 0, the real server remains in the failed state until you manually suspend and then reactivate it.</li> <li>• When this field is not configured and has the default setting of 0 and then you configure this option with an integer between 30 and 3,600, the failed real server immediately transitions to the Operational state.</li> <li>• When you configure this field and then increase the value, the real server remains in the failed state for the duration of the previously-configured value. The new value takes effect the next time the real server transitions to the failed state.</li> <li>• When you configure this field and then decrease the value, the failed real server immediately transitions to the Operational state.</li> <li>• When you configure this field with an integer between 30 and 3,600 and then reset it to the default of 0, the real server remains in the failed state for the duration of the previously-configured value. The default setting takes effect the next time the real server transitions to the failed state. Then the real server remains in the failed state until you manually suspend and then reactivate it.</li> <li>• When you change this field within the reset-time interval the real server in the OPERATIONAL with several connection failures, the new threshold interval takes effect the next time that a connection error occurs, even if it occurs within the current reset-time interval.</li> </ul> |
| Partial-Threshold Percentage | <p>Field that appears only for host server farms.</p> <p>Enter the minimum percentage of real servers in the primary server farm that must remain active for the server farm to stay up. If the percentage of active real servers falls below this threshold, the ACE takes the server farm out of service. Valid entries are from 0 to 99. The default is 0.</p>                                                                                                                                                                                                                                                                                                                                                                                                                                                                                                                                                                                                                                                                                                                                                                                                                                                                                                                                                                                                                                                                                                                                                                                                                                                                                                                                                                                                                                                                                                                                                                                                                    |
| Back Inservice               | <p>Field that appears only for host server farms.</p> <p>Enter the percentage of real servers in the primary server farm that must be active again for the ACE to place the server farm back into service. Valid entries are from 0 to 99. The value in this field should be larger than the value in the Partial Threshold Percentage field. The default is 0.</p>                                                                                                                                                                                                                                                                                                                                                                                                                                                                                                                                                                                                                                                                                                                                                                                                                                                                                                                                                                                                                                                                                                                                                                                                                                                                                                                                                                                                                                                                                                                                                                                                                  |

Table 8-7 Server Farm Attributes (continued)

| Field  | Description                                                                                                                                                                                                                                                                                                                                                                                                                                                                                                                                                                                                                                                                                                                                                                                                                                                                                                                                                                                                                                                                                                                                                                                                                                                                                                                                                                                                                                                                                                                                                                                                                                                      |
|--------|------------------------------------------------------------------------------------------------------------------------------------------------------------------------------------------------------------------------------------------------------------------------------------------------------------------------------------------------------------------------------------------------------------------------------------------------------------------------------------------------------------------------------------------------------------------------------------------------------------------------------------------------------------------------------------------------------------------------------------------------------------------------------------------------------------------------------------------------------------------------------------------------------------------------------------------------------------------------------------------------------------------------------------------------------------------------------------------------------------------------------------------------------------------------------------------------------------------------------------------------------------------------------------------------------------------------------------------------------------------------------------------------------------------------------------------------------------------------------------------------------------------------------------------------------------------------------------------------------------------------------------------------------------------|
| Probes | <p>Field that appears only as follows:</p> <ul style="list-style-type: none"> <li>For all host server farms. The Available probe list contains all probe types.</li> <li>For redirect server farms configured on ACE devices that use the following software versions: <ul style="list-style-type: none"> <li>ACE module: A2(3.x) and later releases</li> <li>ACE appliance: A3(x) and later releases</li> </ul> </li> </ul> <p>The redirect server farm Available probe list contains only probes of the type Is Routed, which means that the ACE routes the probe address according to the ACE internal routing table (see the <a href="#">“Configuring Health Monitoring for Real Servers”</a> section on page 8-51).</p> <p>In the Available Items list, choose the probes to use for health monitoring, and click <b>Add</b>. The selected probes appear in the Selected Items list.</p> <hr/> <p> <b>Note</b> You can associate both IPv6 and IPv4 probes to a server farm. IPv6 requires ACE module and ACE appliance software Version A5(1.0) or later.</p> <hr/> <p> <b>Note</b> The list of available probes does not include VM health monitoring probes. To choose a VM probe for monitoring local VM usage, see the <a href="#">Dynamic Workload Scaling</a> field.</p> <hr/> <p>To remove probes that you do not want to use for health monitoring, select them in the Selected Items list, and click <b>Remove</b>. The selected probes appear in the Available Items list.</p> |

**Step 5** Do one of the following:

- Click **Deploy Now** to deploy this configuration on the ACE and save your entries to the running-configuration and startup-configuration files.

The window refreshes with additional configuration options:

- To add real servers to the server farm, see the [“Adding Real Servers to a Server Farm”](#) section on page 8-37.
- To specify a predictor method for the server farm, see the [“Configuring the Predictor Method for Server Farms”](#) section on page 8-39.
- To configure return code checking, see the [“Configuring Server Farm HTTP Return Error-Code Checking”](#) section on page 8-46.
- Click **Cancel** to exit the procedure without saving your entries and to return to the Server Farms table.
- Click **Next** to deploy your entries and to configure another server farm.

**Step 6** (Optional) To display statistics and status information for an existing server farm, choose a server farm from the Server Farms table, and click **Details**.

The **show serverfarm name detail** CLI command output appears. See the [“Displaying Server Farm Statistics and Status Information”](#) section on page 8-48 for details.

**Related Topics**

- [Configuring Health Monitoring for Real Servers, page 8-51](#)
- [Configuring Real Servers, page 8-5](#)
- [Configuring Sticky Groups, page 9-7](#)
- [Configuring the Predictor Method for Server Farms, page 8-39](#)
- [Configuring Server Farm HTTP Return Error-Code Checking, page 8-46](#)
- [Configuring Dynamic Workload Scaling, page 8-26](#)

## Adding Real Servers to a Server Farm

You can add real servers to a server farm. After adding a server farm (see the “[Configuring Server Farms](#)” section on page 8-30), you can associate real servers with it and configure predictors and retcode maps. The options for these attributes appear after you have successfully added a new server farm.

**Assumptions**

This topic assumes the following:

- A server farm has been added to ANM (see the “[Configuring Server Farms](#)” section on page 8-30).
- At least one real server exists.

**Consideration**

A server farm can support a mix of IPv6 and IPv4 real servers. IPv6 requires ACE module and ACE appliance software Version A5(1.0) or later.

**Procedure**

- 
- Step 1** Choose **Config > Devices > context > Load Balancing > Server Farms**.  
The Server Farms table appears.
- Step 2** In the Server Farms table, choose the server farm that you want to associate with real servers.  
The Real Servers table appears.
- Step 3** In the Real Servers table, click **Add** to add a new entry, or select an existing server and click **Edit** to modify it.  
The Real Servers configuration pane appears.
- Step 4** In the Real Servers configuration pane, configure the real server using the information in [Table 8-8](#).

**Table 8-8** *Real Server Configuration Attributes*

| Field              | Description                                                                                                                                                       |
|--------------------|-------------------------------------------------------------------------------------------------------------------------------------------------------------------|
| Name               | Server that you want to associate with the server farm.                                                                                                           |
| Port               | Port number to be used for server port address translation (PAT). Valid entries are from 1 to 65535.                                                              |
| Backup Server Name | Server that is to act as the backup server for the server farm. Leave this field blank to indicate that there is no designated backup server for the server farm. |
| Backup Server Port | Server port number. If you select a backup server, enter the backup server port number. Valid entries are from 1 to 65535.                                        |

Table 8-8 Real Server Configuration Attributes (continued)

| Field            | Description                                                                                                                                                                                                                                                                                                                                                                                                                                                                                                                                                                                 |
|------------------|---------------------------------------------------------------------------------------------------------------------------------------------------------------------------------------------------------------------------------------------------------------------------------------------------------------------------------------------------------------------------------------------------------------------------------------------------------------------------------------------------------------------------------------------------------------------------------------------|
| Fail-On-All      | <p>Field that appears only for real servers identified as host servers.</p> <p>By default, real servers with multiple probes configured for them have an OR logic associated with them. This means that if one of the real server probes fails, the real server fails and enters the PROBE-FAILED state.</p> <p>Check this checkbox to configure a real server to remain in the OPERATIONAL state unless all probes associated with it fail (AND logic).</p> <p>The Fail-On-All function is applicable to all probe types.</p>                                                              |
| State            | <p>State of this server as follows:</p> <ul style="list-style-type: none"> <li>• <b>In Service</b>—The server is in service.</li> <li>• <b>In Service Standby</b>—The server is a backup server and remains inactive unless the primary server fails. If the primary server fails, the backup server becomes active and starts accepting connections.</li> <li>• <b>Out Of Service</b>—The server is out of service.</li> </ul>                                                                                                                                                             |
| Min. Connections | <p>Minimum number of connections that the number of connections must fall below before the ACE resumes sending connections to the server after it has exceeded the number in the Max. Connections field. The number in this field must be less than or equal to the number in the Max. Connections field.</p> <p>For ACE appliances, valid entries are from 2 to 4294967295.</p> <p>For ACE modules, valid entries are from 2 to 4000000.</p>                                                                                                                                               |
| Max. Connections | <p>Maximum number of active connections that can be sent to the server. When the number of connections exceeds this number, the ACE stops sending connections to the server until the number of connections falls below the number specified in the Min. Connections field.</p> <p>For ACE appliances, valid entries are from 2 to 4294967295.</p> <p>For ACE modules, valid entries are from 2 to 4000000.</p>                                                                                                                                                                             |
| Weight           | <p>Weight to assign to the server. Valid entries are from 1 to 100. The default is 8.</p>                                                                                                                                                                                                                                                                                                                                                                                                                                                                                                   |
| Probes           | <p>Probes to apply to the server. Choose the probes in the Available Items list that you want to apply to this server, and click <b>Add</b>. The selected probes appear in the Selected Items list. To remove probes that you do not want to use, choose the probes in the Selected Items list, and click <b>Remove</b>. The selected probes appear in the Available Items list.</p> <p> <b>Note</b> The VM probe type does not display in the Available Items list even if you have one configured.</p> |
| Rate Bandwidth   | <p>Bandwidth rate, which is the number of bytes per second and applies to the network traffic exchanged between the ACE and the real server in both directions.</p> <p>Specify the bandwidth limit in bytes per second. Valid entries are from 2 to 300000000. The default is 300000000.</p>                                                                                                                                                                                                                                                                                                |
| Rate Connection  | <p>Connection rate, which is the number of connections per second received by the ACE and applies only to new connections destined to a real server.</p> <p>Specify the limit for connections per second. Valid entries are from 2 to 350000. The default is 350000.</p>                                                                                                                                                                                                                                                                                                                    |

- Step 5** When you finish configuring this server for this server farm, do one of the following:
- Click **Deploy Now** to deploy this configuration on the ACE and save your entries to the running-configuration and startup-configuration files. You return to the Real Servers table.
  - Click **Cancel** to exit this procedure without saving your entries and to return to the Real Servers table.
  - Click **Next** to deploy your entries and to add another real server for this server farm.

---

#### Related Topics

- [Configuring Health Monitoring for Real Servers, page 8-51](#)
- [Configuring Real Servers, page 8-5](#)
- [Configuring Sticky Groups, page 9-7](#)
- [Configuring the Predictor Method for Server Farms, page 8-39](#)
- [Configuring Server Farm HTTP Return Error-Code Checking, page 8-46](#)
- [Configuring Dynamic Workload Scaling, page 8-26](#)

## Configuring the Predictor Method for Server Farms

You can configure the predictor method for a server farm. The predictor method specifies how the ACE is to select a server in the server farm when it receives a client request for a service. After adding a server farm (see the “[Configuring Server Farms](#)” section on page 8-30), you can associate real servers with it and configure the predictor method and retcode maps. The options for these attributes appear after you have successfully added a new server farm.



---

**Note** You can configure only one predictor method per server farm.

---

#### Assumptions

This topic assumes the following:

- A server farm has been added to ANM (see the “[Configuring Server Farms](#)” section on page 8-30.)
- At least one real server exists.

#### Procedure

---

- Step 1** Choose **Config > Devices > context > Load Balancing > Server Farms**.  
The Server Farms table appears.
- Step 2** In the Server Farms table, choose the server farm that you want to configure the predictor method for, and click the **Predictor** tab.  
The Predictor configuration pane appears.
- Step 3** In the Type field of the Predictor configuration pane, choose the method that the ACE is to use to select a server in this server farm when it receives a client request (see [Table 8-9](#)).
- Step 4** Enter the required information for the selected predictor method (see [Table 8-9](#)).



**Note** Fields and information related to IPv6 require ACE module and ACE appliance software Version A5(1.0) or later.

**Table 8-9** Predictor Method Attributes

| Predictor Method | Description / Action                                                                                                                                                                                                                                                                                                                                                                                                                                                                                                                                                                                                                                                                                                                |
|------------------|-------------------------------------------------------------------------------------------------------------------------------------------------------------------------------------------------------------------------------------------------------------------------------------------------------------------------------------------------------------------------------------------------------------------------------------------------------------------------------------------------------------------------------------------------------------------------------------------------------------------------------------------------------------------------------------------------------------------------------------|
| Hash Address     | <p>Server selection method that uses a hash value based on the source or destination IP address.</p> <p>To configure the hash address predictor method, do the following:</p> <ol style="list-style-type: none"> <li>a. In the Mask Type field, indicate whether server selection is based on source IP address or the destination IP address as follows: <ul style="list-style-type: none"> <li>– <b>N/A</b>—This option is not defined.</li> <li>– <b>Destination</b>—The server is selected based on the destination IP address.</li> <li>– <b>Source</b>—The server is selected based on the source IP address.</li> </ul> </li> </ol>                                                                                          |
|                  | <p> <b>Note</b> If you configure the server farm with IPv6 and IPv4 Hash Address predictors at the same time, both predictors must have the same mask type. IPv6 requires ACE module and ACE appliance software Version A5(1.0) or later.</p> <ol style="list-style-type: none"> <li>b. In the IP Netmask field, choose the subnet mask to apply to the address. If none is specified, the default is 255.255.255.255.</li> <li>c. In the IPv6 Prefix-Length field, enter the IPv6 prefix length. If none is specified, the default is 128. This field appears only for ACE module and ACE appliance software Version A5(1.0) or later.</li> </ol> |



Table 8-9 Predictor Method Attributes (continued)



| Predictor Method | Description / Action                                                                                                                                                                                                                                                                                                                                                                                                                                                                                                                                                                                                                                                                                                                                                                                                                                                                                                                                                                                                                                                                                                                                                                                                                                                                                                                                                                                                                                                                                                                                                                                                                                                                                                                                                                                                                                                                                                                                                                                                                                                                                                                                                                                                                                                                                                                                                                                                                                                                                                                                                                                                                                                                                                                                                                                                                                                                                                           |
|------------------|--------------------------------------------------------------------------------------------------------------------------------------------------------------------------------------------------------------------------------------------------------------------------------------------------------------------------------------------------------------------------------------------------------------------------------------------------------------------------------------------------------------------------------------------------------------------------------------------------------------------------------------------------------------------------------------------------------------------------------------------------------------------------------------------------------------------------------------------------------------------------------------------------------------------------------------------------------------------------------------------------------------------------------------------------------------------------------------------------------------------------------------------------------------------------------------------------------------------------------------------------------------------------------------------------------------------------------------------------------------------------------------------------------------------------------------------------------------------------------------------------------------------------------------------------------------------------------------------------------------------------------------------------------------------------------------------------------------------------------------------------------------------------------------------------------------------------------------------------------------------------------------------------------------------------------------------------------------------------------------------------------------------------------------------------------------------------------------------------------------------------------------------------------------------------------------------------------------------------------------------------------------------------------------------------------------------------------------------------------------------------------------------------------------------------------------------------------------------------------------------------------------------------------------------------------------------------------------------------------------------------------------------------------------------------------------------------------------------------------------------------------------------------------------------------------------------------------------------------------------------------------------------------------------------------------|
| Hash Content     | <p>Server selection method that uses a hash value based on the specified content string of the HTTP packet body. Do the following:</p> <ol style="list-style-type: none"> <li>In the Begin Pattern field, enter the beginning pattern of the content string and the pattern string to match before hashing. If you do not specify a beginning pattern, the ACE starts parsing the HTTP body immediate following the offset byte. You cannot configure different beginning and ending patterns for different server farms that are part of the same traffic classification.<br/><br/>Valid entries are unquoted text strings with no spaces and a maximum of 255 alphanumeric characters. The ACE supports regular expressions for matching string expressions. <a href="#">Table 14-33</a> lists the supported characters that you can use for matching string expressions.</li> <li>In the End Pattern field, enter the pattern that marks the end of hashing. If you do not specify either a length or an end pattern, the ACE continues to parse the data until it reaches the end of the field or the end of the packet, or until it reaches the maximum body parse length. You cannot configure different beginning and ending patterns for different server farms that are part of the same traffic classification.<br/><br/>Valid entries are unquoted text strings with no spaces and a maximum of 255 alphanumeric characters. The ACE supports regular expressions for matching string expressions. <a href="#">Table 14-33</a> lists the supported characters that you can use for matching string expressions.</li> <li>In the Length (Bytes) field, enter the length in bytes of the portion of the content (starting with the byte after the offset value) that the ACE uses for sticking the client to the server. Valid entries are from 1 to 1000 bytes.<br/><br/>The offset and length can vary from 0 to 1000 bytes. If the payload is longer than the offset but shorter than the offset plus the length of the payload, the ACE sticks the connection based on that portion of the payload starting with the byte after the offset value and ending with the byte specified by the offset plus the length. The total of the offset and the length cannot exceed 1000.</li> </ol> <p> <b>Note</b> You cannot specify both the length and the end-pattern options for a Hash Content predictor.</p> <ol style="list-style-type: none"> <li>In the HTTP Content Offset (Bytes) field, enter the portion of the content that the ACE uses to stick the client on a particular server by indicating the bytes to ignore starting with the first byte of the payload. Valid entries are integers from 0 to 999 bytes. The default is 0, which indicates that the ACE does not exclude any portion of the content.</li> </ol> |
| Hash Cookie      | <p>Server selection method that uses a hash value based on the cookie name.</p> <p>In the Cookie Name field, enter a cookie name in the form of an unquoted text string with no spaces and a maximum of 64 characters.</p>                                                                                                                                                                                                                                                                                                                                                                                                                                                                                                                                                                                                                                                                                                                                                                                                                                                                                                                                                                                                                                                                                                                                                                                                                                                                                                                                                                                                                                                                                                                                                                                                                                                                                                                                                                                                                                                                                                                                                                                                                                                                                                                                                                                                                                                                                                                                                                                                                                                                                                                                                                                                                                                                                                     |
| Hash Header      | <p>Server selection method that uses a hash value based on the header name.</p> <p>In the Header Name field, choose the HTTP header to be used for server selection as follows:</p> <ul style="list-style-type: none"> <li>To specify an HTTP header that is not one of the standard HTTP headers, click the first radio button and enter the HTTP header name in the Header Name field. Valid entries are unquoted text strings with no spaces and a maximum of 64 characters.</li> <li>To specify one of the standard HTTP headers, click the second radio button, and then choose one of the HTTP headers from the list.</li> </ul>                                                                                                                                                                                                                                                                                                                                                                                                                                                                                                                                                                                                                                                                                                                                                                                                                                                                                                                                                                                                                                                                                                                                                                                                                                                                                                                                                                                                                                                                                                                                                                                                                                                                                                                                                                                                                                                                                                                                                                                                                                                                                                                                                                                                                                                                                         |

Table 8-9 Predictor Method Attributes (continued)

| Predictor Method | Description / Action                                                                                                                                                                                                                                                                                                                                                                                                                                                                                                                                                                                                                                                                                                                                                                                                                                                                                                                                                                                                                                                                                                                                                                                                                                                                                                                                                                                                                                                                                                                                                                                                                                                                                                                                                                                                                                                                                                                                                                                                                                                                                                                                                                                                                                                                                                                                                                                                                                                                                                                                                                                                                                                                                                                                                                                                                                                               |
|------------------|------------------------------------------------------------------------------------------------------------------------------------------------------------------------------------------------------------------------------------------------------------------------------------------------------------------------------------------------------------------------------------------------------------------------------------------------------------------------------------------------------------------------------------------------------------------------------------------------------------------------------------------------------------------------------------------------------------------------------------------------------------------------------------------------------------------------------------------------------------------------------------------------------------------------------------------------------------------------------------------------------------------------------------------------------------------------------------------------------------------------------------------------------------------------------------------------------------------------------------------------------------------------------------------------------------------------------------------------------------------------------------------------------------------------------------------------------------------------------------------------------------------------------------------------------------------------------------------------------------------------------------------------------------------------------------------------------------------------------------------------------------------------------------------------------------------------------------------------------------------------------------------------------------------------------------------------------------------------------------------------------------------------------------------------------------------------------------------------------------------------------------------------------------------------------------------------------------------------------------------------------------------------------------------------------------------------------------------------------------------------------------------------------------------------------------------------------------------------------------------------------------------------------------------------------------------------------------------------------------------------------------------------------------------------------------------------------------------------------------------------------------------------------------------------------------------------------------------------------------------------------------|
| Hash Layer4      | <p>Layer 4 generic protocol load-balancing method. Use this predictor to load balance packets from protocols that are not explicitly supported by the ACE.</p> <p><b>a.</b> In the Begin Pattern field, enter the beginning pattern of the Layer 4 payload and the pattern string to match before hashing. If you do not specify a beginning pattern, the ACE starts parsing the HTTP body immediate following the offset byte. You cannot configure different beginning and ending patterns for different server farms that are part of the same traffic classification.</p> <p>Valid entries are unquoted text strings with no spaces and a maximum of 255 alphanumeric characters. The ACE supports regular expressions for matching string expressions. <a href="#">Table 14-33</a> lists the supported characters that you can use for matching string expressions.</p> <p><b>b.</b> In the End Pattern field, enter the pattern that marks the end of hashing. If you do not specify either a length or an end pattern, the ACE continues to parse the data until it reaches the end of the field or the end of the packet, or until it reaches the maximum body parse length. You cannot configure different beginning and ending patterns for different server farms that are part of the same traffic classification.</p> <p>Valid entries are unquoted text strings with no spaces and a maximum of 255 alphanumeric characters. The ACE supports regular expressions for matching string expressions. <a href="#">Table 14-33</a> lists the supported characters that you can use for matching string expressions.</p> <p><b>c.</b> In the Length (Bytes) field, enter the length in bytes of the portion of the payload (starting with the byte after the offset value) that the ACE uses for sticking the client to the server. Valid entries are from 1 to 1000 bytes.</p> <p>The offset and length can vary from 0 to 1000 bytes. If the payload is longer than the offset but shorter than the offset plus the length of the payload, the ACE sticks the connection based on that portion of the payload starting with the byte after the offset value and ending with the byte specified by the offset plus the length. The total of the offset and the length cannot exceed 1000.</p> <p> <b>Note</b> You cannot specify both the length and end-pattern options for a Hash Layer 4 predictor.</p> <p><b>d.</b> In the HTTP Content Offset (Bytes) field, enter the portion of the content that the ACE uses to stick the client on a particular server by indicating the bytes to ignore starting with the first byte of the payload. Valid entries are from 0 to 999 bytes. The default is 0, which indicates that the ACE does not exclude any portion of the content.</p> |
| Hash URL         | <p>Server selection method that uses a hash value based on the URL. Use this method to load balance firewalls.</p> <p>Enter values in one or both of the pattern fields as follows:</p> <ul style="list-style-type: none"> <li>In the URL Begin Pattern field, enter the beginning pattern of the URL and the pattern string to parse.</li> <li>In the URL End Pattern field, enter the ending pattern of the URL and the pattern string to parse.</li> </ul> <p>Valid entries for these fields are unquoted text strings with no spaces and a maximum of 255 alphanumeric characters for each pattern that you configure. The following special characters are also allowed: @ # \$</p>                                                                                                                                                                                                                                                                                                                                                                                                                                                                                                                                                                                                                                                                                                                                                                                                                                                                                                                                                                                                                                                                                                                                                                                                                                                                                                                                                                                                                                                                                                                                                                                                                                                                                                                                                                                                                                                                                                                                                                                                                                                                                                                                                                                           |

**Table 8-9** *Predictor Method Attributes (continued)*

| <b>Predictor Method</b> | <b>Description / Action</b>                                                                                                                                                                                                                                                                                                                                                                                                                                                                                                                                                                                                                                             |
|-------------------------|-------------------------------------------------------------------------------------------------------------------------------------------------------------------------------------------------------------------------------------------------------------------------------------------------------------------------------------------------------------------------------------------------------------------------------------------------------------------------------------------------------------------------------------------------------------------------------------------------------------------------------------------------------------------------|
| Least Bandwidth         | <p>Server with the least amount of network traffic over a specified sampling period. Do the following:</p> <ul style="list-style-type: none"> <li data-bbox="375 359 1523 422">a. In the Assess Time (Seconds) field, enter the number of seconds for which the ACE is to collect traffic information. Valid entries are from 1 to 10 seconds.</li> <li data-bbox="375 436 1523 533">b. In the Least Bandwidth Samples field, enter the number of samples over which you want to weight and average the results of the probe query to calculate the final load value. Valid entries are 1, 2, 4, 8, and 16 (values from 1 to 16 that are also a power of 2).</li> </ul> |
| Least Connections       | <p>Server with the fewest number of connections.</p> <p>In the Slow Start Duration (Seconds) field, enter the slow-start value to be applied to this predictor method. Valid entries are from 1 to 65535, where 1 is the slowest ramp-up value.</p> <p>The slow-start mechanism is used to avoid sending a high rate of new connections to servers that you have just put into service.</p>                                                                                                                                                                                                                                                                             |

Table 8-9 Predictor Method Attributes (continued)

| Predictor Method | Description / Action                                                                                                                                                                                                                                                                                                                                                                                                                                                                                                                                                                                                                                                                                                                                                                                                                                                                                                                                                                                                                                                                                                                                                                                                                                                                                                                                                                                                                                                                                                                                                                                                                                                                                                                                                                                                                                                                                                                                                                                                                                                                                                                                                                                                                                                                                                                                                                                                                                                                                                                                                                                                                                                                                                                                                                                                                                                                                                                                                                                                                                                                                                                                                                                                                                                                                                                                                                                                                                              |
|------------------|-------------------------------------------------------------------------------------------------------------------------------------------------------------------------------------------------------------------------------------------------------------------------------------------------------------------------------------------------------------------------------------------------------------------------------------------------------------------------------------------------------------------------------------------------------------------------------------------------------------------------------------------------------------------------------------------------------------------------------------------------------------------------------------------------------------------------------------------------------------------------------------------------------------------------------------------------------------------------------------------------------------------------------------------------------------------------------------------------------------------------------------------------------------------------------------------------------------------------------------------------------------------------------------------------------------------------------------------------------------------------------------------------------------------------------------------------------------------------------------------------------------------------------------------------------------------------------------------------------------------------------------------------------------------------------------------------------------------------------------------------------------------------------------------------------------------------------------------------------------------------------------------------------------------------------------------------------------------------------------------------------------------------------------------------------------------------------------------------------------------------------------------------------------------------------------------------------------------------------------------------------------------------------------------------------------------------------------------------------------------------------------------------------------------------------------------------------------------------------------------------------------------------------------------------------------------------------------------------------------------------------------------------------------------------------------------------------------------------------------------------------------------------------------------------------------------------------------------------------------------------------------------------------------------------------------------------------------------------------------------------------------------------------------------------------------------------------------------------------------------------------------------------------------------------------------------------------------------------------------------------------------------------------------------------------------------------------------------------------------------------------------------------------------------------------------------------------------------|
| Least Loaded     | <p>Least loaded server based on information from SNMP probes. Do the following:</p> <ol style="list-style-type: none"> <li>a. In the SNMP Probe Name field, choose the name of the SNMP probe to use.</li> <li>b. In the Auto Adjust field, configure the autoadjust feature to instruct the ACE to apply the maximum load of 16000 to a real server whose load reaches zero or override the default behavior. By default, the ACE applies the average load of the server farm to a real server whose load is zero. The ACE periodically adjusts this load value based on feedback from the server SNMP probe and other configured options. Options include the following: <ul style="list-style-type: none"> <li>– <b>Average</b>—Instructs the ACE to apply the average load of the server farm to a real server whose load is zero. This setting allows the server to participate in load balancing, while preventing it from being flooded by new connections. This is the default setting.</li> <li>– <b>Maxload</b>—Instructs the ACE to apply the maximum load of the server farm to a real server whose load reaches zero.</li> </ul> <p>The maxload option requires the following ACE software versions:</p> <ul style="list-style-type: none"> <li>- ACE appliance—A3(2.7) or A4(1.0) or later</li> <li>- ACE module—A2(2.4), A2(3.2), or A4(1.0) or later</li> </ul> <p>If you choose the maxload option and the ACE does not support the option, ANM issues a command parse error message.</p> <ul style="list-style-type: none"> <li>– <b>Off</b>—Instructs the ACE to send all new connections to the server that has a load of zero until the next load update arrives from the SNMP probe for this server. There may be times when you want the ACE to send all new connections to a real server whose load is zero.</li> </ul> </li> <li>c. In the Weight Connection field, check the check box to instruct the ACE to use the current connection count in the final load calculation for a real server. When you configure this option, the ACE includes the current connection count in the total load calculation for each real server in a server farm. Uncheck the check box to reset the behavior of the ACE to the default of excluding the current connection count from the load calculation.</li> </ol> <p>To instruct the ACE to select the server with the lowest load, use the predictor least-loaded command in server farm host or redirect configuration mode. With this predictor, the ACE uses SNMP probes to query the real servers for load parameter values (for example, CPU utilization or memory utilization). This predictor is considered adaptive because the ACE continuously provides feedback to the load-balancing algorithm based on the behavior of the real server.</p> <p>To use this predictor, you must associate an SNMP probe with it. The ACE queries user-specified OIDs periodically based on a configurable time interval. The ACE uses the retrieved SNMP load value to determine the server with the lowest load.</p> <p>The syntax of this predictor command is as follows:</p> <p style="padding-left: 40px;"><b>predictor least-loaded probe <i>name</i></b></p> <p>The <i>name</i> argument specifies the identifier of the existing SNMP probe that you want the ACE to use to query the server. Enter an unquoted text string with no spaces and a maximum of 64 alphanumeric characters.</p> |

**Table 8-9** Predictor Method Attributes (continued)

| Predictor Method            | Description / Action                                                                                                                                                                                                                                                                                                                                                                                                                                                                                                                                                                                                                                                                                                                                                                                                                                                                                                                                                                                                                                                                                                                                                                                                                                                                                                                                                                                                                                                                                      |
|-----------------------------|-----------------------------------------------------------------------------------------------------------------------------------------------------------------------------------------------------------------------------------------------------------------------------------------------------------------------------------------------------------------------------------------------------------------------------------------------------------------------------------------------------------------------------------------------------------------------------------------------------------------------------------------------------------------------------------------------------------------------------------------------------------------------------------------------------------------------------------------------------------------------------------------------------------------------------------------------------------------------------------------------------------------------------------------------------------------------------------------------------------------------------------------------------------------------------------------------------------------------------------------------------------------------------------------------------------------------------------------------------------------------------------------------------------------------------------------------------------------------------------------------------------|
| Least Loaded<br>(continued) | <p>For example, to configure the ACE to select the real server with the lowest load based on feedback from an SNMP probe called PROBE_SNMP, enter the following commands:</p> <pre>host1/Admin(config)# serverfarm SF1 host1/Admin(config-sfarm-host)# predictor least-loaded probe PROBE_SNMP host1/Admin(config-sfarm-host-predictor)#</pre> <p>To reset the predictor method to the default of round-robin, enter the following command:</p> <pre>host1/Admin(config-sfarm-host)# no predictor</pre>                                                                                                                                                                                                                                                                                                                                                                                                                                                                                                                                                                                                                                                                                                                                                                                                                                                                                                                                                                                                   |
| Response                    | <p>Server selection method based on the lowest response time for a requested response-time measurement.</p> <ol style="list-style-type: none"> <li>In the Response Type field, select the type of measurement to use as follows: <ul style="list-style-type: none"> <li><b>App-Req-To-Resp</b>—The response time from when the ACE sends an HTTP request to a server to the time that the ACE receives a response from the server for that request.</li> <li><b>Syn-To-Close</b>—The response time from when the ACE sends a TCP SYN to a server to the time that the ACE receives a CLOSE from the server.</li> <li><b>Syn-To-Synack</b>—The response time from when the ACE sends a TCP SYN to a server to the time that the ACE receives a SYN-ACK from the server.</li> </ul> </li> <li>In the Response Samples field, enter the number of samples over which you want to average the results of the response-time measurement. Valid entries are 1, 2, 4, 8, and 16 (values from 1 to 16 that are also a power of 2).</li> <li>In the Weight Connection field, check the check box to instruct the ACE to use the current connection count in the final load calculation for a real server. When you configure this option, the ACE includes the current connection count in the total load calculation for each real server in a server farm. Uncheck the check box to reset the behavior of the ACE to the default of excluding the current connection count from the load calculation.</li> </ol> |
| Round Robin                 | <p>Server selection method in which The ACE selects the next server in the list of servers based on server weight. This method is the default predictor.</p>                                                                                                                                                                                                                                                                                                                                                                                                                                                                                                                                                                                                                                                                                                                                                                                                                                                                                                                                                                                                                                                                                                                                                                                                                                                                                                                                              |

- Step 5** Click **Deploy Now** to deploy this configuration on the ACE and save your entries to the running-configuration and startup-configuration files.

#### Related Topics

- [Configuring Health Monitoring for Real Servers, page 8-51](#)
- [Configuring Real Servers, page 8-5](#)
- [Configuring Sticky Groups, page 9-7](#)
- [Adding Real Servers to a Server Farm, page 8-37](#)
- [Configuring Dynamic Workload Scaling, page 8-26](#)

## Configuring Server Farm HTTP Return Error-Code Checking



### Note

This feature is available only for server farms configured as hosts. It is not available for server farms configured with the type Redirect.

You can configure HTTP return error-code checking (retcode map) for a server farm. After adding a server farm (see the “[Configuring Server Farms](#)” section on page 8-30), you can associate real servers with it and configure the predictor method and retcode maps. These options appear after you have successfully added a server farm.

### Assumption

A host type server farm has been added to ANM (see the “[Configuring Server Farms](#)” section on page 8-30).

### Procedure

**Step 1** Choose **Config > Devices > context > Load Balancing > Server Farms**.

The Server Farms table appears.

**Step 2** In the Server Farms table, choose the server farm that you want to configure for return error-code checking, and click the **Retcode Map** tab.

The Retcode Map table appears.

**Step 3** In the Retcode Map table, click **Add** to add a new entry to the table.

The Retcode Map configuration pane appears.



### Note

You cannot modify an entry in the Retcode Map table. Instead, delete the existing entry, then add a new one.

**Step 4** In the Lowest Retcode field of the Retcode Map configuration pane, enter the minimum value for an HTTP return error code.

Valid entries are from 100 to 599. This number must be less than or equal to the number in the Highest Retcode field.

**Step 5** In the Highest Retcode field, enter the maximum number for an HTTP return error code.

Valid entries are from 100 to 599. This number must be greater than or equal to the number in the Lowest Retcode field.

**Step 6** In the Type field, specify the action to be taken and related options using the information in [Table 8-10](#).



### Note

For ACE appliances, the only available option is Count.

**Table 8-10** Return-Code Type Configuration Options

| Option | Description                                                                         |
|--------|-------------------------------------------------------------------------------------|
| Count  | Total number of return codes received for each return code number that you specify. |

Table 8-10 Return-Code Type Configuration Options (continued)

| Option | Description                                                                                                                                                                                                                                                                                                                                                                                                                                                                                                                                                                                                                                                                                                                                                                                                                                                                                                                                                                                                                                                                                                                                                                                                                                                                                                                                                                                                                                                                                                                                                                                                                                                                                                                                                                                                                                                                                                                                                                                                                                                                                                                                                                                                                                                           |
|--------|-----------------------------------------------------------------------------------------------------------------------------------------------------------------------------------------------------------------------------------------------------------------------------------------------------------------------------------------------------------------------------------------------------------------------------------------------------------------------------------------------------------------------------------------------------------------------------------------------------------------------------------------------------------------------------------------------------------------------------------------------------------------------------------------------------------------------------------------------------------------------------------------------------------------------------------------------------------------------------------------------------------------------------------------------------------------------------------------------------------------------------------------------------------------------------------------------------------------------------------------------------------------------------------------------------------------------------------------------------------------------------------------------------------------------------------------------------------------------------------------------------------------------------------------------------------------------------------------------------------------------------------------------------------------------------------------------------------------------------------------------------------------------------------------------------------------------------------------------------------------------------------------------------------------------------------------------------------------------------------------------------------------------------------------------------------------------------------------------------------------------------------------------------------------------------------------------------------------------------------------------------------------------|
| Log    | <p>Syslog error message generated when the number of events reaches a specified threshold.</p> <ol style="list-style-type: none"> <li>a. In the Threshold field, enter the number of events that the ACE is to receive before generating a syslog error message. Valid entries are as follows: <ul style="list-style-type: none"> <li>– ACE appliance (all) and ACE module pre A4(1.0)—1 to 4294967295.</li> <li>– ACE module A4(1.0)—4 to 4294967295.</li> </ul> </li> <li>b. In the Reset (Seconds) field, enter the time interval in seconds for which the ACE checks for the return code. Valid entries are as follows: <ul style="list-style-type: none"> <li>– ACE appliance or module pre A4(1.0)—1 to 4294967295</li> <li>– ACE appliance or module A4(1.0) and later—1 to 2147483647</li> </ul> </li> </ol>                                                                                                                                                                                                                                                                                                                                                                                                                                                                                                                                                                                                                                                                                                                                                                                                                                                                                                                                                                                                                                                                                                                                                                                                                                                                                                                                                                                                                                                  |
| Remove | <p>The ACE generates a syslog error message when the number of events reaches a specified threshold and then removes the server from service.</p> <ol style="list-style-type: none"> <li>a. In the Threshold field, enter the number of events that the ACE is to receive before generating a syslog error message and removing the server from service. Valid entries are from 1 to 4294967295.</li> <li>b. In the Reset (Seconds) field, enter the time interval in seconds for which the ACE checks for the return code. Valid entries are from 1 to 4294967295 seconds.</li> <li>c. In the Resume Service (Seconds) field, enter the number of seconds that the ACE waits before it resumes service for the real server automatically after taking the real server out of service. Valid entries are 30 to 3600 seconds. The default is 0 seconds. The setting of this field affects the behavior of the real server in the failed state, as follows: <ul style="list-style-type: none"> <li>– When this field is not configured and has the default setting of 0, the real server remains in the failed state until you manually remove it from service and read it.</li> <li>– When this field is not configured and has the default setting of 0 and then you configure it with an integer between 30 and 3,600, the failed real server immediately transitions to the Operational state.</li> <li>– When you configure this field and then increase the value, the real server remains in the failed state for the duration of the previously-configured value. The new value takes effect the next time the real server transitions to the failed state.</li> <li>– When you configure this field and then decrease the value, the failed real server immediately transitions to the Operational state.</li> <li>– When you configure this field with an integer between 30 and 3,600 and then reset it to the default of 0, the real server remains in the failed state for the duration of the previously-configured value. The default setting takes effect the next time the real server transitions to the failed state. Then the real server remains in the failed state until you manually remove it from service and read it.</li> </ul> </li> </ol> |

**Step 7** Do one of the following:

- Click **Deploy Now** to deploy this configuration on the ACE and save your entries to the running-configuration and startup-configuration files.
- Click **Cancel** to exit this procedure without saving your entries and to return to the Retcode Map table.
- Click **Next** to deploy your entries and to add another retcode map.

**Related Topics**

- [Information About Virtual Contexts, page 6-2](#)
- [Configuring Virtual Context Class Maps, page 14-6](#)
- [Configuring Virtual Context Policy Maps, page 14-32](#)
- [Configuring Real Servers, page 8-5](#)
- [Configuring Sticky Groups, page 9-7](#)
- [Configuring Dynamic Workload Scaling, page 8-26](#)

## Displaying All Server Farms

You can display all server farms associated with a virtual context.

**Procedure**

---

**Step 1** Choose **Config > Devices**.

The Virtual Contexts table appears.

**Step 2** In the Virtual Contexts table, choose the virtual context with the server farms you want to display, and click **Load Balancing > Server Farms**.

The Server Farms table appears with the following information:

- Server farm name
- Server farm type (either host or redirect)
- Description
- Number of real servers associated with the server farm
- Number of predictor methods for the server farm
- Number of entries in the HTTP retcode map table

You can click on any of the entries in the last three columns to view specific information about those entries.

---

**Related Topics**

- [Displaying Server Farm Statistics and Status Information, page 8-48](#)
- [Configuring Server Farms, page 8-30](#)
- [Adding Real Servers to a Server Farm, page 8-37](#)
- [Configuring the Predictor Method for Server Farms, page 8-39](#)
- [Configuring Server Farm HTTP Return Error-Code Checking, page 8-46](#)
- [Configuring Dynamic Workload Scaling, page 8-26](#)

## Displaying Server Farm Statistics and Status Information

You can display statistics and status information for a particular server farm.



### Procedure

- 
- Step 1** Choose **Config > Devices > context > Load Balancing > Server Farms**.
- The Server Farms table appears.
- Step 2** In the Server Farms table, choose a server farm from the Server Farms table, and click **Details**.
- The **show serverfarm name detail** CLI command output appears. For details about the displayed output fields, see the *Cisco ACE Module Server Load-Balancing Configuration Guide* or the *Cisco ACE 4700 Series Appliance Server Load-Balancing Configuration Guide*, Chapter 2, Configuring Real Servers and Server Farms.
- Step 3** Click **Update Details** to refresh the output for the **show serverfarm name detail** CLI command.
- The new information appears in a separate panel with a new timestamp; both the old and the new server farm statistics and status information appear side-by-side to avoid overwriting the last updated information.
- Step 4** Click **Close** to return to the Server Farms table.
- 

### Related Topics

- [Displaying All Server Farms, page 8-48](#)
- [Configuring Server Farms, page 8-30](#)
- [Adding Real Servers to a Server Farm, page 8-37](#)
- [Configuring the Predictor Method for Server Farms, page 8-39](#)
- [Configuring Server Farm HTTP Return Error-Code Checking, page 8-46](#)
- [Configuring Dynamic Workload Scaling, page 8-26](#)

## Configuring Health Monitoring

You can instruct the ACE to check the health of servers and server farms by configuring health probes (sometimes referred to as *keepalives*). After you create a probe, you assign it to a real server or a server farm. A probe can be one of many types, including TCP, ICMP, Telnet, HTTP, and so on. You can also configure scripted probes using the TCL scripting language (see the “[TCL Scripts](#)” section on [page 8-50](#)).

The ACE sends out probes periodically to determine the status of a server, verifies the server response, and checks for other network problems that may prevent a client from reaching a server. Based on the server response, the ACE can place the server in or out of service, and, based on the status of the servers in the server farm, it can make reliable load-balancing decisions.

Health monitoring on the ACE tracks the state of a server by sending out probes. Also referred to as out-of-band health monitoring, the ACE verifies the server response or checks for any network problems that can prevent a client to reach a server. Based on the server response, the ACE can place the server in or out of service, and can make reliable load-balancing decisions.

The ACE identifies the health of a server in the following categories:

- **Passed**—The server returns a valid response.
- **Failed**—The server fails to provide a valid response to the ACE or the ACE is unable to reach a server for a specified number of retries.

By configuring the ACE for health monitoring, the ACE sends active probes periodically to determine the server state.

The ACE supports 4000 unique probe configurations which includes ICMP, TCP, HTTP, and other predefined health probes. The ACE also allows the opening of 1000 sockets simultaneously.

This section includes the following topics:

- [“TCL Scripts” section on page 8-50](#)
- [“Configuring Health Monitoring for Real Servers” section on page 8-51](#)
- [“Configuring Probe Attributes” section on page 8-56](#)
- [“Configuring DNS Probe Expect Addresses” section on page 8-73](#)
- [“Configuring Headers for HTTP and HTTPS Probes” section on page 8-74](#)
- [“Configuring Health Monitoring Expect Status” section on page 8-74](#)
- [“Configuring an OID for SNMP Probes” section on page 8-76](#)
- [“Displaying Health Monitoring Statistics and Status Information” section on page 8-77](#)

## TCL Scripts

The ACE supports several specific types of health probes (for example HTTP, TCP, or ICMP health probes) when you need to use a diverse set of applications and health probes to administer your network. The basic health probe types supported in the current ACE software release may not support the specific probing behavior that your network requires. To support a more flexible health-probing functionality, the ACE allows you to upload and execute Toolkit Command Language (TCL) scripts on the ACE.

The TCL interpreter code in the ACE is based on Release 8.44 of the standard TCL distribution. You can create a script to configure health probes. Script probes operate similar to other health probes available in the ACE software. As part of a script probe, the ACE executes the script periodically, and the exit code that is returned by the executing script indicates the relative health and availability of specific real servers. For information on health probes, see the [“Configuring Health Monitoring for Real Servers” section on page 8-51](#).

For your convenience, the following sample scripts for the ACE are available to support the TCL feature and are supported by Cisco TAC:

- ECHO\_PROBE\_SCRIPT
- FINGER\_PROBE\_SCRIPT
- FTP\_PROBE\_SCRIPT
- HTTP\_PROBE\_SCRIPT
- HTTPCONTENT\_PROBE
- HTTPHEADER\_PROBE
- HTTPPROXY\_PROBE
- IMAP\_PROBE
- LDAP\_PROBE
- MAIL\_PROBE
- POP3\_PROBE
- PROBENOTICE\_PROBE

- RTSP\_PROBE
- SSL\_PROBE\_SCRIPT

These scripts are located in the `probe:` directory and are accessible in both the Admin and user contexts. Note that the script files in the `probe:` directory are read-only, so you cannot copy or modify them. However, you can copy files from the `probe:` directory. For more information, see either the *Cisco Application Control Engine Module Administration Guide* or the *Cisco 4700 Series Application Control Engine Appliance Administration Guide*.

To load a script into memory on the ACE and enable it for use, use the `script file` command. For detailed information on uploading and executing TCL scripts on the ACE, see either the *Cisco ACE Module Server Load-Balancing Configuration Guide* or the *Cisco ACE 4700 Series Appliance Server Load-Balancing Configuration Guide*.

## Configuring Health Monitoring for Real Servers

You can establish monitoring of real servers to determine their viability in load-balancing decisions. To check the health and availability of a real server, the ACE periodically sends a probe to the real server. Depending on the server response, the ACE determines whether or not to include the server in its load-balancing decision.

### Procedure

- 
- Step 1** Choose **Config > Devices > context > Load Balancing > Health Monitoring**.
- The Health Monitoring table appears.
- Step 2** In the Health Monitoring table, click **Add** to add a new health monitoring probe, or choose an existing entry and click **Edit** to modify it.
- The Health Monitoring window appears.
- Step 3** In the Name field of the Health Monitoring window, enter a name that identifies the probe and that associates the probe with the real server.
- Valid entries are text strings with a maximum of 64 characters.
- Step 4** In the Type field, choose the type of probe that you want to use.
- The probe type determines what the probe sends to the real server. See [Table 8-11](#) for the types of probes and their descriptions.

**Table 8-11** Probe Types

| Probe Type | Description                                                                                                                                                                                                                                |
|------------|--------------------------------------------------------------------------------------------------------------------------------------------------------------------------------------------------------------------------------------------|
| DNS        | Sends a request to a DNS server giving it a configured domain. To determine if the server is up, the ACE must receive the configured IP address for that domain.                                                                           |
| ECHO-TCP   | Sends a string to the server and compares the response with the original string. If the response string matches the original, the server is marked as passed. If not, the ACE retries as configured before the server is marked as failed. |
| ECHO-UDP   | Sends a string to the server and compares the response with the original string. If the response string matches the original, the server is marked as passed. If not, the ACE retries as configured before the server is marked as failed. |
| FINGER     | Sends a probe to the server to verify that a defined username is a username on the server.                                                                                                                                                 |

Table 8-11 Probe Types (continued)

| Probe Type | Description                                                                                                                                                                                                                                                                                                                                                                                                  |
|------------|--------------------------------------------------------------------------------------------------------------------------------------------------------------------------------------------------------------------------------------------------------------------------------------------------------------------------------------------------------------------------------------------------------------|
| FTP        | Initiates an FTP session. By default, this probe is for an anonymous login with the option of configuring a user ID and password. The ACE performs an FTP GET or LS to determine the outcome of the problem. This probe supports only active connections.                                                                                                                                                    |
| HTTP       | Sets up a TCP connection and issues an HTTP request. Any valid HTTP response causes the probe to mark the real server as passed.                                                                                                                                                                                                                                                                             |
| HTTPS      | Similar to an HTTP probe, but this probe uses SSL to generate encrypted data.                                                                                                                                                                                                                                                                                                                                |
| ICMP       | Sends an ICMP request and listens for a response. If the server returns a response, the ACE marks the real server as passed. If there is no response and times out, or an ICMP standard error occurs, such as DESTINATION_UNREACHABLE, the ACE marks the real server as failed.                                                                                                                              |
| IMAP       | Initiates an IMAP session, using a configured user ID and password. Then, the probe attempts to retrieve email from the server and validates the result of the probe based on the return codes received from the server.                                                                                                                                                                                     |
| POP        | Initiates a POP session, using a configured user ID and password. Then, the probe attempts to retrieve email from the server and validates the result of the probe based on the return codes received from the server.                                                                                                                                                                                       |
| RADIUS     | Connects to a RADIUS server and logs into it to determine if the server is up.                                                                                                                                                                                                                                                                                                                               |
| RTSP       | Establishes a TCP connection and sends a request packet to the server. The ACE compares the response with the configured response code to determine whether the probe succeeded.                                                                                                                                                                                                                             |
| Scripted   | Executes probes from a configured script to perform health probing. This method allows you to author specific scripts with features not present in standard probes. For ACE appliances, the script probe filename must first be established on the device.                                                                                                                                                   |
| SIP-TCP    | Establishes a TCP connection and sends an OPTIONS request packet to the user agent on the server. The ACE compares the response with the configured response code or expected string, or both, to determine whether the probe has succeeded. If you do not configure an expected status code, any response from the server is marked as failed.                                                              |
| SIP-UDP    | Establishes a UDP connection and sends an OPTIONS request packet to the user agent on the server. The ACE compares the response with the configured response code or expected string, or both, to determine whether the probe has succeeded. If you do not configure an expected status code, any response from the server is marked as failed.                                                              |
| SMTP       | Initiates an SMTP session by logging into the server.                                                                                                                                                                                                                                                                                                                                                        |
| SNMP       | Establishes a UDP connection and sends a maximum of eight SMNP OID queries to probe the server. The ACE weighs and averages the load information that is retrieved and uses it as input to the least-loaded algorithm for load-balancing decisions. If the retrieved value is within the configured threshold, the server is marked as passed. If the threshold is exceeded, the server is marked as failed. |
| TCP        | Initiates a TCP handshake and expects a response. By default, a successful response causes the probe to mark the server as passed. The probe then sends a FIN to end the session. If the response is not valid, or if there is no response, the probe marks the real server as failed.                                                                                                                       |
| TELNET     | Establishes a connection to the real server and verifies that a greeting from the application was received.                                                                                                                                                                                                                                                                                                  |

**Table 8-11** Probe Types (continued)

| Probe Type | Description                                                                                                                                                                                                                                                                                                                                                                                                                                                                                                                                                                                                                                                                                                                                                                                                                                                                                                                                      |
|------------|--------------------------------------------------------------------------------------------------------------------------------------------------------------------------------------------------------------------------------------------------------------------------------------------------------------------------------------------------------------------------------------------------------------------------------------------------------------------------------------------------------------------------------------------------------------------------------------------------------------------------------------------------------------------------------------------------------------------------------------------------------------------------------------------------------------------------------------------------------------------------------------------------------------------------------------------------|
| UDP        | Sends a UDP packet to a real server. The probe marks the server as failed only if an ICMP Port Unreachable messages is returned.                                                                                                                                                                                                                                                                                                                                                                                                                                                                                                                                                                                                                                                                                                                                                                                                                 |
| VM         | <p>This probe type requires the following:</p> <ul style="list-style-type: none"> <li>• The ACE appliance or module is using software Version A4(2.0) or a later release.</li> <li>• The ACE is configured with a VM Controller connection (see the “<a href="#">Configuring and Verifying a VM Controller Connection</a>” section on page 8-29).</li> </ul> <p>Sends a probe to the VMware VM Controller to determine the average amount of both CPU and memory usage of its associated local VMs. The probe response determines whether the ACE load-balances traffic to the local VMs only or bursts traffic to the remote VMs due to high usage of the local VMs.</p> <p> <b>Note</b> You use a VM probe when you configure the ACE for Dynamic Workload Scaling (see the “<a href="#">Configuring Dynamic Workload Scaling</a>” section on page 8-26).</p> |

**Step 5** Enter health monitoring general attributes (see [Table 8-12](#)).



**Note** Fields and information related to IPv6 require ACE module and ACE appliance software Version A5(1.0) or later.



**Note** Click **More Settings** to access the additional general attributes for the selected probe type. By default, ANM hides the probe attributes with default values and the probe attributes that are not commonly used.

**Table 8-12** Health Monitoring General Attributes





| Field                    | Action                                                                                                                                                                                                                                                                                                                                                                                                                                                                                                                                                                                                                                                                                                                                                                                                                                                                                                                                               |
|--------------------------|------------------------------------------------------------------------------------------------------------------------------------------------------------------------------------------------------------------------------------------------------------------------------------------------------------------------------------------------------------------------------------------------------------------------------------------------------------------------------------------------------------------------------------------------------------------------------------------------------------------------------------------------------------------------------------------------------------------------------------------------------------------------------------------------------------------------------------------------------------------------------------------------------------------------------------------------------|
| Description              | Description for this probe. Valid entries are unquoted alphanumeric text strings with no spaces and a maximum of 240 characters.                                                                                                                                                                                                                                                                                                                                                                                                                                                                                                                                                                                                                                                                                                                                                                                                                     |
| Probe Interval (Seconds) | <p>Number of seconds that the ACE is to wait before sending another probe to a server marked as passed. Valid entries are from 2 to 65535 for all probe types except the VM probe, which has a range from 300 to 65535. The default values are as follows:</p> <ul style="list-style-type: none"> <li>• ACE appliance (all software versions)—Default is 15 seconds for all probe types except the VM probe, which has a default of 300 seconds.</li> <li>• ACE module: <ul style="list-style-type: none"> <li>– Software Version A4(1.0) and later—Default is 15 seconds for all probe types except the VM probe, which has a default of 300 seconds.</li> <li>– All software versions before A4(1.0)—Default is 120 seconds.</li> </ul> </li> </ul> <p> <b>Note</b> The VM probe type requires ACE software Version A4(2.0) or later on either device type.</p> |

Table 8-12 Health Monitoring General Attributes (continued)

| Field                                                       | Action                                                                                                                                                                                                                                                                                                                                                                                                                                                                                                                                                                                                                                                                                                                                                                                                                                  |
|-------------------------------------------------------------|-----------------------------------------------------------------------------------------------------------------------------------------------------------------------------------------------------------------------------------------------------------------------------------------------------------------------------------------------------------------------------------------------------------------------------------------------------------------------------------------------------------------------------------------------------------------------------------------------------------------------------------------------------------------------------------------------------------------------------------------------------------------------------------------------------------------------------------------|
| Pass Detect Interval (Seconds)                              | <p>Number of seconds that the ACE is to wait before sending another probe to a server marked as failed. Valid entries are from 2 to 65535. The default values are as follows:</p> <ul style="list-style-type: none"> <li>• ACE appliance (all software versions)—Default is 60 seconds.</li> <li>• ACE module: <ul style="list-style-type: none"> <li>– Software Version A4(1.0) and later—Default is 60 seconds.</li> <li>– All software versions before A4(1.0)—Default is 300 seconds.</li> </ul> </li> </ul> <p> <b>Note</b> This field is not applicable for the VM probe type.</p>                                                                                                                                                               |
| Fail Detect                                                 | <p>Consecutive number of times that an ACE must detect that probes have failed to contact a server before marking the server as failed. Valid entries are from 1 to 65535. The default is 3.</p> <p> <b>Note</b> This field is not applicable for the VM probe type.</p>                                                                                                                                                                                                                                                                                                                                                                                                                                                                               |
| <b>More Settings (Not applicable for the VM probe type)</b> |                                                                                                                                                                                                                                                                                                                                                                                                                                                                                                                                                                                                                                                                                                                                                                                                                                         |
| Pass Detect Count                                           | Number of successful probe responses from the server before the server is marked as passed. Valid entries are from 1 to 65535. The default is 3.                                                                                                                                                                                                                                                                                                                                                                                                                                                                                                                                                                                                                                                                                        |
| Receive Timeout (Seconds)                                   | Number of seconds that the ACE is to wait for a response from a server that has been probed before marking the server as failed. Valid entries are from 1 to 65535. The default is 10.                                                                                                                                                                                                                                                                                                                                                                                                                                                                                                                                                                                                                                                  |
| Destination IPv4/IPv6 Address <sup>1</sup>                  | <p>The IPv6 option requires ACE module and ACE appliance software Version A5(1.0) or later, which supports IPv4 and IPv6. Preferred destination IP address. By default, the probe uses the IP address from the real or virtual server configuration for the destination IP address. To override the destination address that the probe uses, enter the preferred destination IP address in this field.</p> <p> <b>Note</b> The following probes support IPv6 destination addresses: DNS, HTTP, HTTPS, ICMP, TCP, and UDP.</p> <p> <b>Note</b> When you assign a probe to a real server, they must be configured with the same IP address type (IPv6 or IPv4).</p> |
| Is Routed <sup>2</sup>                                      | Check box that indicates that the destination IP address is routed according to the ACE internal routing table. Uncheck the check box to indicate that the destination IP address is not routed according to the ACE internal routing table.                                                                                                                                                                                                                                                                                                                                                                                                                                                                                                                                                                                            |
| Port                                                        | <p>By default, the precedence in which the probe inherits the port number is as follows:</p> <ul style="list-style-type: none"> <li>• The port number that you configure for the probe.</li> <li>• The configured port number from the real server in server farm.</li> <li>• The configured port number from the VIP in a Layer 3 and Layer 4 class map.</li> <li>• The default port number. Table 8-13 lists the default port number for each probe type.</li> </ul> <p>If you explicitly configure a default port, the ACE always sends the probe to the default port. The probe does not dynamically inherit the port number from the real server in a server farm or from the VIP specified in the class map.</p>                                                                                                                  |

1. The Dest IP Address field is not applicable to the Scripted probe type.
2. The Is Routed field is not applicable to the RTSP, Scripted, SIP-TCP, and SIP-UDP probe types.

**Table 8-13**      *Default Port Numbers for Probe Types*

| Probe Type             | Default Port Number |
|------------------------|---------------------|
| DNS                    | 53                  |
| Echo                   | 7                   |
| Finger                 | 79                  |
| FTP                    | 21                  |
| HTTP                   | 80                  |
| HTTPS                  | 443                 |
| ICMP                   | Not applicable      |
| IMAP                   | 143                 |
| POP3                   | 110                 |
| RADIUS                 | 1812                |
| RTSP                   | 554                 |
| Scripted               | 1                   |
| SIP (both TCP and UDP) | 5060                |
| SMTP                   | 25                  |
| SNMP                   | 161                 |
| Telnet                 | 23                  |
| TCP                    | 80                  |
| UDP                    | 53                  |
| VM                     | 443                 |

**Step 6** Enter the attributes for the specific probe type selected as follows:

- For DNS probes, see [Table 8-14](#).
- For Echo-TCP probes, see [Table 8-15](#).
- For Echo-UDP probes, see [Table 8-16](#).
- For Finger probes, see [Table 8-17](#).
- For FTP probes, see [Table 8-18](#).
- For HTTP probes, see [Table 8-19](#).
- For HTTPS probes, see [Table 8-20](#).
- There are no specific attributes for ICMP probes.
- For IMAP probes, see [Table 8-21](#).
- For POP probes, see [Table 8-22](#).
- For RADIUS probes, see [Table 8-23](#).
- For RTSP probes, see [Table 8-24](#).

- For Scripted probes, see [Table 8-25](#).
- For SIP-TCP probes, see [Table 8-26](#).
- For SIP-UDP probes, see [Table 8-27](#).
- For SMTP probes, see [Table 8-28](#).
- For SNMP probes, see [Table 8-29](#).
- For TCP probes, see [Table 8-30](#).
- For Telnet probes, see [Table 8-31](#).
- For UDP probes, see [Table 8-32](#).
- For VM probes, see [Table 8-33](#).

**Step 7** Do one of the following:

- Click **Deploy Now** to deploy this configuration on the ACE and save your entries to the running-configuration and startup-configuration files.
- Click **Cancel** to exit this procedure without saving your entries and to return to the Health Monitoring table.
- Click **Next** to deploy your entries and to configure another probe.

**Step 8** (Optional) To display statistics and status information for a particular probe, choose the probe from the Health Monitoring table, and click **Details**.

The **show probe name detail** CLI command output appears. See the “[Displaying Health Monitoring Statistics and Status Information](#)” section on [page 8-77](#) for details.

---

#### Related Topics

- [Configuring DNS Probe Expect Addresses, page 8-73](#)
- [Configuring Headers for HTTP and HTTPS Probes, page 8-74](#)
- [Configuring Health Monitoring Expect Status, page 8-74](#)
- [Displaying Health Monitoring Statistics and Status Information, page 8-77](#)
- [Configuring Real Servers, page 8-5](#)
- [Configuring Server Farms, page 8-30](#)
- [Configuring Sticky Groups, page 9-7](#)

## Configuring Probe Attributes

You can configure health monitoring probe-specific attributes.

This section includes the following topics:

- [DNS Probe Attributes, page 8-57](#)
- [Echo-TCP Probe Attributes, page 8-58](#)
- [Echo-UDP Probe Attributes, page 8-58](#)
- [Finger Probe Attributes, page 8-58](#)
- [FTP Probe Attributes, page 8-59](#)



- [HTTP Probe Attributes, page 8-60](#)
- [HTTPS Probe Attributes, page 8-61](#)
- [IMAP Probe Attributes, page 8-63](#)
- [POP Probe Attributes, page 8-64](#)
- [RADIUS Probe Attributes, page 8-65](#)
- [RTSP Probe Attributes, page 8-65](#)
- [Scripted Probe Attributes, page 8-66](#)
- [SIP-TCP Probe Attributes, page 8-67](#)
- [SIP-UDP Probe Attributes, page 8-68](#)
- [SMTP Probe Attributes, page 8-69](#)
- [SNMP Probe Attributes, page 8-69](#)
- [TCP Probe Attributes, page 8-70](#)
- [Telnet Probe Attributes, page 8-70](#)
- [UDP Probe Attributes, page 8-71](#)
- [VM Probe Attributes, page 8-72](#)

Refer to the following topics for additional configuration options for health-monitoring probes:

- [Configuring DNS Probe Expect Addresses, page 8-73](#)
- [Configuring Headers for HTTP and HTTPS Probes, page 8-74](#)
- [Configuring Health Monitoring Expect Status, page 8-74](#)
- [Configuring an OID for SNMP Probes, page 8-76](#)
- [Displaying Health Monitoring Statistics and Status Information, page 8-77](#)

## DNS Probe Attributes

[Table 8-14](#) lists the DNS probe attributes.



### Note

Click **More Settings** to access the additional attributes for the DNS probe type. By default, ANM hides the probe attributes with default values and the probe attributes that are not commonly used.

**Table 8-14** *DNS Probe Attributes*

| Field                | Action                                                                                                                                                                                                            |
|----------------------|-------------------------------------------------------------------------------------------------------------------------------------------------------------------------------------------------------------------|
| Domain Name          | Domain name that the probe is to send to the DNS server. Valid entries are unquoted text strings with a maximum of 255 characters.                                                                                |
| <b>More Settings</b> |                                                                                                                                                                                                                   |
| Port                 | Enter the port number that the probe is to use. By default, the probe uses port inheritance to determine the port number. For more information, see the general attribute <a href="#">Port</a> field description. |

To configure expect addresses for DNS probes, see the [“Configuring DNS Probe Expect Addresses” section on page 8-73](#).

## Echo-TCP Probe Attributes

Table 8-15 lists the Echo-TCP probe attributes.

**Note**

Click **More Settings** to access the additional attributes for the Echo-TCP probe type. By default, ANM hides the probe attributes with default values and the probe attributes that are not commonly used.

**Table 8-15** *Echo-TCP Probe Attributes*

| Field                      | Action                                                                                                                                                                                                                                                                                                                                                                                         |
|----------------------------|------------------------------------------------------------------------------------------------------------------------------------------------------------------------------------------------------------------------------------------------------------------------------------------------------------------------------------------------------------------------------------------------|
| Send Data                  | ASCII data that the probe is to send to the server. Valid entries are unquoted text strings with no spaces and a maximum of 255 characters.                                                                                                                                                                                                                                                    |
| <b>More Settings</b>       |                                                                                                                                                                                                                                                                                                                                                                                                |
| TCP Connection Termination | Check box that when checked, configures the ACE to terminate TCP connections gracefully by sending a FIN to the server. Uncheck the check box to configure the ACE to terminate a TCP connection by sending an RST.                                                                                                                                                                            |
| Open Timeout (Seconds)     | Number of seconds to wait when opening a connection with a real server. Valid entries are integers from 1 to 65535. The default is as follows: <ul style="list-style-type: none"> <li>For ACE module version A2(3.x) and earlier, the default is 10 seconds.</li> <li>For ACE module version A4(1.0) and later or ACE appliance version A3(1.x) and later, the default is 1 second.</li> </ul> |

## Echo-UDP Probe Attributes

Table 8-16 lists the Echo-UDP probe attributes.

**Note**

Click **More Settings** to access the additional attributes for the Echo-UDP probe type. By default, ANM hides the probe attributes with default values and the probe attributes that are not commonly used.

**Table 8-16** *Echo-UDP Probe Attributes*

| Field                | Action                                                                                                                                                                                                            |
|----------------------|-------------------------------------------------------------------------------------------------------------------------------------------------------------------------------------------------------------------|
| Send Data            | ASCII data that the probe is to send to the server. Valid entries are unquoted text strings with no spaces and a maximum of 255 characters.                                                                       |
| <b>More Settings</b> |                                                                                                                                                                                                                   |
| Port                 | Enter the port number that the probe is to use. By default, the probe uses port inheritance to determine the port number. For more information, see the general attribute <a href="#">Port</a> field description. |

## Finger Probe Attributes

Table 8-17 lists the Finger probe attributes.

**Note**

Click **More Settings** to access the additional attributes for the Finger probe type. By default, ANM hides the probe attributes with default values and the probe attributes that are not commonly used.

**Table 8-17** *Finger Probe Attributes*

| Field                      | Action                                                                                                                                                                                                                                                                                                                                                                                |
|----------------------------|---------------------------------------------------------------------------------------------------------------------------------------------------------------------------------------------------------------------------------------------------------------------------------------------------------------------------------------------------------------------------------------|
| Send Data                  | ASCII data that the probe is to send to the server. Valid entries are unquoted text strings with no spaces and a maximum of 255 characters.                                                                                                                                                                                                                                           |
| <b>More Settings</b>       |                                                                                                                                                                                                                                                                                                                                                                                       |
| Port                       | Enter the port number that the probe is to use. By default, the probe uses port inheritance to determine the port number. For more information, see the general attribute <a href="#">Port</a> field description.                                                                                                                                                                     |
| TCP Connection Termination | Check box that when checked, configures the ACE to terminate TCP connections gracefully by sending a FIN to the server. Uncheck the check box to configure the ACE to terminate a TCP connection by sending an RST.                                                                                                                                                                   |
| Open Timeout (Seconds)     | Number of seconds to wait when opening a connection with a real server. Valid entries are from 1 to 65535. The default is as follows: <ul style="list-style-type: none"> <li>For ACE module version A2(3.x) and earlier, the default is 10 seconds.</li> <li>For ACE module version A4(1.0) and later or ACE appliance version A3(1.x) and later, the default is 1 second.</li> </ul> |

## FTP Probe Attributes

[Table 8-18](#) lists the FTP probe attributes.



### Note

Click **More Settings** to access the additional attributes for the FTP probe type. By default, ANM hides the probe attributes with default values and the probe attributes that are not commonly used.

**Table 8-18** *FTP Probe Attributes*

| Field                      | Action                                                                                                                                                                                                                                                                                                                                                                                         |
|----------------------------|------------------------------------------------------------------------------------------------------------------------------------------------------------------------------------------------------------------------------------------------------------------------------------------------------------------------------------------------------------------------------------------------|
| <b>More Settings</b>       |                                                                                                                                                                                                                                                                                                                                                                                                |
| Port                       | Enter the port number that the probe is to use. By default, the probe uses port inheritance to determine the port number. For more information, see the general attribute <a href="#">Port</a> field description.                                                                                                                                                                              |
| TCP Connection Termination | Check box that when checked, configures the ACE to terminate TCP connections gracefully by sending a FIN to the server. Uncheck the check box to configure the ACE to terminate a TCP connection by sending an RST.                                                                                                                                                                            |
| Open Timeout (Seconds)     | Number of seconds to wait when opening a connection with a real server. Valid entries are integers from 1 to 65535. The default is as follows: <ul style="list-style-type: none"> <li>For ACE module version A2(3.x) and earlier, the default is 10 seconds.</li> <li>For ACE module version A4(1.0) and later or ACE appliance version A3(1.x) and later, the default is 1 second.</li> </ul> |

To configure probe expect statuses for FTP probes, see the [“Configuring Health Monitoring Expect Status”](#) section on page 8-74.

## HTTP Probe Attributes

Table 8-19 lists the HTTP probe attributes.



**Note**

Click **More Settings** to access the additional attributes for the HTTP probe type. By default, ANM hides the probe attributes with default values and the probe attributes which are not commonly used.

**Table 8-19 HTTP Probe Attributes**

| Field                      | Action                                                                                                                                                                                                                                                                                                                                                                                                                                                                                                                                                                                                                                                                                                                                                                                       |
|----------------------------|----------------------------------------------------------------------------------------------------------------------------------------------------------------------------------------------------------------------------------------------------------------------------------------------------------------------------------------------------------------------------------------------------------------------------------------------------------------------------------------------------------------------------------------------------------------------------------------------------------------------------------------------------------------------------------------------------------------------------------------------------------------------------------------------|
| Port                       | Enter the port number that the probe is to use. By default, the probe uses port inheritance to determine the port number. For more information, see the general attribute <a href="#">Port</a> field description.                                                                                                                                                                                                                                                                                                                                                                                                                                                                                                                                                                            |
| Request Method Type        | Type of HTTP request method that is to be used for this probe.<br>Choose one of the following: <ul style="list-style-type: none"> <li>• <b>N/A</b>—This option is not defined.</li> <li>• <b>Get</b>—The HTTP request method is a GET with a URL of “/”. This request method directs the server to get the page, and the ACE calculates a hash value for the content of the page. If the page content information changes, the hash value no longer matches the original hash value and the ACE assumes the service is down. This is the default request method.</li> <li>• <b>Head</b>—The server is to only get the header for the page. Using this method can prevent the ACE from assuming that the service is down due to changed content and therefore changed hash values.</li> </ul> |
| Request HTTP URL           | Field that appears if you chose Head or Get in the Request Method Type field.<br>Enter the URL path on the remote server. Valid entries are strings of up to 255 characters specifying the URL path. The default path is “/”.                                                                                                                                                                                                                                                                                                                                                                                                                                                                                                                                                                |
| <b>More Settings</b>       |                                                                                                                                                                                                                                                                                                                                                                                                                                                                                                                                                                                                                                                                                                                                                                                              |
| Append Port Host Tag       | Check box that when checked, configures the ACE to append port information in the HTTP Host header when you configure a nondefault destination port for an HTTP probe. By default, the check box is unchecked and the ACE does not append this information.<br><br><div style="border: 1px solid black; padding: 5px;"> <p><b>Note</b> This feature requires ACE module software Version A2(3.4) and ACE appliance software Version A3(2.7) or later releases.</p> </div>                                                                                                                                                                                                                                                                                                                    |
| TCP Connection Termination | Check box that when checked, configures the ACE to terminate TCP connections gracefully by sending a FIN to the server. Uncheck the check box to configure the ACE to terminate a TCP connection by sending an RST.                                                                                                                                                                                                                                                                                                                                                                                                                                                                                                                                                                          |
| Open Timeout (Seconds)     | Number of seconds to wait when opening a connection with a real server. Valid entries are from 1 to 65535. The default is as follows: <ul style="list-style-type: none"> <li>• For ACE module software Version A2(3.x) and earlier, the default is 10 seconds.</li> <li>• For ACE module software Version A4(1.0) and later or ACE appliance software Version A3(1.x) and later, the default is 1 second.</li> </ul>                                                                                                                                                                                                                                                                                                                                                                         |
| User Name                  | User identifier to be used for authentication on the real server. Valid entries are unquoted text strings with a maximum of 64 characters.                                                                                                                                                                                                                                                                                                                                                                                                                                                                                                                                                                                                                                                   |

**Table 8-19** HTTP Probe Attributes (continued)

| Field                     | Action                                                                                                                                                                                                                                                                                                                                                                                                                                                                                                                                   |
|---------------------------|------------------------------------------------------------------------------------------------------------------------------------------------------------------------------------------------------------------------------------------------------------------------------------------------------------------------------------------------------------------------------------------------------------------------------------------------------------------------------------------------------------------------------------------|
| Password                  | Password to be used for authentication on the real server. Valid entries are unquoted text strings with a maximum of 64 characters.<br>Reenter the password in the Confirm field.                                                                                                                                                                                                                                                                                                                                                        |
| Expect Regular Expression | Expected response data from the probe destination. Valid entries are text strings (quotes allowed) with a maximum of 255 characters.                                                                                                                                                                                                                                                                                                                                                                                                     |
| Expect Regex Offset       | Number of characters into the received message or buffer where the ACE is to begin looking for the string specified in the Expect Regular Expression field. Valid entries are from 1 to 4000.                                                                                                                                                                                                                                                                                                                                            |
| Hash                      | Check box that when checked, configures the ACE to use an MD5 hash for an HTTP GET probe. Uncheck the check box to configure the ACE not to use an MD5 hash for an HTTP GET probe.                                                                                                                                                                                                                                                                                                                                                       |
| Hash String               | Field that appears if the Hash check box is selected.<br>Enter the 32-bit hash value that the ACE is to compare with the hash that is generated from the HTTP page sent by the server. If you do not provide this value, the ACE generates a value the first time it queries the server, stores this value, and matches this value with other responses from the server. A successful comparison causes the probe to maintain an Alive state.<br>Enter the MD5 hash value as a quoted or unquoted hexadecimal string with 16 characters. |

To configure probe headers and expect statuses for HTTP probes, see the following topics:

- [Configuring Headers for HTTP and HTTPS Probes, page 8-74](#)
- [Configuring Health Monitoring Expect Status, page 8-74](#)

## HTTPS Probe Attributes

Table 8-20 lists the HTTPS probe attributes.



### Note

Click **More Settings** to access the additional attributes for the HTTPS probe type. By default, ANM hides the probe attributes with default values and the probe attributes that are not commonly used.

Table 8-20 HTTPS Probe Attributes

| Field               | Action                                                                                                                                                                                                                                                                                                                                                                                                                                                                                                                                                                                                                                                                                                                                                                                         |
|---------------------|------------------------------------------------------------------------------------------------------------------------------------------------------------------------------------------------------------------------------------------------------------------------------------------------------------------------------------------------------------------------------------------------------------------------------------------------------------------------------------------------------------------------------------------------------------------------------------------------------------------------------------------------------------------------------------------------------------------------------------------------------------------------------------------------|
| Port                | Enter the port number that the probe is to use. By default, the probe uses port inheritance to determine the port number. For more information, see the general attribute <a href="#">Port</a> field description.                                                                                                                                                                                                                                                                                                                                                                                                                                                                                                                                                                              |
| Request Method Type | Type of HTTP request method that is to be used for this probe.<br>Choose one of the following: <ul style="list-style-type: none"> <li>• <b>N/A</b>—This option is not defined.</li> <li>• <b>Get</b>—The HTTP request method is a GET with a URL of “/”. This request method directs the server to get the page, and the ACE calculates a hash value for the content of the page. If the page content information changes, the hash value no longer matches the original hash value and the ACE assumes the service is down. This is the default request method.</li> <li>• <b>Head</b>—The server is to only get the header for the page. Using this method can prevent the ACE from assuming that the service is down due to changed content and as a result changed hash values.</li> </ul> |
| Request HTTP URL    | Field that appears if you chose Head or Get in the Request Method Type field.<br>Enter the URL path on the remote server. Valid entries are strings of up to 255 characters specifying the URL path. The default path is “/”.                                                                                                                                                                                                                                                                                                                                                                                                                                                                                                                                                                  |
| Cipher              | Choose the cipher suite to be used with this HTTPS probe: <ul style="list-style-type: none"> <li>• <b>RSA_ANY</b>—The HTTPS probe accepts all RSA-configured cipher suites and that no specific suite is configured. This is the default action.</li> <li>• <b>RSA_EXPORT1024_WITH_DES_CBC_SHA</b></li> <li>• <b>RSA_EXPORT1024_WITH_RC4_56_MD5</b></li> <li>• <b>RSA_EXPORT1024_WITH_RC4_56_SHA</b></li> <li>• <b>RSA_EXPORT_WITH_DES40_CBC_SHA</b></li> <li>• <b>RSA_EXPORT_WITH_RC4_40_MD5</b></li> <li>• <b>RSA_WITH_3DES_EDE_CBC_SHA</b></li> <li>• <b>RSA_WITH_AES_128_CBC_SHA</b></li> <li>• <b>RSA_WITH_AES_256_CBC_SHA</b></li> <li>• <b>RSA_WITH_DES_CBC_SHA</b></li> <li>• <b>RSA_WITH_RC4_128_MD5</b></li> <li>• <b>RSA_WITH_RC4_128_SHA</b></li> </ul>                            |
| SSL Version         | Version of SSL or TLS to be used in ClientHello messages sent to the server as follows: <ul style="list-style-type: none"> <li>• <b>All</b>—The probe is to use all SSL versions.</li> <li>• <b>SSLv3</b>—The probe is to use SSL version 3.</li> <li>• <b>TLSv1</b>—The probe is to use TLS version 1.</li> </ul> By default, the probe sends ClientHello messages with an SSL version 3 header and a TLS version 1 message.                                                                                                                                                                                                                                                                                                                                                                  |

### More Settings

Table 8-20 HTTPS Probe Attributes (continued)

| Field                      | Action                                                                                                                                                                                                                                                                                                                                                                                                                                                                                                                                                  |
|----------------------------|---------------------------------------------------------------------------------------------------------------------------------------------------------------------------------------------------------------------------------------------------------------------------------------------------------------------------------------------------------------------------------------------------------------------------------------------------------------------------------------------------------------------------------------------------------|
| Append Port Host Tag       | <p>Check box that when checked, configures the ACE to append port information in the HTTPS Host header when you configure a nondefault destination port for an HTTPS probe. By default, the check box is unchecked and the ACE does not append this information.</p> <p> <b>Note</b> This feature requires ACE module software Version A2(3.4) and ACE appliance software Version A3(2.7) or later releases.</p>                                                       |
| TCP Connection Termination | <p>Check box that when checked, configures the ACE to terminate TCP connections gracefully by sending a FIN to the server. Uncheck the check box to configure the ACE to terminate a TCP connection by sending an RST.</p>                                                                                                                                                                                                                                                                                                                              |
| Open Timeout (Seconds)     | <p>Number of seconds to wait when opening a connection with a real server. Valid entries are from 1 to 65535. The default is as follows:</p> <ul style="list-style-type: none"> <li>For ACE module version A2(3.x) and earlier, the default is 10 seconds.</li> <li>For ACE module version A4(1.0) and later or ACE appliance version A3(1.x) and later, the default is 1 second.</li> </ul>                                                                                                                                                            |
| User Name                  | <p>User identifier to be used for authentication on the real server. Valid entries are unquoted text strings with a maximum of 64 characters.</p>                                                                                                                                                                                                                                                                                                                                                                                                       |
| Password                   | <p>Password to be used for authentication on the real server. Valid entries are unquoted text strings with a maximum of 64 characters.</p> <p>Reenter the password in the Confirm field.</p>                                                                                                                                                                                                                                                                                                                                                            |
| Expect Regular Expression  | <p>Expected response data from the probe destination. Valid entries are text strings (quotes allowed) with a maximum of 255 characters.</p>                                                                                                                                                                                                                                                                                                                                                                                                             |
| Expect Regex Offset        | <p>Number of characters into the received message or buffer where the ACE is to begin looking for the string specified in the Expect Regular Expression field. Value entries are from 1 to 4000.</p>                                                                                                                                                                                                                                                                                                                                                    |
| Hash                       | <p>Check box that when checked, configures the ACE to use an MD5 hash for an HTTP GET probe. Uncheck the check box to configure the ACE not to use an MD5 hash for an HTTP GET probe.</p>                                                                                                                                                                                                                                                                                                                                                               |
| Hash String                | <p>Field that appears if the Hash check box is selected.</p> <p>Enter the 32-bit hash value that the ACE is to compare with the hash that is generated from the HTTP page sent by the server. If you do not provide this value, the ACE generates a value the first time it queries the server, stores this value, and matches this value with other responses from the server. A successful comparison causes the probe to maintain an Alive state.</p> <p>Enter the MD5 hash value as a quoted or unquoted hexadecimal string with 16 characters.</p> |

To configure probe headers and expect statuses for HTTPS probes, see the following topics:

- [Configuring Headers for HTTP and HTTPS Probes, page 8-74](#)
- [Configuring Health Monitoring Expect Status, page 8-74](#)

## IMAP Probe Attributes

[Table 8-21](#) lists the IMAP probe attributes.

**Note**

Click **More Settings** to access the additional attributes for the IMAP probe type. By default, ANM hides the probe attributes with default values and the probe attributes are not commonly used.

**Table 8-21** IMAP Probe Attributes

| Field                      | Action                                                                                                                                                                                                                                                                                                                                                                                |
|----------------------------|---------------------------------------------------------------------------------------------------------------------------------------------------------------------------------------------------------------------------------------------------------------------------------------------------------------------------------------------------------------------------------------|
| User Name                  | User identifier to be used for authentication on the real server. Valid entries are unquoted text strings with a maximum of 64 characters.                                                                                                                                                                                                                                            |
| Password                   | Password to be used for authentication on the real server. Valid entries are unquoted text strings with a maximum of 64 characters.<br>Reenter the password in the Confirm field.                                                                                                                                                                                                     |
| Mailbox Name               | User mailbox name from which to retrieve email for this IMAP probe. Valid entries are unquoted text strings with a maximum of 64 characters.                                                                                                                                                                                                                                          |
| Request Command            | Request method command for this probe. Valid entries are text strings with a maximum of 32 characters and no spaces.                                                                                                                                                                                                                                                                  |
| <b>More Settings</b>       |                                                                                                                                                                                                                                                                                                                                                                                       |
| Port                       | Enter the port number that the probe is to use. By default, the probe uses port inheritance to determine the port number. For more information, see the general attribute <a href="#">Port</a> field description.                                                                                                                                                                     |
| TCP Connection Termination | Check box that when checked, configures the ACE to terminate TCP connections gracefully by sending a FIN to the server. Uncheck the check box to configure the ACE to terminate a TCP connection by sending an RST.                                                                                                                                                                   |
| Open Timeout (Seconds)     | Number of seconds to wait when opening a connection with a real server. Valid entries are from 1 to 65535. The default is as follows: <ul style="list-style-type: none"> <li>For ACE module version A2(3.x) and earlier, the default is 10 seconds.</li> <li>For ACE module version A4(1.0) and later or ACE appliance version A3(1.x) and later, the default is 1 second.</li> </ul> |

**POP Probe Attributes**

[Table 8-22](#) lists the POP probe attributes.

**Note**

Click **More Settings** to access the additional attributes for the POP probe type. By default, ANM hides the probe attributes with default values and the probe attributes which are not commonly used.

**Table 8-22** POP Probe Attributes

| Field     | Action                                                                                                                                                                            |
|-----------|-----------------------------------------------------------------------------------------------------------------------------------------------------------------------------------|
| User Name | User identifier to be used for authentication on the real server. Valid entries are unquoted text strings with a maximum of 64 characters.                                        |
| Password  | Password to be used for authentication on the real server. Valid entries are unquoted text strings with a maximum of 64 characters.<br>Reenter the password in the Confirm field. |



**Table 8-22** POP Probe Attributes (continued)

| Field                      | Action                                                                                                                                                                                                                                                                                                                                                                                |
|----------------------------|---------------------------------------------------------------------------------------------------------------------------------------------------------------------------------------------------------------------------------------------------------------------------------------------------------------------------------------------------------------------------------------|
| Request Command            | Request method command for this probe. Valid entries are text strings with a maximum of 32 characters and no spaces.                                                                                                                                                                                                                                                                  |
| <b>More Settings</b>       |                                                                                                                                                                                                                                                                                                                                                                                       |
| Port                       | Enter the port number that the probe is to use. By default, the probe uses port inheritance to determine the port number. For more information, see the general attribute <a href="#">Port</a> field description.                                                                                                                                                                     |
| TCP Connection Termination | Check box that when checked, configures the ACE to terminate TCP connections gracefully by sending a FIN to the server. Uncheck the check box to configure the ACE to terminate a TCP connection by sending an RST.                                                                                                                                                                   |
| Open Timeout (seconds)     | Number of seconds to wait when opening a connection with a real server. Valid entries are from 1 to 65535. The default is as follows: <ul style="list-style-type: none"> <li>For ACE module version A2(3.x) and earlier, the default is 10 seconds.</li> <li>For ACE module version A4(1.0) and later or ACE appliance version A3(1.x) and later, the default is 1 second.</li> </ul> |

## RADIUS Probe Attributes

[Table 8-23](#) lists the RADIUS probe attributes.



### Note

Click **More Settings** to access the additional attributes for the RADIUS probe type. By default, ANM hides the probe attributes with default values and the probe attributes that are not commonly used.

**Table 8-23** RADIUS Probe Attributes

| Field                | Action                                                                                                                                                                                                            |
|----------------------|-------------------------------------------------------------------------------------------------------------------------------------------------------------------------------------------------------------------|
| User Secret          | Shared secret to be used to allow probe access to the RADIUS server. Valid entries are case-sensitive strings with no spaces and a maximum of 64 characters.                                                      |
| User Name            | User identifier to be used for authentication on the real server. Valid entries are unquoted text strings with a maximum of 64 characters.                                                                        |
| Password             | Password to be used for authentication on the real server. Valid entries are unquoted text strings with a maximum of 64 characters.<br>Reenter the password in the Confirm field.                                 |
| <b>More Settings</b> |                                                                                                                                                                                                                   |
| Port                 | Enter the port number that the probe is to use. By default, the probe uses port inheritance to determine the port number. For more information, see the general attribute <a href="#">Port</a> field description. |
| NAS IP Address       | IP address of the Network Access Server (NAS) in dotted-decimal format, such as 192.168.11.1.                                                                                                                     |

## RTSP Probe Attributes

[Table 8-24](#) lists the RTSP probe attributes.

**Note**

Click **More Settings** to access the additional attributes for the RTSP probe type. By default, ANM hides the probe attributes with default values and the probe attributes that are not commonly used.

**Table 8-24 RTSP Probe Attributes**

| Field                           | Action                                                                                                                                                                                                                                                                                                                                                                                    |
|---------------------------------|-------------------------------------------------------------------------------------------------------------------------------------------------------------------------------------------------------------------------------------------------------------------------------------------------------------------------------------------------------------------------------------------|
| Port                            | Enter the port number that the probe is to use. By default, the probe uses port inheritance to determine the port number. For more information, see the general attribute <a href="#">Port</a> field description.                                                                                                                                                                         |
| RTSP Require Header Value       | Require header for the probe.                                                                                                                                                                                                                                                                                                                                                             |
| RTSP Proxy Require Header Value | Proxy-Require header for the probe.                                                                                                                                                                                                                                                                                                                                                       |
| RTSP Request Method Type        | Request method type: <ul style="list-style-type: none"> <li>• <b>N/A</b>—No request method is selected.</li> <li>• <b>Describe</b>—Probe is to use the Describe request type.</li> </ul>                                                                                                                                                                                                  |
| <b>More Settings</b>            |                                                                                                                                                                                                                                                                                                                                                                                           |
| TCP Connection Termination      | Check box that when checked, configures the ACE to terminate TCP connections gracefully by sending a FIN to the server. Uncheck the check box to configure the ACE to terminate a TCP connection by sending an RST.                                                                                                                                                                       |
| Open Timeout (Seconds)          | Number of seconds to wait when opening a connection with a real server. Valid entries are from 1 to 65535. The default is as follows: <ul style="list-style-type: none"> <li>• For ACE module version A2(3.x) and earlier, the default is 10 seconds.</li> <li>• For ACE module version A4(1.0) and later or ACE appliance version A3(1.x) and later, the default is 1 second.</li> </ul> |

To configure probe expect statuses for RTSP probes, see the “[Configuring Health Monitoring Expect Status](#)” section on page 8-74.

## Scripted Probe Attributes

[Table 8-25](#) lists the HTTP probe attributes.

**Note**

Click **More Settings** to access the additional attributes for the Scripted probe type. By default, ANM hides the probe attributes with default values and the probe attributes that are not commonly used.

**Table 8-25** Scripted Probe Attributes

| Field                                           | Action                                                                                                                                                                                                                                                                                                                                                                                                                                                                                                                                                                    |
|-------------------------------------------------|---------------------------------------------------------------------------------------------------------------------------------------------------------------------------------------------------------------------------------------------------------------------------------------------------------------------------------------------------------------------------------------------------------------------------------------------------------------------------------------------------------------------------------------------------------------------------|
| Port                                            | Enter the port number that the probe is to use. By default, the probe uses port inheritance to determine the port number. For more information, see the general attribute <a href="#">Port</a> field description.                                                                                                                                                                                                                                                                                                                                                         |
| Script Name                                     | Local name that you want to assign to this file on the ACE. This file can reside in the disk0: directory or the probe: directory (if the probe: directory exists).<br><br> <b>Note</b> The script file must first be established on the ACE device and the name must be entered exactly as is appears on the device. See your ACE documentation for more details.<br><br>Valid entries are unquoted text strings with no spaces and a maximum of 255 characters.                         |
| Script Arguments                                | Valid arguments, which are unquoted text strings with no spaces; separate multiple arguments with a space. The field limit is 255 characters.                                                                                                                                                                                                                                                                                                                                                                                                                             |
| <b>More Settings</b>                            |                                                                                                                                                                                                                                                                                                                                                                                                                                                                                                                                                                           |
| Script Needs To Be Copied From Remote Location? | Check box that indicates that the file needs to be copied from a remote server. Uncheck this check box to indicate that the script resides locally.                                                                                                                                                                                                                                                                                                                                                                                                                       |
| Protocol                                        | Field that appears if the script is to be copied from a remote server.<br>Choose the protocol to be used for copying the script: <ul style="list-style-type: none"> <li>• <b>FTP</b>—The script is to be copied using FTP.</li> <li>• <b>TFTP</b>—The script is to be copied using TFTP.</li> </ul>                                                                                                                                                                                                                                                                       |
| User Name                                       | Field that appears if FTP is selected in the Protocol field.<br>Enter the name of the user account on the remote server.                                                                                                                                                                                                                                                                                                                                                                                                                                                  |
| Password                                        | Field that appears if FTP is selected in the Protocol field.<br>Enter the password for the user account on the remote server.<br>Reenter the password in the Confirm field.                                                                                                                                                                                                                                                                                                                                                                                               |
| Source File Name                                | Field appears if the script is to be copied from a remote server.<br>Enter the host IP address, path, and filename of the file on the remote server in the format <i>host-ip/path/filename</i> where: <ul style="list-style-type: none"> <li>• <i>host-ip</i> represents the IP address of the remote server.</li> <li>• <i>path</i> represents the directory path of the file on the remote server.</li> <li>• <i>filename</i> represents the filename of the file on the remote server.</li> </ul> For example, your entry might be 192.168.11.2/usr/bin/my-script.ext. |

## SIP-TCP Probe Attributes

[Table 8-26](#) lists the SIP-TCP probe attributes.



### Note

Click **More Settings** to access the additional attributes for the SIP-TCP probe type. By default, ANM hides the probe attributes with default values and the probe attributes that are not commonly used.

**Table 8-26** SIP-TCP Probe Attributes

| Field                      | Action                                                                                                                                                                                                                                                                                                                                                                               |
|----------------------------|--------------------------------------------------------------------------------------------------------------------------------------------------------------------------------------------------------------------------------------------------------------------------------------------------------------------------------------------------------------------------------------|
| <b>More Settings</b>       |                                                                                                                                                                                                                                                                                                                                                                                      |
| Port                       | Enter the port number that the probe is to use. By default, the probe uses port inheritance to determine the port number. For more information, see the general attribute <a href="#">Port</a> field description.                                                                                                                                                                    |
| TCP Connection Termination | Check box that when checked, configures the ACE to terminate TCP connections gracefully by sending a FIN to the server. Uncheck the check box to configure the ACE to terminate a TCP connection by sending an RST.                                                                                                                                                                  |
| Open Timeout (Seconds)     | Number of seconds to wait when opening a connection with a real server. Valid entries are from 1 to 65535. The default is as follows <ul style="list-style-type: none"> <li>For ACE module version A2(3.x) and earlier, the default is 10 seconds.</li> <li>For ACE module version A4(1.0) and later or ACE appliance version A3(1.x) and later, the default is 1 second.</li> </ul> |
| Expect Regular Expression  | Expected response data from the probe destination. Valid entries are text strings with a maximum of 255 characters. This field accepts both single and double quotes. Double quotes are considered delimiters so they don't appear on the device. Single quotes will appear on the device.                                                                                           |
| Expect Regex Offset        | Number of characters into the received message or buffer where the ACE is to begin looking for the string specified in the Expect Regular Expression field. Value entries are from 1 to 4000.                                                                                                                                                                                        |

To configure probe expect statuses for SIP-TCP probes, see the [“Configuring Health Monitoring Expect Status”](#) section on page 8-74.

## SIP-UDP Probe Attributes

[Table 8-27](#) lists the SIP-UDP probe attributes.



### Note

Click **More Settings** to access the additional attributes for the SIP-UDP probe type. By default, ANM hides the probe attributes with default values and the probe attributes that are not commonly used.

**Table 8-27** SIP-UDP Probe Attributes

| Field                     | Action                                                                                                                                                                                                                                                                                     |
|---------------------------|--------------------------------------------------------------------------------------------------------------------------------------------------------------------------------------------------------------------------------------------------------------------------------------------|
| <b>More Settings</b>      |                                                                                                                                                                                                                                                                                            |
| Port                      | Enter the port number that the probe is to use. By default, the probe uses port inheritance to determine the port number. For more information, see the general attribute <a href="#">Port</a> field description.                                                                          |
| Expect Regular Expression | Expected response data from the probe destination. Valid entries are text strings with a maximum of 255 characters. This field accepts both single and double quotes. Double quotes are considered delimiters so they don't appear on the device. Single quotes will appear on the device. |
| Expect Regex Offset       | Number of characters into the received message or buffer where the ACE is to begin looking for the string specified in the Expect Regular Expression field. Value entries are from 1 to 4000.                                                                                              |

To configure probe expect statuses for SIP-UDP probes, see the “[Configuring Health Monitoring Expect Status](#)” section on page 8-74.

## SMTP Probe Attributes

Table 8-28 lists the SMTP probe attributes.



### Note

Click **More Settings** to access the additional attributes for the SMTP probe type. By default, ANM hides the probe attributes with default values and the probe attributes that are not commonly used.

**Table 8-28** SMTP Probe Attributes

| Field                      | Action                                                                                                                                                                                                                                                                                                                                                                                |
|----------------------------|---------------------------------------------------------------------------------------------------------------------------------------------------------------------------------------------------------------------------------------------------------------------------------------------------------------------------------------------------------------------------------------|
| <b>More Settings</b>       |                                                                                                                                                                                                                                                                                                                                                                                       |
| Port                       | Enter the port number that the probe is to use. By default, the probe uses port inheritance to determine the port number. For more information, see the general attribute <a href="#">Port</a> field description.                                                                                                                                                                     |
| TCP Connection Termination | Check box that when checked, configures the ACE to terminate TCP connections gracefully by sending a FIN to the server. Uncheck the check box to configure the ACE to terminate a TCP connection by sending an RST.                                                                                                                                                                   |
| Open Timeout (Seconds)     | Number of seconds to wait when opening a connection with a real server. Valid entries are from 1 to 65535. The default is as follows: <ul style="list-style-type: none"> <li>For ACE module version A2(3.x) and earlier, the default is 10 seconds.</li> <li>For ACE module version A4(1.0) and later or ACE appliance version A3(1.x) and later, the default is 1 second.</li> </ul> |

To configure probe expect statuses for SMTP probes, see the “[Configuring Health Monitoring Expect Status](#)” section on page 8-74.

## SNMP Probe Attributes

Table 8-29 lists the SNMP probe attributes.



### Note

Click **More Settings** to access the additional attributes for the SNMP probe type. By default, ANM hides the probe attributes with default values and the probe attributes that are not commonly used.

**Table 8-29** SNMP Probe Attributes

| Field                | Action                                                                                                         |
|----------------------|----------------------------------------------------------------------------------------------------------------|
| SNMP Community       | SNMP community string. Valid entries are unquoted text strings with no spaces and a maximum of 255 characters. |
| <b>More Settings</b> |                                                                                                                |

**Table 8-29** *SNMP Probe Attributes (continued)*

| Field        | Action                                                                                                                                                                                                                                           |
|--------------|--------------------------------------------------------------------------------------------------------------------------------------------------------------------------------------------------------------------------------------------------|
| Port         | Enter the port number that the probe is to use. By default, the probe uses port inheritance to determine the port number. For more information, see the general attribute <a href="#">Port</a> field description.                                |
| SNMP Version | SNMP version for the probe: <ul style="list-style-type: none"> <li>• <b>N/A</b>—No version is selected.</li> <li>• <b>SNMPv1</b>—This probe is to use SNMP version 1.</li> <li>• <b>SNMPv2c</b>—This probe is to use SNMP version 2c.</li> </ul> |

To configure the SNMP OID for SNMP probes, see the “[Configuring an OID for SNMP Probes](#)” section on page 8-76.

## TCP Probe Attributes

[Table 8-30](#) lists the TCP probe attributes.



### Note

Click **More Settings** to access the additional attributes for the TCP probe type. By default, ANM hides the probe attributes with default values and the probe attributes that are not commonly used.

**Table 8-30** *TCP Probe Attributes*

| Field                      | Action                                                                                                                                                                                                                                                                                                                                                                                    |
|----------------------------|-------------------------------------------------------------------------------------------------------------------------------------------------------------------------------------------------------------------------------------------------------------------------------------------------------------------------------------------------------------------------------------------|
| Port                       | Enter the port number that the probe is to use. By default, the probe uses port inheritance to determine the port number. For more information, see the general attribute <a href="#">Port</a> field description.                                                                                                                                                                         |
| Send Data                  | ASCII data that the probe is to send to the server. Valid entries are unquoted text strings with no spaces and a maximum of 255 characters.                                                                                                                                                                                                                                               |
| <b>More Settings</b>       |                                                                                                                                                                                                                                                                                                                                                                                           |
| TCP Connection Termination | Check box that when checked, configures the ACE to terminate TCP connections gracefully by sending a FIN to the server. Uncheck the check box to configure the ACE to terminate a TCP connection by sending an RST.                                                                                                                                                                       |
| Open Timeout (Seconds)     | Number of seconds to wait when opening a connection with a real server. Valid entries are from 1 to 65535. The default is as follows: <ul style="list-style-type: none"> <li>• For ACE module version A2(3.x) and earlier, the default is 10 seconds.</li> <li>• For ACE module version A4(1.0) and later or ACE appliance version A3(1.x) and later, the default is 1 second.</li> </ul> |
| Expect Regular Expression  | Expected response data from the probe destination. Valid entries are text strings (quotes allowed) with a maximum of 255 characters.                                                                                                                                                                                                                                                      |
| Expect Regex Offset        | Number of characters into the received message or buffer where the ACE is to begin looking for the string specified in the Expect Regular Expression field. Value entries are from 1 to 4000.                                                                                                                                                                                             |

## Telnet Probe Attributes

[Table 8-31](#) lists the Telnet probe attributes.

**Note**

Click **More Settings** to access the additional attributes for the Telnet probe type. By default, ANM hides the probe attributes with default values and the probe attributes that are not commonly used.

**Table 8-31** *Telnet Probe Attributes*

| Field                      | Action                                                                                                                                                                                                                                                                                                                                                                                          |
|----------------------------|-------------------------------------------------------------------------------------------------------------------------------------------------------------------------------------------------------------------------------------------------------------------------------------------------------------------------------------------------------------------------------------------------|
| <b>More Settings</b>       |                                                                                                                                                                                                                                                                                                                                                                                                 |
| Port                       | Enter the port number that the probe is to use. By default, the probe uses port inheritance to determine the port number. For more information, see the general attribute <a href="#">Port</a> field description.                                                                                                                                                                               |
| TCP Connection Termination | Check box that when checked, configures the ACE to terminate TCP connections gracefully by sending a FIN to the server. Uncheck the check box to configure the ACE to terminate a TCP connection by sending an RST.                                                                                                                                                                             |
| Open Timeout (Seconds)     | Enter the number of seconds to wait when opening a connection with a real server. Valid entries are from 1 to 65535. The default is as follows: <ul style="list-style-type: none"> <li>For ACE module version A2(3.x) and earlier, the default is 10 seconds.</li> <li>For ACE module version A4(1.0) and later or ACE appliance version A3(1.x) and later, the default is 1 second.</li> </ul> |

**UDP Probe Attributes**

[Table 8-32](#) lists the UDP probe attributes.

**Note**

Click **More Settings** to access the additional attributes for the UDP probe type. By default, ANM hides the probe attributes with default values and the probe attributes that are not commonly used.

**Table 8-32** *UDP Probe Attributes*

| Field                     | Action                                                                                                                                                                                                            |
|---------------------------|-------------------------------------------------------------------------------------------------------------------------------------------------------------------------------------------------------------------|
| Port                      | Enter the port number that the probe is to use. By default, the probe uses port inheritance to determine the port number. For more information, see the general attribute <a href="#">Port</a> field description. |
| Send Data                 | ASCII data that the probe is to send to the server. Valid entries are unquoted text strings with no spaces and a maximum of 255 characters.                                                                       |
| <b>More Settings</b>      |                                                                                                                                                                                                                   |
| Expect Regular Expression | Expected response data from the probe destination. Valid entries are text strings (quotes allowed) with a maximum of 255 characters.                                                                              |
| Expect Regex Offset       | Number of characters into the received message or buffer where the ACE is to begin looking for the string specified in the Expect Regular Expression field. Value entries are from 1 to 4000.                     |

## VM Probe Attributes



**Note**

You use a VM probe when you configure the ACE for Dynamic Workload Scaling (see the [“Configuring Dynamic Workload Scaling”](#) section on page 8-26), which requires that the ACE appliance or module is using software Version A4(2.0) or a later release.

You configure the VM probe attributes to control when the ACE bursts traffic to remote VMs based on an average of local VM CPU usage, memory usage, or both. The ACE obtains the usage information by sending the VM probe to the specified VM Controller associated with the local VMs (see [Figure 1-1](#)). It calculates the average aggregate load information for all local VMs as a percentage of CPU usage or memory usage and uses either or both percentages to determine when to burst traffic to the remote data center. If the server farm consists of both physical servers and VMs, the ACE considers load information only from the VMs.

By default, the VM probe checks the percentage of usage for either the CPU or memory against the maximum threshold value. Whichever percentage reaches its maximum threshold value first causes the ACE to burst traffic to the remote data center. The default maximum burst threshold value of 99 percent instructs the ACE to always load balance traffic to the local VMs unless the load value is equal to 100 percent or the VMs are not in the Operational state. If you configure the maximum burst threshold value to 1 percent, the ACE always bursts traffic to the remote data center.

When the usage percentage is less than the minimum threshold value, the ACE stops bursting traffic to the remote data center and continues to load balance traffic to the local VMs. Any active connections to the remote data center are allowed to complete.

[Table 8-33](#) lists the VM probe attributes.

**Table 8-33 VM Probe Attributes**

| Field                      | Action                                                                                                                                                                                                                                          |
|----------------------------|-------------------------------------------------------------------------------------------------------------------------------------------------------------------------------------------------------------------------------------------------|
| Max CPU Burst Threshold    | Percentage of CPU usage by the local VMs at which the ACE begins to burst traffic to the remote VMs. Enter a value from 1 to 99. The default is 99.                                                                                             |
| Min CPU Burst Threshold    | Percentage of CPU usage by the local VMs below which the ACE stops bursting traffic to the remote VMs. Enter a value from 1 to 99. The default is 99.                                                                                           |
| Max Memory Burst Threshold | Percentage of memory usage by the local VMs at which the ACE begins to burst traffic to the remote VMs. Enter a value from 1 to 99. The default is 99.                                                                                          |
| Min Memory Burst Threshold | Percentage of memory usage by the local VMs below which the ACE stops bursting traffic to the remote VMs. Enter a value from 1 to 99. The default is 99.                                                                                        |
| VM Controller Name         | Identifier of the VM Controller that is associated with the local VMs and that you configured in the <a href="#">“Configuring and Verifying a VM Controller Connection”</a> section on page 8-29. Click the radio button for the VM Controller. |

To associate the VM probe with a server farm, see the [“Configuring Server Farms”](#) section on page 8-30.

**Related Topics**

- [Configuring Dynamic Workload Scaling, page 8-26](#)
- [Configuring Server Farms, page 8-30](#)
- [Dynamic Workload Scaling Overview, page 8-4](#)



## Configuring DNS Probe Expect Addresses

You can specify the IP address that the ACE expects to receive in response to a DNS request. When a DNS probe sends a domain name resolve request to the server, it verifies the returned IP address by matching the received IP address with the configured addresses.

### Assumption

A DNS probe has been configured. See the “[Configuring Health Monitoring for Real Servers](#)” section on page 8-51 for more information.

### Procedure

---

**Step 1** Choose **Config > Devices > context > Load Balancing > Health Monitoring**.

The Health Monitoring table appears.

**Step 2** In the Health Monitoring table, choose the DNS probe that you want to configure with an expected IP address.

The Expect Addresses table appears.

**Step 3** In the Expect Addresses table, click **Add** to add an entry to the Expect Addresses table.

The Expect Address configuration pane appears.



---

**Note** You cannot modify an entry in the Expect Addresses table. Instead, delete the existing entry, then add a new one.

---

**Step 4** In the IPv4/IPv6 Address field, enter the IP address that the ACE appliance is to expect as a server response to a DNS request. You can enter multiple addresses in this field. However, you cannot mix IPv4 and IPv6 addresses.



---

**Note** IPv6 requires ACE module and ACE appliance software Version A5(1.0) or later.

---

**Step 5** Do one of the following:

- Click **Deploy Now** to deploy this configuration on the ACE and save your entries to the running-configuration and startup-configuration files.
  - Click **Cancel** to exit this procedure without saving your entry and to return to the Expect Addresses table.
  - Click **Next** to deploy your entry and to add another IP Address to the Expect Addresses table.
- 

### Related Topics

- [Configuring Health Monitoring for Real Servers, page 8-51](#)
- [DNS Probe Attributes, page 8-57](#)
- [Displaying Health Monitoring Statistics and Status Information, page 8-77](#)

## Configuring Headers for HTTP and HTTPS Probes

You can specify header fields for HTTP and HTTPS probes.

### Assumption

An HTTP or HTTPS probe has been configured. See the [“Configuring Health Monitoring for Real Servers” section on page 8-51](#) for more information.

### Procedure

- 
- Step 1** Choose **Config > Devices > context > Load Balancing > Health Monitoring**.  
The Health Monitoring table appears.
- Step 2** In the Health Monitoring table, choose the HTTP or HTTPS probe that you want to configure with a header.  
The Probe Headers table appears.
- Step 3** In the Probe Headers table, click **Add** to add an entry, or choose an existing entry and click **Edit** to modify it.  
The Probe Headers configuration pane appears.
- Step 4** In the Header Name field of the Probe Headers configuration pane, choose the HTTP header the probe is to use.
- Step 5** In the Header Value field, enter the string to assign to the header field.  
Valid entries are text strings with a maximum of 255 characters. If the string includes spaces, enclose the string with quotes.
- Step 6** Do one of the following:
- Click **Deploy Now** to deploy this configuration on the ACE and save your entries to the running-configuration and startup-configuration files.
  - Click **Cancel** to exit this procedure without saving your entry and to return to the Probe Headers table.
  - Click **Next** to deploy your entry and to add another header entry to the Probe Headers table.
- 

### Related Topics

- [Configuring Health Monitoring for Real Servers, page 8-51](#)
- [HTTP Probe Attributes, page 8-60](#)
- [HTTPS Probe Attributes, page 8-61](#)
- [Displaying Health Monitoring Statistics and Status Information, page 8-77](#)

## Configuring Health Monitoring Expect Status

You can configure a single or range of code responses that the ACE expects from the probe destination. When the ACE receives a response from the server, it expects a status code to mark a server as passed. By default, there are no status codes configured on the ACE. If you do not configure a status code, any response code from the server is marked as failed.

Expect status codes can be configured for FTP, HTTP, HTTPS, RTSP, SIP-TCP, SIP-UDP, and SMTP probes.

### Assumption

An FTP, HTTP, HTTPS, RTSP, SIP-TCP, SIP-UDP or SMTP probe has been configured. See the [“Configuring Health Monitoring for Real Servers”](#) section on page 8-51 for more information.

### Procedure

- 
- Step 1** Choose **Config > Devices > context > Load Balancing > Health Monitoring**.
- The Health Monitoring table appears.
- Step 2** In the Health Monitoring table, choose the probe that you want to configure for expect status codes, and click the **Expect Status** tab.
- The Expect Status table appears.
- Step 3** In the Expect Status table, click **Add** to add an entry, or select an existing entry and click **Edit** to modify it.
- The Expect Status configuration pane appears.
- Step 4** In the Expect Status configuration pane, configure a single expect status code as follows:
- In the Min. Expect Status Code field, enter the expect status code for this probe. Valid entries are from 0 to 999.
  - In the Max. Expect Status code, enter the same expect status code that you entered in the Min Expect Status Code field.
- Step 5** In the Expect Status configuration pane, configure a range of expect status codes as follows:
- In the Min. Expect Status Code, enter the lower limit of the range of status codes. Valid entries are from 0 to 999.
  - In the Max. Expect Status Code, enter the upper limit of a range of status codes. Valid entries are from 0 to 999. The value in this field must be greater than or equal to the value in the Min Expect Status Code field.
- Step 6** Do one of the following:
- Click **Deploy Now** to deploy this configuration on the ACE and save your entries to the running-configuration and startup-configuration files.
  - Click **Cancel** to exit this procedure without saving your entries and to return to the Expect Status table.
  - Click **Next** to deploy your entries and to add another expect status code to the Expect Status table.
- 

### Related Topics

- [Configuring Health Monitoring for Real Servers, page 8-51](#)
- [FTP Probe Attributes, page 8-59](#)
- [HTTP Probe Attributes, page 8-60](#)
- [SMTP Probe Attributes, page 8-69](#)
- [Displaying Health Monitoring Statistics and Status Information, page 8-77](#)

## Configuring an OID for SNMP Probes

You can configure OID queries to probe the server. When the ACE sends a probe with an SNMP OID query, the ACE uses the retrieved value as input to the least-loaded algorithm for load-balancing decisions. Least-loaded load balancing bases the server selection on the server with the lowest load value. If the retrieved value is within the configured threshold, the server is marked as passed. If the threshold is exceeded, the server is marked as failed.

The ACE allows a maximum of eight OID queries to probe the server.

### Assumption

An SNMP probe has been configured. See the “[Configuring Health Monitoring for Real Servers](#)” section on page 8-51 for more information.

### Procedure

- 
- Step 1** Choose **Config > Devices > context > Load Balancing > Health Monitoring**.  
The Health Monitoring table appears.
- Step 2** In the Health Monitoring table, choose the SNMP probe for which you want to specify an OID.  
The SNMP OID for Server Load Query table appears.
- Step 3** In the SNMP OID for Server Load Query table, click **Add** to add an entry, or choose an existing entry and click **Edit** to modify it.  
The SNMP OID configuration pane appears.
- Step 4** In the SNMP OID field of the SNMP OID configuration pane, enter the OID that the probe is to use to query the server for a value.  
Valid entries are unquoted strings with a maximum of 255 alphanumeric characters in dotted-decimal notation, such as .1.3.6.1.4.2021.10.1.3.1. The OID string is based on the server type.
- Step 5** In the Max. Absolute Server Load Value field, enter the OID value in the form of an integer and to indicate that the retrieved OID value is an absolute value instead of a percent.  
Valid entries are from 1 to 4294967295.  
When the ACE sends a probe with an SNMP OID query, the ACE uses the retrieved value as input to the least-loaded algorithm for load-balancing decisions. By default, the ACE assumes that the retrieved OID value is a percentile value. Use this option to specify that the retrieved OID value is an absolute value.
- Step 6** In the Server Load Threshold Value field, specify the threshold at which the server is to be taken out of service as follows:
- When the OID value is based on a percent, valid entries are integers from 1 to 100.
  - When the OID is based on an absolute value, valid entries are from 1 to the value specified in the Maximum Absolute Server Load Value field.
- Step 7** In the Server Load Weighting field, enter the weight to assign to this OID for the SNMP probe.  
Valid entries are from 0 to 16000.
- Step 8** Do one of the following:
- Click **Deploy Now** to deploy this configuration on the ACE and save your entries to the running-configuration and startup-configuration files.
  - Click **Cancel** to exit this procedure without saving your entries and to return to the SNMP OID table.

- Click **Next** to deploy your entries and to add another item to the SNMP OID table.
- 

#### Related Topics

- [Configuring Health Monitoring for Real Servers, page 8-51](#)
- [SNMP Probe Attributes, page 8-69](#)
- [Displaying Health Monitoring Statistics and Status Information, page 8-77](#)

## Displaying Health Monitoring Statistics and Status Information

You can display statistics and status information for a particular probe.

#### Procedure

---

**Step 1** Choose **Config > Devices > context > Load Balancing > Health Monitoring**.

The Health Monitoring table appears.

**Step 2** In the Health Monitoring table, choose a probe from the Health Monitoring table, and click **Details**.

The **show probe name detail** CLI command output appears. For details on the displayed output fields, see the *Cisco ACE Module Server Load-Balancing Configuration Guide* or the *Cisco ACE 4700 Series Appliance Server Load-Balancing Configuration Guide*, Chapter 4, Configuring Health Monitoring.



**Note** For a DNS probe, the detailed probe results always identify a default DNS domain of `www.Cisco.com`.

---

**Step 3** Click **Update Details** to refresh the output for the **show probe name detail** CLI command.

**Step 4** Click **Close** to return to the Health Monitoring table.

---

#### Related Topics

- [Configuring Health Monitoring for Real Servers, page 8-51](#)

## Configuring Secure KAL-AP

You can configure a secure keepalive-appliance protocol (KAL-AP) associated with a virtual context. A KAL-AP on the ACE enables communication between the ACE and a Global Site Selector (GSS), which sends KAL-AP requests to report the server states and loads for global-server load-balancing (GSLB) decisions. The ACE uses KAL-AP through a UDP connection to calculate weights and provide information for server availability to the KAL-AP device. The ACE acts as a server and listens for KAL-AP requests. When KAL-AP is initialized on the ACE, the ACE listens on the standard 5002 port for any KAL-AP requests. You cannot configure any other port.

The ACE supports secure KAL-AP for MD5 encryption of data between it and the GSS. For encryption, you must configure a shared secret as a key for authentication between the GSS and the ACE context.

**Assumptions**

This topic assumes the following:

- You have created a virtual context that specifies the Keepalive Appliance Protocol over UDP.
- You have enabled KAL-AP on the ACE by configuring a management class map and policy map, and apply it to the appropriate interface.

**Procedure**

- 
- Step 1** Choose **Config > Devices > context > Load Balancing > Secure KAL-AP**.
- The Secure KAL-AP table appears.
- Step 2** In the Secure KAL-AP table, click **Add** to configure secure KAL-AP for MD5 encryption of data.
- The Secure KAL-AP configuration window appears.
- Step 3** In the IP Address field of the Secure KAL-AP configuration window, enable secure KAL-AP by configuring the VIP address for the GSS.
- Enter the IP address in dotted-decimal notation (for example, 192.168.11.1).
- Step 4** In the Hash Key field, enter the MD5 encryption method shared secret between the KAL-AP device and the ACE.
- Enter the shared secret as a case-sensitive string with no spaces and a maximum of 31 alphanumeric characters. The ACE supports the following special characters in a shared secret:
- , . / = + - ^ @ ! % ~ # \$ \* ( )
- Step 5** Do one of the following:
- Click **Deploy Now** to deploy this configuration on the ACE and save your entries to the running-configuration and startup-configuration files. The ACE validates the secure KAL-AP configuration and deploys it.
  - Click **Cancel** to exit this procedure without accepting your entries and to return to the Secure KAL-AP table.
  - Click **Next** to accept your entries.
- 

**Related Topics**

- [Creating Virtual Contexts, page 6-2](#)
- [Setting Match Conditions for Layer 3/Layer 4 Management Traffic Class Maps, page 14-12](#)



# CHAPTER 9

## Configuring Stickiness

---

**Date:** 3/28/12

This chapter describes how to configure stickiness on the Cisco Application Control Engine (ACE) using Cisco Application Networking Manager (ANM).



**Note**

---

When naming ACE objects (such as a real server, virtual server, parameter map, class map, health probe, and so on), enter an alphanumeric string of 1 to 64 characters, which can include the following special characters: underscore (\_), hyphen (-), dot (.), and asterisk (\*). Spaces are not allowed.

If you are using ANM with an ACE module or ACE appliance and you configure a named object at the ACE CLI, keep in mind that ANM does not support all of the special characters that the ACE CLI allows you to use when configuring a named object. If you use special characters that ANM does not support, you may not be able to import or manage the ACE using ANM.

---

This chapter includes the following sections:

- [Information About Stickiness, page 9-1](#)
- [Sticky Types, page 9-2](#)
- [Sticky Groups, page 9-6](#)
- [Sticky Table, page 9-6](#)
- [Configuring Sticky Groups, page 9-7](#)

## Information About Stickiness

When customers visit an e-commerce site, they usually start out browsing the site. The site may require that the client become “stuck” to one server once the connection is established, or once client starts to build a shopping cart.

In either case, once the client adds items to the shopping cart, it is important that all of the client requests get directed to the same server so that all the items are contained in one shopping cart on one server. An instance of a customer’s shopping cart is typically local to a particular web server and is not duplicated across multiple servers.

E-commerce applications are not the only types of applications that require stickiness. Any web application that maintains client information may require stickiness, such as banking applications or online trading. Other uses include FTP and HTTP file transfers.

Stickiness allows the same client to maintain multiple simultaneous or subsequent TCP or IP connections with the same real server for the duration of a session. A session is series of transactions between a client and a server over some finite period of time (from several minutes to several hours). This feature is particularly useful for e-commerce applications where a client needs to maintain multiple connections with the same server while shopping online, especially while building a shopping cart and during the checkout process.

Depending on the configured SLB policy, the ACE sticks a client to an appropriate server after the ACE has determined which load-balancing method to use. If the ACE determines that a client is already stuck to a particular server, then the ACE sends that client request to that server, regardless of the load-balancing criteria specified by the matched policy. If the ACE determines that the client is not stuck to a particular server, it applies the normal load-balancing rules to the content request.

For information about stickiness, see the following topics:

- [Sticky Types, page 9-2](#)
- [Sticky Groups, page 9-6](#)
- [Sticky Table, page 9-6](#)

#### Related Topics

- [Configuring Virtual Server Default Layer 7 Load Balancing, page 7-50](#)
- [Configuring Sticky Groups, page 9-7](#)

## Sticky Types

All ACE devices support stickiness based on the following:

- HTTP cookies
- HTTP headers
- IP addresses
- HTTP content
- Layer 4 payloads
- RADIUS attributes
- RTSP headers
- SIP headers

This section includes the following topics:

- [HTTP Content Stickiness, page 9-3](#)
- [HTTP Cookie Stickiness, page 9-3](#)
- [HTTP Header Stickiness, page 9-4](#)
- [IP Netmask and IPv6 Prefix Stickiness, page 9-4](#)
- [Layer 4 Payload Stickiness, page 9-4](#)
- [RADIUS Stickiness, page 9-5](#)
- [RTSP Header Stickiness, page 9-5](#)
- [SIP Header Stickiness, page 9-5](#)



## HTTP Content Stickiness

HTTP content stickiness allows you to stick a client to a server based on the content of an HTTP packet. You can specify a beginning pattern and ending pattern, the number of bytes to parse, and an offset that specifies how many bytes to ignore from the beginning of the data.

### Related Topics

- [Configuring Stickiness, page 9-1](#)
- [Sticky Types, page 9-2](#)
- [Sticky Groups, page 9-6](#)
- [Sticky Table, page 9-6](#)

## HTTP Cookie Stickiness

Client *cookies* uniquely identify clients to the ACE and the servers that provide content. A cookie is a small data structure within the HTTP header that is used by a server to deliver data to a web client and request that the client store the information. In certain applications, the client returns the information to the server to maintain the connection state or persistence between the client and the server.

When the ACE examines a request for content and determines through policy matching that the content is sticky, it examines any cookie or URL present in the content request. The ACE uses the information in the cookie or URL to direct the content request to the appropriate server.

The ACE supports the following types of cookie stickiness:

- Dynamic cookie learning

You can configure the ACE to look for a specific cookie name and automatically learn its value either from the client request HTTP header or from the server Set-Cookie message in the server response. Dynamic cookie learning is useful when dealing with applications that store more than just the session ID or user ID within the same cookie. Only very specific bytes of the cookie value are relevant to stickiness.

By default, the ACE learns the entire cookie value. You can optionally specify an offset and length to instruct the ACE to learn only a portion of the cookie value.

Alternatively, you can specify a secondary cookie value that appears in the URL string in the HTTP request. This option instructs the ACE to search for (and eventually learn or stick to) the cookie information as part of the URL. URL learning is useful with applications that insert cookie information as part of the HTTP URL. In some cases, you can use this feature to work around clients that reject cookies.

- Cookie insert

The ACE inserts the cookie on behalf of the server upon the return request, so that the ACE can perform cookie stickiness even when the servers are not configured to set cookies. The cookie contains information that the ACE uses to ensure persistence to a specific real server.

### Related Topics

- [Configuring Stickiness, page 9-1](#)
- [Sticky Types, page 9-2](#)
- [Sticky Groups, page 9-6](#)
- [Sticky Table, page 9-6](#)

## HTTP Header Stickiness

You can use HTTP-header information to provide stickiness. With HTTP header stickiness, you can specify a header offset to provide stickiness based on a unique portion of the HTTP header.

### Related Topics

- [Configuring Stickiness, page 9-1](#)
- [Sticky Types, page 9-2](#)
- [Sticky Groups, page 9-6](#)
- [Sticky Table, page 9-6](#)

## IP Netmask and IPv6 Prefix Stickiness

You can use the source IP address, the destination IP address, or both to uniquely identify individual clients and their requests for stickiness purposes based on their IP netmask or IPv6 prefix. However, if an enterprise or a service provider uses a megaproxy to establish client connections to the Internet, the source IP address no longer is a reliable indicator of the true source of the request. In this case, you can use cookies or one of the other sticky methods to ensure session persistence.



### Note

---

IPv6 requires ACE module and ACE appliance software Version A5(1.0) or later.

---

### Related Topics

- [Configuring Stickiness, page 9-1](#)
- [Sticky Types, page 9-2](#)
- [Sticky Groups, page 9-6](#)
- [Sticky Table, page 9-6](#)

## Layer 4 Payload Stickiness

Layer 4 payload stickiness allows you to stick a client to a server based on the data in Layer 4 frames. You can specify a beginning pattern and ending pattern, the number of bytes to parse, and an offset that specifies how many bytes to ignore from the beginning of the data.

### Related Topics

- [Configuring Stickiness, page 9-1](#)
- [Sticky Types, page 9-2](#)
- [Sticky Groups, page 9-6](#)
- [Sticky Table, page 9-6](#)

## RADIUS Stickiness

RADIUS stickiness can be based on the following RADIUS attributes:

- Calling Station ID
- Username

### Related Topics

- [Configuring Stickiness, page 9-1](#)
- [Sticky Types, page 9-2](#)
- [Sticky Groups, page 9-6](#)
- [Sticky Table, page 9-6](#)

## RTSP Header Stickiness

Real time streaming protocol (RTSP) stickiness is based on information in the RTSP session header. With RTSP header stickiness, you can specify a header offset to provide stickiness based on a unique portion of the RTSP header.

### Related Topics

- [Configuring Stickiness, page 9-1](#)
- [Sticky Types, page 9-2](#)
- [Sticky Groups, page 9-6](#)
- [Sticky Table, page 9-6](#)

## SIP Header Stickiness

Session initiation protocol (SIP) header stickiness is based on the SIP Call-ID header field. SIP header stickiness requires the entire SIP header, so you cannot specify an offset.

### Related Topics

- [Configuring Stickiness, page 9-1](#)
- [Sticky Types, page 9-2](#)
- [Sticky Groups, page 9-6](#)
- [Sticky Table, page 9-6](#)

# Sticky Groups

The ACE uses the concept of sticky groups to configure stickiness. A sticky group allows you to specify sticky attributes. After you configure a sticky group and its attributes, you associate the sticky group with a Layer 7 policy-map action in a Layer 7 server load balancing (SLB) policy map. You can create a maximum of 4096 sticky groups in each context. Each sticky group that you configure on the ACE contains a series of parameters that determine the following:

- Sticky method
- Timeout
- Replication
- Sticky method-specific attributes



## Note

The context in which you configure a sticky group must be associated with a resource class that allocates a portion of ACE resources to stickiness. See the [“Using Resource Classes”](#) section on page 6-43 for information about configuring ACE resources.

## Related Topics

- [Configuring Stickiness, page 9-1](#)
- [Sticky Types, page 9-2](#)
- [Sticky Table, page 9-6](#)

# Sticky Table

The ACE uses a sticky table to keep track of sticky connections. Table entries are as follows:

- Sticky groups
- Sticky methods
- Sticky connections
- Real servers

The sticky table can hold a maximum of four million entries (four million simultaneous users). When the table reaches the maximum number of entries, additional sticky connections cause the table to wrap and the first users become unstuck from their respective servers.

The ACE uses a configurable timeout mechanism to age out sticky table entries. When an entry times out, it becomes eligible for reuse. High connection rates may cause the premature aging out of sticky entries. In this case, the ACE reuses the entries that are closest to expiration first.

Sticky entries can be either dynamic (generated by the ACE on demand) or static (user-configured). When you create a static sticky entry, the ACE places the entry in the sticky table immediately. Static entries remain in the sticky database until you remove them from the configuration. You can create a maximum of 4096 static sticky entries in each context.

If the ACE takes a real server out of service for whatever reason (probe failure, no inservice command, or ARP timeout), the ACE removes from the database any sticky entries that are related to that server.

**Related Topics**

- [Configuring Stickiness, page 9-1](#)
- [Sticky Types, page 9-2](#)
- [Sticky Groups, page 9-6](#)

## Configuring Sticky Groups

You can configure sticky groups. Stickiness (or session persistence) is a feature that allows the same client to maintain multiple simultaneous or subsequent TCP connections with the same real server for the duration of a session. A session is a series of transactions between a client and a server over some finite period of time (from several minutes to several hours). This feature is particularly useful for e-commerce applications where a client needs to maintain multiple TCP connections with the same server while shopping online, especially while building a shopping cart and during the checkout process.

E-commerce applications are not the only types of applications that require stickiness. Any web application that maintains client information may require stickiness, such as banking applications or online trading. Other uses include FTP and HTTP file transfers.

The ACE uses the concept of sticky groups to configure stickiness. A sticky group allows you to specify sticky attributes. After you configure a sticky group and its attributes, you associate the sticky group with a Layer 7 policy-map action in a Layer 7 SLB policy map.

**Note**

---

(Pre ACE version A4(1.0) module or appliance only) The context in which you configure a sticky group must be associated with a resource class that allocates a portion of ACE resources to stickiness. See the [“Using Resource Classes” section on page 6-43](#) for information about configuring ACE resources.

---

**Assumption**

(Pre ACE version A4(1.0) module or appliance only) The context in which you are configuring a sticky group is associated with a resource class that allocates resources to stickiness.

**Procedure**

- 
- Step 1** Choose **Config > Devices > context > Load Balancing > Stickiness**.  
The Sticky Groups table appears.
  - Step 2** In the Sticky Groups table, click **Add** to add a new sticky group, or choose an existing sticky group that you want to modify and click **Edit**.
  - Step 3** Configure the sticky group using the information in [Table 9-1](#).

**Note**

---

Fields and information related to IPv6 require ACE module and ACE appliance software Version A5(1.0) or later.

---

Table 9-1 Sticky Group Attributes

| Field       | Description                                                                                                                                                                                                                                                                                                                                                                                                                                                                                                                                                                                                                                                                                                                                                                                                                                                                                                                                                                                                                                                                                                                                                                                                                                                                                                                                                                                                                                                                                                                                                                                                                                                                                                                                                                                                                                                                                                                                                                                                                                                                                                                                                                                                                                                                                                                                                                                                                                                                                                                                                                                                                                                                                                                                                                                                                                                                                                                                                                                                                                                                                                                  |
|-------------|------------------------------------------------------------------------------------------------------------------------------------------------------------------------------------------------------------------------------------------------------------------------------------------------------------------------------------------------------------------------------------------------------------------------------------------------------------------------------------------------------------------------------------------------------------------------------------------------------------------------------------------------------------------------------------------------------------------------------------------------------------------------------------------------------------------------------------------------------------------------------------------------------------------------------------------------------------------------------------------------------------------------------------------------------------------------------------------------------------------------------------------------------------------------------------------------------------------------------------------------------------------------------------------------------------------------------------------------------------------------------------------------------------------------------------------------------------------------------------------------------------------------------------------------------------------------------------------------------------------------------------------------------------------------------------------------------------------------------------------------------------------------------------------------------------------------------------------------------------------------------------------------------------------------------------------------------------------------------------------------------------------------------------------------------------------------------------------------------------------------------------------------------------------------------------------------------------------------------------------------------------------------------------------------------------------------------------------------------------------------------------------------------------------------------------------------------------------------------------------------------------------------------------------------------------------------------------------------------------------------------------------------------------------------------------------------------------------------------------------------------------------------------------------------------------------------------------------------------------------------------------------------------------------------------------------------------------------------------------------------------------------------------------------------------------------------------------------------------------------------------|
| Group Name  | Sticky group identifier. Valid entries are unquoted text strings with no spaces and a maximum of 64 alphanumeric characters.                                                                                                                                                                                                                                                                                                                                                                                                                                                                                                                                                                                                                                                                                                                                                                                                                                                                                                                                                                                                                                                                                                                                                                                                                                                                                                                                                                                                                                                                                                                                                                                                                                                                                                                                                                                                                                                                                                                                                                                                                                                                                                                                                                                                                                                                                                                                                                                                                                                                                                                                                                                                                                                                                                                                                                                                                                                                                                                                                                                                 |
| Type        | <p>Method to be used when establishing sticky connections and to configure any type-specific attributes. The choices are as follows:</p> <ul style="list-style-type: none"> <li>• <b>HTTP Content</b>—The ACE sticks client connections to the same real server based on a string in the data portion of the HTTP packet. See <a href="#">Table 9-2</a> for additional configuration options.</li> <li>• <b>HTTP Cookie</b>—The ACE either learns a cookie from the HTTP header of a client request or inserts a cookie in the Set-Cookie header of the response from the server to the client and then uses the learned cookie to provide stickiness between the client and server for the duration of the transaction. See <a href="#">Table 9-3</a> for additional configuration options.</li> <li>• <b>HTTP Header</b>—The ACE sticks client connections to the same real server based on HTTP headers. See <a href="#">Table 9-4</a> for additional configuration options.</li> <li>• <b>IP Netmask</b>—The ACE sticks a client to the same server for multiple subsequent connections as needed to complete a transaction using the client source IPv4 IP address, the destination IPv4 IP address, or both. You can optionally configure an IPv6 prefix length with this sticky type. IPv6 requires ACE module and ACE appliance software Version A5(1.0) or later. See <a href="#">Table 9-5</a> for additional configuration options.</li> </ul> <p><b>Note</b> If an organization uses a megaproxy to load balance client requests across multiple proxy servers when a client connects to the Internet, the source IP address is no longer a reliable indicator of the true source of the request. In this situation, you can use cookies or another sticky method to ensure session persistence.</p> <ul style="list-style-type: none"> <li>• <b>V6 Prefix</b>—(Option that appears only for ACE module and ACE appliance software Version A5(1.0) or later.) The ACE appliance sticks a client to the same server for multiple subsequent connections as needed to complete a transaction using the client source IP address, the destination IP address, or both based on their IPv6 prefix. You can optionally configure an IPv4 netmask with this sticky type. See <a href="#">Table 9-6</a> for additional configuration options.</li> <li>• <b>Layer 4 Payload</b>—The ACE sticks client connections to the same real server based on a string in the payload portion of the Layer 4 protocol packet. See <a href="#">Table 9-7</a> for additional configuration options.</li> <li>• <b>RADIUS</b>—The ACE sticks client connections to the same real server based on a RADIUS attribute. See <a href="#">Table 9-8</a> for additional configuration options.</li> <li>• <b>RTSP Header</b>—The ACE sticks client connections to the same real server based on the RTSP Session header field. See <a href="#">Table 9-9</a> for additional configuration options.</li> <li>• <b>SIP Header</b>—The ACE sticks client connections to the same real server based on the SIP Call-ID header field.</li> </ul> |
| Cookie Name | <p>This option appears for sticky type HTTP Cookie.</p> <p>Enter a unique identifier for the cookie. Valid entries are unquoted text strings with no spaces and a maximum of 64 alphanumeric characters.</p>                                                                                                                                                                                                                                                                                                                                                                                                                                                                                                                                                                                                                                                                                                                                                                                                                                                                                                                                                                                                                                                                                                                                                                                                                                                                                                                                                                                                                                                                                                                                                                                                                                                                                                                                                                                                                                                                                                                                                                                                                                                                                                                                                                                                                                                                                                                                                                                                                                                                                                                                                                                                                                                                                                                                                                                                                                                                                                                 |

**Table 9-1** *Sticky Group Attributes (continued)*

| Field              | Description                                                                                                                                                                                                                                                                                                                                                                                                                                                                                                                                                                                                                                                         |
|--------------------|---------------------------------------------------------------------------------------------------------------------------------------------------------------------------------------------------------------------------------------------------------------------------------------------------------------------------------------------------------------------------------------------------------------------------------------------------------------------------------------------------------------------------------------------------------------------------------------------------------------------------------------------------------------------|
| Enable Insert      | <p>This option appears only for sticky type HTTP Cookie.</p> <p>Check this check box if the ACE appliance is to insert a cookie in the Set-Cookie header of the response from the server to the client. This option is useful when you want to use a session cookie for persistence but the server is not currently setting the appropriate cookie. When selected, the ACE appliance selects a cookie value that identifies the original server from which the client received a response. For subsequent connections of the same transaction, the client uses the cookie to stick to the same server.</p> <p>Clear this check box to disable cookie insertion.</p> |
| Browser Expire     | <p>This option appears for sticky type HTTP Cookie and you select Enable Insert.</p> <p>Check this check box to allow the client's browser to expire a cookie when the session ends. Clear this check box to disable browser expire.</p>                                                                                                                                                                                                                                                                                                                                                                                                                            |
| Offset (Bytes)     | <p>This option appears for sticky types HTTP Cookie and HTTP Header.</p> <p>Enter the number of bytes the ACE appliance is to ignore starting with the first byte of the cookie. Valid entries are integers from 0 to 999. The default is 0 (zero), which indicates that the ACE appliance does not exclude any portion of the cookie.</p>                                                                                                                                                                                                                                                                                                                          |
| Length (Bytes)     | <p>This option appears for sticky types HTTP Cookie and HTTP Header.</p> <p>Enter the length of the portion of the cookie (starting with the byte after the offset value) that the ACE appliance is to use for sticking the client to the server. Valid entries are integers from 1 to 1000.</p>                                                                                                                                                                                                                                                                                                                                                                    |
| Secondary Name     | <p>This option appears only for sticky type HTTP Cookie.</p> <p>Enter an alternate cookie name that is to appear in the URL string of the Web page on the server. The ACE appliance uses this cookie to maintain a sticky connection between a client and a server and adds a secondary entry in the sticky table. Valid entries are unquoted text strings with no spaces and a maximum of 64 characters.</p>                                                                                                                                                                                                                                                       |
| Header Name        | <p>This option appears for sticky type HTTP Header.</p> <p>Select the HTTP header to use for sticking client connections.</p>                                                                                                                                                                                                                                                                                                                                                                                                                                                                                                                                       |
| Netmask            | <p>This option appears only for sticky type IP Netmask.</p> <p>Select the netmask to apply to the source IP address, the destination IP address, or both.</p>                                                                                                                                                                                                                                                                                                                                                                                                                                                                                                       |
| IPv4 Netmask       | <p>This option appears only for sticky type IP Netmask or IPv6 Prefix (IPv6 requires ACE module and ACE appliance software Version A5(1.0) or later). This option is mandatory for the sticky type IP Netmask and optional for the sticky type IPv6 Prefix.</p> <p>Select the netmask to apply to the source IP address, the destination IP address, or both.</p>                                                                                                                                                                                                                                                                                                   |
| IPv6 Prefix Length | <p>This option appears only for ACE module and ACE appliance software Version A5(1.0) or later and for sticky type IPv6 Prefix or IP Netmask. This option is mandatory for the sticky type IPv6 Prefix and optional for the sticky type IP Netmask.</p> <p>Enter the IPv6 prefix length to apply to the source IP address, the destination IP address, or both.</p>                                                                                                                                                                                                                                                                                                 |

Table 9-1 Sticky Group Attributes (continued)

| Field                                | Description                                                                                                                                                                                                                                                                                                                                                                                                                                                                                                                                                                                                                                                               |
|--------------------------------------|---------------------------------------------------------------------------------------------------------------------------------------------------------------------------------------------------------------------------------------------------------------------------------------------------------------------------------------------------------------------------------------------------------------------------------------------------------------------------------------------------------------------------------------------------------------------------------------------------------------------------------------------------------------------------|
| Address Type                         | <p>This option appears only for sticky type IP Netmask or IPv6 Prefix (IPv6 requires ACE module and ACE appliance software Version A5(1.0) or later).</p> <p>Indicate whether this sticky type is to be applied to the client source IP address, the destination IP address, or both:</p> <ul style="list-style-type: none"> <li>Both—Indicates that this sticky type is to be applied to both the source IP address and the destination IP address.</li> <li>Destination—Indicates that this sticky type is to be applied to the destination IP address only.</li> <li>Source—Indicates that this sticky type is to be applied to the source IP address only.</li> </ul> |
| Sticky Server Farm                   | Server farm that you want to associate with this sticky group.                                                                                                                                                                                                                                                                                                                                                                                                                                                                                                                                                                                                            |
| Backup Server Farm                   | Backup server farm that is associated with this sticky group. If the primary server farm is down, the ACE uses the backup server farm.                                                                                                                                                                                                                                                                                                                                                                                                                                                                                                                                    |
| Aggregate State                      | <p>Field that appears when a server farm and backup server farm are selected.</p> <p>Check box that indicates that the state of the backup server farm is tied to the virtual server state. Uncheck this check box if the backup server farm is not tied to the virtual server state.</p>                                                                                                                                                                                                                                                                                                                                                                                 |
| Sticky Enabled On Backup Server Farm | <p>Field that appears when a server farm and backup server farm are selected.</p> <p>Check box that indicates that the backup server farm is sticky. Uncheck this check box if the backup server farm is not sticky.</p>                                                                                                                                                                                                                                                                                                                                                                                                                                                  |
| Replicate On HA Peer                 | <p>Check box that indicates that the ACE to replicate sticky table entries on the standby ACE. If a failover occurs and this option is selected, the new active ACE can maintain the existing sticky connections.</p> <p>Uncheck this check box to indicate that the ACE is not to replicate sticky table entries on the standby ACE.</p>                                                                                                                                                                                                                                                                                                                                 |
| Timeout (Minutes)                    | Number of minutes that the ACE keeps the sticky information for a client connection in the sticky table after the latest client connection terminates. Valid entries are from 1 to 65535; the default is 1440 minutes (24 hours).                                                                                                                                                                                                                                                                                                                                                                                                                                         |
| Timeout Active Connections           | <p>Check box that specifies that the ACE is to time out sticky table entries even if active connections exist after the sticky timer expires.</p> <p>Uncheck this check box to specify that the ACE is not to time out sticky table entries even if active connections exist after the sticky timer expires. This behavior is the default.</p>                                                                                                                                                                                                                                                                                                                            |

**Step 4** Do one of the following:

- Click **Deploy Now** to deploy this configuration on the ACE and save your entries to the running-configuration and startup-configuration files. To configure sticky statics, see the [“Configuring Sticky Statics” section on page 9-15](#).
- Click **Cancel** to exit the procedure without saving your entries and to return to the Sticky Groups table.
- Click **Next** to deploy your entries and to configure another sticky group.

**Related Topics**

- [Configuring Sticky Statics, page 9-15](#)



- [Configuring Virtual Context Class Maps](#), page 14-6
- [Configuring Virtual Context Policy Maps](#), page 14-32
- [Configuring Real Servers](#), page 8-5
- [Configuring Server Farms](#), page 8-30

## Sticky Group Attribute Tables

This section describes the different sticky group type-specific attributes.



**Note**

There are no specific sticky group type-specific attributes for SIP Header.

This section includes the following topics:

- [HTTP Content Sticky Group Attributes](#), page 9-11
- [HTTP Cookie Sticky Group Attributes](#), page 9-12
- [HTTP Header Sticky Group Attributes](#), page 9-13
- [IP Netmask Sticky Group Attributes](#), page 9-13
- [V6 Prefix Sticky Group Attributes](#), page 9-13
- [Layer 4 Payload Sticky Group Attributes](#), page 9-14
- [RADIUS Sticky Group Attributes](#), page 9-14
- [RTSP Header Sticky Group Attributes](#), page 9-15

### HTTP Content Sticky Group Attributes

[Table 9-2](#) describes the HTTP content sticky group attributes.

**Table 9-2** *HTTP Content Sticky Group Attributes*

| Field          | Description                                                                                                                                                                                                                                                                                                                                                                                                 |
|----------------|-------------------------------------------------------------------------------------------------------------------------------------------------------------------------------------------------------------------------------------------------------------------------------------------------------------------------------------------------------------------------------------------------------------|
| HTTP Content   | Check box that instructs the ACE to use the constant portion of HTTP content to make persistent connections to a specific server. Uncheck the check box to identify specific content for stickiness in the Offset, Length, Begin Pattern, and End Pattern fields.<br><br>HTTP content may change over time with only a portion remaining constant throughout a transaction between the client and a server. |
| Offset         | Number of bytes that the virtual server is to ignore starting with the first byte of the cookie. Valid entries are from 0 to 999. The default is 0 (zero), which indicates that the virtual server does not exclude any portion of the cookie.                                                                                                                                                              |
| Length (Bytes) | Length of the portion of the cookie (starting with the byte after the offset value) that the ACE is to use for sticking the client to the server. Valid entries are from 1 to 1000.                                                                                                                                                                                                                         |

**Table 9-2** HTTP Content Sticky Group Attributes (continued)

| Field         | Description                                                                                                                                                                                                                                                                                                                                                                                                                                                                                                                                                                                                                                                                                                                                                                        |
|---------------|------------------------------------------------------------------------------------------------------------------------------------------------------------------------------------------------------------------------------------------------------------------------------------------------------------------------------------------------------------------------------------------------------------------------------------------------------------------------------------------------------------------------------------------------------------------------------------------------------------------------------------------------------------------------------------------------------------------------------------------------------------------------------------|
| Begin Pattern | <p>Beginning pattern of the HTTP content payload and the pattern string to match before hashing. If you do not specify a beginning pattern, the ACE begins parsing immediately after the offset byte. You cannot configure different beginning and ending patterns for different server farms that are part of the same traffic classification.</p> <p>Valid entries are unquoted text strings with no spaces and a maximum of 255 alphanumeric characters. You can enter a text string with spaces if you enclose the entire string in quotation marks (""). The ACE supports regular expressions for matching string expressions. <a href="#">Table 14-33</a> lists the supported characters that you can use for matching string expressions.</p>                               |
| End Pattern   | <p>Pattern that marks the end of hashing. If you do not specify an end pattern or a length, the ACE continues to parse the data until it reaches the end of the field or packet, or until it reaches the maximum body parse length. You cannot configure different beginning and ending patterns for different server farms that are part of the same traffic classification.</p> <p>Valid entries are unquoted text strings with no spaces and a maximum of 255 alphanumeric characters. You can enter a text string with spaces if you enclose the entire string in quotation marks (""). The ACE supports regular expressions for matching string expressions. <a href="#">Table 14-33</a> lists the supported characters that you can use for matching string expressions.</p> |

## HTTP Cookie Sticky Group Attributes

[Table 9-3](#) describes the HTTP cookie sticky group attributes.

**Table 9-3** HTTP Cookie Sticky Group Attributes

| Field          | Description                                                                                                                                                                                                                                                                                                                                                                                                                                                                                                                                                                                                    |
|----------------|----------------------------------------------------------------------------------------------------------------------------------------------------------------------------------------------------------------------------------------------------------------------------------------------------------------------------------------------------------------------------------------------------------------------------------------------------------------------------------------------------------------------------------------------------------------------------------------------------------------|
| Cookie Name    | Unique identifier for the cookie. Valid entries are unquoted text strings with no spaces and a maximum of 64 alphanumeric characters.                                                                                                                                                                                                                                                                                                                                                                                                                                                                          |
| Enable Insert  | <p>Check box that determines if the virtual server is to insert a cookie in the Set-Cookie header of the response from the server to the client. This option is useful when you want to use a session cookie for persistence but the server is not currently setting the appropriate cookie. When selected, the virtual server selects a cookie value that identifies the original server from which the client received a response. For subsequent connections of the same transaction, the client uses the cookie to stick to the same server.</p> <p>Uncheck the check box to disable cookie insertion.</p> |
| Offset         | Number of bytes that the virtual server is to ignore starting with the first byte of the cookie. Valid entries are from 0 to 999. The default is 0 (zero), which indicates that the virtual server does not exclude any portion of the cookie.                                                                                                                                                                                                                                                                                                                                                                 |
| Length (Bytes) | Length of the portion of the cookie (starting with the byte after the offset value) that the ACE is to use for sticking the client to the server. Valid entries are from 1 to 1000.                                                                                                                                                                                                                                                                                                                                                                                                                            |
| Secondary Name | Alternate cookie name that is to appear in the URL string of the web page on the server. The virtual server uses this cookie to maintain a sticky connection between a client and a server and adds a secondary entry in the sticky table. Valid entries are unquoted text strings with no spaces and a maximum of 64 characters.                                                                                                                                                                                                                                                                              |

## HTTP Header Sticky Group Attributes

Table 9-4 describes the HTTP header sticky group attributes.

**Table 9-4** HTTP Header Sticky Group Attributes

| Field          | Description                                                                                                                                                                                                                               |
|----------------|-------------------------------------------------------------------------------------------------------------------------------------------------------------------------------------------------------------------------------------------|
| Header Name    | HTTP header to use for sticking client connections.                                                                                                                                                                                       |
| Offset         | Number of bytes the virtual server is to ignore starting with the first byte of the cookie. Valid entries are from 0 to 999. The default is 0 (zero), which indicates that the virtual server does not exclude any portion of the cookie. |
| Length (Bytes) | Length of the portion of the cookie (starting with the byte after the offset value) that the ACE is to use for sticking the client to the server. Valid entries are from 1 to 1000.                                                       |

## IP Netmask Sticky Group Attributes

Table 9-5 describes the IP netmask sticky group attributes.

**Table 9-5** IP Netmask Sticky Group Attributes

| Field              | Description                                                                                                                                                                                                                                                                                                                                                                                 |
|--------------------|---------------------------------------------------------------------------------------------------------------------------------------------------------------------------------------------------------------------------------------------------------------------------------------------------------------------------------------------------------------------------------------------|
| Netmask            | Netmask to apply to the source IP address, destination IP address, or both.                                                                                                                                                                                                                                                                                                                 |
| IPv6 Prefix Length | (Optional field that requires ACE module and ACE appliance software Version A5(1.0) or later) IPv6 prefix length to apply to the source IP address, destination IP address, or both.                                                                                                                                                                                                        |
| Address Type       | Address type that the sticky type is to be applied to as follows: <ul style="list-style-type: none"> <li>• <b>Both</b>—Sticky type is applied to both the source IP address and the destination IP address.</li> <li>• <b>Destination</b>—Sticky type is applied to the destination IP address only.</li> <li>• <b>Source</b>—Sticky type applied to the source IP address only.</li> </ul> |

## V6 Prefix Sticky Group Attributes

Table 9-6 describes the V6 prefix sticky group attributes, which requires ACE module and ACE appliance software Version A5(1.0) or later.

**Table 9-6** IPv6 Prefix Sticky Group Attributes

| Field         | Description                                                                                                                                                                                                                                                                                                                                                                                 |
|---------------|---------------------------------------------------------------------------------------------------------------------------------------------------------------------------------------------------------------------------------------------------------------------------------------------------------------------------------------------------------------------------------------------|
| Prefix Length | (Field that requires ACE module and ACE appliance software Version A5(1.0) or later) IPv6 prefix length to apply to the source IP address, destination IP address, or both.                                                                                                                                                                                                                 |
| IPv4 Netmask  | (Optional) Netmask to apply to the source IP address, destination IP address, or both.                                                                                                                                                                                                                                                                                                      |
| Address Type  | Address type that the sticky type is to be applied to as follows: <ul style="list-style-type: none"> <li>• <b>Both</b>—Sticky type is applied to both the source IP address and the destination IP address.</li> <li>• <b>Destination</b>—Sticky type is applied to the destination IP address only.</li> <li>• <b>Source</b>—Sticky type applied to the source IP address only.</li> </ul> |

## Layer 4 Payload Sticky Group Attributes

Table 9-7 describes the Layer 4 payload sticky group attributes.

**Table 9-7** Layer 4 Payload Sticky Group Attributes

| Field                      | Description                                                                                                                                                                                                                                                                                                                                                                                                                                                                                                                                                                                                                                                                                                                                                                   |
|----------------------------|-------------------------------------------------------------------------------------------------------------------------------------------------------------------------------------------------------------------------------------------------------------------------------------------------------------------------------------------------------------------------------------------------------------------------------------------------------------------------------------------------------------------------------------------------------------------------------------------------------------------------------------------------------------------------------------------------------------------------------------------------------------------------------|
| Offset                     | Number of bytes the virtual server is to ignore starting with the first byte of the cookie. Valid entries are from 0 to 999. The default is 0 (zero), which indicates that the virtual server does not exclude any portion of the cookie.                                                                                                                                                                                                                                                                                                                                                                                                                                                                                                                                     |
| Length (Bytes)             | Length of the portion of the cookie (starting with the byte after the offset value) that the ACE is to use for sticking the client to the server. Valid entries are from 1 to 1000. The default is 1000.                                                                                                                                                                                                                                                                                                                                                                                                                                                                                                                                                                      |
| Begin Pattern              | <p>Beginning pattern of the Layer 4 payload and the pattern string to match before hashing. If you do not specify a beginning pattern, the ACE begins parsing immediately after the offset byte. You cannot configure different beginning and ending patterns for different server farms that are part of the same traffic classification.</p> <p>Valid entries are unquoted text strings with no spaces and a maximum of 255 alphanumeric characters. You can enter a text string with spaces provided that you enclose the entire string in quotation marks (""). The ACE supports regular expressions for matching string expressions. Table 14-33 lists the supported characters that you can use for matching string expressions.</p>                                    |
| End Pattern                | <p>Pattern that marks the end of hashing. If you do not specify an end pattern or a length, the ACE continues to parse the data until it reaches the end of the field or packet, or until it reaches the maximum body parse length. You cannot configure different beginning and ending patterns for different server farms that are part of the same traffic classification.</p> <p>Valid entries are unquoted text strings with no spaces and a maximum of 255 alphanumeric characters. You can enter a text string with spaces provided that you enclose the entire string in quotation marks (""). The ACE supports regular expressions for matching string expressions. Table 14-33 lists the supported characters that you can use for matching string expressions.</p> |
| Enable Sticky For Response | <p>Check box that enables the ACE to parse server responses and perform sticky learning. The ACE uses a hash of the server response bytes to populate the sticky database. The next time that the ACE receives a client request with those same bytes, it sticks the client to the same server.</p> <p>Uncheck the check box to reset the behavior of the ACE to the default of not parsing server responses and performing sticky learning.</p>                                                                                                                                                                                                                                                                                                                              |

## RADIUS Sticky Group Attributes

Table 9-8 describes the RADIUS sticky group attributes.

**Table 9-8** RADIUS Sticky Group Attributes

| Field        | Description                                                                                                                                                                                                                                                                                                                                                                                                                   |
|--------------|-------------------------------------------------------------------------------------------------------------------------------------------------------------------------------------------------------------------------------------------------------------------------------------------------------------------------------------------------------------------------------------------------------------------------------|
| RADIUS Types | <p>Choose the RADIUS attribute to use for sticking client connections:</p> <ul style="list-style-type: none"> <li>• <b>N/A</b>—This option is not configured.</li> <li>• <b>RADIUS Calling ID</b>—Stickiness is based on the RADIUS framed IP attribute and the calling station ID attribute.</li> <li>• <b>RADIUS User Name</b>—Stickiness is based on the RADIUS framed IP attribute and the username attribute.</li> </ul> |

## RTSP Header Sticky Group Attributes

Table 9-9 describes the RTSP header sticky group attributes.

**Table 9-9** RTSP Header Sticky Group Attributes

| Field          | Description                                                                                                                                                                                                                                    |
|----------------|------------------------------------------------------------------------------------------------------------------------------------------------------------------------------------------------------------------------------------------------|
| Offset         | Number of bytes that the virtual server is to ignore starting with the first byte of the cookie. Valid entries are from 0 to 999. The default is 0 (zero), which indicates that the virtual server does not exclude any portion of the cookie. |
| Length (Bytes) | Length of the portion of the cookie (starting with the byte after the offset value) that the ACE is to use for sticking the client to the server. Valid entries are from 1 to 1000. The default is 1000.                                       |

## Displaying All Sticky Groups by Context

You can display all sticky groups associated with a virtual context.

### Procedure

- 
- Step 1** Choose **Config > Devices**.  
The Virtual Contexts table appears.
- Step 2** In the Virtual Contexts table, choose the virtual context with the sticky groups that you want to display, and choose **Load Balancing > Stickiness**.  
The Sticky Groups table appears, listing the sticky groups associated with the selected context.
- 

### Related Topics

- [Configuring Sticky Groups, page 9-7](#)
- [Configuring Sticky Statics, page 9-15](#)

## Configuring Sticky Statics

You can configure sticky statics.



### Note

Fields and information related to IPv6 require ACE module and ACE appliance software Version A5(1.0) or later.

### Assumption

A sticky group has been configured. See the “[Configuring Sticky Groups](#)” section on page 9-7 for more information.

### Procedure

- 
- Step 1** Choose **Config > Devices > context > Load Balancing > Stickiness**.

The Sticky Groups table and Sticky Statics tab appears. If you do not see the Sticky Statics tab beneath the Sticky Groups table, click the **Switch between Configure and Browse Modes** button.

**Step 2** From the Sticky Groups table, choose the sticky group that you want to configure for sticky statics

**Step 3** From the Sticky Statics tab, click **Add** to add a new entry to the table, or select an existing entry, then click **Edit** to modify it.

The Sticky Statics configuration screen appears.

**Step 4** In the Sequence Number field, either accept the automatically incremented number for this entry or enter a new sequence number. The sequence number indicates the order in which multiple sticky static configurations are applied.

The sequence number indicates the order in which multiple sticky static configurations are applied.

**Step 5** From the Type drop-down list, choose the sticky group type.

The choices are as follows:

- **HTTP Content**—The ACE sticks client connections to the same real server based on a string in the data portion of the HTTP packet.
- **HTTP Cookie**—The ACE either learns a cookie from the HTTP header of a client request or inserts a cookie in the Set-Cookie header of the response from the server to the client, and then uses the learned cookie to provide stickiness between the client and server for the duration of the transaction.
- **HTTP Header**—The ACE sticks client connections to the same real server based on HTTP headers.
- **IP Netmask**—The ACE sticks a client to the same server for multiple subsequent connections as needed to complete a transaction using the client source IP address, the destination IP address, or both based on the IPv4 netmask. You can optionally configure an IPv6 prefix length with this sticky type.



---

**Note** If an organization uses a megaproxy to load balance client requests across multiple proxy servers when a client connects to the Internet, the source IP address is no longer a reliable indicator of the true source of the request. In this situation, you can use cookies or another sticky method to ensure session persistence.

---

- **V6 Prefix**—(Option that appears only for ACE module and ACE appliance software Version A5(1.0) or later) The ACE sticks a client to the same server for multiple subsequent connections as needed to complete a transaction using the client source IP address, the destination IP address, or both based on the IPv6 prefix length. You can optionally configure an IPv4 netmask with this sticky type.
- **Layer 4 Payload**—The ACE sticks client connections to the same real server based on a string in the payload portion of the Layer 4 protocol packet.
- **RADIUS**—The ACE sticks client connections to the same real server based on a RADIUS attribute.
- **RTSP Header**—The ACE sticks client connections to the same real server based on the RTSP Session header field.
- **SIP Header**—The ACE sticks client connections to the same real server based on the SIP Call-ID header field.

**Step 6** If you chose HTTP Cookie, HTTP, RTSP, or SIP Header for the sticky type, in the Static Value field, enter the cookie string value.

Valid entries are unquoted text strings with a maximum of 255 alphanumeric characters. If the string includes spaces, enclose the string with quotes.

- Step 7** If you chose IP Netmask or V6 Prefix for the sticky type, do the following:
- For the IP Address Type, select either IPv4 or IPv6.
  - In the Static Source field, enter the source IP address of the client.
  - In the Static Destination field, enter the destination IP address of the client.
- Step 8** In the Named Real Server field, choose the real server to associate with this static sticky entry.
- Step 9** In the Port field, enter the port number of the real server.  
Valid entries are from 1 to 65535.
- Step 10** Do one of the following:
- Click **Deploy Now** to deploy this configuration on the ACE and save your entries to the running-configuration and startup-configuration files.
  - Click **Cancel** to exit the procedure without saving your entries and to return to the Sticky Statics table.
  - Click **Next** to deploy your entries and to configure another sticky static entry.
- 

#### Related Topics

[Configuring Sticky Groups, page 9-7](#)







# CHAPTER 10

## Configuring Parameter Maps

---

**Date:** 3/28/12

This chapter describes how to configure parameter maps on the Cisco Application Control Engine (ACE) using Cisco Application Networking Manager (ANM).



**Note**

---

When naming ACE objects (such as a real server, virtual server, parameter map, class map, health probe, and so on), enter an alphanumeric string of 1 to 64 characters, which can include the following special characters: underscore (\_), hyphen (-), dot (.), and asterisk (\*). Spaces are not allowed.

If you are using ANM with an ACE module or ACE appliance and you configure a named object at the ACE CLI, keep in mind that ANM does not support all of the special characters that the ACE CLI allows you to use when configuring a named object. If you use special characters that ANM does not support, you may not be able to import or manage the ACE using ANM.

---

This chapter includes the following sections:

- [Information About Parameter Maps, page 10-1](#)
- [Configuring Connection Parameter Maps, page 10-3](#)
- [Configuring Generic Parameter Maps, page 10-8](#)
- [Configuring HTTP Parameter Maps, page 10-9](#)
- [Configuring Optimization Parameter Maps, page 10-12](#)
- [Configuring RTSP Parameter Maps, page 10-20](#)
- [Configuring SIP Parameter Maps, page 10-21](#)
- [Configuring Skinny Parameter Maps, page 10-23](#)
- [Configuring DNS Parameter Maps, page 10-25](#)
- [Supported MIME Types, page 10-26](#)

## Information About Parameter Maps

Parameter maps allow you to perform actions on traffic that ingresses an ACE interface based on certain criteria, such as protocol or connection attributes. After you configure a parameter map, you associate it with a policy map to implement configured behavior. [Table 10-1](#) describes the parameter maps that you can configure using ANM and the ACE devices that support them.

**Table 10-1** Parameter Map Types and ACE Support

| Parameter Map | Description                                                                                                                                                                                                                                              | ACE Device |               |
|---------------|----------------------------------------------------------------------------------------------------------------------------------------------------------------------------------------------------------------------------------------------------------|------------|---------------|
|               |                                                                                                                                                                                                                                                          | ACE Module | ACE Appliance |
| Connection    | Connection parameter maps combine all IP and TCP connection-related behaviors pertaining to: <ul style="list-style-type: none"> <li>TCP normalization, termination, and server reuse</li> <li>IP normalization, fragmentation, and reassembly</li> </ul> | X          | X             |
| Generic       | Generic parameter maps combine related generic protocol actions for server load-balancing connections.                                                                                                                                                   | X          | X             |
| HTTP          | HTTP parameter maps configure ACE behavior for HTTP load-balanced connections.                                                                                                                                                                           | X          | X             |
| Optimization  | Optimization parameter maps specify optimization-related commands that pertain to application acceleration and optimization functions performed by the ACE.                                                                                              |            | X             |
| RTSP          | Real Time Streaming Protocol (RTSP) parameter maps configure advanced RTSP behavior for server load-balancing connections.                                                                                                                               | X          | X             |
| SIP           | Session Initiation Protocol (SIP) parameter maps configure SIP deep packet inspection on the ACE.                                                                                                                                                        | X          | X             |
| Skinny        | Skinny Client Control Protocol (SCCP) parameter maps configure SCCP packet inspection on the ACE.                                                                                                                                                        | X          | X             |
| DNS           | Domain Name System (DNS) parameter maps configure DNS actions for DNS packet inspection.                                                                                                                                                                 | X          | X             |

**Related Topics**

- [Configuring Connection Parameter Maps, page 10-3](#)
- [Configuring Generic Parameter Maps, page 10-8](#)
- [Configuring HTTP Parameter Maps, page 10-9](#)
- [Configuring Optimization Parameter Maps, page 10-12](#)
- [Configuring RTSP Parameter Maps, page 10-20](#)
- [Configuring SIP Parameter Maps, page 10-21](#)
- [Configuring Skinny Parameter Maps, page 10-23](#)
- [Configuring Generic Parameter Maps, page 10-8](#)
- [Configuring Traffic Policies, page 14-1](#)
- [Configuring Parameter Maps, page 10-1](#)
- [Configuring Virtual Contexts, page 6-8](#)

# Configuring Connection Parameter Maps

You can configure a connection parameter map for use with a Layer 3/Layer 4 policy map. Connection parameter maps combine all IP and TCP connection-related behaviors pertaining to the following:

- TCP normalization, termination, and server reuse
- IP normalization, fragmentation, and reassembly

## Procedure

**Step 1** Choose **Config > Devices > context > Load Balancing > Parameter Maps > Connection Parameter Maps**.

The Connection Parameter Maps table appears.

**Step 2** In the Connection Parameter Maps table, click **Add** to add a new parameter map, or choose an existing parameter map and click **Edit** to modify it.

The Connection Parameter Maps configuration window appears.

**Step 3** In the Connection Parameter Maps configuration window, configure the parameter map using the information in [Table 10-2](#).

Click **More Settings** to access the additional Connection Parameter Map configuration attributes. By default, ANM hides the default Connection Parameter Map configuration attributes and the attributes that are not commonly used.

**Table 10-2** Connection Parameter Map Attributes

| Field                        | Description                                                                                                                                                                                                                                                                                                                                                                                                                                                                                                                                    |
|------------------------------|------------------------------------------------------------------------------------------------------------------------------------------------------------------------------------------------------------------------------------------------------------------------------------------------------------------------------------------------------------------------------------------------------------------------------------------------------------------------------------------------------------------------------------------------|
| Parameter Name               | Unique name for the parameter map. Valid entries are unquoted text strings with no spaces and a maximum of 64 alphanumeric characters.                                                                                                                                                                                                                                                                                                                                                                                                         |
| Description                  | Field that appears for ACE module A2(1.5), ACE appliance A3(2.3), and later releases of either device type. If you attempt to use the Description feature with an ACE that is running an earlier software version, ANM displays an invalid command detected error message and does not deploy the parameter map.<br><br>Brief description of the parameter map. Enter a text string with a maximum of 240 alphanumeric characters (A–Z, a–z, 0–9). Spaces and special characters are allowed. Double quotes must be entered as matching pairs. |
| Inactivity Timeout (Seconds) | Number of seconds that the ACE is to wait before disconnecting idle connections. Valid entries are from 0 to 3217203. A value of 0 indicates that the ACE is never to time out a TCP connection.                                                                                                                                                                                                                                                                                                                                               |

Table 10-2 Connection Parameter Map Attributes (continued)

| Field                         | Description                                                                                                                                                                                                                                                                                                                                                                                                                                                                                                                                                                                                                                                                                  |
|-------------------------------|----------------------------------------------------------------------------------------------------------------------------------------------------------------------------------------------------------------------------------------------------------------------------------------------------------------------------------------------------------------------------------------------------------------------------------------------------------------------------------------------------------------------------------------------------------------------------------------------------------------------------------------------------------------------------------------------|
| <b>More Settings</b>          |                                                                                                                                                                                                                                                                                                                                                                                                                                                                                                                                                                                                                                                                                              |
| Exceeds MSS                   | Action that the ACE takes to handle segments that exceed the maximum segment size (MSS): <ul style="list-style-type: none"> <li>• <b>Allow</b>—The ACE is to permit segments that exceed the configured MSS.</li> <li>• <b>Drop</b>—The ACE is to discard segments that exceed the configured MSS.</li> </ul>                                                                                                                                                                                                                                                                                                                                                                                |
| Max. Connection Limit         | Maximum number of concurrent connections to allow for the parameter map. Valid entries are from 0 to 4000000.                                                                                                                                                                                                                                                                                                                                                                                                                                                                                                                                                                                |
| Nagle                         | Check box that enables the Nagle algorithm, which instructs a sender to buffer any data to be sent until all outstanding data has been acknowledged or until there is a full segment of data to send. Enabling the Nagle algorithm increases throughput, but it can increase latency in your TCP connection.<br><br>Uncheck the check box to disable the Nagle algorithm.<br><br><b>Note</b> Disable the Nagle algorithm when you observe unacceptable delays in TCP connections.                                                                                                                                                                                                            |
| Random Sequence Number        | Check box that enables the use of random TCP sequence numbers, which adds a measure of security to TCP connections by making it more difficult for a hacker to guess or predict the next sequence number in a TCP connection.<br><br>Uncheck the check box to disable the use of random TCP sequence numbers.<br><br>This option is enabled by default.                                                                                                                                                                                                                                                                                                                                      |
| Bandwidth Rate Limit          | Option that appears for ACE modules only. Enter the bandwidth-rate limit in bytes per second for the parameter map. Valid entries are from 0 to 300000000 bytes.                                                                                                                                                                                                                                                                                                                                                                                                                                                                                                                             |
| Connection Rate Limit         | Connection-rate limit in connections per second. Valid entries are from 0 to 350000.                                                                                                                                                                                                                                                                                                                                                                                                                                                                                                                                                                                                         |
| Reserved Bits                 | Action that the ACE takes to handle segments with the reserved bits set in the TCP header: <ul style="list-style-type: none"> <li>• <b>Allow</b>—Segments with the reserved bits are to be permitted.</li> <li>• <b>Drop</b>—Segments with the reserved bits are to be discarded.</li> <li>• <b>Clear</b>—Reserved bits in TCP headers are to be cleared and segments are to be allowed.</li> </ul>                                                                                                                                                                                                                                                                                          |
| Type-of-Service IP Header     | Type of service for an IP packet that determines how the network handles the packet and balances its precedence, throughput, delay, reliability, and cost.<br><br>Enter the type-of-service value to be applied to IP packets. Valid entries are from 0 to 255.<br><br>For more information about type of service, refer to RFCs 791, 1122, 1349, and 3168.                                                                                                                                                                                                                                                                                                                                  |
| ACK Delay Time (Milliseconds) | Number of milliseconds that the ACE is to wait before sending an acknowledgement from a client to a server. Valid entries are from 0 to 400.                                                                                                                                                                                                                                                                                                                                                                                                                                                                                                                                                 |
| TCP Buffer Share (Bytes)      | Option that appears for only ACE modules. To improve throughput and overall performance, the ACE buffers the number of bytes you specify before processing received data or transmitting data. Use this option to increase the default buffer size and thereby realize improved network performance.<br><br>Enter the maximum size of the TCP buffer in bytes. Valid entries are from 8192 to 262143 bytes. Default is 32768.<br><br><b>Note</b> If you enter a value in this field for an ACE device that does not support this option, an error message appears. Leave this field blank when creating or modifying a connection parameter map for devices that do not support this option. |

Table 10-2 Connection Parameter Map Attributes (continued)

| Field                                       | Description                                                                                                                                                                                                                                                                                                                                                                                                                                                                                                                                                                                                                                                                                                                                                                                                                                                                                                                                                                                                                               |
|---------------------------------------------|-------------------------------------------------------------------------------------------------------------------------------------------------------------------------------------------------------------------------------------------------------------------------------------------------------------------------------------------------------------------------------------------------------------------------------------------------------------------------------------------------------------------------------------------------------------------------------------------------------------------------------------------------------------------------------------------------------------------------------------------------------------------------------------------------------------------------------------------------------------------------------------------------------------------------------------------------------------------------------------------------------------------------------------------|
| Smallest TCP MSS (Bytes)                    | Size of the smallest segment of TCP data that the ACE is to accept. Valid entries are from 0 to 65535 bytes. The value 0 indicates that the ACE is not to set a minimum limit.                                                                                                                                                                                                                                                                                                                                                                                                                                                                                                                                                                                                                                                                                                                                                                                                                                                            |
| Largest TCP MSS (Bytes)                     | Size of the largest segment of TCP data that the ACE is to accept. Valid entries are from 0 to 65535 bytes. The value 0 indicates that the ACE is not to set a maximum limit.                                                                                                                                                                                                                                                                                                                                                                                                                                                                                                                                                                                                                                                                                                                                                                                                                                                             |
| SYN Retries                                 | Number of attempts that the ACE is to make to transmit a TCP segment when initiating a Layer 7 connection. Valid entries are from 1 to 15. The default is 4.                                                                                                                                                                                                                                                                                                                                                                                                                                                                                                                                                                                                                                                                                                                                                                                                                                                                              |
| TCP WAN Optimization RTT                    | <p>Option that specifies how the ACE is to apply TCP optimizations to packets on a connection associated with a Layer 7 policy map using a round-trip time (RTT) value.</p> <p>The choices are as follows:</p> <ul style="list-style-type: none"> <li>An entry of 0 (zero) indicates that the ACE is to apply TCP optimizations to packets for the life of a connection.</li> <li>An entry of 65535 (the default) indicates that the ACE is to perform normal operations (that is, without optimizations) for the life of a connection.</li> <li>Entries from 1 to 65534 indicate that the ACE is to use the following guidelines: <ul style="list-style-type: none"> <li>If the actual client RTT is less than the configured RTT, the ACE performs normal operations for the life of the connection.</li> <li>If the actual client RTT is greater than or equal to the configured RTT, the ACE performs TCP optimizations on the packets for the life of a connection.</li> </ul> </li> </ul> <p>Valid entries are from 0 to 65535.</p> |
| Timeout For Embryonic Connections (Seconds) | <p>Number of seconds that the ACE is to wait before timing out an embryonic connection, which is a TCP three-way handshake for a connection that does not complete for some reason.</p> <p>Valid entries are from 0 to 4294967295. The default is 5. A value of 0 indicates that the ACE is never to time out an embryonic connection.</p>                                                                                                                                                                                                                                                                                                                                                                                                                                                                                                                                                                                                                                                                                                |
| Half Closed Timeout (Seconds)               | <p>Number of seconds the ACE is to wait before closing a half-closed connection, which is one in which the client or server sends a FIN and the server or client acknowledges the FIN without sending a FIN itself.</p> <p>Valid entries are from 0 to 4294967295. The default is 3600 (1 hour). A value of 0 indicates that the ACE is never to time out a half-closed connection.</p>                                                                                                                                                                                                                                                                                                                                                                                                                                                                                                                                                                                                                                                   |
| Slow Start Algorithm                        | <p>Check box that enables the slow start algorithm. When enabled, the slow start algorithm increases TCP window size as ACK handshakes arrive so that new segments are injected into the network at the rate at which acknowledgements are returned by the host at the other end of the connection.</p> <p>Uncheck the check box to disable the slow start algorithm. This option is disabled by default.</p>                                                                                                                                                                                                                                                                                                                                                                                                                                                                                                                                                                                                                             |
| SYN Segments With Data                      | <p>Action that the ACE takes to handle TCP SYN segments that contain data:</p> <ul style="list-style-type: none"> <li><b>Allow</b>—The ACE is to permit SYN segments that contain data and mark them for processing.</li> <li><b>Drop</b>—The ACE is to discard SYN segments that contain data.</li> </ul>                                                                                                                                                                                                                                                                                                                                                                                                                                                                                                                                                                                                                                                                                                                                |

Table 10-2 Connection Parameter Map Attributes (continued)

| Field                        | Description                                                                                                                                                                                                                                                                                                                                                                                                                                                                                                                                                                              |
|------------------------------|------------------------------------------------------------------------------------------------------------------------------------------------------------------------------------------------------------------------------------------------------------------------------------------------------------------------------------------------------------------------------------------------------------------------------------------------------------------------------------------------------------------------------------------------------------------------------------------|
| Urgent Pointer Policy        | <p>Action that the ACE takes to handle urgent data as identified by the Urgent data control bit. Urgent data, as indicated by a control bit in the TCP header, indicates that urgent data is to be processed as soon as possible, even before normal data.</p> <p>The choices are as follows:</p> <ul style="list-style-type: none"> <li>• <b>Allow</b>—The ACE is to permit the status of the Urgent control bit.</li> <li>• <b>Clear</b>—The ACE is to set the Urgent control bit to 0 (zero) and thereby invalidate the Urgent Pointer which provides segment information.</li> </ul> |
| TCP Window Scale Factor      | <p>TCP window scale factor. The TCP window scaling extension expands the definition of the TCP window to 32 bits and uses a scale factor to carry the 32-bit value in the 16-bit window of the TCP header. Increasing the window size improves TCP performance in network paths with large bandwidth, long-delay characteristics.</p> <p>Valid entries are from 0 to 14 (the maximum scale factor).</p> <p>For more information on TCP window scaling, refer to RFC 1323.</p>                                                                                                            |
| Action For TCP Options Range | <p>Action that the ACE takes to handle the following TCP options:</p> <ul style="list-style-type: none"> <li>• Selective ACK</li> <li>• Timestamps</li> <li>• Action For TCP Window Scale Factor</li> </ul> <p>The choices are as follows:</p> <ul style="list-style-type: none"> <li>• <b>N/A</b>—This option is not set.</li> <li>• <b>Allow</b>—The ACE is to allow any segment with the specified option set.</li> <li>• <b>Drop</b>—The ACE is to discard any segment with the specified option set.</li> </ul>                                                                     |
| Lower TCP Options            | <p>Option that appears if you chose Allow or Drop for the Action For TCP Options Range.</p> <p>Enter the lower limit of the TCP option range. Valid entries are 6, 7, or a value from 9 to 255. See <a href="#">Table 10-3</a> for information on TCP options.</p>                                                                                                                                                                                                                                                                                                                       |
| Upper TCP Options            | <p>Option that appears if you chose Allow or Drop for the Action For TCP Options Range.</p> <p>Enter the upper limit of the TCP option range. Valid entries are 6, 7, or a value from 9 to 255. See <a href="#">Table 10-3</a> for information on TCP options.</p>                                                                                                                                                                                                                                                                                                                       |
| Selective ACK                | <p>Action that the ACE takes to handle the selective ACK option that is specified in SYN segments:</p> <ul style="list-style-type: none"> <li>• <b>Allow</b>—The ACE allows any segment with the specified option set.</li> <li>• <b>Clear</b>—The ACE clears the specified option from any segment that has it set and allow the segment.</li> </ul>                                                                                                                                                                                                                                    |

**Table 10-2** Connection Parameter Map Attributes (continued)

| Field                              | Description                                                                                                                                                                                                                                                                                                                                                                                                                                 |
|------------------------------------|---------------------------------------------------------------------------------------------------------------------------------------------------------------------------------------------------------------------------------------------------------------------------------------------------------------------------------------------------------------------------------------------------------------------------------------------|
| Timestamps                         | Action that the ACE takes to handle the time stamp option that is specified in SYN segments: <ul style="list-style-type: none"> <li>• <b>Allow</b>—The ACE allows any segment with the specified option set.</li> <li>• <b>Clear</b>—The ACE clears the specified option from any segment that has it set and allow the segment.</li> </ul>                                                                                                 |
| Action For TCP Window Scale Factor | Action that the ACE takes to handle the TCP window scale factor option that is specified in SYN segments: <ul style="list-style-type: none"> <li>• <b>Allow</b>—The ACE allows any segment with the specified option set.</li> <li>• <b>Clear</b>—The ACE clears the specified option from any segment that has it set and allow the segment.</li> <li>• <b>Drop</b>—The ACE discards any segment with the specified option set.</li> </ul> |

Table 10-3 lists the TCP options for connection parameter maps.

**Table 10-3** TCP Options for Connection Parameter Maps<sup>1</sup>

| Type | Length | Meaning                                     |
|------|--------|---------------------------------------------|
| 6    | 6      | Echo (obsoleted by option 8)                |
| 7    | 6      | Echo Reply (obsoleted by option 8)          |
| 9    | 2      | Partial Order Connection Permitted          |
| 10   | 3      | Partial Order Service Profile               |
| 11   |        | CC                                          |
| 12   |        | CC.NEW                                      |
| 13   |        | CC.ECHO                                     |
| 14   | 3      | TCP Alternate Checksum Request              |
| 15   | N      | TCP Alternate Checksum Data                 |
| 16   |        | Skeeter                                     |
| 17   |        | Bubba                                       |
| 18   | 3      | Trailer Checksum Option                     |
| 19   | 18     | MD5 Signature Option                        |
| 20   |        | SCPS Capabilities                           |
| 21   |        | Selective Negative Acknowledgements (SNACK) |
| 22   |        | Record Boundaries                           |
| 23   |        | Corruption Experienced                      |
| 24   |        | SNAP                                        |
| 25   |        | Unassigned (released 12/18/2000)            |
| 26   |        | TCP Compression Filter                      |

1. For more information about TCP options, see the *Cisco 4700 Series Application Control Engine Appliance Security Configuration Guide*.

**Step 4** Do one of the following:

- Click **Deploy Now** to deploy this configuration on the ACE and save your entries to the running-configuration and startup-configuration files.
- Click **Cancel** to exit this procedure without accepting your entries and to return to the Parameter Map table.
- Click **Next** to accept your entries and to add another parameter map.

#### Related Topics

- [Configuring Parameter Maps, page 10-1](#)
- [Configuring Traffic Policies, page 14-1](#)
- [Configuring Virtual Contexts, page 6-8](#)

## Configuring Generic Parameter Maps

You configure a generic parameter map, which allows you to specify nonprotocol-specific behavior for data parsing. Generic parameter maps examine the payload and make decisions regardless of the protocol.

#### Procedure

**Step 1** Choose **Config > Devices > context > Load Balancing > Parameter Maps > Generic Parameter Maps**.

The Generic Parameter Maps table appears.

**Step 2** In the Generic Parameter Maps table, click **Add** to add a new parameter map, or choose an existing parameter map and click **Edit** to modify it.

The Parameter Maps configuration window appears.

**Step 3** In the Parameter Maps configuration window, configure the parameter map using the information in [Table 10-4](#).

**Table 10-4** Generic Parameter Map Attributes

| Field          | Description                                                                                                                                                                                                                                                                                                                                                                                                                                                                                                                                    |
|----------------|------------------------------------------------------------------------------------------------------------------------------------------------------------------------------------------------------------------------------------------------------------------------------------------------------------------------------------------------------------------------------------------------------------------------------------------------------------------------------------------------------------------------------------------------|
| Parameter Name | Unique name for the parameter map. Valid entries are unquoted text strings with no spaces and a maximum of 64 alphanumeric characters.                                                                                                                                                                                                                                                                                                                                                                                                         |
| Description    | Field that appears for ACE module A2(1.5), ACE appliance A3(2.3), and later releases of either device type. If you attempt to use the Description feature with an ACE that is running an earlier software version, ANM displays an invalid command detected error message and does not deploy the parameter map.<br><br>Brief description of the parameter map. Enter a text string with a maximum of 240 alphanumeric characters (A–Z, a–z, 0–9). Spaces and special characters are allowed. Double quotes must be entered as matching pairs. |



**Table 10-4** Generic Parameter Map Attributes (continued)

| Field                     | Description                                                                                                                                                            |
|---------------------------|------------------------------------------------------------------------------------------------------------------------------------------------------------------------|
| Case-Insensitive          | Check box that instructs the ACE to be case insensitive for the parameter map. Uncheck this check box to instruct the ACE to be case sensitive for this parameter map. |
| Max. Parse Length (Bytes) | Number of bytes to parse for the total length of all generic headers. Valid entries are from 1 to 65535. The default is 2048 bytes.                                    |

**Step 4** Do one of the following:

- Click **Deploy Now** to deploy this configuration on the ACE and save your entries to the running-configuration and startup-configuration files.
- Click **Cancel** to exit this procedure without saving your entries and to return to the Generic Parameter Maps table.
- Click **Next** to deploy your entries and to configure another generic parameter map.

#### Related Topics

- [Configuring Parameter Maps, page 10-1](#)
- [Configuring Traffic Policies, page 14-1](#)
- [Configuring Parameter Maps, page 10-1](#)
- [Configuring Virtual Contexts, page 6-8](#)

## Configuring HTTP Parameter Maps

You can configure an HTTP parameter map for use with a Layer 3/Layer 4 policy map. HTTP parameter maps allow you to configure ACE behavior for HTTP load-balanced connections.

#### Procedure

- Step 1** Choose **Config > Devices > context > Load Balancing > Parameter Maps > HTTP Parameter Maps**. The HTTP Parameter Maps table appears.
- Step 2** In the HTTP Parameter Maps table, click **Add** to add a new parameter map, or choose an existing parameter map and click **Edit** to modify it. The HTTP Parameter Maps configuration window appears.
- Step 3** In the HTTP Parameter Maps configuration window, configure the parameter map using the information in [Table 10-5](#).

Table 10-5 HTTP Parameter Map Attributes

| Field                             | Description                                                                                                                                                                                                                                                                                                                                                                                                                                                                                                                                                                                                                                                                                                                                                   |
|-----------------------------------|---------------------------------------------------------------------------------------------------------------------------------------------------------------------------------------------------------------------------------------------------------------------------------------------------------------------------------------------------------------------------------------------------------------------------------------------------------------------------------------------------------------------------------------------------------------------------------------------------------------------------------------------------------------------------------------------------------------------------------------------------------------|
| Parameter Name                    | Unique name for the parameter map. Valid entries are unquoted text strings with no spaces and a maximum of 64 alphanumeric characters.                                                                                                                                                                                                                                                                                                                                                                                                                                                                                                                                                                                                                        |
| Description                       | Field that appears for ACE module A2(1.5), ACE appliance A3(2.3), and later releases of either device type. If you attempt to use the Description feature with an ACE that is running an earlier software version, ANM displays an invalid command detected error message and does not deploy the parameter map.<br><br>Brief description of the parameter map. Enter a text string with a maximum of 240 alphanumeric characters (A–Z, a–z, 0–9). Spaces and special characters are allowed. Double quotes must be entered as matching pairs.                                                                                                                                                                                                                |
| Case-Insensitive                  | Check box that instructs the ACE to be case insensitive. Uncheck this check box to indicate that the ACE is to be case sensitive. This check box is cleared by default.                                                                                                                                                                                                                                                                                                                                                                                                                                                                                                                                                                                       |
| Header Modify Per-Request         | Check box to require that SSL information is inserted for every HTTP GET request. Current functionality only requires that the information be inserted at the first GET request.                                                                                                                                                                                                                                                                                                                                                                                                                                                                                                                                                                              |
| Exceed Max. Parse Length          | Action that the ACE takes to handle cookies, HTTP headers, and URLs that exceed the maximum parse length. The choices are as follows: <ul style="list-style-type: none"> <li>• <b>Continue</b>—The ACE is to continue load balancing. When this option is selected, the HTTP Persistence Rebalance option is disabled if the total length of all cookies, HTTP headers, and URLs exceeds the maximum parse value.</li> <li>• <b>Drop</b>—The ACE is to stop load balancing and to discard the packet.</li> </ul>                                                                                                                                                                                                                                              |
| HTTP Persistence Rebalance        | Check box that instructs the ACE to do the following: <ul style="list-style-type: none"> <li>• Separately load balance each subsequent HTTP request on the same TCP connection.</li> <li>• Insert the header and cookie for every request instead of only the first request.</li> </ul> Uncheck this check box to indicate that this option is disabled.<br><br>This option is enabled by default.                                                                                                                                                                                                                                                                                                                                                            |
| TCP Server Connection Reuse       | Check box that instructs the ACE to reduce the number of open connections on a server by allowing connections to persist and be reused by multiple client connections. If you enable this feature, perform the following tasks: <ul style="list-style-type: none"> <li>• Ensure that the ACE maximum segment size (MSS) is the same as the server maximum segment size.</li> <li>• Configure port address translation (PAT) on the interface that is connected to the real server.</li> <li>• Configure on the ACE the same TCP options that exist on the TCP server.</li> <li>• Ensure that each server farm is homogeneous (all real servers within a server farm have identical configurations).</li> </ul> Uncheck this check box to disable this option. |
| Content Max. Parse Length (Bytes) | Maximum number of bytes to parse in HTTP content. Valid entries are from 1 to 65535. The default is 4096.                                                                                                                                                                                                                                                                                                                                                                                                                                                                                                                                                                                                                                                     |
| Header Max. Parse Length (Bytes)  | Maximum number of bytes to parse for the total length of cookies, HTTP headers, and URLs. Valid entries are from 1 to 65535. The default is 4096.                                                                                                                                                                                                                                                                                                                                                                                                                                                                                                                                                                                                             |

Table 10-5 HTTP Parameter Map Attributes (continued)

| Field                         | Description                                                                                                                                                                                                                                                                                                                                                                                                                                                                                                                                                                                                                                                                                                                                                                                                                                                                                                                                                                                              |
|-------------------------------|----------------------------------------------------------------------------------------------------------------------------------------------------------------------------------------------------------------------------------------------------------------------------------------------------------------------------------------------------------------------------------------------------------------------------------------------------------------------------------------------------------------------------------------------------------------------------------------------------------------------------------------------------------------------------------------------------------------------------------------------------------------------------------------------------------------------------------------------------------------------------------------------------------------------------------------------------------------------------------------------------------|
| Secondary Cookie Delimiters   | ASCII-character delimiters to be used to separate cookies in a URL string. Valid entries are unquoted text strings with no spaces and a maximum of 4 characters. The default delimiters are /&#+.                                                                                                                                                                                                                                                                                                                                                                                                                                                                                                                                                                                                                                                                                                                                                                                                        |
| MIME Type To Compress         | <p>Option that appears only for ACE appliances (all versions) and ACE modules version A4(1.0) and later. In the field on the left, enter the Multipurpose Internet Mail Extension (MIME) type to compress, and click <b>Add</b>. The MIME type appears in the column on the right. To remove or change a MIME type, choose it in the column on the right, and click <b>Remove</b>. The selected MIME type appears in the field on the left where you can modify or delete it.</p> <p>To specify the sequence in which compression is to be applied, choose MIME types in the column on the right, and click <b>Up</b> or <b>Down</b> to arrange the MIME types.</p> <p>The “Supported MIME Types” section on page 10-26 lists the supported MIME types. You can use an asterisk (*) to indicate a wildcard, such as text/*, which would include all text MIME types (text/html, text/plain, and so on).</p>                                                                                              |
| User Agent Not To Compress    | <p>Option that appears only for ACE appliances (all versions) and ACE modules version A4(1.0) and later. A user agent is a client that initiates a request. Examples of user agents include browsers, editors, and other end-user tools. When you specify a user agent string in this field, the ACE does not compress the response to a request when the request contains the matching user agent string.</p> <p>In the field on the left, enter the user agent string to be matched, and click <b>Add</b>. The string appears in the column on the right. To remove or change a user agent string, choose it in the column on the right, and click <b>Remove</b>. The selected string appears in the field on the left where you can modify or delete it.</p> <p>To specify the sequence in which strings are to be matched, choose strings in the column on the right, and click <b>Up</b> or <b>Down</b> to arrange the strings in the desired sequence.</p> <p>Valid entries are 64 characters.</p> |
| Min. Size To Compress (Bytes) | Option that appears only for ACE appliances (all versions) and ACE modules version A4(1.0) and later. Enter the threshold at which compression is to occur. The ACE compresses files that are the minimum size or larger. Valid entries are from 1 to 4096 bytes.                                                                                                                                                                                                                                                                                                                                                                                                                                                                                                                                                                                                                                                                                                                                        |

**Step 4** Do one of the following:

- Click **Deploy Now** to deploy this configuration on the ACE and save your entries to the running-configuration and startup-configuration files.
- Click **Cancel** to exit this procedure without accepting your entries and to return to the Parameter Map table.
- Click **Next** to accept your entries and to add another parameter map.

**Related Topics**

- [Configuring Parameter Maps, page 10-1](#)
- [Configuring Traffic Policies, page 14-1](#)
- [Configuring Parameter Maps, page 10-1](#)

- [Configuring Virtual Contexts, page 6-8](#)

## Configuring Optimization Parameter Maps



### Note

Optimization parameter maps are available for ACE appliances only.

You can configure an optimization parameter map for use with a Layer 3/Layer 4 policy map. Optimization parameter maps specify optimization-related commands that pertain to application acceleration and optimization functions performed by the ACE.

See the “[Configuring Application Acceleration and Optimization](#)” section on page 15-1 or the *Cisco 4700 Series Application Control Engine Appliance Application Acceleration and Optimization Configuration Guide* for more information about application acceleration and optimization.

### Procedure

- Step 1** Choose **Config > Devices > context > Load Balancing > Parameter Maps > Optimization Parameter Maps**.
- The Optimization Parameter Maps table appears.
- Step 2** In the Optimization Parameter Maps table, click **Add** to add a new parameter map, or choose an existing parameter map and click **Edit** to modify it.
- The Optimization Parameter Maps configuration window appears.
- Step 3** In the Optimization Parameter Maps configuration window, configure the parameter map using the information in [Table 10-6](#).

**Table 10-6 Optimization Parameter Map Attributes**

| Field                        | Description                                                                                                                                                                                                                                                                                                                                                                                                                                                                                                                                                |
|------------------------------|------------------------------------------------------------------------------------------------------------------------------------------------------------------------------------------------------------------------------------------------------------------------------------------------------------------------------------------------------------------------------------------------------------------------------------------------------------------------------------------------------------------------------------------------------------|
| Parameter Name               | Unique name for the parameter map. Valid entries are unquoted text strings with no spaces and a maximum of 64 alphanumeric characters.                                                                                                                                                                                                                                                                                                                                                                                                                     |
| Description                  | Field that appears for ACE module A2(1.5), ACE appliance A3(2.3), and later releases of either device type. If you attempt to use the Description feature with an ACE that is running an earlier software version, ANM displays an invalid command detected error message and does not deploy the parameter map.<br><br>Brief description of the parameter map. Enter a text string with a maximum of 240 alphanumeric characters (A–Z, a–z, 0–9). Spaces and special characters are allowed. Double quotes must be entered as matching pairs.             |
| Set Browser Freshness Period | Method that the ACE uses to determine the freshness of objects in the client’s browser: <ul style="list-style-type: none"> <li>• <b>N/A</b>—This option is not configured.</li> <li>• <b>Disable Browser Object Freshness Control</b>—Browser freshness control is not used.</li> <li>• <b>Set Freshness Similar To Flash Forward Objects</b>—The ACE sets freshness similar to that used for FlashForwarded objects and to use the values specified in the Maximum Time for Cache Time-To-Live and Minimum Time for Cache Time-To-Live fields.</li> </ul> |

Table 10-6 Optimization Parameter Map Attributes (continued)

| Field                                           | Description                                                                                                                                                                                                                                                                                                                                                                                                                                                                                                                                                                                                                                                                                                                                  |
|-------------------------------------------------|----------------------------------------------------------------------------------------------------------------------------------------------------------------------------------------------------------------------------------------------------------------------------------------------------------------------------------------------------------------------------------------------------------------------------------------------------------------------------------------------------------------------------------------------------------------------------------------------------------------------------------------------------------------------------------------------------------------------------------------------|
| Duration For Browser Freshness (Seconds)        | Field that appears if the Set Browser Freshness Period option is not configured.<br>Enter the number of seconds that objects in the client's browser are considered fresh. Valid entries are 0 to 2147483647 seconds.                                                                                                                                                                                                                                                                                                                                                                                                                                                                                                                        |
| Response Codes To Ignore (Comma Separated)      | Comma-separated list of HTTP response codes for which the response body must not be read. For example, an entry of 302 indicates that the ACE is to ignore the response body of a 302 (redirect) response from the origin server. Valid entries are unquoted text strings with a maximum of 64 alphanumeric characters from 100 to 599, inclusive.                                                                                                                                                                                                                                                                                                                                                                                           |
| Appscope Optimize Rate (%)                      | Percentage of all requests or sessions to be sampled for performance with acceleration (or optimization) applied. All applicable optimizations for the class will be performed. Valid entries are from 0 to 100 percent. The default is 10 percent. The sum of this value and the value entered in the Passthru Rate Percent field must not exceed 100.                                                                                                                                                                                                                                                                                                                                                                                      |
| Appscope Passthrough Rate (%)                   | Percentage of all requests or sessions to be sampled for performance without optimization. No optimizations for the class will be performed. Valid entries are from 0 to 100. The default is 10 percent. The sum of this value and the value entered in the Optimize Rate Percent field must not exceed 100.                                                                                                                                                                                                                                                                                                                                                                                                                                 |
| Max. Number for Parameter Summary Log (Bytes)   | Maximum number of bytes that are to be logged for each parameter value in the parameter summary of a transaction log entry in the statistics log. If a parameter value exceeds this limit, it is truncated at the specified limit. Valid entries are from 0 to 10,000 bytes.                                                                                                                                                                                                                                                                                                                                                                                                                                                                 |
| Max. For Post Data to Scan for Logging (KBytes) | Maximum number of kilobytes of POST data that the ACE is to scan for parameters for the purpose of logging transaction parameters in the statistics log.<br>Valid entries are from 0 to 1000 KB.                                                                                                                                                                                                                                                                                                                                                                                                                                                                                                                                             |
| String For Grouping Requests                    | String that the ACE uses to sort requests for AppScope reporting. The string can contain a URL regular expression that defines a set of URLs in which URLs that differ only by their query parameters are to be treated as separate URLs in AppScope reports.<br><br>For example, to define a string that is used to identify the URLs <code>http://server/catalog.asp?region=asia</code> and <code>http://server/catalog.asp?region=america</code> as two separate reporting categories, you would enter <b><code>http_query_param(region)</code></b> .<br><br>Valid entries are from 1 to 255 characters and can contain the parameter expander functions listed in <a href="#">Table 10-7</a> .                                           |
| Base File Anonymous Level                       | Base file anonymous level. Information that is common to a large set of users is generally not confidential or user-specific. Conversely, information that is unique to a specific user or a small set of users is generally confidential or user-specific. The anonymous base file feature enables the ACE to create and deliver condensed base files that contain only information that is common to a large set of users. No information unique to a particular user, or across a very small subset of users, is included in anonymous base files.<br><br>Enter the value for base file anonymity for the all-user condensation method. Valid entries are from 0 to 50. The default is 0, which disables the base file anonymity feature. |

**Table 10-6 Optimization Parameter Map Attributes (continued)**

| Field                                          | Description                                                                                                                                                                                                                                                                                                                                                                                                                                                                                                                                                                                                                                                                                                                                                                                                                                                                                                |
|------------------------------------------------|------------------------------------------------------------------------------------------------------------------------------------------------------------------------------------------------------------------------------------------------------------------------------------------------------------------------------------------------------------------------------------------------------------------------------------------------------------------------------------------------------------------------------------------------------------------------------------------------------------------------------------------------------------------------------------------------------------------------------------------------------------------------------------------------------------------------------------------------------------------------------------------------------------|
| Cache-Key Modifier Expression                  | <p>Cache key modifier expression. A cache object key is a unique identifier that is used to identify a cached object to be served to a client, replacing a trip to the origin server. The cache key modifier feature allows you to modify the canonical form of a URL; that is, the portion before “?” in a URL. For example, the canonical URL of <code>http://www.xyz.com/somepage.asp?action=browse&amp;level=2</code> is <code>http://www.xyz.com/somepage.asp</code>.</p> <p>Enter a regular expression containing embedded variables as described in <a href="#">Table 10-7</a>. The ACE transforms URLs specified in class maps for this virtual server with the expression and variable entered here.</p> <p>Valid entries are unquoted text strings with no spaces and a maximum of 255 alphanumeric characters. If the string includes spaces, enclose the string with quotation marks (“”).</p> |
| Min. Time For Cache Time-To-Live (Seconds)     | <p>Minimum number of seconds that an object without an explicit expiration time should be considered fresh in the ACE cache. This value specifies the minimum time that content can be cached. If the ACE is configured for FlashForward optimization, this value should normally be 0. If the ACE is configured for dynamic caching, this value should indicate how long the ACE should cache the page. (See <a href="#">Table 7-17</a> for information about these configuration options.)</p> <p>Valid entries are from 0 to 2147483647 seconds.</p>                                                                                                                                                                                                                                                                                                                                                    |
| Max. Time For Cache Time-To-Live (Seconds)     | <p>Maximum number of seconds that an object without an explicit expiration time should be considered fresh in the ACE cache. Valid entries are from 0 to 2147483647 seconds.</p>                                                                                                                                                                                                                                                                                                                                                                                                                                                                                                                                                                                                                                                                                                                           |
| Cache Time-To-Live Duration (%)                | <p>Percentage of an object’s age at which an embedded object without an explicit expiration time is considered fresh.</p> <p>Valid entries are from 0 to 100 percent.</p>                                                                                                                                                                                                                                                                                                                                                                                                                                                                                                                                                                                                                                                                                                                                  |
| Expression To Modify Cache Key Query Parameter | <p>Regular expression that contains embedded variables as described in <a href="#">Table 10-7</a>. The ACE transforms URLs specified in class maps for this virtual server with the expression and variable entered here.</p> <p>The cache parameter feature allows you to modify the query parameter of a URL; that is, the portion after “?” in a URL. For example, the query parameter portion of <code>http://www.xyz.com/somepage.asp?action=browse&amp;level=2</code> is <code>action=browse&amp;level=2</code>.</p> <p>If no string is specified, the query parameter portion of the URL is used as the default value for this portion of the cache key.</p> <p>Valid entries are unquoted text strings with no spaces and a maximum of 255 alphanumeric characters.</p>                                                                                                                            |
| Canonical URL Expressions (Comma Separated)    | <p>Comma-separated list of parameter expander functions as defined in <a href="#">Table 10-7</a> to identify the URLs to associate with this parameter map. The ACE uses the canonical URL feature to eliminate the “?” and any characters that follow to identify the general part of the URL. This general URL is then used to create the base file. In this way, the ACE maps multiple URLs to a single canonical URL.</p> <p>Valid entries are unquoted text strings with a maximum of 255 alphanumeric characters.</p>                                                                                                                                                                                                                                                                                                                                                                                |
| Enable Cacheable Content Optimization          | <p>Check box that enables delta optimization of content that can be cached. This feature allows the ACE to detect content that can be cached and perform delta optimization on it.</p> <p>Uncheck the check box to disable this feature.</p>                                                                                                                                                                                                                                                                                                                                                                                                                                                                                                                                                                                                                                                               |

Table 10-6 Optimization Parameter Map Attributes (continued)

| Field                                                | Description                                                                                                                                                                                                                                                                                                                                                                                                                                                                                                                                                                                                                       |
|------------------------------------------------------|-----------------------------------------------------------------------------------------------------------------------------------------------------------------------------------------------------------------------------------------------------------------------------------------------------------------------------------------------------------------------------------------------------------------------------------------------------------------------------------------------------------------------------------------------------------------------------------------------------------------------------------|
| Enable Delta Optimization On First Visit To Web Page | Check box that enables condensation on the first visit to a web page. Uncheck the check box to disable this feature.                                                                                                                                                                                                                                                                                                                                                                                                                                                                                                              |
| Min. Page Size For Delta Optimization (Bytes)        | Minimum page size, in bytes, that can be condensed. Valid entries are from 1 to 250000 bytes.                                                                                                                                                                                                                                                                                                                                                                                                                                                                                                                                     |
| Max. Page Size For Delta Optimization (Bytes)        | Maximum page size, in bytes, that can be condensed. Valid entries are from 1 to 250000 bytes.                                                                                                                                                                                                                                                                                                                                                                                                                                                                                                                                     |
| Set Default Client Script                            | Scripting language that the ACE recognizes on condensed content pages: <ul style="list-style-type: none"> <li>• <b>N/A</b>—This option is not configured.</li> <li>• <b>Javascript</b>—The default scripting language is JavaScript.</li> <li>• <b>Visual Basic Script</b>—The default scripting language is Visual Basic.</li> </ul>                                                                                                                                                                                                                                                                                             |
| Exclude Iframes From Delta Optimization              | Check box that specifies that delta optimization is not to be applied to IFrames (inline frames). Uncheck the check box to indicate that delta optimization is to be applied to IFrames.                                                                                                                                                                                                                                                                                                                                                                                                                                          |
| Exclude Non-ASCII Data From Delta Optimization       | Check box that specifies that delta optimization is not to be applied to non-ASCII data. Uncheck the check box to indicate that delta optimization is to be applied to non-ASCII data.                                                                                                                                                                                                                                                                                                                                                                                                                                            |
| Exclude JavaScripts From Delta Optimization          | Check box that specifies that delta optimization is not to be applied to JavaScript. Clear the check box to indicate that delta optimization is to be applied to JavaScript.                                                                                                                                                                                                                                                                                                                                                                                                                                                      |
| MIME Types To Exclude From Delta Optimization        | Mime types to exclude from delta optimization.<br>Do the following: <ol style="list-style-type: none"> <li>1. In the first field, enter a comma-separated list of the MIME (Multipurpose Internet Mail Extension) type messages that are not to have delta optimization applied, such as image/Jpeg, text/html, application/msword, or audio/mpeg. See the <a href="#">“Supported MIME Types”</a> section on page 10-26 for a list of supported MIME types.</li> <li>2. Click <b>Add</b> to add the entry to the list box on the right. You can position the entries in the list box by using the Up and Down buttons.</li> </ol> |
| Remove HTML META Elements From Documents             | Check box that specifies that HTML META elements are to be removed from documents to prevent them from being condensed. Uncheck the check box to indicate that HTML META elements are not to be removed from documents.                                                                                                                                                                                                                                                                                                                                                                                                           |
| Set Flash Forward Refresh Policy                     | Method the ACE is to use to refresh stale embedded objects: <ul style="list-style-type: none"> <li>• <b>N/A</b>—This option is not configured.</li> <li>• <b>Allow Flash Forward To Indirect Refresh Of Objects</b>—The ACE uses FlashForward to indirectly refresh embedded objects.</li> <li>• <b>Bypass Flash Forward To Direct Refresh Of Objects</b>—The ACE bypasses FlashForward for stale embedded objects so that they are refreshed directly.</li> </ul>                                                                                                                                                                |
| Rebase Delta Optimization Threshold (%)              | Delta threshold, expressed as a percent, when rebasing is to be triggered. This entry represents the size of a page delta relative to total page size, expressed as a percent. This entry triggers rebasing when the delta response size exceeds the threshold as a percentage of base file size.<br>Valid entries are from 0 to 10000 percent.                                                                                                                                                                                                                                                                                   |

Table 10-6 Optimization Parameter Map Attributes (continued)

| Field                                   | Description                                                                                                                                                                                                                                                                                                                                                                                                                                                                                                                                                                                                                            |
|-----------------------------------------|----------------------------------------------------------------------------------------------------------------------------------------------------------------------------------------------------------------------------------------------------------------------------------------------------------------------------------------------------------------------------------------------------------------------------------------------------------------------------------------------------------------------------------------------------------------------------------------------------------------------------------------|
| Rebase Flash Forward Threshold (%)      | <p>Threshold, expressed as a percent, when rebasing is to be triggered based on the percent of FlashForwarded URLs in the response. This entry triggers rebasing when the difference between the percentages of FlashForwarded URLs in the delta response and the base file exceeds the threshold.</p> <p>Valid entries are from 0 to 10000 percent.</p>                                                                                                                                                                                                                                                                               |
| Rebase History Size (Pages)             | <p>Number of pages to be stored before the ACE resets all rebase control parameters to zero and starts over. This option prevents the base file from becoming too rigid.</p> <p>Valid entries are from 10 to 2147483647.</p>                                                                                                                                                                                                                                                                                                                                                                                                           |
| Rebase Modify Cool-Off Period (Seconds) | <p>Number of seconds after the last modification before performing a rebase.</p> <p>Valid entries are from 1 to 14400 seconds (4 hours).</p>                                                                                                                                                                                                                                                                                                                                                                                                                                                                                           |
| Rebase Reset Period (Seconds)           | <p>Period of time, in seconds, for performing a meta data refresh.</p> <p>Valid entries are from 1 to 900 seconds (15 minutes).</p>                                                                                                                                                                                                                                                                                                                                                                                                                                                                                                    |
| Override Client Request Headers         | <p>Action that the ACE takes to handle client request headers (primarily for embedded objects):</p> <ul style="list-style-type: none"> <li>• <b>N/A</b>—This feature is not enabled.</li> <li>• <b>All Cache Request Headers Are Ignored</b>—The ACE ignores all cache request headers.</li> <li>• <b>Overrides The Cache Control: No Cache HTTP Header From A Request</b>—The ACE ignores cache control request headers that state <i>no cache</i>.</li> </ul>                                                                                                                                                                        |
| Override Server Response Headers        | <p>Action that the ACE takes to handle origin server response headers (primarily for embedded objects):</p> <ul style="list-style-type: none"> <li>• <b>N/A</b>—This feature is not enabled.</li> <li>• <b>All Cache Request Headers Are Ignored</b>—The ACE ignores all response headers.</li> <li>• <b>Overrides The Cache Control: Private HTTP Header From A Response</b>—The ACE ignores cache control response headers that state <i>private</i>.</li> </ul>                                                                                                                                                                     |
| UTF-8 Character Set Threshold           | <p>UTF-8 (8-bit Unicode Transformation Format) character set, which is an international standard that allows Web pages to display non-ASCII or non-English multibyte characters. It can represent any universal character in the Unicode standard and is backwards compatible with ASCII.</p> <p>Enter the number of UTF-8 characters that need to appear on a page to constitute a UTF-8 character set page. Valid entries are from 1 to 1,000,000.</p>                                                                                                                                                                               |
| Server Load Threshold Trigger (%)       | <p>Server load threshold trigger that indicates that the time-to-live (TTL) period for cached objects is to be based dynamically on server load. With this method, TTL periods increase if the current response time from the origin sever is greater than the average response time and decrease if the current response time from the origin server is less than the average response time when the difference in response times exceeds a specified threshold amount.</p> <p>Enter the threshold, expressed as a percent, at which the TTL for cached objects is to be changed.</p> <p>Valid entries are from 0 to 100 percent.</p> |



**Table 10-6** Optimization Parameter Map Attributes (continued)

| Field                                    | Description                                                                                                                                                                                                                                                                                                                                                                                                                                                                                                                                                                                                                                                                                                                                                                                                                                                                                                                                                                                                                                            |
|------------------------------------------|--------------------------------------------------------------------------------------------------------------------------------------------------------------------------------------------------------------------------------------------------------------------------------------------------------------------------------------------------------------------------------------------------------------------------------------------------------------------------------------------------------------------------------------------------------------------------------------------------------------------------------------------------------------------------------------------------------------------------------------------------------------------------------------------------------------------------------------------------------------------------------------------------------------------------------------------------------------------------------------------------------------------------------------------------------|
| Server Load Time-To-Live Change (%)      | <p>Option that specifies the percentage by which the cache TTL is increased or decreased in response to a change in server load. For example, if this value is set to 20 and the current TTL for a response is 300 seconds, and if the current server response times exceeds the trigger threshold, the cache TTL for the response is raised to 360 seconds.</p> <p>Enter the percent by which the cache TTL is to be increased or decreased when the server load threshold trigger is met.</p> <p>Valid entries are from 0 to 100 percent.</p>                                                                                                                                                                                                                                                                                                                                                                                                                                                                                                        |
| Delta Optimization Mode                  | <p>Method by which delta optimization is to be implemented.</p> <p>The choices are as follows:</p> <ul style="list-style-type: none"> <li>• <b>N/A</b>—This option is not configured.</li> <li>• <b>Enable The All-User Mode For Delta Optimization</b>—The ACE is to generate the delta against a single base file that is shared by all users of the URL. This option is usable in most cases if the structure of a page is common across all users, and the disk space overhead is minimal.</li> <li>• <b>Enable The Per-User Mode For Delta Optimization</b>—The ACE is to generate the delta against a base file that is created specifically for that user. This option is useful when page contents, including layout elements, are different for each user, and delivers the highest level of condensation. However, this increases disk space requirements because a copy of the base page that is delivered to each user is cached. This option is useful when privacy is required because base pages are not shared among users.</li> </ul> |
| String To Be Used For Server HTTP Header | <p>Option that defines a string that is to be sent in the server header for an HTTP response. This option provides you with a method for uniquely tagging the context or URL match statement by setting the server header value to a particular string. The server header string can be used when a particular URL is not being transmitted to the correct target context or match statement.</p> <p>Enter the string that is to appear in the server header. Valid entries are quoted text strings with a maximum of 64 alphanumeric characters.</p>                                                                                                                                                                                                                                                                                                                                                                                                                                                                                                  |

Table 10-7 lists the parameter expander functions that you can use.

Table 10-7 Parameter Expander Functions

| Variable                                                                                                                                  | Description                                                                                                                                                                                                                                                                                                                                                                                                                                                                                                                                                                                                                                                                                                                                                                                                                                                                                                                                                                              |
|-------------------------------------------------------------------------------------------------------------------------------------------|------------------------------------------------------------------------------------------------------------------------------------------------------------------------------------------------------------------------------------------------------------------------------------------------------------------------------------------------------------------------------------------------------------------------------------------------------------------------------------------------------------------------------------------------------------------------------------------------------------------------------------------------------------------------------------------------------------------------------------------------------------------------------------------------------------------------------------------------------------------------------------------------------------------------------------------------------------------------------------------|
| <code>\$(number)</code>                                                                                                                   | <p>Expands to the corresponding matching subexpression (by <i>number</i>) in the URL pattern. Subexpressions are marked in a URL pattern using parentheses (). The numbering of the subexpressions begins with 1 and is the number of the left-parenthesis “(“ counting from the left. You can specify any positive integer for the number. <code>\$(0)</code> matches the entire URL. For example, if the URL pattern is <code>((http://server/.*)/(.*)/a.jsp)</code>, and the URL that matches it is <code>http://server/main/sub/a.jsp?category=shoes&amp;session=99999</code>, then the following are correct:</p> <p><code>\$(0)</code> = <code>http://server/main/sub/a.jsp</code><br/> <code>\$(1)</code> = <code>http://server/main/sub/</code><br/> <code>\$(2)</code> = <code>http://server/main</code><br/> <code>\$(3)</code> = <code>sub</code></p> <p>If the specified subexpression does not exist in the URL pattern, then the variable expands to the empty string.</p> |
| <code>\$http_query_string()</code>                                                                                                        | <p>Expands to the value of the whole query string in the URL. For example, if the URL is <code>http://myhost/dothis?param1=value1&amp;param2=value2</code>, then the following is correct:</p> <p><code>\$http_query_string()</code> = <code>param1=value1&amp;param2=value2</code></p> <p>This function applies to both GET and POST requests.</p>                                                                                                                                                                                                                                                                                                                                                                                                                                                                                                                                                                                                                                      |
| <code>\$http_query_param(query-param-name)</code><br><br>The obsolete syntax is also supported:<br><code>\$param(query-param-name)</code> | <p>Expands to the value of the named query parameter (case sensitive). For example, if the URL is <code>http://server/main/sub/a.jsp?category=shoes&amp;session=99999</code>, then the following are correct:</p> <p><code>\$http_query_param(category)</code> = <code>shoes</code><br/> <code>\$http_query_param(session)</code> = <code>99999</code></p> <p>If the specified parameter does not exist in the query, then the variable expands to the empty string. This function applies to both GET and POST requests.</p>                                                                                                                                                                                                                                                                                                                                                                                                                                                            |
| <code>\$http_cookie(cookie-name)</code>                                                                                                   | <p>Evaluates to the value of the named cookie. For example, <code>\$http_cookie(cookiexyz)</code>. The cookie name is case sensitive.</p>                                                                                                                                                                                                                                                                                                                                                                                                                                                                                                                                                                                                                                                                                                                                                                                                                                                |
| <code>\$http_header(request-header-name)</code>                                                                                           | <p>Evaluates to the value of the specified HTTP request header. In the case of multivalued headers, it is the single representation as specified in the HTTP specification. For example, <code>\$http_header(user-agent)</code>. The HTTP header name is not case sensitive.</p>                                                                                                                                                                                                                                                                                                                                                                                                                                                                                                                                                                                                                                                                                                         |
| <code>\$http_method()</code>                                                                                                              | <p>Evaluates to the HTTP method used for the request, such as GET or POST.</p>                                                                                                                                                                                                                                                                                                                                                                                                                                                                                                                                                                                                                                                                                                                                                                                                                                                                                                           |

**Table 10-7** Parameter Expander Functions (continued)

| Variable                                                                                                                                                                                                                                                                                                                                                                                                                                                   | Description                                                                                                                                                                                                                                                                                                                                                                                                                                                                         |
|------------------------------------------------------------------------------------------------------------------------------------------------------------------------------------------------------------------------------------------------------------------------------------------------------------------------------------------------------------------------------------------------------------------------------------------------------------|-------------------------------------------------------------------------------------------------------------------------------------------------------------------------------------------------------------------------------------------------------------------------------------------------------------------------------------------------------------------------------------------------------------------------------------------------------------------------------------|
| Boolean Functions:<br>\$http_query_param_present( <i>query-param-name</i> )<br>\$http_query_param_notpresent( <i>query-param-name</i> )<br>\$http_cookie_present( <i>cookie-name</i> )<br>\$http_cookie_notpresent( <i>cookie-name</i> )<br>\$http_header_present( <i>request-header-name</i> )<br>\$http_header_notpresent( <i>request-header-name</i> )<br>\$http_method_present( <i>method-name</i> )<br>\$http_method_notpresent( <i>method-name</i> ) | Evaluates to a Boolean value: True or False, depending on the presence or absence of the element in the request. The elements are a specific query parameter ( <i>query-param-name</i> ), a specific cookie ( <i>cookie-name</i> ), a specific request header ( <i>request-header-name</i> ), or a specific HTTP method ( <i>method-name</i> ). All identifiers are case sensitive except for the HTTP request header name.                                                         |
| \$regex_match( <i>param1</i> , <i>param2</i> )                                                                                                                                                                                                                                                                                                                                                                                                             | Evaluates to a Boolean value: True if the two parameters match and False if they do not match. The two parameters can be any two expressions, including regular expressions, that evaluate to two strings. For example, this function:<br><pre>\$regex_match(\$http_query_param(URL), .*Store\.asp.*)</pre> compares the query URL with the regular expression string <code>.*Store\.asp.*</code> .<br>If the URL matches this regular expression, this function evaluates to True. |

**Step 4** Do one of the following:

- Click **Deploy Now** to deploy this configuration on the ACE and save your entries to the running-configuration and startup-configuration files. The ACE validates the parameter map configuration and deploys it.
- Click **Cancel** to exit this procedure without accepting your entries and to return to the Parameter Map table.
- Click **Next** to accept your entries and to add another parameter map.

**Related Topics**

- [Configuring Parameter Maps, page 10-1](#)
- [Configuring Traffic Policies, page 14-1](#)
- [Configuring Parameter Maps, page 10-1](#)
- [Configuring Virtual Contexts, page 6-8](#)

# Configuring RTSP Parameter Maps

You can configure a Real Time Streaming protocol (RTSP) parameter map, which allows you to configure advanced RTSP behavior for server load-balancing connections.

## Procedure

- 
- Step 1** Choose **Config > Devices > context > Load Balancing > Parameter Maps > RTSP Parameter Maps**.  
The RTSP Parameter Maps table appears.
- Step 2** In the RTSP Parameter Maps table, click **Add** to add a new parameter map, or choose an existing parameter map and click **Edit** to modify it.  
The Parameter Maps configuration window appears.
- Step 3** In the Parameter Maps configuration window, configure the parameter map using the information in [Table 10-8](#).

**Table 10-8** RTSP Parameter Map Attributes

| Field                            | Description                                                                                                                                                                                                                                                                                                                                                                                                                                                                                                                                    |
|----------------------------------|------------------------------------------------------------------------------------------------------------------------------------------------------------------------------------------------------------------------------------------------------------------------------------------------------------------------------------------------------------------------------------------------------------------------------------------------------------------------------------------------------------------------------------------------|
| Parameter Name                   | Unique name for the parameter map. Valid entries are unquoted text strings with no spaces and a maximum of 64 alphanumeric characters.                                                                                                                                                                                                                                                                                                                                                                                                         |
| Description                      | Field that appears for ACE module A2(1.5), ACE appliance A3(2.3), and later releases of either device type. If you attempt to use the Description feature with an ACE that is running an earlier software version, ANM displays an invalid command detected error message and does not deploy the parameter map.<br><br>Brief description of the parameter map. Enter a text string with a maximum of 240 alphanumeric characters (A–Z, a–z, 0–9). Spaces and special characters are allowed. Double quotes must be entered as matching pairs. |
| Case-Insensitive                 | Check box that instructs the ACE to be case insensitive. Uncheck the check box to instruct the ACE is to be case sensitive.                                                                                                                                                                                                                                                                                                                                                                                                                    |
| Header Max. Parse Length (Bytes) | Number of bytes to parse for the total length of RTSP headers. Valid entries are from 1 to 65535. The default is 2048 bytes.                                                                                                                                                                                                                                                                                                                                                                                                                   |

- Step 4** Do one of the following:
- Click **Deploy Now** to deploy this configuration on the ACE and save your entries to the running-configuration and startup-configuration files.
  - Click **Cancel** to exit this procedure without saving your entries and to return to the RTSP Parameter Maps table.
  - Click **Next** to deploy your entries and to configure another RTSP parameter map.
- 

## Related Topics

- [Configuring Parameter Maps, page 10-1](#)
- [Configuring Traffic Policies, page 14-1](#)
- [Configuring Parameter Maps, page 10-1](#)

- [Configuring Virtual Contexts, page 6-8](#)

## Configuring SIP Parameter Maps

You can configure Session Initiation Protocol (SIP) parameter maps, which allow you to configure SIP deep-packet inspection policy maps on the ACE.

### Procedure

- 
- Step 1** Choose **Config > Devices > context > Load Balancing > Parameter Maps > SIP Parameter Maps**.  
The SIP Parameter Maps table appears.
- Step 2** In the SIP Parameter Maps table, click **Add** to add a new parameter map, or choose an existing parameter map and click **Edit** to modify it.  
The Parameter Maps configuration window appears.
- Step 3** In the Parameter Maps configuration window, configure the parameter map using the information in [Table 10-9](#).

**Table 10-9** SIP Parameter Map Attributes

| Field             | Description                                                                                                                                                                                                                                                                                                                                                                                                                                                                                                                                                 |
|-------------------|-------------------------------------------------------------------------------------------------------------------------------------------------------------------------------------------------------------------------------------------------------------------------------------------------------------------------------------------------------------------------------------------------------------------------------------------------------------------------------------------------------------------------------------------------------------|
| Parameter Name    | Unique name for the parameter map. Valid entries are unquoted text strings with no spaces and a maximum of 64 alphanumeric characters.                                                                                                                                                                                                                                                                                                                                                                                                                      |
| Description       | Field that appears for ACE module A2(1.5), ACE appliance A3(2.3), and later releases of either device type. If you attempt to use the Description feature with an ACE that is running an earlier software version, ANM displays an invalid command detected error message and does not deploy the parameter map.<br><br>Brief description of the parameter map. Enter a text string with a maximum of 240 alphanumeric characters (A–Z, a–z, 0–9). Spaces and special characters are allowed. Double quotes must be entered as matching pairs.              |
| Instant Messaging | Check box that enables instant messaging (IM) over SIP after it has been disabled.<br><br>Uncheck this check box to disable this feature.                                                                                                                                                                                                                                                                                                                                                                                                                   |
| Logging All       | Check box that appears only for ACE module and ACE appliance software Version A4(1.0) or later. Check this check box to enable logging of all received and transmitted SIP packets in the system log (syslog) in addition to the dropped packets, which by default are logged.<br><br>The ACE allows all headers sent in the SIP packet, including proprietary headers. In the event of a failover for SIP sessions over UDP, the ACE continues to process SIP packets for established SIP sessions.<br><br>Uncheck this check box to disable this feature. |

Table 10-9 SIP Parameter Map Attributes (continued)

| Field                             | Description                                                                                                                                                                                                                                                                                                                                                                                                                                                                                                                                                                                                                                                                                                                                                                                                                                                                                                                                                              |
|-----------------------------------|--------------------------------------------------------------------------------------------------------------------------------------------------------------------------------------------------------------------------------------------------------------------------------------------------------------------------------------------------------------------------------------------------------------------------------------------------------------------------------------------------------------------------------------------------------------------------------------------------------------------------------------------------------------------------------------------------------------------------------------------------------------------------------------------------------------------------------------------------------------------------------------------------------------------------------------------------------------------------|
| Max. Forward Validation           | <p>Option that allows you to configure the ACE to validate the value of the Max-Forward header field.</p> <p>Specify how the ACE is to handle the validation of Max-Forward header fields. The choices are as follows:</p> <ul style="list-style-type: none"> <li>• <b>N/A</b>—The ACE is not to validate Max-Forward header fields.</li> <li>• <b>Drop</b>—The ACE is to drop the SIP message if it does not pass Max-Forward header validation.</li> <li>• <b>Deny</b>—The ACE is to reset the SIP connection if it does not pass Max-Forward header validation.</li> </ul>                                                                                                                                                                                                                                                                                                                                                                                            |
| Log Max. Forward Validation Event | <p>Check box that instructs the ACE to log Max-Forward validation events.</p> <p>Uncheck the check box to disable this feature.</p>                                                                                                                                                                                                                                                                                                                                                                                                                                                                                                                                                                                                                                                                                                                                                                                                                                      |
| Mask UA Software Version          | <p>Check box that instructs the ACE to mask the user agent software version. If the software version of a user agent is exposed, that user agent might be vulnerable to attacks from hackers who exploit the security holes present in that particular software version. This option allows you to mask or log the user agent software version so that it is not exposed.</p> <p>Uncheck the check box to disable this feature.</p>                                                                                                                                                                                                                                                                                                                                                                                                                                                                                                                                      |
| Log UA Software Version           | <p>Check box that instructs the ACE to log the user agent software version.</p> <p>Uncheck the check box to disable this feature.</p>                                                                                                                                                                                                                                                                                                                                                                                                                                                                                                                                                                                                                                                                                                                                                                                                                                    |
| Strict Header Validation          | <p>Action that the ACE is to take to handle header validation. You can ensure the validity of SIP packet headers by configuring the ACE to check for the presence of the following mandatory SIP header fields:</p> <ul style="list-style-type: none"> <li>• From</li> <li>• To</li> <li>• Call-ID</li> <li>• CSeq</li> <li>• Via</li> <li>• Max-Forwards</li> </ul> <p>If one of the header fields is missing in a SIP packet, the ACE considers that packet invalid. The ACE also checks for forbidden header fields, according to RFC 3261.</p> <p>Specify how the ACE is to handle header validation. The choices are as follows:</p> <ul style="list-style-type: none"> <li>• <b>N/A</b>—The ACE does not to perform header validation.</li> <li>• <b>Drop</b>—The ACE drops the SIP message if the SIP packet does not pass header validation.</li> <li>• <b>Reset</b>—The ACE resets the connection if the SIP packet does not pass header validation.</li> </ul> |
| Log Strict Header Validation      | <p>Check box that instructs the ACE to log header validation events.</p> <p>Uncheck the check box to disable this feature.</p>                                                                                                                                                                                                                                                                                                                                                                                                                                                                                                                                                                                                                                                                                                                                                                                                                                           |
| Mask Non SIP URI                  | <p>Check box that instructs the ACE to mask non-SIP URIs in SIP messages. This option and the next enable the detection of non-SIP URIs in SIP messages.</p> <p>Uncheck the check box to disable this feature.</p>                                                                                                                                                                                                                                                                                                                                                                                                                                                                                                                                                                                                                                                                                                                                                       |

Table 10-9 SIP Parameter Map Attributes (continued)

| Field                               | Description                                                                                                                             |
|-------------------------------------|-----------------------------------------------------------------------------------------------------------------------------------------|
| Log Non SIP URI                     | Check box that instructs the ACE to log non-SIP URIs in SIP messages.<br>Uncheck the check box to disable this feature.                 |
| SIP Media Pinhole Timeout (Seconds) | Timeout period for SIP media pinhole (secure port) connections in seconds. Valid entries are from 1 to 65535 seconds. The default is 5. |

**Step 4** Do one of the following:

- Click **Deploy Now** to deploy this configuration on the ACE and save your entries to the running-configuration and startup-configuration files.
- Click **Cancel** to exit this procedure without saving your entries and to return to the SIP Parameter Maps table.
- Click **Next** to deploy your entries and to configure another SIP parameter map.

#### Related Topics

- [Configuring Parameter Maps, page 10-1](#)
- [Configuring Traffic Policies, page 14-1](#)
- [Configuring Parameter Maps, page 10-1](#)
- [Configuring Virtual Contexts, page 6-8](#)

## Configuring Skinny Parameter Maps

You can configure Skinny Client Control Protocol (SCCP or [Skinny](#)) parameter maps, which allow you to configure SCCP packet inspection on the ACE.

#### Procedure

**Step 1** Choose **Config > Devices > context > Load Balancing > Parameter Maps > Skinny Parameter Maps**.

The Skinny Parameter Maps table appears.

**Step 2** In the Skinny Parameter Maps table, click **Add** to add a new parameter map, or choose an existing parameter map and click **Edit** to modify it.

The Parameter Maps configuration window appears.

- Step 3** In the Parameter Maps configuration window, configure the parameter map using the information in [Table 10-10](#).

**Table 10-10** Skinny Parameter Map Attributes

| Field                           | Description                                                                                                                                                                                                                                                                                                                                                                                                                                                                                                                                    |
|---------------------------------|------------------------------------------------------------------------------------------------------------------------------------------------------------------------------------------------------------------------------------------------------------------------------------------------------------------------------------------------------------------------------------------------------------------------------------------------------------------------------------------------------------------------------------------------|
| Parameter Name                  | Unique name for the parameter map. Valid entries are unquoted text strings with no spaces and a maximum of 64 alphanumeric characters.                                                                                                                                                                                                                                                                                                                                                                                                         |
| Description                     | Field that appears for ACE module A2(1.5), ACE appliance A3(2.3), and later releases of either device type. If you attempt to use the Description feature with an ACE that is running an earlier software version, ANM displays an invalid command detected error message and does not deploy the parameter map.<br><br>Brief description of the parameter map. Enter a text string with a maximum of 240 alphanumeric characters (A–Z, a–z, 0–9). Spaces and special characters are allowed. Double quotes must be entered as matching pairs. |
| Enforce Registration            | Check box that enables Skinny registration enforcement. You can configure the ACE to allow only registered Skinny clients to make calls. To accomplish this task, the ACE maintains the state of each Skinny client. After a client registers with CCM, the ACE opens a secure port (pinhole) to allow that client to make a call.<br><br>Uncheck the check box to disable this feature.                                                                                                                                                       |
| Message Id Max                  | Maximum value for the station message ID in hexadecimal that the ACE is to accept. Valid entries are hexadecimal values from 0x0 to 0x4000 with a default value of 0x181. If a packet arrives with a station message ID greater than the specified value, the ACE drops the packet and generates a syslog message.<br><br><br><b>Note</b> The Message Id Max. hexadecimal value should always start with 0x or 0X.                                          |
| Min. SCCP Prefix Length (Bytes) | Minimum SCCP prefix length in bytes. By default, the ACE drops SCCP messages that have an SCCP Prefix length that is less than the message ID. The ACE drops Skinny message packets that fail this check and generates a syslog message.<br><br>Valid entries are from 4 to 4000 bytes.                                                                                                                                                                                                                                                        |
| Max. SCCP Prefix Length (Bytes) | Maximum SCCP prefix length in bytes. This feature allows you to configure the ACE so that it checks the maximum SCCP prefix length. The ACE drops Skinny message packets that fail this check and generates a syslog message.<br><br>Valid entries are from 4 to 4000 bytes.                                                                                                                                                                                                                                                                   |

- Step 4** Do one of the following:
- Click **Deploy Now** to deploy this configuration on the ACE and save your entries to the running-configuration and startup-configuration files.
  - Click **Cancel** to exit this procedure without saving your entries and to return to the Skinny Parameter Maps table.
  - Click **Next** to deploy your entries and to configure another Skinny parameter map.

#### Related Topics

- [Configuring Parameter Maps, page 10-1](#)



- [Configuring Traffic Policies, page 14-1](#)
- [Configuring Virtual Contexts, page 6-8](#)

## Configuring DNS Parameter Maps

You can configure Domain Name System (DNS) parameter maps, which allow you to configure DNS actions for DNS packet inspection.

### Procedure

- 
- Step 1** Choose **Config > Devices > context > Load Balancing > Parameter Maps > DNS Parameter Maps**.  
The DNS Parameter Maps table appears.
- Step 2** In the DNS Parameter Maps table, click **Add** to add a new parameter map, or choose an existing parameter map and click **Edit** to modify it.  
The DNS Parameter Maps configuration window appears.
- Step 3** In the DNS Parameter Maps configuration window, configure the parameter map using the information in [Table 10-11](#).

**Table 10-11** DNS Parameter Map Attributes

| Field             | Description                                                                                                                                                                                                                                                                                                                                                                                                                                                                                                                                    |
|-------------------|------------------------------------------------------------------------------------------------------------------------------------------------------------------------------------------------------------------------------------------------------------------------------------------------------------------------------------------------------------------------------------------------------------------------------------------------------------------------------------------------------------------------------------------------|
| Parameter Name    | Unique name for the parameter map. Valid entries are unquoted text strings with no spaces and a maximum of 64 alphanumeric characters.                                                                                                                                                                                                                                                                                                                                                                                                         |
| Description       | Field that appears for ACE module A2(1.5), ACE appliance A3(2.3), and later releases of either device type. If you attempt to use the Description feature with an ACE that is running an earlier software version, ANM displays an invalid command detected error message and does not deploy the parameter map.<br><br>Brief description of the parameter map. Enter a text string with a maximum of 240 alphanumeric characters (A–Z, a–z, 0–9). Spaces and special characters are allowed. Double quotes must be entered as matching pairs. |
| Timeout (Seconds) | Amount of time in seconds that the ACE keeps the query entries without answers in the hash table before timing them out. Configure the ACE to time out DNS queries that have no matching server response. Specify the Enter an integer from 2 to 120 seconds. The default is 10 seconds.                                                                                                                                                                                                                                                       |

- Step 4** Do one of the following:
- Click **Deploy Now** to deploy this configuration on the ACE and save your entries to the running-configuration and startup-configuration files.
  - Click **Cancel** to exit this procedure without saving your entries and to return to the DNS Parameter Maps table.
  - Click **Next** to deploy your entries and to configure another DNS parameter map.
- 

### Related Topics

- [Configuring Parameter Maps, page 10-1](#)

- [Configuring Traffic Policies, page 14-1](#)
- [Configuring Virtual Contexts, page 6-1](#)

## Supported MIME Types

The ACE supports the following MIME types:

- application/msexcel
- application/mspowerpoint
- application/msword
- application/octet-stream
- application/pdf
- application/postscript
- application/\x-gzip
- application/\x-java-archive
- application/\x-java-vm
- application/\x-messenger
- application/\zip
- audio/\*
- audio/basic
- audio/midi
- audio/mpeg
- audio/x-adpcm
- audio/x-aiff
- audio/x-ogg
- audio/x-wav
- image/\*
- image/gif
- image/jpeg
- image/png
- image/tiff
- image/x-3ds
- image/x-bitmap
- image/x-niff
- image/x-portable-bitmap
- image/x-portable-greymap
- image/x-xpm
- text/\*
- text/css

- text/html
- text/plain
- text/richtext
- text/sgml
- text/xmcd
- text/xml
- video/\*
- video/flc
- video/mpeg
- video/quicktime
- video/sgi
- video/x-fli





# CHAPTER 11

## Configuring SSL

---

**Date:** 3/28/12

This chapter describes how to configure Secure Sockets Layer (SSL) on the Cisco Application Control Engine (ACE) using Cisco Application Networking Manager (ANM).



**Note**

When naming ACE objects (such as a real server, virtual server, parameter map, class map, health probe, and so on), enter an alphanumeric string of 1 to 64 characters, which can include the following special characters: underscore (\_), hyphen (-), dot (.), and asterisk (\*). Spaces are not allowed.

If you are using ANM with an ACE module or ACE appliance and you configure a named object at the ACE CLI, keep in mind that ANM does not support all of the special characters that the ACE CLI allows you to use when configuring a named object. If you use special characters that ANM does not support, you may not be able to import or manage the ACE using ANM.

---

This chapter includes the following sections:

- [SSL Overview, page 11-2](#)
- [SSL Configuration Prerequisites, page 11-2](#)
- [Summary of SSL Configuration Tasks, page 11-3](#)
- [SSL Setup Sequence, page 11-4](#)
- [Using SSL Certificates, page 11-5](#)
- [Using SSL Keys, page 11-10](#)
- [Configuring SSL Parameter Maps, page 11-18](#)
- [Configuring SSL Chain Group Parameters, page 11-23](#)
- [Configuring SSL CSR Parameters, page 11-24](#)
- [Generating CSRs, page 11-26](#)
- [Configuring SSL Proxy Service, page 11-27](#)
- [Configuring SSL OCSP Service, page 11-29](#)
- [Enabling Client Authentication, page 11-31](#)

# SSL Overview

SSL is an application-level protocol that provides encryption technology for the Internet, ensuring secure transactions such as the transmission of credit card numbers for e-commerce websites. SSL initiation occurs when the ACE device (either an ACE module or an ACE appliance) acts as a client and initiates the SSL session between it and the SSL server. SSL termination occurs when the ACE, acting as an SSL server, terminates an SSL connection from a client and then establishes a TCP connection to an HTTP server.

SSL provides the secure transaction of data between a client and a server through a combination of privacy, authentication, and data integrity. SSL relies upon certificates and private-public key exchange pairs for this level of security.

Figure 11-1 shows the following network connections in which the ACE terminates the SSL connection with the client:

- Client to ACE—SSL connection between a client and the ACE acting as an SSL proxy server
- ACE to Server—TCP connection between the ACE and the HTTP server

**Figure 11-1** *SSL Termination with Client*  
SSL Termination with a Client

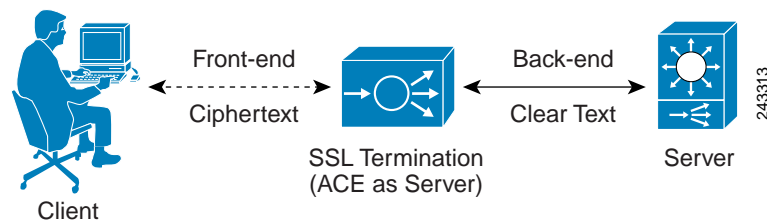

The ACE uses parameter maps, SSL proxy services, and class maps to build the policy maps that determine the flow of information between the client, the ACE, and the server. SSL termination is a Layer 3 and Layer 4 application because it is based on the destination IP addresses of the inbound traffic flow from the client. For this type of application, you create a Layer 3 and Layer 4 policy map that the ACE applies to the inbound traffic.

If you need to delete any of the SSL objects (authorization groups, chain groups, parameter maps, keys, CRLs, or certificates), you must remove the dependency from within the proxy service first before removing the SSL object.

Before configuring the ACE for SSL, see the “[SSL Configuration Prerequisites](#)” section on page 11-2.

## SSL Configuration Prerequisites

This SSL configuration prerequisites are as follows:

- Your ACE hardware is configured for server load balancing (SLB).



### Note

During the real server and server farm configuration process, when you associate a real server with a server farm, ensure that you assign an appropriate port number for the real server. The default behavior by the ACE is to automatically assign the same destination port that was used by the inbound connection to the outbound server connection if you do not specify a port.

- Your policy map is configured to define the SSL session parameters and client/server authentication tools, such as the certificate and RSA key pair.
- Your class map is associated with the policy map to define the virtual SSL server IP address that the destination IP address of the inbound traffic must match.
- You must import a digital certificate and its corresponding public and private key pair to the desired ACE context.
- At least one SSL certificate is available.
- If you do not have a certificate and corresponding key pair, you can generate an [RSA](#) key pair and a certificate signing request ([CSR](#)). Create a CSR when you need to apply for a certificate from a certificate authority (CA). The CA signs the CSR and returns the authorized digital certificate to you.



**Note** You cannot generate a CSR in Building Blocks (Config > Global > All Building Blocks); SSL CSR generation is available only in virtual context configuration.

## Summary of SSL Configuration Tasks

[Table 11-1](#) describes the tasks for using SSL keys and certificates.

**Table 11-1** *SSL Key and Certificate Procedure Overview*

| Task                                                                                                         | Description                                                                                                                                                                                                                                                        |
|--------------------------------------------------------------------------------------------------------------|--------------------------------------------------------------------------------------------------------------------------------------------------------------------------------------------------------------------------------------------------------------------|
| Create an SSL parameter map.                                                                                 | Create an SSL parameter map to specify the options that apply to SSL sessions such as the method to be used to close SSL connections, the cipher suite, and version of SSL or TLS. See the <a href="#">“Configuring SSL Parameter Maps”</a> section on page 11-18. |
| Create an SSL key pair file.                                                                                 | Create an SSL RSA key pair file to generate a CSR, create a digital signature, and encrypt packet data during the SSL handshake with an SSL peer. See the <a href="#">“Generating SSL Key Pairs”</a> section on page 11-14.                                        |
| Configure CSR parameters.                                                                                    | Set CSR parameters to define the distinguished name attributes of a CSR. See the <a href="#">“Configuring SSL CSR Parameters”</a> section on page 11-24.                                                                                                           |
| Create a CSR.                                                                                                | Create a CSR to submit with the key pair file when you apply for an SSL certificate. See the <a href="#">“Generating CSRs”</a> section on page 11-26.                                                                                                              |
| Copy and paste the CSR into the Certificate Authority (CA) web-based application or email the CSR to the CA. | Using the SSL key pair and CSR, apply for an approved certificate from a Certificate Authority.<br>Use the method specified by the CA for submitting your request.                                                                                                 |
| Save the approved certificate from the CA in its received format on an FTP, SFTP, or TFTP server.            | When you receive the approved certificate, save it in the format in which it was received on a network server accessible via FTP, SFTP, or TFTP.                                                                                                                   |

**Table 11-1** SSL Key and Certificate Procedure Overview (continued)

| Task                                                                                             | Description                                                                                                                                                                                                                                                                                                               |
|--------------------------------------------------------------------------------------------------|---------------------------------------------------------------------------------------------------------------------------------------------------------------------------------------------------------------------------------------------------------------------------------------------------------------------------|
| Import the approved certificate and key pair into the desired virtual context.                   | Import the approved certificate and the associated SSL key pair into the appropriate context using ANM.<br>For more information, see following sections: <ul style="list-style-type: none"> <li>• “Importing SSL Certificates” section on page 11-7</li> <li>• “Importing SSL Key Pairs” section on page 11-11</li> </ul> |
| Confirm that the public key in the key pair file matches the public key in the certificate file. | Examine the contents of the files to confirm that the key pair information is the same in both the key pair file and the certificate file.                                                                                                                                                                                |
| Configure the virtual context for SSL.                                                           | See the “Configuring Traffic Policies” section on page 14-1.                                                                                                                                                                                                                                                              |
| Configure authorization group.                                                                   | Create a group of certificates that are trusted as certificate signers by creating an authentication group. See the “Configuring SSL Authentication Groups” section on page 11-31.                                                                                                                                        |
| Configure CRL.                                                                                   | See the “Configuring CRLs for Client Authentication” section on page 11-33.                                                                                                                                                                                                                                               |

For more information about using SSL with ACE, see the *Cisco 4700 Series Application Control Engine Appliance SSL Configuration Guide* or *Cisco Application Control Engine Module SSL Configuration Guide*.

## SSL Setup Sequence

The SSL setup sequence provides detailed instructions with illustrations for configuring SSL on ACE devices from ANM (Figure 11-2). The purpose of this option is to provide a visual guide for performing typical SSL operations, such as SSL CSR generation, SSL proxy creation, and so on. This option does not replace any existing SSL functions or configuration windows already present in ANM. It is only intended as an additional guide for anyone unfamiliar or unclear with the SSL operations that need to be performed on the ACE device. From the SSL setup sequence, you are allowed to configure all SSL operations, without duplicating the edit/delete/table/view operations that the other SSL configuration windows provide.

The tools and operations involved in typical SSL operations are as follows:

- SSL Import/Create Keys
- SSL Import Certificates
- SSL CSR generation
- SSL proxy creation



### Note

The SSL Setup Sequence in ANM uses the terms *SSL Policies* and *SSL Proxy Service* interchangeably.



For more information on SSL configuration features, see the [“Summary of SSL Configuration Tasks” section on page 11-3](#).

**Figure 11-2** *SSL Setup Sequence*



#### Related Topics

- [Configuring SSL, page 11-1](#)
- [Importing SSL Certificates, page 11-7](#)
- [Importing SSL Key Pairs, page 11-11](#)
- [Configuring SSL Parameter Maps, page 11-18](#)
- [Configuring SSL Chain Group Parameters, page 11-23](#)
- [Configuring SSL Proxy Service, page 11-27](#)

## Using SSL Certificates

Digital certificates and key pairs are a form of digital identification for user authentication. Certificate Authorities issue certificates that attest to the validity of the public keys they contain. A client or server certificate includes the following identification attributes:

- Name of the Certificate Authority and Certificate Authority digital signature
- Name of the client or server (the certificate subject) that the certificate authenticates
- Issuer
- Time stamps that indicate the certificate’s start date
- Time stamps that indicate the certificate’s expiration date
- CA certificate

A Certificate Authority has one or more signing certificates that it uses for creating SSL certificates and certificate revocation lists (CRLs). Each signing certificate has a matching private key that is used to create the Certificate Authority signature. The Certificate Authority makes the signing certificates (with the public key embedded) available to the public, enabling anyone to access and use the signing certificates to verify that an SSL certificate or CRL was actually signed by a specific Certificate Authority.



#### Note

For the ACE module A2(3.0), ACE appliance A4(1.0), or later releases of either device type, the ACE supports a maximum of eight CRLs for any context. For earlier releases of either device type, the ACE supports a maximum of four CRLs for any context.

All certificates have an expiration date, usually one year after the certificate was issued. You can monitor certificate expiration status by going to Monitor > Devices > *context* > Dashboard. ANM issues a warning email daily before the certificate expiration date. You establish how many days before the expiration date that the warning email messages begin in the Threshold Groups settings window, which you can access using either of the following methods:

- Choose **Monitor > Alarm Notifications > Thresholds Groups**.
- Click the **Configure Certificate Expiry Threshold Alarms** button in the Certificates window (Config > Devices > *context* > SSL > Certificates).

**Note**

The Certificates window (Config > Devices > *context* > SSL > Certificates) contains the Expiry Date field, which displays the certificate expiration date. Due to a known issue with the ACE module and appliance, it is possible that this field displays either “Null” or characters that are unparseable or unreadable. When this issue occurs, ANM is unable to track the certificate expiration date. If the certificate is defined in a threshold group configured for certificate expiration alarm notifications and this issue occurs, ANM may not issue an expiration alarm when expected or it may issue a false alarm. If you encounter this issue, remove the certificate from the ACE, reimport it, and then verify that the correct expiration date displays in the Certificates window.

For more information about configuring the certificate expiration alarm notification, see the [“Configuring Alarm Notifications on ANM” section on page 17-57](#).

The ACE requires certificates and corresponding key pairs for the following:

- **SSL Termination**—The ACE acts as an SSL proxy server and terminates the SSL session between it and the client. For SSL termination, you must obtain a server certificate and corresponding key pair.
- **SSL Initiation**—The ACE acts as a client and initiates the SSL session between it and the SSL server. For SSL initiation, you must obtain a client certificate and corresponding key pair.

**Note**

The ACE includes a preinstalled sample certificate and corresponding key pair. This feature is available only for the ACE module A2(3.0), ACE appliance A4(1.0), and later releases of either device type.

The certificate is for demonstration purposes only and does not have a valid domain. It is a self-signed certificate with basic extensions named *cisco-sample-cert*. The key pair is an RSA 1024-bit key pair named *cisco-sample-key*.

You can display the sample certificate and corresponding key pair files as follows:

- To display the *cisco-sample-cert* file, choose **Config > Devices > *context* > SSL > Certificates**.
- To display the *cisco-sample-key* file, choose **Config > Devices > *context* > SSL > Keys**.

You can add these files to an SSL-proxy service (see the [“Configuring SSL Proxy Service” section on page 11-27](#)) and are available for use in any context with the filenames remaining the same in each context.

The ACE allows you to export these files but does not allow you to import any files with these names. When you upgrade the ACE software, these files are overwritten with the files provided in the upgrade image. You cannot use the **crypto delete** CLI command to delete these files unless you downgrade the ACE software because a software downgrade preserves these files as if they were user-installed SSL files.

**Related Topics**

- [Configuring SSL](#), page 11-1
- [Exporting SSL Certificates](#), page 11-15
- [Importing SSL Certificates](#), page 11-7
- [Using SSL Keys](#), page 11-10
- [Importing SSL Key Pairs](#), page 11-11
- [Configuring SSL CSR Parameters](#), page 11-24
- [Generating CSRs](#), page 11-26
- [Configuring SSL Proxy Service](#), page 11-27

## Importing SSL Certificates

You can import SSL certificates from a remote server to the ACE, which can support the following number of certificates and key pairs depending on the installed software version:

- ACE Module:
  - A2(3.x) and earlier—3800 certificates and 3800 key pairs
  - A4(1.0)—4096 certificates and 4096 key pairs
- ACE Appliance:
  - A3(1.x) and earlier—3800 certificates and 3800 key pairs
  - A3(2.x) and later (including A4(1.0))—4096 certificates and 4096 key pairs

**Assumptions**

This topic assumes the following:

- You have configured the ACE for server load balancing. (See the [“Information About Load Balancing”](#) section on page 7-1.)
- You have obtained an SSL certificate from a certificate authority (CA) and have placed it on a network server accessible by the ACE.



---

**Note** You cannot import SSL certificates in Building Blocks (Config > Global > All Building Blocks); SSL certificate imports are available only in virtual context configuration.

---

**Procedure**

- 
- Step 1** To configure a virtual context, choose **Config > Devices > context > SSL > Certificates**.  
The Certificates table appears, listing any valid SSL certificates.  
The cisco-sample-cert certificate is included in the list only for the ACE module A2(3.0), ACE appliance A4(1.0), and later releases of either device type. For information on this sample certificate, see the [“Using SSL Certificates”](#) section on page 11-5.
- Step 2** In the Certificates table, do one of the following:
- To import a single SSL certificate, click **Import**. The Import dialog box appears.
  - To import multiple SSL certificates, click **Bulk Import**. The Bulk Import dialog box appears.



**Note** The SSL bulk import feature is available only for ACE module A2(2.0), ACE appliance A4(1.0), or later releases of either device type. If you attempt to use the bulk import feature with an ACE that is running an earlier software version, ANM displays an invalid command detected error message and does not deploy the bulk import configuration for the ACE.



**Note** SSL bulk import can take longer based on the number of SSL certificates being imported. It will progress to completion on the ACE. To see the imported certificates in ANM, perform a CLI Sync for this context once the SSL bulk import has completed. For information on synchronizing contexts, see the [“Synchronizing Virtual Context Configurations”](#) section on page 6-105.

**Step 3** Enter the applicable information:

- For the Import dialog box, see [Table 11-2](#).
- For the Bulk Import dialog box, see [Table 11-3](#) (ACE module A2(2.0), ACE appliance A4(1.0), and later releases of either device type only).

**Table 11-2** *SSL Certificate Management Import Attributes*

| Field            | Description                                                                                                                                                                                                                                                                                                                                                                                                                                                                                                                                                                                                                                           |
|------------------|-------------------------------------------------------------------------------------------------------------------------------------------------------------------------------------------------------------------------------------------------------------------------------------------------------------------------------------------------------------------------------------------------------------------------------------------------------------------------------------------------------------------------------------------------------------------------------------------------------------------------------------------------------|
| Protocol         | Method to use for accessing the network server: <ul style="list-style-type: none"> <li>• <b>FTP</b>—FTP is to be used to access the network server when importing the SSL certificate.</li> <li>• <b>SFTP</b>—SFTP is to be used to access the network server when importing the SSL certificate.</li> <li>• <b>TERMINAL</b>—You will import the file using cut and paste by pasting the certificate information to the terminal display. You can use the terminal method to display only PEM files, which are in ASCII format.</li> <li>• <b>TFTP</b>—TFTP is to be used to access the network server when importing the SSL certificate.</li> </ul> |
| IP Address       | Field that appears for FTP, TFTP, and SFTP. Enter the IP address of the remote server on which the SSL certificate file resides.                                                                                                                                                                                                                                                                                                                                                                                                                                                                                                                      |
| Remote File Name | Field that appears for single-file SSL certificate importing and FTP, TFTP, and SFTP. Enter the directory and filename of the single certificate file on the network server.                                                                                                                                                                                                                                                                                                                                                                                                                                                                          |
| Local File Name  | Filename to use for the single SSL certificate file when it is imported to the ACE.                                                                                                                                                                                                                                                                                                                                                                                                                                                                                                                                                                   |
| User Name        | Field that appears for FTP and SFTP. Enter the name of the user account on the network server.                                                                                                                                                                                                                                                                                                                                                                                                                                                                                                                                                        |
| Password         | Field that appears for FTP and SFTP. Enter the password for the user account on the network server.                                                                                                                                                                                                                                                                                                                                                                                                                                                                                                                                                   |
| Confirm          | Field that appears for FTP and SFTP. Reenter the password.                                                                                                                                                                                                                                                                                                                                                                                                                                                                                                                                                                                            |
| Passphrase       | Field that appears for FTP, TFTP, SFTP, and TERMINAL. Enter the passphrase that was created with the file. Without this phrase, you cannot use the file. Passphrases are used only with encrypted PEM and PKCS files.                                                                                                                                                                                                                                                                                                                                                                                                                                 |
| Confirm          | Field that appears for FTP, SFTP, and TERMINAL. Reenter the passphrase.                                                                                                                                                                                                                                                                                                                                                                                                                                                                                                                                                                               |

**Table 11-2** *SSL Certificate Management Import Attributes (continued)*

| Field          | Description                                                                                                                                                                                                                                                                                                                                              |
|----------------|----------------------------------------------------------------------------------------------------------------------------------------------------------------------------------------------------------------------------------------------------------------------------------------------------------------------------------------------------------|
| Non-Exportable | Check box that specifies that this certificate file cannot be exported from the ACE.<br><br>The ability to export SSL certificates allows you to copy signed certificates to another server on your network so that you can then import them onto another ACE or Web server. Exporting is similar to copying in that the original files are not deleted. |
| Import Text    | Field that appears for Terminal. Cut the certificate information from the remote server and paste it into this field.                                                                                                                                                                                                                                    |

**Table 11-3** *SSL Certificate Management Bulk Import Attributes*

| Field          | Description                                                                                                                                                                                                                                                                                                                                                                                                                                                                                                                                                                                                                                                                                                                                                                                                                                                                                                                                                     |
|----------------|-----------------------------------------------------------------------------------------------------------------------------------------------------------------------------------------------------------------------------------------------------------------------------------------------------------------------------------------------------------------------------------------------------------------------------------------------------------------------------------------------------------------------------------------------------------------------------------------------------------------------------------------------------------------------------------------------------------------------------------------------------------------------------------------------------------------------------------------------------------------------------------------------------------------------------------------------------------------|
| Protocol       | SFTP is to be used to access the network server when importing the SSL certificates. SFTP is the only supported protocol for bulk import.                                                                                                                                                                                                                                                                                                                                                                                                                                                                                                                                                                                                                                                                                                                                                                                                                       |
| IP Address     | IP address of the remote server on which the SSL certificate files reside.                                                                                                                                                                                                                                                                                                                                                                                                                                                                                                                                                                                                                                                                                                                                                                                                                                                                                      |
| Remote Path    | Path to the SSL certificate files that reside on the remote server. The ACE fetches only files specified by the path; it does not recursively fetch remote directories. Enter a filename path including wildcards (for example, /remote/path/*.pem). The ACE supports POSIX pattern matching notation, as specified in section 2.13 of the "Shell and Utilities" volume of IEEE Std 1003.1-2004. This notation includes the "*", "?" and "[" metacharacters.<br><br>To fetch all files from a remote directory, specify a remote path that ends with a wildcard character (for example, /remote/path/*). Do not include spaces or the following special characters:<br><br>;<> `@\$&()<br><br>The ACE fetches all files on the remote server that matches the wildcard criteria. However, it imports only files with names that have a maximum of 40 characters. If the name of a file exceeds 40 characters, the ACE does not import the file and discards it. |
| User Name      | Name of the user account on the network server.                                                                                                                                                                                                                                                                                                                                                                                                                                                                                                                                                                                                                                                                                                                                                                                                                                                                                                                 |
| Password       | Password for the user account on the network server.                                                                                                                                                                                                                                                                                                                                                                                                                                                                                                                                                                                                                                                                                                                                                                                                                                                                                                            |
| Confirm        | Password confirmation.                                                                                                                                                                                                                                                                                                                                                                                                                                                                                                                                                                                                                                                                                                                                                                                                                                                                                                                                          |
| Passphrase     | Passphrase that was created with the file. Without this phrase, you cannot use the file. Passphrases are used only with encrypted PEM and PKCS files.                                                                                                                                                                                                                                                                                                                                                                                                                                                                                                                                                                                                                                                                                                                                                                                                           |
| Confirm        | Passphrase confirmation.                                                                                                                                                                                                                                                                                                                                                                                                                                                                                                                                                                                                                                                                                                                                                                                                                                                                                                                                        |
| Non-Exportable | Check box to specify that this certificate file cannot be exported from the ACE.<br><br>The ability to export SSL certificates allows you to copy signed certificates to another server on your network so that you can then import them onto another ACE or Web server. Exporting is similar to copying in that the original files are not deleted.                                                                                                                                                                                                                                                                                                                                                                                                                                                                                                                                                                                                            |

**Step 4** Do one of the following:

- Click **OK** to accept your entries and to return to the Certificates table. ANM updates the Certificates table with the newly installed certificate.
- Click **Cancel** to exit this procedure without saving your entries and to return to the Certificates table.

**Related Topics**

- [Configuring SSL, page 11-1](#)
- [Using SSL Keys, page 11-10](#)
- [Importing SSL Key Pairs, page 11-11](#)
- [Configuring SSL Parameter Maps, page 11-18](#)
- [Configuring SSL Chain Group Parameters, page 11-23](#)
- [Configuring SSL CSR Parameters, page 11-24](#)
- [Configuring SSL Proxy Service, page 11-27](#)

## Using SSL Keys

You can display options for working with SSL and SSL keys. The ACE and its peer use a public key cryptographic system named Rivest, Shamir, and Adelman Signatures (RSA) for authentication during the SSL handshake to establish an SSL session. The RSA system uses *key pairs* that consist of a public key and a corresponding private (secret) key. During the handshake, the RSA key pairs encrypt the session key that both devices will use to encrypt the data that follows the handshake.

**Procedure**

---

**Step 1** Choose the item to configure:

- To configure a virtual context, choose **Config > Devices > context > SSL > Keys**.
- To configure a building block, choose **Config > Global > building\_block > SSL > Keys**.

The Keys table appears.

**Step 2** In the Keys table, continue with one of the following options:

- Generate a key pair—See [Generating SSL Key Pairs, page 11-14](#).
  - Import a key pair—See [Importing SSL Key Pairs, page 11-11](#).
  - Export a key pair—See [Exporting SSL Key Pairs, page 11-16](#).
  - Generate a CSR—See [Generating CSRs, page 11-26](#).
- 

**Related Topics**

- [Generating SSL Key Pairs, page 11-14](#)
- [Importing SSL Key Pairs, page 11-11](#)
- [Generating SSL Key Pairs, page 11-14](#)
- [Exporting SSL Key Pairs, page 11-16](#)
- [Configuring SSL, page 11-1](#)

## Importing SSL Key Pairs

You can import an SSL key pair file from a network server to an ACE, which can support the following number of certificates and key pairs depending on the installed software version:

- ACE Module:
  - A2(3.x) and earlier—3800 certificates and 3800 key pairs
  - A4(1.0)—4096 certificates and 4096 key pairs
- ACE Appliance:
  - A3(1.x) and earlier—3800 certificates and 3800 key pairs
  - A3(2.x) and later (including A4(1.0))—4096 certificates and 4096 key pairs

### Assumptions

This topic assumes the following:

- You have configured the ACE for server load balancing. (See the [“Information About Load Balancing”](#) section on page 7-1.)
- You have obtained an SSL key pair from a certificate authority (CA) and have placed the pair on a network server accessible by the ACE.

### Procedure

**Step 1** Choose the item to configure:

- To configure a virtual context, choose **Config > Devices > context > SSL > Keys**.
- To configure a building block, choose **Config > Global > building\_block > SSL > Keys**.

The Keys table appears, listing existing SSL keys.

For the ACE module A2(3.0), ACE appliance A4(1.0), and later releases of both either type, the cisco-sample-key key pair is included in the list. For information on this sample key pair, see the [“Using SSL Certificates”](#) section on page 11-5.

**Step 2** Do one of the following:

- To import a single SSL key pair, in the Keys table, click **Import**. The Import dialog box appears.
- To import multiple SSL key pairs, click **Bulk Import**. The Bulk Import dialog box appears.

**Note**

The SSL bulk import feature is available only for ACE module A2(2.0), ACE appliance A4(1.0), and later releases of either device type. If you attempt to use the bulk import feature with an ACE that is running an earlier software version, ANM displays an invalid command detected error message and does not deploy the bulk import configuration for the ACE.

**Note**

SSL bulk import can take longer based on the number of SSL keys being imported. It will progress to completion on the ACE. To see the imported keys in ANM, perform a CLI Sync for this context once the SSL bulk import has completed. For information on synchronizing contexts, see the [“Synchronizing Virtual Context Configurations”](#) section on page 6-105.

**Step 3** Enter the applicable information as follows:

- For the Import dialog box, see [Table 11-4](#).
- For the Bulk Import dialog box, see [Table 11-5](#) (ACE module A2(2.0), ACE appliance A4(1.0), and later releases of either device type only).

**Table 11-4** *SSL Key Pair Import Attributes*

| Field            | Description                                                                                                                                                                                                                                                                                                                                                                                                                                                                                                                                                                                                                                                              |
|------------------|--------------------------------------------------------------------------------------------------------------------------------------------------------------------------------------------------------------------------------------------------------------------------------------------------------------------------------------------------------------------------------------------------------------------------------------------------------------------------------------------------------------------------------------------------------------------------------------------------------------------------------------------------------------------------|
| Protocol         | Method to use for accessing the network server: <ul style="list-style-type: none"> <li>• <b>FTP</b>—FTP is to be used to access the network server when importing the SSL key pair file.</li> <li>• <b>SFTP</b>—SFTP is to be used to access the network server when importing the SSL key pair file.</li> <li>• <b>TERMINAL</b>—You will import the file using cut and paste by pasting the certificate and key pair information to the terminal display. You can use the terminal method to display only PEM files, which are in ASCII format.</li> <li>• <b>TFTP</b>—TFTP is to be used to access the network server when importing the SSL key pair file.</li> </ul> |
| IP Address       | Field that appears for FTP, TFTP, and SFTP. Enter the IP address of the remote server on which the SSL key pair file resides.                                                                                                                                                                                                                                                                                                                                                                                                                                                                                                                                            |
| Remote File Name | Field that appears for single-file SSL key pair importing and FTP, TFTP, and SFTP. Enter the directory and filename of the single key pair file on the network server.                                                                                                                                                                                                                                                                                                                                                                                                                                                                                                   |
| Local File Name  | Filename to be used for the single SSL key pair file when it is imported to the ACE.                                                                                                                                                                                                                                                                                                                                                                                                                                                                                                                                                                                     |
| User Name        | This field appears for FTP and SFTP. Enter the name of the user account on the network server.                                                                                                                                                                                                                                                                                                                                                                                                                                                                                                                                                                           |
| Password         | Field that appears for FTP and SFTP. Enter the password for the user account on the network server.                                                                                                                                                                                                                                                                                                                                                                                                                                                                                                                                                                      |
| Confirm          | Field that appears for FTP, SFTP, and TERMINAL. Reenter the password.                                                                                                                                                                                                                                                                                                                                                                                                                                                                                                                                                                                                    |
| Passphrase       | Field that appears for FTP, TFTP, SFTP, and TERMINAL. Enter the passphrase that was created with the file. Without this phrase, you cannot use the file. Passphrases are used only with encrypted PEM and PKCS files.                                                                                                                                                                                                                                                                                                                                                                                                                                                    |
| Confirm          | Field that appears for FTP and SFTP. Reenter the passphrase.                                                                                                                                                                                                                                                                                                                                                                                                                                                                                                                                                                                                             |
| Non-Exportable   | Check box to specify that this key pair file cannot be exported from the ACE. The ability to export SSL key pair files allows you to copy key pair files to another server on your network so that you can then import them onto another ACE or Web server. Exporting is similar to copying in that the original files are not deleted.<br><br>Uncheck the check box to indicate that this key pair file can be exported from the ACE.                                                                                                                                                                                                                                   |
| Import Text      | Field that appears for Terminal. Cut the key pair information from the remote server and paste it into this field.                                                                                                                                                                                                                                                                                                                                                                                                                                                                                                                                                       |

**Table 11-5** *SSL Key Pair Bulk Import Attributes*

| Field      | Description                                                                                                                            |
|------------|----------------------------------------------------------------------------------------------------------------------------------------|
| Protocol   | SFTP is to be used to access the network server when importing the SSL key pairs. SFTP is the only supported protocol for bulk import. |
| IP Address | IP address of the remote server on which the SSL key pair files resides.                                                               |



**Table 11-5** *SSL Key Pair Bulk Import Attributes (continued)*

| Field          | Description                                                                                                                                                                                                                                                                                                                                                                                                                                                                                                                                                                                                                                                                                                                                                                                                                                                                                                                                                                                                                     |
|----------------|---------------------------------------------------------------------------------------------------------------------------------------------------------------------------------------------------------------------------------------------------------------------------------------------------------------------------------------------------------------------------------------------------------------------------------------------------------------------------------------------------------------------------------------------------------------------------------------------------------------------------------------------------------------------------------------------------------------------------------------------------------------------------------------------------------------------------------------------------------------------------------------------------------------------------------------------------------------------------------------------------------------------------------|
| Remote Path    | <p>Path to the key pair files that reside on the remote server. The ACE fetches only files specified by the path; it does not recursively fetch remote directories. Enter a filename path including wildcards (for example, /remote/path/*.pem). The ACE module supports POSIX pattern matching notation, as specified in section 2.13 of the "Shell and Utilities" volume of IEEE Std 1003.1-2004. This notation includes the "*", "?" and "[" metacharacters.</p> <p>To fetch all files from a remote directory, specify a remote path that ends with a wildcard character (for example, /remote/path/*). Do not include spaces or the following special characters:</p> <pre style="margin-left: 40px;">;&lt;&gt; \' @\$&amp;()</pre> <p>The ACE module fetches all files on the remote server that matches the wildcard criteria. However, it imports only files with names that have a maximum of 40 characters. If the name of a file exceeds 40 characters, the ACE module does not import the file and discards it.</p> |
| User Name      | Name of the user account on the network server.                                                                                                                                                                                                                                                                                                                                                                                                                                                                                                                                                                                                                                                                                                                                                                                                                                                                                                                                                                                 |
| Password       | Password for the user account on the network server.                                                                                                                                                                                                                                                                                                                                                                                                                                                                                                                                                                                                                                                                                                                                                                                                                                                                                                                                                                            |
| Confirm        | Password confirmation.                                                                                                                                                                                                                                                                                                                                                                                                                                                                                                                                                                                                                                                                                                                                                                                                                                                                                                                                                                                                          |
| Passphrase     | Passphrase that was created with the file. Without this phrase, you cannot use the file. Passphrases are used only with encrypted PEM and PKCS files.                                                                                                                                                                                                                                                                                                                                                                                                                                                                                                                                                                                                                                                                                                                                                                                                                                                                           |
| Confirm        | Passphrase confirmation.                                                                                                                                                                                                                                                                                                                                                                                                                                                                                                                                                                                                                                                                                                                                                                                                                                                                                                                                                                                                        |
| Non-Exportable | Check box to specify that this certificate file cannot be exported from the ACE. The ability to export SSL key pairs allows you to copy signed certificates to another server on your network so that you can then import them onto another ACE or Web server. Exporting is similar to copying in that the original files are not deleted.                                                                                                                                                                                                                                                                                                                                                                                                                                                                                                                                                                                                                                                                                      |

**Step 4** Do one of the following:

- Click **OK** to accept your entries and to return to the Keys table. ANM updates the Keys table with the imported key pair file information.
- Click **Cancel** to exit this procedure without saving your entries and to return to the Keys table.

**Related Topics**

- [Configuring SSL, page 11-1](#)
- [Importing SSL Certificates, page 11-7](#)
- [Configuring SSL Parameter Maps, page 11-18](#)
- [Configuring SSL Chain Group Parameters, page 11-23](#)
- [Configuring SSL CSR Parameters, page 11-24](#)
- [Configuring SSL Proxy Service, page 11-27](#)

## Generating SSL Key Pairs

The ACE can generate SSL RSA key pairs if you do not have any matching key pairs.

### Procedure

**Step 1** Choose the item to configure:

- To configure a virtual context, choose **Config > Devices > context > SSL > Keys**.
- To configure a building block, choose **Config > Global > building\_block > SSL > Keys**.

The Keys table appears.

For the ACE module A2(3.0), ACE appliance A4(1.0), and later releases of either device type, the cisco-sample-key key pair is included in the list. For information about this sample key pair, see the “Using SSL Certificates” section on page 11-5.

**Step 2** In the Keys table, click **Add** to add a new key pair.

The Keys configuration window appears.



**Note** You cannot modify an existing entry in the Keys table. Instead, delete the existing entry, then add a new one.

**Step 3** In the Keys configuration window, enter the information in [Table 11-6](#).

**Table 11-6** Key Attributes

| Field          | Description                                                                                                                                                                                                                                                                                                                                                                                                                                                                                                                                                                  |
|----------------|------------------------------------------------------------------------------------------------------------------------------------------------------------------------------------------------------------------------------------------------------------------------------------------------------------------------------------------------------------------------------------------------------------------------------------------------------------------------------------------------------------------------------------------------------------------------------|
| Name           | Name of the SSL key pair. Valid entries are alphanumeric strings up to 64 characters.                                                                                                                                                                                                                                                                                                                                                                                                                                                                                        |
| Size (Bits)    | Key pair security strength. The number of bits in the key pair file defines the size of the RSA key pair used to secure Web transactions. Longer keys produce more secure implementations by increasing the strength of the RSA security policy. Options and their relative levels of security are as follows: <ul style="list-style-type: none"> <li>• <b>512</b>—Least security</li> <li>• <b>768</b>—Normal security</li> <li>• <b>1024</b>—High security, level 1</li> <li>• <b>1536</b>—High security, level 2</li> <li>• <b>2048</b>—High security, level 3</li> </ul> |
| Type           | RSA is a public-key cryptographic system used for authentication.                                                                                                                                                                                                                                                                                                                                                                                                                                                                                                            |
| Exportable Key | Check box that specifies that the key pair file can be exported. Uncheck the check box to indicate that the key pair file cannot be exported.                                                                                                                                                                                                                                                                                                                                                                                                                                |

**Step 4** Do one of the following:

- Click **Deploy Now** to deploy this configuration on the ACE and save your entries to the running-configuration and startup-configuration files.
- Click **Cancel** to exit this procedure without saving your entries and to return to the Keys table.

- Click **Next** to deploy your entries and to define another RSA key pair.
- 

After generating an RSA key pair, you can do the following:

- Create a CSR parameter set. The CSR parameter set defines the distinguished name attributes for the ACE to use during the CSR-generating process. For details on defining a CSR parameter set, see the “[Configuring SSL CSR Parameters](#)” section on page 11-24.
- Generate a CSR for the RSA key pair file and transfer the CSR request to the certificate authority for signing. This provides an added layer of security because the RSA private key originates directly within the ACE and does not have to be transported externally. Each generated key pair must be accompanied by a corresponding certificate to work. For details on generating a CSR, see the “[Generating CSRs](#)” section on page 11-26.

#### Related Topics

- [Configuring SSL, page 11-1](#)
- [Importing SSL Certificates, page 11-7](#)
- [Importing SSL Key Pairs, page 11-11](#)
- [Configuring SSL Chain Group Parameters, page 11-23](#)
- [Configuring SSL CSR Parameters, page 11-24](#)
- [Configuring SSL Proxy Service, page 11-27](#)

## Exporting SSL Certificates

You can export SSL certificates from the ACE to a remote server. The ability to export SSL certificates allows you copy signed certificates to another server on your network so that you can then import them onto another ACE or Web server. Exporting certificates is similar to copying in that the original certificates are not deleted.

#### Assumption

The SSL certificate can be exported (see the “[Importing SSL Certificates](#)” section on page 11-7).



**Note** You can export an SSL certificate in Building Blocks (Config > Global > All Building Blocks); SSL certificate export is available only in virtual context configuration.

---

#### Procedure

---

- Step 1** To configure a virtual context, choose **Config > Devices > context > SSL > Certificates**.  
The Certificates table appears, listing any valid SSL certificates.  
The cisco-sample-cert certificate is included in the list only for the ACE module A2(3.0), ACE appliance 4(1.0), and later releases of either device type. For information about this sample certificate, see the “[Using SSL Certificates](#)” section on page 11-5.
- Step 2** In the Certificates table, choose the certificate you want to export, and click **Export**.  
The Export dialog box appears.

**Step 3** In the Export dialog box, enter the information in [Table 11-7](#).

**Table 11-7** *SSL Certificate Export Attributes*

| Field            | Description                                                                                                                                                                                                                                                                                                                                                                                                                                                                                                                                                                                                                                                                    |
|------------------|--------------------------------------------------------------------------------------------------------------------------------------------------------------------------------------------------------------------------------------------------------------------------------------------------------------------------------------------------------------------------------------------------------------------------------------------------------------------------------------------------------------------------------------------------------------------------------------------------------------------------------------------------------------------------------|
| Protocol         | Method to be used for exporting the SSL certificate: <ul style="list-style-type: none"> <li>• <b>FTP</b>—FTP is to be used to access the network server when exporting the SSL certificate.</li> <li>• <b>SFTP</b>—SFTP is to be used to access the network server when exporting the SSL certificate.</li> <li>• <b>TERMINAL</b>—You will export the certificate using cut and paste by pasting the certificate and key pair information to the terminal display. You can use the terminal method to display only PEM files, which are in ASCII format.</li> <li>• <b>TFTP</b>—TFTP is to be used to access the network server when exporting the SSL certificate.</li> </ul> |
| IP Address       | Field that appears for FTP, TFTP, and SFTP. Enter the IP address of the remote server to which the SSL certificate file is to be exported.                                                                                                                                                                                                                                                                                                                                                                                                                                                                                                                                     |
| Remote File Name | Field that appears for FTP, TFTP, and SFTP. Enter the directory and filename to be used for the SSL certificate file on the remote network server.                                                                                                                                                                                                                                                                                                                                                                                                                                                                                                                             |
| User Name        | Field that appears for FTP and SFTP. Enter the name of the user account on the remote network server.                                                                                                                                                                                                                                                                                                                                                                                                                                                                                                                                                                          |
| Password         | Field that appears for FTP and SFTP. Enter the password for the user account on the remote network server.                                                                                                                                                                                                                                                                                                                                                                                                                                                                                                                                                                     |
| Confirm          | Field that appears for FTP and SFTP. Reenter the password.                                                                                                                                                                                                                                                                                                                                                                                                                                                                                                                                                                                                                     |

**Step 4** Do one of the following:

- Click **OK** to export the certificate and to return to the Certificates table.
- Click **Cancel** to exit this procedure without exporting the certificate and to return to the Certificates table.

#### Related Topics

- [Configuring SSL, page 11-1](#)
- [Importing SSL Certificates, page 11-7](#)
- [Importing SSL Key Pairs, page 11-11](#)
- [Generating SSL Key Pairs, page 11-14](#)
- [Configuring SSL Chain Group Parameters, page 11-23](#)
- [Configuring SSL CSR Parameters, page 11-24](#)
- [Configuring SSL Proxy Service, page 11-27](#)

## Exporting SSL Key Pairs

You can export SSL key pairs from the ACE to a remote server. The ability to export SSL key pairs allows you copy SSL key pair files to another server on your network so that you can then import them onto another ACE or Web server. Exporting key pair files is similar to copying in that the original key pairs are not deleted.

**Assumption**

The SSL key pair can be exported (see the “[Generating SSL Key Pairs](#)” section on page 11-14).

**Procedure**

**Step 1** Choose the item to configure:

- To configure a virtual context, choose **Config > Devices > context > SSL > Keys**.
- To configure a building block, choose **Config > Global > building\_block > SSL > Keys**.

The Keys table appears. For the ACE module A2(3.0) and later releases only, the `cisco-sample-key` key pair is included in the list. For information about this sample key pair, see the “[Using SSL Certificates](#)” section on page 11-5.

**Step 2** In the Keys table, choose the key entry you want to export, and click **Export**.

The Export dialog box appears.

**Step 3** In the Export dialog box, enter the information in [Table 11-8](#).

**Table 11-8** *SSL Key Export Attributes*

| Field            | Description                                                                                                                                                                                                                                                                                                                                                                                                                                                                                                                                                                                                                                                 |
|------------------|-------------------------------------------------------------------------------------------------------------------------------------------------------------------------------------------------------------------------------------------------------------------------------------------------------------------------------------------------------------------------------------------------------------------------------------------------------------------------------------------------------------------------------------------------------------------------------------------------------------------------------------------------------------|
| Protocol         | Specify the method to be used for exporting the SSL key pair: <ul style="list-style-type: none"> <li>• <b>FTP</b>—FTP is to be used to access the network server when exporting the SSL key pair.</li> <li>• <b>SFTP</b>—SFTP is to be used to access the network server when exporting the SSL key pair.</li> <li>• <b>TERMINAL</b>—You will export the key pair using cut and paste by pasting the key pair information to the terminal display. You can use the terminal method to display only PEM files, which are in ASCII format.</li> <li>• <b>TFTP</b>—TFTP is to be used to access the network server when exporting the SSL key pair.</li> </ul> |
| IP Address       | Field that appears for FTP, TFTP, and SFTP. Enter the IP address of the remote server to which the SSL key pair is to be exported.                                                                                                                                                                                                                                                                                                                                                                                                                                                                                                                          |
| Remote File Name | Field that appears for FTP, TFTP, and SFTP. Enter the directory and filename to be used for the SSL key pair file on the remote network server.                                                                                                                                                                                                                                                                                                                                                                                                                                                                                                             |
| User Name        | Field that appears for FTP and SFTP. Enter the name of the user account on the remote network server.                                                                                                                                                                                                                                                                                                                                                                                                                                                                                                                                                       |
| Password         | Field that appears for FTP and SFTP. Enter the password for the user account on the remote network server.                                                                                                                                                                                                                                                                                                                                                                                                                                                                                                                                                  |
| Confirm          | Field that appears for FTP and SFTP. Reenter the password.                                                                                                                                                                                                                                                                                                                                                                                                                                                                                                                                                                                                  |

**Step 4** Do one of the following:

- Click **OK** to export the key pair and to return to the Keys table.
- Click **Cancel** to exit this procedure without exporting the key pair and to return to the Keys table.

**Related Topics**

- [Configuring SSL, page 11-1](#)
- [Importing SSL Certificates, page 11-7](#)

- [Importing SSL Key Pairs, page 11-11](#)
- [Generating SSL Key Pairs, page 11-14](#)
- [Configuring SSL Chain Group Parameters, page 11-23](#)
- [Configuring SSL CSR Parameters, page 11-24](#)
- [Configuring SSL Proxy Service, page 11-27](#)

## Configuring SSL Parameter Maps

You can create SSL parameter maps., which defines the SSL session parameters that the ACE applies to an SSL proxy service. SSL parameter maps let you apply the same SSL session parameters to different proxy services.

### Procedure

- 
- Step 1** Choose the item to configure:
- To configure a virtual context, choose **Config > Devices > context > SSL > Parameter Map**.
  - To configure a building block, choose **Config > Global > building\_block > SSL > Parameter Map**.
- The Parameter Map table appears.
- Step 2** In the Parameter Map table, click **Add** to add a new SSL parameter map, or choose an existing entry to modify and click **Edit**.
- The Parameter Map configuration window appears.
- Step 3** In the Parameter Map configuration window, enter the information in [Table 11-9](#).

**Table 11-9** *SSL Parameter Map Attributes*

| Field                              | Description                                                                                                                                                                                                                                                                                                                                                                                                                                                                                                                                    |
|------------------------------------|------------------------------------------------------------------------------------------------------------------------------------------------------------------------------------------------------------------------------------------------------------------------------------------------------------------------------------------------------------------------------------------------------------------------------------------------------------------------------------------------------------------------------------------------|
| Name                               | Unique name for the parameter map. Valid entries are alphanumeric strings with a maximum of 64 characters.                                                                                                                                                                                                                                                                                                                                                                                                                                     |
| Description                        | Field that appears for ACE module A2(1.5), ACE appliance A3(2.3), and later releases of either device type. If you attempt to use the Description feature with an ACE that is running an earlier software version, ANM displays an invalid command detected error message and does not deploy the parameter map.<br><br>Brief description of the parameter map. Enter a text string with a maximum of 240 alphanumeric characters (A–Z, a–z, 0–9). Spaces and special characters are allowed. Double quotes must be entered as matching pairs. |
| Queue Delay Timeout (Milliseconds) | Time (in milliseconds) to wait before emptying the queued data for encryption. Valid entries are 0 to 10000 milliseconds. If disabled (set to 0), the ACE encrypts the data from the server as soon as it arrives and then sends the encrypted data to the client.<br><br><b>Note</b> The Queue Delay Timeout is only applied to data that the SSL module sends to the client. This avoids a potentially long delay in passing a small HTTP GET to the real server.                                                                            |

Table 11-9 SSL Parameter Map Attributes (continued)

| Field                                | Description                                                                                                                                                                                                                                                                                                                                                                                                                                                                                                                                                                                                                                                                                                                                                                                                                                                                                                                                                         |
|--------------------------------------|---------------------------------------------------------------------------------------------------------------------------------------------------------------------------------------------------------------------------------------------------------------------------------------------------------------------------------------------------------------------------------------------------------------------------------------------------------------------------------------------------------------------------------------------------------------------------------------------------------------------------------------------------------------------------------------------------------------------------------------------------------------------------------------------------------------------------------------------------------------------------------------------------------------------------------------------------------------------|
| Session Cache Timeout (Milliseconds) | <p>Timeout value of an SSL session ID to remain valid before the ACE requires the full SSL handshake to establish a new SSL session. This feature allows the ACE to reuse the master key on subsequent connections with the client, which can speed up the SSL negotiation process.</p> <p>Valid entries are 0 to 72000 milliseconds. Specifying a value of 0 causes the ACE to implement a least recently used (LRU) timeout policy. By disabling this option (with the <b>no</b> command), the full SSL handshake occurs for each new connection with the ACE module.</p>                                                                                                                                                                                                                                                                                                                                                                                         |
| Reject Expired CRL Certificates      | <p>Check box that instructs the ACE to reject any certificates listed on an expired CRL.</p> <p>Uncheck the check box to instruct the ACE to accept certificates listed on an expired CRL, which is the default setting.</p>                                                                                                                                                                                                                                                                                                                                                                                                                                                                                                                                                                                                                                                                                                                                        |
| Close Protocol Behavior              | <p>Method that the ACE uses to close the SSL connection:</p> <ul style="list-style-type: none"> <li>• <b>Disabled</b>—The ACE sends a close-notify alert message to the SSL peer; however, the SSL peer does not expect a close-notify alert before removing the session. Whether the SSL peer sends a close-notify alert message or not, the session information is preserved, allowing session resumption for future SSL connections.</li> <li>• <b>None</b>—The ACE does not send a close-notify alert message to the SSL peer, nor does the ACE expect a close-notify alert message from the peer. The ACE preserves the session information so that SSL resumption can be used for future SSL connections. This is the default.</li> </ul> <p><b>Note</b> Where ACE 1.0 is already configured with the Strict option, ANM interprets it as the option None. This is due to the change in ACE 1.0 configuration (which no longer allows the Strict option).</p> |
| SSL Version                          | <p>Version of SSL to be used during SSL communications:</p> <ul style="list-style-type: none"> <li>• <b>All</b>—The ACE uses both SSL v3 and TLS v1 in its communications with its SSL peer.</li> <li>• <b>SSL3</b>—The ACE uses only SSL v3 in its communications with its SSL peer.</li> <li>• <b>TLS1</b>—The ACE uses only TLS v1 in its communications with its SSL peer.</li> </ul>                                                                                                                                                                                                                                                                                                                                                                                                                                                                                                                                                                           |

**Table 11-9** *SSL Parameter Map Attributes (continued)*

| Field                         | Description                                                                                                                                                                                                                                                                                                                                                                                                                                                                                                                                                                                                                                                                                                                                                                                                                                                                                                                                                                                                                                                                                                                                                                                                                                                                                                                                                                                                                                                                                                                                                                                                                                                                         |
|-------------------------------|-------------------------------------------------------------------------------------------------------------------------------------------------------------------------------------------------------------------------------------------------------------------------------------------------------------------------------------------------------------------------------------------------------------------------------------------------------------------------------------------------------------------------------------------------------------------------------------------------------------------------------------------------------------------------------------------------------------------------------------------------------------------------------------------------------------------------------------------------------------------------------------------------------------------------------------------------------------------------------------------------------------------------------------------------------------------------------------------------------------------------------------------------------------------------------------------------------------------------------------------------------------------------------------------------------------------------------------------------------------------------------------------------------------------------------------------------------------------------------------------------------------------------------------------------------------------------------------------------------------------------------------------------------------------------------------|
| Ignore Authentication Failure | <p>Option that enables the ACE to ignore expired or invalid SSL certificates and continue setting up the connection as follows:</p> <ul style="list-style-type: none"> <li>• ACE module versions 3.0(0)A2(1.1) forward and ACE appliance version A3(1.0) only—If checked, this feature enables the ACE to ignore expired or invalid server certificates and to continue setting up the back-end connection in an SSL initiation configuration. This option allows the ACE to ignore the following nonfatal errors with respect to server certificates: <ul style="list-style-type: none"> <li>– Certificate not yet valid</li> <li>– Certificate has expired</li> <li>– Certificate revoked</li> <li>– Unknown issuer</li> </ul> </li> <li>• ACE module version A2(3.0) and later only—If checked, this feature enables the ACE to ignore expired or invalid client or server certificates and to continue setting up the SSL connection. This options allows the ACE to ignore the following nonfatal errors with respect to either client certificates for SSL termination configurations, or server certificates for SSL initiation configurations: <ul style="list-style-type: none"> <li>– Certificate not yet valid (both)</li> <li>– Certificate has expired (both)</li> <li>– Certificate revoked (both)</li> <li>– Unknown issuer (both)</li> <li>– No client certificate (client certificate only)</li> <li>– CRL not available (client certificate only)</li> <li>– CRL has expired (client certificate only)</li> <li>– Certificate has signature failure (client certificate only)</li> <li>– Certificate other error (client certificate only)</li> </ul> </li> </ul> |

**Step 4** Click the **Parameter Map Cipher** tab and click **Add** to add a cipher, or choose an existing cipher and click **Edit**.

Enter the information in [Table 11-10](#).

**Table 11-10** *SSL Parameter Map Cipher Configuration Attributes*

| Field           | Description                                                                                                                                                                                                                                                                                                                                     |
|-----------------|-------------------------------------------------------------------------------------------------------------------------------------------------------------------------------------------------------------------------------------------------------------------------------------------------------------------------------------------------|
| Cipher Name     | <p>Cipher to use.</p> <p>For more information on the SSL cipher suites that ACE supports, see the <i>Cisco 4700 Series Application Control Engine Appliance SSL Configuration Guide</i> or the <i>Cisco Application Control Engine Module SSL Configuration Guide</i>.</p>                                                                      |
| Cipher Priority | <p>Priority that you want to assign to this cipher suite. The priority indicates the cipher's preference for use.</p> <p>Valid entries are from 1 to 10 with 1 indicating the least preferred and 10 indicating the most preferred. When determining which cipher suite to use, the ACE chooses the cipher suite with the highest priority.</p> |



- Step 5** In the Parameter Map Cipher table, do one of the following:
- Click **Deploy Now** to deploy the Parameter Map Cipher on the ACE and save your entries to the running-configuration and startup-configuration files
  - Click **Cancel** to exit the procedure without saving your entries and to return to the Parameter Map Cipher table.
  - Click **Next** to deploy your entries and to add another entry to the Parameter Map Cipher table.
- Step 6** Click the **Redirect Authentication Failure** tab and click **Add** to add a redirect or choose an existing redirect, and click **Edit**.



**Note** This option is available only for the ACE module A2(3.0), ACE appliance A4(1.0), and later releases of either device type.

Enter the information in [Table 11-11](#).



**Note** The Redirect Authentication Failure feature is only for SSL termination configurations in which the ACE performs client authentication. The ACE ignores these attributes if you configure them for an SSL initiation configuration.

**Table 11-11** *SSL Parameter Map Redirect Configuration Attributes*

| Field                         | Description                                                                                                                                                                                                                                                                                                                                                                                                                                                                                                                                                                                                                                                                                                                                                                                                                                                                                                                                                                                                                                                                                                                                                                                                                                                                                                                                                                                                                                                                |
|-------------------------------|----------------------------------------------------------------------------------------------------------------------------------------------------------------------------------------------------------------------------------------------------------------------------------------------------------------------------------------------------------------------------------------------------------------------------------------------------------------------------------------------------------------------------------------------------------------------------------------------------------------------------------------------------------------------------------------------------------------------------------------------------------------------------------------------------------------------------------------------------------------------------------------------------------------------------------------------------------------------------------------------------------------------------------------------------------------------------------------------------------------------------------------------------------------------------------------------------------------------------------------------------------------------------------------------------------------------------------------------------------------------------------------------------------------------------------------------------------------------------|
| Client Certificate Validation | Type of certificate validation failure to redirect. From the drop-down list, choose the type to redirect: <ul style="list-style-type: none"> <li>• <b>Any</b>—Associates any of the certificate failures with the redirect. You can configure the authentication-failure redirect any command with individual reasons for redirection. When you do, the ACE attempts to match one of the individual reasons before using the any reason. You cannot configure the authentication-failure redirect any command with the authentication-failure ignore command.</li> <li>• <b>Cert-expired</b>—Associates an expired certificate failure with a redirect.</li> <li>• <b>Cert-has-signature-failure</b>—Associates a certificate signature failure with a redirect.</li> <li>• <b>Cert-not-yet-valid</b>—Associates a certificate that is not yet valid failure with the redirect.</li> <li>• <b>Cert-other-error</b>—Associates a all other certificate failures with a redirect.</li> <li>• <b>Cert-revoked</b>—Associates a revoked certificate failure with a redirect.</li> <li>• <b>CRL-has-expired</b>—Associates an expired CRL failure with a redirect.</li> <li>• <b>CRL-not-available</b>—Associates a CRL that is not available failure with a redirect.</li> <li>• <b>No-client-cert</b>—Associates no client certificate failure with a redirect.</li> <li>• <b>Unknown-issuer</b>—Associates an unknown issuer certificate failure with a redirect.</li> </ul> |
| Redirect Type                 | Redirect type to use: <ul style="list-style-type: none"> <li>• <b>Server Farm</b>—Specifies a redirect server farm for the redirect.</li> <li>• <b>URL</b>—Specifies a static URL path for the redirect.</li> </ul>                                                                                                                                                                                                                                                                                                                                                                                                                                                                                                                                                                                                                                                                                                                                                                                                                                                                                                                                                                                                                                                                                                                                                                                                                                                        |

**Table 11-11** SSL Parameter Map Redirect Configuration Attributes

| Field            | Description                                                                                                                                                                                                                                                                                                                                                                                                                                                                                                                                                                                                                                                          |
|------------------|----------------------------------------------------------------------------------------------------------------------------------------------------------------------------------------------------------------------------------------------------------------------------------------------------------------------------------------------------------------------------------------------------------------------------------------------------------------------------------------------------------------------------------------------------------------------------------------------------------------------------------------------------------------------|
| Server Farm Name | <p>Field that appears when the <a href="#">Redirect Type</a> is set to Server Farm. ANM displays the available server farms as follows:</p> <ul style="list-style-type: none"> <li>• ACE software Version A4(1.0) or later—ANM displays all configured host and redirect server farms.</li> <li>• All earlier ACE software versions—ANM displays only those server farms configured as redirect server farms.</li> </ul> <p>Choose one of the available server farm options or click <b>Plus (+)</b> to open the server farm configuration popup and configure a redirect server farm (see the <a href="#">“Configuring Server Farms” section on page 8-30</a>).</p> |
| Redirect URL     | Field that appears when the Redirect Type is set to URL. Specifies the static URL path for the redirect. Enter a string with a maximum of 255 characters and no spaces.                                                                                                                                                                                                                                                                                                                                                                                                                                                                                              |
| Redirect Code    | <p>Field appears when the Redirect Type is set to URL.</p> <p>Enter the redirect code that is sent back to the client:</p> <ul style="list-style-type: none"> <li>• <b>301</b>—Status code for a resource permanently moving to a new location.</li> <li>• <b>302</b>—Status code for a resource temporarily moving to a new location.</li> </ul>                                                                                                                                                                                                                                                                                                                    |

- Step 7** In the Redirect Authentication Failure table, do one of the following:
- Click **Deploy Now** to deploy the Redirect Authentication Failure table on the ACE and save your entries to the running-configuration and startup-configuration files.
  - Click **Cancel** to exit the procedure without saving your entries and to return to the Redirect Authentication Failure table.
  - Click **Next** to deploy your entries and to add another entry to the Redirect Authentication Failure table.

- Step 8** In the Parameter Map table, do one of the following:
- Click **Deploy Now** to deploy this configuration on the ACE and save your entries to the running-configuration and startup-configuration files.
  - Click **Cancel** to exit the procedure without saving your entries and to return to the Parameter Map table.
  - Click **Next** to deploy your entries and to add another entry to the Parameter Map table.

#### Related Topics

- [Configuring SSL, page 11-1](#)
- [Importing SSL Certificates, page 11-7](#)
- [Importing SSL Key Pairs, page 11-11](#)
- [Generating SSL Key Pairs, page 11-14](#)
- [Configuring SSL Chain Group Parameters, page 11-23](#)
- [Configuring SSL CSR Parameters, page 11-24](#)
- [Configuring SSL Proxy Service, page 11-27](#)

# Configuring SSL Chain Group Parameters

You can configure certificate chain groups for a virtual context. A chain group specifies the *certificate chains* that the ACE sends to its peer during the handshake process. A certificate chain is a hierarchal list of certificates that includes the ACE's certificate, the root certificate authority certificate, and any intermediate certificate authority certificates. Using the information provided in a certificate chain, the certificate verifier searches for a trusted authority in the certificate hierarchal list up to and including the root certificate authority. If the verifier finds a trusted authority before reaching the root certificate authority certificate, it stops searching further.

## Assumption

At least one SSL certificate is available.

## Procedure

- 
- Step 1** Choose **Config > Devices > context > SSL > Chain Group Parameters**.  
The Chain Group Parameters table appears.
- Step 2** In the Chain Group Parameters table, click **Add** to add a new chain group, or choose an existing chain group, and click **Edit** to modify it.  
The Chain Group Parameters configuration window appears.
- Step 3** In the Name field of the Chain Group Parameters configuration window, enter a unique name for the chain group.  
Valid entries are alphanumeric strings with a maximum of 64 characters.
- Step 4** Do one of the following:
- Click **Deploy Now** to deploy this configuration on the ACE and save your entries to the running-configuration and startup-configuration files. The updated Chain Group Parameters window appears along with the Chain Group Certificates table. Continue with [Step 5](#).
  - Click **Cancel** to exit the procedure without saving your entries and to return to the Chain Group Parameters table.
  - Click **Next** to deploy your entries and to add another entry to the Chain Group Parameters table.
- Step 5** In the Chain Group Certificates table, click **Add** to add an entry.  
The Chain Group Certificates configuration window appears.
-  **Note** You cannot modify an existing entry in the Chain Group Certificates table. Instead, delete the entry, then add a new one.
- 
- Step 6** In the Certificate Name field, choose the certificate to add to this chain group.
- Step 7** Do one of the following:
- Click **Deploy Now** to deploy this configuration on the ACE and save your entries to the running-configuration and startup-configuration files.

- Click **Cancel** to exit the procedure without saving your entries and to return to the Chain Group Certificates table.
- Click **Next** to deploy your entries and to add another certificate to this chain group table.

---

### Related Topics

- [Configuring SSL, page 11-1](#)
- [Importing SSL Certificates, page 11-7](#)
- [Importing SSL Key Pairs, page 11-11](#)
- [Generating SSL Key Pairs, page 11-14](#)
- [Configuring SSL Parameter Maps, page 11-18](#)
- [Configuring SSL CSR Parameters, page 11-24](#)
- [Configuring SSL Proxy Service, page 11-27](#)

## Configuring SSL CSR Parameters

A *certificate signing request* (CSR) is a message you send to a certificate authority such as VeriSign and Thawte to apply for a digital identity certificate. The CSR contains information that identifies the SSL site, such as location and a serial number, and a public key that you choose. A corresponding private key is not included in the CSR, but is used to digitally sign the request. The CSR may be accompanied by other credentials or proofs of identity required by the certificate authority, and the certificate authority may contact the applicant for more information.

If the request is successful, the certificate authority returns a digitally signed (with the private key of the certificate authority) identity certificate.

CSR parameters define the *distinguished name* attributes the ACE applies to the CSR during the CSR-generating process. These attributes provide the certificate authority with the information it needs to authenticate your site. Defining a CSR parameter set lets you to generate multiple CSRs with the same distinguished name attributes.

Each context on the ACE can contain up to eight CSR parameter sets.

Use this procedure to define the distinguished name attributes for SSL CSRs.

### Procedure

---

**Step 1** Choose the item to configure:

- To configure a virtual context, choose **Config > Devices > context > SSL > CSR Parameters**.
- To configure a building block, choose **Config > Global > building\_block > SSL > CSR Parameters**.

The CSR Parameters table appears.

**Step 2** In the CSR Parameters table, click **Add** to add new set of CSR attributes, or choose an existing entry to modify and click **Edit**.

The CSR Parameters configuration window appears.

**Step 3** In the CSR Parameters configuration window, enter the information in [Table 11-12](#).

**Table 11-12** *SSL CSR Parameter Attributes*

| Field             | Description                                                                                                                                                                                                                                                                                                                                |
|-------------------|--------------------------------------------------------------------------------------------------------------------------------------------------------------------------------------------------------------------------------------------------------------------------------------------------------------------------------------------|
| Name              | Unique name for this parameter set. Valid entries are alphanumeric strings with a maximum of 64 characters.                                                                                                                                                                                                                                |
| Country           | Name of the country where the SSL site resides. Valid entries are 2 alphabetic characters representing the country, such as <i>US</i> for the United States. The International Organization for Standardization (ISO) maintains the complete list of valid country codes on its Web site ( <a href="http://www.iso.org">www.iso.org</a> ). |
| State             | Name of the state or province where the SSL site resides.                                                                                                                                                                                                                                                                                  |
| Locality          | Name of the city where the SSL site resides.                                                                                                                                                                                                                                                                                               |
| Common Name       | Name of the domain or host of the SSL site. Valid entries are strings with a maximum of 64 characters. Special characters are allowed.                                                                                                                                                                                                     |
| Serial Number     | Serial number to assign to the certificate. Valid entries are alphanumeric strings with a maximum of 16 characters.                                                                                                                                                                                                                        |
| Organization Name | Name of the organization to include in the certificate. Valid entries are alphanumeric strings with a maximum of 64 characters.                                                                                                                                                                                                            |
| Email             | Site email address. Valid entries are text strings, including alphanumeric and special characters (for example, @ symbol in email address) with a maximum of 40 characters.                                                                                                                                                                |
| Organization Unit | Name of the organization to include in the certificate. Valid entries are alphanumeric strings with a maximum of 64 characters.                                                                                                                                                                                                            |

**Step 4** Do one of the following:

- Click **Deploy Now** to deploy this configuration on the ACE and save your entries to the running-configuration and startup-configuration files.
- Click **Cancel** to exit this procedure without saving your entries and to return to the CSR Parameters table.
- Click **Next** to deploy your entries and to define another set of CSR attributes.

#### Related Topics

- [Configuring SSL, page 11-1](#)
- [Importing SSL Certificates, page 11-7](#)
- [Importing SSL Key Pairs, page 11-11](#)
- [Configuring SSL Parameter Maps, page 11-18](#)
- [Configuring SSL Chain Group Parameters, page 11-23](#)
- [Configuring SSL Proxy Service, page 11-27](#)

## Generating CSRs

You can generate an SSL *certificate signing request* (CSR), which is a message that you send to a certificate authority such as VeriSign and Thawte to apply for a digital identity certificate. Create a CSR when you need to apply for a certificate from a certificate authority. When the certificate authority approves a request, it signs the CSR and returns the authorized digital certificate to you. This certificate includes the private key of the certificate authority. When you receive the authorized certificate and key pair, you can import them for use (see the “[Importing SSL Certificates](#)” section on page 11-7 and the “[Importing SSL Key Pairs](#)” section on page 11-11).

**Note**

You cannot generate a CSR in Building Blocks (Config > Global > All Building Blocks); SSL CSR generation is available only in virtual context configuration.

**Assumption**

You have configured SSL CSR parameters (see the “[Configuring SSL CSR Parameters](#)” section on page 11-24).

**Procedure**

- 
- Step 1** Choose **Config > Devices > context > SSL > Keys**.
- The Keys table appears.
- Step 2** In the Keys table, choose a key and click **Generate CSR**.
- The Generate a Certificate Signing Request dialog box appears.
- Step 3** In the CSR Parameter field of the Generate a Certificate Signing Request dialog box, choose the CSR parameter to be used.
- Step 4** Do one of the following:
- Click **OK** to generate the CSR. The CSR appears in a popup window which you can now submit to a certificate authority for approval. Work with your certificate authority to determine the method of submission, such as email or a Web-based application. Click **Close** to close the popup window and to return to the Keys table.
  - Click **Cancel** to exit this procedure without generating the CSR and to return to the Keys table.
- 

**Related Topics**

- [Configuring SSL, page 11-1](#)
- [Importing SSL Certificates, page 11-7](#)
- [Importing SSL Key Pairs, page 11-11](#)
- [Configuring SSL Parameter Maps, page 11-18](#)
- [Configuring SSL Chain Group Parameters, page 11-23](#)
- [Configuring SSL Proxy Service, page 11-27](#)

# Configuring SSL Proxy Service

You can configure an SSL proxy service that defines the SSL parameter map, key pair, certificate, and chain group the ACE uses during SSL handshakes. By configuring an SSL proxy *server* service on the ACE, the ACE can act as an SSL server.

## Assumption

You have configured at least one SSL key pair, certificate, chain group, or parameter map to apply to this proxy service.

## Procedure

- 
- Step 1** Choose **Config > Devices > context > SSL > Proxy Service**.  
The Proxy Service table appears.
- Step 2** In the Proxy Service table, click **Add** to add a new proxy service, or choose an existing service and click **Edit** to modify it.  
The Proxy Service configuration window appears.
- Step 3** In the Proxy Service configuration window, enter the information in [Table 11-13](#).

**Table 11-13** SSL Proxy Service Attributes



| Field              | Description                                                                                                                                                                                                                                                                                                                                                                                                                                                                                                                                                                                                                                                                                                                                                                                                                                                                                                                                                                                                                                                                                                                                                                                                                                                       |
|--------------------|-------------------------------------------------------------------------------------------------------------------------------------------------------------------------------------------------------------------------------------------------------------------------------------------------------------------------------------------------------------------------------------------------------------------------------------------------------------------------------------------------------------------------------------------------------------------------------------------------------------------------------------------------------------------------------------------------------------------------------------------------------------------------------------------------------------------------------------------------------------------------------------------------------------------------------------------------------------------------------------------------------------------------------------------------------------------------------------------------------------------------------------------------------------------------------------------------------------------------------------------------------------------|
| Proxy Service Name | Unique name for this proxy service. Valid entries are alphanumeric strings with a maximum of 40 to 65 characters, depending on your ACE and hardware version.                                                                                                                                                                                                                                                                                                                                                                                                                                                                                                                                                                                                                                                                                                                                                                                                                                                                                                                                                                                                                                                                                                     |
| Keys               | <p>Key pair that the ACE is to use during the SSL handshake for data encryption.</p> <p> <b>Caution</b> When choosing the key pair from the drop-down list, be sure to choose the keys that correspond to the certificate that you choose.</p> <p> <b>Note</b> If you use SSL Setup Sequence to create the proxy service, ANM selects the keys that correspond to the certificate that you choose. If ANM cannot detect a corresponding key pair, you can select a key pair from the drop-down list and click <b>Verify Key</b> to have ANM verify that the keys correspond to the selected certificate. ANM displays a message to let you know that your key pair selection either matches or does not match the selected certificate. For more information about SSL Setup Sequence, see the <a href="#">“SSL Setup Sequence” section on page 11-4</a>.</p> <p>The <b>cisco-sample-key</b> option is available for the ACE module A2(3.0) and later releases only. For information about this sample key pair, see the <a href="#">“Using SSL Certificates” section on page 11-5</a>.</p> |

Table 11-13 SSL Proxy Service Attributes (continued)



| Field            | Description                                                                                                                                                                                                                                                                                                                                                                                                                                                                                                                                                                                                                                                                                                                                                                                                                                                                                                                                                                                                                                                                                                                                                                                                                                                                                                              |
|------------------|--------------------------------------------------------------------------------------------------------------------------------------------------------------------------------------------------------------------------------------------------------------------------------------------------------------------------------------------------------------------------------------------------------------------------------------------------------------------------------------------------------------------------------------------------------------------------------------------------------------------------------------------------------------------------------------------------------------------------------------------------------------------------------------------------------------------------------------------------------------------------------------------------------------------------------------------------------------------------------------------------------------------------------------------------------------------------------------------------------------------------------------------------------------------------------------------------------------------------------------------------------------------------------------------------------------------------|
| Certificates     | <p>Certificate that the ACE is to use during the SSL handshake to prove its identity.</p> <p> <b>Caution</b> When choosing the certificate from the drop-down list, be sure to choose the certificate that corresponds to the keys that you choose.</p> <p> <b>Note</b> If you use SSL Setup Sequence to create the proxy service, ANM selects the keys that correspond to the certificate that you choose. If ANM cannot detect a corresponding key pair, you can select a key pair from the drop-down list and click <b>Verify Key</b> to have ANM verify that the keys correspond to the selected certificate. ANM displays a message to let you know that your key pair selection either matches or does not match the selected certificate. For more information about SSL Setup Sequence, see the <a href="#">“SSL Setup Sequence” section on page 11-4</a>.</p> <p>The <b>cisco-sample-cert</b> option is available only for the ACE module A2(3.0), ACE appliance A4(1.0), and later releases of either device type. For information about this sample certificate, see the <a href="#">“Using SSL Certificates” section on page 11-5</a>.</p> |
| Chain Groups     | Chain group that the ACE is to use during the SSL handshake. To create a chain group, see the <a href="#">“Configuring SSL Chain Group Parameters” section on page 11-23</a> .                                                                                                                                                                                                                                                                                                                                                                                                                                                                                                                                                                                                                                                                                                                                                                                                                                                                                                                                                                                                                                                                                                                                           |
| Auth Groups      | Authorization group name that the ACE is to use during the SSL handshake. To create an authorization group, see the <a href="#">“Configuring SSL Authentication Groups” section on page 11-31</a> .                                                                                                                                                                                                                                                                                                                                                                                                                                                                                                                                                                                                                                                                                                                                                                                                                                                                                                                                                                                                                                                                                                                      |
| CRL Best-Effort  | Field that displays only when <a href="#">Auth Groups</a> is selected. Allows ANM to search client certificates for the service to determine if it contains a CRL in the extension. ANM then retrieves the value, if it exists.                                                                                                                                                                                                                                                                                                                                                                                                                                                                                                                                                                                                                                                                                                                                                                                                                                                                                                                                                                                                                                                                                          |
| CRL Name         | Field that displays only when <a href="#">Auth Groups</a> is selected. Do one of the following: <ul style="list-style-type: none"> <li>Choose <b>N/A</b> when the CRL name is not applicable.</li> <li>Choose the CRL name that the ACE used for authentication.</li> </ul>                                                                                                                                                                                                                                                                                                                                                                                                                                                                                                                                                                                                                                                                                                                                                                                                                                                                                                                                                                                                                                              |
| OCSP Best-Effort | Field that displays for ACE module or appliance software Version A5(1.0) or later, and when <a href="#">Auth Groups</a> is selected. Check the OCSP Best-Effort checkbox to allow the ACE appliance to extract the extension to find the OCSP server information from the certificate itself where, from the revocation status, information about the certificate could be obtained. If this extension is missing from the certificate and the best effort OCSP server information is configured with the SSL proxy, the cert is considered revoked.                                                                                                                                                                                                                                                                                                                                                                                                                                                                                                                                                                                                                                                                                                                                                                     |
| OCSP Servers     | Uncheck the checkbox to display the OCSP server field to choose the available OCSP server.                                                                                                                                                                                                                                                                                                                                                                                                                                                                                                                                                                                                                                                                                                                                                                                                                                                                                                                                                                                                                                                                                                                                                                                                                               |
| OCSP Servers     | Field that displays for ACE module or appliance software Version A5(1.0) or later, and when the <a href="#">OCSP Best-Effort</a> checkbox is unchecked. Choose the available OCSP server.                                                                                                                                                                                                                                                                                                                                                                                                                                                                                                                                                                                                                                                                                                                                                                                                                                                                                                                                                                                                                                                                                                                                |



Table 11-13 SSL Proxy Service Attributes (continued)

| Field                           | Description                                                                                                                                                                                                                                                                                                                                                                                                                                                                                                        |
|---------------------------------|--------------------------------------------------------------------------------------------------------------------------------------------------------------------------------------------------------------------------------------------------------------------------------------------------------------------------------------------------------------------------------------------------------------------------------------------------------------------------------------------------------------------|
| Parameter Maps                  | SSL parameter map to associate with this SSL proxy server service.                                                                                                                                                                                                                                                                                                                                                                                                                                                 |
| Revocation Check Priority Order | Field that displays for ACE module or appliance software Version A5(1.0) or later. Priority setting for the revocation check. Choose one of the following: <ul style="list-style-type: none"> <li>• <b>N/A</b>—Indicates that this field is not applicable.</li> <li>• <b>CRL-OCSP</b>—The ACE uses the CRLs first to determine the revocation status, and then the OCSP servers.</li> <li>• <b>OCSP-CRL</b>—The ACE uses the OCSP servers first to determine the revocation status, and then the CRLs.</li> </ul> |

**Step 4** Do one of the following:

- Click **Deploy Now** to deploy this configuration on the ACE and save your entries to the running-configuration and startup-configuration files.
- Click **Cancel** to exit this procedure without saving your entries and to return to the Proxy Service table.
- Click **Next** to deploy your entries and to add another proxy service.
- Click **Delete** to remove this configuration on the ACE.



**Note** When an authorization group is deleted, the CRL Name object (if it exists) is deleted automatically.

#### Related Topics

- [Configuring SSL, page 11-1](#)
- [Importing SSL Certificates, page 11-7](#)
- [Importing SSL Key Pairs, page 11-11](#)
- [Configuring SSL Parameter Maps, page 11-18](#)
- [Configuring SSL Chain Group Parameters, page 11-23](#)
- [Configuring SSL CSR Parameters, page 11-24](#)

## Configuring SSL OCSP Service



**Note** The SSL Online Certificate Status Protocol feature requires ACE module and ACE appliance software Version A5(1.0) or later.

SSL Online Certificate Status Protocol (OCSP) service defines the host server for certificate revocation checks using OCSP. The OCSP server, also known as the OCSP responder, maintains or obtains the information about the certificates issued by different CAs that are revoked and possibly non-revoked,

and provides this information when requested by OCSP clients. OCSP can provide latest information about the revocation status of the certificate. Use of OCSP removes the need to download and cache the CRLs which could be very large in sizes and impose large memory requirements on systems.

You can configure a maximum of 64 OCSP server configurations system-wide on the ACE. You can configure all of these servers in a single or multiple contexts.

Use this procedure to define the attributes that the ACE appliance is to use during SSL handshakes so that it can act as an SSL server.

### Assumption

Configure OCSP on an associated proxy service.

You can configure both OCSP and CRLs for authentication.

### Procedure

- 
- Step 1** Select **Config > Devices > context > SSL > OCSP Service**. The OCSP Service table appears.
- Step 2** Click **Add** to add a new OCSP service, or select an existing service, then click **Edit** to modify it. The OCSP Service configuration screen appears.
- Step 3** In the Name field, enter a unique name for this OCSP service. Valid entries are alphanumeric strings with a maximum of 64 characters. This name is used when you apply this configuration to an SSL proxy service.
- Step 4** In the URL field, enter an HTTP based URL for the OCSP host name and optional port ID in the form of `http://ocsp_hostname.com:port_id`. If you do not specify a port ID, the ACE uses the default value of 2560.
- Step 5** Optionally, in the Request Signer's Certificate field, you can select a filename for the signer certificate to sign the requests to the server. By default, the request is not signed.
- Step 6** Optionally, in the Response Signer's Certificate field, you can select a filename for the signer certificate to verify the signature on the server responses. By default, the responses are not verified.
- Step 7** Check the Enable Nonce check box to enable the inclusion of the nonce in the requests to the server. By default, nonce is disabled.
- Clear the checkbox to disable the inclusion of the nonce in requests to the server.
- Step 8** In the TCP Connection Inactivity Timeout field, enter an integer from 2 to 3600 to specify the TCP connection inactivity timeout in seconds. The default is 300 seconds.
- Step 9** Do one of the following:
- Click **Deploy Now** to deploy this configuration on the ACE appliance.
  - Click **Cancel** to exit this procedure without saving your entries and to return to the OCSP Service table.
  - Click **Next** to save your entries and to add another proxy service.
- 

### Related Topics

- [Configuring SSL, page 11-1](#)
- [Configuring SSL Proxy Service, page 11-27](#)

# Enabling Client Authentication

During the flow of a normal SSL handshake, the SSL server sends its certificate to the client. Then the client verifies the identity of the server through the certificate. However, the client does not send any identification of its own to the server. When you enable the client authentication feature on the ACE, it will require that the client send a certificate to the server. Then the server verifies the following information on the certificate:

- A recognized CA issued the certificate.
- The valid period of the certificate is still in effect.
- The certificate signature is valid and not tampered.
- The CA has not revoked the certificate.
- At least one SSL certificate is available.

Use the following procedures to enable or disable client authentication:

- [Configuring SSL Proxy Service, page 11-27](#)
- [Configuring SSL Authentication Groups, page 11-31](#)
- [Configuring CRLs for Client Authentication, page 11-33](#)

## Configuring SSL Authentication Groups

You can specify the certificate authentication groups that the ACE uses during the SSL handshake and enable client authentication on this SSL-proxy service. The ACE includes the certificates configured in the group along with the certificate that you specified for the SSL proxy service.

On the ACE, you can implement a group of certificates that are trusted as certificate signers by creating an authentication group. After creating the authentication group and assigning its certificates, then you can assign the authentication group to a proxy service in an SSL termination configuration to enable client authentication. For information on client authentication, see the [“Enabling Client Authentication” section on page 11-31](#).

For information on server authentication and assigning an authentication group, see the [“Configuring SSL Proxy Service” section on page 11-27](#).

**Note**

You cannot create an authorization group in Building Blocks (Config > Global > All Building Blocks); You can only create SSL authentication groups while configuring virtual contexts in specific modules.

**Assumptions**

- At least one SSL certificate is available.
- Your ACE supports authentication groups. See the *Supported Devices Table for Cisco Application Networking Manager* for details.

**Procedure**

- Step 1** Choose **Config > Devices > context > SSL > Auth Group Parameters**.  
The Auth Group Parameters table appears.

**Step 2** In the Auth Group Parameters table, click **Add** to add an authentication group, or choose an existing authorization group and click **Edit** to modify it.

The Auth Group Parameters configuration window appears.

**Step 3** In the Name field of the Auth Group Parameters configuration window, enter a unique name for the authorization group.

Valid entries are alphanumeric strings with a maximum of 64 characters.

**Step 4** Do one of the following:

- Click **Deploy Now** to deploy this configuration on the ACE and save your entries to the running-configuration and startup-configuration files. The updated Auth Group Parameters window appears along with the Auth Group Certificates table. Continue with [Step 5](#).
- Click **Cancel** to exit the procedure without saving your entries and to return to the Auth Group Parameters table.
- Click **Next** to deploy your entries and to add another entry to the Auth Group Parameters table.

**Step 5** In the Auth Group Certificate field, click **Add** to add an entry.

The Auth Group Certificates configuration window appears.



---

**Note** You cannot modify an existing entry in the Auth Group Certificates table. Instead, delete the entry, then add a new one.

---

**Step 6** In the Certificate Name field, choose the certificate to add to this authorization group.

**Step 7** Do one of the following:

- Click **Deploy Now** to deploy this configuration on the ACE and save your entries to the running-configuration and startup-configuration files.
- Click **Cancel** to exit the procedure without saving your entries and to return to the Auth Group Parameters table.
- Click **Next** to deploy your entries and to add another entry to the Auth Group Parameters table.

**Step 8** You can repeat the previous step to add more certificates to the authorization group or click **Deploy Now**.

**Step 9** After you configure authorization group parameters, you can configure the SSL proxy service to use a CRL. See the “[Configuring CRLs for Client Authentication](#)” section on page 11-33.



---

**Note** When you enable client authentication, a significant performance decrease may occur. Additional latency may occur when you configure CRL retrieval.

---

#### Related Topics

- [Configuring SSL Chain Group Parameters](#), page 11-23
- [Configuring CRLs for Client Authentication](#), page 11-33

## Configuring CRLs for Client Authentication

You can configure the ACE to scan for CRLs and retrieve them. By default, ACE does not use certificate revocation lists (CRLs) during client authentication. You can configure the SSL proxy service to use a CRL by having the ACE scan each client certificate for the service to determine if it contains a CRL in the extension and then retrieve the value, if it exists. For more information about SSL termination on the ACE, see either the *Cisco Application Control Engine Module SSL Configuration Guide* or the *Cisco ACE 4700 Series Appliance SSL Configuration Guide*.

**Note**

The ACE supports the creation of a maximum of eight CRLs for any context.

**Note**

When you enable client authentication, a significant performance decrease may occur. Additional latency may occur when you configure CRL retrieval.

**Assumption**

A CRL cannot be configured on an SSL proxy without first configuring an authorization group.

**Procedure**

- Step 1** Choose **Config > Devices > context > SSL > Certificate Revocation Lists (CRLs)**.  
The Certificate Revocation Lists (CRLs) table appears.
- Step 2** In the Certificate Revocation Lists (CRLs) table, click **Add** to add a CRL, or choose an existing CRL and click **Edit** to modify it.  
The Certificate Revocation Lists (CRLs) window appears.
- Step 3** In the Certificate Revocation Lists (CRLs) window, enter the information in [Table 11-14](#).

**Table 11-14** *SSL Certificate Revocation List*

| Field | Description                                                                                                                                                                                                         |
|-------|---------------------------------------------------------------------------------------------------------------------------------------------------------------------------------------------------------------------|
| Name  | CRL name. Valid entries are unquoted alphanumeric strings with a maximum of 64 characters.                                                                                                                          |
| URL   | URL where the ACE retrieves the CRL. Valid entries are unquoted alphanumeric strings with a maximum of 255 characters. Only HTTP URLs are supported. ACE checks the URL and displays an error if it does not match. |

- Step 4** Do one of the following:
- Click **Deploy Now** to deploy this configuration on the ACE and save your entries to the running-configuration and startup-configuration files. The updated Certificate Revocation Lists (CRLs) table appears.
  - Click **Cancel** to exit the procedure without saving your entries and to return to the Certificate Revocation Lists (CRLs) table.
  - Click **Next** to deploy your entries and to add another entry to the Certificate Revocation Lists (CRLs) table.

**Related Topics**

- [Configuring SSL Proxy Service, page 11-27](#)
- [Configuring SSL Authentication Groups, page 11-31](#)



# CHAPTER 12

## Configuring Network Access

---

**Date:** 3/28/12

This chapter describes how to configure network access using Cisco Application Networking Manager (ANM).



**Note**

---

When naming ACE objects (such as a real server, virtual server, parameter map, class map, health probe, and so on), enter an alphanumeric string of 1 to 64 characters, which can include the following special characters: underscore (\_), hyphen (-), dot (.), and asterisk (\*). Spaces are not allowed.

If you are using ANM with an ACE module or ACE appliance and you configure a named object at the ACE CLI, keep in mind that ANM does not support all of the special characters that the ACE CLI allows you to use when configuring a named object. If you use special characters that ANM does not support, you may not be able to import or manage the ACE using ANM.

---

This chapter includes the following sections:

- [Information About VLANs, page 12-2](#)
- [Configuring VLANs Using Cisco IOS Software \(ACE Module\), page 12-3](#)
- [Configuring Virtual Context VLAN Interfaces, page 12-6](#)
- [Configuring Virtual Context BVI Interfaces, page 12-19](#)
- [Configuring VLAN Interface NAT Pools, page 12-26](#)
- [Configuring Virtual Context Static Routes, page 12-28](#)
- [Configuring Global IP DHCP, page 12-29](#)
- [Configuring Static VLANs for Over 8000 Static NAT Configurations, page 12-31](#)
- [Configuring Gigabit Ethernet Interfaces on the ACE Appliance, page 12-32](#)
- [Configuring Port-Channel Interfaces for the ACE Appliance, page 12-35](#)

# Information About VLANs

This section provides an overview of how the ACE module and appliance use VLANs.

This section includes the following topics:

- [ACE Module VLANs, page 12-2](#)
- [ACE Appliance VLANs, page 12-2](#)

## ACE Module VLANs

The ACE module does not include any external physical interfaces to receive traffic from clients and servers. Instead, it uses internal VLAN interfaces. You assign VLANs from the supervisor engine to the ACE. After the VLANs are assigned to the ACE, you can configure the corresponding VLAN interfaces on the ACE as either routed or bridged for use. When you configure an IP address on an interface, the ACE automatically makes it a routed mode interface.

Similarly, when you configure a bridge group on an interface VLAN, the ACE automatically makes it a bridged interface. Then, you associate a bridge-group virtual interface (BVI) with the bridge group. For more information on bridged groups and BVIs, see the [“Configuring Virtual Context BVI Interfaces” section on page 12-19](#).

The ACE also supports shared VLANs, which are multiple interfaces in different contexts on the same VLAN within the same subnet. Only routed interfaces can share VLANs. Note that there is no routing across contexts even when shared VLANs are configured.

### Related Topics

- [Configuring VLANs Using Cisco IOS Software \(ACE Module\), page 12-3](#)
- [Configuring Virtual Context VLAN Interfaces, page 12-6](#)
- [Configuring Virtual Context BVI Interfaces, page 12-19](#)
- [Configuring Virtual Context Static Routes, page 12-28](#)
- [Configuring Global IP DHCP, page 12-29](#)

## ACE Appliance VLANs

The ACE appliance has four physical Ethernet interface ports. All VLANs are allocated to the physical ports. After the VLANs are assigned, you can configure the corresponding VLAN interfaces as either routed or bridged for use. When you configure an IP address on an interface, the ACE appliance automatically makes it a routed mode interface.

Similarly, when you configure a bridge group on an interface VLAN, the ACE appliance automatically makes it a bridged interface. Then, you associate a BVI with the bridge group.

The ACE appliance also supports shared VLANs, which are multiple interfaces in different contexts on the same VLAN within the same subnet. Only routed interfaces can share VLANs. Note that there is no routing across contexts even when shared VLANs are configured.

In routed mode, the ACE is considered a router hop in the network. In the Admin or user contexts, the ACE supports static routes only. The ACE supports up to eight equal cost routes for load balancing.



**Related Topics**

- [Configuring Virtual Context VLAN Interfaces, page 12-6](#)
- [Configuring Virtual Context BVI Interfaces, page 12-19](#)
- [Configuring Gigabit Ethernet Interfaces on the ACE Appliance, page 12-32](#)
- [Configuring Port-Channel Interfaces for the ACE Appliance, page 12-35](#)

## Configuring VLANs Using Cisco IOS Software (ACE Module)

To allow the ACE module to receive traffic from the supervisor engine in the Catalyst 6500 series switch or Cisco 7600 series router, you must create VLAN groups on the supervisor engine and then assign the groups to the ACE module. After the VLAN groups are assigned to the ACE module, you can configure the VLAN interfaces on the ACE module. By default, all VLANs are allocated to the Admin context on the ACE module.

This section includes the following topics:

- [Creating VLAN Groups Using Cisco IOS Software](#)
- [Assigning VLAN Groups to the ACE Module Through Cisco IOS Software](#)
- [Adding Switched Virtual Interfaces to the MSFC](#)

## Creating VLAN Groups Using Cisco IOS Software

In Cisco IOS software, you can create one or more VLAN groups and then assign the groups to the ACE module. For example, you can assign all the VLANs to one group, create an inside group and an outside group, or create a group for each customer.

You cannot assign the same VLAN to multiple groups; however, you can assign up to a maximum of 16 groups to an ACE. VLANs that you want to assign to multiple ACEs, for example, can reside in a separate group from VLANs that are unique to each ACE.

To assign VLANs to a group using Cisco IOS software on the supervisor engine, use the **svclc vlan-group** command. The syntax of this command is as follows:

```
svclc vlan-group group_number vlan_range
```

The arguments are as follows:

- *group\_number*—Number of the VLAN group.
- *vlan\_range*—One or more VLANs (2 to 1000 and 1025 to 4094) identified in one of the following ways:
  - A single number (*n*)
  - A range (*n-x*)

Separate numbers or ranges by commas, as shown in this example:

```
5,7-10,13,45-100
```

For example, to create three VLAN groups, 50 with a VLAN range of 55 to 57, 51 with a VLAN range of 75 to 86, and 52 with VLAN 100, enter:

```
Router(config)# svclc vlan-group 50 55-57
Router(config)# svclc vlan-group 51 70-86
```

```
Router(config)# svclc vlan-group 52 100
```

### Related Topics

- [Assigning VLAN Groups to the ACE Module Through Cisco IOS Software, page 12-4](#)
- [Adding Switched Virtual Interfaces to the MSFC, page 12-5](#)

## Assigning VLAN Groups to the ACE Module Through Cisco IOS Software

The ACE module cannot receive traffic from the supervisor engine unless you assign VLAN groups to it. To assign the VLAN groups to the ACE module using Cisco IOS software on the supervisor engine, use the **svc module** command in configuration mode. The syntax of this command is as follows:

```
svc module slot_number vlan-group group_number_range
```

The arguments are as follows:

- *slot\_number*—Slot number where the ACE module resides. To display slot numbers and the devices in the chassis, use the **show module** command in Exec mode. The ACE module appears as the Application Control Engine Module in the Card Type field.
- *group\_number\_range*—One or more group numbers that are identified in one of the following ways:
  - A single number (*n*)
  - A range (*n-x*)

Separate numbers or ranges by commas, as shown in this example:

```
5,7-10
```

For example, to assign VLAN groups 50 and 52 to the ACE module in slot 5, and VLAN groups 51 and 52 to the ACE module in slot 8, enter the following commands:

```
Router(config)# svc module 5 vlan-group 50,52
Router(config)# svc module 8 vlan-group 51,52
```

To view the group configuration for the ACE module and the associated VLANs, use the **show svclc vlan-group** command. For example, enter the following commands:

```
Router(config)# exit
Router# show svclc vlan-group
```

To view VLAN group numbers for all devices, use the **show svc module** command. For example, enter the following command:

```
Router# show svc module
```



### Note

Enter the **show vlans** command in Exec mode from the Admin context to display the ACE module VLANs that are downloaded from the supervisor engine.

### Related Topics

- [Creating VLAN Groups Using Cisco IOS Software, page 12-3](#)
- [Adding Switched Virtual Interfaces to the MSFC, page 12-5](#)

## Adding Switched Virtual Interfaces to the MSFC

A VLAN defined on the Multilayer Switch Feature Card (MSFC) is called a switched virtual interface (SVI). If you assign the VLAN used for the SVI to the ACE module, then the MSFC routes between the ACE module and other Layer 3 VLANs. By default, only one SVI can exist between the MSFC and the ACE. However, for multiple contexts, you may configure multiple SVIs for unique VLANs on each context.

### Procedure:

- 
- Step 1** (Optional) If you need to add more than one SVI to the ACE module, enter the following command:
- ```
Router(config)# svclc multiple-vlan-interfaces
```
- Step 2** Add a VLAN interface to the MSFC. For example, to add VLAN 55, enter the following command:
- ```
Router(config)# interface vlan 55
```
- Step 3** Set the IP address for this interface on the MSFC. For example, to set the address 10.1.1.1 255.255.255.0, enter the following command:
- ```
Router(config-if)# ip address 10.1.1.1 255.255.255.0
```
- Step 4** Enable the interface. For example, enter the following command:
- ```
Router(config-if)# no shut
```
- 



### Note

To monitor any VLAN that is associated with more than two trunk ports, physical ports, or trunk-physical ports on the supervisor engine, enable the autostate feature by using the **svclc autostate** command. When you associate a VLAN to these ports, autostate declares that the VLAN is up. When a VLAN state change occurs on the supervisor engine, autostate sends a notification to the ACE module to bring the interface up or down.

To view this SVI configuration, use the **show interface vlan** command. For example, enter the following command:

```
Router# show int vlan 55
```

### Related Topics

- [Creating VLAN Groups Using Cisco IOS Software, page 12-3](#)
- [Assigning VLAN Groups to the ACE Module Through Cisco IOS Software, page 12-4](#)

# Configuring Virtual Context VLAN Interfaces

You can configure VLAN interfaces for virtual contexts on the ACE.



## Note

The options that appear when you choose **Config > Devices > context** depend on the device associated with the virtual context and the role associated with your account.

## Assumptions

This topic assumes the following:

- A Layer 3/Layer 4 or Management policy map has been configured for this virtual context. For more information, see the “[Configuring Traffic Policies](#)” section on page 14-1.
- An access control list has been configured for this virtual context. Entering an ACL name does not configure the ACL; you must configure the ACL on the ACE appliance. For more information, see the “[Configuring Security with ACLs](#)” section on page 6-78.

## Procedure

- Step 1** Choose **Config > Devices > context > Network > VLAN Interfaces**.  
The VLAN Interface table appears.
- Step 2** In the VLAN Interface table, click **Poll Now** to instruct ANM to poll the devices and display the current values and click **OK** when prompted if you want to poll the devices for data now.
- Step 3** Click **Add** to add a new VLAN interface, or choose an existing VLAN interface and click **Edit** to modify it.



## Note

If you click **Edit**, not all of the fields can be modified.

- Step 4** Enter the VLAN interface attributes (see [Table 12-1](#)). Click **More Settings** to access the additional VLAN interface attributes.

By default, ANM hides the default VLAN interface attributes and the VLAN interface attributes that are not commonly used.



## Note

Fields and information related to IPv6 require ACE module and ACE appliance software Version A5(1.0) or later.



## Note

If you create a fault-tolerant VLAN, do not use it for any other network traffic.

**Table 12-1** VLAN Interface Attributes

| Field       | Description                                                                                                                      |
|-------------|----------------------------------------------------------------------------------------------------------------------------------|
| VLAN        | VLAN identifier. Either accept the automatically incremented entry or enter a different value. Valid entries are from 2 to 4094. |
| Description | Brief description for this interface.                                                                                            |

Table 12-1 VLAN Interface Attributes (continued)

| Field             | Description                                                                                                                                                                                                                                                                                                                                                                                                                                                                                                                                                                                                                                                                                                                                                                                                                                                                                                                                                                                                                                                                                                                                                                                                                                                                                                                                                                                                                                                                                   |
|-------------------|-----------------------------------------------------------------------------------------------------------------------------------------------------------------------------------------------------------------------------------------------------------------------------------------------------------------------------------------------------------------------------------------------------------------------------------------------------------------------------------------------------------------------------------------------------------------------------------------------------------------------------------------------------------------------------------------------------------------------------------------------------------------------------------------------------------------------------------------------------------------------------------------------------------------------------------------------------------------------------------------------------------------------------------------------------------------------------------------------------------------------------------------------------------------------------------------------------------------------------------------------------------------------------------------------------------------------------------------------------------------------------------------------------------------------------------------------------------------------------------------------|
| Interface Type    | <p>Role of the virtual context in the network topology of the VLAN interface:</p> <ul style="list-style-type: none"> <li>• <b>Routed</b>—In a routed topology, the ACE virtual context acts as a router between the client-side network and the server-side network. In this topology, every real server for the application must be routed through the ACE virtual context, either by setting the default gateway on each real server to the virtual contexts server-side VLAN interface address, or by using a separate router with appropriate routes configured between the ACE virtual context and the real servers.</li> </ul> <p> <b>Note</b> A routed VLAN interface can support both IPv4 and IPv6 addresses at the same time. IPv6 requires ACE module and ACE appliance software Version A5(1.0) or later.</p> <ul style="list-style-type: none"> <li>• <b>Bridged</b>—In a bridged topology, the ACE virtual context bridges two VLANs, a client-side VLAN and a real-server VLAN, on the same subnet using a bridged virtual interface (BVI). In this case, the real server routing does not change to accommodate the ACE virtual context. Instead, the ACE virtual context becomes a “bump in the wire” that transparently handles traffic to and from the real servers.</li> <li>• <b>Unknown</b>—Choose Unknown if you are unsure of the network topology of the VLAN interface.</li> </ul> |
| IP Address        | <p>Field that appears for the Routed Interface Type. Enter the IPv4 address assigned to this interface. This address must be a unique IP address that is not used in another context. Duplicate IP addresses in different contexts are not supported.</p> <p>If this interface is only used for IPv6 traffic, entering an IPv4 address is optional. IPv6 requires ACE module and ACE appliance software Version A5(1.0) or later.</p>                                                                                                                                                                                                                                                                                                                                                                                                                                                                                                                                                                                                                                                                                                                                                                                                                                                                                                                                                                                                                                                         |
| Alias IP Address  | Field that appears for the Routed interface type. Enter the IPv4 address of the alias that this interface is associated with.                                                                                                                                                                                                                                                                                                                                                                                                                                                                                                                                                                                                                                                                                                                                                                                                                                                                                                                                                                                                                                                                                                                                                                                                                                                                                                                                                                 |
| Peer IP Address   | Field that appears for the Routed interface type. Enter the IPv4 address of the remote peer.                                                                                                                                                                                                                                                                                                                                                                                                                                                                                                                                                                                                                                                                                                                                                                                                                                                                                                                                                                                                                                                                                                                                                                                                                                                                                                                                                                                                  |
| Netmask           | Field that appears for the Routed interface type. Choose the subnet mask to be used.                                                                                                                                                                                                                                                                                                                                                                                                                                                                                                                                                                                                                                                                                                                                                                                                                                                                                                                                                                                                                                                                                                                                                                                                                                                                                                                                                                                                          |
| BVI               | Field that appears for the Bridged interface type. Enter the number of the bridge group to be configured on this VLAN. When you configure a bridge group on a VLAN, the ACE automatically makes it bridged. Valid entries are from 1 to 4094.                                                                                                                                                                                                                                                                                                                                                                                                                                                                                                                                                                                                                                                                                                                                                                                                                                                                                                                                                                                                                                                                                                                                                                                                                                                 |
| Admin Status      | Administrative state of the interface. Specify whether you want the interface to be Up or Down.                                                                                                                                                                                                                                                                                                                                                                                                                                                                                                                                                                                                                                                                                                                                                                                                                                                                                                                                                                                                                                                                                                                                                                                                                                                                                                                                                                                               |
| Enable MAC Sticky | <p>Check box that instructs the ACE to convert dynamic MAC addresses to sticky secure MAC addresses and to add this information to the running configuration.</p> <p>Uncheck the check box to indicate that the ACE is not to convert dynamic MAC addresses to sticky secure MAC addresses.</p>                                                                                                                                                                                                                                                                                                                                                                                                                                                                                                                                                                                                                                                                                                                                                                                                                                                                                                                                                                                                                                                                                                                                                                                               |

Table 12-1 VLAN Interface Attributes (continued)



| Field                | Description                                                                                                                                                                                                                                                                                                                                                                                                                                                                                                                                                                                                                                                                                                                                                                                                         |
|----------------------|---------------------------------------------------------------------------------------------------------------------------------------------------------------------------------------------------------------------------------------------------------------------------------------------------------------------------------------------------------------------------------------------------------------------------------------------------------------------------------------------------------------------------------------------------------------------------------------------------------------------------------------------------------------------------------------------------------------------------------------------------------------------------------------------------------------------|
| Enable Normalization | <p>Check box that specifies that normalization is to be enabled on this interface. Uncheck the check box to indicate that normalization is to be disabled on this interface for IPv4, IPv6, or both. The IPv6 option requires ACE module and ACE appliance software Version A5(1.0) or later.</p> <p> <b>Caution</b> Disabling normalization may expose your ACE and network to potential security risks. Normalization protects your networking environment from attackers by enforcing strict security policies that are designed to examine traffic for malformed or malicious segments.</p>                                                                                                                                    |
| Enable IPv6          | <p>Field that appears only for ACE module and ACE appliance software Version A5(1.0) or later, and for the Routed interface type. Check the check box to enable IPv6 on this interface. By default, IPv6 is disabled. The interface cannot be in bridged mode. When you enable IPv6, the ACE automatically does the following:</p> <ul style="list-style-type: none"> <li>• Configures a link-local address (if not previously configured)</li> <li>• Performs duplicate address detection (DAD)</li> </ul> <p>Clear the check box to indicate that IPv6 is disabled on this interface.</p>                                                                                                                                                                                                                         |
| IPv6 Global Address  | <p>Field that appears only for ACE module and ACE appliance software Version A5(1.0) or later, and for the Routed interface type. A global address is an IPv6 unicast address that is used for general IPv6 communication. Each global address is unique across the entire Internet. Therefore, its scope is global. The low order 64 bits can be assigned in several ways, including autoconfiguration using the EUI-64 format. You can configure only one globally unique IPv6 address on an interface.</p> <p>When you configure a global IPv6 address on an interface, the ACE automatically does the following:</p> <ul style="list-style-type: none"> <li>• Configures a link-local address (if not previously configured)</li> <li>• Performs duplicate address detection (DAD) on both addresses</li> </ul> |
| IPv6 Address         | <p>To configure an IPv6 global address on an interface, enter a complete IPv6 address with a prefix of 2000::/3 to 3fff::/3. For example, enter 2001:DB8:1::0.</p> <p>Check the EUI-64 box to specify that the low order 64 bits are automatically generated in the IEEE 64-bit Extended Unique Identifier (EUI-64) format specified in RFC 2373. To use EUI-64, the Prefix Length field must be less than or equal to 64 and the host segment must be all zeros.</p>                                                                                                                                                                                                                                                                                                                                               |
| Alias IPv6 Address   | <p>When you configure redundancy with active and standby ACEs, you can configure a VLAN interface that has an alias global IPv6 address that is shared between the active and standby ACEs. The alias IPv6 address serves as a shared gateway for the two ACEs in a redundant configuration. You can configure only one alias global IPv6 address on an interface.</p> <p>To configure an IPv6 alias global address, enter a complete IPv6 address with a prefix of 2000::/3 to 3fff::/3. For example, enter 2001:DB8:1::0.</p> <p> <b>Note</b> You must configure redundancy (fault tolerance) on the ACE for the alias global IPv6 address to work.</p>                                                                        |

Table 12-1 VLAN Interface Attributes (continued)



| Field                     | Description                                                                                                                                                                                                                                                                                                                                                                                                                                                                                                                                                                                                                                                                                                                                                                                                                                                                                                                                                                                                        |
|---------------------------|--------------------------------------------------------------------------------------------------------------------------------------------------------------------------------------------------------------------------------------------------------------------------------------------------------------------------------------------------------------------------------------------------------------------------------------------------------------------------------------------------------------------------------------------------------------------------------------------------------------------------------------------------------------------------------------------------------------------------------------------------------------------------------------------------------------------------------------------------------------------------------------------------------------------------------------------------------------------------------------------------------------------|
| Peer IPv6 Address         | <p>To configure an IPv6 peer global address, enter a complete IPv6 address with a prefix of 2000::/3 to 3fff::/3. For example, enter 2001:DB8:1::0.</p> <p>Check the EUI-64 box to specify that the low order 64 bits are automatically generated in the IEEE 64-bit Extended Unique Identifier (EUI-64) format specified in RFC 2373. To use EUI-64, the Prefix Length field must be less than or equal to 64 and the host segment must be all zeros.</p>  <p><b>Note</b> The IPv6 peer global address must be unique across multiple contexts on a shared VLAN.</p> <p>Check the EUI-64 box to specify that the low order 64 bits are automatically generated in the IEEE 64-bit Extended Unique Identifier (EUI-64) format specified in RFC 2373. To use EUI-64, the Prefix Length field must be less than or equal to 64 and the host segment must be all zeros.</p>                                                          |
| Prefix Length             | <p>Enter the prefix length for all global addresses to specify how many of the most significant bits (MSBs) are used for the network identifier. Enter an integer from 3 to 127. If you use the optional EUI-64 check box for the global and peer addresses, the prefix must be less than or equal to 64.</p>                                                                                                                                                                                                                                                                                                                                                                                                                                                                                                                                                                                                                                                                                                      |
| IPv6 Unique-Local Address | <p>Field that appears only for ACE module and ACE appliance software Version A5(1.0) or later, and for the Routed interface type. A unique local address is an optional IPv6 unicast address that is used for local communication within an organization and it is similar to a private IPv4 address (for example, 10.10.2.1). Unique local addresses have a global scope, but they are not routable on the internet, and they are assigned by a central authority. All unique local addresses have a predefined prefix of FC00::/7. You can configure only one IPv6 unique local address on an interface.</p>                                                                                                                                                                                                                                                                                                                                                                                                     |
| IPv6 Address              | <p>To configure a unique local address, enter a complete IPv6 address with an FC00::/7 prefix in the first field. In the second field after the /, enter the prefix length to specify how many of the most significant bits (MSBs) are used for the network identifier.</p> <p>Check the EUI-64 box to specify that the low order 64 bits are automatically generated in the IEEE 64-bit Extended Unique Identifier (EUI-64) format specified in RFC 2373. To use EUI-64, the Prefix Length field must be less than or equal to 64 and the host segment must be all zeros.</p>                                                                                                                                                                                                                                                                                                                                                                                                                                     |
| Peer IPv6 Address         | <p>In a redundant configuration, you can configure an IPv6 peer unique local address on the active that is synchronized to the standby ACE. You can configure only one peer unique local IPv6 address on an interface.</p> <p>To configure a peer unique local address, enter a complete IPv6 address with an FC00::/7 prefix in the first field. In the second field after the /, enter the prefix length to specify how many of the most significant bits (MSBs) are used for the network identifier.</p>  <p><b>Note</b> The IPv6 peer unique local address must be unique across multiple contexts on a shared VLAN.</p> <p>Check the EUI-64 box to specify that the low order 64 bits are automatically generated in the IEEE 64-bit Extended Unique Identifier (EUI-64) format specified in RFC 2373. To use EUI-64, the Prefix Length field must be less than or equal to 64 and the host segment must be all zeros.</p> |
| Prefix Length             | <p>Enter the prefix length for all unique-local addresses to specify how many of the most significant bits (MSBs) are used for the network identifier. Enter an integer from 7 to 127. If you use the optional EUI-64 check box for the global and peer addresses, the prefix must be less than or equal to 64.</p>                                                                                                                                                                                                                                                                                                                                                                                                                                                                                                                                                                                                                                                                                                |

Table 12-1 VLAN Interface Attributes (continued)

| Field                        | Description                                                                                                                                                                                                                                                                                                                                                                                                                                                                                                                                                                                                                           |
|------------------------------|---------------------------------------------------------------------------------------------------------------------------------------------------------------------------------------------------------------------------------------------------------------------------------------------------------------------------------------------------------------------------------------------------------------------------------------------------------------------------------------------------------------------------------------------------------------------------------------------------------------------------------------|
| IPv6 Link-Local Address      | <p>Field that appears only for ACE module and ACE appliance software Version A5(1.0) or later, and for the Routed interface type. By default, when you enable IPv6 or configure a global IPv6 address on an interface, the ACE automatically creates a link local address for it. Every link local address must have a predefined prefix of FE80::/10. You can configure only one IPv6 link local address on an interface. This address always has the prefix of 64.</p> <p>To manually configure the link local address, enter a complete IPv6 address with an FE80::/10 prefix in this field. For example, enter FE80:DB8:1::1.</p> |
| IPv6 Peer Link-Local Address | <p>Field that appears only for ACE module and ACE appliance software Version A5(1.0) or later, and for the Routed interface type. In a redundant configuration, you can configure an IPv6 peer link local address for the standby ACE. You can configure only one peer link local address on an interface.</p> <p>To configure the peer link local address, enter a complete IPv6 address with an FE80::/10 prefix in this field.</p> <p> <b>Note</b> The IPv6 peer link local address must be unique across multiple contexts on a shared VLAN.</p> |



Table 12-1 VLAN Interface Attributes (continued)

| Field                         | Description                                                                                                                                                                                                                                                                                                                                                                                                                                                                                                                                                                                                                                                                                                                                                                                               |
|-------------------------------|-----------------------------------------------------------------------------------------------------------------------------------------------------------------------------------------------------------------------------------------------------------------------------------------------------------------------------------------------------------------------------------------------------------------------------------------------------------------------------------------------------------------------------------------------------------------------------------------------------------------------------------------------------------------------------------------------------------------------------------------------------------------------------------------------------------|
| <b>More Settings</b>          |                                                                                                                                                                                                                                                                                                                                                                                                                                                                                                                                                                                                                                                                                                                                                                                                           |
| Enable ICMP Guard             | <p>For ACE module and ACE appliance software versions earlier than A5(1.0), this field does not include the IP version number check boxes and is for enabling the IPv4 version only. Check the <b>IPv4</b>, <b>IPv6</b>, or both check boxes to indicate that ICMP Guard is to be enabled on the ACE.</p> <p>Clear the check boxes to indicate that ICMP Guard is not to be enabled on ACE.</p> <p> <b>Caution</b> Disabling ICMP security checks may expose your ACE and network to potential security risks. When you disable ICMP Guard, the ACE appliance no longer performs NAT translations on the ICMP header and payload in error packets, which can potentially reveal real host IP addresses to attackers.</p> |
| Enable DHCP Relay             | <p>For ACE module and ACE appliance software versions earlier than A5(1.0), this field does not include the IP version number check boxes and is for enabling the IPv4 version only. Check the <b>IPv4</b>, <b>IPv6</b>, or both check boxes to indicate that the ACE is to accept DHCP requests from clients on this interface and to enable the DHCP relay agent. For IPv6, link local address for the</p> <p>Clear the check boxes to indicate that the ACE is not to accept DHCP requests or enable the DHCP relay agent.</p>                                                                                                                                                                                                                                                                         |
| Reverse Path Forwarding (RPF) | <p>For ACE module and ACE appliance software versions earlier than A5(1.0), this field does not include the IP version number check boxes and is for enabling the IPv4 version only. Check the <b>IPv4</b>, <b>IPv6</b>, or both check boxes to indicate that the ACE is to discard IP packets if no reverse route is found or if the route does not match the interface on which the packets arrived.</p> <p>Clear the check boxes to indicate that the ACE is not to filter or discard packets based on the ability to verify the source IP address.</p>                                                                                                                                                                                                                                                |
| Reassembly Timeout (Seconds)  | <p>Enter the number of seconds that the ACE appliance is to wait before it abandons the fragment reassembly process if it doesn't receive any outstanding fragments for the current fragment chain (that is, fragments belonging to the same packet).</p> <ul style="list-style-type: none"> <li>• For IPv4, valid entries are 1 to 30 seconds. The default is 5.</li> <li>• For IPv6, valid entries are 1 to 60 seconds. The default is 60. IPv6 requires ACE module and ACE appliance software Version A5(1.0) or later.</li> </ul>                                                                                                                                                                                                                                                                     |
| Max. Fragment Chains Allowed  | <p>Enter the maximum number of fragments belonging to the same packet that the ACE appliance is to accept for reassembly. For IPv4 and IPv6, valid entries are integers from 1 to 256. The default is 24.</p>                                                                                                                                                                                                                                                                                                                                                                                                                                                                                                                                                                                             |
| Min. Fragment MTU Value       | <p>Enter the minimum fragment size that the ACE appliance accepts for reassembly for a VLAN interface.</p> <ul style="list-style-type: none"> <li>• For IPv4, valid entries are 28 to 9216 bytes. The default is 576.</li> <li>• For IPv6, valid entries are 56 to 9216 bytes. The default is 1280. IPv6 requires ACE module and ACE appliance software Version A5(1.0) or later.</li> </ul>                                                                                                                                                                                                                                                                                                                                                                                                              |

Table 12-1 VLAN Interface Attributes (continued)

| Field                             | Description                                                                                                                                                                                                                                                                                                                                                                                                                                                                                                                                                                                                                                                                                                                                                                                                                                                                                          |
|-----------------------------------|------------------------------------------------------------------------------------------------------------------------------------------------------------------------------------------------------------------------------------------------------------------------------------------------------------------------------------------------------------------------------------------------------------------------------------------------------------------------------------------------------------------------------------------------------------------------------------------------------------------------------------------------------------------------------------------------------------------------------------------------------------------------------------------------------------------------------------------------------------------------------------------------------|
| Action For IP Header Options      | <p>For ACE module and ACE appliance software versions earlier than A5(1.0), this field does not include the IP version number and is for IPv4 only. Choose the IPv4, IPv6, or both action the ACE appliance is to take when an IP option is set in a packet:</p> <ul style="list-style-type: none"> <li>• <b>Allow</b>—Indicates that the ACE appliance is to allow the IP packet with the IP options set.</li> <li>• <b>Clear</b>—Indicates that the ACE appliance is to clear all IP options from the packet and to allow the packet.</li> <li>• <b>Clear-Invalid</b>—Indicates that the ACE appliance is to clear the invalid IP options from the packet and then allow the packet. This action is the default for IPv4.</li> <li>• <b>Drop</b>—Indicates that the ACE appliance is to discard the packet regardless of any options that are set. This action is the default for IPv6.</li> </ul> |
| Enable MAC Address Autogenerate   | MAC address autogenerate option, which allows you to configure a different MAC address for the VLAN interface.                                                                                                                                                                                                                                                                                                                                                                                                                                                                                                                                                                                                                                                                                                                                                                                       |
| Min. TTL IP Header Value          | <p>Minimum number of hops that a packet is allowed to reach its destination. Valid entries are from 1 to 255. This field is applicable for IPv4 and IPv6 traffic. IPv6 requires ACE module and ACE appliance software Version A5(1.0) or later.</p> <p>Each router along the path decrements the TTL by one. If the packet TTL reaches zero before the packet reaches its destination, the packet is discarded.</p>                                                                                                                                                                                                                                                                                                                                                                                                                                                                                  |
| MTU Value                         | Number of bytes for Maximum Transmission Units (MTUs). Valid entries are from 68 to 9216. The default is 1500.                                                                                                                                                                                                                                                                                                                                                                                                                                                                                                                                                                                                                                                                                                                                                                                       |
| Enable Syn Cookie Threshold Value | <p>Field that is applicable for ACE module software Version A2(1.0) and later, and ACE appliance software Version A3(1.0) and later. Embryonic connection threshold above which the ACE applies SYN-cookie DoS protection.</p> <p>Valid entries are as follows:</p> <ul style="list-style-type: none"> <li>• 2 to 65535 for ACE module software versions earlier than A4(1.0).</li> <li>• 1 to 65535 for ACE module software Version A4(1.0) and later, and ACE appliance software Version A3(1.0) and later.</li> </ul>                                                                                                                                                                                                                                                                                                                                                                             |
| Action For DF Bit                 | <p>Action that the ACE takes when a packet has its DF (Don't Fragment) bit set in the IP header. Choose one of the following settings:</p> <ul style="list-style-type: none"> <li>• <b>Allow</b>—The ACE permits the packet with the DF bit set. If the packet is larger than the next-hop MTU, ACE discards the packet and sends an ICMP unreachable message to the source host. This is the default.</li> <li>• <b>Clear</b>—The ACE clears the DF bit and permit the packet. If the packet is larger than the next-hop MTU, the ACE fragments the packet.</li> </ul>                                                                                                                                                                                                                                                                                                                              |

Table 12-1 VLAN Interface Attributes (continued)

| Field               | Description                                                                                                                                                                                                                                                                                                                                                                                                                                                                                                                                                                                                                                                                                                                                                                                                                                                                                                                                                                                                                                                                                                                                                                                                                                                                                                                                                                                                                |
|---------------------|----------------------------------------------------------------------------------------------------------------------------------------------------------------------------------------------------------------------------------------------------------------------------------------------------------------------------------------------------------------------------------------------------------------------------------------------------------------------------------------------------------------------------------------------------------------------------------------------------------------------------------------------------------------------------------------------------------------------------------------------------------------------------------------------------------------------------------------------------------------------------------------------------------------------------------------------------------------------------------------------------------------------------------------------------------------------------------------------------------------------------------------------------------------------------------------------------------------------------------------------------------------------------------------------------------------------------------------------------------------------------------------------------------------------------|
| ARP Inspection Type | <p>Type of ARP inspection, which prevents malicious users from impersonating other hosts or routers, known as ARP spoofing. ARP spoofing can enable a “man-in-the-middle” attack. For example, a host sends an ARP request to the gateway router. The gateway router responds with the gateway router MAC address.</p> <p>By default, ARP inspection is disabled on all interfaces, allowing all ARP packets through the ACE. When you enable ARP inspection, the ACE appliance uses the IP address and interface ID (ifID) of an incoming ARP packet as an index into the ARP table. ARP inspection operates only on ingress bridged interfaces.</p> <p> <b>Note</b> If ARP inspection fails, then the ACE does not perform source MAC validation.</p> <p>Choices are as follows:</p> <ul style="list-style-type: none"> <li>• <b>N/A</b>—ARP inspection is disabled.</li> <li>• <b>Flood</b>—Enables ARP forwarding of nonmatching ARP packets. The ACE appliance forwards all ARP packets to all interfaces in the bridge group. This setting is the default. In the absence of a static ARP entry, this option bridges all packets.</li> <li>• <b>No Flood</b>—Disables ARP forwarding for the interface and drops nonmatching ARP packets. In the absence of a static ARP entry, this option does not bridge any packets.</li> </ul> |
| UDP Config Commands | <p>UDP boost command options:</p> <ul style="list-style-type: none"> <li>• <b>N/A</b>—Not applicable.</li> <li>• <b>IP Destination Hash</b>—Performs destination IP hash during connection.</li> <li>• <b>IP Source Hash</b>—Performs source IP hash during connection lookup.</li> </ul>                                                                                                                                                                                                                                                                                                                                                                                                                                                                                                                                                                                                                                                                                                                                                                                                                                                                                                                                                                                                                                                                                                                                  |

Table 12-1 VLAN Interface Attributes (continued)



| Field               | Description                                                                                                                                                                                                                                                                                                                                                                                                                                                                                                                                                                                                                                                                                                                                                                                                                                                                                                                                                                                                                                                                                                                                                                                                                                                                                                                                                                                                                                                                                                                                                                                                                                                                                                                                                                                                                                                                                                                                                                                                                                                                                                    |
|---------------------|----------------------------------------------------------------------------------------------------------------------------------------------------------------------------------------------------------------------------------------------------------------------------------------------------------------------------------------------------------------------------------------------------------------------------------------------------------------------------------------------------------------------------------------------------------------------------------------------------------------------------------------------------------------------------------------------------------------------------------------------------------------------------------------------------------------------------------------------------------------------------------------------------------------------------------------------------------------------------------------------------------------------------------------------------------------------------------------------------------------------------------------------------------------------------------------------------------------------------------------------------------------------------------------------------------------------------------------------------------------------------------------------------------------------------------------------------------------------------------------------------------------------------------------------------------------------------------------------------------------------------------------------------------------------------------------------------------------------------------------------------------------------------------------------------------------------------------------------------------------------------------------------------------------------------------------------------------------------------------------------------------------------------------------------------------------------------------------------------------------|
| Secondary IP Groups | <p>Option that is available only for the ACE module A2(3.0), ACE appliance A4(1.0), and later releases of both device types. This option displays only when Interface Type is set to Routed.</p> <p>The number of secondary IP groups that you can enter for a VLAN depends on the ACE release as follows:</p> <ul style="list-style-type: none"> <li>• ACE module A2(3.0) and ACE appliance A4(1.0)—Up to 4 secondary IP groups.</li> <li>• ACE module A2(3.1) and later—Up to 15 secondary IP groups.</li> </ul> <p>The IP, alias IP, and peer IP addresses of each Secondary IP group should be in the same subnet.</p>  <p><b>Note</b> You cannot configure secondary IP addresses on FT VLANs.</p> <p>To create secondary IP groups for the VLAN, do the following:</p> <ol style="list-style-type: none"> <li>Define one or more of the following secondary IP address types: <ul style="list-style-type: none"> <li>– IP—Secondary IP address assigned to this interface. The primary address must be active for the secondary address to be active.</li> <li>– AliasIP—Secondary IP address of the alias associated with this interface.</li> <li>– PeerIP—Secondary IP address of the remote peer.</li> <li>– Netmask—Secondary subnet mask to be used.</li> </ul> <p>The ACE has a system limit of 1,024 for each secondary IP address type.</p> </li> <li>Click <b>Add to selection</b> (right arrow) to add the group to the group display area.</li> <li>Repeat the first two steps for each additional group.</li> <li>(Optional) Rearrange the order in which the groups are listed by selecting one of the group listings in the group display area and click either <b>Move item up in list</b> (up arrow) or <b>Move item down in list</b> (down arrow). Note that the ACE does not care what order the groups are in.</li> <li>(Optional) Edit a group or remove it from the list by selecting the desired group in the group display area and click <b>Remove from selection</b> (left arrow).</li> </ol> |
| Input Policies      | <p>Policy map that is associated with this VLAN interface. From the Available list, double-click a policy map name or use the right arrow to move it to the Selected list. This policy map is to be applied to the inbound direction of the interface; that is, all traffic received by this interface.</p> <p>If you choose more than one policy map, use the Up and Down arrows to choose the priority of the policy map in the Selected list. These arrows modify the order of the policy maps for new VLANs only; they do not modify the policy map order when editing an existing policy map.</p>                                                                                                                                                                                                                                                                                                                                                                                                                                                                                                                                                                                                                                                                                                                                                                                                                                                                                                                                                                                                                                                                                                                                                                                                                                                                                                                                                                                                                                                                                                         |
| Input Access Group  | <p>ACL input access group to be associated with this VLAN interface. From the Available list, double-click an ACL name or use the right arrow to move it to the Selected list. Any ACL group listed in the Selected list specifies that this access group is to be applied to the inbound direction of the interface.</p>                                                                                                                                                                                                                                                                                                                                                                                                                                                                                                                                                                                                                                                                                                                                                                                                                                                                                                                                                                                                                                                                                                                                                                                                                                                                                                                                                                                                                                                                                                                                                                                                                                                                                                                                                                                      |
| Output Access Group | <p>ACL output access group that is associated with this VLAN interface. From the Available list, double-click an ACL name or use the right arrow to move it to the Selected list. Any ACL group listed in the Selected list specifies that this access group is to be applied to the outbound direction of the interface; that is, all traffic sent by this interface.</p>                                                                                                                                                                                                                                                                                                                                                                                                                                                                                                                                                                                                                                                                                                                                                                                                                                                                                                                                                                                                                                                                                                                                                                                                                                                                                                                                                                                                                                                                                                                                                                                                                                                                                                                                     |

Table 12-1 VLAN Interface Attributes (continued)

| Field                             | Description                                                                                                                                                                                                                                                                                                                                                                                                                                                                                                                                                                                                                                                            |
|-----------------------------------|------------------------------------------------------------------------------------------------------------------------------------------------------------------------------------------------------------------------------------------------------------------------------------------------------------------------------------------------------------------------------------------------------------------------------------------------------------------------------------------------------------------------------------------------------------------------------------------------------------------------------------------------------------------------|
| Static ARP Entry (IP/MAC Address) | <p>Static ARP entry.</p> <p>Do the following:</p> <ol style="list-style-type: none"> <li>In the ARP IP Address field, enter the IP address. This field accepts IPv4 addresses only.</li> <li>In the ARP MAC Address field, enter the hardware MAC address for the ARP table entry (for example, 00.02.9a.3b.94.d9).</li> <li>When completed, use the right arrow to move the static ARP entry to the list box. Use the Up and Down arrows to choose the priority of the static ARP entry in the list box. These arrows modify the order of the static ARPs for new VLANs only; they do not modify the static ARP order when editing an existing policy map.</li> </ol> |
| DHCP Relay Configuration          | Enter the IPv4 address of the DHCP server to which the DHCP relay agent is to forward client requests. Enter the IP address in dotted-decimal notation, such as 192.168.11.2.                                                                                                                                                                                                                                                                                                                                                                                                                                                                                          |
| IPv6 DHCP Forward Interface VLAN  | Field that appears only for ACE module and ACE appliance software Version A5(1.0) or later. Enter the VLAN to forward all received client requests with destination being the IPv6 DHCP address configured in the IPv6 DHCP Relay Configuration field.                                                                                                                                                                                                                                                                                                                                                                                                                 |
| IPv6 DHCP Relay Configuration     | <p>Field that appears only for ACE module and ACE appliance software Version A5(1.0) or later. Enter the IPv6 address for the DHCP server where the DHCP relay agent forwards client requests.</p> <p>Select the VLAN when the server address is a link local address.</p> <p> <b>Note</b> When you enter a DHCPv6 server global IPv6 address, a VLAN is not required.</p>                                                                                                                                                                                                           |
| Managed-Config                    | <p>Field that appears only for ACE module and ACE appliance software Version A5(1.0) or later. Check box to indicate that the interface use the stateful autoconfiguration mechanism to configure IPv6 addresses.</p> <p>Uncheck the check box to indicate that the interface does not use the stateful autoconfiguration mechanism to configure IPv6 addresses.</p>                                                                                                                                                                                                                                                                                                   |
| Other-Config                      | <p>Field that appears only for ACE module and ACE appliance software Version A5(1.0) or later. Check box to indicate that the interface use the stateful autoconfiguration mechanism to configure parameters other than IPv6 addresses.</p> <p>Uncheck the check box to indicate that the interface does not use the stateful autoconfiguration mechanism to configure parameters other than IPv6 addresses.</p>                                                                                                                                                                                                                                                       |
| NS Interval                       | <p>Field that appears only for ACE module and ACE appliance software Version A5(1.0) or later. The ACE sends neighbor solicitation messages through ICMPv6 on the local link to determine the IPv6 addresses of nearby nodes (hosts or routers). You can configure the rate at which the ACE sends these neighbor solicitation messages.</p> <p>By default, the interval at which the ACE sends NS messages for DAD default is 1000 milliseconds (msecs). To configure the interval, enter an integer from 1000 to 2147483647.</p>                                                                                                                                     |
| NS Reachable Time                 | <p>Field that appears only for ACE module and ACE appliance software Version A5(1.0) or later. The neighbor solicitation reachable time is the time period in milliseconds during which a host considers the peer is reachable after a reachability confirmation from the peer. A reachability confirmation can include neighbor solicitation or advertisement, or any upper protocol traffic.</p> <p>By default, this time period is 0 milliseconds. To configure this time, enter an integer from 0 to 3600000.</p>                                                                                                                                                  |

**Table 12-1** VLAN Interface Attributes (continued)

| Field                            | Description                                                                                                                                                                                                                                                                                                                                                                                                                                                                                                                                                    |
|----------------------------------|----------------------------------------------------------------------------------------------------------------------------------------------------------------------------------------------------------------------------------------------------------------------------------------------------------------------------------------------------------------------------------------------------------------------------------------------------------------------------------------------------------------------------------------------------------------|
| Retransmission time              | Field that appears only for ACE module and ACE appliance software Version A5(1.0) or later. By default, the advertised retransmission time is 0 milliseconds.<br>To configure the retransmission time, enter an integer from 0 to 3600000.                                                                                                                                                                                                                                                                                                                     |
| DAD Attempts                     | Field that appears only for ACE module and ACE appliance software Version A5(1.0) or later. By default, the number of attempts for sending duplicate address detection (DAD) is 1.<br>To configure the DAD attempts, enter an integer from 0 to 255.                                                                                                                                                                                                                                                                                                           |
| RA Hop Limit                     | Field that appears only for ACE module and ACE appliance software Version A5(1.0) or later. By default, the hop limit that neighbors should use when originating IPv6 packets is 64. To configure the hop limit in the IPv6 header, enter an integer from 0 to 255.                                                                                                                                                                                                                                                                                            |
| RA Lifetime                      | Field that appears only for ACE module and ACE appliance software Version A5(1.0) or later. The router advertisement lifetime is the length of time that neighboring nodes should consider the ACE as the default router before they send RS messages again.<br>By default, this length of time is 1800 seconds (30 minutes). To configure the RA lifetime, enter an integer from 0 to 9000.                                                                                                                                                                   |
| RA Interval                      | Field that appears only for ACE module and ACE appliance software Version A5(1.0) or later. By default, the rate at which the ACE sends RA messages is 600 seconds. To configure the rate, enter an integer from 4 to 1800.                                                                                                                                                                                                                                                                                                                                    |
| Suppress RA                      | Field that appears only for ACE module and ACE appliance software Version A5(1.0) or later. Check box to instruct the ACE to not respond to RS messages. The ACE also stops periodic unsolicited RAs that it sends at the RA interval.<br>By default, the ACE automatically responds to RS messages that it receives from neighbors with RA messages that include, for example, the network prefix. You can instruct the ACE to not respond to RS messages.<br>Uncheck the check box to reset the default behavior of automatically responding to RS messages. |
| IPv6 Router Prefix Advertisement | Field that appears only for ACE module and ACE appliance software Version A5(1.0) or later. Click the Add button to configure the IPv6 prefixes that the ACE advertises in RA messages on the local link.                                                                                                                                                                                                                                                                                                                                                      |
| IPv6 Address/Prefix Length       | To configure IPv6 address advertised in the RA messages, enter a complete IPv6 address in the first field. In the second field after the /, enter the prefix length to specify how many of the most significant bits (MSBs) are used for the network identifier.                                                                                                                                                                                                                                                                                               |
| No Advertisements                | Check the check box to indicate that the route prefix is not advertised.<br>Clear the check box to indicate that the route prefix is advertised.                                                                                                                                                                                                                                                                                                                                                                                                               |

Table 12-1 VLAN Interface Attributes (continued)

| Field         | Description                                                                                                                                                                                                                                                                                                                                                                                                                                                                                                                                                                                                                                                                                                                                                                                                                                                                                                                                                                                                                                                                                                       |
|---------------|-------------------------------------------------------------------------------------------------------------------------------------------------------------------------------------------------------------------------------------------------------------------------------------------------------------------------------------------------------------------------------------------------------------------------------------------------------------------------------------------------------------------------------------------------------------------------------------------------------------------------------------------------------------------------------------------------------------------------------------------------------------------------------------------------------------------------------------------------------------------------------------------------------------------------------------------------------------------------------------------------------------------------------------------------------------------------------------------------------------------|
| Lifetime      | <p>Configure the prefix lifetime attributes as follows:</p> <ul style="list-style-type: none"> <li>• Lifetime Duration: <ul style="list-style-type: none"> <li>– Valid Lifetime—By default, the prefix lifetime is 2592000 seconds (30 days). To configure the prefix lifetime in seconds, enter an integer from 0 to 2147183647. Select Infinite to indicate that the prefix never expires.</li> <li>– Preferred Lifetime—By default, the prefix lifetime is 604800 seconds (10 days). To configure how long an IPv6 address remains preferred in seconds, enter an integer from 0 to 2147183647. This lifetime must not exceed the Valid Lifetime. Select Infinite to indicate that the preferred lifetime never expires.</li> </ul> </li> <li>• Lifetime Expiration Date: <ul style="list-style-type: none"> <li>– Valid Month/Day/Year/Time—Valid lifetime expiration date and time.</li> <li>– Preferred Month/Day/Year/Time—Preferred lifetime expiration date and time.</li> </ul> </li> </ul> <p>Use the drop-down lists to select a day, month, and year. To specify the time, use the hh:mm format.</p> |
| Off-link      | <p>This option appears when you enter a Preferred Lifetime field.</p> <p>Check this check box to indicate that the route prefix is on a different subnet for a router to route to it.</p> <p>Clear the check box to indicate that the route prefix is on the same subnet for a router to route to it.</p>                                                                                                                                                                                                                                                                                                                                                                                                                                                                                                                                                                                                                                                                                                                                                                                                         |
| No-autoconfig | <p>This option appears when you enter a Preferred Lifetime field.</p> <p>Check this check box to indicate to the host that it cannot use this prefix when creating an stateless IPv6 address.</p> <p>Clear the check box to indicate to the host that it can use this prefix when creating an stateless IPv6 address.</p>                                                                                                                                                                                                                                                                                                                                                                                                                                                                                                                                                                                                                                                                                                                                                                                         |

**Step 5** Do one of the following:

- Click **Deploy Now** to immediately deploy this configuration on the ACE and save your entries to the running-configuration and startup-configuration files. This option appears for virtual contexts.
- Click **Cancel** to exit this procedure without saving your entries and to return to the previous window.

**Step 6** (Optional) To display statistics and status information for a VLAN interface, choose the VLAN interface from the VLAN Interface table, then click **Details**.

The **show interface vlan** CLI command output appears. See the “[Displaying VLAN Interface Statistics and Status Information](#)” section on page 12-18 for details.

#### Related Topics

- [Configuring VLAN Interface NAT Pools, page 12-26](#)
- [Displaying All VLAN Interfaces, page 12-18](#)
- [Displaying VLAN Interface Statistics and Status Information, page 12-18](#)

## Displaying All VLAN Interfaces

You can display all of the VLAN interfaces associated with a specific virtual context by choosing **Config > Devices > context > Network > VLAN Interfaces**.

The VLAN Interface table appears with the information shown in [Table 12-2](#).

**Table 12-2** VLAN Interface Table Fields

| Field              | Description                                                                                                                                                                                                                                                                                                                                                                                                                   |
|--------------------|-------------------------------------------------------------------------------------------------------------------------------------------------------------------------------------------------------------------------------------------------------------------------------------------------------------------------------------------------------------------------------------------------------------------------------|
| VLAN               | VLAN number.                                                                                                                                                                                                                                                                                                                                                                                                                  |
| Description        | Description for this interface.                                                                                                                                                                                                                                                                                                                                                                                               |
| Interface Type     | Role of the virtual context in the network topology of the VLAN interface.                                                                                                                                                                                                                                                                                                                                                    |
| IP Address         | IP address assigned to this interface including the netmask for an IPv4 address or a prefix length for an IPv6 address. IPv6 requires ACE module and ACE appliance software Version A5(1.0) or later.<br><br>This table does not display the IPv6 link-local, unique-local, and multicast addresses for the interface. To display these addresses, click Details to display the output for the <b>show ipv6 vlan</b> command. |
| IPv6 Config Status | The status whether IPv6 is enabled or disabled on the interface. IPv6 requires ACE module and ACE appliance software Version A5(1.0) or later.                                                                                                                                                                                                                                                                                |
| Admin Status       | Status of the interface, which can be Up or Down.                                                                                                                                                                                                                                                                                                                                                                             |
| Operational Status | Operational state of the device (Up or Down).                                                                                                                                                                                                                                                                                                                                                                                 |
| Last Polled        | Date and time of the last time that ANM polled the device to display the current values.                                                                                                                                                                                                                                                                                                                                      |

### Related Topics

- [Configuring Virtual Context VLAN Interfaces, page 12-6](#)
- [Configuring Virtual Context BVI Interfaces, page 12-19](#)
- [Displaying VLAN Interface Statistics and Status Information, page 12-18](#)

## Displaying VLAN Interface Statistics and Status Information

You can display statistics and status information for a particular VLAN interface.

### Procedure

**Step 1** Choose **Config > Devices > context > Network > VLAN Interfaces**.

The VLAN Interfaces table appears.

**Step 2** Choose a VLAN interface from the VLAN Interfaces table, and click **Details**.

The **show interface vlan**, **show ipv6 interface vlan**, and **show ipv6 neighbors** CLI commands appears. The IPv6 commands require ACE module and ACE appliance software Version A5(1.0) or later. Click on the command to display its output. For details on the displayed output fields, see either the *Cisco ACE Module Routing and Bridging Configuration Guide* or the *Cisco ACE 4700 Series Appliance Routing and Bridging Configuration Guide*.



- Step 3** Click **Update Details** to refresh the output for the **show interface vlan** CLI command.
- Step 4** Click **Close** to return to the VLAN Interfaces table.

---

**Related Topics**

- [Configuring Virtual Context VLAN Interfaces, page 12-6](#)
- [Displaying All VLAN Interfaces, page 12-18](#)

## Configuring Virtual Context BVI Interfaces

You can configure Bridge-Group Virtual Interfaces (BVI) for virtual contexts. The ACE supports virtual contexts containing BVI interfaces. You can configure two interface VLANs into a group and bridge packets between them. All interfaces are in one broadcast domain and packets from one VLAN are switched to the other VLAN. The ACE bridge mode supports only two Layer 2 VLANs per bridge group.

**Note**

---

The options that appear when you choose Config > Devices > *context* depend on the device associated with the virtual context and the role associated with your account.

---

This section includes the following topics:

- [Configuring BVI Interfaces for a Virtual Context, page 12-19](#)
- [Displaying All BVI Interfaces by Context, page 12-25](#)
- [Displaying BVI Interface Statistics and Status Information, page 12-26](#)

## Configuring BVI Interfaces for a Virtual Context

You can configure BVI interfaces for a virtual context.

**Procedure**

- 
- Step 1** Choose **Config > Devices > context > Network > BVI Interfaces**.
- The BVI Interface configuration table appears.
- Step 2** Click **Poll Now** to instruct ANM to poll the devices and display the current values, and click **OK** when prompted if you want to poll the devices for data now.
- Step 3** Click **Add** to add a new BVI interface.
- Step 4** Enter the interface attributes (see [Table 12-3](#)).

**Note**

---

When you create or edit a virtual context BVI, if either of the two VLANs do not exist, ANM creates the VLAN and populates the BVI with the description specified in the BVI Interface window.

If you delete the BVI and there are values specified in either of the two VLAN fields, ANM removes the BVI value from the VLAN.

---

**Note**

Fields and information related to IPv6 require ACE module and ACE appliance software Version A5(1.0) or later.

**Table 12-3 BVI Interface Attributes**

| Field               | Description                                                                                                                                                                                                                                                                                                                                                                                                                                                                                                                                                                                                                                                                                                                                                                                                                                                                                                                                                                                                                                                                                                                                                                                                                                                                                                                                                                                                                                                                                                                                                                                                                                                                                                                    |
|---------------------|--------------------------------------------------------------------------------------------------------------------------------------------------------------------------------------------------------------------------------------------------------------------------------------------------------------------------------------------------------------------------------------------------------------------------------------------------------------------------------------------------------------------------------------------------------------------------------------------------------------------------------------------------------------------------------------------------------------------------------------------------------------------------------------------------------------------------------------------------------------------------------------------------------------------------------------------------------------------------------------------------------------------------------------------------------------------------------------------------------------------------------------------------------------------------------------------------------------------------------------------------------------------------------------------------------------------------------------------------------------------------------------------------------------------------------------------------------------------------------------------------------------------------------------------------------------------------------------------------------------------------------------------------------------------------------------------------------------------------------|
| BVI                 | BVI identifier. Either accept the automatically incremented entry or enter a different, unique value for the BVI. Valid entries are from 1 to 4094.                                                                                                                                                                                                                                                                                                                                                                                                                                                                                                                                                                                                                                                                                                                                                                                                                                                                                                                                                                                                                                                                                                                                                                                                                                                                                                                                                                                                                                                                                                                                                                            |
| Description         | Brief description for this interface.                                                                                                                                                                                                                                                                                                                                                                                                                                                                                                                                                                                                                                                                                                                                                                                                                                                                                                                                                                                                                                                                                                                                                                                                                                                                                                                                                                                                                                                                                                                                                                                                                                                                                          |
| IP Address          | IPv4 address assigned to this interface. This address must be a unique IP address that is not used in another context. Duplicate IP addresses in different contexts are not supported.<br><br><br><b>Note</b> If this interface is only used for IPv6 traffic, entering an IPv4 address is optional. IPv6 requires ACE module and ACE appliance software Version A5(1.0) or later.                                                                                                                                                                                                                                                                                                                                                                                                                                                                                                                                                                                                                                                                                                                                                                                                                                                                                                                                                                                                                                                                                                                                                                                                                                                            |
| Alias IP Address    | IPv4 address of the alias that this interface is associated with.                                                                                                                                                                                                                                                                                                                                                                                                                                                                                                                                                                                                                                                                                                                                                                                                                                                                                                                                                                                                                                                                                                                                                                                                                                                                                                                                                                                                                                                                                                                                                                                                                                                              |
| Peer IP Address     | IPv4 address of the remote peer.                                                                                                                                                                                                                                                                                                                                                                                                                                                                                                                                                                                                                                                                                                                                                                                                                                                                                                                                                                                                                                                                                                                                                                                                                                                                                                                                                                                                                                                                                                                                                                                                                                                                                               |
| Netmask             | Subnet mask to be used.                                                                                                                                                                                                                                                                                                                                                                                                                                                                                                                                                                                                                                                                                                                                                                                                                                                                                                                                                                                                                                                                                                                                                                                                                                                                                                                                                                                                                                                                                                                                                                                                                                                                                                        |
| Admin Status        | Administrative state of the interface: <b>Up</b> or <b>Down</b> .                                                                                                                                                                                                                                                                                                                                                                                                                                                                                                                                                                                                                                                                                                                                                                                                                                                                                                                                                                                                                                                                                                                                                                                                                                                                                                                                                                                                                                                                                                                                                                                                                                                              |
| Secondary IP Groups | Option that is available only for the ACE module A2(3.0), ACE appliance A4(1.0), and later releases of either device type. The number of secondary IP groups that you can enter for a BVI depends on the ACE release as follows: <ul style="list-style-type: none"> <li>• ACE module A2(3.0) and ACE appliance A4(1.0)—Up to 4 secondary IP groups.</li> <li>• ACE module A2(3.1) and later—Up to 15 secondary IP groups.</li> </ul> <p>To create secondary IP groups for this BVI, do the following:</p> <ol style="list-style-type: none"> <li>Define one or more of the following secondary IP address types: <ul style="list-style-type: none"> <li>– IP—Secondary IP address assigned to this interface. The primary address must be active for the secondary address to be active.</li> <li>– AliasIP—Secondary IP address of the alias associated with this interface.</li> <li>– PeerIP—Secondary IP address of the remote peer.</li> <li>– Netmask—Secondary subnet mask to be used.</li> </ul> <p>The ACE has a system limit of 1,024 for each secondary IP address type.</p> </li> <li>Click Add to selection (right arrow) to add the group to the group display area.</li> <li>Repeat the first two steps for each additional group.</li> <li>(Optional) Rearrange the order in which the groups are listed by selecting one of the group listings in the group display area and click either Move item up in list (up arrow) or Move item down in list (down arrow). Note that the ACE does not care what order the groups are in.</li> <li>(Optional) Edit a group or remove it from the list by selecting the desired group in the group display area and click Remove from selection (left arrow).</li> </ol> |
| First VLAN          | First VLAN whose bridge group is to be configured with this BVI. This VLAN can be the server or client VLAN. Valid entries are from 2 to 4094.                                                                                                                                                                                                                                                                                                                                                                                                                                                                                                                                                                                                                                                                                                                                                                                                                                                                                                                                                                                                                                                                                                                                                                                                                                                                                                                                                                                                                                                                                                                                                                                 |

Table 12-3 BVI Interface Attributes (continued)

| Field                   | Description                                                                                                                                                                                                                                                                                                                                                                                                                                                                                                                                                                                                                                                                                                                                          |
|-------------------------|------------------------------------------------------------------------------------------------------------------------------------------------------------------------------------------------------------------------------------------------------------------------------------------------------------------------------------------------------------------------------------------------------------------------------------------------------------------------------------------------------------------------------------------------------------------------------------------------------------------------------------------------------------------------------------------------------------------------------------------------------|
| First VLAN Description  | Brief description for the first VLAN.                                                                                                                                                                                                                                                                                                                                                                                                                                                                                                                                                                                                                                                                                                                |
| Second VLAN             | Second VLAN whose bridge group is to be configured with this BVI. This VLAN can be the server or client VLAN. Valid entries are from 2 to 4094.                                                                                                                                                                                                                                                                                                                                                                                                                                                                                                                                                                                                      |
| Second VLAN Description | Brief description for the second VLAN.                                                                                                                                                                                                                                                                                                                                                                                                                                                                                                                                                                                                                                                                                                               |
| Enable IPv6             | Field that appears only for ACE module and ACE appliance software Version A5(1.0) or later. Check box to enable IPv6 on this interface. By default, IPv6 is disabled. The interface cannot be in bridged mode. When you enable IPv6, the ACE automatically does the following: <ul style="list-style-type: none"> <li>• Configures a link-local address (if not previously configured)</li> <li>• Performs duplicate address detection (DAD) on both addresses</li> </ul> Uncheck the check box to indicate that IPv6 is disabled on this interface.                                                                                                                                                                                                 |
| IPv6 Global Address     | Field that appears only for ACE module and ACE appliance software Version A5(1.0) or later. A global address is an IPv6 unicast address that is used for general IPv6 communication. Each global address is unique across the entire Internet. Therefore, its scope is global. The low order 64 bits can be assigned in several ways, including autoconfiguration using the EUI-64 format. You can configure only one globally unique IPv6 address on an interface. <p>When you configure a global address, the ACE automatically does the following:</p> <ul style="list-style-type: none"> <li>• Configures a link-local address (if not previously configured)</li> <li>• Performs duplicate address detection (DAD) on both addresses</li> </ul> |
| IPv6 Address            | To configure an IPv6 global address on an interface, enter a complete IPv6 address with a prefix of 2000::/3 to 3fff::/3. For example, enter 2001:DB8:1::0. <p>Check the EUI-64 check box to specify that the low order 64 bits are automatically generated in the IEEE 64-bit Extended Unique Identifier (EUI-64) format specified in RFC 2373. To use EUI-64, the Prefix Length field must be less than or equal to 64 and the host segment must be all zeros.</p>                                                                                                                                                                                                                                                                                 |
| Alias IPv6 Address      | When you configure redundancy with active and standby devices, you can configure a VLAN interface that has an alias global IPv6 address that is shared between the active and standby devices. The alias IPv6 address serves as a shared gateway for the two ACEs in a redundant configuration. You can configure only one alias global IPv6 address on an interface. <p>To configure an IPv6 alias global address, enter a complete IPv6 address with a prefix of 2000::/3 to 3fff::/3. For example, enter 2001:DB8:1::0.</p>                                                                                                                                                                                                                       |
|                         |  <p><b>Note</b> You must configure redundancy (fault tolerance) on the ACE for the alias global IPv6 address to work.</p>                                                                                                                                                                                                                                                                                                                                                                                                                                                                                                                                         |

Table 12-3 BVI Interface Attributes (continued)



| Field                     | Description                                                                                                                                                                                                                                                                                                                                                                                                                                                                                                                                                                                                                                                                                                                                                                                                                                                                                                                                                                                                               |
|---------------------------|---------------------------------------------------------------------------------------------------------------------------------------------------------------------------------------------------------------------------------------------------------------------------------------------------------------------------------------------------------------------------------------------------------------------------------------------------------------------------------------------------------------------------------------------------------------------------------------------------------------------------------------------------------------------------------------------------------------------------------------------------------------------------------------------------------------------------------------------------------------------------------------------------------------------------------------------------------------------------------------------------------------------------|
| Peer IPv6 Address         | <p>To configure an IPv6 peer global address, enter a complete IPv6 address with a prefix of 2000::/3 to 3fff::/3. For example, enter 2001:DB8:1::0.</p> <p>Check the EUI-64 box to specify that the low order 64 bits are automatically generated in the IEEE 64-bit Extended Unique Identifier (EUI-64) format specified in RFC 2373. To use EUI-64, the Prefix Length field must be less than or equal to 64 and the host segment must be all zeros.</p> <p></p> <p><b>Note</b> The IPv6 peer global address must be unique across multiple contexts on a shared VLAN.</p>                                                                                                                                                                                                                                                                                                                                                             |
| Prefix Length             | <p>Enter the prefix length for all global addresses to specify how many of the most significant bits (MSBs) are used for the network identifier. Enter an integer from 1 to 128. If you use the optional EUI-64 check box for the global and peer addresses, the prefix must be less than or equal to 64.</p>                                                                                                                                                                                                                                                                                                                                                                                                                                                                                                                                                                                                                                                                                                             |
| IPv6 Unique-Local Address | <p>Field that appears only for ACE module and ACE appliance software Version A5(1.0) or later. A unique local address is an optional IPv6 unicast address that is used for local communication within an organization and it is similar to a private IPv4 address (for example, 10.10.2.1). Unique local addresses have a global scope, but they are not routable on the internet, and they are assigned by a central authority. All unique local addresses have a predefined prefix of FC00::/7. You can configure only one IPv6 unique local address on an interface.</p>                                                                                                                                                                                                                                                                                                                                                                                                                                               |
| IPv6 Address              | <p>To configure a unique local address, enter a complete IPv6 address with an FC00::/7 prefix in the first field. In the second field after the /, enter the prefix length to specify how many of the most significant bits (MSBs) are used for the network identifier.</p> <p>Check the EUI-64 box to specify that the low order 64 bits are automatically generated in the IEEE 64-bit Extended Unique Identifier (EUI-64) format specified in RFC 2373. To use EUI-64, the Prefix Length field must be less than or equal to 64 and the host segment must be all zeros.</p>                                                                                                                                                                                                                                                                                                                                                                                                                                            |
| Peer IPv6 Address         | <p>In a redundant configuration, you can configure an IPv6 peer unique local address on the active that is synchronized to the standby ACE. You can configure only one peer unique local IPv6 address on an interface.</p> <p>To configure a peer unique local address, enter a complete IPv6 address with an FC00::/7 prefix in the first field. In the second field after the /, enter the prefix length to specify how many of the most significant bits (MSBs) are used for the network identifier.</p> <p></p> <p><b>Note</b> The IPv6 peer unique local address must be unique across multiple contexts on a shared VLAN.</p> <p>Check the EUI-64 box to specify that the low order 64 bits are automatically generated in the IEEE 64-bit Extended Unique Identifier (EUI-64) format specified in RFC 2373. To use EUI-64, the Prefix Length field must be less than or equal to 64 and the host segment must be all zeros.</p> |
| Prefix Length             | <p>Enter the prefix length for all global addresses to specify how many of the most significant bits (MSBs) are used for the network identifier. Enter an integer from 1 to 128. If you use the optional EUI-64 check box for the global and peer addresses, the prefix must be less than or equal to 64.</p>                                                                                                                                                                                                                                                                                                                                                                                                                                                                                                                                                                                                                                                                                                             |

Table 12-3 BVI Interface Attributes (continued)

| Field                                                                                                                            | Description                                                                                                                                                                                                                                                                                                                                                                                                                                                                                                                                                                                              |
|----------------------------------------------------------------------------------------------------------------------------------|----------------------------------------------------------------------------------------------------------------------------------------------------------------------------------------------------------------------------------------------------------------------------------------------------------------------------------------------------------------------------------------------------------------------------------------------------------------------------------------------------------------------------------------------------------------------------------------------------------|
| IPv6 Link-Local Address                                                                                                          | <p>Field that appears only for ACE module and ACE appliance software Version A5(1.0) or later. By default, when you enable IPv6 or configure any other valid IPv6 address on an interface, the ACE automatically creates a link local address for it. Every link local address must have a predefined prefix of FE80::/10. You can configure only one IPv6 link local address on an interface. This address always has the prefix of 64.</p> <p>To manually configure the link local address, enter a complete IPv6 address with an FE80::/10 prefix in this field. For example, enter FE80:DB8:1::1</p> |
| IPv6 Peer Link-Local Address                                                                                                     | <p>Field that appears only for ACE module and ACE appliance software Version A5(1.0) or later. In a redundant configuration, you can configure an IPv6 peer link local address for the standby ACE. You can configure only one peer link local address on an interface.</p> <p>To configure the peer link local address, enter a complete IPv6 address with an FE80::/10 prefix in this field.</p> <p> <b>Note</b> The IPv6 peer link local address must be unique across multiple contexts on a shared VLAN.</p>       |
| <b>More Settings</b> (The More Settings option appears only for ACE module and ACE appliance software Version A5(1.0) or later.) |                                                                                                                                                                                                                                                                                                                                                                                                                                                                                                                                                                                                          |
| Managed-Config                                                                                                                   | <p>Check box to indicate that the interface use the stateful autoconfiguration mechanism to configure IPv6 addresses.</p> <p>Uncheck the check box to indicate that the interface does not use the stateful autoconfiguration mechanism to configure IPv6 addresses.</p>                                                                                                                                                                                                                                                                                                                                 |
| Other-Config                                                                                                                     | <p>Check box to indicate that the interface use the stateful autoconfiguration mechanism to configure parameters other than IPv6 addresses.</p> <p>Clear the check box to indicate that the interface does not use the stateful autoconfiguration mechanism to configure parameters other than IPv6 addresses.</p>                                                                                                                                                                                                                                                                                       |
| NS Interval                                                                                                                      | <p>The ACE sends neighbor solicitation messages through ICMPv6 on the local link to determine the IPv6 addresses of nearby nodes (hosts or routers). You can configure the rate at which the ACE sends these neighbor solicitation messages.</p> <p>By default, the interval at which the ACE sends NS messages for DAD default is 1000 milliseconds (msecs). To configure the interval, enter an integer from 1000 to 2147483647.</p>                                                                                                                                                                   |
| NS Reachable Time                                                                                                                | <p>The neighbor solicitation reachable time is the time period in milliseconds during which a host considers the peer is reachable after a reachability confirmation from the peer. A reachability confirmation can include neighbor solicitation or advertisement, or any upper protocol traffic.</p> <p>By default, this time period is 0 milliseconds. To configure this time, enter an integer from 0 to 3600000.</p>                                                                                                                                                                                |
| Retransmission time                                                                                                              | <p>By default, the advertised retransmission time is 0 milliseconds.</p> <p>To configure the retransmission time, enter an integer from 0 to 3600000.</p>                                                                                                                                                                                                                                                                                                                                                                                                                                                |
| DAD Attempts                                                                                                                     | <p>By default, the number of attempts for sending duplicate address detection (DAD) is 1.</p> <p>To configure the DAD attempts, enter an integer from 0 to 255.</p>                                                                                                                                                                                                                                                                                                                                                                                                                                      |
| RA Hop Limit                                                                                                                     | <p>By default, the hop limit that neighbors should use when originating IPv6 packets is 64. To configure the hop limit in the IPv6 header, enter an integer from 0 to 255.</p>                                                                                                                                                                                                                                                                                                                                                                                                                           |

Table 12-3 BVI Interface Attributes (continued)

| Field                              | Description                                                                                                                                                                                                                                                                                                                                                                                                                                                                                                                                                                                                                                                                                                                                                                                                                                                                                                                                                                                                                                                                                                                         |
|------------------------------------|-------------------------------------------------------------------------------------------------------------------------------------------------------------------------------------------------------------------------------------------------------------------------------------------------------------------------------------------------------------------------------------------------------------------------------------------------------------------------------------------------------------------------------------------------------------------------------------------------------------------------------------------------------------------------------------------------------------------------------------------------------------------------------------------------------------------------------------------------------------------------------------------------------------------------------------------------------------------------------------------------------------------------------------------------------------------------------------------------------------------------------------|
| RA Lifetime                        | <p>The RA lifetime is the length of time that neighboring nodes should consider the ACE as the default router before they send RS messages again.</p> <p>By default, this length of time is 1800 seconds (30 minutes). To configure the RA lifetime, enter an integer from 0 to 9000.</p>                                                                                                                                                                                                                                                                                                                                                                                                                                                                                                                                                                                                                                                                                                                                                                                                                                           |
| RA Interval                        | <p>By default, the rate at which the ACE sends RA messages is 600 seconds. To configure the rate, enter an integer from 4 to 1800.</p>                                                                                                                                                                                                                                                                                                                                                                                                                                                                                                                                                                                                                                                                                                                                                                                                                                                                                                                                                                                              |
| Suppress RA                        | <p>By default, the ACE automatically responds to RS messages that it receives from neighbors with RA messages that include, for example, the network prefix. You can instruct the ACE to not respond to RS messages.</p> <p>Check the check box to instruct the ACE to not respond to RS messages.</p> <p>Clear the check box to reset the default behavior of automatically responding to RS messages.</p>                                                                                                                                                                                                                                                                                                                                                                                                                                                                                                                                                                                                                                                                                                                         |
| IPv6 Router Advertisement Settings | <p>Click the <b>Add</b> button to configure the IPv6 prefixes that the ACE advertises in RA messages on the local link.</p>                                                                                                                                                                                                                                                                                                                                                                                                                                                                                                                                                                                                                                                                                                                                                                                                                                                                                                                                                                                                         |
| IPv6 Address/Prefix Length         | <p>To configure IPv6 address advertised in the RA messages, enter a complete IPv6 address in the first field. In the second field after the /, enter the prefix length to specify how many of the most significant bits (MSBs) are used for the network identifier.</p>                                                                                                                                                                                                                                                                                                                                                                                                                                                                                                                                                                                                                                                                                                                                                                                                                                                             |
| No Advertisements                  | <p>Check the check box to indicate that the route prefix is not advertised.</p> <p>Clear the check box to indicate that the route prefix is advertised.</p>                                                                                                                                                                                                                                                                                                                                                                                                                                                                                                                                                                                                                                                                                                                                                                                                                                                                                                                                                                         |
| Lifetime                           | <p>Configure the prefix lifetime attributes as follows:</p> <ul style="list-style-type: none"> <li>• Lifetime Duration: <ul style="list-style-type: none"> <li>– Valid Lifetime—By default, the prefix lifetime is 2592000 seconds (30 days). To configure the prefix lifetime in seconds, enter an integer from 0 to 2147183647.</li> <li>Select Infinite to indicate that the prefix never expires.</li> <li>– Preferred Lifetime—By default, the prefix lifetime is 604800 seconds (10 days). To configure how long an IPv6 address remains preferred in seconds, enter an integer from 0 to 2147183647. This lifetime must not exceed the Valid Lifetime.</li> <li>Select Infinite to indicate that the preferred lifetime never expires.</li> </ul> </li> <li>• Lifetime Expiration Date: <ul style="list-style-type: none"> <li>– Valid Month/Day/Year/Time—Valid lifetime expiration date and time.</li> <li>– Preferred Month/Day/Year/Time—Preferred lifetime expiration date and time.</li> </ul> </li> </ul> <p>Use the drop-down lists to select a day, month, and year. To specify the time, use the hh:mm format.</p> |

**Table 12-3** BVI Interface Attributes (continued)

| Field         | Description                                                                                                                                                                                                                                                                                                |
|---------------|------------------------------------------------------------------------------------------------------------------------------------------------------------------------------------------------------------------------------------------------------------------------------------------------------------|
| Off-link      | This option appears when you enter a Preferred Lifetime field.<br>Check this check box to indicate that the route prefix is on a different subnet for a router to route to it.<br>Clear the check box to indicate that the route prefix is on the same subnet for a router to route to it.                 |
| No-autoconfig | This option appears when you enter a Preferred Lifetime field.<br>Check this check box to indicate to the host that it cannot use this prefix when creating an stateless IPv6 address.<br>Clear the check box to indicate to the host that it can use this prefix when creating an stateless IPv6 address. |

**Step 5** Do one of the following:

- Click **Deploy Now** to immediately deploy this configuration on the ACE and save your entries to the running-configuration and startup-configuration files. This option appears for virtual contexts.
- Click **Cancel** to exit this procedure without saving your entries and to return to the previous table.

**Step 6** To display statistics and status information for a BVI interface, choose the BVI interface from the BVI Interface table, and click **Details**.

The **show interface bvi**, **show ipv6 interface bvi**, and **show ipv6 neighbors** CLI command outputs appears. IPv6 commands requires ACE module and ACE appliance software Version A5(1.0) or later. See the “[Displaying BVI Interface Statistics and Status Information](#)” section on page 12-26 for details.

#### Related Topics

- [Configuring Network Access, page 12-1](#)
- [Configuring Virtual Context Primary Attributes, page 6-14](#)

## Displaying All BVI Interfaces by Context

You can display all of the BVI interfaces associated with a specific context by choosing **Config > Devices > context > Network > BVI Interfaces**.

The BVI Interface table appears with the information shown in [Table 12-4](#).

**Table 12-4** BVI Interface Fields

| Field              | Description                                                                                                                                                                                           |
|--------------------|-------------------------------------------------------------------------------------------------------------------------------------------------------------------------------------------------------|
| BVI                | Name of the BVI interface.                                                                                                                                                                            |
| Description        | Description for the BVI interface.                                                                                                                                                                    |
| IP Address         | IP address assigned to this interface including the netmask for an IPv4 address or a prefix length for an IPv6 address. IPv6 requires ACE module and ACE appliance software Version A5(1.0) or later. |
| IPv6 Config Status | The status whether IPv6 is enabled or disabled on the interface. IPv6 requires ACE module and ACE appliance software Version A5(1.0) or later.                                                        |

Table 12-4 BVI Interface Fields (continued)

| Field              | Description                                                                              |
|--------------------|------------------------------------------------------------------------------------------|
| Admin Status       | Status of the interface, which can be Up or Down.                                        |
| Operational Status | Operational state of the device (Up or Down).                                            |
| Last Polled        | Date and time of the last time that ANM polled the device to display the current values. |

**Related Topics**

- [Displaying BVI Interface Statistics and Status Information, page 12-26](#)

## Displaying BVI Interface Statistics and Status Information

You can display statistics and status information for a particular BVI interface by using the **Details** button.

**Procedure**

- 
- Step 1** Choose **Config > Devices > context > Network > BVI Interfaces**.
- The BVI Interface table appears.
- Step 2** In the BVI Interface table, choose a BVI interface from the BVI Interface table, and click **Details**.
- The **show interface bvi**, **show ipv6 interface bvi**, and **show ipv6 neighbors** CLI command outputs appear. The IPv6 commands require ACE module and ACE appliance software Version A5(1.0) or later. For details about the displayed output fields, see either the *Cisco ACE Module Routing and Bridging Configuration Guide* or the *Cisco ACE 4700 Series Appliance Routing and Bridging Configuration Guide*.
- Step 3** Click **Update Details** to refresh the command output.
- Step 4** Click **Close** to return to the BVI Interface table.
- 

**Related Topics**

- [Displaying All BVI Interfaces by Context, page 12-25](#)

## Configuring VLAN Interface NAT Pools

You can configure Network Address Translation (NAT) pools for a VLAN interface. NAT is designed to simplify and conserve IP addresses. It allows private IP networks that use unregistered IP addresses to connect to the Internet. NAT operates on a router, usually connecting two networks, and translates the private (not globally unique) addresses in the internal network into legal addresses before the packets are forwarded to another network.

The ACE allows you to configure NAT so that it advertises only one address for the entire network to the outside world. This feature, which effectively hides the entire internal network behind that address, offers both security and address conservation.



Several internal addresses can be translated to only one or a few external addresses by using Port Address Translation (PAT) in conjunction with NAT. With PAT, you can configure static address translations at the port level and use the remainder of the IP address for other translations. PAT effectively extends NAT from one-to-one to many-to-one by associating the source port with each flow.



**Note** The options that appear when you choose **Config > Devices > context** depend on the device associated with the virtual context and the role associated with your account.



**Note** Fields and information related to IPv6 require ACE module and ACE appliance software Version A5(1.0) or later.



**Note** When server load balancing is IPv6 to IPv4 or IPv4 to IPv6, you must configure source NAT.

### Assumption

You have successfully configured at least one VLAN interface (see the [“Configuring Virtual Context VLAN Interfaces”](#) section on page 12-6).

### Procedure

- 
- Step 1** Choose **Config > Devices > context > Network > NAT Pools**.  
The NAT Pools table appears.
- Step 2** In the NAT Pools table, click **Add** to add a new NAT pool, or choose an existing NAT pool and click **Edit** to modify it.
- 

**Note** If you click **Edit**, not all of the fields can be modified.
- 
- Step 3** Choose the VLAN interface that you want to configure a NAT pool for and click the **NAT Pool** tab.  
The NAT Pool configuration table appears.
- Step 4** In the NAT Pool configuration table, click **Add** to add a new entry.
- Step 5** In the VLAN ID field, from the drop-down list, choose a VLAN entry.
- Step 6** In the NAT Pool ID field, either accept the automatically incremented entry or enter a new number to uniquely identify this pool.  
Valid entries are from 1 to 2147483647.
- Step 7** In the IP Address Type field, choose either **IPv4** or **IPv6**.  
This field appears only for ACE module and ACE appliance software Version A5(1.0) or later, which supports IPv4 and IPv6.
- Step 8** In the Start IP Address field, enter an IP address for the selected IP Address Type.  
This entry identifies either a single IP address or, if using a range of IP addresses, the first IP address in a range of global addresses for this NAT pool.
- Step 9** In the End IP Address field, enter the highest IP address in a range of global IP addresses for this NAT pool.

Enter the IP address for the selected IP Address Type. Leave this field blank if you want to identify only the single IP address in the Start IP Address field.

- Step 10** Depending on the IP address type that you chose, do one of the following:
- For IPv4, in the Netmask field, choose the subnet mask for the global IP addresses in the NAT pool.
  - For IPv6, in the Prefix Length field, enter the prefix length for the global IP addresses in the NAT pool.
- Step 11** Check the PAT Enabled check box to instruct the ACE to perform port address translation (PAT) in addition to NAT.
- Uncheck the check box to indicate that the ACE is not to perform port address translation (PAT) in addition to NAT.
- Step 12** Do one of the following:
- Click **Deploy Now** to immediately deploy this configuration on the ACE and save your entries to the running-configuration and startup-configuration files. This option appears for virtual contexts.
  - Click **Cancel** to exit this procedure without saving your entries and to return to the NAT Pools table.
  - Click **Next** to deploy your entries and to add another NAT Pool entry.

#### Related Topics

- [Configuring Virtual Context VLAN Interfaces, page 12-6](#)
- [Configuring Virtual Context BVI Interfaces, page 12-19](#)

## Configuring Virtual Context Static Routes

You can configure context static routes. Admin and user context modes do not support dynamic routing, therefore you must use static routes for any networks to which the ACE is not directly connected, such as when there is a router between a network and the ACE.



#### Note

Fields and information related to IPv6 require ACE module and ACE appliance software Version A5(1.0) or later.

#### Procedure

- Step 1** Choose **Config > Devices > context > Network > Static Routes**.

The Static Routes configuration table appears and displays the following information:

- Destination prefix
- Destination prefix mask
- Next hop IP address

- Step 2** In the Static Routes configuration table, click **Add** to add a new static route.



#### Note

You cannot modify an existing static route. To make changes to an existing static route, you must delete the static route and then add it back.

- Step 3** In the IP Address Type, choose either **IPv4** or **IPv6** for the route.
- This field appears only for ACE module and ACE appliance software Version A5(1.0) or later, which supports IPv4 or IPv6.
- Step 4** In the Destination Prefix field, enter the IP address based on the address type (IPv4 or IPv6) for the route.
- The address that you specify for the static route is the address that is in the packet before entering the ACE and performing network address translation.
- Step 5** Depending on the IP address type that you chose, do one of the following:
- For IPv4, in the Destination Prefix Mask field, choose the subnet to use for this route.
  - For IPv6, in the Destination Prefix-length field, enter the prefix length from 0 to 128 to use for this route.
- Step 6** (IPv6 IP address type only) For the Forward Interface Type, choose one of the following:
- N/A (Not applicable)
  - VLAN
  - BVI
- If you select VLAN or BVI, select its number from the drop down menu. To configure an interface, click Plus. After configuring it, select its number from the drop down menu.
- Step 7** In the Next Hop field, enter the IP address of the gateway router based on the address type (IPv4 or IPv6) for this route.
- The gateway address must be in the same network as a VLAN interface for this context.
- Step 8** Do one of the following:
- Click **Deploy Now** to immediately deploy this configuration on the ACE and save your entries to the running-configuration and startup-configuration files. This option appears for virtual contexts.
  - Click **Cancel** to exit this procedure without saving your entries and to return to the previous table.
  - Click **Next** to deploy your entries and to add another static route.
- 

#### Related Topics

- [Configuring Virtual Contexts, page 6-8](#)
- [Configuring Virtual Context Primary Attributes, page 6-14](#)

## Configuring Global IP DHCP

You can configure the Dynamic Host Configuration (DHCP) relay agent at the context level so the configuration applies to all interfaces associated with the context. When you configure the ACE as a DHCP relay agent, it is responsible for forwarding the requests and responses that are negotiated between the DHCP clients and the server. By default, the DHCP relay agent is disabled. You must configure a DHCP server when you enable the DHCP relay agent.



#### Note

The options that appear when you choose **Config > Devices > context** depend on the device associated with the virtual context and the role associated with your account.

**Note**

Fields and information related to IPv6 require ACE module and ACE appliance software Version A5(1.0) or later.

**Procedure**

- 
- Step 1** Choose **Config > Devices > context > Network > Global IP DHCP**.
- The Global IP DHCP configuration table appears.
- Step 2** From the Global IP DHCP configuration table, in the **Enable DHCP Relay For The Context** field, click **IPv4**, **IPv6**, or both to enable DHCP relay for the context and all interfaces associated with this context.
- For ACE module and ACE appliance software versions earlier than A5(1.0), this field does not include the IP version number and is for IPv4 only.
- Step 3** In the Relay Agent Information Reforwarding Policy field, choose a relay agent information forwarding policy:
- **N/A**—Specifies to not configure the DHCP relay to identify what is to be performed if a forwarded message already contains relay information.
  - **Keep**—Specifies that existing information is left unchanged on the DHCP relay agent.
  - **Replace**—Specifies that existing information is overwritten on the DHCP relay agent.
- Step 4** In the IP DHCP Server field, choose the IP DHCP server to which the DHCP relay agent is to forward client requests.
- Step 5** In the IPv6 Forward Interface VLAN field, you can optionally enter the VLAN interface number that you configured in the [IPv6 DHCP Forward Interface VLAN](#) field on the interface where the multicast DHCP relay message is sent.
- This field appears only for ACE module and ACE appliance software Version A5(1.0) or later.
- Step 6** In the IPv6 DHCP server, specify one or more IP DHCP servers and IPv6 addresses to which the DHCP relay agent is to forward client requests.
- This field appears only for ACE module and ACE appliance software Version A5(1.0) or later.
- Step 7** Do one of the following:
- Click **Deploy Now** to immediately deploy this configuration on the ACE and save your entries to the running-configuration and startup-configuration files. This option appears for virtual contexts.
  - Click **Cancel** to exit this procedure without saving your entries and to return to the previous table.
  - Click **Next** to deploy your entries and to add another DHCP relay entry.
-

# Configuring Static VLANs for Over 8000 Static NAT Configurations

**Note**

This feature applies to ACE modules only and was deprecated beginning with ACE software Version A5(1.0).

You can create more than 8,000 static NAT configurations (one static NAT configuration with a netmask is counted as one configuration). In addition, follow these restrictions and guidelines when using this feature:

- This feature is supported in routed mode only.
- Only one mapped interface is allowed per virtual context. However, each static NAT configuration must have a different mapped IP address.
- At any point, you can configure no more than one next-hop on the mapped interface.
- Bidirectional NAT, or in other words, source-address as well as destination-address translation, for the same flow is not supported.
- You must have fewer than 1,000 real IP addresses on the same subnet as the real interface. In addition, you must have fewer than 1,000 mapped IP address on the same subnet as the mapped interface.
- If you use this feature, we recommended that you do not use MP-based NAT for the same virtual context.

**Procedure**

- 
- Step 1** Choose **Config > Devices > context > Network > Static NAT Overwrite**.
- The Static NAT Overwrite configuration table appears.
- Step 2** In the Static NAT Overwrite configuration table, click **Add** to add a new static NAT.
- Step 3** In the Mapped IP Address field, enter the IP address to which the real IP address is translated.
- In a context, the mapped IP address must be different in each static NAT configuration.
- Step 4** In the Real VLAN Number field, choose the VLAN number of the interface connected to the real IP address network.
- The list of available real VLANs includes routed mode VLANs only (for more information, see [Interface Type](#)).
- Step 5** In the Mapped VLAN Number field, choose the VLAN number of the interface connected to the mapped IP address network.
- The list of available mapped VLANs includes routed mode VLANs only (for more information, see [Interface Type](#)). In a context, the mapped interface must be the same in each static NAT configuration.
- Step 6** In the Real IP Address field, enter the real server IP address to be translated.
- In a context, you must configure a different address for configurations that have the same real server interface.
- Step 7** In the Real IP Netmask field, choose the subnet mask for the real server address.
- Step 8** Do one of the following:

- Click **Deploy Now** to immediately deploy this configuration on the ACE and save your entries to the running-configuration and startup-configuration files. This option appears for virtual contexts.
- Click **Cancel** to exit this procedure without saving your entries and to return to the previous table.
- Click **Next** to deploy your entries and to add another DHCP relay entry.

## Configuring Gigabit Ethernet Interfaces on the ACE Appliance



### Note

This feature is for ACE appliances only.

You can configure a Gigabit Ethernet interface on the ACE appliance, which provides physical Ethernet ports to connect servers, PCs, routers, and other devices to the ACE appliance. The ACE appliance supports four Layer 2 Ethernet ports for performing Layer 2 switching. You can configure the four Ethernet ports to provide an interface for connecting to 10-Mbps, 100-Mbps, or 1000-Mbps networks. Each Layer 2 Ethernet port supports autonegotiate, full-duplex, or half-duplex operation on an Ethernet LAN, and can carry traffic within a designated VLAN.

A Layer 2 Ethernet port can be configured as follows:

- **Member of Port-Channel Group**—The port is configured as a member of a port-channel group, which associates a physical port on the ACE appliance to a logical port to create a port-channel logical interface. The VLAN association is derived from port-channel configuration. The port is configured as a Layer 2 EtherChannel, where each EtherChannel bundles the individual physical Ethernet data ports into a single logical link that provides the aggregate bandwidth of up to four physical links on the ACE.
- **Access VLAN**—The port is assigned to a single VLAN. This port is referred to as an access port and provides a connection for end users or node devices, such as a router or server.
- **Trunk port**—The port is associated with IEEE 802.1Q encapsulation-based VLAN trunking to allocate VLANs to ports and to pass VLAN information (including VLAN identification) between switches for all Ethernet channels defined in a Layer 2 Ethernet data port or a Layer 2 EtherChannel (port-channel) group on the ACE appliance.

This section includes the following topics:

- [Configuring Gigabit Ethernet Interfaces, page 12-32](#)
- [Displaying Gigabit Ethernet Interface Statistics and Status Information, page 12-35](#)

## Configuring Gigabit Ethernet Interfaces

This section describes how to configure Gigabit Interfaces on the ACE.

### Procedure

- Step 1** Choose **Config > Devices > context > Network > GigabitEthernet Interfaces**.  
The GigabitEthernet Interfaces table appears.
- Step 2** In the GigabitEthernet Interfaces table, click **Poll Now** to instruct ANM to poll the devices and display the current values, and click **OK** when prompted to poll the devices for data.



**Step 3** Choose an existing gigabit Ethernet interface, and click **Edit** to modify it.

**Step 4** Enter the gigabit Ethernet physical interface attributes (see [Table 12-5](#)).

**Table 12-5** *Physical Interface Attributes*

| Field               | Description                                                                                                                                                                                                                                                                                                                                                                                                                                                                                                                                                                                                                                                                                                                                                                                                                                                                                                                                                                                                                                                                                                   |
|---------------------|---------------------------------------------------------------------------------------------------------------------------------------------------------------------------------------------------------------------------------------------------------------------------------------------------------------------------------------------------------------------------------------------------------------------------------------------------------------------------------------------------------------------------------------------------------------------------------------------------------------------------------------------------------------------------------------------------------------------------------------------------------------------------------------------------------------------------------------------------------------------------------------------------------------------------------------------------------------------------------------------------------------------------------------------------------------------------------------------------------------|
| Interface Name      | Name of the Gigabit Ethernet interface, which is in the format <i>slot_number/port_number</i> where <i>slot_number</i> is the physical slot on the ACE for the specified port, and <i>port_number</i> is the physical Ethernet data port on the ACE for the specified port.                                                                                                                                                                                                                                                                                                                                                                                                                                                                                                                                                                                                                                                                                                                                                                                                                                   |
| Description         | Brief description for this interface.                                                                                                                                                                                                                                                                                                                                                                                                                                                                                                                                                                                                                                                                                                                                                                                                                                                                                                                                                                                                                                                                         |
| Admin Status        | Administrative state of the interface: <b>Up</b> or <b>Down</b> .                                                                                                                                                                                                                                                                                                                                                                                                                                                                                                                                                                                                                                                                                                                                                                                                                                                                                                                                                                                                                                             |
| Speed               | Port speed: <ul style="list-style-type: none"> <li>• <b>Auto</b>—Autonegotiate with other devices</li> <li>• <b>10 Mbps</b></li> <li>• <b>100 Mbps</b></li> <li>• <b>1000 Mbps</b></li> </ul>                                                                                                                                                                                                                                                                                                                                                                                                                                                                                                                                                                                                                                                                                                                                                                                                                                                                                                                 |
| Duplex              | Interface duplex mode: <ul style="list-style-type: none"> <li>• <b>Auto</b>—Resets the specified Ethernet port to automatically negotiate port speed and duplex of incoming signals. This is the default setting.</li> <li>• <b>Full</b>—Configures the specified Ethernet port for full-duplex operation, which allows data to travel in both directions at the same time.</li> <li>• <b>Half</b>—Configures the specified Ethernet port for half-duplex operation. A half-duplex setting ensures that data only travels in one direction at any given time.</li> </ul>                                                                                                                                                                                                                                                                                                                                                                                                                                                                                                                                      |
| Port Operation Mode | Port operation mode: <ul style="list-style-type: none"> <li>• <b>N/A</b>—Specifies that this option is not to be used.</li> <li>• <b>Channel Group</b>—Specifies to map the port to a port channel. You must specify: <ul style="list-style-type: none"> <li>• Port Channel Group Number—Specifies the port channel group number.</li> <li>• HA VLAN—Specifies the high availability (HA) VLAN used for communication between the members of the FT group.</li> </ul> </li> <li>• <b>Switch Port</b>—Specifies the interface switch port type: <ul style="list-style-type: none"> <li>• Access—Specifies that the port interface is an access port. You must specify a VLAN as an access port in the Access VLAN field.</li> <li>• Trunk—Specifies that the port interface is a trunk port. When you choose Trunk, you must complete one or both of the following fields: <ul style="list-style-type: none"> <li>- Trunk Native VLAN—Identifies the 802.1Q native VLAN for a trunk.</li> <li>- Trunk Allowed VLANs—Selectively allocates individual VLANs to a trunk link.</li> </ul> </li> </ul> </li> </ul> |
| HA LAN              | High availability (HA) VLAN used for communication between the members of the FT group.                                                                                                                                                                                                                                                                                                                                                                                                                                                                                                                                                                                                                                                                                                                                                                                                                                                                                                                                                                                                                       |

Table 12-5 Physical Interface Attributes (continued)

| Field         | Description                                                                                                                                                                                                                                                                                                                                                                                                                                                                                                                                                                                                                                                                                                                                                                                                                                                                                                                                                                           |
|---------------|---------------------------------------------------------------------------------------------------------------------------------------------------------------------------------------------------------------------------------------------------------------------------------------------------------------------------------------------------------------------------------------------------------------------------------------------------------------------------------------------------------------------------------------------------------------------------------------------------------------------------------------------------------------------------------------------------------------------------------------------------------------------------------------------------------------------------------------------------------------------------------------------------------------------------------------------------------------------------------------|
| Carrier Delay | <p>Configurable delay at the physical port level to address any issues with transition time, based on the variety of peers. Valid values are from 0 to 120 seconds. The default is 0 (no carrier delay).</p> <p> <b>Note</b> If you connect an ACE to a Catalyst 6500 series switch, your configuration on the switch may include the Spanning-Tree Protocol (STP). However, the ACE does not support STP. In this case, you may find that the Layer 2 convergence time is much longer than the physical port up time. For example, the physical port would normally be up within 3 seconds, but STP moving to the forward state may need approximately 30 seconds. During this transitional time, although the ACE declares the port to be up, the traffic does not pass. In this case, you should specify a carrier delay.</p>                                                                     |
| QoS Trust COS | <p>Quality of Service (QoS) for the physical Ethernet port. By default, QoS is disabled for each physical Ethernet port on the ACE.</p> <p>QoS for a configured physical Ethernet port is based on VLAN Class of Service (CoS) bits (priority bits that segment the traffic in eight different classes of service). When you enable QoS on a port (a trusted port), traffic is mapped into different ingress queues based on their VLAN CoS bits. If there are no VLAN CoS bits, or QoS is not enabled on the port (untrusted port), the traffic is then mapped into the lowest priority queue.</p> <p>You can enable QoS for an Ethernet port configured for fault tolerance. In this case, heartbeat packets are always tagged with CoS bits set to 7 (a weight of High).</p> <p> <b>Note</b> We recommend that you enable QoS on the FT VLAN port to provide higher priority for FT traffic.</p> |

**Step 5** Do one of the following:

- Click **Deploy Now** to immediately deploy this configuration on the ACE and save your entries to the running-configuration and startup-configuration files.
- Click **Cancel** to exit the procedure without saving your changes and to return to the Physical Interface table.
- Click **Next** or **Previous** to go to the next or previous physical channel.
- Click **Delete** to remove this entry from the Physical Interface table and to return to the table.

**Step 6** (Optional) To display statistics and status information for a particular Gigabit Ethernet interface, choose the interface from the GigabitEthernet Interfaces table, and click **Details**.

The **show interface gigabitEthernet** CLI command output appears. See the “[Displaying Gigabit Ethernet Interface Statistics and Status Information](#)” section on page 12-35 for details.

**Related Topics**

- [Configuring Virtual Context VLAN Interfaces, page 12-6](#)
- [Configuring Virtual Context BVI Interfaces, page 12-19](#)
- [Configuring Port-Channel Interfaces for the ACE Appliance, page 12-35](#)



## Displaying Gigabit Ethernet Interface Statistics and Status Information

You can display statistics and status information for a particular Gigabit Ethernet interface.

### Procedure

- 
- Step 1** Choose **Config > Devices > context > Network > GigabitEthernet Interfaces**.
- The GigabitEthernet Interfaces table appears.
- Step 2** In the GigabitEthernet Interfaces table, choose a Gigabit Ethernet interface from the GigabitEthernet Interfaces table, and click **Details**.
- The **show interface gigabitEthernet** CLI command output appears. For details on the displayed output fields, see the *Cisco ACE 4700 Series Appliance Routing and Bridging Configuration Guide*.
- Step 3** (Optional) Click **Update Details** to refresh the display.
- Step 4** Click **Close** to return to the GigabitEthernet Interfaces table.
- 

### Related Topics

[Configuring Gigabit Ethernet Interfaces on the ACE Appliance, page 12-32](#)

## Configuring Port-Channel Interfaces for the ACE Appliance

This section discusses how to configure port channel interfaces for the ACE appliance. It consists of the following topics:

- [Why Use Port Channels?, page 12-35](#)
- [Configuring a Port-Channel Interface, page 12-36](#)
- [Configuring a Catalyst 6500 Series Switch for an ACE Appliance Port-Channel Interface Connection, page 12-38](#)
- [Displaying Port Channel Interface Statistics and Status Information, page 12-40](#)

## Why Use Port Channels?

A port channel groups multiple physical ports into a single logical port. This is also called port aggregation or channel aggregation. A port channel containing multiple physical ports has several advantages:

- Improves link reliability through physical redundancy.
- Allows greater total throughput to the ACE appliance. For example, four 1-Gigabit Ethernet interfaces can be aggregated into a single 4-Gigabit channel.
- Allows traffic capacity to be scaled up in the future, without network disruption at that time. A port channel can do everything a switched port can do, but a switched port cannot do everything a port channel can do. We recommend that you use a port channel.
- Provides maximum flexibility of network configuration and focuses network configuration on VLANs rather than physical cabling.

The disadvantage of a port channel is that it requires additional configuration on the switch the ACE is connected to, as well as the ACE itself. There are many methods of port aggregation implemented by different switches, and not every method works with ACE. For an example of how to configure a Cisco Catalyst 6500 switch to enable a port channel connection to ACE, see the “[Configuring a Catalyst 6500 Series Switch for an ACE Appliance Port-Channel Interface Connection](#)” section on page 12-38.

Using a port channel also requires more detailed knowledge of your network's VLANs, because all “cabling” to and from the ACE will be handled over VLANs rather than using physical cables. Nonetheless, use of port channels is highly recommended, especially in a production deployment of ACE.

Figure 12-1 illustrates a port channel interface.

**Figure 12-1 Example of a Port Channel Interface**

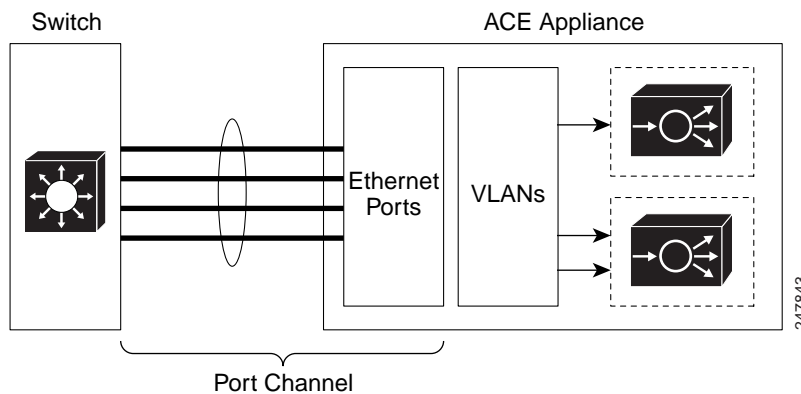

#### Related Topics

[Configuring a Port-Channel Interface, page 12-36](#)

[Displaying Port Channel Interface Statistics and Status Information, page 12-40](#)

## Configuring a Port-Channel Interface



#### Note

This feature is for ACE appliances only.

You can group physical ports together on the ACE appliance to form a logical Layer 2 interface called the port channel. All the ports belonging to the same port channel must be configured with same values; for example, port parameters, VLAN membership, and trunk configuration. Only one port channel in a channel group is allowed, and a physical port can belong to a single port-channel interface only.

- 
- Step 1** Choose **Config > Devices > context > Network > Port Channel Interfaces**.  
The Port Channel Interface table appears.
- Step 2** In the Port Channel Interface table, click **Poll Now** to instruct ANM to poll the devices and display the current values, and click **OK** when prompted to poll the devices for data.
- Step 3** Click **Add** to add a port channel interface, or choose an existing port channel interface and click **Edit** to modify it.



**Note** If you click **Edit**, not all of the fields can be modified.

**Step 4** Enter the port channel interface attributes (see [Table 12-6](#)).

**Table 12-6** Port Channel Interface Attributes

| Field                 | Description                                                                                                                                                                                                                                                                                                                                                                                                                                                                                                                                                                                                                                                                                                                                                                                                   |
|-----------------------|---------------------------------------------------------------------------------------------------------------------------------------------------------------------------------------------------------------------------------------------------------------------------------------------------------------------------------------------------------------------------------------------------------------------------------------------------------------------------------------------------------------------------------------------------------------------------------------------------------------------------------------------------------------------------------------------------------------------------------------------------------------------------------------------------------------|
| Interface Number      | Channel number for the port-channel interface, which can be from 1 to 255.                                                                                                                                                                                                                                                                                                                                                                                                                                                                                                                                                                                                                                                                                                                                    |
| Description           | Brief description for this interface.                                                                                                                                                                                                                                                                                                                                                                                                                                                                                                                                                                                                                                                                                                                                                                         |
| Fault Tolerant VLAN   | Fault tolerant (FT) VLAN used for communication between the members of the FT group.                                                                                                                                                                                                                                                                                                                                                                                                                                                                                                                                                                                                                                                                                                                          |
| Admin Status          | Administrative state of the interface: <b>Up</b> or <b>Down</b> .                                                                                                                                                                                                                                                                                                                                                                                                                                                                                                                                                                                                                                                                                                                                             |
| Load Balancing Method | Load balancing method: <ul style="list-style-type: none"> <li>• <b>Dst-IP</b>—Loads distribution on the destination IP address.</li> <li>• <b>Dst-MAC</b>—Loads distribution on the destination MAC address.</li> <li>• <b>Dst-Port</b>—Loads distribution on the destination TCP or UDP port.</li> <li>• <b>Src-Dst-IP</b>—Loads distribution on the source or destination IP address.</li> <li>• <b>Src-Dst-MAC</b>—Loads distribution on the source or destination MAC address.</li> <li>• <b>Src-Dst-Port</b>—Loads distribution on the source or destination port.</li> <li>• <b>Src-IP</b>—Loads distribution on the source IP address.</li> <li>• <b>Src-MAC</b>—Loads distribution on the source MAC address.</li> <li>• <b>Src-Port</b>—Loads distribution on the TCP or UDP source port.</li> </ul> |
| Switch Port Type      | Interface switchport type: <ul style="list-style-type: none"> <li>• <b>N/A</b>—Indicates that the switchport type is not specified.</li> <li>• <b>Access</b>—Specifies that the port interface is an access port. You must specify a VLAN as an access port in the Access VLAN field.</li> <li>• <b>Trunk</b>—Specifies that the port interface is a trunk port. When you choose Trunk, you must complete the following fields: <ul style="list-style-type: none"> <li>– Trunk Native VLAN—Identifies the 802.1Q native VLAN for a trunk.</li> <li>– Trunk Allowed VLANs—Selectively allocate individual VLANs to a trunk link.</li> </ul> </li> </ul>                                                                                                                                                        |

**Step 5** Do one of the following:

- Click **Deploy Now** to immediately deploy this configuration on the ACE and save your entries to the running-configuration and startup-configuration files.
- Click **Cancel** to exit the procedure without saving your changes and to return to the Port Channel Interface table.
- Click **Next** to deploy your entries and to add another port-channel interface.

**Step 6** (Optional) To display statistics and status information for a particular port-channel interface, choose the interface from the Port Channel Interfaces table, and click **Details**.

The **show interface port-channel** CLI command output appears. See the “[Displaying Port Channel Interface Statistics and Status Information](#)” section on page 12-40 for details.

#### Related Topics

- [Configuring Port-Channel Interfaces for the ACE Appliance, page 12-35](#)
- [Configuring Port-Channel Interfaces for the ACE Appliance, page 12-35](#)
- [Displaying Port Channel Interface Statistics and Status Information, page 12-40](#)
- [Configuring Virtual Context VLAN Interfaces, page 12-6](#)

## Configuring a Catalyst 6500 Series Switch for an ACE Appliance Port-Channel Interface Connection

This section provides information for you to configure a port-channel interface on a network device such as the Catalyst 6500 Series switch. After you configure the port channels for the ACE appliance through ANM and you physically connect the Gigabit Ethernet physical interfaces on the ACE appliance to the Catalyst 6500 Series switch ports, configure the port channels on the switch. The information outlined in this topic is intended as an example of configuring port channels on a switch. You can adapt this information for whatever switch the ACE appliance is connected to in your network.

For specific details on configuring the Catalyst 6500 Series switch, see the documentation set on [www.Cisco.com](http://www.Cisco.com).

This section includes the following topics:

- [Creating the Port Channel Interface on the Catalyst 6500](#)
- [Adding Interfaces to the Port Channel](#)

### Creating the Port Channel Interface on the Catalyst 6500

This section contains an example in which a Catalyst 6500 Series switch is configured with a port channel using an 802.1q trunk that allows the associated VLANs. The native VLAN of the trunk is VLAN 10.



#### Note

Default VLAN 1 should not be used for the native VLAN because this VLAN is used internally on the ACE appliance.

Port-channel load balancing is used to distribute the traffic load across each of the links in the port channel to ensure efficient utilization of each link. Port-channel load balancing on the Catalyst 6500 Series switch can use MAC addresses or IP addresses, Layer 4 port numbers, source addresses, destination addresses, or both source and destination addresses. By default, the ACE appliance uses Src-Dst-MAC to make a load balancing decision (see [Table 12-6](#)). We recommend that you use the source and destination Layer 4 port for the load-balancing decision.

The following example illustrates the CLI commands used to configure a port channel interface for the Catalyst 6500 Series switch:

```
Switch(config)# port-channel load-balance src-dst-port
Switch(config)# interface port-channel 1
Switch(config-if)# description For Connection with ACE Appliance
Switch(config-if)# switchport
Switch(config-if)# switchport mode trunk
Switch(config-if)# switchport trunk encapsulation dot1q
Switch(config-if)# switchport trunk native vlan 10
Switch(config-if)# switchport trunk allowed vlan 10,20,30,31, 40,50
Switch(config-if)# switchport nonegotiate
Switch(config-if)# mls qos trust cos
```

After you configure the port channel on the Catalyst 6500 Series switch, you can then add it to the configuration of the four interfaces as described in the “[Adding Interfaces to the Port Channel](#)” section on page 12-39.

**Note**

The ACE appliance does not support Port Aggregation Protocol (PAgP) or Link Aggregate Control Protocol (LACP) so the port-channel interface is configured using **mode on**.

## Adding Interfaces to the Port Channel

The following example illustrates the CLI commands used to configure the four switch ports 3/9 through 3/12 as members of the port channel on the Catalyst 6500 Series switch:

```
Switch(config-if)# int range Gig 3/9 - 12
Switch(config-if-range)# channel-group 1 mode on
Switch(config-if-range)# speed 1000
Switch(config-if-range)# spanning-tree portfast trunk
Switch(config-if-range)# no shut
```

On the ACE appliance, you can configure the Ethernet port speed for a setting of 10, 100, or 1000 Mbps by configuring the Speed field for a Gigabit Ethernet physical interface attributes (see [Table 12-5](#)). The default for the ACE appliance is the auto-negotiate interface speed. We recommend that you configure the speed to 1000 on both the Catalyst 6500 Series switch and the ACE appliance to avoid relying on auto negotiation of the interface speed. A speed setting of 1000 helps to avoid the possibility of the interface operating below the expected Gigabit speed and ensures that the port-channel interface reaches the maximum 4 Gbps throughput.

The ACE appliance does not implement Spanning-Tree protocol and does not take part in Spanning-Tree root bridge election process. PortFast is configured on the Catalyst 6500 Series switch to reduce the time required for spanning tree to allow traffic on the port connected to the ACE interface by immediately moving to the forwarding state, bypassing the block, listening, and learning states. The average time for switch port moving into a forward state is approximately 30 seconds. Using PortFast reduces this time to approximately 5 seconds.

**Note**

In virtual partitions operating in bridge mode, the ACE offers an option to bridge Spanning-Tree BPDUs between two VLANs to prevent the possibility of a loop. Such a loop may occur when two partitions actively forward traffic. This should not happen during normal operation; however, the option to bridge BPDUs provides a safeguard against this condition. Upon detecting BPDUs, the switch connected to the ACE appliance immediately blocks the port/VLAN from which the loop originated from. We recommend that you configure an ethertype ACL that includes the BPDU protocol and apply the ACL to Layer 2 interfaces in bridge mode.

## Displaying Port Channel Interface Statistics and Status Information

You can display statistics and status information for a particular port-channel interface.

### Procedure

---

**Step 1** Choose **Config > Devices > context > Network > Port Channel Interfaces**.

The Port Channel Interfaces table appears.

**Step 2** In the Port Channel Interfaces table, choose a port-channel interface from the Port Channel Interfaces table, and click **Details**.

The **show interface port-channel** CLI command output appears. For details about the displayed output fields, see the *Cisco ACE 4700 Series Appliance Routing and Bridging Configuration Guide*.

**Step 3** (Optional) Click **Update Details** to refresh the display.

**Step 4** Click **Close** to return to the Port Channel Interfaces table.

---

### Related Topics

[Configuring Port-Channel Interfaces for the ACE Appliance, page 12-35](#)



# CHAPTER 13

## Configuring High Availability

---

**Date:** 3/28/12

This chapter describes how to configure high availability for ANM servers and ACE devices.



**Note**

---

When naming ACE objects (such as a real server, virtual server, parameter map, class map, health probe, and so on), enter an alphanumeric string of 1 to 64 characters, which can include the following special characters: underscore (\_), hyphen (-), dot (.), and asterisk (\*). Spaces are not allowed.

If you are using ANM with an ACE module or ACE appliance and you configure a named object at the ACE CLI, keep in mind that ANM does not support all of the special characters that the ACE CLI allows you to use when configuring a named object. If you use special characters that ANM does not support, you may not be able to import or manage the ACE using ANM.

---

This chapter includes the following sections:

- [Understanding ANM High Availability, page 13-2](#)
- [Understanding ACE Redundancy, page 13-6](#)
- [Configuring ACE High Availability, page 13-14](#)
- [Configuring ACE High Availability Peers, page 13-15](#)
- [Clearing ACE High Availability Pairs, page 13-17](#)
- [Configuring ACE High Availability Groups, page 13-17](#)
- [Displaying High Availability Group Statistics and Status, page 13-21](#)
- [Switching Over an ACE High Availability Group, page 13-22](#)
- [Deleting ACE High Availability Groups, page 13-23](#)
- [ACE High Availability Tracking and Failure Detection Overview, page 13-23](#)
- [Tracking ACE VLAN Interfaces for High Availability, page 13-24](#)
- [Tracking Hosts for High Availability, page 13-25](#)
- [Configuring Host Tracking Probes, page 13-26](#)
- [Configuring ACE Peer Host Tracking Probes, page 13-28](#)
- [Configuring ACE HSRP Groups, page 13-29](#)
- [Synchronizing ACE High Availability Configurations, page 13-30](#)
- [Synchronizing SSL Certificate and Key Pairs on Both ACE Peers, page 13-32](#)

# Understanding ANM High Availability

ANM high availability (or fault tolerance) ensures that your network services and applications are always available. High availability (HA) provides seamless switchover of flows in case an ANM server becomes unresponsive or a critical host or interface fails. High availability uses two ANM nodes, where one node is the *active* node and the other is the *standby* node.

The ANM high availability features are as follows:

- Automatic determination of node status, whether *active* or *standby*, using heartbeat counts.
- Designation of the virtual IP address (VIP), which is associated with the active node.
- Near real-time replication of ANM configuration and events after a failover occurs.
- Automatic inspection of certificate/key presence on HA peer upon SSL certificate or key import.

During normal operation, ANM high availability performs the following actions:

- The two nodes constantly exchange heartbeat packets over both interfaces.
- Database operations that occur on the active node's database are replicated on the standby node's database.
- The monitor function ensures that the necessary processes are running on both the active and standby node. For example, not all processes necessarily run on the standby node, so after a node changes from active to standby, ANM high availability function stops certain processes on the standby node.

When you log into ANM, you log in using a virtual IP address (VIP) that associates with the active node. The VIP is the only IP address you need to remember. If the current active node fails, the standby node takes over as the active node and the VIP automatically associates with the node that has just become active. When a failover occurs and the standby node becomes the active node, all existing web sessions are lost. In addition, there is a slight delay while the standby node takes over as the active node. After the switchover is complete and the ANM fully initializes, you can log into ANM using the same VIP. All ANM functions remain the same.

ANM uses heartbeat counts to determine when a failover should occur. Because both nodes are constantly sending and receiving heartbeat packets, if heartbeat packets are no longer being received on a node, its peer node is determined to be dead. If this peer node was the active node, then the standby node takes over as the active node. The VIP automatically associates with the newly active node, and the monitoring process starts any necessary processes on the newly active node that were not already running.

Similarly, if you manually issue a failover to cause the active node to become the standby node, the heartbeat process disassociates the VIP from the node and tells the monitoring function to stop processes that are not normally run on the standby node.

## Related Topics

- [Understanding ANM High Availability Processes, page 13-3](#)
- [Configuring ANM High Availability Overview, page 13-3](#)
- [CLI Commands for ANM High Availability Processes, page 13-4](#)
- [Recovering From an HA Database Replication Failure, page 13-6](#)



## Understanding ANM High Availability Processes

During normal high availability operation, the active node runs all ANM processes required for normal operation of ANM. The standby node runs only a minimal set of processes. [Table 13-1](#) lists the processes, their descriptions, and on which node they run.



### Note

If you are running standalone ANM, all processes show in [Table 13-1](#), with the exception of the heartbeat process, are constantly running.

**Table 13-1 ANM High Availability Processes**

| Process   | Description                                                                                                   | Node on Which Process Runs |
|-----------|---------------------------------------------------------------------------------------------------------------|----------------------------|
| Monit     | Starts, stops, restarts, and monitors local ANM processes                                                     | Active and standby         |
| Heartbeat | Provides UDP-based heartbeat between nodes, helps determine active vs. standby states, and associates the VIP | Active and standby         |
| Mysql     | Provides persistent storage and implements database replication between active and standby nodes              | Active and standby         |
| ANM       | Java process                                                                                                  | Active node only           |
| DAL       | Java process                                                                                                  | Active node only           |
| Ip-disc   | Java process                                                                                                  | Active node only           |
| Licman    | Java process for license management                                                                           | Active and standby         |

### Related Topics

- [CLI Commands for ANM High Availability Processes, page 13-4](#)
- [Understanding ANM High Availability, page 13-2](#)
- [Configuring ACE High Availability, page 13-14](#)
- [Understanding ACE Redundancy, page 13-6](#)

## Configuring ANM High Availability Overview

Configuring ANM high availability depends on whether you are using ANM Virtual Appliance or ANM server.

### ANM Virtual Appliance

You can implement redundancy for ANM Virtual Appliance using the high availability feature of the underlying VMware vSphere platform. VMware HA (High Availability) detects faults in the operation of managed virtual machines and provides redundancy in case of a failure.

You implement VMware HA for ANM Virtual Appliance in the same manner as for any VM-based application running on VMware infrastructure; that is, ANM Virtual Appliance does not impose any special requirements for implementing VMware HA.

For additional information about installing ANM Virtual Appliance, see the [Installation Guide for the Cisco Application Networking Manager 5.2 Virtual Appliance](#).

### ANM Server

ANM high availability consists of two nodes, which both run the ANM software. Each node must have at least two network interfaces as follows:

- A primary interface, normally used to access the node.
- A heartbeat interface, which is used to provide additional redundancy. The heartbeat interfaces of the two nodes must be connected via a crossover Ethernet connection.
- The two Ethernet interfaces used on one of the hosts should match the two interfaces used on the other host, with regard to the subnets they participate in. For example, if HA Node 1 uses eth0 for the primary interface and eth1 for the heartbeat interface, then HA Node 2 should also use eth0 for the primary interface and eth1 for the heartbeat interface.

**Note**

---

ANM does not configure the primary and heartbeat IP addresses of the nodes' interfaces. You must manually configure the node's interfaces.

---

When you installed ANM, you provided values for high availability parameters, determined the node IDs of the two nodes designated as *Node 1* and *Node 2*. For additional information about the installation parameters, see the [Installation Guide for Cisco Application Networking Manager 5.2](#).

### Related Topics

- [Understanding ANM High Availability, page 13-2](#)
- [Configuring ACE High Availability Groups, page 13-17](#)
- [Configuring ACE High Availability, page 13-14](#)

## CLI Commands for ANM High Availability Processes

You use two commands to view ANM processes:

- Use the `/opt/CSCOanm/bin/anm-tool` command to start and stop the ANM processes and to view the status of the ANM processes.
- Use the `/opt/CSCOanm/bin/anm-ha` command to check high availability configuration or to force a node to become standby or active.

[Table 13-2](#) lists the sub-commands and their descriptions.

Table 13-2 CLI Sub-commands for Processes

| Command                   | Sub-command      | Description                                                                                                                                                                                                                                                                                                                                                                                                                                                                                                                                                                                                                                                                                                                                                                    |
|---------------------------|------------------|--------------------------------------------------------------------------------------------------------------------------------------------------------------------------------------------------------------------------------------------------------------------------------------------------------------------------------------------------------------------------------------------------------------------------------------------------------------------------------------------------------------------------------------------------------------------------------------------------------------------------------------------------------------------------------------------------------------------------------------------------------------------------------|
| /opt/CSCOanm/bin/anm-tool | info-services    | Indicates the state of all ANM processes. This command does not return process status if <i>monit</i> is not running.                                                                                                                                                                                                                                                                                                                                                                                                                                                                                                                                                                                                                                                          |
|                           | stop-services    | Stops all ANM processes, including <i>monit</i> .<br><b>Note</b> <i>Monit</i> must be running in order for the info-services command to provide status information.<br><b>Note</b> When ANM is running in HA mode and the standby ANM is just starting up, the active ANM copies its entire database to the standby ANM. During the copy process, the active ANM cannot be stopped or restarted using the <b>anm-tool</b> command. Check the Admin > ANM Management page for the HA Replication Status and wait until the status is set to OK before attempting to stop ANM.                                                                                                                                                                                                   |
|                           | start-services   | Starts the relevant ANM processes.                                                                                                                                                                                                                                                                                                                                                                                                                                                                                                                                                                                                                                                                                                                                             |
|                           | restart-services | Restarts the relevant ANM processes.<br><b>Note</b> When ANM is running in HA mode and the standby ANM is just starting up, the active ANM copies its entire database to the standby ANM. During the copy process, the active ANM cannot be stopped or restarted using the <b>anm-tool</b> command. Check the Admin > ANM Management page for the HA Replication Status and wait until the status is set to OK before attempting to restart ANM.                                                                                                                                                                                                                                                                                                                               |
|                           | info             | Provides additional information (state, whether running or stopped, start time, and PID) regarding the Java processes. <i>Monit</i> need not be running for this command to return information.                                                                                                                                                                                                                                                                                                                                                                                                                                                                                                                                                                                |
| /opt/CSCOanm/bin/anm-ha   | check            | Checks the local node's high availability configuration. If errors are returned, HA might not function correctly until you fix the errors.<br><b>Note</b> You must run this command on both the active and standby node.<br><br>While errors might indicate a problem, they could also simply indicate a known condition. For example, you receive a warning if the ANM cannot ping the peer node via either of the specified IP addresses; however, if the peer is down, the warning can be ignored because this is a known issue. It is also possible that no error might be returned even though there is a configuration problem. For example, the configuration of the two nodes must match; however the check sub-command cannot validate that the configurations match. |
|                           | active           | Forces the local node to become <i>active</i> and the peer node to become the <i>standby</i> node.                                                                                                                                                                                                                                                                                                                                                                                                                                                                                                                                                                                                                                                                             |
|                           | standby          | Forces the local node to become <i>standby</i> and the peer node to become the <i>active</i> node.                                                                                                                                                                                                                                                                                                                                                                                                                                                                                                                                                                                                                                                                             |

**Related Topics**

- [Understanding ANM High Availability Processes, page 13-3](#)

- [Understanding ANM High Availability, page 13-2](#)
- [Configuring ACE High Availability, page 13-14](#)
- [Understanding ACE Redundancy, page 13-6](#)

## Recovering From an HA Database Replication Failure

This section provides an overview of the database replication process that occurs between ANM HA active and standby nodes and how to recover from a replication failure.

When the active ANM is running and the standby ANM is just starting up, the active ANM copies its entire database to the standby ANM. This process normally takes from a few seconds to a few minutes depending on the size of the configuration data and monitoring data. During the replication process, the active ANM database is locked and the active ANM cannot be stopped or restarted using the **anm-tool** command nor can it perform a failover.

It is possible for the database replication process to fail if the standby ANM is stopped or powered down, the connectivity is down, or the active ANM is powered down. The failure of the replication process does not affect the integrity of the active ANM database. The procedure in this section describes what to do if you encounter a replication failure.

### Procedure

- 
- Step 1** Check the standby ANM and make sure that it has stopped.
- If the standby ANM is still running, stop it because its database might be incomplete due to the replication failure.
- Step 2** Check the connectivity between the active ANM and standby ANM and make sure that both links are up and connected.
- Step 3** Do one of the following:
- If the active ANM is still running, login and check to see that its configuration is normal.
  - If the active ANM has stopped or powered down, restart it now.
- Step 4** After the active ANM is running normally, restart the standby ANM.
- 
-  **Caution** Do not restart the standby ANM before the active ANM is running and operating normally.
- 
- Step 5** From the standby ANM GUI, choose **Admin > ANM Management** to display the ANM Server window and make sure that the HA Replication Status is set to OK before performing any daily management tasks.
- 

## Understanding ACE Redundancy

ACE module redundancy (or fault tolerance) uses a maximum of two ACEs in the same Catalyst 6500 switch or in separate switches to ensure that your network remains operational even if one of the modules becomes unresponsive.

ACE appliance redundancy uses a maximum of two ACEs to ensure that your network remains operational even if one of the ACE appliances becomes unresponsive.

**Note**

Redundancy is supported between ACEs of the same type only. Redundancy is not supported between an ACE appliance and an ACE module operating as peers. Redundancy must be of the same ACE device type and software version.

For additional information about ACE redundancy, see either the *Cisco Application Control Engine Module Administration Guide* or the *Cisco 4700 Series Application Control Engine Appliance Administration Guide*.

This section includes the following topics:

- [ACE High Availability Polling, page 13-7](#)
- [ACE Redundancy Protocol, page 13-8](#)
- [ACE Stateful Failover, page 13-9](#)
- [ACE Fault-Tolerant VLAN, page 13-10](#)
- [ACE Configuration Synchronization, page 13-11](#)
- [ACE Redundancy Configuration Requirements and Restrictions, page 13-12](#)
- [ACE High Availability Troubleshooting Guidelines, page 13-12](#)

## ACE High Availability Polling

Approximately every two minutes, the ANM issues the **show ft group** command to the ACE to gather the redundancy statistics of each virtual context. The state information is displayed in the HA State and HA Autosync fields when you click **Config > Devices > virtual context**.

**Note**

To display statistics and status information for a particular high availability group displayed in the High Availability (HA) Setup window (Config > Devices > admin\_context > High Availability (HA) > Setup), see the [“Displaying High Availability Group Statistics and Status” section on page 13-21](#).

The possible HA states are as follows:

- **Active**—Local member of the FT group is active and processing flows.
- **Standby Cold**—Indicates if the FT VLAN is down but the peer ACE is still alive, or the configuration or application state synchronization failed. When a context is in this state and a switchover occurs, the transition to the ACTIVE state is stateless.
- **Standby Bulk**—Local standby context is waiting to receive state information from its active peer context. The active peer context receives a notification to send a snapshot of the current state information for all applications to the standby context.
- **Standby Hot**—Local standby context has all the state information it needs to statefully assume the active state if a switchover occurs.
- **Standby Warm**—Allows the configuration and state synchronization process to continue on a best-effort basis when you upgrade or downgrade the ACE software.

- **Inconclusive**—Indicates that ANM was able to determine that the given ACE was configured in HA, however ANM was able to find more than one ACE module or ACE appliance that appeared to be a peer. In this case, ANM was unable to conclusively find a unique HA peer for the given ACE module or ACE appliance. For additional details on addressing this state, see the [“ANM Requirements for ACE High Availability” section on page 5-8](#) for details.

Inconclusive is not shown in the HA State field but is shown in the HA Peer field. It is possible that a context HA peer is inconclusive, but its HA State and HA Peer state are still shown normally because these states are from context polling from the ACE device.

**Note**

When you upgrade or downgrade the ACE from one software version to another, there is a point in the process when the two ACEs have different software versions and, therefore, a software incompatibility. When the Standby Warm state appears, this means that the active ACE will continue to synchronize configuration and state information to the standby even though the standby may not recognize or understand the software commands or state information. This standby state allows the standby ACE to come up with best-effort support.

**Related Topics**

- [ACE High Availability Polling, page 13-7](#)
- [ACE Redundancy Protocol, page 13-8](#)

## ACE Redundancy Protocol

You can configure a maximum of two ACEs of the same type (peers) for redundancy in the same Catalyst 6500 switch or in different chassis for redundancy. Each peer ACE can contain one or more fault-tolerant (FT) groups. Each FT group consists of two members: one active context and one standby context. An FT group has a unique group ID that you assign.

**Note**

For the replication process to function properly and successfully replicate the configuration for a user context when switching from the active context to the standby context, ensure that each user context has been added to the FT group. All applicable user contexts must be part of an FT group for redundancy to function properly.

One virtual MAC address (VMAC) is associated with each FT group. The format of the VMAC is: 00-0b-fc-fe-1b-*groupID*. Because a VMAC does not change upon switchover, the client and server ARP tables does not require updating. The ACE selects a VMAC from a pool of virtual MACs available to it. For more information, see the [“Configuring Virtual Contexts” section on page 6-8](#).

Each FT group acts as an independent redundancy instance. When a switchover occurs, the active member in the FT group becomes the standby member and the original standby member becomes the active member. A switchover can occur for the following reasons:

- The active member becomes unresponsive.
- A tracked host or interface fails.
- You force a switchover for a high availability group by clicking **Switchover** in the HA Groups table (see the [“Switching Over an ACE High Availability Group” section on page 13-22](#)).

To outside nodes (clients and servers), the active and standby FT group members appear as one node with respect to their IP addresses and associated VMAC. ACE provides active-active redundancy with multiple contexts only when there are multiple FT groups configured on each ACE and both devices contain at least one active group member (context). With a single context, the ACE supports active-backup redundancy and each group member is an Admin context.

The ACE sends and receives all redundancy-related traffic (protocol packets, configuration data, heartbeats, and state replication packets) on a dedicated FT VLAN. You cannot use this dedicated VLAN for normal traffic.

To optimize the transmission of heartbeat packets for multiple FT groups and to minimize network traffic, the ACE sends and receives heartbeat messages using a separate process. The ACE uses the heartbeat to probe the peer ACE, rather than probe each context. When an ACE does not receive a heartbeat from the peer ACE, all the contexts in the standby state become active. The ACE sends heartbeat packets over UDP. You can set the frequency with which the ACE sends heartbeat packets as part of the FT peer configuration. For details about configuring the heartbeat, see the “[Configuring ACE High Availability Peers](#)” section on page 13-15.

The election of the active member within each FT group is based on a priority scheme. The member configured with the higher priority is elected as the active member. If a member with a higher priority is found after the other member becomes active, the new member becomes active because it has a higher priority. This behavior is known as preemption and is enabled by default. You can override this default behavior by disabling preemption. To disable preemption, use the Preempt parameter. Enabling Preempt causes the member with the higher priority to assert itself and become active. For details about configuring preemption, see the “[Configuring ACE High Availability Groups](#)” section on page 13-17.

For additional information about ACE redundancy, see either the *Cisco Application Control Engine Module Administration Guide* or the *Cisco 4700 Series Application Control Engine Appliance Administration Guide*.

#### Related Topics

- [Understanding ACE Redundancy, page 13-6](#)
- [ACE High Availability Polling, page 13-7](#)

## ACE Stateful Failover

The ACE replicates flows on the active FT group member to the standby group member per connection for each context. The replicated flows contain all the flow-state information necessary for the standby member to take over the flow if the active member becomes unresponsive. If the active member becomes unresponsive, the replicated flows on the standby member become active when the standby member assumes mastership of the context. The active flows on the former active member transition to a standby state to fully back up the active flows on the new active member.



#### Note

For the replication process to function properly and successfully replicate the configuration for a user context when switching from the active context to the standby context, ensure that the user context has been added to the FT group. All applicable user contexts must be part of an FT group for redundancy to function properly.



#### Note

By default, connection replication is enabled in the ACE.

After a switchover occurs, the same connection information is available on the new active member. Supported end-user applications do not need to reconnect to maintain the same network session.

The state information passed to the standby ACE includes the following data:

- Network Address Translation (NAT) table based on information synchronized with the connection record
- All Transmission Control Protocol (TCP) and User Datagram Protocol (UDP) connections not terminated by the ACE
- HTTP connection states (Optional)
- Sticky table

**Note**

In a user context, the ACE allows a switchover only of the FT group that belongs to that context. In the Admin context, the ACE allows a switchover of all FT groups in all configured contexts in the ACE.

To ensure that bridge learning occurs quickly upon a switchover in a Layer 2 configuration in the case where a VMAC moves to a new location, the new active member sends a gratuitous ARP on every interface associated with the active context. Also, when there are two VLANs on the same subnet and servers need to send packets to clients directly, the servers must know the location of the gateway on the client-side VLAN. The active member acts as the bridge for the two VLANs. In order to initiate learning of the new location of the gateway, the new active member sends an ARP request to the gateway on the client VLAN and bridges the ARP response onto the server VLAN.

For additional information about ACE redundancy, see either the *Cisco Application Control Engine Module Administration Guide* or *Cisco 4700 Series Application Control Engine Appliance Administration Guide*.

**Related Topics**

- [Understanding ACE Redundancy, page 13-6](#)

## ACE Fault-Tolerant VLAN

ACE redundancy uses a dedicated fault-tolerant VLAN between redundant ACEs of the same type to transmit flow-state information and the redundancy heartbeat. Do not use this dedicated VLAN for normal network traffic. You must configure this same VLAN on both peers. You also must configure a different IP address within the same subnet on each ACE for the fault-tolerant VLAN.

The two redundant ACEs constantly communicate over the fault-tolerant VLAN to determine the operating status of each ACE. The standby member uses the heartbeat packet to monitor the health of the active member. The active member uses the heartbeat packet to monitor the health of the standby member.

Communications over the switchover link include the following data:

- Redundancy protocol packets
- State information replication data
- Configuration synchronization information
- Heartbeat packets



For multiple contexts, the fault-tolerant VLAN resides in the system configuration data. Each fault-tolerant VLAN on the ACE has one unique MAC address associated with it. The ACE uses these ACE MAC addresses as the source or destination MACs for sending or receiving redundancy protocol state and configuration replication packets.

**Note**

---

The IP address and the MAC address of the fault-tolerant VLAN do not change at switchover.

---

For additional information about ACE redundancy, see either the *Cisco Application Control Engine Module Administration Guide* or the *Cisco 4700 Series Application Control Engine Appliance Administration Guide*.

**Related Topics**

[Understanding ACE Redundancy, page 13-6](#)

## ACE Configuration Synchronization

For redundancy to function properly, both members of a fault-tolerant group must have identical configurations. The ACE automatically replicates the active configuration on the standby member using a process called *configuration synchronization* (config sync). Config sync automatically replicates any changes made to the configuration of the active member to the standby member. After the ACE synchronizes the redundancy configuration from the active member to the standby peer, it disables configuration mode on the standby. See the “[Configuring ACE High Availability Peers](#)” section on [page 13-15](#).

**Note**

---

The Application Networking Manager manages local configurations only.

---

When ANM detects a pair of ACE peers operating in high availability (HA), ANM allows you to make configuration changes on either the active or standby ACE. ANM then automatically (and seamlessly) pushes the configuration to the active ACE and locally replicates the configuration on the standby imported into ANM. This action is similar to what is performed by the ACE to the peers.

**Note**

---

Keep in mind that the configuration pushed while the standby ACE has been selected does not mean that ANM pushed the configuration to the standby ACE. Typically, with auto-sync turned off, configuration changes are disabled on the standby ACE. In this case, ANM tries to push the configuration to the active ACE in the HA device pair.

---

For additional information about ACE redundancy, see either the *Cisco Application Control Engine Module Administration Guide* or *Cisco 4700 Series Application Control Engine Appliance Administration Guide*.

**Related Topics**

- [Understanding ACE Redundancy, page 13-6](#)
- [Synchronizing ACE High Availability Configurations, page 13-30](#)
- [Synchronizing SSL Certificate and Key Pairs on Both ACE Peers, page 13-32](#)

## ACE Redundancy Configuration Requirements and Restrictions

Follow these requirements and restrictions when configuring the ACE redundancy feature.

- In bridged mode (Layer 2), two contexts cannot share the same VLAN.
- To achieve active-active redundancy, a minimum of two contexts and two fault-tolerant groups are required on each ACE.
- When you configure redundancy, the ACE keeps all interfaces that do not have an IP address in the Down state. The IP address and the peer IP address that you assign to a VLAN interface should be in the same subnet, but different IP addresses. For more information about configuring VLAN interfaces, see the [“Configuring Virtual Context VLAN Interfaces”](#) section on page 12-6.
- When importing an ACE HA pair into ANM, follow one of the configuration requirements outlined below for ANM to uniquely identify the ACE HA pair:
  - Use a unique combination of FT interface VLAN and FT IP address/peer IP address for every ACE HA pair imported into ANM. For HA, it is critical that the combination of FT interface VLAN and IP address/peer IP address always be unique across every pair of ACE peer devices.
  - Define a peer IP address in the management interface, using the management IP address of the peer ACE (module or appliance). Note that the management IP address and management peer IP address used for this definition should be the management IP address used to import both ACE devices into ANM.

For more information about the use of multiple HA pairs imported into ANM, see the [“ANM Requirements for ACE High Availability”](#) section on page 5-8

For additional information about ACE redundancy, see either the *Cisco Application Control Engine Module Administration Guide* or the *Cisco 4700 Series Application Control Engine Appliance Administration Guide*.

### Related Topics

- [Understanding ANM High Availability, page 13-2](#)

## ACE High Availability Troubleshooting Guidelines

This section provides the following set of guidelines for troubleshooting an ACE high availability (or redundancy) configuration in ANM:

- If the high availability setup of two ACE devices is successful, the HA State field of the ACE HA Management table should indicate no errors. If the HA State field does not read Compatible, verify that both ACE devices are the same type of hardware. ACE modules cannot be synchronized with ACE appliances.
- If the high availability setup of two ACE devices is successful, the License Compatibility and SRG Compatibility fields of the **show ft peer** CLI command output on the ACE (module or appliance) should indicate no errors. See either the *Cisco Application Control Engine Module Administration Guide* or *Cisco 4700 Series Application Control Engine Appliance Administration Guide* for details on the **show ft peer** CLI command.
  - If the SRG Compatibility field indicates a problem, this means that the versions of the ACE software running on the devices are not compatible with each other. One or both of the devices will need to have an appropriate version of the ACE software installed before they can be synchronized.

- If the License Compatibility field indicates a licensing problem, go to the Licenses page of ACE Hardware Setup (see the [“Using ACE Hardware Setup” section on page 3-5](#)) and make sure each ACE device has a valid license installed. Licenses must be installed on each device separately because each license is only valid for one hardware device.

For proper HA functionality, the licenses on both ACEs in the pair must be also compatible with each other. This means both licenses must permit the same bandwidth and the same number of virtual contexts.

**Note**

---

If the licenses' bandwidth limits do not match, configuration synchronization may appear to work (although Admin context synchronization may actually not be functional), and the License Compatibility field may not show an error. However, failover from the higher bandwidth ACE to a lower bandwidth ACE could result in loss of traffic.

---

# Configuring ACE High Availability

The tasks involved with configuring high availability on ACE devices are described in [Table 13-3](#).

**Table 13-3 High Availability Task Overview**

|               | <b>Task</b>                                                                                                                                                                                       | <b>Reference</b>                                                                          |
|---------------|---------------------------------------------------------------------------------------------------------------------------------------------------------------------------------------------------|-------------------------------------------------------------------------------------------|
| <b>Step 1</b> | Create a fault-tolerant VLAN and identify peer IP addresses and configure peer devices for heartbeat count and interval.                                                                          | <a href="#">Configuring ACE High Availability Peers, page 13-15</a>                       |
| <b>Step 2</b> | Reconcile SSL certificates and keys, create a fault-tolerant group, assign peer priorities, associate the group with a context, place the group in service, and enable automatic synchronization. | <a href="#">Configuring ACE High Availability Groups, page 13-17</a>                      |
| <b>Step 3</b> | Configure tracking for switchover.                                                                                                                                                                | <a href="#">ACE High Availability Tracking and Failure Detection Overview, page 13-23</a> |

## Related Topics

- [Understanding ACE Redundancy, page 13-6](#)
- [Configuring ACE High Availability Peers, page 13-15](#)
- [Configuring ACE High Availability Groups, page 13-17](#)
- [ACE High Availability Tracking and Failure Detection Overview, page 13-23](#)
- [Synchronizing ACE High Availability Configurations, page 13-30](#)
- [Synchronizing SSL Certificate and Key Pairs on Both ACE Peers, page 13-32](#)

# Configuring ACE High Availability Peers

**Note**

This functionality is available for only Admin contexts.

Fault-tolerant peers transmit and receive heartbeat packets and state and configuration replication packets. The standby member uses the heartbeat packet to monitor the health of the active member, while the active member uses the heartbeat packet to monitor the health of the standby member. When the heartbeat packets are not received from the active member when expected, switchover occurs and the standby member assumes all active communications previously on the active member.

Use this procedure to do the following tasks:

- Identify the two members of a high availability pair.
- Assign IP addresses to the peer ACEs.
- Assign a fault-tolerant VLAN to high availability peers and bind a physical gigabit Ethernet interface to the FT VLAN.
- Configure heartbeat frequency and count on the ACEs in a fault-tolerant VLAN.

**Note**

For ANM to properly manage high availability peers, ensure that the combination of FT interface VLAN along with IP and peer IP address always be unique across every pair of ACE devices in high availability when those devices are imported into ANM. For details, see the [“ANM Requirements for ACE High Availability” section on page 5-8](#).

**Assumption**

At least one fault-tolerant VLAN has been configured.

**Note**

A fault-tolerant VLAN cannot be used for other network traffic.

**Procedure**

**Step 1** Choose **Config > Devices > *admin\_context* > High Availability (HA) > Setup**.

The HA Management window appears with two columns; one for the selected ACE and one for a peer ACE.

**Step 2** Click **Edit** and enter the information for the primary ACE and the peer ACE as described in [Table 13-4](#).

**Table 13-4 High Availability Management Configuration Attributes**

| Field  | This Device                                                                                                                                                          | Peer Device     |
|--------|----------------------------------------------------------------------------------------------------------------------------------------------------------------------|-----------------|
| Module | Name of the ACE                                                                                                                                                      | Not applicable. |
| VLAN   | Fault-tolerant VLAN to be used for this high availability pair. Valid entries are from 1 to 4094.<br><b>Note</b> This VLAN cannot be used for other network traffic. | Not applicable. |

**Table 13-4 High Availability Management Configuration Attributes (continued)**

| Field                    | This Device                                                                                                                                                                                                    | Peer Device                                                                                                                                                    |
|--------------------------|----------------------------------------------------------------------------------------------------------------------------------------------------------------------------------------------------------------|----------------------------------------------------------------------------------------------------------------------------------------------------------------|
| IP Address               | IP address for the fault-tolerant VLAN in dotted-decimal format, such as 192.168.11.2.                                                                                                                         | Enter the IP address of the peer interface in dotted-decimal format so that the peer ACE can communicate on the fault-tolerant VLAN.                           |
| Netmask                  | Subnet mask that is to be used for the fault-tolerant VLAN.                                                                                                                                                    | Not applicable.                                                                                                                                                |
| Query VLAN               | VLAN that the standby ACE is to use to determine whether the active ACE is down or if there is a connectivity problem with the fault-tolerant VLAN.                                                            | Choose the VLAN that the standby ACE is to use to determine whether the active ACE is down or if there is a connectivity problem with the fault-tolerant VLAN. |
| Heartbeat Count          | Number of heartbeat intervals that must occur with no heartbeat packet received by the standby ACE before the standby ACE determines that the active member is not available. Valid entries are from 10 to 50. | Not applicable.                                                                                                                                                |
| Heartbeat Interval       | Number of milliseconds that the active ACE is to wait between each heartbeat it sends to the standby ACE. Valid entries are from 100 to 1000.                                                                  | Not applicable.                                                                                                                                                |
| Interface Enabled        | Interface Enabled check box that enables the high availability interface. Uncheck the check box to disable the high availability interface.                                                                    | Not applicable.                                                                                                                                                |
| Shared VLAN Host ID      | Specific bank of MAC addresses that the ACE uses. Enter a number from 1 to 16. Be sure to configure different bank numbers for multiple ACEs.                                                                  | Not applicable.                                                                                                                                                |
| Peer Shared VLAN Host ID | Specific bank of MAC addresses for the same ACE in a redundant configuration. Valid entries are from 1 to 16. Be sure to configure different bank numbers for multiple ACEs.                                   | Not applicable.                                                                                                                                                |
| HA State                 | Read-only field with the current state of high availability on the ACE.                                                                                                                                        | Not applicable.                                                                                                                                                |

**Step 3** Do one of the following:

- Click **Deploy Now** to deploy this configuration on the ACE and save your entries to the running-configuration and startup-configuration files. Continue with configuring high availability groups. The HA Management window appears at the top of the content area and the HA Groups table appears at the bottom. See the “[Configuring ACE High Availability Groups](#)” section on page 13-17 to configure a high availability group.
- Click **Cancel** to exit this procedure without saving your entries and to view the HA Management window.

**Related Topics**

- [Understanding ANM High Availability, page 13-2](#)
- [Configuring ACE High Availability, page 13-14](#)
- [Configuring ACE High Availability Groups, page 13-17](#)
- [Synchronizing ACE High Availability Configurations, page 13-30](#)

- [Synchronizing SSL Certificate and Key Pairs on Both ACE Peers](#), page 13-32
- [Tracking ACE VLAN Interfaces for High Availability](#), page 13-24

## Clearing ACE High Availability Pairs

**Note**

This functionality is available for only Admin contexts.

You can remove a high availability link between two ACEs.

**Procedure**

- 
- Step 1** Choose **Config > Devices > *admin\_context* > High Availability (HA) > Setup**.  
The HA Management window appears.
- Step 2** Choose the ACE pair whose high availability configuration that you want to remove, and click **Clear**.  
A message appears asking you to confirm the clearing of the high availability link.
- Step 3** Do one of the following:
- Click **OK** to confirm the removal of this high availability link and to return to the HA Management window.
  - Click **Cancel** to exit this procedure without removing this high availability link and to return to the HA Management window.
- 

**Related Topics**

- [Understanding ANM High Availability](#), page 13-2
- [Configuring ACE High Availability Peers](#), page 13-15
- [Editing High Availability Groups](#), page 13-19
- [ACE High Availability Tracking and Failure Detection Overview](#), page 13-23
- [Tracking ACE VLAN Interfaces for High Availability](#), page 13-24
- [Tracking Hosts for High Availability](#), page 13-25

## Configuring ACE High Availability Groups

**Note**

This functionality is available for only Admin contexts.

You can configure a high availability group, or fault-tolerant group, which consists of a maximum of two contexts: One active context on one ACE and one standby context on the peer ACE. You can create multiple fault-tolerant groups on each ACE up to a maximum of:

- For the ACE module—251 groups (250 user contexts and 1 Admin context).
- For the ACE appliance—21 groups (20 user contexts and 1 Admin context).

**Note**

For the replication process to function properly and successfully replicate the configuration for a user context when switching from the active context to the standby context, ensure that each user context has been added to the FT group. All applicable user contexts must be part of an FT group for redundancy to function properly.

**Assumption**

At least one high availability pair has been configured (see the [“Configuring ACE High Availability Peers”](#) section on page 13-15).

**Procedure**

**Step 1** Choose **Config > Devices > admin\_context > High Availability (HA) > Setup**.

The HA Management window appears at the top of the content area and the HA Groups table appears at the bottom.

**Step 2** In the HA Groups table of the HA Management window, click **Add** to add a new high availability group.

The table refreshes with the configurable fields.

**Step 3** Check the Enabled check box to enable the high availability group.

Uncheck the Enabled check box to disable the high availability group.

**Step 4** In the Context field, choose the virtual context to associate with this high availability group.

**Step 5** In the Priority (Actual) field, enter the priority that you want to assign to the first device in the group.

Valid entries are from 1 to 255.

A member of a fault-tolerant group becomes the active member through a process based on the priority assigned. In this process, the group member with the higher priority becomes the active member. When you set up a fault-tolerant pair, use a higher priority for the group where the active member initially resides.

**Step 6** Check the Preempt check box to specify that the group member with the higher priority is to always assert itself and become the active member.

Uncheck the Preempt check box to specify that you do not want the group member with the higher priority to always become the active member.

**Step 7** In the Peer Priority (Actual) field, enter the priority that you want to assign to the peer device in the group.

Valid entries are from 1 to 255.

A member of a fault-tolerant group becomes the active member through a process based on the priority assigned. In this process, the group member with the higher priority becomes the active member. When you set up a fault-tolerant pair, use a higher priority for the group where the active member initially resides.

**Step 8** Check the Autosync Run check box to enable automatic synchronization of the running configuration files.

Uncheck the Autosync Run check box to disable automatic synchronization of the running configuration files. If you disable automatic synchronization, you need to update the configuration of the standby context manually. See the [“Synchronizing Virtual Context Configurations”](#) section on page 6-105.



**Note**

If you check **Autosync Run** for the HA group, you must manually sync the standby context in order for ANM to allow subsequent configuration changes. Until you have done this, the standby context will be marked out of sync. See the “[Synchronizing Virtual Context Configurations in High Availability Mode](#)” section on page 13-31.

**Step 9** Check the Autosync Startup check box to enable automatic synchronization of the startup configuration files.

Uncheck the Autosync Run check box to disable automatic synchronization of the startup configuration files. If you disable automatic synchronization, you need to update the configuration of the standby context manually. See the “[Synchronizing Virtual Context Configurations](#)” section on page 6-105.

**Step 10** Do one of the following:

- Click **Deploy Now** to deploy this configuration on the ACE and save your entries to the running-configuration and startup-configuration files. The HA Groups table refreshes with the new high availability group.
- Click **Cancel** to exit this procedure without saving your entries and to return to the HA Management window and HA Groups table.

**Step 11** (Optional) To display statistics and status information for a particular high availability group, choose the group from the ACE HA Groups table, and click **Details**.

The **show ft group *group\_id* detail** CLI command output appears. See the “[Displaying High Availability Group Statistics and Status](#)” section on page 13-21 for details.

**Related Topics**

- [Configuring ACE High Availability Peers, page 13-15](#)
- [Editing High Availability Groups, page 13-19](#)
- [Synchronizing Virtual Context Configurations, page 6-105](#)
- [Synchronizing SSL Certificate and Key Pairs on Both ACE Peers, page 13-32](#)
- [Tracking ACE VLAN Interfaces for High Availability, page 13-24](#)
- [Tracking Hosts for High Availability, page 13-25](#)

## Editing High Availability Groups

**Note**

This functionality is available for only Admin contexts.

You can modify the attributes of a high availability group.

**Note**

If you need to modify a fault-tolerant group, take the group out of service before making any other changes (see the “[Taking a High Availability Group Out of Service](#)” section on page 13-20). When you finish making all changes, place the group back into service (see the “[Enabling a High Availability Group](#)” section on page 13-21).

**Procedure**

- 
- Step 1** Choose **Config > Devices > admin\_context > High Availability (HA) > Setup**.
- The HA Management window appears at the top of the content area and the HA Groups table appears at the bottom.
- Step 2** In the HA Groups table, choose the high availability group that you want to modify, and click **Edit**.
- The table refreshes with configurable fields.
- Step 3** Modify the fields as desired. For information on these fields, see the [“Configuring ACE High Availability Groups”](#) section on page 13-17.



---

**Note** If you leave unchecked **Autosync Run** for the HA group, you must manually sync the standby context in order for ANM to allow subsequent configuration changes. Until you have done this, the standby context will be marked out of sync. See the [“Synchronizing Virtual Context Configurations in High Availability Mode”](#) section on page 13-31.

---

- Step 4** When you finish modifying this group, do one of the following:
- Click **Deploy Now** to deploy this configuration on the ACE and save your entries to the running-configuration and startup-configuration files. You return to the HA Groups table.
  - Click **Cancel** to exit this procedure without saving your entries and to return to the HA Management window.
- 

**Related Topics**

- [Configuring ACE High Availability Groups, page 13-17](#)
- [Taking a High Availability Group Out of Service, page 13-20](#)
- [Enabling a High Availability Group, page 13-21](#)
- [Configuring ACE High Availability Peers, page 13-15](#)
- [ACE High Availability Tracking and Failure Detection Overview, page 13-23](#)

## Taking a High Availability Group Out of Service



---

**Note** This functionality is available for only Admin contexts.

---

You can take a high availability group out of service, which you must do before you can modify it.

**Procedure**

- 
- Step 1** Choose **Config > Devices > admin\_context > High Availability (HA) > Setup**.
- The HA Management window appears at the top of the content area and the HA Groups table appears at the bottom.

- Step 2** In the HA Groups table, choose the high availability group you want to take out of service, and click **Edit**.
- The table refreshes with configurable fields.
- Step 3** Uncheck the **Enabled** check box.
- Step 4** Click **Deploy Now** to take the high availability group out of service and to return to the HA Groups table.
- You can now make the necessary modifications to the high availability group. To put the high availability group back in service, see the “[Enabling a High Availability Group](#)” section on page 13-21.
- 

#### Related Topics

[Enabling a High Availability Group, page 13-21](#)

## Enabling a High Availability Group



**Note** This functionality is available for only Admin contexts.

---

You can put a high availability group back into service after taking it out of service.

#### Procedure

---

- Step 1** Choose **Config > Devices > admin\_context > High Availability (HA) > Setup**.
- The HA Management window appears at the top of the content area and the HA Groups table appears at the bottom.
- Step 2** In the HA Groups table, choose the high availability group you want to take out of service, and click **Edit**.
- The table refreshes with configurable fields.
- Step 3** Check the **Enabled** check box.
- Step 4** Click **Deploy Now** to put the high availability group in service and to return to the HA Groups table.
- 

#### Related Topics

[Taking a High Availability Group Out of Service, page 13-20](#)

## Displaying High Availability Group Statistics and Status

You can display statistics and status information for a particular high availability group by using the **Details** button. ANM accesses the **show ft group group\_id detail** CLI command to display detailed ACE HA group information.

#### Procedure

---

- Step 1** Choose **Config > Devices > admin\_context > High Availability (HA) > Setup**.

The HA Management window appears at the top of the content area and the HA Groups table appears at the bottom.

**Step 2** Choose an ACE HA group from the ACE HA Groups table and click **Details**.

The **show ft group group\_id detail** CLI command output appears. For details on the displayed output fields, see either the *Cisco ACE Module Administration Guide* or the *Cisco ACE 4700 Series Appliance Administration Guide*.

**Step 3** Click **Update Details** to refresh the output for the **show ft group group\_id detail** CLI command.

**Step 4** Click **Close** to return to the VLAN Interfaces table.

## Switching Over an ACE High Availability Group



### Note

This functionality is available for only Admin contexts.

You can force the failover of a high availability group. You may need to force a switchover when you want to make a particular context the standby (for example, for maintenance or a software upgrade on the currently active context). If the standby group member can statefully become the active member of the high availability group, a switchover occurs.

### Procedure

**Step 1** Choose **Config > Devices > admin\_context > High Availability (HA) > Setup**.

The HA Management window appears at the top of the content area and the HA Groups table appears at the bottom.

**Step 2** In the HA Groups table, choose the group that you want to switch over, and click **Switchover**.

The standby group member becomes active, while the previously active group member becomes the standby member.



### Note

You must manually sync the standby context in order for ANM to allow subsequent configuration changes. Until you have done this, the standby context will be marked out of sync. See the [“Synchronizing Virtual Context Configurations in High Availability Mode”](#) section on page 13-31.

### Related Topics

- [Understanding ANM High Availability, page 13-2](#)
- [Configuring ACE High Availability Peers, page 13-15](#)
- [Configuring ACE High Availability Groups, page 13-17](#)
- [Synchronizing SSL Certificate and Key Pairs on Both ACE Peers, page 13-32](#)
- [Tracking ACE VLAN Interfaces for High Availability, page 13-24](#)

**Related Topics**

- [Understanding ANM High Availability, page 13-2](#)
- [Configuring ACE High Availability Peers, page 13-15](#)
- [Configuring ACE High Availability Groups, page 13-17](#)

## Deleting ACE High Availability Groups

**Note**

This functionality is available for only Admin contexts.

You can remove a high availability group from ANM management.

**Procedure**

**Step 1** Choose **Config > Devices > *admin\_context* > High Availability (HA) > Setup**.

The HA Management window appears at the top of the content area and the HA Groups table appears at the bottom.

**Step 2** In the HA Groups table, choose the high availability group that you want to remove, and click **Delete**.

A message appears asking you to confirm the deletion.

**Step 3** Do one of the following:

- Click **Deploy Now** to delete the high availability group and to return to the HA Groups table. The selected group no longer appears.
- Click **Cancel** to exit this procedure without deleting the high availability group and to return to the HA Groups table.

**Related Topics**

- [Configuring ACE High Availability Peers, page 13-15](#)
- [Configuring ACE High Availability Groups, page 13-17](#)
- [Tracking ACE VLAN Interfaces for High Availability, page 13-24](#)

## ACE High Availability Tracking and Failure Detection Overview

ANM supports the tracking and detection of failures to ensure that switchover occurs as soon as the criteria are met (see [Configuring ACE High Availability Peers, page 13-15](#)). You can track and detect failures on the following:

- Hosts—See [Tracking Hosts for High Availability, page 13-25](#).
- Interfaces—See [Tracking ACE VLAN Interfaces for High Availability, page 13-24](#).

When the active member of a fault-tolerant group becomes unresponsive, the following occurs:

1. The active member's priority is reduced by 10.

2. If the resulting priority value is less than that of the standby member, the active member switches over and the standby member becomes the new active member. All active flows continue uninterrupted.
3. When the failed member comes back up, its priority is incremented by 10.
4. If the resulting priority value is greater than that of the currently active member, a switchover occurs again, returning the flows to the originally active member.

**Note**

In a user context, the ACE allows a switchover only of the fault-tolerant groups belonging to that context. In an Admin context, the ACE allows a switchover of all fault-tolerant groups on all configured contexts on the ACE.

**Related Topics**

- [Configuring ACE High Availability Groups, page 13-17](#)
- [Tracking ACE VLAN Interfaces for High Availability, page 13-24](#)
- [Tracking Hosts for High Availability, page 13-25](#)

## Tracking ACE VLAN Interfaces for High Availability

You can configure a tracking and failure detection process for a VLAN interface.

**Procedure**

- 
- Step 1** Choose **Config > Devices > *admin\_context* > HA Tracking And Failure Detection > Interfaces**.  
The Track Interface table appears.
- Step 2** Click **Add** to add a new tracking process to this table, or choose an existing entry and click **Edit** to modify it.  
The Track Interface configuration window appears.
- Step 3** In the Track Object Name field of the Track Interface configuration window, enter a unique identifier for the tracking process.  
Valid entries are unquoted text strings with no spaces.
- Step 4** In the Priority field, enter the priority for the interface on the active member.  
Valid entries are from 0 to 255 with higher values indicating higher priorities. The values that you enter here and in the Interface Peer Priority field (see [Step 6](#)) reflect the point at which you want switchover to occur. If the tracked interface goes down, the priority of that fault-tolerant group is decremented by the value entered in the Priority field. If the priority of the fault-tolerant group on the active member falls below that of the standby member, a switchover occurs.
- Step 5** In the VLAN Interface field, choose the fault-tolerant VLAN that you want the active member to track.
- Step 6** In the Interface Peer Priority field, enter the priority for the interface on the standby member.  
Valid entries are from 0 to 255 with higher values indicating higher priorities. The values that you enter here and in the Priority field (See [Step 4](#)) reflect the point at which you want switchover to occur. If the tracked interface goes down, the priority of that fault-tolerant group is decremented by the value entered in the Interface Peer Priority field. If the priority of the fault-tolerant group on the active member falls below that of the standby member, a switchover occurs.

**Step 7** In the Peer VLAN Interface field, enter the identifier of an existing fault-tolerant VLAN that you want the standby member to track.

Valid entries are from 1 to 4096.

**Step 8** Do one of the following:

- Click **Deploy Now** to deploy this configuration on the ACE and save your entries to the running-configuration and startup-configuration files. You return to the Track Interface table.
- Click **Cancel** to exit this procedure without saving your entries and to return to the Track Interface table.
- Click **Next** to deploy your entries and to configure the next entry in the Track Interface table.

---

#### Related Topics

- [Configuring ACE High Availability Peers, page 13-15](#)
- [Configuring ACE High Availability Groups, page 13-17](#)
- [Tracking Hosts for High Availability, page 13-25](#)

## Tracking Hosts for High Availability

You can configure a tracking and failure detection process for a gateway or host.



#### Note

Fields and information related to IPv6 require ACE module and ACE appliance software Version A5(1.0) or later.

---

#### Procedure

**Step 1** Choose **Config > Devices > admin\_context > HA Tracking And Failure Detection > Hosts**.

The Track Host table appears.

**Step 2** In the Track Host table, click **Add** to add a new tracking process to the table, or choose an existing entry and click **Edit** to modify it.

The Track Host configuration window appears.

**Step 3** In the Track Object Name field of the Track Host configuration window, enter a unique identifier for the tracking process.

Valid entries are unquoted text strings with no spaces.

**Step 4** In the IP Address Type field, choose either **IPv4** or **IPv6** for the host address type.

This field appears only for ACE module and ACE appliance software Version A5(1.0) or later, which supports IPv4 and IPv6.

**Step 5** In the Track Host/IP Address field, enter the IPv4 or IPv6 address or hostname of the gateway or host that you want the active member of the high availability group to track.

**Step 6** In the Priority field, enter the priority of the probe sent by the active member.

Valid entries are from 0 to 255. Higher values indicate higher priorities. Assign a priority value based on the relative importance of the host that the probe is tracking. If the probe goes down, the ACE decrements the priority of the fault-tolerant group on the active member by the value in the Priority field.

**Step 7** In the Peer Host/IP Address field, enter the IPv4 or IPv6 address or hostname of the host that you want the standby member to track.

**Step 8** In the Peer Priority field, enter the priority of the probe sent by the standby member.

Valid entries are from 0 to 255. Higher values indicate higher priorities. Assign a priority value based on the relative importance of the host that the probe is tracking. If the probe goes down, the ACE decrements the priority of the fault-tolerant group on the standby member by the value in the Priority field.

**Step 9** Do one of the following:

- Click **Deploy Now** to deploy this configuration on the ACE and save your entries to the running-configuration and startup-configuration files. Continue with configuring track host probes. See [Configuring Host Tracking Probes, page 13-26](#).
- Click **Cancel** to exit this procedure without saving your entries and to return to the Track Host table.
- Click **Next** to deploy your entries and to configure another tracking process.

#### Related Topics

- [Configuring Host Tracking Probes, page 13-26](#)
- [Configuring ACE High Availability Peers, page 13-15](#)
- [Configuring ACE High Availability Groups, page 13-17](#)
- [Tracking ACE VLAN Interfaces for High Availability, page 13-24](#)

## Configuring Host Tracking Probes

You can configure probes on the active high availability group member to track the health of the gateway or host.

#### Assumptions

This topic assumes the following:

- At least one host tracking process for high availability has been configured (see [Tracking Hosts for High Availability, page 13-25](#).)
- At least one health monitoring probe has been configured (see [Configuring Health Monitoring for Real Servers, page 8-51](#)).

#### Procedure

**Step 1** Choose **Config > Devices > admin\_context > HA Tracking And Failure Detection > Hosts**.

The Track Host table appears.

**Step 2** Choose the tracking process that you want to modify, and click the **Peer Track Host Probe** tab.

The Peer Track Host Probes table appears.



- Step 3** In the Peer Track Host Probes table, click **Add** to add a peer host tracking probe, or choose an existing peer host tracking probe and click **Edit** to modify it.
- The Peer Track Host Probes configuration window appears.
- Step 4** In the Probe Name field, choose the name of the probe to be used for the peer host tracking process.
- Step 5** In the Priority field, enter a priority for the host that you are tracking by the active member.
- Valid entries are from 1 to 255 with higher values indicating higher priorities. Assign a priority value based on the relative importance of the gateway or host that the probes are tracking. If the host goes down, the ACE decrements the priority of the high availability group on the standby member by the value in this Priority field.
- Step 6** Do one of the following:
- Click **Deploy Now** to deploy this configuration on the ACE and save your entries to the running-configuration and startup-configuration files. You return to the Track Host Probe table. The table includes the added probe.
  - Click **Cancel** to exit this procedure without saving your entries and to return to the Track Host Probe table.
  - Click **Next** to deploy your entries and to configure another track host probe.
- 

#### Related Topics

- [Configuring ACE Peer Host Tracking Probes, page 13-28](#)
- [Configuring ACE High Availability Peers, page 13-15](#)
- [Configuring ACE High Availability Groups, page 13-17](#)
- [Tracking ACE VLAN Interfaces for High Availability, page 13-24](#)

## Deleting Host Tracking Probes

You can remove a high availability host tracking probe.

#### Procedure

---

- Step 1** Choose **Config > Devices > ACE admin\_context > HA Tracking And Failure Detection > Hosts**.
- The Track Host table appears.
- Step 2** In the Track Host table, choose the tracking process you want to modify, and click the **Track Host Probe** tab.
- The Track Host Probe table appears.
- Step 3** In the Track Host table, choose the probe that you want to remove, and click **Delete**.
- The probe is deleted and the Track Host Probe table refreshes without the deleted probe.
- 

#### Related Topics

- [Configuring ACE Peer Host Tracking Probes, page 13-28](#)
- [Configuring ACE High Availability Peers, page 13-15](#)

- [Configuring ACE High Availability Groups, page 13-17](#)
- [Tracking ACE VLAN Interfaces for High Availability, page 13-24](#)

## Configuring ACE Peer Host Tracking Probes

You can configure probes on the standby member of a high availability group to track the health of the gateway or host.

### Assumptions

This topic assumes the following:

- At least one host tracking process for high availability has been configured (see [Tracking Hosts for High Availability, page 13-25](#).)
- At least one health monitoring probe has been configured (see [Configuring Health Monitoring for Real Servers, page 8-51](#)).

### Procedure

- 
- Step 1** Choose **Config > Devices > ACE admin\_context > HA Tracking And Failure Detection > Hosts**.  
The Track Host table appears.
- Step 2** In the Track Host table, choose the tracking process that you want to modify, and click the **Peer Track Host Probe** tab.  
The Peer Track Host Probes table appears.  
If the Track Host Probe and Peer Track Host Probes tabs do not appear below the Track Host table, click **Show Tabs** below the Track Host table name.
- Step 3** In the Peer Track Host Probes table, click **Add** to add a peer host tracking probe, or choose an existing peer host tracking probe and click **Edit** to modify it.  
The Peer Track Host Probes configuration window appears.
- Step 4** In the Probe Name field of the Peer Track Host Probes configuration window, choose the name of the probe to be used for the peer host tracking process.
- Step 5** In the Priority field, enter a priority for the host you are tracking by the standby member of the high availability group.  
Valid entries are from 0 to 255 with higher values indicating higher priorities. Assign a priority value based on the relative importance of the gateway or host that the probes are tracking. If the host goes down, the ACE decrements the priority of the high availability group on the standby member by the value in this Priority field.
- Step 6** Do one of the following:
- Click **Deploy Now** to deploy this configuration on the ACE and save your entries to the running-configuration and startup-configuration files. You return to the Peer Track Host Probes table. The table includes the added probe.
  - Click **Cancel** to exit this procedure without saving your entries and to return to the Peer Track Host Probes table.
  - Click **Next** to deploy your entries and to configure another peer track host probe.
-

**Related Topics**

- [Configuring Host Tracking Probes, page 13-26](#)
- [Configuring ACE High Availability Peers, page 13-15](#)
- [Configuring ACE High Availability Groups, page 13-17](#)
- [Tracking ACE VLAN Interfaces for High Availability, page 13-24](#)

## Deleting Peer Host Tracking Probes

You can remove a high availability peer host tracking probe.

**Procedure**

- 
- Step 1** Choose **Config > Devices > ACE admin\_context > HA Tracking And Failure Detection > Hosts**.  
The Track Host table appears.
- Step 2** In the Track Host table, choose the tracking process that you want to modify and click the **Peer Track Host Probe** tab.  
The Peer Track Host Probes table appears.  
If the Track Host Probe and Peer Track Host Probes tabs do not appear below the Track Host table, click **Show Tabs** below the Track Host table name.
- Step 3** In the Peer Track Host Probes table, choose the probe that you want to remove, and click **Delete**.  
The probe is deleted and the Peer Track Host Probes table refreshes without the deleted probe.
- 

**Related Topics**

- [Configuring ACE Peer Host Tracking Probes, page 13-28](#)
- [Configuring Host Tracking Probes, page 13-26](#)
- [Tracking ACE VLAN Interfaces for High Availability, page 13-24](#)

## Configuring ACE HSRP Groups

You can add or edit a Hot Standby Router Protocol (HSRP) group.

**Assumptions**

This topic assumes the following:

- At least one host tracking process for high availability has been configured (see [Tracking Hosts for High Availability, page 13-25](#).)
- Before you configure an HSRP tracking and failure detection process on the ACE, you must configure the HSRP group on the Catalyst 6500 Supervisor.

### Procedure

- 
- Step 1** Choose **Config > Devices > ACE admin\_context > HA Tracking And Failure Detection > HSRP Groups**.
- The HSRP Groups table appears.
- Step 2** In the HSRP Groups table, click **Add** to add a new HSRP group, or choose an existing entry and click **Edit** to modify it.
- The HSRP Group configuration window appears.
- Step 3** In the Track Object Name field of the HSRP Group configuration window, enter a unique identifier for the tracking process.
- Valid entries are unquoted text strings with no spaces.
- Step 4** In the Priority field, enter the priority of the HSRP group as an from 0 to 255.
- The default is 0. Higher values indicate higher priorities. Assign a priority value based on the relative importance of the HSRP group that you are tracking. If the HSRP group goes down, the ACE decrements the priority of the FT group on the active member. If the priority of the FT group on the active member falls below the priority of the FT group on the standby member, a switchover occurs.
- Step 5** In the HSRP Group Name, enter a name for the HSRP group.
- Step 6** In the HSRP Peer Priority field, enter the priority of the HSRP group as a value from 0 to 255.
- The default is 0. Higher values indicate higher priorities. Assign a priority value based on the relative importance of the HSRP group you are tracking. If the HSRP group goes down, the ACE decrements the priority of the FT group on the standby member.
- Step 7** In the HSRP Group Name of Peer field, enter a name for the HSRP group on the peer ACE.
- Step 8** Do one of the following:
- Click **Deploy Now** to deploy this configuration on the ACE and save your entries to the running-configuration and startup-configuration files. You return to the HSRP Groups table. The table includes the added HSRP group.
  - Click **Cancel** to exit this procedure without saving your entries and to return to the HSRP Groups table.
- 

## Synchronizing ACE High Availability Configurations

When two ACE devices are configured as high availability peers, their configurations must be synchronized at all times so that the standby member can take over for the active member seamlessly. As they synchronize, however, the configuration on the hot standby ACE can become out of sync with the ANM-maintained configuration data for that ACE.



### Note

ANM manages local configurations only.

---

**Note**

Although a context might have been configured for syslog notification, changes applied to the standby ACE configuration can change syslog notification configuration so that you are not notified of the out-of-sync configurations. As a result, it is important for you to manually synchronize ANM with the standby ACE.

Synchronizing configuration files for the standby ACE requires the following:

1. Auditing the standby ACE to confirm that its configuration does not agree with the ANM-maintained configuration data for the ACE. See [Synchronizing Virtual Context Configurations, page 6-105](#).
2. Uploading the configuration from the standby ACE to the ANM server. See [Synchronizing Virtual Context Configurations, page 6-105](#).
3. Ensuring that the SSL certificate/keys are imported and identical for the pair. See [Synchronizing SSL Certificate and Key Pairs on Both ACE Peers, page 13-32](#).
4. For an Admin context, uploading configurations on any newly imported user contexts. If new user contexts are not updated, they cannot be managed using ANM.

## Synchronizing Virtual Context Configurations in High Availability Mode

When configuration changes are made from ANM on any of the ACE devices in a HA pair, ANM automatically detects the active HA peer and deploys the configuration changes to the active ACE alone. ANM does not attempt to deploy a configuration to a standby ACE even if you selected the standby ACE from the ANM device tree. ANM detects the active ACE and will always deploy configuration changes only to the active ACE. In addition, if ACE HA auto-sync is enabled, after the deployment is successful, ANM will locally replicate the configuration in the ANM database on the standby as well to ensure that the ANM configuration is in synchronization with that of the two ACE peers.

In a high availability pair, the two configured virtual contexts synchronize with each other as part of their ongoing communications. However, their copies do not synchronize in ANM and the configuration on the standby member may become out-of-sync with the configuration on the ACE.

After the active member of a high availability pair fails and the standby member becomes active, the newly active member detects any out-of-sync virtual context configurations and reports that status in the Virtual Contexts table so that you can synchronize the virtual context configurations.

**Note**

If a context is put into an out-of-sync state, this context will be automatically synchronized by the backend ANM. It is not necessary for you to perform an explicit synchronization to take care of the out-of-sync state.

For information on synchronizing virtual context configurations, see [Synchronizing Virtual Context Configurations, page 6-105](#).

### Related Topics

- [Configuring ACE High Availability Peers, page 13-15](#)
- [Configuring ACE High Availability Groups, page 13-17](#)
- [Synchronizing Virtual Context Configurations, page 6-105](#)

# Synchronizing SSL Certificate and Key Pairs on Both ACE Peers

You can reconcile the SSL certificates and key pairs. When SSL certificate/key import is attempted on a peer that is configured in HA, ANM detects the HA state and also imports the same certificate/key into the other HA peer. In addition, when you are configuring two peers in HA from ANM, a warning message appears asking you to perform certificate/key reconciliation and offers the appropriate window enabling you to do this.

## Guidelines and Restrictions

The certificate/key reconciliation feature is available from the Admin context only; however, executing this feature from the Admin context also reconciles the SSL certificates and key pairs on all the virtual contexts associated with the ACE peers.

## Procedure

**Step 1** Choose **Config > Devices > admin\_context > High Availability (HA) > Setup**.

The HA Management window appears at the top of the content area and the HA Groups table appears at the bottom.

**Step 2** In the HA Groups table, choose the group that you want to reconcile the SSL certificates and key pairs on the two HA pairs after a switchover occurs, and click **SSL Certificate/Key Reconcile**.

The SSL Certificate/Key Reconciliation popup window appears. Information appears in this popup window for the primary ACE and the peer ACE as described in [Table 13-5](#).

**Table 13-5** SSL Certificate/Key Reconciliation Popup Window Attributes

| Field                                         | Description                                                                                                                                                                                                                                                                                                                                  |
|-----------------------------------------------|----------------------------------------------------------------------------------------------------------------------------------------------------------------------------------------------------------------------------------------------------------------------------------------------------------------------------------------------|
| This Device                                   | IP address for the fault-tolerant VLAN.                                                                                                                                                                                                                                                                                                      |
| Peer Device                                   | Fault-tolerant VLAN to be used for this high availability pair. Valid entries are from 1 to 4094.<br><b>Note</b> This VLAN cannot be used for other network traffic.                                                                                                                                                                         |
| Context Name                                  | Unique name for the virtual context                                                                                                                                                                                                                                                                                                          |
| Matched State                                 | Feature that indicates a match between the SSL certificates and key pairs on the active ACE and the standby ACE peer.                                                                                                                                                                                                                        |
| Not Matched State                             | Feature that indicates that there is not a match between the SSL certificates and key pairs on the active ACE and the standby ACE peer.                                                                                                                                                                                                      |
| <b>SSL Certificates/Keys On Both HA Peers</b> |                                                                                                                                                                                                                                                                                                                                              |
| File Type                                     | Format of the file: PEM, DER, or PKCS12.                                                                                                                                                                                                                                                                                                     |
| Name                                          | Name of the file that contains the certificate or key pair.                                                                                                                                                                                                                                                                                  |
| Exportable                                    | Field that indicates whether or not you can export the file from the ACE. Choices are as follows: <ul style="list-style-type: none"> <li><b>Yes</b>—You can export the file to an FTP, SFTP, or TFP server (see <a href="#">Chapter 11, “Configuring SSL”</a>).</li> <li><b>No</b>—You cannot export the file as it is protected.</li> </ul> |
| Matched                                       | Field that indicates that the SSL certificate and key pair is a match on the peer ACE.                                                                                                                                                                                                                                                       |
| Available On                                  | Field that identifies the ACE devices that contain the SSL certificate and key pair.                                                                                                                                                                                                                                                         |

- Step 3** To copy an SSL certificate and key pair to the ACE peer device, choose it from the SSL Certificates/Keys On Both HA Peers list, and then click **Copy To Peer** (or click **Cancel** to close the SSL Certificate/Key Reconciliation popup window without performing the copy).
- Step 4** To delete an SSL certificate and key pair from the ACE HA pair, choose it from the SSL Certificates/Keys On Both HA Peers list, and click **Delete** (or click **Cancel** to close the SSL Certificate/Key Reconciliation popup window without performing the deletion).
- 

**Related Topics**

- [Understanding ANM High Availability, page 13-2](#)
- [Configuring ACE High Availability Peers, page 13-15](#)
- [Configuring ACE High Availability Groups, page 13-17](#)
- [Synchronizing ACE High Availability Configurations, page 13-30](#)

■ Synchronizing SSL Certificate and Key Pairs on Both ACE Peers





# CHAPTER 14

## Configuring Traffic Policies

---

**Date:** 3/28/12

Cisco Application Networking Manager helps you configure class maps and policy maps to provide a global level of classification for filtering traffic received by or passing through the ACE.



**Note**

---

When naming ACE objects (such as a real server, virtual server, parameter map, class map, health probe, and so on), enter an alphanumeric string of 1 to 64 characters, which can include the following special characters: underscore (\_), hyphen (-), dot (.), and asterisk (\*). Spaces are not allowed.

If you are using ANM with an ACE module or ACE appliance and you configure a named object at the ACE CLI, keep in mind that ANM does not support all of the special characters that the ACE CLI allows you to use when configuring a named object. If you use special characters that ANM does not support, you may not be able to import or manage the ACE using ANM.

---

This chapter includes the following sections:

- [Traffic Policy Overview, page 14-1](#)
- [Class Map and Policy Map Overview, page 14-2](#)
- [Configuring Virtual Context Class Maps, page 14-6](#)
- [Setting Match Conditions for Class Maps, page 14-8](#)
- [Configuring Virtual Context Policy Maps, page 14-32](#)
- [Configuring Rules and Actions for Policy Maps, page 14-34](#)
- [Configuring Actions Lists, page 14-85](#)

## Traffic Policy Overview

Cisco Application Networking Manager helps you configure class maps and policy maps to provide a global level of classification for filtering traffic received by or passing through the ACE. You create traffic policies and attach these policies to one or more VLAN interfaces associated with the ACE to apply feature-specific actions to the matching traffic. The ACE uses the individual traffic policies to implement functions such as:

- FTP command inspection
- IP normalization and fragment reassembly
- Network Address Translation (NAT)

- Optimization of HTTP traffic
- Protocol deep packet inspection
- Remote access using Secure Shell (SSH) or Telnet
- Secure Socket Layer (SSL) security services between a Web browser (the client) and the HTTP connection (the server)
- Server load balancing
- TCP termination, normalization, and reuse

#### Related Topics

- [Class Map and Policy Map Overview, page 14-2](#)
- [Configuring Virtual Context Class Maps, page 14-6](#)
- [Configuring Virtual Context Policy Maps, page 14-32](#)

## Class Map and Policy Map Overview

You classify inbound network traffic destined to, or passing through, the ACE based on a series of flow match criteria specified by a class map. Each class map defines a traffic classification; that is, network traffic that is of interest to you. A policy map defines a series of actions (functions) that you want applied to a set of classified inbound traffic.

Class maps enable you to classify network traffic based on the following criteria:

- Layer 3 and Layer 4 traffic flow information—Source or destination IP address, source or destination port, virtual IP address, or IP protocol
- Layer 7 protocol information—HTTP cookie, HTTP URL, HTTP header, HTTP content, FTP request commands, RADIUS, RDP, RTSP, Skinny, or SIP

The policies that you can configure depend on the ACE you are configuring. [Table 14-1](#) lists the available policies and the ACE devices that support them.

**Table 14-1** Traffic Policies and ACE Device Support

| Policy Map Type                                   | Description                                                                       | ACE Device |               |
|---------------------------------------------------|-----------------------------------------------------------------------------------|------------|---------------|
|                                                   |                                                                                   | ACE Module | ACE Appliance |
| Layer 3/4 Management Traffic (First-Match)        | Layer 3 and Layer 4 policy map for network management traffic received by the ACE | X          | X             |
| Layer 3/4 Network Traffic (First-Match)           | Layer 3 and Layer 4 policy map for traffic passing through the ACE                | X          | X             |
| Layer 7 Command Inspection - FTP (First-Match)    | Layer 7 policy map for inspection of FTP commands                                 | X          | X             |
| Layer 7 Deep Packet Inspection - HTTP (All-Match) | Layer 7 policy map for inspection of HTTP packets                                 | X          | X             |
| Layer 7 Deep Packet Inspection - SIP (All-Match)  | Layer 7 policy map for inspection of SIP packets                                  | X          | X             |
| Layer 7 Deep Packet Inspection - Skinny           | Layer 7 policy map for inspection of Skinny Client Control Protocol (SCCP)        | X          | X             |

**Table 14-1** Traffic Policies and ACE Device Support (continued)

| Policy Map Type                               | Description                                          | ACE Device |               |
|-----------------------------------------------|------------------------------------------------------|------------|---------------|
|                                               |                                                      | ACE Module | ACE Appliance |
| Layer 7 HTTP Optimization (First-Match)       | Layer 7 policy map for optimizing HTTP traffic       |            | X             |
| Layer 7 Server Load Balancing (First-Match)   | Layer 7 policy map for HTTP server load balancing    | X          | X             |
| Server Load Balancing - Generic (First-Match) | Generic Layer 7 policy map for server load balancing | X          | X             |
| Server Load Balancing - RADIUS (First-Match)  | Layer 7 policy map for RADIUS server load balancing  | X          | X             |
| Server Load Balancing - RDP (First-Match)     | Layer 7 policy map for RDP server load balancing     | X          | X             |
| Server Load Balancing - RTSP (First-Match)    | Layer 7 policy map for RTSP server load balancing    | X          | X             |
| Server Load Balancing - SIP (First-Match)     | Layer 7 policy map for SIP server load balancing     | X          | X             |

The traffic classification process consists of the following three steps:

1. Creating a class map, which comprise a set of match criteria related to Layer 3 and Layer 4 traffic classifications or Layer 7 protocol classifications.
2. Creating a policy map, which refers to the class maps and identifies a series of actions to perform based on the traffic match criteria.
3. Activating the policy map and attaching it to a specific VLAN interface or globally to all VLAN interfaces associated with a context by configuring a virtual context global traffic policy to filter traffic received by the ACE.

The following overview topics describe the components that define a traffic policy:

- [Class Maps, page 14-3](#)
- [Policy Maps, page 14-4](#)
- [Parameter Maps and Their Use in Layer 3 and Layer 4 Policy Maps, page 14-5](#)
- [Applying a Policy Map Globally to All VLAN Interfaces, page 6-35](#)

## Class Maps

A class map defines each type of Layer 3 and Layer 4 traffic class and each Layer 7 protocol class. You create class maps to classify the traffic received and transmitted by the ACE as follows:

- Layer 3 and Layer 4 traffic classes contain match criteria that identify the IP network traffic that can pass through the ACE or network management traffic that can be received by the ACE.
- Layer 7 protocol-specific classes identify:
  - Server load-balancing traffic on generic, HTTP, RADIUS, RTSP, or SIP traffic
  - HTTP or SIP traffic for deep packet inspection
  - FTP traffic for inspection of commands

A traffic class contains the following components:

- Class map name
- Class map type
- One or more match conditions that define the match criteria for the class map
- Instructions on how the ACE evaluates match conditions when you specify more than one match statement in a traffic class (match-any, match-all)

The individual match conditions specify the criteria for classifying Layer 3 and Layer 4 network traffic as well as the Layer 7 server load balancing and application protocol-specific fields. The ACE evaluates the packets to determine whether they match the specified criteria. If a statement matches, the ACE considers that packet to be a member of the class and forwards the packet according to the specifications set in the traffic policy. Packets that fail to meet any of the matching criteria are classified as members of the default traffic class if one is specified.

The ACE allows you to configure two Layer 7 load-balancing class maps in a nested traffic class configuration to create a single traffic class. You can nest Layer 7 class maps to achieve complex logical expressions. The ACE restricts the nesting of class maps to two levels to prevent you from including one nested class map under a different class map.

#### Related Topics

- [Class Map and Policy Map Overview, page 14-2](#)
- [Policy Maps, page 14-4](#)
- [Parameter Maps and Their Use in Layer 3 and Layer 4 Policy Maps, page 14-5](#)
- [Configuring Traffic Policies, page 14-1](#)
- [Configuring Virtual Context Class Maps, page 14-6](#)

## Policy Maps

A policy map creates the traffic policy. The purpose of a traffic policy is to implement specific ACE functions associated with a traffic class. A traffic policy contains the following components:

- Policy map name
- Previously created traffic class map or, optionally, the class-default class map
- One or more of the individual Layer 3 and Layer 4 or Layer 7 policies that specify the actions to be performed by the ACE

A Layer 7 policy map is always associated within a Layer 3 and Layer 4 policy map to provide an entry point for traffic classification. Layer 7 policy maps are considered to be child policies and can only be nested under a Layer 3 and Layer 4 policy map. Only a Layer 3 and Layer 4 policy map can be activated on a VLAN interface; a Layer 7 policy map cannot be directly applied on an interface. For example, to associate a Layer 7 load-balancing policy map, you nest the load-balancing policy map by using the Layer 3 and Layer 4 Policy map action type.

If none of the classifications specified in policy maps match, then the ACE executes the default actions specified against the class map configured with the Use Class Default option to use a default class map (if specified). All traffic that fails to meet the other matching criteria in the named class map belongs to the default traffic class. The Use Class Default feature has an implicit **match-any** match statement and is used to match any traffic classification.

The ACE supports flexible class map ordering within a policy map. The ACE executes only the actions for the first matching traffic classification, so the order of class maps within a policy map is very important. The policy lookup order is based on the security features of the ACE. The policy lookup order is implicit, irrespective of the order in which you configure policies on the interface.

The policy lookup order of the ACE is as follows:

1. Access control (permit or deny a packet)
2. Permit or deny management traffic
3. TCP/UDP connection parameters
4. Load balancing based on a virtual IP (VIP)
5. Application protocol inspection
6. Source NAT
7. Destination NAT

The sequence in which the ACE applies the actions for a specific policy is independent of the actions configured for a class map inside a policy.

#### Related Topics

- [Class Map and Policy Map Overview, page 14-2](#)
- [Class Maps, page 14-3](#)
- [Parameter Maps and Their Use in Layer 3 and Layer 4 Policy Maps, page 14-5](#)
- [Configuring Traffic Policies, page 14-1](#)
- [Configuring Virtual Context Policy Maps, page 14-32](#)

## Parameter Maps and Their Use in Layer 3 and Layer 4 Policy Maps

Parameter maps allow you to combine related actions in a Layer 3 and Layer 4 policy map. For example, an HTTP parameter map provides a means of performing actions on traffic ingressing an ACE interface based on certain criteria such as HTTP header and cookie settings, server connection reuse, action to be taken when an HTTP header, cookie, or URL exceeds a configured maximum length, and so on.

The ACE uses policy maps to combine class maps and parameter maps into traffic policies and to perform certain configured actions on the traffic that matches the specified criteria in the policies.

See [Table 10-1](#) for a list of the available parameter maps and the ACE devices that support them.

#### Related Topics

- [Configuring Parameter Maps, page 10-1](#)
- [Class Map and Policy Map Overview, page 14-2](#)
- [Class Maps, page 14-3](#)
- [Policy Maps, page 14-4](#)

## Protocol Inspection Overview

Certain applications require special handling of the data portion of a packet as the packets pass through the ACE. Application protocol inspection helps to verify the protocol behavior and identify unwanted or malicious traffic passing through the ACE. Based on the specifications of the traffic policy, the ACE accepts or rejects the packets to ensure the secure use of applications and services.

For information about application protocol inspection as configured and performed by the ACE, see the related topics.

### Related Topics

- [Configuring Virtual Context Policy Maps, page 14-32](#)
- [Setting Match Conditions for Layer 7 FTP Command Inspection Class Maps, page 14-22](#)
- [Setting Policy Map Rules and Actions for Layer 7 HTTP Deep Packet Inspection, page 14-51](#)
- [Setting Policy Map Rules and Actions for Layer 7 SIP Deep Packet Inspection, page 14-68](#)

## Configuring Virtual Context Class Maps

You can create a class map to classify the traffic received and transmitted by the ACE. For more information about class maps, see the “[Class Maps](#)” section on page 14-3.



### Note

To delete a class map from a context, the class map must no longer be in use. To delete multiple class maps, none of the class maps must be in use. If you attempt to delete multiple class maps and one of the class maps is still in use, none of the class maps are deleted and a message appears stating that one of the class maps is in use. Remove the class map that is still in use from your selection, then click **Delete**. The selected class maps are removed.

### Procedure

- 
- Step 1** Choose **Config > Devices > context > Expert > Class Maps**.
- The Class Maps table appears.
- Step 2** In the Class Maps table, click **Add** to add a new class map, or choose an existing class map and click **Edit** to modify it.
- Step 3** (Optional) Enter a class map identifier number.
- The Name field contains an automatically incremented number for the class map. You can leave the number as it is or enter a different, unique number.
- Step 4** In the Class Map Type field, choose the type of class map that you are creating.
- The types that are available depend on the ACE that you are configuring. [Table 14-2](#) lists the available class map types and the ACE devices that support them.

**Table 14-2** Class Maps and ACE Device Support

| Class Map                             | ACE Devices |               |
|---------------------------------------|-------------|---------------|
|                                       | ACE Module  | ACE Appliance |
| Layer 3/4 Management Traffic          | X           | X             |
| Layer 3/4 Network Traffic             | X           | X             |
| Layer 7 Command Inspection - FTP      | X           | X             |
| Layer 7 Deep Packet Inspection - HTTP | X           | X             |
| Layer 7 Deep Packet Inspection - SIP  | X           | X             |
| Layer 7 Server Load Balancing         | X           | X             |
| Server Load Balancing - Generic       | X           | X             |
| Server Load Balancing - RADIUS        | X           | X             |
| Server Load Balancing - RTSP          | X           | X             |
| Server Load Balancing - SIP           | X           | X             |

- Step 5** In the Match Type field, choose the method to be used to evaluate multiple match statements when multiple match conditions exist:
- **All**—A match exists only if all match conditions are satisfied. If you choose All, you can specify multiple types of match conditions.
  - **Any**—A match exists if at least one of the match conditions is satisfied. If you choose Any, you can specify only one type of match condition.

This field does not appear for Layer 7 Command Inspection - FTP class maps.

- Step 6** In the Description field, enter a brief description for the class map.

- Step 7** Do one of the following:

- Click **Deploy Now** to deploy this configuration on the ACE and to configure match conditions for the class map. See [Setting Match Conditions for Class Maps, page 14-8](#) for more information.
- Click **Cancel** to exit the procedure without saving your entries and to return to the Class Maps table.
- Click **Next** to deploy your entries and to configure another class map.

#### Related Topics

- [Information About Virtual Contexts, page 6-2](#)
- [Deleting Class Maps, page 14-8](#)
- [Setting Match Conditions for Class Maps, page 14-8](#)
- [Configuring Virtual Context Policy Maps, page 14-32](#)

## Deleting Class Maps

You can delete a class map. To delete a class map from a context, the class map must no longer be in use. To delete multiple class maps, none of the class maps must be in use.

### Assumption

The class map to be deleted is not being used.

### Procedure

**Step 1** Choose **Config > Devices > context > Expert > Class Maps**.

The Class Maps table appears.

**Step 2** In the Class Maps table, choose the class maps that you want to delete and click **Delete**.

A confirmation popup window appears, asking you to confirm the deletion.

If you attempt to delete multiple class maps and one of the class maps is still in use, none of the class maps are deleted and a message appears stating that one of the class map is in use. Remove the class map that is still in use from your selection, then click **Delete**. The Class Maps table refreshes and the deleted class maps no longer appear.

**Step 3** Do one of the following:

- Click **OK** to confirm the deletion.
- Click **Cancel** to retain the class map and to return to the Class Maps table.

### Related Topics

- [Class Map and Policy Map Overview, page 14-2](#)
- [Configuring Virtual Context Class Maps, page 14-6](#)

## Setting Match Conditions for Class Maps

[Table 14-3](#) lists the class maps available for all ACE devices and provides links to topics for setting match conditions:

**Table 14-3** Class Maps Available for All ACE Devices

| Class Map                           | Related Topic                                                                                           |
|-------------------------------------|---------------------------------------------------------------------------------------------------------|
| Layer 3/Layer 4 management traffic  | <a href="#">Setting Match Conditions for Layer 3/Layer 4 Management Traffic Class Maps, page 14-12</a>  |
| Layer 3/Layer 4 network traffic     | <a href="#">Setting Match Conditions for Layer 3/Layer 4 Network Traffic Class Maps, page 14-9</a>      |
| Layer 7 FTP command inspection      | <a href="#">Setting Match Conditions for Layer 7 FTP Command Inspection Class Maps, page 14-22</a>      |
| Layer 7 HTTP deep packet inspection | <a href="#">Setting Match Conditions for Layer 7 HTTP Deep Packet Inspection Class Maps, page 14-17</a> |
| Layer 7 server load balancing       | <a href="#">Setting Match Conditions for Layer 7 Server Load Balancing Class Maps, page 14-14</a>       |



**Table 14-3** Class Maps Available for All ACE Devices (continued)

| Class Map                          | Related Topic                                                                                          |
|------------------------------------|--------------------------------------------------------------------------------------------------------|
| Generic server load balancing      | <a href="#">Setting Match Conditions for Generic Server Load Balancing Class Maps, page 14-23</a>      |
| Layer 7 SIP deep packet inspection | <a href="#">Setting Match Conditions for Layer 7 SIP Deep Packet Inspection Class Maps, page 14-30</a> |
| RADIUS server load balancing       | <a href="#">Setting Match Conditions for RADIUS Server Load Balancing Class Maps, page 14-25</a>       |
| RTSP server load balancing         | <a href="#">Setting Match Conditions for RTSP Server Load Balancing Class Maps, page 14-26</a>         |
| SIP server load balancing          | <a href="#">Setting Match Conditions for SIP Server Load Balancing Class Maps, page 14-27</a>          |

## Setting Match Conditions for Layer 3/Layer 4 Network Traffic Class Maps

You can match criteria for a Layer 3/Layer 4 network traffic class map on the ACE.

### Assumption

You have configured a Layer 3/Layer 4 network traffic class map and want to establish match conditions.

### Procedure

- 
- Step 1** Choose **Config > Devices > context > Expert > Class Maps**.  
The Class Maps table appears.
- Step 2** In the Class Maps table, choose the Layer 3/4 network traffic class map that you want to set match conditions for.  
The Match Condition table appears.
- Step 3** In the Match Condition table, click **Add** to add match criteria, or choose the match condition you want to modify and click **Edit**.  
The Match Condition configuration window appears.
- Step 4** In the Sequence Number field of the Match Condition configuration window, enter a value from 2 to 255.
- Step 5** In the Match Condition Type field, choose the type of match condition to use for this class map and configure any match-specific attributes as described in [Table 14-4](#).



**Note** Fields and information related to IPv6 require ACE module and ACE appliance software Version A5(1.0) or later.

**Table 14-4** Layer 3/Layer 4 Network Traffic Class Map Match Conditions

| Match Condition | Description                                                                                                                              |
|-----------------|------------------------------------------------------------------------------------------------------------------------------------------|
| Access List     | Access list that is the match type for this match condition.<br>In the Extended ACL field, choose the ACL to use as the match condition. |
| Any             | Any Layer 3 or Layer 4 IPv4 traffic passing through the ACE meets the match condition.                                                   |

Table 14-4 Layer 3/Layer 4 Network Traffic Class Map Match Conditions (continued)

| Match Condition     | Description                                                                                                                                                                                                                                                                                                                                                                                                                                                                                                                                                                                                                                                                                                                                                                                                                                                                                                                                                                                                                                                                                                                                                                                                                                                                                  |
|---------------------|----------------------------------------------------------------------------------------------------------------------------------------------------------------------------------------------------------------------------------------------------------------------------------------------------------------------------------------------------------------------------------------------------------------------------------------------------------------------------------------------------------------------------------------------------------------------------------------------------------------------------------------------------------------------------------------------------------------------------------------------------------------------------------------------------------------------------------------------------------------------------------------------------------------------------------------------------------------------------------------------------------------------------------------------------------------------------------------------------------------------------------------------------------------------------------------------------------------------------------------------------------------------------------------------|
| Anyv6               | Any Layer 3 or Layer 4 IPv6 traffic passing through the ACE meets the match condition. This option requires ACE module and ACE appliance software Version A5(1.0) or later, which supports IPv4 and IPv6.                                                                                                                                                                                                                                                                                                                                                                                                                                                                                                                                                                                                                                                                                                                                                                                                                                                                                                                                                                                                                                                                                    |
| Destination Address | <p>Destination address that is the match type for this match condition.</p> <p>Do the following:</p> <ol style="list-style-type: none"> <li>a. In the IP Address Type field, choose either <b>IPv4</b> or <b>IPv6</b>. This field appears only for ACE module and ACE appliance software Version A5(1.0) or later, which supports IPv4 and IPv6.</li> <li>b. In the Destination Address field, enter the destination IP address for this match condition in the format based on the address type (IPv4 or IPv6).</li> <li>c. Depending on the destination IP address type that you chose, do one of the following: <ul style="list-style-type: none"> <li>– For IPv4, in the Destination Netmask field, select the subnet mask of the IP address.</li> <li>– For IPv6, in the Destination Prefix-length field, enter the prefix length for the address.</li> </ul> </li> </ol>                                                                                                                                                                                                                                                                                                                                                                                                               |
| Port                | <p>UDP or TCP port or range of ports for IPv4 traffic that is the match type for this match condition.</p> <p>Do the following:</p> <ol style="list-style-type: none"> <li>a. In the Port Protocol field, choose TCP or UDP as the protocol to match.</li> <li>b. In the Port Operator field, choose the match criteria for the port.</li> </ol> <p>Choices are as follows:</p> <ul style="list-style-type: none"> <li>– <b>Any</b>—Any port using the selected protocol meets the match condition.</li> <li>– <b>Equal To</b>—Specific port using the protocol meets the match condition.</li> <li>– In the Port Number field, enter the port to be matched. Valid entries are integers from 0 to 65535. A value of 0 indicates that the ACE is to include all ports.</li> <li>– <b>Range</b>—Port must be one of a range of ports to meet the match condition. Do the following: <ol style="list-style-type: none"> <li>1. In the Lower Port Number field, enter the first port number in the port range for the match condition.</li> <li>2. In the Upper Port Number field, enter the last port number in the port range for the match condition.</li> </ol> </li> </ul> <p>Valid entries are integers from 0 to 65535. A value of 0 indicates that the ACE is to include all ports.</p> |
| Portv6              | <p>UDP or TCP port or range of ports for IPv6 traffic that is the match type for this match condition. This option requires ACE module and ACE appliance software Version A5(1.0) or later, which supports IPv4 and IPv6.</p> <p>For port configuration information, see <a href="#">Port</a>.</p>                                                                                                                                                                                                                                                                                                                                                                                                                                                                                                                                                                                                                                                                                                                                                                                                                                                                                                                                                                                           |

Table 14-4 Layer 3/Layer 4 Network Traffic Class Map Match Conditions (continued)

| Match Condition | Description                                                                                                                                                                                                                                                                                                                                                                                                                                                                                                                                                                                                                                                                                                                                                                                                                                                                                                                                                                                                                                                                                                                                                                                                                                                                                                                                                                                                                                                                                                                                                                                                                                                                                                                                                                                                                                                                                                                                                                                                                                                                                                                                                                                                                                                                                                                                                          |
|-----------------|----------------------------------------------------------------------------------------------------------------------------------------------------------------------------------------------------------------------------------------------------------------------------------------------------------------------------------------------------------------------------------------------------------------------------------------------------------------------------------------------------------------------------------------------------------------------------------------------------------------------------------------------------------------------------------------------------------------------------------------------------------------------------------------------------------------------------------------------------------------------------------------------------------------------------------------------------------------------------------------------------------------------------------------------------------------------------------------------------------------------------------------------------------------------------------------------------------------------------------------------------------------------------------------------------------------------------------------------------------------------------------------------------------------------------------------------------------------------------------------------------------------------------------------------------------------------------------------------------------------------------------------------------------------------------------------------------------------------------------------------------------------------------------------------------------------------------------------------------------------------------------------------------------------------------------------------------------------------------------------------------------------------------------------------------------------------------------------------------------------------------------------------------------------------------------------------------------------------------------------------------------------------------------------------------------------------------------------------------------------------|
| Source Address  | <p>Source IP address that is the match type for this match condition.</p> <p>Do the following:</p> <ol style="list-style-type: none"> <li>a. In the IP Address Type field, choose either <b>IPv4</b> or <b>IPv6</b>. This field appears only for ACE module and ACE appliance software Version A5(1.0) or later, which supports IPv4 and IPv6.</li> <li>b. In the Source IP Address field, enter the source IP address for this match condition in the format based on the address type (IPv4 or IPv6).</li> <li>c. Depending on the source IP address type that you chose, do one of the following: <ul style="list-style-type: none"> <li>– For IPv4, in the Source Netmask field, select the subnet mask of the IP address.</li> <li>– For IPv6, in the Source Prefix-length field, enter the prefix length for the address.</li> </ul> </li> </ol>                                                                                                                                                                                                                                                                                                                                                                                                                                                                                                                                                                                                                                                                                                                                                                                                                                                                                                                                                                                                                                                                                                                                                                                                                                                                                                                                                                                                                                                                                                               |
| Virtual Address | <p>Virtual IP address that is the match type for this match condition.</p> <p>Do the following:</p> <ol style="list-style-type: none"> <li>a. In the IP Address Type field, choose either <b>IPv4</b> or <b>IPv6</b>. This field appears only for ACE module and ACE appliance software Version A5(1.0) or later, which supports IPv4 and IPv6.</li> <li>a. In the Virtual IP Address field, enter the virtual IP address for this match condition in the format based on the address type (IPv4 or IPv6).</li> <li>b. Depending on the IP address type that you chose, do one of the following: <ul style="list-style-type: none"> <li>– For IPv4, in the Virtual IP Netmask field, choose the subnet mask for the virtual IP address.</li> <li>– For IPv6, in the Virtual Prefix-length field, enter the prefix length for the address.</li> </ul> </li> <li>c. In the Virtual Address Protocol field, choose the protocol to be used for this match condition. For a list of protocols and their respective numbers, see <a href="#">Table 6-20</a>.</li> </ol> <p> <b>Note</b> Depending on the protocol that you choose, such as TCP or UDP, additional fields appear. If they appear, enter the information described in the following steps.</p> <ol style="list-style-type: none"> <li>d. In the Port Operator field, choose the match criteria for the port: <ul style="list-style-type: none"> <li>– <b>Any</b>—Any port using the selected protocol meets the match condition.</li> <li>– <b>Equal To</b>—A specific port using the protocol meets the match condition.</li> <li>– In the Port Number field, enter the port to be matched. Valid entries are from 0 to 65535. A value of 0 indicates that the ACE is to include all ports.</li> <li>– <b>Range</b>—The port must be one of a range of ports to meet the match condition. Valid entries are from 0 to 65535. A value of 0 indicates that the ACE is to include all ports.</li> </ul> <p>Do the following:</p> <ol style="list-style-type: none"> <li>1. In the Lower Port Number field, enter the first port number in the port range for the match condition.</li> <li>2. In the Upper Port Number field, enter the last port number in the port range for the match condition.</li> </ol> </li> </ol> |

**Step 6** Do one of the following:

- Click **Deploy Now** to deploy this configuration on the ACE and save your entries to the running-configuration and startup-configuration files. You return to the Match Condition table.



**Note** If you click **Deploy Now**, the ACE drops the traffic and then restarts it, even if you have not made changes. If you have not altered existing match conditions, click **Cancel** instead of **Deploy Now** to ensure uninterrupted traffic.

- Click **Cancel** to exit the procedure without saving your entries and to return to the Match Condition table.
- Click **Next** to deploy your entries and to configure additional match conditions.

#### Related Topics

- [Configuring Traffic Policies, page 14-1](#)
- [Setting Match Conditions for Layer 3/Layer 4 Management Traffic Class Maps, page 14-12](#)
- [Setting Match Conditions for Layer 7 Server Load Balancing Class Maps, page 14-14](#)
- [Configuring Virtual Context Policy Maps, page 14-32](#)
- [Configuring Virtual Context Class Maps, page 14-6](#)

## Setting Match Conditions for Layer 3/Layer 4 Management Traffic Class Maps

You can identify the network management protocols that can be received by the ACE.

#### Assumption

You have configured a Layer 3/Layer 4 network management class map and want to establish match conditions.

#### Procedure

**Step 1** Choose **Config > Devices > context > Expert > Class Maps**.

The Class Maps table appears.

**Step 2** In the Class Maps table, choose the Layer 3/Layer 4 management class map that you want to set match conditions for.

The Match Condition table appears.

**Step 3** In the Match Condition table, click **Add** to add match criteria, or choose the match conditions that you want to modify and click **Edit**.

The Match Condition configuration window appears.

**Step 4** Enter the match conditions (see [Table 14-5](#)).



**Note** Fields and information related to IPv6 require ACE module and ACE appliance software Version A5(1.0) or later.

**Table 14-5 Layer 3/Layer 4 Management Traffic Class Map Match Conditions**

| Field                    | Description                                                                                                                                                                                                                                                                                                                                                                                                                                                                                                                                                                                                                                                                                                                                                                                                                                                                                                                                                                                                                                                                                                                                                                                                  |
|--------------------------|--------------------------------------------------------------------------------------------------------------------------------------------------------------------------------------------------------------------------------------------------------------------------------------------------------------------------------------------------------------------------------------------------------------------------------------------------------------------------------------------------------------------------------------------------------------------------------------------------------------------------------------------------------------------------------------------------------------------------------------------------------------------------------------------------------------------------------------------------------------------------------------------------------------------------------------------------------------------------------------------------------------------------------------------------------------------------------------------------------------------------------------------------------------------------------------------------------------|
| Sequence Number          | Number from 2 to 255 as the line number. The number entered here does not indicate a priority or sequence for the match conditions.                                                                                                                                                                                                                                                                                                                                                                                                                                                                                                                                                                                                                                                                                                                                                                                                                                                                                                                                                                                                                                                                          |
| Match Condition Type     | Confirm that <b>Management</b> is selected.<br><br><b>Note</b> To change the type of match condition, you must delete the class map and add it again with the correct match type.                                                                                                                                                                                                                                                                                                                                                                                                                                                                                                                                                                                                                                                                                                                                                                                                                                                                                                                                                                                                                            |
| Management Protocol Type | Field that identifies the network management protocols that can be received by the ACE. Choose the allowed protocol for this match condition as follows: <ul style="list-style-type: none"> <li>• <b>HTTP</b>—Specifies the Hypertext Transfer Protocol (HTTP).</li> <li>• <b>HTTPS</b>—Specifies the secure (SSL) Hypertext Transfer Protocol (HTTP) for connectivity with the ANM GUI on the ACE.</li> <li>• <b>ICMP</b>—Specifies the Internet Control Message Protocol (ICMP), commonly referred to as ping.</li> <li>• <b>ICMPv6</b>—Specifies the Internet Control Message Protocol version 6 (ICMPv6).</li> <li>• <b>SNMP</b>—Specifies the Simple Network Management Protocol (SNMP).</li> <li>• <b>SSH</b>—Specifies a Secure Shell (SSH) connection to the ACE.</li> <li>• <b>TELNET</b>—Specifies a Telnet connection to the ACE.</li> <li>• <b>KAL-AP-UDP</b>—Specifies the KeepAlive Appliance Protocol over UDP.</li> <li>• <b>XML-HTTPS</b>—Specifies HTTPS as the transfer protocol for sending and receiving XML documents between the ACE and a Network Management System (NMS). Communication is performed using port 10443. This option is available for ACE appliances only.</li> </ul> |
| Traffic Type             | Type of traffic: <ul style="list-style-type: none"> <li>• <b>Any</b>—Any client source IP address meets the match condition.</li> <li>• <b>Source Address</b>—A specific source IP address is part of the match condition.</li> </ul>                                                                                                                                                                                                                                                                                                                                                                                                                                                                                                                                                                                                                                                                                                                                                                                                                                                                                                                                                                        |
| Source Address           | Field that appears if Source Address is selected for Traffic Type.<br><br>Depending on the management protocol type that you chose, do one of the following <ul style="list-style-type: none"> <li>• For ICMP, enter the source IP address of the client in dotted-decimal notation, such as 192.168.11.1.</li> <li>• For ICMPv6, enter a complete IPv6 address.</li> </ul>                                                                                                                                                                                                                                                                                                                                                                                                                                                                                                                                                                                                                                                                                                                                                                                                                                  |
| Source Netmask           | Field that appears if Source Address is selected for Traffic Type. Choose the subnet mask for the source IP address.                                                                                                                                                                                                                                                                                                                                                                                                                                                                                                                                                                                                                                                                                                                                                                                                                                                                                                                                                                                                                                                                                         |
| Source Prefix-length     | This field appears if ICMPv6 is selected for the Management Protocol Type and Source Address is selected for Traffic Type.<br><br>Enter the prefix length for the source IPv6 address.                                                                                                                                                                                                                                                                                                                                                                                                                                                                                                                                                                                                                                                                                                                                                                                                                                                                                                                                                                                                                       |

**Step 5** Do one of the following:

- Click **Deploy Now** to deploy this configuration on the ACE and save your entries to the running-configuration and startup-configuration files. You return to the Match Condition table.



**Note** If you click **Deploy Now**, the ACE drops the traffic and then restarts it, even if you have not made changes. If you have not altered existing match conditions, click **Cancel** instead of **Deploy Now** to ensure uninterrupted traffic.

- Click **Cancel** to exit the procedure without saving your entries and to return to the Match Condition table.
- Click **Next** to deploy your entries and to configure additional match conditions.

#### Related Topics

- [Configuring Traffic Policies, page 14-1](#)
- [Configuring Virtual Context Class Maps, page 14-6](#)
- [Configuring Real Servers, page 8-5](#)
- [Configuring Server Farms, page 8-30](#)
- [Configuring Sticky Groups, page 9-7](#)

## Setting Match Conditions for Layer 7 Server Load Balancing Class Maps

You can set match conditions for Layer 7 server load balancing class maps.

#### Assumption

You have configured a load-balancing class map and want to establish the match conditions.

#### Procedure

- 
- Step 1** Choose **Config > Devices > context > Expert > Class Maps**.  
The Class Maps table appears.
- Step 2** In the Class Maps table, choose the Layer 7 server load balancing class map you want to set match conditions for.  
The Match Condition table appears.
- Step 3** In the Match Condition table, click **Add** to add match criteria, or choose the match condition that you want to modify and click **Edit**.  
The Match Condition configuration window appears.
- Step 4** In the Sequence Number field, enter a value from 2 to 255 as the line number.  
The number entered here does not indicate a priority or sequence for the match conditions.
- Step 5** In the Match Condition Type field, choose the type of match to use and configure condition-specific attributes as described in [Table 14-6](#).



**Note** Fields and information related to IPv6 require ACE module and ACE appliance software Version A5(1.0) or later.

**Table 14-6 Layer 7 Server Load Balancing Class Map Match Conditions**

| Match Condition | Description                                                                                                                                                                                                                                                                                                                                                                                                                                                                                                                                                                                                                                                                                                                                                                                                                                                                                                                                                                                                                                                                                                                                                                                                                                                                        |
|-----------------|------------------------------------------------------------------------------------------------------------------------------------------------------------------------------------------------------------------------------------------------------------------------------------------------------------------------------------------------------------------------------------------------------------------------------------------------------------------------------------------------------------------------------------------------------------------------------------------------------------------------------------------------------------------------------------------------------------------------------------------------------------------------------------------------------------------------------------------------------------------------------------------------------------------------------------------------------------------------------------------------------------------------------------------------------------------------------------------------------------------------------------------------------------------------------------------------------------------------------------------------------------------------------------|
| Class Map       | <p>Class map that is to be used to establish a match condition.</p> <p>In the Class Map field, choose the class map to apply to this match condition.</p>                                                                                                                                                                                                                                                                                                                                                                                                                                                                                                                                                                                                                                                                                                                                                                                                                                                                                                                                                                                                                                                                                                                          |
| HTTP Content    | <p>Specific content contained within the HTTP entity-body that is used to establish a match condition.</p> <p>Do the following:</p> <ol style="list-style-type: none"> <li data-bbox="430 512 1500 573">a. In the Content Expression field, enter the content that is to be matched. Valid entries are alphanumeric strings from 1 to 255 characters.</li> <li data-bbox="430 590 1500 680">b. In the Content Offset (Bytes) field, enter the number of bytes to be ignored starting with the first byte of the Message body, after the empty line (CR,LF,CR,LF) between the headers and the body of the message. Valid entries are from 1 to 255.</li> </ol>                                                                                                                                                                                                                                                                                                                                                                                                                                                                                                                                                                                                                      |
| HTTP Cookie     | <p>HTTP cookie that is to be used to establish a match condition.</p> <p>Do the following:</p> <ol style="list-style-type: none"> <li data-bbox="430 785 1500 846">a. In the Cookie Name field, enter a unique cookie name. Valid entries are unquoted text strings with no spaces and a maximum of 64 alphanumeric characters.</li> <li data-bbox="430 863 1500 924">b. In the Cookie Value field, enter a unique cookie value expression. Valid entries are unquoted text strings with no spaces and a maximum of 255 alphanumeric characters.</li> <li data-bbox="430 940 1500 1062">c. Check the Secondary Cookie Matching check box to instruct the ACE to use both the cookie name and the cookie value to satisfy this match condition. Uncheck this check box to indicate that the ACE is to use either the cookie name or the cookie value to satisfy this match condition.</li> </ol>                                                                                                                                                                                                                                                                                                                                                                                    |
| HTTP Header     | <p>HTTP header that is to be used to establish a match condition.</p> <p>Do the following:</p> <ol style="list-style-type: none"> <li data-bbox="430 1169 1500 1381">a. In the Header Name field, specify the header to match in one of the following ways: <ul style="list-style-type: none"> <li data-bbox="483 1213 1500 1304">– To specify an HTTP header that is not one of the standard HTTP headers, click the first radio button, and enter the HTTP header name in the Header Name field. Valid entries are unquoted text strings with no spaces and a maximum of 64 characters.</li> <li data-bbox="483 1320 1500 1381">– To specify a standard HTTP header, click the second radio button, and choose an HTTP header from the list.</li> </ul> </li> <li data-bbox="430 1398 1500 1560">b. In the Header Value (Bytes) field, enter the header value expression string to compare against the value in the specified field in the HTTP header. Valid entries are text strings with a maximum of 255 alphanumeric characters. The ACE supports regular expressions for matching. If the string includes spaces, enclose the string in quotes. See <a href="#">Table 14-33</a> for a list of the supported characters that you can use in regular expressions.</li> </ol> |

Table 14-6 Layer 7 Server Load Balancing Class Map Match Conditions (continued)

| Match Condition | Description                                                                                                                                                                                                                                                                                                                                                                                                                                                                                                                                                                                                                                                                                                                                                                                                                                                                                                                      |
|-----------------|----------------------------------------------------------------------------------------------------------------------------------------------------------------------------------------------------------------------------------------------------------------------------------------------------------------------------------------------------------------------------------------------------------------------------------------------------------------------------------------------------------------------------------------------------------------------------------------------------------------------------------------------------------------------------------------------------------------------------------------------------------------------------------------------------------------------------------------------------------------------------------------------------------------------------------|
| HTTP URL        | <p>Portion of an HTTP URL that is to be used to establish a match condition.</p> <p>Do the following:</p> <ol style="list-style-type: none"> <li>In the URL Expression field, enter a URL or a portion of a URL to match. Valid entries are URL strings from 1 to 255 alphanumeric characters and include only the portion of the URL following <code>www.hostname.domain</code>. For example, in the URL <code>www.anydomain.com/latest/whatsnew.html</code>, include only <code>/latest/whatsnew.html</code>.</li> <li>In the Method Expression field, enter the HTTP method to match. Valid entries are method names entered as unquoted text strings with no spaces and a maximum of 15 alphanumeric characters. You can enter either one of the standard HTTP 1.1 method names (OPTIONS, GET, HEAD, POST, PUT, DELETE, TRACE, or CONNECT) or a text string that must be matched exactly (for example, CORVETTE).</li> </ol> |
| Source Address  | <p>Source IP address that is to be used to establish a match condition.</p> <p>Do the following:</p> <ol style="list-style-type: none"> <li>In the IP Address Type field, choose either <b>IPv4</b> or <b>IPv6</b>. This field appears only for ACE module and ACE appliance software Version A5(1.0) or later, which supports IPv4 and IPv6.</li> <li>In the Source Address field, enter the source IP address for this match condition in the format based on the address type (IPv4 or IPv6).</li> <li>Depending on the IP address type that you chose, do one of the following: <ul style="list-style-type: none"> <li>– For IPv4, in the Source Netmask field, choose the subnet mask of the source IP address.</li> <li>– For IPv6, in the Source Prefix-length field, enter the prefix length for the address.</li> </ul> </li> </ol>                                                                                     |

**Step 6** Do one of the following:

- Click **Deploy Now** to deploy this configuration on the ACE and save your entries to the running-configuration and startup-configuration files. You return to the Match Condition table.



**Note** If you click **Deploy Now**, the ACE drops the traffic and then restarts it, even if you have not made changes. If you have not altered existing match conditions, click **Cancel** instead of **Deploy Now** to ensure uninterrupted traffic.

- Click **Cancel** to exit the procedure without saving your entries and to return to the Match Condition table.
- Click **Next** to deploy your entries and to configure additional match conditions.

**Related Topics**

- [Information About Virtual Contexts, page 6-2](#)
- [Configuring Virtual Context Class Maps, page 14-6](#)
- [Configuring Virtual Context Policy Maps, page 14-32](#)



## Setting Match Conditions for Layer 7 HTTP Deep Packet Inspection Class Maps

You can configure a Layer 7 class map for deep packet inspection of HTTP traffic by the ACE. When these features are configured, the ACE performs a stateful deep packet inspection of the HTTP protocol and permits or restricts traffic based on the actions in the defined policy maps. You can configure the following security features as part of HTTP deep packet inspection to be performed by the ACE:

- Regular expression matching on name in an HTTP header, URL name, or content expressions in an HTTP entity body
- Content, URL, and HTTP header length checks
- MIME-type message inspection
- Transfer-encoding methods
- Content type verification and filtering
- Port 80 misuse by tunneling protocols
- RFC compliance monitoring and RFC method filtering

Use this procedure to configure a Layer 7 class map for deep packet inspection of HTTP traffic.

### Assumption

You have configured a Layer 7 HTTP deep packet inspection class map and want to establish match conditions.

### Procedure

- 
- Step 1** Choose **Config > Devices > context > Expert > Class Maps**.
- The Class Maps table appears.
- Step 2** In the Class Maps table, choose the Layer 7 HTTP deep packet inspection class map that you want to set match conditions for.
- The Match Condition table appears.
- Step 3** In the Match Condition table, click **Add** to add match criteria, or choose the match condition that you want to modify and click **Edit**.
- The Match Condition configuration window appears.
- Step 4** In the Sequence Number field of the Match Condition configuration window, enter a value from 2 to 255 as the line number.
- The number entered here does not indicate a priority or sequence for the match conditions.
- Step 5** In the Match Condition Type field, choose the method that match decisions are to be made and configure condition-specific attributes as described in [Table 14-7](#).

Table 14-7 Layer 7 HTTP Deep Packet Inspection Class Map Match Conditions

| Match Condition | Description                                                                                                                                                                                                                                                                                                                                                                                                                                                                                                                                                                                                                                                                                                                                                                                                                                                                                                                                                                                                                                                                                                                                                                                                                                                                                                                                                                                                                                                                                                                                                                                                                                                                                                                                                                                                                                                                                                                                                                                                                                                                                                              |
|-----------------|--------------------------------------------------------------------------------------------------------------------------------------------------------------------------------------------------------------------------------------------------------------------------------------------------------------------------------------------------------------------------------------------------------------------------------------------------------------------------------------------------------------------------------------------------------------------------------------------------------------------------------------------------------------------------------------------------------------------------------------------------------------------------------------------------------------------------------------------------------------------------------------------------------------------------------------------------------------------------------------------------------------------------------------------------------------------------------------------------------------------------------------------------------------------------------------------------------------------------------------------------------------------------------------------------------------------------------------------------------------------------------------------------------------------------------------------------------------------------------------------------------------------------------------------------------------------------------------------------------------------------------------------------------------------------------------------------------------------------------------------------------------------------------------------------------------------------------------------------------------------------------------------------------------------------------------------------------------------------------------------------------------------------------------------------------------------------------------------------------------------------|
| Content         | <p>Specific content contained within the HTTP entity-body that is to be used for protocol inspection decisions.</p> <p>Do the following:</p> <ol style="list-style-type: none"> <li>a. In the Content Expression field, enter the content that is to be matched. Valid entries are alphanumeric strings from 1 to 255 characters.</li> <li>b. In the Content Offset (Bytes) field, enter the number of bytes to be ignored starting with the first byte of the Message body, after the empty line (CR,LF,CR,LF) between the headers and the body of the message. Valid entries are from 1 to 255.</li> </ol>                                                                                                                                                                                                                                                                                                                                                                                                                                                                                                                                                                                                                                                                                                                                                                                                                                                                                                                                                                                                                                                                                                                                                                                                                                                                                                                                                                                                                                                                                                             |
| Content Length  | <p>Content parse length in an HTTP message that is to be used for protocol inspection decisions.</p> <p>Do the following:</p> <ol style="list-style-type: none"> <li>a. In the Content Length Operator field, choose the operand to use to compare content length as follows: <ul style="list-style-type: none"> <li>– <b>Equal To</b>—The content length must equal the number in the Content Length Value (Bytes) field.</li> <li>– <b>Greater Than</b>—The content length must be greater than the number in the Content Length Value (Bytes) field.</li> <li>– <b>Less Than</b>—The content length must be less than the number in the Content Length Value (Bytes) field.</li> <li>– <b>Range</b>—The content length must be within the range specified in the Content Length Lower Value (Bytes) field and the Content Length Higher Value (Bytes) field.</li> </ul> </li> <li>b. Enter values to apply for content length comparison as follows: <ul style="list-style-type: none"> <li>– If you chose Equal To, Greater Than, or Less Than in the Content Length Operator field, the Content Length Value (Bytes) field appears. In the Content Length Value (Bytes) field, enter the number of bytes for comparison. Valid entries are from 0 to 4294967295.</li> <li>– If you chose Range in the Content Length Operator field, the Content Length Lower Value (Bytes) and the Content Length Higher Value (Bytes) fields appear. Do the following: <ol style="list-style-type: none"> <li>1. In the Content Length Lower Value (Bytes) field, enter the lowest number of bytes to be used for this match condition. Valid entries are from 0 to 4294967295. The number in this field must be less than the number entered in the Content Length Higher Value (Bytes) field.</li> <li>2. In the Content Length Higher Value (Bytes) field, enter the highest number of bytes to be used for this match condition. Valid entries are from 0 to 4294967295. The number in this field must be greater than the number entered in the Content Length Lower Value (Bytes) field.</li> </ol> </li> </ul> </li> </ol> |

Table 14-7 Layer 7 HTTP Deep Packet Inspection Class Map Match Conditions (continued)

| Match Condition | Description                                                                                                                                                                                                                                                                                                                                                                                                                                                                                                                                                                                                                                                                                                                                                                                                                                                                                                                                                                                                                                                                                                                                                                                                                                                                                                                                                                                                                                                                                                                                                                                                                                                                                                                                                                                                                                                                                                                                                                                                                                                                                                                                                                                                                                                                                                                                                                                                                                                                |
|-----------------|----------------------------------------------------------------------------------------------------------------------------------------------------------------------------------------------------------------------------------------------------------------------------------------------------------------------------------------------------------------------------------------------------------------------------------------------------------------------------------------------------------------------------------------------------------------------------------------------------------------------------------------------------------------------------------------------------------------------------------------------------------------------------------------------------------------------------------------------------------------------------------------------------------------------------------------------------------------------------------------------------------------------------------------------------------------------------------------------------------------------------------------------------------------------------------------------------------------------------------------------------------------------------------------------------------------------------------------------------------------------------------------------------------------------------------------------------------------------------------------------------------------------------------------------------------------------------------------------------------------------------------------------------------------------------------------------------------------------------------------------------------------------------------------------------------------------------------------------------------------------------------------------------------------------------------------------------------------------------------------------------------------------------------------------------------------------------------------------------------------------------------------------------------------------------------------------------------------------------------------------------------------------------------------------------------------------------------------------------------------------------------------------------------------------------------------------------------------------------|
| Header          | <p>Name and value in an HTTP header that are to be used for protocol inspection decisions.</p> <p>Do the following:</p> <ol style="list-style-type: none"> <li>a. In the Header field, choose one of the predefined HTTP headers to be matched, or choose HTTP Header to specify a different HTTP header.</li> <li>b. If you chose HTTP Header, in the Header Name field, enter the name of the HTTP header to match. Valid entries are unquoted text strings with no spaces and a maximum of 64 alphanumeric characters.</li> <li>c. In the Header Value (Bytes) field, enter the header value expression string to compare against the value in the specified field in the HTTP header. Valid entries are text strings with a maximum of 255 alphanumeric characters. The ACE supports regular expressions for matching. If the string includes spaces, enclose the string with quotes. All headers in the header map must be matched. See <a href="#">Table 14-33</a> for a list of the supported characters that you can use in regular expressions.</li> </ol>                                                                                                                                                                                                                                                                                                                                                                                                                                                                                                                                                                                                                                                                                                                                                                                                                                                                                                                                                                                                                                                                                                                                                                                                                                                                                                                                                                                                        |
| Header Length   | <p>Length of the header in the HTTP message that is to be used for protocol inspection decisions.</p> <p>Do the following:</p> <ol style="list-style-type: none"> <li>a. In the Header Length Type field, specify whether HTTP header request or response messages are to be used for protocol inspection decisions as follows: <ul style="list-style-type: none"> <li>– <b>Request</b>—HTTP header request messages are to be checked for header length.</li> <li>– <b>Response</b>—HTTP header response messages are to be checked for header length.</li> </ul> </li> <li>b. In the Header Length Operator field, choose the operand to use to compare header length: <ul style="list-style-type: none"> <li>– <b>Equal To</b>—The header length must equal the number in the Header Length Value (Bytes) field.</li> <li>– <b>Greater Than</b>—The header length must be greater than the number in the Header Length Value (Bytes) field.</li> <li>– <b>Less Than</b>—The header length must be less than the number in the Header Length Value (Bytes) field.</li> <li>– <b>Range</b>—The header length must be within the range specified in the Header Length Lower Value (Bytes) field and the Header Length Higher Value (Bytes) field.</li> </ul> </li> <li>c. Enter values to apply for header length comparison as follows: <ul style="list-style-type: none"> <li>– If you chose Equal To, Greater Than, or Less Than in the Header Length Operator field, the Header Length Value (Bytes) field appears. In the Header Length Value (Bytes) field, enter the number of bytes for comparison. Valid entries are from 0 to 255.</li> <li>– If you chose Range in the Header Length Operator field, the Header Length Lower Value (Bytes) and the Header Length Higher Value (Bytes) fields appear. Do the following: <ol style="list-style-type: none"> <li>1. In the Header Length Lower Value (Bytes) field, enter the lowest number of bytes to be used for this match condition. Valid entries are from 0 to 255. The number in this field must be less than the number entered in the Header Length Higher Value (Bytes) field.</li> <li>2. In the Header Length Higher Value (Bytes) field, enter the highest number of bytes to be used for this match condition. Valid entries are from 1 to 255. The number in this field must be greater than the number entered in the Header Length Lower Value (Bytes) field.</li> </ol> </li> </ul> </li> </ol> |

Table 14-7 Layer 7 HTTP Deep Packet Inspection Class Map Match Conditions (continued)

| Match Condition   | Description                                                                                                                                                                                                                                                                                                                                                                                                                                                                                                                                                                                                                                                                                                                                                                                                                                                                                                                                                                                                                                           |
|-------------------|-------------------------------------------------------------------------------------------------------------------------------------------------------------------------------------------------------------------------------------------------------------------------------------------------------------------------------------------------------------------------------------------------------------------------------------------------------------------------------------------------------------------------------------------------------------------------------------------------------------------------------------------------------------------------------------------------------------------------------------------------------------------------------------------------------------------------------------------------------------------------------------------------------------------------------------------------------------------------------------------------------------------------------------------------------|
| Header MIME Type  | <p>Multipurpose Internet Mail Extension (MIME) message types that are to be used for protocol inspection decisions.</p> <p>In the Header MIME Type field, choose the MIME message type to use for this match condition.</p>                                                                                                                                                                                                                                                                                                                                                                                                                                                                                                                                                                                                                                                                                                                                                                                                                           |
| Port Misuse       | <p>Feature that specifies that the misuse of port 80 (or any other port running HTTP) is to be used for protocol inspection decisions.</p> <p>Choose the application category to use for this match condition:</p> <ul style="list-style-type: none"> <li>• <b>IM</b>—Instant messaging applications are to be used for this match condition.</li> <li>• <b>P2P</b>—Peer-to-peer applications are to be used for this match condition.</li> <li>• <b>Tunneling</b>—Tunneling applications are to be used for this match condition.</li> </ul>                                                                                                                                                                                                                                                                                                                                                                                                                                                                                                         |
| Request Method    | <p>Request method that is to be used for protocol inspection decisions.</p> <p>By default, ACEs allow all request and extension methods. This option allows you to configure class maps that define protocol inspection decisions based on compliance to request methods defined in RFC 2616 and by HTTP extension methods.</p> <p>Do the following:</p> <ol style="list-style-type: none"> <li>a. In the Request Method Type field, choose the type of compliance to be used for protocol inspection decision. Choices are as follows: <ul style="list-style-type: none"> <li>– <b>Ext</b>—HTTP extension method is to be used for protocol inspection decisions.</li> <li>– <b>RFC</b>—Request method defined in RFC 2616 is to be used for protocol inspection decisions.</li> </ul> <p>Depending on your selection, the Ext Request Method field or the RFC Request Method field appears.</p> </li> <li>b. In the Request Method field, choose the specific request method to be used.</li> </ol>                                                 |
| Transfer Encoding | <p>Field that appears when an HTTP transfer-encoding type is used for protocol inspection decisions. The transfer-encoding general-header field indicates the type of transformation, if any, that has been applied to the HTTP message body to safely transfer it between the sender and the recipient.</p> <p>In the Transfer Encoding field, choose the type of encoding that is to be checked:</p> <ul style="list-style-type: none"> <li>• <b>Chunked</b>—The message body is transferred as a series of chunks.</li> <li>• <b>Compress</b>—The encoding format that is produced by the UNIX file compression program compress.</li> <li>• <b>Deflate</b>—The .zlib format that is defined in RFC 1950 in combination with the DEFLATE compression mechanism described in RFC 1951.</li> <li>• <b>Gzip</b>—The encoding format that is produced by the file compression program GZIP (GNU zip) as described in RFC 1952.</li> <li>• <b>Identity</b>—The default (identity) encoding which does not require the use of transformation.</li> </ul> |
| URL               | <p>URL name used for protocol inspection decisions.</p> <p>In the URL field, enter a URL or a portion of a URL to match. Valid entries are URL strings from 1 to 255 alphanumeric characters and include only the portion of the URL following <code>www.hostname.domain</code>. For example, in the URL <code>www.anydomain.com/latest/whatsnew.html</code>, include only <code>/latest/whatsnew.html</code>.</p>                                                                                                                                                                                                                                                                                                                                                                                                                                                                                                                                                                                                                                    |

Table 14-7 Layer 7 HTTP Deep Packet Inspection Class Map Match Conditions (continued)

| Match Condition | Description                                                                                                                                                                                                                                                                                                                                                                                                                                                                                                                                                                                                                                                                                                                                                                                                                                                                                                                                                                                                                                                                                                                                                                                                                                                                                                                                                                                                                                                                                                                                                                                                                                                                                                                                                                                                                                                                                                                                                                         |
|-----------------|-------------------------------------------------------------------------------------------------------------------------------------------------------------------------------------------------------------------------------------------------------------------------------------------------------------------------------------------------------------------------------------------------------------------------------------------------------------------------------------------------------------------------------------------------------------------------------------------------------------------------------------------------------------------------------------------------------------------------------------------------------------------------------------------------------------------------------------------------------------------------------------------------------------------------------------------------------------------------------------------------------------------------------------------------------------------------------------------------------------------------------------------------------------------------------------------------------------------------------------------------------------------------------------------------------------------------------------------------------------------------------------------------------------------------------------------------------------------------------------------------------------------------------------------------------------------------------------------------------------------------------------------------------------------------------------------------------------------------------------------------------------------------------------------------------------------------------------------------------------------------------------------------------------------------------------------------------------------------------------|
| URL Length      | <p>URL length to be used for protocol inspection decisions.</p> <p>Do the following:</p> <ol style="list-style-type: none"> <li>a. In the URL Length Operator field, choose the operand to be used to compare URL length: <ul style="list-style-type: none"> <li>– <b>Equal To</b>—The URL length must equal the number in the URL Length Value (Bytes) field.</li> <li>– <b>Greater Than</b>—The URL length must be greater than the number in the URL Length Value (Bytes) field.</li> <li>– <b>Less Than</b>—The URL length must be less than the number in the URL Length Value (Bytes) field.</li> <li>– <b>Range</b>—The URL length must be within the range specified in the URL Length Lower Value (Bytes) field and the URL Length Higher Value (Bytes) field.</li> </ul> </li> <li>b. Enter values to apply for URL length comparison as follows: <ul style="list-style-type: none"> <li>– If you chose Equal To, Greater Than, or Less Than in the URL Length Operator field, the URL Length Value (Bytes) field appears. In the URL Length Value (Bytes) field, enter the value for comparison. Valid entries are from 1 to 65535 bytes.</li> <li>– If you chose Range in the URL Length Operator field, the URL Length Lower Value (Bytes) and the URL Length Higher Value (Bytes) fields appear. Do the following: <ol style="list-style-type: none"> <li>1. In the URL Length Lower Value (Bytes) field, enter the lowest number of bytes to be used for this match condition. Valid entries are integers from 1 to 65535. The number in this field must be less than the number entered in the URL Length Higher Value (Bytes) field.</li> <li>2. In the URL Length Higher Value (Bytes) field, enter the highest number of bytes to be used for this match condition. Valid entries are integers from 1 to 65535. The number in this field must be greater than the number entered in the URL Length Lower Value (Bytes) field.</li> </ol> </li> </ul> </li> </ol> |

**Step 6** Do one of the following:

- Click **Deploy Now** to deploy this configuration on the ACE and save your entries to the running-configuration and startup-configuration files.



**Note** If you click **Deploy Now**, the ACE drops the traffic, then restarts it, even if you have not made changes. If you have not altered existing match conditions, click **Cancel** instead of **Deploy Now** to ensure uninterrupted traffic.

- Click **Cancel** to exit this procedure without saving your entries and to return to the Match Condition table.
- Click **Next** to configure another match condition for this class map.

**Related Topics**

- [Configuring Virtual Context Policy Maps, page 14-32](#)
- [Setting Match Conditions for Layer 3/Layer 4 Network Traffic Class Maps, page 14-9](#)
- [Setting Match Conditions for Layer 3/Layer 4 Management Traffic Class Maps, page 14-12](#)

- [Setting Match Conditions for Layer 7 Server Load Balancing Class Maps, page 14-14](#)
- [Setting Match Conditions for Layer 7 FTP Command Inspection Class Maps, page 14-22](#)

## Setting Match Conditions for Layer 7 FTP Command Inspection Class Maps

You can set match conditions for a Layer 7 FTP command inspection class map.

### Assumption

You have configured a Layer 7 FTP command inspection class map and want to establish match criteria.

### Procedure

- 
- Step 1** Choose **Config > Devices > context > Expert > Class Maps**.  
The Class Maps table appears.
- Step 2** In the Class Maps table, choose the Layer 7 FTP command inspection class map that you want to set match conditions for.  
The Match Condition table appears.
- Step 3** In the Match Condition table, click **Add** to add match criteria, or choose the match condition that you want to modify and click **Edit**.  
The Match Condition configuration window appears.
- Step 4** In the Sequence Number field of the Match Condition configuration window, enter a value from 2 to 255.
- Step 5** In the Match Condition Type field, confirm that Request Method Name is selected as the match condition type for this class map.
- Step 6** In the Request Method Name field, choose the FTP command to be inspected.  
[Table 14-8](#) identifies the FTP commands that can be inspected.

**Table 14-8** FTP Commands for Inspection

| FTP Command | Description                                                              |
|-------------|--------------------------------------------------------------------------|
| Appe        | Append data to the end of the specified file on the remote host.         |
| Cdup        | Change to the parent of the current directory.                           |
| Dele        | Delete the specified file.                                               |
| Get         | Copy the specified file from the remote host to the local system.        |
| Help        | List all available FTP commands.                                         |
| Mkd         | Create a directory using the specified path and directory name.          |
| Put         | Copy the specified file from the local system to the remote host.        |
| Rmd         | Remove the specified directory.                                          |
| Rnfr        | Rename a file, specifying the current file name. Used with <b>rnto</b> . |
| Rnto        | Rename a file, specifying the new file name. Used with <b>rnfr</b> .     |
| Site        | Execute a site-specific command.                                         |
| Stou        | Store a file on the remote host and give it a unique name.               |
| Syst        | Query the remote host for operating system information.                  |

**Step 7** Do one of the following:

- Click **Deploy Now** to deploy this configuration on the ACE and save your entries to the running-configuration and startup-configuration files. You return to the Match Condition table.



**Note** If you click **Deploy Now**, the ACE drops the traffic and then restarts it, even if you have not made changes. If you have not altered existing match conditions, click **Cancel** instead of **Deploy Now** to ensure uninterrupted traffic.

- Click **Cancel** to exit this procedure without saving your entries and to return to the Match Condition table.
- Click **Next** to configure another match condition for this class map.

#### Related Topics

- [Configuring Virtual Context Class Maps, page 14-6](#)
- [Configuring Virtual Context Policy Maps, page 14-32](#)

## Setting Match Conditions for Generic Server Load Balancing Class Maps

You can set match conditions for a generic server load balancing class map.



**Note** Fields and information related to IPv6 require ACE module and ACE appliance software Version A5(1.0) or later.

#### Assumption

You have configured a generic server load balancing class map and want to establish match criteria.

#### Procedure

- 
- Step 1** Choose **Config > Devices > context > Expert > Class Maps**.  
The Class Maps table appears.
- Step 2** In the Class Maps table, choose the generic server load balancing class map that you want to set match conditions for.  
The Match Condition table appears.
- Step 3** In the Match Condition table, click **Add** to add match criteria, or choose the match condition that you want to modify and click **Edit**.  
The Match Condition configuration window appears.
- Step 4** In the Sequence Number field of the Match Condition configuration window, enter a value from 2 to 255.
- Step 5** In the Match Condition Type field, choose the match condition type for this class map and configure any match-specific criteria as described in [Table 14-9](#).

**Table 14-9 Generic Server Load Balancing Class Map Match Conditions**

| Match Condition | Description                                                                                                                                                                                                                                                                                                                                                                                                                                                                                                                                                                                                                                                                                                                                                                                                                             |
|-----------------|-----------------------------------------------------------------------------------------------------------------------------------------------------------------------------------------------------------------------------------------------------------------------------------------------------------------------------------------------------------------------------------------------------------------------------------------------------------------------------------------------------------------------------------------------------------------------------------------------------------------------------------------------------------------------------------------------------------------------------------------------------------------------------------------------------------------------------------------|
| Class Map       | Class map that is used to establish a match condition. In the Class Map field, choose the class map to use for this match condition.                                                                                                                                                                                                                                                                                                                                                                                                                                                                                                                                                                                                                                                                                                    |
| Layer 4 Payload | <p>Generic data parsing that is used to establish a match condition.</p> <p>Do the following:</p> <ol style="list-style-type: none"> <li>In the Layer 4 Payload Regex field, enter the Layer 4 payload expression contained within the TCP or UDP entity body to use for this match condition. Valid entries are text strings with a maximum of 255 alphanumeric characters. See <a href="#">Table 14-33</a> for a list of the supported characters that you can use for matching string expressions.</li> <li>In the Layer 4 Payload Offset field, enter the absolute offset where the Layer 4 payload expression search starts. The offset starts at the first byte of the TCP or UDP body. Valid entries are from 0 to 999.</li> </ol>                                                                                               |
| Source Address  | <p>Source IP address that is used to establish a match condition.</p> <p>Do the following:</p> <ol style="list-style-type: none"> <li>In the IP Address Type field, choose either <b>IPv4</b> or <b>IPv6</b>. This field appears only for ACE module and ACE appliance software Version A5(1.0) or later, which supports IPv4 and IPv6.</li> <li>In the Source Address field, enter the source IP address for this match condition in the format based on the address type (IPv4 or IPv6).</li> <li>Depending on the IP address type that you chose, do one of the following: <ul style="list-style-type: none"> <li>– For IPv4, in the Source Netmask field, choose the subnet mask for the source IP address.</li> <li>– For IPv6, in the Source Prefix-length field, enter the prefix length for the address.</li> </ul> </li> </ol> |

**Step 6** Do one of the following:

- Click **Deploy Now** to deploy this configuration on the ACE and save your entries to the running-configuration and startup-configuration files. You return to the Match Condition table.



**Note** If you click **Deploy Now**, the ACE drops the traffic and then restarts it even if you have not made changes. If you have not altered existing match conditions, click **Cancel** instead of **Deploy Now** to ensure uninterrupted traffic.

- Click **Cancel** to exit this procedure without saving your entries and to return to the Match Condition table.
- Click **Next** to configure another match condition for this class map.

**Related Topics**

- [Configuring Virtual Context Class Maps, page 14-6](#)
- [Configuring Virtual Context Policy Maps, page 14-32](#)



## Setting Match Conditions for RADIUS Server Load Balancing Class Maps

You can set match conditions for a RADIUS server load balancing class map.

### Assumption

You have configured a RADIUS server load balancing class map and want to establish match criteria.

### Procedure

- 
- Step 1** Choose **Config > Devices > context > Expert > Class Maps**.  
The Class Maps table appears.
- Step 2** In the Class Maps table, choose the RADIUS server load balancing class map that you want to set match conditions for.  
The Match Condition table appears.
- Step 3** In the Match Condition table, click **Add** to add match criteria, or choose the match condition that you want to modify and click **Edit**.  
The Match Condition configuration window appears.
- Step 4** In the Sequence Number field, enter a value from 2 to 255.
- Step 5** In the Match Condition Type field, choose the match condition type for this class map and configure any match-specific criteria as described in [Table 14-10](#).

**Table 14-10 RADIUS Server Load Balancing Class Map Match Conditions**

| Match Condition    | Description                                                                                                                                                                                                                                                                                                                                                                 |
|--------------------|-----------------------------------------------------------------------------------------------------------------------------------------------------------------------------------------------------------------------------------------------------------------------------------------------------------------------------------------------------------------------------|
| Calling Station ID | Unique identifier of the calling station that is used to establish a match condition. In the RADIUS Calling Station ID field, enter the calling station identifier to match. Valid entries are strings containing 1 to 64 alphanumeric characters. See <a href="#">Table 14-33</a> for a list of the supported characters that you can use for matching string expressions. |
| User Name          | Username that is used to establish a match condition. In the User Name field, enter the name to match. Valid entries are strings containing 1 to 64 alphanumeric characters. See <a href="#">Table 14-33</a> for a list of the supported characters that you can use for matching string expressions.                                                                       |

- Step 6** Do one of the following:
- Click **Deploy Now** to deploy this configuration on the ACE and save your entries to the running-configuration and startup-configuration files. You return to the Match Condition table.
-  **Note** If you click **Deploy Now**, the ACE drops the traffic and then restarts it, even if you have not made changes. If you have not altered existing match conditions, click **Cancel** instead of **Deploy Now** to ensure uninterrupted traffic.
- Click **Cancel** to exit this procedure without saving your entries and to return to the Match Condition table.
  - Click **Next** to configure another match condition for this class map.
-

**Related Topics**

- [Configuring Virtual Context Class Maps, page 14-6](#)
- [Configuring Virtual Context Policy Maps, page 14-32](#)

## Setting Match Conditions for RTSP Server Load Balancing Class Maps

You can set match conditions for a RTSP server load balancing class map.

**Assumption**

You have configured a RTSP server load balancing class map and want to establish match criteria.

**Procedure**

- 
- Step 1** Choose **Config > Devices > context > Expert > Class Maps**.
- The Class Maps table appears.
- Step 2** In the Class Maps table, choose the RTSP server load balancing class map that you want to set match conditions for.
- The Match Condition table appears.
- Step 3** In the Match Condition table, click **Add** to add match criteria, or choose the match condition that you want to modify and click **Edit**.
- The Match Condition configuration window appears.
- Step 4** In the Sequence Number field, enter a value from 2 to 255.
- Step 5** In the Match Condition Type field, choose the match condition type for this class map and configure any match-specific criteria as described in [Table 14-11](#).

**Table 14-11 RTSP Server Load Balancing Class Map Match Conditions**

| Match Condition | Description                                                                                                                                                                                                                                                                                                                                                                                                                                                                                                                                                                                                                                                                                                                                                                                                                                                                                                                                                                                                                                                                                                                                                                                                                               |
|-----------------|-------------------------------------------------------------------------------------------------------------------------------------------------------------------------------------------------------------------------------------------------------------------------------------------------------------------------------------------------------------------------------------------------------------------------------------------------------------------------------------------------------------------------------------------------------------------------------------------------------------------------------------------------------------------------------------------------------------------------------------------------------------------------------------------------------------------------------------------------------------------------------------------------------------------------------------------------------------------------------------------------------------------------------------------------------------------------------------------------------------------------------------------------------------------------------------------------------------------------------------------|
| Class Map       | Class map that is used to establish a match condition. In the Class Map field, choose the class map to use for this match condition.                                                                                                                                                                                                                                                                                                                                                                                                                                                                                                                                                                                                                                                                                                                                                                                                                                                                                                                                                                                                                                                                                                      |
| RTSP Header     | <p>Name and value in an RTSP header that is used to establish a match condition.</p> <p>Do the following</p> <ol style="list-style-type: none"> <li>a. In the Header Name field, specify the header in one of the following ways:           <ul style="list-style-type: none"> <li>– To specify an RTSP header that is not one of the standard RSTP headers, choose the first radio button and enter the RTSP header name in the Header Name field. Valid entries are unquoted text strings with no spaces and a maximum of 64 characters.</li> <li>– To specify one of the standard RTSP headers, choose the second radio button and choose one of the RTSP headers from the list.</li> </ul> </li> <li>b. In the Header Value (Bytes) field, enter the header value expression string to compare against the value in the specified field in the RTSP header. Valid entries are text strings with a maximum of 255 alphanumeric characters. The ACE supports regular expressions for matching. If the string includes spaces, enclose the string with quotes. All headers in the header map must be matched. See <a href="#">Table 14-33</a> for a list of the supported characters that you can use in regular expressions.</li> </ol> |

Table 14-11 RTSP Server Load Balancing Class Map Match Conditions (continued)

| Match Condition | Description                                                                                                                                                                                                                                                                                                                                                                                                                                                                                                                                                                                                                                                                                                                                                                                                                                                                                                                                                        |
|-----------------|--------------------------------------------------------------------------------------------------------------------------------------------------------------------------------------------------------------------------------------------------------------------------------------------------------------------------------------------------------------------------------------------------------------------------------------------------------------------------------------------------------------------------------------------------------------------------------------------------------------------------------------------------------------------------------------------------------------------------------------------------------------------------------------------------------------------------------------------------------------------------------------------------------------------------------------------------------------------|
| RTSP URL        | <p>URL or portion of a URL that is used to establish a match condition.</p> <p>Do the following:</p> <ol style="list-style-type: none"> <li>In the URL Expr field, enter a URL, or portion of a URL, to match. The ACE performs matching on whatever URL string appears after the RTSP method, regardless of whether the URL includes the host name. The ACE supports regular expressions for matching URL strings. See <a href="#">Table 14-33</a> for a list of the supported characters that you can use in regular expressions.</li> <li>In the Method field, enter the RTSP method to match. Valid entries are unquoted text strings with no spaces and a maximum of 64 alphanumeric characters. The method can be either one of the standard RTSP method names (DESCRIBE, ANNOUNCE, GET_PARAMETER, OPTIONS, PAUSE, PLAY, RECORD, REDIRECT, SETUP, SET_PARAMETER, TEARDOWN) or a text string that must be matched exactly (for example, STINGRAY).</li> </ol> |
| Source Address  | <p>Source IP address that is used to establish a match condition.</p> <p>Do the following:</p> <ol style="list-style-type: none"> <li>In the Source Address field, enter the source IP address for this match condition in dotted-decimal format, such as 192.168.11.1.</li> <li>In the Source Netmask field, choose the subnet mask for the source IP address.</li> </ol>                                                                                                                                                                                                                                                                                                                                                                                                                                                                                                                                                                                         |

**Step 6** Do one of the following:

- Click **Deploy Now** to deploy this configuration on the ACE and save your entries to the running-configuration and startup-configuration files. You return to the Match Condition table.



**Note** If you click **Deploy Now**, the ACE drops the traffic and then restarts it, even if you have not made changes. If you have not altered existing match conditions, click **Cancel** instead of **Deploy Now** to ensure uninterrupted traffic.

- Click **Cancel** to exit this procedure without saving your entries and to return to the Match Condition table.
- Click **Next** to configure another match condition for this class map.

#### Related Topics

- [Configuring Virtual Context Class Maps, page 14-6](#)
- [Configuring Virtual Context Policy Maps, page 14-32](#)

## Setting Match Conditions for SIP Server Load Balancing Class Maps

You can set match conditions for a SIP server load balancing class map.

#### Assumption

You have configured a SIP server load balancing class map and want to establish match criteria.

**Procedure**

- 
- Step 1** Choose **Config > Devices > context > Expert > Class Maps**.  
The Class Maps table appears.
- Step 2** In the Class Maps table, choose the SIP server load balancing class map that you want to set match conditions for.  
The Match Condition table appears.
- Step 3** In the Match Condition table, click **Add** to add match criteria, or choose the match condition that you want to modify and click **Edit**.  
The Match Condition configuration window appears.
- Step 4** In the Sequence Number field of the Match Condition configuration window, enter a value from 2 to 255.
- Step 5** In the Match Condition Type field, choose the match condition type for this class map and configure any match-specific criteria as described in [Table 14-12](#).



---

**Note** Fields and information related to IPv6 require ACE module and ACE appliance software Version A5(1.0) or later.

---

**Table 14-12 SIP Server Load Balancing Class Map Match Conditions**

| Match Condition | Description                                                                                                                          |
|-----------------|--------------------------------------------------------------------------------------------------------------------------------------|
| Class Map       | Class map that is used to establish a match condition. In the Class Map field, choose the class map to use for this match condition. |

Table 14-12 SIP Server Load Balancing Class Map Match Conditions (continued)

| Match Condition | Description                                                                                                                                                                                                                                                                                                                                                                                                                                                                                                                                                                                                                                                                                                                                                                                                                                                                                                                                                                                                                                                                                                                                                                                               |
|-----------------|-----------------------------------------------------------------------------------------------------------------------------------------------------------------------------------------------------------------------------------------------------------------------------------------------------------------------------------------------------------------------------------------------------------------------------------------------------------------------------------------------------------------------------------------------------------------------------------------------------------------------------------------------------------------------------------------------------------------------------------------------------------------------------------------------------------------------------------------------------------------------------------------------------------------------------------------------------------------------------------------------------------------------------------------------------------------------------------------------------------------------------------------------------------------------------------------------------------|
| SIP Header      | <p>SIP header name and value that are used to establish a match condition.</p> <p>Do the following:</p> <ol style="list-style-type: none"> <li>a. In the Header Name field, specify the header in one of the following ways: <ul style="list-style-type: none"> <li>– To specify a SIP header that is not one of the standard SIP headers, choose the first radio button and enter the SIP header name in the Header Name field. Enter an unquoted text string with no spaces and a maximum of 64 characters.</li> <li>– To specify one of the standard SIP headers, choose the second radio button and choose one of the SIP headers from the list.</li> </ul> </li> <li>b. In the Header Value (Bytes) field, enter the header value expression string to compare against the value in the specified field in the SIP header. Valid entries are text strings with a maximum of 255 alphanumeric characters. The ACE supports regular expressions for matching. If the string includes spaces, enclose the string with quotes. All headers in the header map must be matched. See <a href="#">Table 14-33</a> for a list of the supported characters that you can use in regular expressions.</li> </ol> |
| Source Address  | <p>Source IP address that is used to establish a match condition.</p> <p>Do the following:</p> <ol style="list-style-type: none"> <li>a. In the IP Address Type field, select either <b>IPv4</b> or <b>IPv6</b>. This field appears only for ACE module and ACE appliance software Version A5(1.0) or later, which supports IPv4 and IPv6.</li> <li>b. In the Source Address field, enter the source IP address for this match condition in the format based on the address type (IPv4 or IPv6).</li> <li>c. Depending on the IP address type that you chose, do one of the following: <ul style="list-style-type: none"> <li>– For IPv4, in the Source Netmask field, choose the subnet mask for the source IP address.</li> <li>– For IPv6, in the Source Prefix-length field, enter the prefix length for the address.</li> </ul> </li> </ol>                                                                                                                                                                                                                                                                                                                                                          |

**Step 6** Do one of the following:

- Click **Deploy Now** to deploy this configuration on the ACE and save your entries to the running-configuration and startup-configuration files. You return to the Match Condition table.



**Note** If you click **Deploy Now**, the ACE drops the traffic and then restarts it, even if you have not made changes. If you have not altered existing match conditions, click **Cancel** instead of **Deploy Now** to ensure uninterrupted traffic.

- Click **Cancel** to exit this procedure without saving your entries and to return to the Match Condition table.
- Click **Next** to configure another match condition for this class map.

**Related Topics**

- [Configuring Virtual Context Class Maps, page 14-6](#)
- [Configuring Virtual Context Policy Maps, page 14-32](#)

## Setting Match Conditions for Layer 7 SIP Deep Packet Inspection Class Maps

You can set match conditions for a SIP deep packet inspection class map.

### Assumption

You have configured a SIP deep packet inspection class map and want to establish match criteria.

### Procedure

- 
- Step 1** Choose **Config > Devices > context > Expert > Class Maps**.  
The Class Maps table appears.
- Step 2** In the Class Maps table, choose the SIP deep packet inspection class map that you want to set match conditions for.  
The Match Condition table appears.
- Step 3** In the Match Condition table, click **Add** to add match criteria, or choose the match condition that you want to modify and click **Edit**.  
The Match Condition configuration window appears.
- Step 4** In the Sequence Number field of the Match Condition configuration window, enter a value from 2 to 255.
- Step 5** In the Match Condition Type field, choose the match condition type for this class map and configure any match-specific criteria as described in [Table 14-13](#).

**Table 14-13** Layer 7 SIP Deep Packet Inspection Class Map Match Conditions

| Match Condition | Description                                                                                                                                                                                                                                                                                                                                                                                                                                                                                                                                       |
|-----------------|---------------------------------------------------------------------------------------------------------------------------------------------------------------------------------------------------------------------------------------------------------------------------------------------------------------------------------------------------------------------------------------------------------------------------------------------------------------------------------------------------------------------------------------------------|
| Called Party    | Destination or called party in the URI of the SIP To header that is used to establish a match condition. In the Called Party field, enter a regular expression that identifies the called party in the URI of the SIP To header for this match condition. Valid entries are unquoted text strings with no spaces and a maximum of 255 alphanumeric characters. The ACE supports regular expressions for matching string expressions. <a href="#">Table 14-33</a> lists the supported characters that you can use for matching string expressions. |
| Calling Party   | Source or calling party in the URI of the SIP From header that is used to establish a match condition. In the Calling Party field, enter a regular expression that identifies the called party in the URI of the SIP To header for this match condition. Valid entries are unquoted text strings with no spaces and a maximum of 255 alphanumeric characters. The ACE supports regular expressions for matching string expressions. <a href="#">Table 14-33</a> lists the supported characters that you can use for matching string expressions.  |
| IM Subscriber   | IM (instant messaging) subscriber that is used to establish a match condition. In the IM Subscriber field, enter a regular expression that identifies the IM subscriber for this match condition. Valid entries are unquoted text strings with no spaces and a maximum of 255 alphanumeric characters. The ACE supports regular expressions for matching string expressions. <a href="#">Table 14-33</a> lists the supported characters that you can use for matching string expressions.                                                         |
| Message Path    | Message coming from or transiting through certain SIP proxy servers that is used to establish a match condition. In the Message Path field, enter a regular expression that identifies the SIP proxy server for this match condition. Valid entries are unquoted text strings with no spaces and a maximum of 255 alphanumeric characters. The ACE supports regular expressions for matching string expressions. <a href="#">Table 14-33</a> lists the supported characters that you can use for matching string expressions.                     |

Table 14-13 Layer 7 SIP Deep Packet Inspection Class Map Match Conditions (continued)

| Match Condition    | Description                                                                                                                                                                                                                                                                                                                                                                                                                                                                                                                                                                                                                            |
|--------------------|----------------------------------------------------------------------------------------------------------------------------------------------------------------------------------------------------------------------------------------------------------------------------------------------------------------------------------------------------------------------------------------------------------------------------------------------------------------------------------------------------------------------------------------------------------------------------------------------------------------------------------------|
| SIP Content Length | <p>SIP message body length that is used to establish a match condition.</p> <p>Do the following:</p> <ol style="list-style-type: none"> <li>In the Content Operator field, confirm that Greater Than is selected.</li> <li>In the Content Length field, enter the maximum size of a SIP message body in bytes that the ACE is to allow without performing SIP protocol inspection. If a SIP message exceeds the specified value, the ACE performs SIP protocol inspection as defined in an associated policy map. Valid entries are from 0 to 65534 bytes.</li> </ol>                                                                  |
| SIP Content Type   | <p>Content type in the SIP message body that is used to establish a match condition. In the Content Type field, enter the a regular expression that identifies the content type in the SIP message body to use for this match condition. Valid entries are unquoted text strings with no spaces and a maximum of 255 alphanumeric characters. The ACE supports regular expressions for matching string expressions. Table 14-33 lists the supported characters that you can use for matching string expressions.</p>                                                                                                                   |
| SIP Request Method | <p>SIP request method that is used to establish a match condition. In the Request Method field, choose the request method that is to be matched.</p>                                                                                                                                                                                                                                                                                                                                                                                                                                                                                   |
| Third Party        | <p>Third party who is authorized to register other users on their behalf that is used to establish a match condition. In the Third Party Registration Entities field, enter a regular expression that identifies a privileged user authorized for third-party registrations for this match condition. Valid entries are unquoted text strings with no spaces and a maximum of 255 alphanumeric characters. The ACE supports regular expressions for matching string expressions. Table 14-33 lists the supported characters that you can use for matching string expressions.</p>                                                      |
| URI Length         | <p>SIP URI or user identifier that is used to establish a match condition.</p> <p>Do the following:</p> <ol style="list-style-type: none"> <li>In the URI Type field, choose the type of URI to use: <ul style="list-style-type: none"> <li>– SIP URI—The calling party URI is used for this match condition.</li> <li>– Tel URI—A telephone number is used for this match condition.</li> </ul> </li> <li>In the URI Operator field, confirm that Greater Than is selected.</li> <li>In the URI Length field, enter the maximum length of the SIP URI or Tel URI in bytes. Valid entries are integers from 0 to 254 bytes.</li> </ol> |

**Step 6** Do one of the following:

- Click **Deploy Now** to deploy this configuration on the ACE and save your entries to the running-configuration and startup-configuration files. You return to the Match Condition table.



**Note** If you click **Deploy Now**, the ACE drops the traffic and then restarts it, even if you have not made changes. If you have not altered existing match conditions, click **Cancel** instead of **Deploy Now** to ensure uninterrupted traffic.

- Click **Cancel** to exit this procedure without saving your entries and to return to the Match Condition table.

- Click **Next** to configure another match condition for this class map.

#### Related Topics

- [Configuring Virtual Context Class Maps, page 14-6](#)
- [Configuring Virtual Context Policy Maps, page 14-32](#)

## Configuring Virtual Context Policy Maps

You can create policy maps for a context that establish traffic policy for the ACE. The purpose of a traffic policy is to implement specific ACE functions associated with a traffic class.

A traffic policy contains the following:

- A policy map name.
- A previously created traffic class map or, optionally, the class-default class map.
- One or more of the individual Layer 3/Layer 4 or Layer 7 policies that specify the actions to be performed by the ACE.

The ACE executes actions specified in a policy map on a first-match, multi-match, or all-match basis as follows:

- **First-match**—With a first-match policy map, the ACE executes only the action specified against the first classification that it matches. Layer 3/Layer 4 Management Traffic, Layer 7 Server Load Balancing, Layer 7 Command Inspection - FTP, and Layer 7 HTTP Optimization policy maps are first-match policy maps.
- **Multi-match**—With a multi-match policy map, the ACE executes all possible actions applicable for a specific classification. Layer 3/Layer 4 Network Traffic policy maps are multi-match policy maps.
- **All-match**—With an all-match policy map, the ACE attempts to match all specified conditions against the matching classification and executes the actions of all matching classes until it encounters a deny for a match request.

You can display a context's policy maps and their types in the Policy Maps table (Config > Virtual Contexts > *context* > Expert > Policy Maps.)

The types of policy maps that you can configure depend on the ACE device type. [Table 14-14](#) lists the types of policy maps with brief descriptions and the ACE devices that support them.

**Table 14-14 Policy Maps and ACE Device Support**

| Policy Map Type                                | Description                                                                       | ACE Device |               |
|------------------------------------------------|-----------------------------------------------------------------------------------|------------|---------------|
|                                                |                                                                                   | ACE Module | ACE Appliance |
| Layer 3/4 Management Traffic (First-Match)     | Layer 3 and Layer 4 policy map for network management traffic received by the ACE | X          | X             |
| Layer 3/4 Network Traffic (First-Match)        | Layer 3 and Layer 4 policy map for traffic passing through the ACE                | X          | X             |
| Layer 7 Command Inspection - FTP (First-Match) | Layer 7 policy map for inspection of FTP commands                                 | X          | X             |



Table 14-14 Policy Maps and ACE Device Support (continued)

| Policy Map Type                                   | Description                                                                | ACE Device |               |
|---------------------------------------------------|----------------------------------------------------------------------------|------------|---------------|
|                                                   |                                                                            | ACE Module | ACE Appliance |
| Layer 7 Deep Packet Inspection - HTTP (All-Match) | Layer 7 policy map for inspection of HTTP packets                          | X          | X             |
| Layer 7 Deep Packet Inspection - SIP (All-Match)  | Layer 7 policy map for inspection of SIP packets                           | X          | X             |
| Layer 7 Deep Packet Inspection - Skinny           | Layer 7 policy map for inspection of Skinny Client Control Protocol (SCCP) | X          | X             |
| Layer 7 HTTP Optimization (First-Match)           | Layer 7 policy map for optimizing HTTP traffic                             |            | X             |
| Layer 7 Server Load Balancing (First-Match)       | Layer 7 policy map for HTTP server load balancing                          | X          | X             |
| Server Load Balancing - Generic                   | Generic Layer 7 policy map for server load balancing                       | X          | X             |
| Server Load Balancing - RADIUS (First-Match)      | Layer 7 policy map for RADIUS server load balancing                        | X          | X             |
| Server Load Balancing - RDP (First-Match)         | Layer 7 policy map for RDP server load balancing                           | X          | X             |
| Server Load Balancing - RTSP (First-Match)        | Layer 7 policy map for RTSP server load balancing                          | X          | X             |
| Server Load Balancing - SIP (First-Match)         | Layer 7 policy map for SIP server load balancing                           | X          | X             |

### Procedure

- 
- Step 1** Choose **Config > Devices > context > Expert > Policy Maps**.  
The Policy Maps table appears.
- Step 2** In the Policy Maps table, click **Add** to add a new policy map, or choose an existing policy map and click **Edit** to modify it.
- Step 3** The Policy Map Name field contains an automatically incremented number for the policy map. Either leave the entry as it is or enter a different, unique number.
- Step 4** In the Type field, choose the type of policy map to create. See [Table 14-14](#) for a list of the policy maps and their availability for the different ACE models.
- Step 5** In the Description field, enter a brief description of the policy map.
- Step 6** Do one of the following:
- Click **Deploy Now** to deploy this configuration on the ACE and save your entries to the running-configuration and startup-configuration files. To define rules and actions for the policy map, see [Configuring Rules and Actions for Policy Maps, page 14-34](#).
  - Click **Cancel** to exit this procedure without saving your entries and to return to the Policy Maps table.
  - Click **Next** to deploy your entries and to configure another policy map.
-

**Related Topics**

- [Information About Virtual Contexts, page 6-2](#)
- [Configuring Virtual Context Class Maps, page 14-6](#)
- [Configuring Rules and Actions for Policy Maps, page 14-34](#)

## Configuring Rules and Actions for Policy Maps

Table 14-15 lists the policy maps and related topics for setting rules and actions.

**Table 14-15** Topic Reference for Policy Map Rules and Actions

| Policy Map Type                                   | Topic for Setting Rules and Actions                                                                        |
|---------------------------------------------------|------------------------------------------------------------------------------------------------------------|
| Layer 3/4 Management Traffic (First-Match)        | <a href="#">Setting Policy Map Rules and Actions for Layer 3/Layer 4 Management Traffic, page 14-39</a>    |
| Layer 3/4 Network Traffic (First-Match)           | <a href="#">Setting Policy Map Rules and Actions for Layer 3/Layer 4 Network Traffic, page 14-41</a>       |
| Layer 7 Command Inspection - FTP (First-Match)    | <a href="#">Setting Policy Map Rules and Actions for Layer 7 FTP Command Inspection, page 14-48</a>        |
| Layer 7 Deep Packet Inspection - HTTP (All-Match) | <a href="#">Setting Policy Map Rules and Actions for Layer 7 HTTP Deep Packet Inspection, page 14-51</a>   |
| Layer 7 Deep Packet Inspection - SIP (All-Match)  | <a href="#">Setting Policy Map Rules and Actions for Layer 7 SIP Deep Packet Inspection, page 14-68</a>    |
| Layer 7 Deep Packet Inspection - Skinny           | <a href="#">Setting Policy Map Rules and Actions for Layer 7 Skinny Deep Packet Inspection, page 14-71</a> |
| Layer 7 HTTP Optimization (First-Match)           | <a href="#">Setting Policy Map Rules and Actions for Layer 7 HTTP Optimization, page 14-57</a>             |
| Layer 7 Server Load Balancing (First-Match)       | <a href="#">Setting Policy Map Rules and Actions for Layer 7 Server Load-Balancing Traffic, page 14-61</a> |
| Server Load Balancing - Generic (First-Match)     | <a href="#">Setting Policy Map Rules and Actions for Generic Server Load Balancing, page 14-35</a>         |
| Server Load Balancing - RADIUS (First-Match)      | <a href="#">Setting Policy Map Rules and Actions for RADIUS Server Load Balancing, page 14-73</a>          |
| Server Load Balancing - RDP (First-Match)         | <a href="#">Setting Policy Map Rules and Actions for RDP Server Load Balancing, page 14-75</a>             |
| Server Load Balancing - RTSP (First-Match)        | <a href="#">Setting Policy Map Rules and Actions for RTSP Server Load Balancing, page 14-76</a>            |
| Server Load Balancing - SIP (First-Match)         | <a href="#">Setting Policy Map Rules and Actions for SIP Server Load Balancing, page 14-79</a>             |

## Setting Policy Map Rules and Actions for Generic Server Load Balancing

You can configure the rules and actions for generic traffic received by the ACE.

### Assumptions

This topic assumes the following:

- A generic traffic policy map has been configured.
- A class map has been defined for a class map rule if you do not want to use the class-default class map.

### Procedure

- 
- Step 1** Choose **Config > Devices > context > Expert > Policy Maps**.  
The Policy Maps table appears.
- Step 2** In the Policy Maps table, choose the generic traffic policy map that you want to set rules and actions for.  
The Rule table appears.
- Step 3** In the Rule table, click **Add** to add a new rule, or choose the rule that you want to modify and click **Edit**.  
The Rule window appears.
- Step 4** In the Type field of the Rule window, configure rules using the information in [Table 14-16](#).



**Note** Fields and information related to IPv6 require ACE module and ACE appliance software Version A5(1.0) or later.

---

**Table 14-16** Generic Server Load Balancing Policy Map Rules

| Option    | Description                                                                                                                                                                                                                                                                                                                                                                                                                                                                                                                                                                                                                                                                                                                                                                                                                                                                                                                                                       |
|-----------|-------------------------------------------------------------------------------------------------------------------------------------------------------------------------------------------------------------------------------------------------------------------------------------------------------------------------------------------------------------------------------------------------------------------------------------------------------------------------------------------------------------------------------------------------------------------------------------------------------------------------------------------------------------------------------------------------------------------------------------------------------------------------------------------------------------------------------------------------------------------------------------------------------------------------------------------------------------------|
| Class Map | <p>Class map to use for this traffic policy.</p> <p>From the Use Class Map field, do one of the following:</p> <ul style="list-style-type: none"> <li>• To use the default class map, choose <b>class-default</b>.<br/>The class-default class map is a reserved, well-known class map created by the ACE. You cannot delete or modify this class. All traffic that fails to meet the other matching criteria in the named class map belongs to the default traffic class. If none of the specified classifications matches the traffic, then the ACE performs the action specified by the class-default class map. The class-default class map has an implicit <b>match any</b> statement that enables it to match all traffic.</li> <li>• To use a previously created class map, do the following: <ol style="list-style-type: none"> <li>1. Choose <b>others</b>.</li> <li>2. In the Class Map Name field, choose the class map to use.</li> </ol> </li> </ul> |

Table 14-16 Generic Server Load Balancing Policy Map Rules (continued)

| Option               | Description                                                                                                                                                                                                                                                                                                                                                                                                                                                                                                                                                                                                                                                                                                                                                                                                                                                                                                                                                                                                                                                                                                                                                                                                                                                                                                                                                                                                                                                                                                                                                                                                                                                                                                                                                                                                                                                                                                                                                                                                           |                      |                                                                                                                                                                                                                                                                                                                                                                                                                                                                                                                                                                                                                                                                                                                                   |                      |                                                                                                                                                                                                                                                                                                                                                                                                                                                                                                                                                                                                                                                                                                                                                                                                                                                                                                                                                                                                                                                                                                                                                                                                                                                                                                                                                                                                                                                                                                                                                                                                                                                                                                                                          |                 |                                                                                                                                                                                                                                                                                                                                                                                                                                                                                                                                                                                                                                                                                                                                   |                |                                                                                                                                                                                                                                                                                                                                                                                                                                                                                                                                                                                                                                                                                                                                                                                                                                                                               |
|----------------------|-----------------------------------------------------------------------------------------------------------------------------------------------------------------------------------------------------------------------------------------------------------------------------------------------------------------------------------------------------------------------------------------------------------------------------------------------------------------------------------------------------------------------------------------------------------------------------------------------------------------------------------------------------------------------------------------------------------------------------------------------------------------------------------------------------------------------------------------------------------------------------------------------------------------------------------------------------------------------------------------------------------------------------------------------------------------------------------------------------------------------------------------------------------------------------------------------------------------------------------------------------------------------------------------------------------------------------------------------------------------------------------------------------------------------------------------------------------------------------------------------------------------------------------------------------------------------------------------------------------------------------------------------------------------------------------------------------------------------------------------------------------------------------------------------------------------------------------------------------------------------------------------------------------------------------------------------------------------------------------------------------------------------|----------------------|-----------------------------------------------------------------------------------------------------------------------------------------------------------------------------------------------------------------------------------------------------------------------------------------------------------------------------------------------------------------------------------------------------------------------------------------------------------------------------------------------------------------------------------------------------------------------------------------------------------------------------------------------------------------------------------------------------------------------------------|----------------------|------------------------------------------------------------------------------------------------------------------------------------------------------------------------------------------------------------------------------------------------------------------------------------------------------------------------------------------------------------------------------------------------------------------------------------------------------------------------------------------------------------------------------------------------------------------------------------------------------------------------------------------------------------------------------------------------------------------------------------------------------------------------------------------------------------------------------------------------------------------------------------------------------------------------------------------------------------------------------------------------------------------------------------------------------------------------------------------------------------------------------------------------------------------------------------------------------------------------------------------------------------------------------------------------------------------------------------------------------------------------------------------------------------------------------------------------------------------------------------------------------------------------------------------------------------------------------------------------------------------------------------------------------------------------------------------------------------------------------------------|-----------------|-----------------------------------------------------------------------------------------------------------------------------------------------------------------------------------------------------------------------------------------------------------------------------------------------------------------------------------------------------------------------------------------------------------------------------------------------------------------------------------------------------------------------------------------------------------------------------------------------------------------------------------------------------------------------------------------------------------------------------------|----------------|-------------------------------------------------------------------------------------------------------------------------------------------------------------------------------------------------------------------------------------------------------------------------------------------------------------------------------------------------------------------------------------------------------------------------------------------------------------------------------------------------------------------------------------------------------------------------------------------------------------------------------------------------------------------------------------------------------------------------------------------------------------------------------------------------------------------------------------------------------------------------------|
| Match Condition      | Match condition is used for this traffic policy.                                                                                                                                                                                                                                                                                                                                                                                                                                                                                                                                                                                                                                                                                                                                                                                                                                                                                                                                                                                                                                                                                                                                                                                                                                                                                                                                                                                                                                                                                                                                                                                                                                                                                                                                                                                                                                                                                                                                                                      |                      |                                                                                                                                                                                                                                                                                                                                                                                                                                                                                                                                                                                                                                                                                                                                   |                      |                                                                                                                                                                                                                                                                                                                                                                                                                                                                                                                                                                                                                                                                                                                                                                                                                                                                                                                                                                                                                                                                                                                                                                                                                                                                                                                                                                                                                                                                                                                                                                                                                                                                                                                                          |                 |                                                                                                                                                                                                                                                                                                                                                                                                                                                                                                                                                                                                                                                                                                                                   |                |                                                                                                                                                                                                                                                                                                                                                                                                                                                                                                                                                                                                                                                                                                                                                                                                                                                                               |
|                      | <table border="1"> <tr> <td>Match Condition Name</td> <td>Enter a name for this match condition. Valid entries are unquoted text strings with no spaces and a maximum of 64 alphanumeric characters.</td> </tr> <tr> <td>Match Condition Type</td> <td> <table border="1"> <tr> <td>Layer 4 Payload</td> <td> <p>Layer 4 payload data that is used for the network matching criteria.</p> <p>Do the following:</p> <ol style="list-style-type: none"> <li>In the Layer 4 Payload RegexMatch Condition field, enter a Layer 4 payload expression that is contained within the TCP or UDP entity body. Valid entries are strings containing 1 to 255 alphanumeric characters. <a href="#">Table 14-33</a> lists the supported characters that you can use for matching string expressions.</li> <li>In the Layer 4 Payload Offset field, enter the absolute offset in the data where the Layer 4 payload expression search string starts. The offset starts at the first byte of the TCP or UDP body. Valid entries are from 0 to 999.</li> </ol> </td> </tr> <tr> <td>Source Address</td> <td> <p>Client source host IP address and subnet mask that are used for the network traffic matching criteria.</p> <p>Do the following:</p> <ol style="list-style-type: none"> <li>In the IP Address Type field, choose either <b>IPv4</b> or <b>IPv6</b>. This field appears only for ACE module and ACE appliance software Version A5(1.0) or later, which supports IPv4 and IPv6.</li> <li>In the Source IP v4/v6 Address field, enter the source IP address of the client in the format based on the address type (IPv4 or IPv6).</li> <li>Depending on the IP address type that you chose, do one of the following: <ul style="list-style-type: none"> <li>– For IPv4, in the Source Netmask field, choose the subnet mask for the source IP address.</li> <li>– For IPv6, in the Source Prefix-length field, enter the prefix length for the address.</li> </ul> </li> </ol> </td> </tr> </table> </td> </tr> </table> | Match Condition Name | Enter a name for this match condition. Valid entries are unquoted text strings with no spaces and a maximum of 64 alphanumeric characters.                                                                                                                                                                                                                                                                                                                                                                                                                                                                                                                                                                                        | Match Condition Type | <table border="1"> <tr> <td>Layer 4 Payload</td> <td> <p>Layer 4 payload data that is used for the network matching criteria.</p> <p>Do the following:</p> <ol style="list-style-type: none"> <li>In the Layer 4 Payload RegexMatch Condition field, enter a Layer 4 payload expression that is contained within the TCP or UDP entity body. Valid entries are strings containing 1 to 255 alphanumeric characters. <a href="#">Table 14-33</a> lists the supported characters that you can use for matching string expressions.</li> <li>In the Layer 4 Payload Offset field, enter the absolute offset in the data where the Layer 4 payload expression search string starts. The offset starts at the first byte of the TCP or UDP body. Valid entries are from 0 to 999.</li> </ol> </td> </tr> <tr> <td>Source Address</td> <td> <p>Client source host IP address and subnet mask that are used for the network traffic matching criteria.</p> <p>Do the following:</p> <ol style="list-style-type: none"> <li>In the IP Address Type field, choose either <b>IPv4</b> or <b>IPv6</b>. This field appears only for ACE module and ACE appliance software Version A5(1.0) or later, which supports IPv4 and IPv6.</li> <li>In the Source IP v4/v6 Address field, enter the source IP address of the client in the format based on the address type (IPv4 or IPv6).</li> <li>Depending on the IP address type that you chose, do one of the following: <ul style="list-style-type: none"> <li>– For IPv4, in the Source Netmask field, choose the subnet mask for the source IP address.</li> <li>– For IPv6, in the Source Prefix-length field, enter the prefix length for the address.</li> </ul> </li> </ol> </td> </tr> </table> | Layer 4 Payload | <p>Layer 4 payload data that is used for the network matching criteria.</p> <p>Do the following:</p> <ol style="list-style-type: none"> <li>In the Layer 4 Payload RegexMatch Condition field, enter a Layer 4 payload expression that is contained within the TCP or UDP entity body. Valid entries are strings containing 1 to 255 alphanumeric characters. <a href="#">Table 14-33</a> lists the supported characters that you can use for matching string expressions.</li> <li>In the Layer 4 Payload Offset field, enter the absolute offset in the data where the Layer 4 payload expression search string starts. The offset starts at the first byte of the TCP or UDP body. Valid entries are from 0 to 999.</li> </ol> | Source Address | <p>Client source host IP address and subnet mask that are used for the network traffic matching criteria.</p> <p>Do the following:</p> <ol style="list-style-type: none"> <li>In the IP Address Type field, choose either <b>IPv4</b> or <b>IPv6</b>. This field appears only for ACE module and ACE appliance software Version A5(1.0) or later, which supports IPv4 and IPv6.</li> <li>In the Source IP v4/v6 Address field, enter the source IP address of the client in the format based on the address type (IPv4 or IPv6).</li> <li>Depending on the IP address type that you chose, do one of the following: <ul style="list-style-type: none"> <li>– For IPv4, in the Source Netmask field, choose the subnet mask for the source IP address.</li> <li>– For IPv6, in the Source Prefix-length field, enter the prefix length for the address.</li> </ul> </li> </ol> |
| Match Condition Name | Enter a name for this match condition. Valid entries are unquoted text strings with no spaces and a maximum of 64 alphanumeric characters.                                                                                                                                                                                                                                                                                                                                                                                                                                                                                                                                                                                                                                                                                                                                                                                                                                                                                                                                                                                                                                                                                                                                                                                                                                                                                                                                                                                                                                                                                                                                                                                                                                                                                                                                                                                                                                                                            |                      |                                                                                                                                                                                                                                                                                                                                                                                                                                                                                                                                                                                                                                                                                                                                   |                      |                                                                                                                                                                                                                                                                                                                                                                                                                                                                                                                                                                                                                                                                                                                                                                                                                                                                                                                                                                                                                                                                                                                                                                                                                                                                                                                                                                                                                                                                                                                                                                                                                                                                                                                                          |                 |                                                                                                                                                                                                                                                                                                                                                                                                                                                                                                                                                                                                                                                                                                                                   |                |                                                                                                                                                                                                                                                                                                                                                                                                                                                                                                                                                                                                                                                                                                                                                                                                                                                                               |
| Match Condition Type | <table border="1"> <tr> <td>Layer 4 Payload</td> <td> <p>Layer 4 payload data that is used for the network matching criteria.</p> <p>Do the following:</p> <ol style="list-style-type: none"> <li>In the Layer 4 Payload RegexMatch Condition field, enter a Layer 4 payload expression that is contained within the TCP or UDP entity body. Valid entries are strings containing 1 to 255 alphanumeric characters. <a href="#">Table 14-33</a> lists the supported characters that you can use for matching string expressions.</li> <li>In the Layer 4 Payload Offset field, enter the absolute offset in the data where the Layer 4 payload expression search string starts. The offset starts at the first byte of the TCP or UDP body. Valid entries are from 0 to 999.</li> </ol> </td> </tr> <tr> <td>Source Address</td> <td> <p>Client source host IP address and subnet mask that are used for the network traffic matching criteria.</p> <p>Do the following:</p> <ol style="list-style-type: none"> <li>In the IP Address Type field, choose either <b>IPv4</b> or <b>IPv6</b>. This field appears only for ACE module and ACE appliance software Version A5(1.0) or later, which supports IPv4 and IPv6.</li> <li>In the Source IP v4/v6 Address field, enter the source IP address of the client in the format based on the address type (IPv4 or IPv6).</li> <li>Depending on the IP address type that you chose, do one of the following: <ul style="list-style-type: none"> <li>– For IPv4, in the Source Netmask field, choose the subnet mask for the source IP address.</li> <li>– For IPv6, in the Source Prefix-length field, enter the prefix length for the address.</li> </ul> </li> </ol> </td> </tr> </table>                                                                                                                                                                                                                                                                              | Layer 4 Payload      | <p>Layer 4 payload data that is used for the network matching criteria.</p> <p>Do the following:</p> <ol style="list-style-type: none"> <li>In the Layer 4 Payload RegexMatch Condition field, enter a Layer 4 payload expression that is contained within the TCP or UDP entity body. Valid entries are strings containing 1 to 255 alphanumeric characters. <a href="#">Table 14-33</a> lists the supported characters that you can use for matching string expressions.</li> <li>In the Layer 4 Payload Offset field, enter the absolute offset in the data where the Layer 4 payload expression search string starts. The offset starts at the first byte of the TCP or UDP body. Valid entries are from 0 to 999.</li> </ol> | Source Address       | <p>Client source host IP address and subnet mask that are used for the network traffic matching criteria.</p> <p>Do the following:</p> <ol style="list-style-type: none"> <li>In the IP Address Type field, choose either <b>IPv4</b> or <b>IPv6</b>. This field appears only for ACE module and ACE appliance software Version A5(1.0) or later, which supports IPv4 and IPv6.</li> <li>In the Source IP v4/v6 Address field, enter the source IP address of the client in the format based on the address type (IPv4 or IPv6).</li> <li>Depending on the IP address type that you chose, do one of the following: <ul style="list-style-type: none"> <li>– For IPv4, in the Source Netmask field, choose the subnet mask for the source IP address.</li> <li>– For IPv6, in the Source Prefix-length field, enter the prefix length for the address.</li> </ul> </li> </ol>                                                                                                                                                                                                                                                                                                                                                                                                                                                                                                                                                                                                                                                                                                                                                                                                                                                            |                 |                                                                                                                                                                                                                                                                                                                                                                                                                                                                                                                                                                                                                                                                                                                                   |                |                                                                                                                                                                                                                                                                                                                                                                                                                                                                                                                                                                                                                                                                                                                                                                                                                                                                               |
| Layer 4 Payload      | <p>Layer 4 payload data that is used for the network matching criteria.</p> <p>Do the following:</p> <ol style="list-style-type: none"> <li>In the Layer 4 Payload RegexMatch Condition field, enter a Layer 4 payload expression that is contained within the TCP or UDP entity body. Valid entries are strings containing 1 to 255 alphanumeric characters. <a href="#">Table 14-33</a> lists the supported characters that you can use for matching string expressions.</li> <li>In the Layer 4 Payload Offset field, enter the absolute offset in the data where the Layer 4 payload expression search string starts. The offset starts at the first byte of the TCP or UDP body. Valid entries are from 0 to 999.</li> </ol>                                                                                                                                                                                                                                                                                                                                                                                                                                                                                                                                                                                                                                                                                                                                                                                                                                                                                                                                                                                                                                                                                                                                                                                                                                                                                     |                      |                                                                                                                                                                                                                                                                                                                                                                                                                                                                                                                                                                                                                                                                                                                                   |                      |                                                                                                                                                                                                                                                                                                                                                                                                                                                                                                                                                                                                                                                                                                                                                                                                                                                                                                                                                                                                                                                                                                                                                                                                                                                                                                                                                                                                                                                                                                                                                                                                                                                                                                                                          |                 |                                                                                                                                                                                                                                                                                                                                                                                                                                                                                                                                                                                                                                                                                                                                   |                |                                                                                                                                                                                                                                                                                                                                                                                                                                                                                                                                                                                                                                                                                                                                                                                                                                                                               |
| Source Address       | <p>Client source host IP address and subnet mask that are used for the network traffic matching criteria.</p> <p>Do the following:</p> <ol style="list-style-type: none"> <li>In the IP Address Type field, choose either <b>IPv4</b> or <b>IPv6</b>. This field appears only for ACE module and ACE appliance software Version A5(1.0) or later, which supports IPv4 and IPv6.</li> <li>In the Source IP v4/v6 Address field, enter the source IP address of the client in the format based on the address type (IPv4 or IPv6).</li> <li>Depending on the IP address type that you chose, do one of the following: <ul style="list-style-type: none"> <li>– For IPv4, in the Source Netmask field, choose the subnet mask for the source IP address.</li> <li>– For IPv6, in the Source Prefix-length field, enter the prefix length for the address.</li> </ul> </li> </ol>                                                                                                                                                                                                                                                                                                                                                                                                                                                                                                                                                                                                                                                                                                                                                                                                                                                                                                                                                                                                                                                                                                                                         |                      |                                                                                                                                                                                                                                                                                                                                                                                                                                                                                                                                                                                                                                                                                                                                   |                      |                                                                                                                                                                                                                                                                                                                                                                                                                                                                                                                                                                                                                                                                                                                                                                                                                                                                                                                                                                                                                                                                                                                                                                                                                                                                                                                                                                                                                                                                                                                                                                                                                                                                                                                                          |                 |                                                                                                                                                                                                                                                                                                                                                                                                                                                                                                                                                                                                                                                                                                                                   |                |                                                                                                                                                                                                                                                                                                                                                                                                                                                                                                                                                                                                                                                                                                                                                                                                                                                                               |
| Insert Before        | <ol style="list-style-type: none"> <li>Indicate whether this rule is to precede another rule for this policy map: <ul style="list-style-type: none"> <li>– <b>N/A</b>—This option is not configured.</li> <li>– <b>False</b>—This rule is not to precede another rule in this policy map.</li> <li>– <b>True</b>—This rule is to precede another rule in this policy map. The Insert Before Policy Rule field appears.</li> </ul> </li> <li>If you chose True, in the Insert Before Policy Rule field, choose the rule that you want the current rule to precede.</li> </ol>                                                                                                                                                                                                                                                                                                                                                                                                                                                                                                                                                                                                                                                                                                                                                                                                                                                                                                                                                                                                                                                                                                                                                                                                                                                                                                                                                                                                                                          |                      |                                                                                                                                                                                                                                                                                                                                                                                                                                                                                                                                                                                                                                                                                                                                   |                      |                                                                                                                                                                                                                                                                                                                                                                                                                                                                                                                                                                                                                                                                                                                                                                                                                                                                                                                                                                                                                                                                                                                                                                                                                                                                                                                                                                                                                                                                                                                                                                                                                                                                                                                                          |                 |                                                                                                                                                                                                                                                                                                                                                                                                                                                                                                                                                                                                                                                                                                                                   |                |                                                                                                                                                                                                                                                                                                                                                                                                                                                                                                                                                                                                                                                                                                                                                                                                                                                                               |

**Step 5** Do one of the following:

- Click **Deploy Now** to deploy this configuration on the ACE and save your entries to the running-configuration and startup-configuration files. The window refreshes and the Action table appears. Continue with [Step 6](#).
- Click **Cancel** to exit this procedure without saving your entries and to return to the Rule table.



**Note** If you chose the Insert Before option described in [Table 14-16](#) and specified True, perform the following steps to refresh the Rule tab before adding an action for this rule:

1. Click the Rule tab to refresh the Rule table.
2. In the Rule table, choose the newly added rule.

When the window refreshes, an empty action list appears.

**Step 6** In the Action table, click **Add** to add an entry or choose an existing entry to modify and click **Edit**.

**Step 7** In the Id field, accept the automatically incremented entry or assign a unique identifier for this action.

**Step 8** In the Action Type field, configure actions for this rule using the information in [Table 14-17](#).

**Table 14-17** Generic Server Load Balancing Policy Map Actions

| Action         | Description                                                                                                                                                                                                                                                                                                                                                                                                                                                                                                                                                                                                                                                                                                                                                                                                                                                                                      |
|----------------|--------------------------------------------------------------------------------------------------------------------------------------------------------------------------------------------------------------------------------------------------------------------------------------------------------------------------------------------------------------------------------------------------------------------------------------------------------------------------------------------------------------------------------------------------------------------------------------------------------------------------------------------------------------------------------------------------------------------------------------------------------------------------------------------------------------------------------------------------------------------------------------------------|
| Drop           | Field that instructs the ACE to discard packets that match this policy map. In the Action Log field, specify whether or not the dropped packets are to be logged in the software: <ul style="list-style-type: none"> <li>• <b>N/A</b>—This option is not configured.</li> <li>• <b>False</b>—Dropped packets are not to be logged in the software.</li> <li>• <b>True</b>—Dropped packets are to be logged in the software.</li> </ul>                                                                                                                                                                                                                                                                                                                                                                                                                                                           |
| Forward        | Field that instructs the ACE to forward the traffic that matches this policy map to its destination.                                                                                                                                                                                                                                                                                                                                                                                                                                                                                                                                                                                                                                                                                                                                                                                             |
| Reverse Sticky | Feature that applies only to the ACE module version 3.0(0)A2(1.1), ACE appliance version A4(1.0), or later releases of either device type. Reverse IP stickiness is an enhancement to regular stickiness and is used mainly in FWLB. It ensures that multiple distinct connections that are opened by hosts at both ends (client and server) are load-balanced and stuck to the same firewall. Reverse stickiness applies to such protocols as FTP, RTSP, SIP, and so on where there are separate control channels and data channels opened by the client and the server, respectively. For complete details about reverse stickiness, see the <a href="#">Release Note for the Cisco Application Control Engine Module (Software Version 3.0(0)A2(X))</a> .<br><br>In the Sticky Group field, choose an existing IP netmask sticky group that you want to associate with reverse IP stickiness. |

Table 14-17 Generic Server Load Balancing Policy Map Actions (continued)

| Action             | Description                                                                                                                                                                                                                                                                                                                                                                                                                                                                                                                                                                                                                                                                                                                                                                                                                                                                                                                          |
|--------------------|--------------------------------------------------------------------------------------------------------------------------------------------------------------------------------------------------------------------------------------------------------------------------------------------------------------------------------------------------------------------------------------------------------------------------------------------------------------------------------------------------------------------------------------------------------------------------------------------------------------------------------------------------------------------------------------------------------------------------------------------------------------------------------------------------------------------------------------------------------------------------------------------------------------------------------------|
| Server Farm        | <p>Serverfarm that the ACE is to load balance client requests for content.</p> <p>Do the following:</p> <ol style="list-style-type: none"> <li>In the Server Farm field, choose the server farm for this policy map action.</li> <li>In the Backup Server Farm field, choose the backup server farm for this action.</li> <li>Check the <b>Sticky Enabled</b> check box to indicate that the backup server farm is sticky. Uncheck this check box if the backup server farm is not sticky.</li> <li>Check the <b>Aggregate State Enabled</b> check box to indicate that the operational state of the backup server farm is taken into consideration when evaluating the state of the load-balancing class in a policy map. Uncheck this check box to indicate that the operational state of the backup server farm is not taken into consideration when evaluating the state of the load-balancing class in a policy map.</li> </ol> |
| Server Farm-NAT    | <p>Dynamic NAT that the ACE is to apply to traffic for this policy map.</p> <p>Do the following:</p> <ol style="list-style-type: none"> <li>In the NAT Pool ID field, enter the number of the pool of IP addresses that exist under the VLAN specified in the VLAN Id field. Valid entries are from 1 to 2147483647. For information about configuring NAT pools, see <a href="#">“Configuring Virtual Context BVI Interfaces” section on page 12-19</a>.</li> <li>In the VLAN ID field, choose the VLAN to use for NAT. Valid entries are from 1 to 4094.</li> <li>In the Server Farm Type field, indicate whether the server farm is a backup or primary server farm.</li> </ol>                                                                                                                                                                                                                                                   |
| Set-IP-TOS         | <p>IP Differentiated Services Code Point (DSCP) bit in the Type of Service (ToS) byte that the ACE is to set. After the IP DSCP bit is set, other Quality of Service (QoS) services can then operate on the bit settings.</p> <p>In the IP TOS Rewrite Value field, enter the IP DSCP value. Valid entries are from 0 to 255.</p>                                                                                                                                                                                                                                                                                                                                                                                                                                                                                                                                                                                                    |
| Sticky Group       | Sticky group that you want to associate with reverse stickiness.                                                                                                                                                                                                                                                                                                                                                                                                                                                                                                                                                                                                                                                                                                                                                                                                                                                                     |
| Sticky Server Farm | <p>Sticky server farm that the ACE is to load balance client requests for content.</p> <p>In the Sticky Group field, choose the sticky server farm that is to be used for requests that match this policy map.</p>                                                                                                                                                                                                                                                                                                                                                                                                                                                                                                                                                                                                                                                                                                                   |

- Step 9** Do one of the following:
- Click **Deploy Now** to deploy this configuration on the ACE and save your entries to the running-configuration and startup-configuration files.
  - Click **Cancel** to exit the procedure without saving your entries and to return to the Action table.
  - Click **Next** to deploy your entries and to configure another action.

#### Related Topics

- [Configuring Traffic Policies, page 14-1](#)
- [Configuring Virtual Context Class Maps, page 14-6](#)
- [Configuring Virtual Context Policy Maps, page 14-32](#)

- [Configuring Rules and Actions for Policy Maps, page 14-34](#)

## Setting Policy Map Rules and Actions for Layer 3/Layer 4 Management Traffic

You can configure the rules and actions for IP management traffic received by the ACE.



### Note

Fields and information related to IPv6 require ACE module and ACE appliance software Version A5(1.0) or later.

### Assumptions

This topic assumes the following:

- A network management policy map has been configured.
- A class map has been defined for a class map rule if you do not want to use the class-default class map.

### Procedure

- 
- Step 1** Choose **Config > Devices > context > Expert > Policy Maps**.
- The Policy Maps table appears.
- Step 2** In the Policy Maps table, choose the Layer 3/Layer 4 management traffic policy map that you want to set rules and actions for.
- The Rule table appears.
- Step 3** In the Rule table, click **Add** to add a new rule, or choose the rule that you want to modify and click **Edit**.
- The Rule window appears.
- Step 4** In the Type field of the Rule window, confirm that classmap is selected.
- Step 5** In the Use Class Map field, do one of the following:
- For an IPv4 default class map, choose the **class-default** radio button.
  - For an IPv6 default class map, choose the **class-default-v6** radio button.
  - For a previously created class map, go to [Step 6](#).
- Step 6** To use a previously created class map for this rule, do the following:
- In the Use Class Map field, choose the **others** radio button.
  - In the Class Map Name field, choose the class map to be used.
  - In the Insert Before field, specify whether this rule is to precede another rule in this policy map:
    - **N/A**—This option is not configured.
    - **False**—This rule is not to precede another rule in this policy map.
    - **True**—This rule is to precede another rule in this policy map. The Insert Before Policy Rule field appears
  - If you chose True, in the Insert Before Policy Rule field, choose the rule that you want the current rule to precede.

**Step 7** Do one of the following:

- Click **Deploy Now** to deploy this configuration on the ACE and save your entries to the running-configuration and startup-configuration files. The Action table appears. To define actions for this rule, continue with [Step 8](#).
- Click **Cancel** to exit this procedure without saving your entries and to return to the Policy Maps table.
- Click **Next** to deploy your entries and to configure another rule.



**Note** If you chose the Insert Before option in [Step 6](#) and specified True, perform the following steps to refresh the Rule tab before adding an action for this rule:

1. Click the Rule tab to refresh the Rule table.
2. In the Rule table, choose the newly added rule.

When the window refreshes, an empty action list appears.

**Step 8** In the Action table, click **Add** to add an action or choose an existing action, and click **Edit** to modify it. The Action configuration window appears.

**Step 9** In the Id field of the Action configuration window, either accept the automatically incremented entry or assign a unique identifier for this action.

**Step 10** In the Action Type field, confirm that Management Permit is selected to indicate that this action permits or denies network management traffic.

**Step 11** In the Action field, specify the action that is to occur:

- **Deny**—The ACE is to deny network management traffic when this rule is met.
- **Permit**—The ACE is to accept network management traffic when this rule is met.

**Step 12** Do the following:

- Click **Deploy Now** to deploy this configuration on the ACE and save your entries to the running-configuration and startup-configuration files.
- Click **Cancel** to exit the procedure without saving your entries and to return to the Action table.
- Click **Next** to deploy your entries and to configure another action.

---

#### Related Topics

- [Configuring Virtual Context Class Maps, page 14-6](#)
- [Configuring Virtual Context Policy Maps, page 14-32](#)
- [Configuring Rules and Actions for Policy Maps, page 14-34](#)



## Setting Policy Map Rules and Actions for Layer 3/Layer 4 Network Traffic

You can configure rules and actions for Layer 3/Layer 4 traffic other than network management traffic.

**Note**

Fields and information related to IPv6 require ACE module and ACE appliance software Version A5(1.0) or later.

**Assumptions**

This topic assumes the following:

- You have configured a Layer 3/Layer 4 policy map.
- A class map has been defined if you do not want to use the class-default class map.

**Procedure**

- 
- Step 1** Choose **Config > Devices > context > Expert > Policy Maps**.
- The Policy Maps table appears.
- Step 2** In the Policy Maps table, choose the Layer 3/Layer 4 network traffic policy map that you want to set rules and actions for.
- The Rule table appears.
- Step 3** In the Rule table, click **Add** to add a new rule, or choose the rule that you want to modify and click **Edit**.
- The Rule configuration window appears.
- Step 4** In the Type field of the Rule configuration window, confirm that Class Map is selected.
- Step 5** In the Use Class Map field, choose one of the following:
- For an IPv4 default class map, choose the **class-default** radio button.
  - For an IPv6 default class map, choose the **class-default-v6** radio button.
  - For a previously created class map, go to [Step 6](#).
- Step 6** To use a previously created class map for this rule, do the following:
- a. In the Use Class Map field, choose the **others** radio button.
  - b. In the Class Map Name field, choose the class map to be used.
  - c. In the Insert Before field, choose one of the following to indicate whether this rule is to precede another rule in this policy map:
    - **N/A**—Indicates that this option is not configured.
    - **False**—Indicates that this rule is not to precede another rule in this policy map.
    - **True**—Indicates that this rule is to precede another rule in this policy map.If you select True, the Insert Before Policy Rule field appears. Select the rule that you want the current rule to precede.

**Step 7** Do one of the following:

- Click **Deploy Now** to deploy this configuration on the ACE and save your entries to the running-configuration and startup-configuration files. The window refreshes and the Action field appears. To configure actions for this rule, continue with [Step 8](#).
- Click **Cancel** to exit this procedure without saving your entries and to return to the Policy Maps table.
- Click **Next** to deploy your entries and to configure another rule.



**Note** If you chose the Insert Before option in [Step 6](#) and specified True, perform the following steps to refresh the Rule tab before adding an action for this rule:

1. Click the Rule tab to refresh the Rule table.
2. In the Rule table, choose the newly added rule.

When the window refreshes, an empty action list appears.

**Step 8** In the Action field, click **Edit**. The Action table appears.

**Step 9** In the Action table, click **Add** to add an action or choose an existing action and click **Edit** to modify it. The Action configuration window appears.

**Step 10** In the Id field, either accept the automatically incremented entry or assign a unique identifier for this action.

**Step 11** In the Action Type field, choose the type of action to be taken for this rule and configure the related attributes. See [Table 14-18](#).

**Table 14-18** Layer 3/Layer 4 Network Traffic Policy Map Actions

| Action                 | Description/Steps                                                                                                                                                                                                                                                   |
|------------------------|---------------------------------------------------------------------------------------------------------------------------------------------------------------------------------------------------------------------------------------------------------------------|
| Appl-Parameter-DNS     | DNS parameter map that contains DNS-related actions that is to be implemented for this rule.<br>In the Parameter Map field, specify the name of the DNS parameter map to use.                                                                                       |
| Appl-Parameter-Generic | Generic parameter map that is to be implemented for this rule.<br>In the Parameter Map field, specify the name of the generic parameter map to use.                                                                                                                 |
| Appl-Parameter-HTTP    | HTTP parameter map that contains HTTP-related actions that is to be implemented for this rule.<br>In the Parameter Map field, specify the name of the HTTP parameter map to use.                                                                                    |
| Appl-Parameter-RTSP    | RTSP parameter map that contains RTSP-related actions that is to be implemented for this rule.<br>In the Parameter Map field, specify the name of the RTSP parameter map to use.                                                                                    |
| Appl-Parameter-SIP     | SIP parameter map that contains SIP-related actions that is to be implemented for this rule.<br>In the Parameter Map field, specify the name of the SIP parameter map to use.                                                                                       |
| Appl-Parameter-Skinny  | Skinny parameter map that contains Skinny-related actions that is to be implemented for this rule.<br>In the Parameter Map field, specify the name of the Skinny parameter map to use.                                                                              |
| Connection             | Connection parameter map that contains TCP/IP connection-related commands that pertain to normalization and termination that is to be implemented for this rule.<br>In the Connection Parameter Maps field, choose the Connection parameter map that is to be used. |

**Table 14-18** Layer 3/Layer 4 Network Traffic Policy Map Actions (continued)

| Action                        | Description/Steps                                                                                                                                                                                                                                                                                                                                                                                                                                                                                                                                                                                                                                                                                                                                                                                                                                                                                                                                                                                                                                                                                                                                                                                                                                                                                                                                                                                                                                                                                                                                                                                                                                                                                                                                                                                                                 |
|-------------------------------|-----------------------------------------------------------------------------------------------------------------------------------------------------------------------------------------------------------------------------------------------------------------------------------------------------------------------------------------------------------------------------------------------------------------------------------------------------------------------------------------------------------------------------------------------------------------------------------------------------------------------------------------------------------------------------------------------------------------------------------------------------------------------------------------------------------------------------------------------------------------------------------------------------------------------------------------------------------------------------------------------------------------------------------------------------------------------------------------------------------------------------------------------------------------------------------------------------------------------------------------------------------------------------------------------------------------------------------------------------------------------------------------------------------------------------------------------------------------------------------------------------------------------------------------------------------------------------------------------------------------------------------------------------------------------------------------------------------------------------------------------------------------------------------------------------------------------------------|
| HTTP Optimize                 | Option that appears for ACE appliances only.<br>In the HTTP Optimization Policy field, choose the HTTP optimization policy map to use.                                                                                                                                                                                                                                                                                                                                                                                                                                                                                                                                                                                                                                                                                                                                                                                                                                                                                                                                                                                                                                                                                                                                                                                                                                                                                                                                                                                                                                                                                                                                                                                                                                                                                            |
| Inspect                       | Application inspection that is to be implemented for this rule.<br>Do the following: <ol style="list-style-type: none"> <li>a. In the Inspect Type field, choose the protocol that is to be inspected.</li> <li>b. Provide any protocol-specific information.</li> </ol> <p><a href="#">Table 14-19</a> describes the available options for application inspection actions.</p>                                                                                                                                                                                                                                                                                                                                                                                                                                                                                                                                                                                                                                                                                                                                                                                                                                                                                                                                                                                                                                                                                                                                                                                                                                                                                                                                                                                                                                                   |
| KAL-ap-Primary-Out-of-Service | Feature that is supported only for ACE module software Version A2(3.1), ACE appliance software Version A4(1.0), and later versions of either device type. This feature enables the ACE to notify a Global Site Selector (GSS) that the primary server farm is down when the backup server farm is in use.<br><br>By default, when you configure a redirect server farm as a backup server farm on the ACE and the primary server farm fails, the backup server farm redirects client requests to another data center; however, the VIP remains in the INSERVICE state.<br><br>When you configure the ACE to communicate with a GSS, it provides information for server availability. When a backup server is in use after the primary server farm is down, this feature enables the ACE to inform the GSS that the VIP for the primary server farm is out of service by returning a load value of 255. The GSS recognizes that the primary server farm is down and sends future DNS requests with the IP address of the other data center.                                                                                                                                                                                                                                                                                                                                                                                                                                                                                                                                                                                                                                                                                                                                                                                        |
| KAL-AP-TAG                    | Feature that is supported only for the ACE module software Version A2(2.0), ACE appliance software Version A4(1.0), and later versions for both device types. The KAL-AP-TAG feature allows the Cisco Global Site Selector (GSS) proprietary KAL-AP protocol to extract load and availability information from the ACE when a firewall is positioned between the GSS and the ACE. This feature allows you to configure a tag (name) per VIP for a maximum of 4096 tags on an ACE. This feature does not replace the tag per domain feature. For more information about this feature, see the <i>Release Note for the Cisco Application Control Engine Module (Software Version A2(2.0))</i> or the <i>Cisco Application Control Engine Module Server Load-Balancing Configuration Guide (Software Version A2(3.0))</i> , the Configuring Health Monitoring chapter.<br><br><b>Note</b> The KAL-AP-TAG selection is not available for the class-default class map.<br><br>In the KAL-AP-Tag Name field, enter the name as an unquoted text string with no spaces and a maximum of 76 alphanumeric characters.<br><br>The following scenarios are not supported and will result in an error: <ul style="list-style-type: none"> <li>• You cannot configure a tag name for a VIP that already has a tag configuration as part of a different policy configuration.</li> <li>• You cannot associate the same tag name with more than one VIP.</li> <li>• You cannot associate the same tag name with a domain and a VIP.</li> <li>• You cannot assign two different tags to two different Layer 3 class maps that have the same VIP, but different port numbers. The KAL-AP protocol considers these class maps to have the same VIP and calculates the load for both Layer 3 rules together when the GSS queries the VIP.</li> </ul> |

Table 14-18 Layer 3/Layer 4 Network Traffic Policy Map Actions (continued)

| Action    | Description/Steps                                                                                                                                                                                                                                                                                                                                                                                                                                                                                                                                                                                                                                                                                                                                                                                                                                                                                                                                                                                                                                                                                                                                                                                                                                                                                                                                                                                                                                                                                                                                                                                                                                                                                                                                                                                                                                                                                                                                                                                                                                                                                                                                                                                                                                                                                                                                                                                                                                                                                                                                                                                                                                                                                                                                                                                                                                                                                                                    |
|-----------|--------------------------------------------------------------------------------------------------------------------------------------------------------------------------------------------------------------------------------------------------------------------------------------------------------------------------------------------------------------------------------------------------------------------------------------------------------------------------------------------------------------------------------------------------------------------------------------------------------------------------------------------------------------------------------------------------------------------------------------------------------------------------------------------------------------------------------------------------------------------------------------------------------------------------------------------------------------------------------------------------------------------------------------------------------------------------------------------------------------------------------------------------------------------------------------------------------------------------------------------------------------------------------------------------------------------------------------------------------------------------------------------------------------------------------------------------------------------------------------------------------------------------------------------------------------------------------------------------------------------------------------------------------------------------------------------------------------------------------------------------------------------------------------------------------------------------------------------------------------------------------------------------------------------------------------------------------------------------------------------------------------------------------------------------------------------------------------------------------------------------------------------------------------------------------------------------------------------------------------------------------------------------------------------------------------------------------------------------------------------------------------------------------------------------------------------------------------------------------------------------------------------------------------------------------------------------------------------------------------------------------------------------------------------------------------------------------------------------------------------------------------------------------------------------------------------------------------------------------------------------------------------------------------------------------------|
| NAT       | <p>Network address translation (NAT) that the ACE is to use for this rule.</p> <p>Do the following:</p> <ol style="list-style-type: none"> <li>a. In the NAT Mode field, choose the type of NAT to be used: <ul style="list-style-type: none"> <li>- <b>Dynamic NAT</b>—NAT is to translate local addresses to a pool of global addresses. Continue with <a href="#">Step c</a>.</li> <li>- <b>Static NAT</b>—NAT is to translate each local address to a fixed global address. Continue with <a href="#">Step b</a>.</li> </ul> </li> <li>b. If you chose Static NAT, do the following: <ol style="list-style-type: none"> <li>1. In the IP Address Type field, choose either <b>IPv4</b> or <b>IPv6</b>. This field appears only for ACE module and ACE appliance software Version A5(1.0) or later, which supports IPv4 and IPv6.</li> <li>2. In the Static Mapped Address field, enter the IP address to use for static NAT translation. This entry establishes the globally unique IP address of a host as it appears to the outside world. The policy map performs the global IP address translation for the source IP address specified in the ACL (as part of the class-map traffic classification).</li> <li>3. Depending on the IP address type that you chose, do one of the following: <ul style="list-style-type: none"> <li>- For IPv4, in the Static Mapped Netmask field, choose the subnet mask to apply to the static mapped address.</li> <li>- For IPv6, in the Static Mapped Prefix-length field, enter the prefix length for the static mapped address.</li> </ul> </li> <li>4. In the NAT Protocol field, choose the protocol to use for NAT. Choices are as follows: <ul style="list-style-type: none"> <li>- <b>N/A</b>—This attribute is not set.</li> <li>- <b>TCP</b>—The ACE is to use TCP for NAT.</li> <li>- <b>UDP</b>—The ACE is to use UDP for NAT.</li> </ul> </li> <li>5. In the Static Port field, enter the TCP or UDP port to use for static port redirection. Valid entries are from 0 to 65535.</li> <li>6. In the VLAN Id field, choose the VLAN to use for NAT.</li> </ol> </li> <li>c. If you chose Dynamic NAT, do the following: <ol style="list-style-type: none"> <li>1. In the NAT Pool Id field, enter the number of the pool of IP addresses that exist under the VLAN specified in the VLAN Id field. Valid entries are from 1 to 2147483647. See the <a href="#">“Configuring Virtual Context BVI Interfaces”</a> section on page 12-19.</li> <li>2. In the VLAN Id field, choose the VLAN to use for NAT.</li> </ol> </li> </ol> <p><b>Note</b> For dynamic NAT, ACE allows you to associate a non-configured NAT pool ID to the dynamic NAT action. However, the ANM will not discover the dynamic NAT action when the NAT pool ID is not configured. You must associate the configured NAT pool ID to the dynamic NAT action for ANM discovery to complete successfully.</p> |
| Policymap | <p>Layer 7 server load-balancing policy map that the ACE is to associate with this Layer 3/Layer 4 policy map.</p> <p>In the Policy Map field, choose the Layer 7 policy map.</p>                                                                                                                                                                                                                                                                                                                                                                                                                                                                                                                                                                                                                                                                                                                                                                                                                                                                                                                                                                                                                                                                                                                                                                                                                                                                                                                                                                                                                                                                                                                                                                                                                                                                                                                                                                                                                                                                                                                                                                                                                                                                                                                                                                                                                                                                                                                                                                                                                                                                                                                                                                                                                                                                                                                                                    |

**Table 14-18** Layer 3/Layer 4 Network Traffic Policy Map Actions (continued)

| Action         | Description/Steps                                                                                                                                                                                                                                                                                                                                                                                                                                                                                                                                                                                                                                                                                                                                                                                                                                                                                                                           |
|----------------|---------------------------------------------------------------------------------------------------------------------------------------------------------------------------------------------------------------------------------------------------------------------------------------------------------------------------------------------------------------------------------------------------------------------------------------------------------------------------------------------------------------------------------------------------------------------------------------------------------------------------------------------------------------------------------------------------------------------------------------------------------------------------------------------------------------------------------------------------------------------------------------------------------------------------------------------|
| SSL-Proxy      | <p>SSL proxy server service that defines the SSL parameters that the ACE is to use during the handshake and subsequent SSL session.</p> <p>Do the following:</p> <ol style="list-style-type: none"> <li>In the SSL Proxy field, choose the SSL proxy server service to use in the handshake and subsequent SSL session when the ACE engages with an SSL client.</li> <li>In the SSL Proxy Type field, confirm that Server is selected to indicate that the ACE is to be configured so that it is recognized as an SSL server.</li> </ol>                                                                                                                                                                                                                                                                                                                                                                                                    |
| UDP-Fast-Age   | <p>Option that appears for ACE modules only. The ACE is to close the connection immediately after sending a response to the client, thereby enabling per-packet load balancing for UDP traffic.</p>                                                                                                                                                                                                                                                                                                                                                                                                                                                                                                                                                                                                                                                                                                                                         |
| VIP-Advertise  | <p>Option that appears for ACE modules release only. The ACE is to advertise the IP address of a virtual server as the host route.</p> <p>Do the following:</p> <ol style="list-style-type: none"> <li>In the Active field, check the checkbox if you want the ACE to advertises the IP address of the virtual server as the host route only if there is at least one active real server in the server farm.</li> </ol> <p> <b>Note</b> Uncheck the Active field check box if you want the ACE to always advertises the IP address of the virtual server whether there is any active real server associated with the VIP.</p> <ol style="list-style-type: none"> <li>If you check the Active field check box, in the Metric Distance field, enter the administrative distance to include in the routing table. Valid entries are from 1 to 254.</li> </ol> |
| VIP-ICMP-Reply | <p>VIP is to send an ICMP ECHO-REPLY response to ICMP requests.</p> <p>Do the following:</p> <ol style="list-style-type: none"> <li>In the Active field, check the checkbox to instruct the ACE to reply to an ICMP request only if the configured VIP is active. If the VIP is not active and the active option is specified, the ACE discards the ICMP request and the request times out.</li> <li>In the Primary Inservice field, check the checkbox to instruct the ACE to reply to an ICMP ping only if the primary server farm state is UP, regardless of the state of the backup server farm. If this option is enabled and the primary server farm state is DOWN, the ACE discards the ICMP request and the request times out.</li> </ol>                                                                                                                                                                                           |
| VIP-In-Service | <p>VIP is to be enabled for server load-balancing operations.</p>                                                                                                                                                                                                                                                                                                                                                                                                                                                                                                                                                                                                                                                                                                                                                                                                                                                                           |

**Table 14-19 Layer 3/Layer 4 Network Traffic Policy Map Application Inspection Options**

| Option | Description                                                                                                                                                                                                                                                                                                                                                                                                                                                                                                                                                                                                                                                                                                                                                                                                                                                                                                                                                                                                                                                                                                                                                                                   |
|--------|-----------------------------------------------------------------------------------------------------------------------------------------------------------------------------------------------------------------------------------------------------------------------------------------------------------------------------------------------------------------------------------------------------------------------------------------------------------------------------------------------------------------------------------------------------------------------------------------------------------------------------------------------------------------------------------------------------------------------------------------------------------------------------------------------------------------------------------------------------------------------------------------------------------------------------------------------------------------------------------------------------------------------------------------------------------------------------------------------------------------------------------------------------------------------------------------------|
| DNS    | <p>Domain Name System (DNS) query inspection is to be implemented. DNS requires application inspection so that DNS queries will not be subject to the generic UDP handling based on activity timeouts. Instead, the UDP connections associated with DNS queries and responses are torn down as soon as a reply to a DNS query has been received. The ACE performs the reassembly of DNS packets to verify that the packet length is less than the configured maximum length.</p> <p>In the DNS Max. Length field, enter the maximum length of a DNS reply in bytes. Default for all modules and ACE 4710 devices is 512. Valid range for ACE 1.0 modules is 64 to 65535, and for all other supported modules and ACE 4710 devices, 64 to 65535.</p>                                                                                                                                                                                                                                                                                                                                                                                                                                           |
| FTP    | <p>FTP inspection is to be implemented. The ACE inspects FTP packets, translates the address and port embedded in the payload, and opens up secondary channel for data.</p> <ol style="list-style-type: none"> <li>a. In the Parameter Map field, specify a previously created parameter map used to define parameters for FTP inspection.</li> <li>b. In the FTP Strict field, specify whether or not the ACE is to check for protocol RFC compliance and prevent Web browsers from sending embedded commands in FTP requests: <ul style="list-style-type: none"> <li>– N/A—This attribute is not set.</li> <li>– <b>False</b>—The ACE is not to check for RFC compliance or prevent Web browsers from sending embedded commands in FTP requests.</li> <li>– <b>True</b>—The ACE is to check for RFC compliance and prevent Web browsers from sending embedded commands in FTP requests.</li> </ul> </li> <li>c. If you chose True, in the FTP Inspect Policy field, choose the Layer 7 FTP command inspection policy to be implemented for this rule.</li> </ol>                                                                                                                            |
| HTTP   | <p>Enhanced Hypertext Transfer Protocol (HTTP) inspection is to be performed on HTTP traffic. The inspection checks are based on configured parameters in an existing Layer 7 policy map and internal RFC compliance checks performed by the ACE. By default, the ACE allows all request methods.</p> <p>Do the following:</p> <ol style="list-style-type: none"> <li>a. In the HTTP Inspect Policy field, choose the HTTP inspection policy map to be implemented for this rule. If you do not specify a Layer 7 policy map, the ACE performs a general set of Layer 3 and Layer 4 protocol fixup actions and internal RFC compliance checks.</li> <li>b. In the URL Logging field, specify whether or not Layer 3 and Layer 4 traffic is to be monitored: <ul style="list-style-type: none"> <li>– N/A—This attribute is not set.</li> <li>– <b>False</b>—Layer 3 and Layer 4 traffic is not to be monitored.</li> <li>– <b>True</b>—Layer 3 and Layer 4 traffic is to be monitored. When enabled, this function logs every URL request that is sent in the specified class of traffic, including the source or destination IP address and the URL that is accessed.</li> </ul> </li> </ol> |

**Table 14-19 Layer 3/Layer 4 Network Traffic Policy Map Application Inspection Options (continued)**

| Option | Description                                                                                                                                                                                                                                                                                                                                                                                                                                                                                                                                                                                                                                                                                                                                                                                                                                                                               |
|--------|-------------------------------------------------------------------------------------------------------------------------------------------------------------------------------------------------------------------------------------------------------------------------------------------------------------------------------------------------------------------------------------------------------------------------------------------------------------------------------------------------------------------------------------------------------------------------------------------------------------------------------------------------------------------------------------------------------------------------------------------------------------------------------------------------------------------------------------------------------------------------------------------|
| ICMP   | <p>Internet Control Message Protocol (ICMP) payload inspection is to be performed. ICMP inspection allows ICMP traffic to have a “session” so that it can be inspected similarly to TCP and UDP traffic.</p> <p>In the ICMP Error field, specify whether or not the ACE is to perform name address translation on ICMP error messages:</p> <ul style="list-style-type: none"> <li>• <b>N/A</b>—This attribute is not set.</li> <li>• <b>False</b>—The ACE is not to perform NAT on ICMP error messages.</li> <li>• <b>True</b>—The ACE is to perform NAT on ICMP error messages. When enabled, the ACE creates translation sessions for intermediate or endpoint nodes that send ICMP error messages based on the NAT configuration. The ACE overwrites the packet with the translated IP addresses.</li> </ul>                                                                           |
| ILS    | Internet Locator Service (ILS) protocol inspection is to be implemented.                                                                                                                                                                                                                                                                                                                                                                                                                                                                                                                                                                                                                                                                                                                                                                                                                  |
| RTSP   | <p>Real Time Streaming Protocol (RTSP) packet inspection is to be implemented. RTSP is used by RealAudio, RealNetworks, Apple QuickTime 4, RealPlayer, and Cisco IP/TV connections. The ACE monitors Setup and Response (200 OK) messages in the control channel established using TCP port 554 (no UDP support).</p> <p>In the Parameter Map field, choose a previously defined parameter map used to define parameters for RTSP inspection.</p>                                                                                                                                                                                                                                                                                                                                                                                                                                         |
| SIP    | <p>SIP protocol inspection is to be implemented. SIP is used for call handling sessions and instant messaging. The ACE inspects signaling messages for media connection addresses, media ports, and embryonic connections. The ACE also uses NAT to translate IP addresses that are embedded in the user-data portion of the packet.</p> <p>Do the following:</p> <ol style="list-style-type: none"> <li>a. In the Parameter Map field, specify a previously created parameter map used to define parameters for SIP inspection.</li> <li>b. In the SIP Inspect Policy field, choose a previously created Layer 7 SIP inspection policy map to implement packet inspection of Layer 7 SIP application traffic.</li> </ol> <p>If you do not specify a Layer 7 policy map, the ACE performs a general set of Layer 3 and Layer 4 HTTP fixup actions and internal RFC compliance checks.</p> |
| Skinny | <p>Cisco Skinny Client Control Protocol (SCCP) protocol inspection is to be implemented. The SCCP is a Cisco proprietary protocol that is used between Cisco CallManager and Cisco VOiP phones. The ACE uses NAT to translate embedded IP addresses and port numbers in SCCP packet data.</p> <p>Do the following:</p> <ol style="list-style-type: none"> <li>a. In the Parameter Map field, specify a previously created connection parameter map used to define parameters for Skinny inspection.</li> <li>b. In the Skinny Inspect Policy field, choose a previously created Layer 7 Skinny inspection policy map to implement packet inspection of Layer 7 Skinny application traffic.</li> </ol> <p>If you do not specify a Layer 7 policy map, the ACE performs a general set of Layer 3 and Layer 4 HTTP fixup actions and internal RFC compliance checks.</p>                     |

**Step 12** Do the following:

- Click **Deploy Now** to deploy this configuration on the ACE and save your entries to the running-configuration and startup-configuration files.
- Click **Cancel** to exit this procedure without saving your entries and to return to the Action table.
- Click **Next** to deploy your entries and to configure another Action.

#### Related Topics

- [Configuring Traffic Policies, page 14-1](#)
- [Configuring Virtual Context Class Maps, page 14-6](#)
- [Configuring Virtual Context Policy Maps, page 14-32](#)

## Setting Policy Map Rules and Actions for Layer 7 FTP Command Inspection

You can add rules and actions for Layer 7 FTP command inspection policy maps.

File Transfer Protocol (FTP) inspection inspects FTP sessions for address translation in a message, dynamic opening of ports, and stateful tracking of request and response messages. Each specified FTP command must be acknowledged before the ACE allows a new command. Command filtering allows you to restrict specific commands by the ACE. When the ACE denies a command, it closes the connection.

The FTP command inspection process, as performed by the ACE:

- Prepares a dynamic secondary data connection. The channels are allocated in response to a file upload, a file download, or a directory listing event and must be prenegotiated. The port is negotiated through the PORT or PASV commands.
- Tracks the FTP command-response sequence. The ACE performs the command checks listed below. If you specify the FTP Strict field in a Layer 3 and Layer 4 policy map, the ACE tracks each FTP command and response sequence for the anomalous activity outlined below. The FTP Strict parameter is used in conjunction with a Layer 7 FTP policy map (nested within the Layer 3 and Layer 4 policy map) to deny certain FTP commands or to mask the server reply for SYST command.



**Note** The use of the FTP Strict parameter may affect FTP clients that do not comply with the RFC standards.

- Truncated command—Checks the number of commas in the PORT and PASV reply command against a fixed value of five. If the value is not five, the ACE assumes that the PORT command is truncated and issues a warning message and closes the TCP connection.
- Incorrect command—Checks the FTP command to verify if it ends with <CR><LF> characters, as required by RFC 959. If the FTP command does not end with those characters, the ACE closes the connection.
- Size of RETR and STOR commands—Checked the size of the RETR and STOR commands against a fixed constant of 256. If the size is greater, the ACE logs an error message and closes the connection.
- Command spoofing—Verifies that the PORT command is always sent from the client. If a PORT command is sent from the server, the ACE denies the TCP connection.



- Reply spoofing—Verifies that the PASV reply command (227) is always sent from the server. If a PASV reply command is sent from the client, the ACE denies the TCP connection. This denial prevents a security hole when the user executes “227 xxxxx a1, a2, a3, a4, p1, p2.”
- Invalid port negotiation—Checks the negotiated dynamic port value to verify that it is greater than 1024 (port numbers in the range from 2 to 1024 are reserved for well-known connections). If the negotiated port falls in this range, the ACE closes the TCP connection.
- Command pipelining—Checks the number of characters present after the port numbers in the PORT and PASV reply command against a constant value of 8. If the number of characters is greater than 8, the ACE closes the TCP connection.
- Translates embedded IP addresses in conjunction with NAT. FTP command inspection translates the IP address within the application payload. Refer to RFC 959 for background details.

### Procedure

- 
- Step 1** Choose **Config > Devices > context > Expert > Policy Maps**.  
The Policy Maps table appears.
- Step 2** In the Policy Maps table, choose the Layer 7 FTP command inspection policy map that you want to set rules and actions for.  
The Rule table appears.
- Step 3** In the Rule table, click **Add** to add a new rule, or choose an existing rule and click **Edit** to modify it.  
The Rule configuration window appears.
- Step 4** In the Type field of the Rule configuration window, configure rules using the information in [Table 14-20](#).

**Table 14-20 Layer 7 FTP Command Inspection Policy Map Rules**

| Option    | Description                                                                                                                                                                                                                                                                                                                                                                                                                                                                                                                                                                                                                                                                                                                                                                                                                                                                                                                                                         |
|-----------|---------------------------------------------------------------------------------------------------------------------------------------------------------------------------------------------------------------------------------------------------------------------------------------------------------------------------------------------------------------------------------------------------------------------------------------------------------------------------------------------------------------------------------------------------------------------------------------------------------------------------------------------------------------------------------------------------------------------------------------------------------------------------------------------------------------------------------------------------------------------------------------------------------------------------------------------------------------------|
| Class Map | <p>Class map to use for this traffic policy.</p> <p>Do the following:</p> <ol style="list-style-type: none"> <li>a. To use the class-default class map, check the Use Class Default check box.<br/>The class-default class map is a reserved, well-known class map created by the ACE. You cannot delete or modify this class. All traffic that fails to meet the other matching criteria in the named class map belongs to the default traffic class. If none of the specified classifications matches the traffic, then the ACE performs the action specified by the class-default class map. The class-default class map has an implicit <b>match any</b> statement that enables it to match all traffic.</li> <li>b. To use a previously created class map, do the following: <ol style="list-style-type: none"> <li>1. Clear the Use Class Default check box.</li> <li>2. In the Class Map Name field, choose the class map to be used.</li> </ol> </li> </ol> |

Table 14-20 Layer 7 FTP Command Inspection Policy Map Rules (continued)

| Option          | Description                                                                                                                                                                                                                                                                                                                                                                                                                                                                                                                                                                                                                                                                      |
|-----------------|----------------------------------------------------------------------------------------------------------------------------------------------------------------------------------------------------------------------------------------------------------------------------------------------------------------------------------------------------------------------------------------------------------------------------------------------------------------------------------------------------------------------------------------------------------------------------------------------------------------------------------------------------------------------------------|
| Match Condition | <p>Match condition to use for this traffic policy.</p> <p>Do the following:</p> <ol style="list-style-type: none"> <li>In the Match Condition Name field, enter a name for this match condition. Valid entries are unquoted text strings with no spaces and a maximum of 64 alphanumeric characters.</li> <li>In the Match Condition Type field, confirm that Request Method Name is selected.</li> <li>In the Request Method Name field, choose the FTP command to be inspected for this rule. <a href="#">Table 14-8</a> describes the FTP commands that can be inspected.</li> </ol>                                                                                          |
| Insert Before   | <p>Order of the rules in the policy map.</p> <p>Do the following:</p> <ol style="list-style-type: none"> <li>Specify whether or not this rule is to precede another rule for this policy map. Choices are as follows: <ul style="list-style-type: none"> <li>– <b>N/A</b>—This option is not configured.</li> <li>– <b>False</b>—This rule is not to precede another rule in this policy map.</li> <li>– <b>True</b>—This rule is to precede another rule in this policy map. The Insert Before Policy Rule field appears.</li> </ul> </li> <li>If you chose True, in the Insert Before Policy Rule field, choose the rule that you want the current rule to precede.</li> </ol> |

- Step 5** Do one of the following:
- Click **Deploy Now** to deploy this configuration on the ACE and save your entries to the running-configuration and startup-configuration files. The window refreshes and the Action table appears. Continue with [Step 6](#).
  - Click **Cancel** to exit this procedure without saving your entries and to return to the Policy Maps table.
  - Click **Next** to deploy your entries and to configure another rule.



**Note** If you chose the Insert Before option described in [Table 14-20](#) and specified True, perform the following steps to refresh the Rule tab before adding an action for this rule:

1. Click the Rule tab to refresh the Rule table.
2. In the Rule table, choose the newly added rule.

When the window refreshes, an empty action list appears.

- Step 6** In the Action table, click **Add** to add an entry, or choose an existing entry and click **Edit** to modify it. The Action configuration window appears.
- Step 7** In the Id field of the Action configuration window, either accept the automatically incremented entry or assign a unique identifier for this action.
- Step 8** In the Action Type field, specify the action to be taken for this rule:
- **Deny**—The ACE is to deny the specified FTP command when this rule is met.

- **Mask Reply**—The ACE is to mask the reply to the FTP **sys** command by filtering sensitive information from the command output. The action applies to the FTP **sys** command only.

**Step 9** Do one of the following:

- Click **Deploy Now** to deploy this configuration on the ACE and save your entries to the running-configuration and startup-configuration files.
- Click **Cancel** to exit this procedure without saving your entries and to return to the Action table.
- Click **Next** to deploy your entries and to configure another action for this rule.

---

#### Related Topics

- [Configuring Traffic Policies, page 14-1](#)
- [Configuring Virtual Context Class Maps, page 14-6](#)
- [Configuring Virtual Context Policy Maps, page 14-32](#)

## Setting Policy Map Rules and Actions for Layer 7 HTTP Deep Packet Inspection

You can add rules and actions for Layer 7 HTTP deep packet inspection policy maps.

The ACE performs a stateful deep packet inspection of the HTTP protocol. Deep packet inspection is a special case of application inspection where the ACE examines the application payload of a packet or a traffic stream and makes decisions based on the content of the data. During HTTP deep inspection, the main focus of the application inspection process is on HTTP attributes such as HTTP header, URL, and to a limited extent, the payload. User-defined regular expressions can also be used to detect “signatures” in the payload.

You define policies to permit or deny the traffic, or to send a TCP reset message to the client or server to close the connection.

The security features covered by HTTP application inspection include:

- RFC compliance monitoring and RFC method filtering
- Content, URL, and HTTP header length checks
- Transfer-encoding methods
- Content type verification and filtering
- Port 80 misuse

#### Procedure

---

**Step 1** Choose **Config > Devices > context > Expert > Policy Maps**.

The Policy Maps table appears.

**Step 2** In the Policy Maps table, choose the Layer 7 deep packet inspection policy map that you want to set rules and actions for.

The Rule table appears.

**Step 3** In the Rule table, click **Add** to add a new rule, or choose an existing rule and click **Edit** to modify it.

The Rule configuration window appears.

**Step 4** In the Type field of the Rule configuration window, configure rules using the information in [Table 14-21](#).

**Table 14-21** Layer 7 HTTP Deep Packet Inspection Policy Map Rules

| Option          | Description                                                                                                                                                                                                                                                                                                                                                                                                                                                                                                                                                                                                                                                                                                                                                                                                                                                                                                                                                                |
|-----------------|----------------------------------------------------------------------------------------------------------------------------------------------------------------------------------------------------------------------------------------------------------------------------------------------------------------------------------------------------------------------------------------------------------------------------------------------------------------------------------------------------------------------------------------------------------------------------------------------------------------------------------------------------------------------------------------------------------------------------------------------------------------------------------------------------------------------------------------------------------------------------------------------------------------------------------------------------------------------------|
| Class Map       | <p>Class map to use for this traffic policy.</p> <p>From the Use Class Map field, do one of the following:</p> <ul style="list-style-type: none"> <li>• To use the default class map, choose <b>class-default</b>.<br/> <p>The class-default class map is a reserved, well-known class map created by the ACE. You cannot delete or modify this class. All traffic that fails to meet the other matching criteria in the named class map belongs to the default traffic class. If none of the specified classifications matches the traffic, then the ACE performs the action specified by the class-default class map. The class-default class map has an implicit <b>match any</b> statement that enables it to match all traffic.</p> </li> <li>• To use a previously created class map, do the following: <ol style="list-style-type: none"> <li>1. Choose <b>others</b>.</li> <li>2. In the Class Map Name field, choose the class map to use.</li> </ol> </li> </ul> |
| Match Condition | <p>Match condition to use for this traffic policy.</p> <p>Do the following:</p> <ol style="list-style-type: none"> <li>a. In the Match Condition Name field, enter a name for this match condition. Valid entries are unquoted text strings with no spaces and a maximum of 64 alphanumeric characters.</li> <li>b. In the Match Condition Type field, choose the method by which match decisions are to be made and their corresponding conditions. See <a href="#">Table 14-22</a> for information about these selections.</li> </ol>                                                                                                                                                                                                                                                                                                                                                                                                                                    |
| Insert Before   | <p>Order of the rules in the policy map.</p> <p>Do the following:</p> <ol style="list-style-type: none"> <li>a. Specify whether or not this rule is to precede another rule for this policy map. Choices are as follows: <ul style="list-style-type: none"> <li>– <b>N/A</b>—This option is not configured.</li> <li>– <b>False</b>—This rule is not to precede another rule in this policy map.</li> <li>– <b>True</b>—This rule is to precede another rule in this policy map. The Insert Before Policy Rule field appears.</li> </ul> </li> <li>b. If you chose True, in the Insert Before Policy Rule field, choose the rule that you want the current rule to precede.</li> </ol>                                                                                                                                                                                                                                                                                     |

**Table 14-22 Layer 7 HTTP Deep Packet Inspection Policy Map Match Conditions**

| Match Condition           | Description                                                                                                                                                                                                                                                                                                                                                                                                                                                                                                                                                                                                                                                                                                                                                                                                                                                                                                                                                                                                                                                                                                                                                                                                                                                                                                                                                                                                                                                                                                                                                                                                                                                                                                                                                                                                                                                                                                                                                                                                                                                               |
|---------------------------|---------------------------------------------------------------------------------------------------------------------------------------------------------------------------------------------------------------------------------------------------------------------------------------------------------------------------------------------------------------------------------------------------------------------------------------------------------------------------------------------------------------------------------------------------------------------------------------------------------------------------------------------------------------------------------------------------------------------------------------------------------------------------------------------------------------------------------------------------------------------------------------------------------------------------------------------------------------------------------------------------------------------------------------------------------------------------------------------------------------------------------------------------------------------------------------------------------------------------------------------------------------------------------------------------------------------------------------------------------------------------------------------------------------------------------------------------------------------------------------------------------------------------------------------------------------------------------------------------------------------------------------------------------------------------------------------------------------------------------------------------------------------------------------------------------------------------------------------------------------------------------------------------------------------------------------------------------------------------------------------------------------------------------------------------------------------------|
| Content                   | <p>Content contained within the HTTP entity-body that is used for protocol inspection decisions.</p> <p>Do the following:</p> <ol style="list-style-type: none"> <li>a. In the Content Expression field, enter the content that is to be matched. Valid entries are alphanumeric strings from 1 to 255 characters.</li> <li>b. In the Content Offset (Bytes) field, enter the number of bytes to be ignored starting with the first byte of the Message body, after the empty line (CR,LF,CR,LF) between the headers and the body of the message. Valid entries are from 1 to 255 bytes.</li> </ol>                                                                                                                                                                                                                                                                                                                                                                                                                                                                                                                                                                                                                                                                                                                                                                                                                                                                                                                                                                                                                                                                                                                                                                                                                                                                                                                                                                                                                                                                       |
| Content Length            | <p>Content parse length in an HTTP message that is used for protocol inspection decisions.</p> <p>Do the following:</p> <ol style="list-style-type: none"> <li>a. In the Content Length Operator field, choose the operand to be used to compare content length: <ul style="list-style-type: none"> <li>– <b>Equal To</b>—Content length must equal the number in the Content Length Value (Bytes) field.</li> <li>– <b>Greater Than</b>—Content length must be greater than the number in the Content Length Value (Bytes) field.</li> <li>– <b>Less Than</b>—Content length must be less than the number in the Content Length Value (Bytes) field.</li> <li>– <b>Range</b>—Content length must be within the range specified in the Content Length Lower Value (Bytes) field and the Content Length Higher Value (Bytes) field.</li> </ul> </li> <li>b. Enter values to apply for content length comparison as follows: <ul style="list-style-type: none"> <li>– If you chose Equal To, Greater Than, or Less Than in the Content Length Operator field, the Content Length Value (Bytes) field appears. In the Content Length Value (Bytes) field, enter the number of bytes for comparison. Valid entries are from 0 to 4294967295.</li> <li>– If you chose Range in the Content Length Operator field, the Content Length Lower Value (Bytes) and the Content Length Higher Value (Bytes) fields appear: <ol style="list-style-type: none"> <li>1. In the Content Length Lower Value (Bytes) field, enter the lowest number of bytes to be used for this match condition. Valid entries are from 0 to 4294967295. The number in this field must be less than the number entered in the Content Length Higher Value (Bytes) field.</li> <li>2. In the Content Length Higher Value (Bytes) field, enter the highest number of bytes to be used for this match condition. Valid entries are from 1 to 4294967295. The number in this field must be greater than the number entered in the Content Length Lower Value (Bytes) field.</li> </ol> </li> </ul> </li> </ol> |
| Content Type Verification | <p>Match command that verifies the content MIME-type messages with the header MIME-type. This inline match command limits the MIME-types in HTTP messages allowed through the ACE. It verifies that the header MIME-type value is in the internal list of supported MIME-types and the header MIME-type matches the actual content in the data or entity body portion of the message. If they do not match, the ACE performs the specified Layer 7 policy map action.</p>                                                                                                                                                                                                                                                                                                                                                                                                                                                                                                                                                                                                                                                                                                                                                                                                                                                                                                                                                                                                                                                                                                                                                                                                                                                                                                                                                                                                                                                                                                                                                                                                 |

Table 14-22 Layer 7 HTTP Deep Packet Inspection Policy Map Match Conditions (continued)

| Match Condition | Description                                                                                                                                                                                                                                                                                                                                                                                                                                                                                                                                                                                                                                                                                                                                                                                                                                                                                                                                                                                                                                                                                                                                                                                                                                                                                                                                                                                                                                                                                                                                                                                                                                                                                                                                                                                                                                                                                                                                                                                                                                                                                                                                                                                                                                                                                                                                                                                                                                                                |
|-----------------|----------------------------------------------------------------------------------------------------------------------------------------------------------------------------------------------------------------------------------------------------------------------------------------------------------------------------------------------------------------------------------------------------------------------------------------------------------------------------------------------------------------------------------------------------------------------------------------------------------------------------------------------------------------------------------------------------------------------------------------------------------------------------------------------------------------------------------------------------------------------------------------------------------------------------------------------------------------------------------------------------------------------------------------------------------------------------------------------------------------------------------------------------------------------------------------------------------------------------------------------------------------------------------------------------------------------------------------------------------------------------------------------------------------------------------------------------------------------------------------------------------------------------------------------------------------------------------------------------------------------------------------------------------------------------------------------------------------------------------------------------------------------------------------------------------------------------------------------------------------------------------------------------------------------------------------------------------------------------------------------------------------------------------------------------------------------------------------------------------------------------------------------------------------------------------------------------------------------------------------------------------------------------------------------------------------------------------------------------------------------------------------------------------------------------------------------------------------------------|
| Header          | <p>Name and value in an HTTP header that are used for protocol inspection decisions.</p> <p>Do the following:</p> <ol style="list-style-type: none"> <li>a. In the Header field, choose one of the predefined HTTP headers to be matched, or choose HTTP Header to specify a different HTTP header.</li> <li>b. If you chose HTTP Header, in the Header Name field, enter the name of the HTTP header to match. Valid entries are unquoted text strings with no spaces and a maximum of 64 alphanumeric characters.</li> <li>c. In the Header Value (Bytes) field, enter the header value expression string to compare against the value in the specified field in the HTTP header. Valid entries are text strings with a maximum of 255 alphanumeric characters. The ACE supports regular expressions for matching. To include spaces in the string, enclose the entire string in quotes. All headers in the header map must be matched. See <a href="#">Table 14-33</a> for a list of the supported characters that you can use in regular expressions.</li> </ol>                                                                                                                                                                                                                                                                                                                                                                                                                                                                                                                                                                                                                                                                                                                                                                                                                                                                                                                                                                                                                                                                                                                                                                                                                                                                                                                                                                                                       |
| Header Length   | <p>Length of the header in the HTTP message that is used for protocol inspection decisions.</p> <p>Do the following:</p> <ol style="list-style-type: none"> <li>a. In the Header Length Type field, specify whether or not HTTP header request or response messages are to be used for protocol inspection decisions: <ul style="list-style-type: none"> <li>– <b>Request</b>—HTTP header request messages are to be checked for header length.</li> <li>– <b>Response</b>—HTTP header response messages are to be checked for header length.</li> </ul> </li> <li>b. In the Header Length Operator field, choose the operand to be used to compare header length: <ul style="list-style-type: none"> <li>– <b>Equal To</b>—The header length must equal the number in the Header Length Value (Bytes) field.</li> <li>– <b>Greater Than</b>—The header length must be greater than the number in the Header Length Value (Bytes) field.</li> <li>– <b>Less Than</b>—The header length must be less than the number in the Header Length Value (Bytes) field.</li> <li>– <b>Range</b>—The header length must be within the range specified in the Header Length Lower Value (Bytes) field and the Header Length Higher Value (Bytes) field.</li> </ul> </li> <li>c. Enter values to apply for header length comparison as follows: <ul style="list-style-type: none"> <li>– If you chose Equal To, Greater Than, or Less Than in the Header Length Operator field, the Header Length Value (Bytes) field appears. In the Header Length Value (Bytes) field, enter the number of bytes for comparison. Valid entries are from 0 to 255.</li> <li>– If you chose Range in the Header Length Operator field, the Header Length Lower Value (Bytes) and the Header Length Higher Value (Bytes) fields appear.</li> </ul> <p>Do the following:</p> <ol style="list-style-type: none"> <li>1. In the Header Length Lower Value (Bytes) field, enter the lowest number of bytes to be used for this match condition. Valid entries are from 0 to 255. The number in this field must be less than the number entered in the Header Length Higher Value (Bytes) field.</li> <li>2. In the Header Length Higher Value (Bytes) field, enter the highest number of bytes to be used for this match condition. Valid entries are from 1 to 255. The number in this field must be greater than the number entered in the Header Length Lower Value (Bytes) field.</li> </ol> </li> </ol> |

**Table 14-22** Layer 7 HTTP Deep Packet Inspection Policy Map Match Conditions (continued)

| Match Condition   | Description                                                                                                                                                                                                                                                                                                                                                                                                                                                                                                                                                                                                                                                                                                                                                                                                                                                                                                                                                                                                                                                     |
|-------------------|-----------------------------------------------------------------------------------------------------------------------------------------------------------------------------------------------------------------------------------------------------------------------------------------------------------------------------------------------------------------------------------------------------------------------------------------------------------------------------------------------------------------------------------------------------------------------------------------------------------------------------------------------------------------------------------------------------------------------------------------------------------------------------------------------------------------------------------------------------------------------------------------------------------------------------------------------------------------------------------------------------------------------------------------------------------------|
| Header MIME Type  | Multipurpose Internet Mail Extension (MIME) message types that are used for protocol inspection decisions. In the Header MIME Type field, choose the MIME message type to be used for this match condition.                                                                                                                                                                                                                                                                                                                                                                                                                                                                                                                                                                                                                                                                                                                                                                                                                                                     |
| Port Misuse       | Misuse of port 80 (or any other port running HTTP) that is used for protocol inspection decisions. In the Port Misuse field, choose the application category to be used for this match condition: <ul style="list-style-type: none"> <li>• <b>IM</b>—Instant messaging applications are to be used for this match condition.</li> <li>• <b>P2P</b>—Peer-to-peer applications are to be used for this match condition.</li> <li>• <b>Tunneling</b>—Tunneling applications are to be used for this match condition.</li> </ul>                                                                                                                                                                                                                                                                                                                                                                                                                                                                                                                                    |
| Request Method    | Request method that is used for protocol inspection decisions. By default, ACEs allow all request and extension methods. This option allows you to configure class maps that define protocol inspection decisions based on compliance to request methods defined in RFC 2616 and by HTTP extension methods. <p>a. In the Request Method Type field, choose the type of compliance to be used for protocol inspection decision:</p> <ul style="list-style-type: none"> <li>– <b>Ext</b>—An HTTP extension method is to be used for protocol inspection decisions.</li> </ul> <p> <b>Note</b> The list of available HTTP extension methods from which to choose varies depending on the version of software installed in the ACE.</p> <ul style="list-style-type: none"> <li>– <b>RFC</b>—A request method defined in RFC 2616 is to be used for protocol inspection decisions.</li> </ul> <p>b. In the Request Method field, choose the specific request method to be used.</p> |
| Strict HTTP       | Internal compliance checks that are performed to verify that a message is compliant with the HTTP RFC standard, RFC 2616. If the HTTP message is not compliant, the ACE performs the specified Layer 7 policy map action.                                                                                                                                                                                                                                                                                                                                                                                                                                                                                                                                                                                                                                                                                                                                                                                                                                       |
| Transfer Encoding | HTTP transfer-encoding type that is used for protocol inspection decisions. The transfer-encoding general-header field indicates the type of transformation, if any, that has been applied to the HTTP message body to safely transfer it between the sender and the recipient. <p>In the Transfer Encoding field, choose the type of encoding that is to be checked:</p> <ul style="list-style-type: none"> <li>• <b>Chunked</b>—Message body is transferred as a series of chunks.</li> <li>• <b>Compress</b>—Encoding format that is produced by the UNIX file compression program compress.</li> <li>• <b>Deflate</b>—The .zlib format that is defined in RFC 1950 in combination with the DEFLATE compression mechanism described in RFC 1951.</li> <li>• <b>Gzip</b>—Encoding format that is produced by the file compression program GZIP (GNU zip) as described in RFC 1952.</li> <li>• <b>Identity</b>—Default (identity) encoding which does not require the use of transformation.</li> </ul>                                                        |

Table 14-22 Layer 7 HTTP Deep Packet Inspection Policy Map Match Conditions (continued)

| Match Condition | Description                                                                                                                                                                                                                                                                                                                                                                                                                                                                                                                                                                                                                                                                                                                                                                                                                                                                                                                                                                                                                                                                                                                                                                                                                                                                                                                                                                                                                                                                                                                                                                                                                                                                                                                                                                                                                                                                                                                                               |
|-----------------|-----------------------------------------------------------------------------------------------------------------------------------------------------------------------------------------------------------------------------------------------------------------------------------------------------------------------------------------------------------------------------------------------------------------------------------------------------------------------------------------------------------------------------------------------------------------------------------------------------------------------------------------------------------------------------------------------------------------------------------------------------------------------------------------------------------------------------------------------------------------------------------------------------------------------------------------------------------------------------------------------------------------------------------------------------------------------------------------------------------------------------------------------------------------------------------------------------------------------------------------------------------------------------------------------------------------------------------------------------------------------------------------------------------------------------------------------------------------------------------------------------------------------------------------------------------------------------------------------------------------------------------------------------------------------------------------------------------------------------------------------------------------------------------------------------------------------------------------------------------------------------------------------------------------------------------------------------------|
| URL             | URL names are used for protocol inspection decisions. In the URL field, enter a URL or a portion of a URL to match. Valid entries are URL strings from 1 to 255 alphanumeric characters and include only the portion of the URL following <i>www.hostname.domain</i> . For example, in the URL <i>www.anydomain.com/latest/whatsnew.html</i> , include only <i>/latest/whatsnew.html</i> .                                                                                                                                                                                                                                                                                                                                                                                                                                                                                                                                                                                                                                                                                                                                                                                                                                                                                                                                                                                                                                                                                                                                                                                                                                                                                                                                                                                                                                                                                                                                                                |
| URL Length      | <p>URL length that is used for protocol inspection decisions.</p> <p>Do the following:</p> <ol style="list-style-type: none"> <li>a. In the URL Length Operator field, choose the operand to be used to compare URL length: <ul style="list-style-type: none"> <li>– <b>Equal To</b>—URL length must equal the number in the URL Length Value (Bytes) field.</li> <li>– <b>Greater Than</b>—URL length must be greater than the number in the URL Length Value (Bytes) field.</li> <li>– <b>Less Than</b>—URL length must be less than the number in the URL Length Value (Bytes) field.</li> <li>– <b>Range</b>—URL length must be within the range specified in the URL Length Lower Value (Bytes) field and the URL Length Higher Value (Bytes) field.</li> </ul> </li> <li>b. Enter values to apply for URL length comparison as follows: <ul style="list-style-type: none"> <li>– If you chose Equal To, Greater Than, or Less Than in the URL Length Operator field, the URL Length Value (Bytes) field appears. In the URL Length Value (Bytes) field, enter the value for comparison. Valid entries are from 1 to 65535 bytes.</li> <li>– If you chose Range in the URL Length Operator field, the URL Length Lower Value (Bytes) and the URL Length Higher Value (Bytes) fields appear.</li> </ul> <p>Do the following:</p> <ol style="list-style-type: none"> <li>1. In the URL Length Lower Value (Bytes) field, enter the lowest number of bytes to be used for this match condition. Valid entries are from 1 to 65535. The number in this field must be less than the number entered in the URL Length Higher Value (Bytes) field.</li> <li>2. In the URL Length Higher Value (Bytes) field, enter the highest number of bytes to be used for this match condition. Valid entries are from 1 to 65535. The number in this field must be greater than the number entered in the URL Length Lower Value (Bytes) field.</li> </ol> </li> </ol> |

**Step 5** Do one of the following:

- Click **Deploy Now** to deploy this configuration on the ACE and save your entries to the running-configuration and startup-configuration files. The window refreshes and the Action table appears. To define actions for this rule, continue with [Step 6](#).
- Click **Cancel** to exit this procedure without saving your entries and to return to the Policy Maps table.
- Click **Next** to deploy your entries and to configure another rule.



**Note**

If you chose the Insert Before option described in [Table 14-21](#) and specified True, perform the following steps to refresh the Rule tab before adding an action for this rule:

1. Click the Rule tab to refresh the Rule table.
2. In the Rule table, choose the newly added rule.

When the window refreshes, an empty action list appears.

**Step 6** In the Action table, click **Add** to add a new action, or choose an existing action and click **Edit** to modify it.

The Action configuration window appears.

**Step 7** In the Id field of the Action configuration window, either accept the automatically incremented entry or assign a unique identifier for this action.

**Step 8** In the Action Type field, choose the action to be taken for this rule:

- **Permit**—The HTTP traffic is to be allowed if it meets the match criteria.
- **Reset**—The HTTP traffic is to be denied if it meets the match criteria. A TCP reset message is sent to the client or server to close the connection.

**Step 9** In the Action Log field, specify whether or not the action taken is to be logged:

- **N/A**—This option is not configured.
- **False**—Dropped packets are not to be logged in the software.
- **True**—Dropped packets are to be logged in the software.

**Step 10** Do one of the following:

- Click **Deploy Now** to deploy this configuration on the ACE and save your entries to the running-configuration and startup-configuration files.
- Click **Cancel** to exit this procedure without saving your entries and to return to the Action table.
- Click **Next** to configure another action for this policy map and rule.

**Related Topics**

- [Configuring Traffic Policies, page 14-1](#)
- [Configuring Virtual Context Class Maps, page 14-6](#)
- [Configuring Virtual Context Policy Maps, page 14-32](#)
- [Configuring Rules and Actions for Policy Maps, page 14-34](#)

## Setting Policy Map Rules and Actions for Layer 7 HTTP Optimization

**Note**

HTTP optimization policy maps are available for ACE appliances only.

You can add rules and actions for Layer 7 HTTP optimization policy maps.

**Assumptions**

This topic assumes the following:

- An action list has been configured. See [Configuring an HTTP Optimization Action List, page 15-3](#) for more information.
- A class map has been defined if you are not using the class-default class map. See [Configuring Virtual Context Class Maps, page 14-6](#) for more information.

**Procedure**

- 
- Step 1** Choose **Config > Devices > context > Expert > Policy Maps**.
- The Policy Maps table appears.
- Step 2** In the Policy Maps table, choose the Layer 7 HTTP optimization policy map that you want to set rules and actions for.
- The Rule table appears.
- Step 3** In the Rule table, click **Add** to add a new rule, or choose an existing rule and click **Edit** to modify it.
- The Rule configuration window appears.
- Step 4** In the Type field of the Rule configuration window, configure rules using the information in [Table 14-23](#).

**Table 14-23** Layer 7 HTTP Optimization Policy Map Rules

| Option    | Description                                                                                                                                                                                                                                                                                                                                                                                                                                                                                                                                                                                                                                                                                                                                                                                                                                                                                                                                                                                                   |
|-----------|---------------------------------------------------------------------------------------------------------------------------------------------------------------------------------------------------------------------------------------------------------------------------------------------------------------------------------------------------------------------------------------------------------------------------------------------------------------------------------------------------------------------------------------------------------------------------------------------------------------------------------------------------------------------------------------------------------------------------------------------------------------------------------------------------------------------------------------------------------------------------------------------------------------------------------------------------------------------------------------------------------------|
| Class Map | <p>Class map to use for this traffic policy.</p> <p>From the Use Class Map field, do one of the following:</p> <ul style="list-style-type: none"> <li>• To use the default class map, choose <b>class-default</b>.</li> </ul> <p>The class-default class map is a reserved, well-known class map created by the ACE. You cannot delete or modify this class. All traffic that fails to meet the other matching criteria in the named class map belongs to the default traffic class. If none of the specified classifications matches the traffic, then the ACE performs the action specified by the class-default class map. The class-default class map has an implicit <b>match any</b> statement that enables it to match all traffic.</p> <ul style="list-style-type: none"> <li>• To use a previously created class map, do the following: <ol style="list-style-type: none"> <li>1. Choose <b>others</b>.</li> <li>2. In the Class Map Name field, choose the class map to use.</li> </ol> </li> </ul> |

**Table 14-23** Layer 7 HTTP Optimization Policy Map Rules (continued)

| Option          | Description                                                                                                                                                                                                                                                                                                                                                                                                                                                                                                                                                                                                                                                    |
|-----------------|----------------------------------------------------------------------------------------------------------------------------------------------------------------------------------------------------------------------------------------------------------------------------------------------------------------------------------------------------------------------------------------------------------------------------------------------------------------------------------------------------------------------------------------------------------------------------------------------------------------------------------------------------------------|
| Match Condition | <p>Match condition to use for this traffic policy.</p> <p>Do the following:</p> <ol style="list-style-type: none"> <li>a. In the Match Condition Name field, enter a name for this match condition. Valid entries are unquoted text strings with no spaces and a maximum of 64 alphanumeric characters.</li> <li>b. In the Match Condition Type field, choose the method by which match decisions are to be made and their corresponding conditions. See <a href="#">Table 14-24</a> for information about these selections.</li> </ol>                                                                                                                        |
| Insert Before   | <p>Order of the rules in the policy map.</p> <p>Do the following:</p> <ol style="list-style-type: none"> <li>a. Specify whether or not this rule is to precede another rule for this policy map: <ul style="list-style-type: none"> <li>– <b>N/A</b>—This option is not configured.</li> <li>– <b>False</b>—This rule is not to precede another rule in this policy map.</li> <li>– <b>True</b>—This rule is to precede another rule in this policy map. The Insert Before Policy Rule field appears.</li> </ul> </li> <li>b. If you chose True, in the Insert Before Policy Rule field, choose the rule that you want the current rule to precede.</li> </ol> |

**Table 14-24 Layer 7 HTTP Optimization Policy Map Match Conditions**

| Match Condition | Procedure                                                                                                                                                                                                                                                                                                                                                                                                                                                                                                                                                                                                                                                                                                                                                                                                                                                                                                                                                                                                                                |
|-----------------|------------------------------------------------------------------------------------------------------------------------------------------------------------------------------------------------------------------------------------------------------------------------------------------------------------------------------------------------------------------------------------------------------------------------------------------------------------------------------------------------------------------------------------------------------------------------------------------------------------------------------------------------------------------------------------------------------------------------------------------------------------------------------------------------------------------------------------------------------------------------------------------------------------------------------------------------------------------------------------------------------------------------------------------|
| Cookie          | <p>HTTP cookie that is to be used to establish a match condition.</p> <p>Do the following:</p> <ol style="list-style-type: none"> <li>In the Cookie Name field, enter a unique cookie name. Valid entries are unquoted text strings with no spaces and a maximum of 64 alphanumeric characters.</li> <li>In the Cookie Value field, enter a unique cookie value expression. Valid entries are unquoted text strings with no spaces and a maximum of 255 alphanumeric characters.</li> <li>In the Secondary Cookie field, check the checkbox to specify that the ACE is to use either the cookie name or the cookie value to satisfy this match condition. Uncheck this check box to indicate that the ACE is to use either the cookie name or the cookie value to satisfy this match condition.</li> </ol>                                                                                                                                                                                                                               |
| Header          | <p>HTTP header that is to be used to establish a match condition.</p> <p>Do the following:</p> <ol style="list-style-type: none"> <li>In the Header field, choose one of the predefined HTTP headers to be matched, or choose HTTP Header to specify a different HTTP header.</li> <li>If you chose HTTP Header, in the Header Name field, enter the name of the HTTP header to match. Valid entries are unquoted text strings with no spaces and a maximum of 64 alphanumeric characters.</li> <li>In the Header Value (Bytes) field, enter the header value expression string to compare against the value in the specified field in the HTTP header. Valid entries are text strings with a maximum of 255 alphanumeric characters. The ACE supports regular expressions for matching. To include spaces in the string, enclose the entire string in quotes. All headers in the header map must be matched. See <a href="#">Table 14-33</a> for a list of the supported characters that you can use in regular expressions.</li> </ol> |
| HTTP URL        | <p>Portion of an HTTP URL that is to be used to establish a match condition.</p> <p>Do the following:</p> <ol style="list-style-type: none"> <li>In the URL Expression field, enter a URL or a portion of a URL to match. Valid entries are URL strings from 1 to 255 alphanumeric characters and include only the portion of the URL following <code>www.hostname.domain</code>. For example, in the URL <code>www.anydomain.com/latest/whatsnew.html</code>, include only <code>/latest/whatsnew.html</code>.</li> <li>In the Method Expression field, enter the HTTP method to match. Valid entries are method names entered as unquoted text strings with no spaces and a maximum of 15 alphanumeric characters. You can enter either one of the standard HTTP 1.1 method names (OPTIONS, GET, HEAD, POST, PUT, DELETE, TRACE, or CONNECT) or a text string that must be matched exactly (for example, CORVETTE).</li> </ol>                                                                                                         |

**Step 5** Do one of the following:

- Click **Deploy Now** to deploy this configuration on the ACE and save your entries to the running-configuration and startup-configuration files. The window refreshes and the Action table appears. To define actions for this rule, continue with [Step 6](#).
- Click **Cancel** to exit this procedure without saving your entries and to return to the Rule table.
- Click **Next** to deploy your entries and to configure another rule.

**Note**

If you chose the Insert Before option described in [Table 14-23](#) and specified True, perform the following steps to refresh the Rule tab before adding an action for this rule:

1. Click the Rule tab to refresh the Rule table.
2. In the Rule table, choose the newly added rule.

When the window refreshes, an empty action list appears.

- Step 6** In the Action table, click **Add** to add a new action, or choose an existing action and click **Edit** to modify it.
- The Action configuration window appears.
- Step 7** In the Id field of the Action configuration window, either accept the automatically incremented entry or assign a unique identifier for this action.
- Step 8** In the Action Type field, confirm that Action List is selected.
- Step 9** In the Action List field, choose the action list to apply to this policy map and rule.
- Step 10** In the Optimization Parameter Map field, choose the optimization parameter map to apply to this policy map and rule.
- Step 11** Do one of the following:
- Click **Deploy Now** to deploy this configuration on the ACE and save your entries to the running-configuration and startup-configuration files.
  - Click **Cancel** to exit this procedure without saving your entries and to return to the Action table.
  - Click **Next** to deploy your entries and to configure another action for this rule.

**Related Topics**

- [Configuring Traffic Policies, page 14-1](#)
- [Configuring Virtual Context Class Maps, page 14-6](#)
- [Configuring Virtual Context Policy Maps, page 14-32](#)
- [Configuring Rules and Actions for Policy Maps, page 14-34](#)

## Setting Policy Map Rules and Actions for Layer 7 Server Load-Balancing Traffic

You can set rules and actions for Layer 7 server load-balancing policy maps.

**Assumptions**

This topic assumes the following:

- You have configured a load-balancing policy map and want to establish the corresponding rules and actions.
- If you want to configure an SSL proxy action, you have configured SSL proxy service for this context.

- If you want to insert, rewrite, and delete HTTP headers, ensure that an HTTP header modify action list has been configured (see the “[Configuring an HTTP Header Modify Action List](#)” section on [page 14-85](#)).

### Procedure

- 
- Step 1** Choose **Config > Devices > context > Expert > Policy Maps**.  
The Policy Maps table appears.
- Step 2** In the Policy Maps table, choose the load-balancing policy map you want to set rules and actions for.  
The Rule table appears.
- Step 3** In the Rule table, click **Add** to add a new rule, or choose an existing rule and **Edit** to modify it.  
The Rule configuration window appears.
- Step 4** From the Type field, choose one of the following rule types to use:
- **Class Map**—Indicates that the ACE appliance is to use an existing class map that identifies the rules and corresponding actions. If you choose this rule type, go to [Step 5](#).
  - **Match Condition**—Indicates that the ACE appliance is to use a set of conditions to identify the rules and corresponding actions. If you choose this rule type, go to [Step 6](#).
- Step 5** If you chose Class Map rule type, from the Use Class Map field, either choose **class-default** to use the default class map or specify a previously created class map as follows:
- From the Use Class Map field, choose **others**. The Class Map field appears.
  - From the Class Map field, choose the class map to use.
  - In the Insert Before field, indicate whether this rule is to precede another rule in this policy map by choosing one of the following options:
    - **N/A**—Indicates that this option is not configured.
    - **False**—Indicates that this rule is not to precede another rule in this policy map.
    - **True**—Indicates that this rule is to precede another rule in this policy map.
  - If you chose True, the Insert Before Policy Rule field appears. Select the rule that you want the current rule to precede.
- Step 6** If you chose the Match Conditions rule type, do the following:
- In the Match Condition Name field enter a name for the match condition. Valid entries are unquoted text strings with no spaces and a maximum of 64 alphanumeric characters.
  - In the Match Condition Type field, select the method by which match decisions are to be made and their corresponding conditions. See [Table 14-25](#) for information about these selections.



**Note** Fields and information related to IPv6 require ACE module and ACE appliance software Version A5(1.0) or later.

**Table 14-25 Layer 7 Server Load Balancing Policy Map Match Conditions**

| Match Condition | Description                                                                                                                                                                                                                                                                                                                                                                                                                                                                                                                                                                                                                                                                                                                                                                                                                                                                                                                                                                                                                                                                                                                                                                                                         |
|-----------------|---------------------------------------------------------------------------------------------------------------------------------------------------------------------------------------------------------------------------------------------------------------------------------------------------------------------------------------------------------------------------------------------------------------------------------------------------------------------------------------------------------------------------------------------------------------------------------------------------------------------------------------------------------------------------------------------------------------------------------------------------------------------------------------------------------------------------------------------------------------------------------------------------------------------------------------------------------------------------------------------------------------------------------------------------------------------------------------------------------------------------------------------------------------------------------------------------------------------|
| HTTP Content    | <p>Option that appears for ACE modules only. Specific content contained within the HTTP entity-body is used to establish a match condition.</p> <p>Do the following:</p> <ol style="list-style-type: none"> <li>a. In the Content Expression field, enter the content that is to be matched. Valid entries are alphanumeric strings from 1 to 255 characters.</li> <li>b. In the Content Offset (Bytes) field, enter the number of bytes to be ignored starting with the first byte of the Message body, after the empty line (CR,LF,CR,LF) between the headers and the body of the message. Valid entries are from 1 to 255.</li> </ol>                                                                                                                                                                                                                                                                                                                                                                                                                                                                                                                                                                            |
| HTTP Cookie     | <p>HTTP cookies are to be used for this match condition.</p> <p>Do the following:</p> <ol style="list-style-type: none"> <li>a. In the Cookie Name field, enter a unique cookie name. Valid entries are unquoted text strings with no spaces and a maximum of 64 alphanumeric characters.</li> <li>b. In the Cookie Value field, enter a unique cookie value expression. Valid entries are unquoted text strings with no spaces and a maximum of 255 alphanumeric characters. The ACE supports regular expressions for matching string expressions. <a href="#">Table 14-33</a> lists the supported characters that you can use for matching string expressions.</li> </ol>                                                                                                                                                                                                                                                                                                                                                                                                                                                                                                                                         |
| HTTP Header     | <p>HTTP header and a corresponding value are to be used for this match condition.</p> <p>Do the following:</p> <ol style="list-style-type: none"> <li>a. In the Header Name field, specify the header to match in one of the following ways: <ul style="list-style-type: none"> <li>– To specify an HTTP header that is not one of the standard HTTP headers, choose the first radio button, then enter the HTTP header name in the Header Name field. Valid entries are unquoted text strings with no spaces and a maximum of 64 characters.</li> <li>– To specify a standard HTTP header, click the second radio button, then choose an HTTP header from the list.</li> </ul> </li> <li>b. In the Header Value (Bytes) field, enter the header-value expression string to compare against the value in the specified field in the HTTP header. Valid entries are text strings with a maximum of 255 alphanumeric characters. The ACE supports regular expressions for matching. To include spaces, enclose the entire string in quotes. All headers in the header map must be matched. See <a href="#">Table 14-33</a> for a list of the supported characters that you can use in regular expressions.</li> </ol> |

Table 14-25 Layer 7 Server Load Balancing Policy Map Match Conditions (continued)

| Match Condition | Description                                                                                                                                                                                                                                                                                                                                                                                                                                                                                                                                                                                                                                                                                                                                                                                                                                                                                                                                                                                                                                                                                                                                                                                                                                                                         |
|-----------------|-------------------------------------------------------------------------------------------------------------------------------------------------------------------------------------------------------------------------------------------------------------------------------------------------------------------------------------------------------------------------------------------------------------------------------------------------------------------------------------------------------------------------------------------------------------------------------------------------------------------------------------------------------------------------------------------------------------------------------------------------------------------------------------------------------------------------------------------------------------------------------------------------------------------------------------------------------------------------------------------------------------------------------------------------------------------------------------------------------------------------------------------------------------------------------------------------------------------------------------------------------------------------------------|
| HTTP URL        | <p>Rule that performs regular expression matching against the received packet data from a particular connection based on the HTTP URL string.</p> <p>Do the following:</p> <ol style="list-style-type: none"> <li>In the URL Expression field, enter a URL, or portion of a URL, to match. Valid entries are URL strings from 1 to 255 alphanumeric characters. Include only the portion of the URL following <code>www.hostname.domain</code> in the match statement. For example, in the URL <code>www.anydomain.com/latest/whatsnew.html</code>, include only <code>/latest/whatsnew.html</code>. To match the <code>www.anydomain.com</code> portion, the URL string can take the form of a URL regular expression. The ACE supports regular expressions for matching URL strings. See Table 14-33 for a list of the supported characters that you can use in regular expressions.</li> <li>In the Method Expression field, enter the HTTP method to match. Valid entries are unquoted text strings with no spaces and a maximum of 15 alphanumeric characters. The method can either be one of the standard HTTP 1.1 method names (OPTIONS, GET, HEAD, POST, PUT, DELETE, TRACE, or CONNECT) or a text string that must be matched exactly (for example, CORVETTE).</li> </ol> |
| Source Address  | <p>Client source IP address that is used to establish match conditions.</p> <p>Do the following:</p> <ol style="list-style-type: none"> <li>In the IP Address Type field, choose either <b>IPv4</b> or <b>IPv6</b>. This field appears only for ACE module and ACE appliance software Version A5(1.0) or later, which supports IPv4 and IPv6.</li> <li>In the Source IP v4/v6 Address field, enter the source IP address of the client in the format based on the address type (IPv4 or IPv6).</li> <li>Depending on the IP address type that you chose, do one of the following: <ul style="list-style-type: none"> <li>– For IPv4, from the Source Netmask field, choose the subnet mask of the IP address.</li> <li>– For IPv6, from the Source Prefix-length field, enter the prefix length for the address.</li> </ul> </li> </ol>                                                                                                                                                                                                                                                                                                                                                                                                                                             |

**Step 7** For specific class maps and match conditions, in the Insert Before field, indicate whether this rule is to precede another defined policy rule by choosing one of the following:

- **N/A**—Indicates that this option is not applicable.
- **False**—Indicates that this rule is not to precede another defined policy rule.
- **True**—Indicates that this rule is to precede another policy rule.

If you select True, in the Insert Before Policy Rule field, select the policy rule that this rule is to precede.

**Step 8** Do one of the following:

- Click **Deploy Now** to deploy this configuration on the ACE and save your entries to the running-configuration and startup-configuration files. The window refreshes and the Action table appears. To define the actions for this rule, continue with Step 9.
- Click **Cancel** to exit this procedure without saving your entries and to return to the Rule table.
- Click **Next** to deploy your entries and to configure another rule.



**Note**

If you chose the Insert Before option described in [Step 7](#) and specified True, perform the following steps to refresh the Rule tab before adding an action for this rule:

1. Click the Rule tab to refresh the Rule table.
2. In the Rule table, choose the newly added rule.

When the window refreshes, an empty action list appears.

- Step 9** In the Action table, click **Add** to add a new action, or choose an existing action and click **Edit** to modify it.
- Step 10** In the Id field, either accept the automatically incremented entry or assign a unique identifier for this action.
- Step 11** In the Action Type field, choose the action to be taken and configure any action-specific attributes as described in [Table 14-26](#).

**Table 14-26** Layer 7 Server Load Balancing Policy Map Actions

| Action   | Description                                                                                                                                                                                                                                                                                                                                                                                                                                                                                                                                                                                                                                                                                                                               |
|----------|-------------------------------------------------------------------------------------------------------------------------------------------------------------------------------------------------------------------------------------------------------------------------------------------------------------------------------------------------------------------------------------------------------------------------------------------------------------------------------------------------------------------------------------------------------------------------------------------------------------------------------------------------------------------------------------------------------------------------------------------|
| Action   | Action that the ACE is to implement for the rule. In the Action List field, choose an action list to associate with this rule.                                                                                                                                                                                                                                                                                                                                                                                                                                                                                                                                                                                                            |
| Compress | Option that appears for ACE appliances (all versions) and ACE modules version A4(1.0) and later. The ACE is to compress packets that match this policy map. This option is available only when you associate an HTTP-type class map with a policy map.<br>In the Compress Method field, specify the method that the ACE is to use to compress packets: <ul style="list-style-type: none"> <li>• <b>Deflate</b>—Indicates that the ACE is to use the DEFLATE compression method when the client browser supports both the DEFLATE and GZIP compression methods.</li> <li>• <b>Gzip</b>—Indicates that ACE is to use the GZIP compression method when the client browser supports both the DEFLATE and GZIP compression methods.</li> </ul> |
| Drop     | Field that instructs the ACE to discard packets that match the rule. In the Action Log field, specify whether or not the dropped packets are to be logged in the software: <ul style="list-style-type: none"> <li>• <b>N/A</b>—This option is not configured.</li> <li>• <b>False</b>—Dropped packets are not to be logged in the software.</li> <li>• <b>True</b>—Dropped packets are to be logged in the software.</li> </ul>                                                                                                                                                                                                                                                                                                           |
| Forward  | Field that instructs the ACE to forward requests that match this policy map without load balancing the requests.                                                                                                                                                                                                                                                                                                                                                                                                                                                                                                                                                                                                                          |

Table 14-26 Layer 7 Server Load Balancing Policy Map Actions (continued)

| Action         | Description                                                                                                                                                                                                                                                                                                                                                                                                                                                                                                                                                                                                                                                                                                                                                                                                                                                                                                                                                                                                                                                                                                                                                                                                                                                                                               |
|----------------|-----------------------------------------------------------------------------------------------------------------------------------------------------------------------------------------------------------------------------------------------------------------------------------------------------------------------------------------------------------------------------------------------------------------------------------------------------------------------------------------------------------------------------------------------------------------------------------------------------------------------------------------------------------------------------------------------------------------------------------------------------------------------------------------------------------------------------------------------------------------------------------------------------------------------------------------------------------------------------------------------------------------------------------------------------------------------------------------------------------------------------------------------------------------------------------------------------------------------------------------------------------------------------------------------------------|
| Insert-HTTP    | <p>Field that instructs the ACE to insert an HTTP header for Layer 7 load balancing for requests that match this policy map. This option allows the ACE to identify a client whose IP address has been translated using NAT by inserting a generic header and string value in the client HTTP request.</p> <p>Do the following:</p> <ol style="list-style-type: none"> <li>a. In the HTTP Header Name field, enter the name of the generic field in the HTTP header. Valid entries are unquoted text strings with no spaces and a maximum of 64 alphanumeric characters.</li> <li>b. In the HTTP Header Value field, enter the value to be inserted into the HTTP header. Valid entries are unquoted text strings with a maximum of 255 alphanumeric characters. The ACE supports regular expressions for matching. To include spaces, enclose the entire string in quotes. All headers in the header map must be matched. See <a href="#">Table 14-33</a> for a list of the supported characters that you can use in regular expressions.</li> </ol>                                                                                                                                                                                                                                                     |
| Reverse Sticky | <p>Feature that applies only to the ACE module version 3.0(0)A2(1.1), ACE appliance version A4(1.0), or later releases of either device type. Reverse IP stickiness is an enhancement to regular stickiness and is used mainly in firewall load balancing (FWLB). It ensures that multiple distinct connections that are opened by hosts at both ends (client and server) are load-balanced and stuck to the same firewall. Reverse stickiness applies to such protocols as FTP, RTSP, SIP, and so on where there are separate control channels and data channels opened by the client and the server, respectively. For complete details about reverse stickiness, see the <a href="#">Release Note for the Cisco Application Control Engine Module (Software Version 3.0(0)A2(X))</a>.</p> <p>In the Sticky Group field, choose the name of an existing IP netmask sticky group that you want to associate with reverse IP stickiness.</p>                                                                                                                                                                                                                                                                                                                                                              |
| Server Farm    | <p>Field that instructs the ACE to load balance client requests for content to a server farm.</p> <p>Do the following:</p> <ol style="list-style-type: none"> <li>a. In the Server Farm field, choose the server farm to which requests for content are to be sent.</li> <li>b. In the Backup Server Farm field, choose the backup server farm to which requests for content are to be sent.<br/>Choose <b>N/A</b> to indicate that no backup server farm is to be used.</li> <li>c. Choose the Sticky Enabled check box to indicate that the sticky group associated with this policy and applied to the primary server farm is applied to the backup server farm. Clear the Sticky Enabled check box to indicate that the sticky group associated with this policy and applied to the primary server farm in that policy is not applied to the backup server farm.</li> <li>d. Choose the Aggregate State Enabled check box to indicate that the operational state of the backup server farm is taken into consideration when evaluating the state of the load-balancing class in a policy map. Clear this check box to indicate that the operational state of the backup server farm is not taken into consideration when evaluating the state of the load-balancing class in a policy map.</li> </ol> |

**Table 14-26** Layer 7 Server Load Balancing Policy Map Actions (continued)

| Action             | Description                                                                                                                                                                                                                                                                                                                                                                                                                                                                                                                                                                                                                                                                                                       |
|--------------------|-------------------------------------------------------------------------------------------------------------------------------------------------------------------------------------------------------------------------------------------------------------------------------------------------------------------------------------------------------------------------------------------------------------------------------------------------------------------------------------------------------------------------------------------------------------------------------------------------------------------------------------------------------------------------------------------------------------------|
| Server Farm-NAT    | <p>Option that appears for ACE modules only. The ACE is to apply dynamic NAT to traffic for this policy map.</p> <p>Do the following:</p> <ol style="list-style-type: none"> <li>a. In the NAT Pool ID field, enter the number of the pool of IP addresses that exist under the VLAN specified in the VLAN Id field. Valid entries are from 1 to 2147483647. For information on configuring NAT pools, see <a href="#">Configuring Virtual Context BVI Interfaces, page 12-19</a>.</li> <li>b. In the VLAN ID field, choose the VLAN to use for NAT. Valid entries are from 1 to 4094.</li> <li>c. In the Server Farm Type field, indicate whether the server farm is a backup or primary server farm.</li> </ol> |
| Set IP-TOS         | <p>Set the IP Differentiated Services Code Point (DSCP) bit in the Type of Service (ToS) byte. After the IP DSCP bit is set, other Quality of Service (QoS) services can then operate on the bit settings.</p> <p>In the IP TOS Rewrite Value (Bytes) field, enter the IP DSCP value. Valid entries are from 0 to 255.</p>                                                                                                                                                                                                                                                                                                                                                                                        |
| SSL-Proxy          | <p>SSL proxy client service that defines the SSL parameters that the ACE is to use during the handshake and subsequent SSL session.</p> <p>Do the following:</p> <ol style="list-style-type: none"> <li>a. In the SSL Proxy field, choose the SSL proxy service to be used for this action.</li> <li>b. In the SSL Proxy Type field, confirm that Client is selected to indicate that the ACE is to be configured so that it is recognized as an SSL client.</li> </ol>                                                                                                                                                                                                                                           |
| Sticky-Server Farm | <p>Field that instructs the ACE to load balance requests that match this policy to a sticky server farm. In the Sticky Group field, choose the sticky server farm that is to be used for requests that match this policy map.</p>                                                                                                                                                                                                                                                                                                                                                                                                                                                                                 |

**Step 12** Do one of the following:

- Click **Deploy Now** to deploy this configuration on the ACE and save your entries to the running-configuration and startup-configuration files.
  - Click **Cancel** to exit the procedure without saving your entries and to return to the Action table.
  - Click **Next** to deploy your entries and to configure another action.
- 

#### Related Topics

- [Configuring Traffic Policies, page 14-1](#)
- [Configuring Virtual Context Class Maps, page 14-6](#)
- [Configuring Virtual Context Policy Maps, page 14-32](#)
- [Configuring Rules and Actions for Policy Maps, page 14-34](#)

## Setting Policy Map Rules and Actions for Layer 7 SIP Deep Packet Inspection

You can configure the rules and actions for a SIP deep packet inspection policy map.

#### Assumptions

This topic assumes the following:

- A SIP deep packet inspection policy map has been configured.
- A class map has been defined for a class map rule if you do not want to use the class-default class map.

#### Procedure

---

**Step 1** Choose **Config > Devices > context > Expert > Policy Maps**.

The Policy Maps table appears.

**Step 2** In the Policy Maps table, choose the SIP deep packet inspection policy map that you want to set rules and actions for.

The Rule table appears.

**Step 3** In the Rule table, click **Add** to add a new rule, or choose the rule that you want to modify and click **Edit**.

The Rule window appears.

**Step 4** In the Type field of the Rule window, configure rules using the information in [Table 14-27](#).

**Table 14-27** Layer 7 SIP Deep Packet Inspection Policy Map Rules

| Option          | Description                                                                                                                                                                                                                                                                                                                                                                                                                                                                                                                                                                                                                                                                                                                                                                                                                                                                                                                                                                |
|-----------------|----------------------------------------------------------------------------------------------------------------------------------------------------------------------------------------------------------------------------------------------------------------------------------------------------------------------------------------------------------------------------------------------------------------------------------------------------------------------------------------------------------------------------------------------------------------------------------------------------------------------------------------------------------------------------------------------------------------------------------------------------------------------------------------------------------------------------------------------------------------------------------------------------------------------------------------------------------------------------|
| Class Map       | <p>Class map to use for this traffic policy.</p> <p>From the Use Class Map field, do one of the following:</p> <ul style="list-style-type: none"> <li>• To use the default class map, choose <b>class-default</b>.<br/> <p>The class-default class map is a reserved, well-known class map created by the ACE. You cannot delete or modify this class. All traffic that fails to meet the other matching criteria in the named class map belongs to the default traffic class. If none of the specified classifications matches the traffic, then the ACE performs the action specified by the class-default class map. The class-default class map has an implicit <b>match any</b> statement that enables it to match all traffic.</p> </li> <li>• To use a previously created class map, do the following: <ol style="list-style-type: none"> <li>1. Choose <b>others</b>.</li> <li>2. In the Class Map Name field, choose the class map to use.</li> </ol> </li> </ul> |
| Match Condition | <p>Match condition to use for this traffic policy.</p> <p>Do the following:</p> <ol style="list-style-type: none"> <li>a. In the Match Condition field, enter a name for this match condition. Valid entries are unquoted text strings with no spaces and a maximum of 64 alphanumeric characters.</li> <li>b. In the Match Condition Type field, choose the type of match condition to use for this policy map and configure any type-specific options using the information in <a href="#">Table 7-10</a>.</li> </ol>                                                                                                                                                                                                                                                                                                                                                                                                                                                    |
| Insert Before   | <p>Order of the rules in the policy map.</p> <p>Do the following:</p> <ol style="list-style-type: none"> <li>a. Specify whether or not this rule is to precede another rule for this policy map: <ul style="list-style-type: none"> <li>– <b>N/A</b>—This option is not configured.</li> <li>– <b>False</b>—This rule is not to precede another rule in this policy map.</li> <li>– <b>True</b>—This rule is to precede another rule in this policy map. The Insert Before Policy Rule field appears.</li> </ul> </li> <li>b. If you chose True, in the Insert Before Policy Rule field, choose the rule that you want the current rule to precede.</li> </ol>                                                                                                                                                                                                                                                                                                             |

- Step 5** Do one of the following:
- Click **Deploy Now** to deploy this configuration on the ACE and save your entries to the running-configuration and startup-configuration files. The window refreshes and the Action table appears. Continue with [Step 6](#).
  - Click **Cancel** to exit this procedure without saving your entries and to return to the Rule table.
  - Click **Next** to deploy your entries and to add another rule.



---

**Note** If you chose the Insert Before option described in [Table 14-27](#) and specified True, perform the following steps to refresh the Rule tab before adding an action for this rule:

1. Click the Rule tab to refresh the Rule table.
2. In the Rule table, choose the newly added rule.

When the window refreshes, an empty action list appears.

---

- Step 6** In the Action table, click **Add** to add an entry or choose an existing entry to modify and click **Edit**.
- Step 7** In the Id field, either accept the automatically incremented entry or assign a unique identifier for this action.
- Step 8** In the Action Type field, choose the action to be taken for this rule:
- **Drop**—The SIP traffic is to be dropped if it meets the specified match criteria.
  - **Permit**—The SIP traffic is to be allowed if it meets the specified match criteria.
  - **Reset**—The SIP traffic is to be denied if it meets the specified match criteria. A TCP reset message is sent to the client or server to close the connection.
- Step 9** In the Action Log field, specify whether the action taken is to be logged:
- **N/A**—This option is not configured.
  - **False**—Dropped packets are not to be logged in the software.
  - **True**—Dropped packets are to be logged in the software.
- Step 10** Do one of the following:
- Click **Deploy Now** to deploy this configuration on the ACE and save your entries to the running-configuration and startup-configuration files.
  - Click **Cancel** to exit the procedure without saving your entries and to return to the Action table.
  - Click **Next** to deploy your entries and to configure another action.
- 

#### Related Topics

- [Configuring Traffic Policies, page 14-1](#)
- [Configuring Virtual Context Class Maps, page 14-6](#)
- [Configuring Virtual Context Policy Maps, page 14-32](#)
- [Configuring Rules and Actions for Policy Maps, page 14-34](#)

## Setting Policy Map Rules and Actions for Layer 7 Skinny Deep Packet Inspection

You can configure the rules and actions for a Skinny Client Control Protocol (SCCP) deep packet inspection policy map.

### Assumptions

This topic assumes the following:

- A Skinny deep packet inspection policy map has been configured.
- A class map has been defined for a class map rule if you do not want to use the class-default class map.

### Procedure

- 
- Step 1** Choose **Config > Devices > context > Expert > Policy Maps**.
- The Policy Maps table appears.
- Step 2** In the Policy Maps table, choose the Skinny deep packet inspection policy map that you want to set rules and actions for.
- The Rule table appears.
- Step 3** In the Rule table, click **Add** to add a new rule, or choose the rule you want to modify, then click **Edit**.
- The Rule window appears.
- Step 4** In the Type field of the Rule window, confirm that Match Condition is selected.
- Step 5** In the Match Condition Name field, enter a name for this match condition.
- Valid entries are unquoted text strings with no spaces and a maximum of 64 alphanumeric characters.
- Step 6** In the Match Condition Type field, confirm that Message ID is selected.
- Step 7** In the Message ID Operator field, specify whether or not the match criteria is for a single message identifier or for a range of message identifiers:
- **Equal To**—A single message identifier is used for this match condition.  
In the Message ID Value field, enter the numerical identifier of a SCCP message. Valid entries are from 0 to 65535.
  - **Range**—A range of message identifiers is used for this match condition.  
Do the following:
    - a. In the Message ID Low Range Value field, enter the lowest numerical identifier of a range of SCCP messages. Valid entries are from 0 to 65535.
    - b. In the Message ID High Range Value field, enter the highest numerical identifier of a range of SCCP messages. Valid entries are integers from 0 to 65535, and the value in this field must equal or be greater than the value in the Message ID Low Range Value field.
- Step 8** In the Insert Before field, specify whether or not this rule is to precede another rule in this policy map:
- **N/A**—This option is not configured.
  - **False**—This rule is not to precede another rule in this policy map.

- **True**—This rule is to precede another rule in this policy map. The Insert Before Policy Rule field appears.

**Step 9** If you chose True, in the Insert Before Policy Rule field, choose the rule that you want the current rule to precede.

**Step 10** Do one of the following:

- Click **Deploy Now** to deploy this configuration on the ACE and save your entries to the running-configuration and startup-configuration files. The window refreshes and the Action table appears. To define the actions for this rule, continue with [Step 11](#).
- Click **Cancel** to exit this procedure without saving your entries and to return to the Rule table.
- Click **Next** to deploy your entries and to configure another rule.



**Note** If you chose the Insert Before option in [Step 8](#) and specified True, perform the following steps to refresh the Rule tab before adding an action for this rule:

1. Click the Rule tab to refresh the Rule table.
2. In the Rule table, choose the newly added rule.

When the window refreshes, an empty action list appears.

**Step 11** In Action table, click **Add** to add a new action, or choose an existing action and click **Edit** to modify it. The Action configuration window appears.

**Step 12** In the ID field, accept the automatically incremented entry or assign a unique identifier for this action.

**Step 13** In the Action Type field, confirm that Reset is selected.

**Step 14** In the Action Log field, specify whether the action taken is to be logged:

- **N/A**—This option is not configured.
- **False**—Dropped packets are not to be logged in the software.
- **True**—Dropped packets are to be logged in the software.

**Step 15** Do one of the following:

- Click **Deploy Now** to deploy this configuration on the ACE and save your entries to the running-configuration and startup-configuration files.
- Click **Cancel** to exit the procedure without saving your entries and to return to the Action table.
- Click **Next** to deploy your entries and to configure another action.

#### Related Topics

- [Configuring Traffic Policies, page 14-1](#)
- [Configuring Virtual Context Class Maps, page 14-6](#)
- [Configuring Virtual Context Policy Maps, page 14-32](#)
- [Configuring Rules and Actions for Policy Maps, page 14-34](#)



## Setting Policy Map Rules and Actions for RADIUS Server Load Balancing

You can configure the rules and actions for RADIUS traffic received by the ACE.

### Assumptions

This topic assumes the following:

- A RADIUS server load balancing traffic policy map has been configured.
- A class map has been defined for a class map rule if you do not want to use the class-default class map.

### Procedure

- 
- Step 1** Choose **Config > Devices > context > Expert > Policy Maps**.  
The Policy Maps table appears.
- Step 2** In the Policy Maps table, choose the RADIUS server load balancing policy map that you want to set rules and actions for.  
The Rule table appears.
- Step 3** In the Rule table, click **Add** to add a new rule, or choose the rule you want to modify and click **Edit**.  
The Rule window appears.
- Step 4** In the Type field of the Rule window, configure rules using the information in [Table 14-28](#).

**Table 14-28** RADIUS Server Load Balancing Policy Map Rules

| Option    | Description                                                                                                                                                                                                                                                                                                                                                                                                                                                                                                                                                                                                                                                                                                                                                                                                                                                                                                                                                       |
|-----------|-------------------------------------------------------------------------------------------------------------------------------------------------------------------------------------------------------------------------------------------------------------------------------------------------------------------------------------------------------------------------------------------------------------------------------------------------------------------------------------------------------------------------------------------------------------------------------------------------------------------------------------------------------------------------------------------------------------------------------------------------------------------------------------------------------------------------------------------------------------------------------------------------------------------------------------------------------------------|
| Class Map | <p>Class map to use for this traffic policy.</p> <p>From the Use Class Map field, do one of the following:</p> <ul style="list-style-type: none"> <li>• To use the default class map, choose <b>class-default</b>.<br/>The class-default class map is a reserved, well-known class map created by the ACE. You cannot delete or modify this class. All traffic that fails to meet the other matching criteria in the named class map belongs to the default traffic class. If none of the specified classifications matches the traffic, then the ACE performs the action specified by the class-default class map. The class-default class map has an implicit <b>match any</b> statement that enables it to match all traffic.</li> <li>• To use a previously created class map, do the following: <ol style="list-style-type: none"> <li>1. Choose <b>others</b>.</li> <li>2. In the Class Map Name field, choose the class map to use.</li> </ol> </li> </ul> |

Table 14-28 RADIUS Server Load Balancing Policy Map Rules (continued)

| Option          | Description                                                                                                                                                                                                                                                                                                                                                                                                                                                                                                                                                                                                                                                                                                                                                                                                                                                                                                                                                                                                                                                                                                                                                                                                                             |
|-----------------|-----------------------------------------------------------------------------------------------------------------------------------------------------------------------------------------------------------------------------------------------------------------------------------------------------------------------------------------------------------------------------------------------------------------------------------------------------------------------------------------------------------------------------------------------------------------------------------------------------------------------------------------------------------------------------------------------------------------------------------------------------------------------------------------------------------------------------------------------------------------------------------------------------------------------------------------------------------------------------------------------------------------------------------------------------------------------------------------------------------------------------------------------------------------------------------------------------------------------------------------|
| Match Condition | <p>Match condition to use for this traffic policy.</p> <p>Do the following:</p> <ul style="list-style-type: none"> <li>a. In the Match Condition Name field, enter a name for this match condition. Valid entries are unquoted text strings with no spaces and a maximum of 64 alphanumeric characters.</li> <li>b. In the Match Condition Type field, choose the type of match condition to use for this policy map: <ul style="list-style-type: none"> <li>– <b>Calling Station ID</b>—A unique identifier of the calling station is used to establish a match condition. <p>In the RADIUS Calling Station ID field, enter the calling station identifier to match. Valid entries are strings containing 1 to 64 alphanumeric characters. See <a href="#">Table 14-33</a> for a list of the supported characters that you can use for matching string expressions.</p> </li> <li>– <b>User Name</b>—A username is used to establish a match condition. <p>In the User Name field, enter the name to match. Valid entries are strings containing 1 to 64 alphanumeric characters. See <a href="#">Table 14-33</a> for a list of the supported characters that you can use for matching string expressions.</p> </li> </ul> </li> </ul> |
| Insert Before   | <p>Order of the rules in the policy map.</p> <p>Do the following:</p> <ul style="list-style-type: none"> <li>a. Indicate whether this rule is to precede another rule for this policy map: <ul style="list-style-type: none"> <li>– <b>N/A</b>—This option is not configured.</li> <li>– <b>False</b>—This rule is not to precede another rule in this policy map.</li> <li>– <b>True</b>—This rule is to precede another rule in this policy map. The Insert Before Policy Rule field appears.</li> </ul> </li> <li>b. If you chose True, in the Insert Before Policy Rule field, choose the rule that you want the current rule to precede.</li> </ul>                                                                                                                                                                                                                                                                                                                                                                                                                                                                                                                                                                                |

- Step 5** Do one of the following:
- Click **Deploy Now** to deploy this configuration on the ACE and save your entries to the running-configuration and startup-configuration files. The window refreshes and the Action table appears. To enter actions for this rule, continue with [Step 6](#).
  - Click **Cancel** to exit this procedure without saving your entries and to return to the Rule table.
  - Click **Next** to deploy your entries and to configure another rule.



**Note** If you chose the Insert Before option described in [Table 14-28](#) and specified True, perform the following steps to refresh the Rule tab before adding an action for this rule:

1. Click the Rule tab to refresh the Rule table.
2. In the Rule table, choose the newly added rule.

When the window refreshes, an empty action list appears.

- Step 6** In the Action table, click **Add** to add an entry or choose an existing entry to modify and click **Edit**.

- Step 7** In the Id field, accept the automatically incremented entry or assign a unique identifier for this action.
- Step 8** In the Action Type field, configure actions for this rule using the information in [Table 14-17](#).
- Step 9** Do one of the following:
- Click **Deploy Now** to deploy this configuration on the ACE and save your entries to the running-configuration and startup-configuration files.
  - Click **Cancel** to exit the procedure without saving your entries and to return to the Action table.
  - Click **Next** to deploy your entries and to configure another action.
- 

#### Related Topics

- [Configuring Traffic Policies, page 14-1](#)
- [Configuring Virtual Context Class Maps, page 14-6](#)
- [Configuring Virtual Context Policy Maps, page 14-32](#)
- [Configuring Rules and Actions for Policy Maps, page 14-34](#)

## Setting Policy Map Rules and Actions for RDP Server Load Balancing

Use this procedure to configure the rules and actions for RDP traffic received by the ACE.

#### Assumptions

This topic assumes the following:

- An RDP server load balancing traffic policy map has been configured.
- A class map has been defined for a class map rule if you do not want to use the class-default class map.

#### Procedure

---

- Step 1** Choose **Config > Devices > context > Expert > Policy Maps**.  
The Policy Maps table appears.
- Step 2** In the Policy Maps table, choose the RDP server load balancing policy map that you want to set rules and actions for.  
The Rule table appears.
- Step 3** In the Rule table, click **Add** to add a new rule.  
The Rule window appears.
- Step 4** In the Type field of the Rule window, confirm that Class Map is selected.
- Step 5** Check the Use Class Default check box.



**Note** You can only use the default class map (Class Default) with an RDP server load balancing policy map.

---

The class-default class map is a reserved, well-known class map created by the ACE. You cannot delete or modify this class. The class-default class map has an implicit **match any** statement that enables it to match all traffic.

- Step 6** Do one of the following:
- Click **Deploy Now** to deploy this configuration on the ACE and save your entries to the running-configuration and startup-configuration files. The window refreshes and the Action table appears. To enter actions for this rule, continue with [Step 7](#).
  - Click **Cancel** to exit this procedure without saving your entries and to return to the Rule table.
  - Click **Next** to deploy your entries and to configure another rule.
- Step 7** In the Action table, click **Add** to add an entry, or choose an existing entry to modify and click **Edit**.
- Step 8** In the Id field, accept the automatically incremented entry or assign a unique identifier for this action.
- Step 9** In the Action Type field, configure actions for this rule using the information in [Table 14-17](#).
- Step 10** Do one of the following:
- Click **Deploy Now** to deploy this configuration on the ACE and save your entries to the running-configuration and startup-configuration files.
  - Click **Cancel** to exit the procedure without saving your entries and to return to the Action table.
  - Click **Next** to deploy your entries and to configure another action.

---

#### Related Topics

- [Configuring Traffic Policies, page 14-1](#)
- [Configuring Virtual Context Class Maps, page 14-6](#)
- [Configuring Virtual Context Policy Maps, page 14-32](#)
- [Configuring Rules and Actions for Policy Maps, page 14-34](#)

## Setting Policy Map Rules and Actions for RTSP Server Load Balancing

You can configure the rules and actions for RTSP traffic received by the ACE.

#### Assumptions

This topic assumes the following:

- An RTSP server load balancing traffic policy map has been configured.
- A class map has been defined for a class map rule if you do not want to use the class-default class map.

#### Procedure

- 
- Step 1** Choose **Config > Devices > context > Expert > Policy Maps**.
- The Policy Maps table appears.
- Step 2** In the Policy Maps table, choose the RTSP server load balancing policy map that you want to set rules and actions for.
- The Rule table appears.

- Step 3** In the Rule table, click **Add** to add a new rule, or choose the rule that you want to modify and click **Edit**. The Rule window appears.
- Step 4** In the Type field of the Rule window, configure rules using the information in [Table 14-29](#).

**Table 14-29** RTSP Server Load Balancing Policy Map Rules

| Option          | Description                                                                                                                                                                                                                                                                                                                                                                                                                                                                                                                                                                                                                                                                                                                                                                                                                                                                                                                                                                                                                 |
|-----------------|-----------------------------------------------------------------------------------------------------------------------------------------------------------------------------------------------------------------------------------------------------------------------------------------------------------------------------------------------------------------------------------------------------------------------------------------------------------------------------------------------------------------------------------------------------------------------------------------------------------------------------------------------------------------------------------------------------------------------------------------------------------------------------------------------------------------------------------------------------------------------------------------------------------------------------------------------------------------------------------------------------------------------------|
| Class Map       | <p>Class map to use for this traffic policy.</p> <p>From the Use Class Map field, do one of the following:</p> <ul style="list-style-type: none"> <li>• To use the default class map, choose <b>class-default</b>.</li> </ul> <p>The class-default class map is a reserved, well-known class map created by the ACE. You cannot delete or modify this class. All traffic that fails to meet the other matching criteria in the named class map belongs to the default traffic class. If none of the specified classifications matches the traffic, then the ACE performs the action specified by the class-default class map. The class-default class map has an implicit <b>match any</b> statement that enables it to match all traffic.</p> <ul style="list-style-type: none"> <li>• To use a previously created class map, do the following:               <ol style="list-style-type: none"> <li>1. Choose <b>others</b>.</li> <li>2. In the Class Map Name field, choose the class map to use.</li> </ol> </li> </ul> |
| Match Condition | <p>Match condition to use for this traffic policy.</p> <p>Do the following:</p> <ol style="list-style-type: none"> <li>a. In the Match Condition Name field, enter a name for this match condition. Valid entries are unquoted text strings with no spaces and a maximum of 64 alphanumeric characters.</li> <li>b. In the Match Condition Type field, choose the type of match condition to use for this policy map and configure any type-specific options using the information in <a href="#">Table 14-30</a>.</li> </ol> <p> <b>Note</b> Fields and information related to IPv6 require ACE module and ACE appliance software Version A5(1.0) or later.</p>                                                                                                                                                                                                                                                                         |
| Insert Before   | <p>Order of the rules in the policy map.</p> <p>Do the following:</p> <ol style="list-style-type: none"> <li>a. Indicate whether or not this rule is to precede another rule for this policy map by choosing one of the following options:               <ul style="list-style-type: none"> <li>– <b>N/A</b>—This option is not configured.</li> <li>– <b>False</b>—This rule is not to precede another rule in this policy map.</li> <li>– <b>True</b>—This rule is to precede another rule in this policy map. The Insert Before Policy Rule field appears.</li> </ul> </li> <li>b. If you chose True, in the Insert Before Policy Rule field, choose the rule that you want the current rule to precede.</li> </ol>                                                                                                                                                                                                                                                                                                      |

Table 14-30 RTSP Policy Map Match Conditions

| Match Condition | Description                                                                                                                                                                                                                                                                                                                                                                                                                                                                                                                                                                                                                                                                                                                                                                                                                                                                                                                                                                                                                                                                                                                                                                                             |
|-----------------|---------------------------------------------------------------------------------------------------------------------------------------------------------------------------------------------------------------------------------------------------------------------------------------------------------------------------------------------------------------------------------------------------------------------------------------------------------------------------------------------------------------------------------------------------------------------------------------------------------------------------------------------------------------------------------------------------------------------------------------------------------------------------------------------------------------------------------------------------------------------------------------------------------------------------------------------------------------------------------------------------------------------------------------------------------------------------------------------------------------------------------------------------------------------------------------------------------|
| RTSP Header     | <p>RTSP header information that is used for matching criteria.</p> <p>Do the following:</p> <ol style="list-style-type: none"> <li>a. In the Header Name field, specify the header to match in one of the following ways: <ul style="list-style-type: none"> <li>– To specify an RTSP header that is not one of the standard RTSP headers, choose the first radio button, then enter the RTSP header name in the Header Name field. Valid entries are unquoted text strings with no spaces and a maximum of 64 characters.</li> <li>– To specify a standard RTSP header, click the second radio button, then choose an RTSP header from the list.</li> </ul> </li> <li>b. In the Header Value (Bytes) field, enter the header value expression string to compare against the value in the specified field in the RTSP header. Valid entries are text strings with a maximum of 255 alphanumeric characters. The ACE supports regular expressions for matching. If the string includes spaces, enclose the string with quotes. All headers in the header map must be matched. See <a href="#">Table 14-33</a> for a list of the supported characters that you can use in regular expressions.</li> </ol> |
| RTSP URL        | <p>URL or portion of a URL that is used for match criteria.</p> <p>Do the following:</p> <ol style="list-style-type: none"> <li>a. In the URL Expr field, enter a URL, or portion of a URL, to match. The ACE performs matching on whatever URL string appears after the RTSP method, regardless of whether the URL includes the host name. The ACE supports regular expressions for matching URL strings. See <a href="#">Table 14-33</a> for a list of the supported characters that you can use in regular expressions.</li> <li>b. In the Method Expr field, enter the RTSP method to match. Valid entries are unquoted text strings with no spaces and a maximum of 64 alphanumeric characters. The method can be either one of the standard RTSP method names (DESCRIBE, ANNOUNCE, GET_PARAMETER, OPTIONS, PAUSE, PLAY, RECORD, REDIRECT, SETUP, SET_PARAMETER, TEARDOWN) or a text string that must be matched exactly (for example, STINGRAY).</li> </ol>                                                                                                                                                                                                                                       |
| Source Address  | <p>Source IP address that is used for match criteria.</p> <p>Do the following:</p> <ol style="list-style-type: none"> <li>a. In the IP Address Type field, choose either <b>IPv4</b> or <b>IPv6</b>. This field appears only for ACE module and ACE appliance software Version A5(1.0) or later, which supports IPv4 and IPv6.</li> <li>b. In the Source Address field, enter the source IP address for this match condition in the format based on the address type (IPv4 or IPv6).</li> <li>c. Depending of the IP address type that you chose, do one of the following: <ul style="list-style-type: none"> <li>– For IPv4, In the Source Netmask field, choose the subnet mask for the source IP address.</li> <li>– For IPv6, in the Source Prefix-length field, enter the prefix length for the address.</li> </ul> </li> </ol>                                                                                                                                                                                                                                                                                                                                                                    |

- Step 5** In the Insert Before field, indicate whether or not this rule is to precede another rule for this policy map:
- **N/A**—This option is not configured.
  - **False**—This rule is not to precede another rule in this policy map.

- **True**—This rule is to precede another rule in this policy map. The Insert Before Policy Rule field appears.

If you chose True, in the Insert Before Policy Rule field, choose the rule that you want the current rule to precede.

**Step 6** Do one of the following:

- Click **Deploy Now** to deploy this configuration on the ACE and save your entries to the running-configuration and startup-configuration files. The window refreshes and the Action table appears. Continue with [Step 7](#).
- Click **Cancel** to exit this procedure without saving your entries and to return to the Rule table.
- Click **Next** to deploy your entries and to add another rule.



**Note** If you chose the Insert Before option in [Table 14-30](#) and specified True, perform the following steps to refresh the Rule tab before adding an action for this rule:

1. Click the Rule tab to refresh the Rule table.
2. In the Rule table, choose the newly added rule.

When the window refreshes, an empty action list appears.

**Step 7** In the Action table, click **Add** to add an entry, or choose an existing entry to modify and click **Edit**.

**Step 8** In the Id field, accept the automatically incremented entry or assign a unique identifier for this action.

**Step 9** In the Action Type field, configure actions for this rule using the information in [Table 14-17](#).

**Step 10** Do one of the following:

- Click **Deploy Now** to deploy this configuration on the ACE and save your entries to the running-configuration and startup-configuration files.
- Click **Cancel** to exit the procedure without saving your entries and to return to the Action table.
- Click **Next** to deploy your entries and to configure another action.

#### Related Topics

- [Configuring Traffic Policies, page 14-1](#)
- [Configuring Virtual Context Class Maps, page 14-6](#)
- [Configuring Virtual Context Policy Maps, page 14-32](#)
- [Configuring Rules and Actions for Policy Maps, page 14-34](#)

## Setting Policy Map Rules and Actions for SIP Server Load Balancing

You can configure the rules and actions for SIP traffic received by the ACE.

#### Assumptions

This topic assumes the following:

- A SIP server load balancing traffic policy map has been configured.
- A class map has been defined for a class map rule if you do not want to use the class-default class map.

### Procedure

- 
- Step 1** Choose **Config > Devices > context > Expert > Policy Maps**.  
The Policy Maps table appears.
- Step 2** In the Policy Maps table, choose the SIP server load balancing policy map that you want to set rules and actions for.  
The Rule table appears.
- Step 3** In the Rule table, click **Add** to add a new rule, or choose the rule that you want to modify and click **Edit**.  
The Rule window appears.
- Step 4** In the Type field of the Rule window, configure rules using the information in [Table 14-31](#).

**Table 14-31 SIP Server Load Balancing Policy Map Rules**

| Option    | Description                                                                                                                                                                                                                                                                                                                                                                                                                                                                                                                                                                                                                                                                                                                                                                                                                                                                                                                                                                                                   |
|-----------|---------------------------------------------------------------------------------------------------------------------------------------------------------------------------------------------------------------------------------------------------------------------------------------------------------------------------------------------------------------------------------------------------------------------------------------------------------------------------------------------------------------------------------------------------------------------------------------------------------------------------------------------------------------------------------------------------------------------------------------------------------------------------------------------------------------------------------------------------------------------------------------------------------------------------------------------------------------------------------------------------------------|
| Class Map | <p>Class map to use for this traffic policy.</p> <p>From the Use Class Map field, do one of the following:</p> <ul style="list-style-type: none"> <li>• To use the default class map, choose <b>class-default</b>.</li> </ul> <p>The class-default class map is a reserved, well-known class map created by the ACE. You cannot delete or modify this class. All traffic that fails to meet the other matching criteria in the named class map belongs to the default traffic class. If none of the specified classifications matches the traffic, then the ACE performs the action specified by the class-default class map. The class-default class map has an implicit <b>match any</b> statement that enables it to match all traffic.</p> <ul style="list-style-type: none"> <li>• To use a previously created class map, do the following: <ol style="list-style-type: none"> <li>1. Choose <b>others</b>.</li> <li>2. In the Class Map Name field, choose the class map to use.</li> </ol> </li> </ul> |



**Table 14-31 SIP Server Load Balancing Policy Map Rules (continued)**

| Option          | Description                                                                                                                                                                                                                                                                                                                                                                                                                                                                                                                                                                                                                                                                                                                                                                                                                                 |
|-----------------|---------------------------------------------------------------------------------------------------------------------------------------------------------------------------------------------------------------------------------------------------------------------------------------------------------------------------------------------------------------------------------------------------------------------------------------------------------------------------------------------------------------------------------------------------------------------------------------------------------------------------------------------------------------------------------------------------------------------------------------------------------------------------------------------------------------------------------------------|
| Match Condition | <p>Match condition to use for this traffic policy.</p> <p>Do the following:</p> <ol style="list-style-type: none"> <li data-bbox="391 407 1511 470">a. In the Match Condition field, enter a name for this match condition. Valid entries are unquoted text strings with no spaces and a maximum of 64 alphanumeric characters.</li> <li data-bbox="391 485 1511 548">b. In the Match Condition Type field, choose the type of match condition to use for this policy map and configure any type-specific options using the information in <a href="#">Table 14-32</a>.</li> </ol> <p> <b>Note</b> Fields and information related to IPv6 require ACE module and ACE appliance software Version A5(1.0) or later.</p>                                      |
| Insert Before   | <p>Order of the rules in the policy map.</p> <p>Do the following:</p> <ol style="list-style-type: none"> <li data-bbox="391 785 1511 1010">a. Indicate whether or not this rule is to precede another rule for this policy map. Choices are as follows: <ul style="list-style-type: none"> <li data-bbox="444 856 886 888">– <b>N/A</b>—This option is not configured.</li> <li data-bbox="444 905 1214 936">– <b>False</b>—This rule is not to precede another rule in this policy map.</li> <li data-bbox="444 953 1511 1010">– <b>True</b>—This rule is to precede another rule in this policy map. The Insert Before Policy Rule field appears.</li> </ul> </li> <li data-bbox="391 1026 1511 1083">b. If you chose True, in the Insert Before Policy Rule field, choose the rule that you want the current rule to precede.</li> </ol> |

**Table 14-32 SIP Server Load Balancing Policy Map Match Conditions**

| Match Condition | Description                                                                                                                                                                                                                                                                                                                                                                                                                                                                                                                                                                                                                                                                                                                                                                                                                                                                                                                                                                                                                                                                                                                                                                                     |
|-----------------|-------------------------------------------------------------------------------------------------------------------------------------------------------------------------------------------------------------------------------------------------------------------------------------------------------------------------------------------------------------------------------------------------------------------------------------------------------------------------------------------------------------------------------------------------------------------------------------------------------------------------------------------------------------------------------------------------------------------------------------------------------------------------------------------------------------------------------------------------------------------------------------------------------------------------------------------------------------------------------------------------------------------------------------------------------------------------------------------------------------------------------------------------------------------------------------------------|
| SIP Header      | <p>SIP header information that is used for matching criteria.</p> <p>Do the following:</p> <ol style="list-style-type: none"> <li>a. In the Header Name field, specify the header to match in one of the following ways: <ul style="list-style-type: none"> <li>– To specify a SIP header that is not one of the standard SIP headers, choose the first radio button, then enter the SIP header name in the Header Name field. Valid entries are unquoted text strings with no spaces and a maximum of 64 characters.</li> <li>– To specify a standard SIP header, click the second radio button, then choose an SIP header from the list.</li> </ul> </li> <li>b. In the Header Value (Bytes) field, enter the header value expression string to compare against the value in the specified field in the SIP header. Valid entries are text strings with a maximum of 255 alphanumeric characters. The ACE supports regular expressions for matching. If the string includes spaces, enclose the string with quotes. All headers in the header map must be matched. See <a href="#">Table 14-33</a> for a list of the supported characters that you can use in regular expressions.</li> </ol> |
| Source Address  | <p>Source IP address is used for match criteria.</p> <p>Do the following:</p> <ol style="list-style-type: none"> <li>a. In the IP Address Type field, choose either <b>IPv4</b> or <b>IPv6</b>. This field appears only for ACE module and ACE appliance software Version A5(1.0) or later, which supports IPv4 and IPv6.</li> <li>b. In the Source Address field, enter the source IP address for this match condition in the format based on the address type (IPv4 or IPv6).</li> <li>c. Depending on the IP address type that you chose, do one of the following: <ul style="list-style-type: none"> <li>– For IPv4, in the Source Netmask field, choose the subnet mask for the source IP address.</li> <li>– For IPv6, in the Source Prefix-length field, enter the prefix length for the address.</li> </ul> </li> </ol>                                                                                                                                                                                                                                                                                                                                                                 |

- Step 5** Do one of the following:
- Click **Deploy Now** to deploy this configuration on the ACE and save your entries to the running-configuration and startup-configuration files. The window refreshes and the Action table appears so you can enter actions for this rule. Continue with [Step 6](#).
  - Click **Cancel** to exit this procedure without saving your entries and to return to the Rule table.
  - Click **Next** to deploy your entries and to add another rule.
- Step 6** In the Action table, click **Add** to add an entry, or choose an existing entry to modify and click **Edit**.
- Step 7** In the Id field, accept the automatically incremented entry or assign a unique identifier for this action.
- Step 8** In the Action Type field, configure actions for this rule using the information in [Table 14-17](#).

**Step 9** Do one of the following:

- Click **Deploy Now** to deploy this configuration on the ACE and save your entries to the running-configuration and startup-configuration files.
- Click **Cancel** to exit the procedure without saving your entries and to return to the Action table.
- Click **Next** to deploy your entries and to configure another action.



---

**Note** If you chose the Insert Before option in [Table 14-31](#) and specified True, perform the following steps to refresh the Rule tab before adding an action for this rule:

1. Click the Rule tab to refresh the Rule table.
2. In the Rule table, choose the newly added rule.

When the window refreshes, an empty action list appears.

---

#### Related Topics

- [Configuring Traffic Policies, page 14-1](#)
- [Configuring Virtual Context Class Maps, page 14-6](#)
- [Configuring Virtual Context Policy Maps, page 14-32](#)
- [Configuring Rules and Actions for Policy Maps, page 14-34](#)

## Special Characters for Matching String Expressions

Table 14-33 identifies the special characters that can be used in matching string expressions.

**Table 14-33** Special Characters for Matching String Expressions

| Convention    | Description                                                                         |
|---------------|-------------------------------------------------------------------------------------|
| .             | One of any character.                                                               |
| .*            | Zero or more of any character.                                                      |
| \.            | Period (escaped).                                                                   |
| \xhh          | Non-printable character.                                                            |
| [charset]     | Match any single character from the range.                                          |
| [^charset]    | Do not match any character in the range. All other characters represent themselves. |
| ()            | Expression grouping.                                                                |
| expr1   expr2 | OR of expressions.                                                                  |
| (expr)*       | 0 or more of expression.                                                            |
| (expr)+       | 1 or more of expression.                                                            |
| .\a           | Alert (ASCII 7).                                                                    |
| .\b           | Backspace (ASCII 8).                                                                |
| .\f           | Form-feed (ASCII 12).                                                               |
| .\n           | New line (ASCII 10).                                                                |
| .\r           | Carriage return (ASCII 13).                                                         |
| .\t           | Tab (ASCII 9).                                                                      |
| .\v           | Vertical tab (ASCII 11).                                                            |
| .\0           | Null (ASCII 0).                                                                     |
| .\            | Backslash.                                                                          |
| .\x##         | Any ASCII character as specified in two-digit hexadecimal notation.                 |

### Related Topics

- [Configuring Traffic Policies, page 14-1](#)
- [Configuring Virtual Context Class Maps, page 14-6](#)
- [Configuring Virtual Context Policy Maps, page 14-32](#)
- [Configuring Rules and Actions for Policy Maps, page 14-34](#)

# Configuring Actions Lists

An action list is a named group of actions that you associate with a Layer 7 policy map. The ACE supports the following types action lists:

- An HTTP optimization action list groups a series of individual application acceleration and optimization operations that you want the ACE to perform. The HTTP optimization action list is associated with a Layer 7 HTTP optimization policy map (see the [“Setting Policy Map Rules and Actions for Layer 7 HTTP Optimization”](#) section on page 14-57).
- An HTTP header modify action list performs the following operations:
  - Groups a series of individual functions to insert, rewrite, or delete HTTP headers.
  - Configures the SSL URL rewrite function.
  - Inserts SSL session parameters, client certificate fields, and server certificate fields into the HTTP requests that the ACE receives over the connection.

The HTTP header action list is associated with a Layer 7 server load-balancing policy map (see the [“Setting Policy Map Rules and Actions for Layer 7 Server Load-Balancing Traffic”](#) section on page 14-61).

Table 14-34 lists the action lists that you can configure using the ACE.

**Table 14-34 Action Lists**

| Action List                    | Topic                                                                     |
|--------------------------------|---------------------------------------------------------------------------|
| Optimization Action List       | <a href="#">Configuring an HTTP Optimization Action List, page 15-3</a>   |
| HTTP Header Modify Action List | <a href="#">Configuring an HTTP Header Modify Action List, page 14-85</a> |

## Configuring an HTTP Header Modify Action List

An HTTP header modify action list groups a series of individual functions to insert, rewrite, or delete HTTP headers. It can also be used to configure the SSL URL rewrite function.

This section includes the following topics:

- [Configuring HTTP Header Insertion, Deletion, and Rewrite, page 14-85](#)
- [Configuring SSL URL Rewrite, page 14-88](#)
- [Configuring SSL Header Insertion, page 14-89](#)

## Configuring HTTP Header Insertion, Deletion, and Rewrite

You can configure an HTTP header modify action list that inserts, rewrites, or deletes HTTP headers.

### Procedure

- 
- Step 1** Choose **Config > Devices > context > Expert > HTTP Header Modify Action Lists**.
- The HTTP Header Modify Action Lists table appears.
- Step 2** In the HTTP Header Modify Action Lists table, click **Add** to add a new action list, or choose an existing action list and click **Edit** to modify it.

- Step 3** For a new action list, in the Action List Name field, enter a unique name for the action list. Valid entries are unquoted text strings with a maximum of 64 alphanumeric characters. Click **Deploy Now** when completed to save the configuration and display the editing tabs.
- Step 4** Click the **Header Action** tab.  
The Header Action table appears.
- Step 5** In the Header Action table, click **Add** to add a new entry to the table.  
The Header Action configuration window appears. Enter the required information as shown in [Table 14-35](#).

**Table 14-35 Header Action Configuration Window Fields**

| Header Action Field | Description / Action                                                                                                                                                                                                                                                                                                                                                                                                                                                                                                                                                                                                                                                                                                                                                                                                                                                                                                                                             |
|---------------------|------------------------------------------------------------------------------------------------------------------------------------------------------------------------------------------------------------------------------------------------------------------------------------------------------------------------------------------------------------------------------------------------------------------------------------------------------------------------------------------------------------------------------------------------------------------------------------------------------------------------------------------------------------------------------------------------------------------------------------------------------------------------------------------------------------------------------------------------------------------------------------------------------------------------------------------------------------------|
| Operator            | <p>HTTP header modify action that the ACE is to take in an HTTP request from a client, a response from a server, or both. Choices are as follows:</p> <ul style="list-style-type: none"> <li>• <b>Delete</b>—Deletes an HTTP header in a request from a client, in a response from a server, or both.</li> <li>• <b>Insert</b>—Insert a header name and value in an HTTP request from a client, a response from a server, or both. When the ACE uses Network Address Translation (NAT) to translate the source IP address of a client to a VIP, servers need a way to identify that client for the TCP and IP return traffic. To identify a client whose source IP address has been translated using NAT, you can instruct the ACE to insert a generic header and string value of your choice in the client HTTP request.</li> <li>• <b>Rewrite</b>—Rewrite an HTTP header in request packets from a client, response packets from a server, or both.</li> </ul> |

Table 14-35 Header Action Configuration Window Fields (continued)

| Header Action Field | Description / Action                                                                                                                                                                                                                                                                                                                                                                                                                                                                                                                                                                                                                                                                                                                                                                                                                                                                                                                                                                                                                                                                                                                                                                                                                                                                                                                                                                                                                                  |
|---------------------|-------------------------------------------------------------------------------------------------------------------------------------------------------------------------------------------------------------------------------------------------------------------------------------------------------------------------------------------------------------------------------------------------------------------------------------------------------------------------------------------------------------------------------------------------------------------------------------------------------------------------------------------------------------------------------------------------------------------------------------------------------------------------------------------------------------------------------------------------------------------------------------------------------------------------------------------------------------------------------------------------------------------------------------------------------------------------------------------------------------------------------------------------------------------------------------------------------------------------------------------------------------------------------------------------------------------------------------------------------------------------------------------------------------------------------------------------------|
| Direction           | <p>HTTP header modify action that the ACE is to take with respect to the selected operator (Insert, Delete, or Rewrite). Choices are as follows:</p> <p><b>Insert:</b></p> <ul style="list-style-type: none"> <li>• <b>Both</b>—Specifies that the ACE insert an HTTP header in both HTTP request packets and response packets.</li> <li>• <b>Request</b>—Specifies that the ACE insert an HTTP header only in HTTP request packets from clients.</li> <li>• <b>Response</b>—Specifies that the ACE insert an HTTP header only in HTTP response packets from servers.</li> </ul> <p><b>Delete:</b></p> <ul style="list-style-type: none"> <li>• <b>Both</b>—Specifies that the ACE delete the header in both HTTP request packets and response packets.</li> <li>• <b>Request</b>—Specifies that the ACE delete the header only in HTTP request packets from clients.</li> <li>• <b>Response</b>—Specifies that the ACE delete the header only in HTTP response packets from servers.</li> </ul> <p><b>Rewrite:</b></p> <ul style="list-style-type: none"> <li>• <b>Both</b>—Specifies that the ACE rewrite an HTTP header string in both HTTP request packets and response packets.</li> <li>• <b>Request</b>—Specifies that the ACE rewrite an HTTP header string only in HTTP request packets from clients.</li> <li>• <b>Response</b>—Specifies that the ACE rewrite an HTTP header string only in HTTP response packets from servers.</li> </ul> |
| Header Name         | Identifier of an HTTP header. Enter an unquoted text string with a maximum of 255 alphanumeric characters.                                                                                                                                                                                                                                                                                                                                                                                                                                                                                                                                                                                                                                                                                                                                                                                                                                                                                                                                                                                                                                                                                                                                                                                                                                                                                                                                            |
| Header Value        | <p>Value of the HTTP header that you want to insert or replace in request packets, response packets, or both. Enter an unquoted text string with no spaces and a maximum of 255 alphanumeric characters. You can also use the following dynamic replacement strings:</p> <ul style="list-style-type: none"> <li>• <b>%is</b>—Inserts the source IP address in the HTTP header</li> <li>• <b>%id</b>—Inserts the destination IP address in the HTTP header</li> <li>• <b>%ps</b>—Inserts the source port in the HTTP header</li> <li>• <b>%pd</b>—Inserts the destination port in the HTTP header</li> </ul> <p>The ACE supports regular expressions for matching. To include spaces in the string, enclose the entire string in quotes. All headers in the header map must be matched. See <a href="#">Table 14-33</a> for a list of the supported characters that you can use in regular expressions.</p>                                                                                                                                                                                                                                                                                                                                                                                                                                                                                                                                            |
| Replace             | Pattern string that you want to substitute for the header value regular expression. For dynamic replacement of the first and second parenthesized expressions from the header value, use %1 and %2, respectively.                                                                                                                                                                                                                                                                                                                                                                                                                                                                                                                                                                                                                                                                                                                                                                                                                                                                                                                                                                                                                                                                                                                                                                                                                                     |

- Step 6** Do one of the following:
- Click **Deploy Now** to deploy this configuration on the ACE and save your entries to the running-configuration and startup-configuration files.
  - Click **Cancel** to exit this procedure without saving your entries.
  - Click **Next** to save your entries.

---

### Related Topics

[Setting Policy Map Rules and Actions for Layer 7 Server Load-Balancing Traffic, page 14-61, Table 14-26](#)

## Configuring SSL URL Rewrite

You can configure an HTTP header modify action list that performs SSL URL rewrite.

When a client sends encrypted traffic to the ACE in an SSL termination configuration, the ACE terminates the SSL traffic and then sends clear text to the server. Because the server is unaware of the encrypted traffic flowing between the client and the ACE, the server may return to the client a URL in the Location header of HTTP redirect responses (301: Moved Permanently or 302: Found) in the form `http://www.cisco.com` instead of `https://www.cisco.com`. In this case, the client makes a request to the unencrypted insecure URL, even though the original request was for a secure URL. Because the client connection changes to HTTP, the requested data may not be available from the server using a clear text connection.

To solve this problem, the ACE provides SSLURL rewrite, which changes the redirect URL from `http://` to `https://` in the Location response header from the server before sending the response to the client. By using URL rewrite, you can avoid nonsecure HTTP redirects. All client connections to the web server will be SSL, ensuring the secure delivery of HTTPS content back to the client. The ACE uses regular expression matching to determine whether the URL needs rewriting. If a Location response header matches the specified regular expression, the ACE rewrites the URL. In addition, the ACE provides parameters to add or change the SSL and the clear port numbers.

### Procedure

- 
- Step 1** Choose **Config > Devices > context > Expert > HTTP Header Modify Action Lists**.  
The HTTP Header Modify Action Lists table appears.
- Step 2** In the HTTP Header Modify Action Lists table, click **Add** to add a new action list, or choose an existing action list and click **Edit** to modify it.
- Step 3** For a new action list, in the Action List Name field enter a unique name for the action list.  
Valid entries are unquoted text strings with a maximum of 64 alphanumeric characters. Click **Deploy Now** when completed to save the configuration and display the editing tabs.
- Step 4** Click the **SSL Action** tab.  
The SSL Action table appears.
- Step 5** In the SSL Action table, click **Add** to add a new entry to the SSL Action table.  
The SSL Action configuration window appears. Enter the required information as shown in [Table 14-36](#).



**Table 14-36** SSL Action Configuration Window Fields

| Header Action Field | Description / Action                                                                                                                                                                                                                                                                                                                                                                                                                                                                                                                                                                                                                                                                                                                                                                                                                                                                                                                                                                                                                                                                                                                                                                                                                                                       |
|---------------------|----------------------------------------------------------------------------------------------------------------------------------------------------------------------------------------------------------------------------------------------------------------------------------------------------------------------------------------------------------------------------------------------------------------------------------------------------------------------------------------------------------------------------------------------------------------------------------------------------------------------------------------------------------------------------------------------------------------------------------------------------------------------------------------------------------------------------------------------------------------------------------------------------------------------------------------------------------------------------------------------------------------------------------------------------------------------------------------------------------------------------------------------------------------------------------------------------------------------------------------------------------------------------|
| URL Expression      | <p>Field that specifies the rewriting of the URL in the Location response header based on a URL regular expression match. If the URL in the Location header matches the URL regular expression string that you specify, the ACE rewrites the URL from http:// to https:// and rewrites the port number. Enter an unquoted text string with no spaces and a maximum of 255 alphanumeric characters. Alternatively, you can enter a text string with spaces if you enclose the entire string in quotation marks (“”).</p> <p>The location regex that you enter must be a pure URL (for example, www\.cisco\.com) with no port or path designations. To match a port, use the SSL Port and Clear Port parameters. If you need to match a path, use the HTTP header rewrite feature to rewrite the string. For information about the HTTP header rewrite feature, see the <a href="#">“Configuring HTTP Header Insertion, Deletion, and Rewrite” section on page 14-85</a>.</p> <p>The ACE supports regular expressions for matching. To include spaces in the string, enclose the entire string in quotes. All headers in the header map must be matched. See <a href="#">Table 14-33</a> for a list of the supported characters that you can use in regular expressions.</p> |
| SSL Port            | SSL port number from which the ACE translates a clear port number before sending the server redirect response to the client. Enter a value from 1 to 65535. The default is 443.                                                                                                                                                                                                                                                                                                                                                                                                                                                                                                                                                                                                                                                                                                                                                                                                                                                                                                                                                                                                                                                                                            |
| Clear Port          | Clear port number to which the ACE translates the SSL port number before sending a server redirect response to the client. Enter a value from 1 to 65535. The default is 80.                                                                                                                                                                                                                                                                                                                                                                                                                                                                                                                                                                                                                                                                                                                                                                                                                                                                                                                                                                                                                                                                                               |

**Step 6** Do one of the following:

- Click **Deploy Now** to deploy this configuration on the ACE and save your entries to the running-configuration and startup-configuration files.
- Click **Cancel** to exit this procedure without saving your entries.
- Click **Next** to save your entries.

**Related Topics**

- [Setting Policy Map Rules and Actions for Layer 7 Server Load-Balancing Traffic, page 14-61, Table 14-26](#)

## Configuring SSL Header Insertion

**Note**

This option is available only for the ACE module A2(3.0), ACE appliance A4(1.0), and later releases of either device type.

You can configure an HTTP header modify action list that performs SSL header insertion.

When a client sends encrypted traffic to the ACE in an SSL termination configuration, the ACE terminates the SSL traffic and then sends clear text to the server, which is unaware of the encrypted traffic flowing between the client and the ACE. Using an action list associated with a Layer 7 HTTP load-balancing policy map, you can instruct the ACE to perform SSL HTTP header insertion. The ACE provides the server with the following SSL session information by inserting HTTP headers into the HTTP requests that it receives over the connection:

- **Session Parameters**—SSL session parameters that the ACE and client negotiate during the SSL handshake.
- **Server Certificate Fields**—Information regarding the SSL server certificate that resides on the ACE.
- **Client Certificate Fields**—Information regarding the SSL client certificate that the ACE retrieves from the client when you configure the ACE to perform client authentication.

**Note**

To prevent HTTP header spoofing, the ACE deletes any incoming HTTP headers that match one of the headers that it is going to insert into the HTTP request.

By default, the ACE inserts the SSL header information into the first HTTP request only that it receives over the connection. When the ACE and client need to renegotiate their connection, the ACE updates the HTTP header information that it send to the server to reflect the new session parameters. You can also instruct the ACE to insert the session information into every HTTP request that it receives over the connection by creating an HTTP parameter map with either the **Header Modify Per-Request** or **HTTP Persistence Rebalance** options enabled (see the “[Configuring HTTP Parameter Maps](#)” section on page 10-9).

**Note**

The maximum amount of data that the ACE can insert is 512 bytes. The ACE truncates the data if it exceeds this limit.

**Procedure**

- Step 1** Choose **Config > Devices > context > Expert > HTTP Header Modify Action Lists**.  
The HTTP Header Modify Action Lists table appears.
- Step 2** In the HTTP Header Modify Action Lists table, do one of the following:
  - To add a new action list, click **Add**. In the Action List Name field, enter a unique name for the action list. Valid entries are unquoted text strings with a maximum of 64 alphanumeric characters. Click **Deploy Now** when completed to save the configuration and display the editing tabs.
  - To edit an existing action list, choose the action list and click **Edit** to display the editing tabs.
- Step 3** Click the **SSL Header Insert** tab.  
The SSL Header Insert table appears.
- Step 4** In the SSL Header Insert table, click **Add** to add a new entry to the SSL Header Insert table.  
The SSL Header Insert configuration window appears. Enter the required information as shown in [Table 14-37](#).

**Table 14-37** *SSL Action Configuration Window Fields*

| Header Action Field | Description / Action                                                                                                                                                                                                                                                                                                                                                                                                                                                  |
|---------------------|-----------------------------------------------------------------------------------------------------------------------------------------------------------------------------------------------------------------------------------------------------------------------------------------------------------------------------------------------------------------------------------------------------------------------------------------------------------------------|
| Request             | Type of SSL header information to insert into the HTTP request: <ul style="list-style-type: none"> <li>• <b>Client-Certificate</b>—Information about the client certificate that the ACE retrieves from the client.</li> <li>• <b>Server-Certificate</b>—Information about the server certificate that resides on the ACE.</li> <li>• <b>Session</b>—Information about the session parameters that the ACE and client negotiated during the SSL handshake.</li> </ul> |

Table 14-37 SSL Action Configuration Window Fields (continued)

| Header Action Field | Description / Action                                                                                                                                                                                                                                                                                                                                                                                                                                                                                                                                                                                                                                                                                                                                                                                                                                                                                                                                                                                                                                                                                                                                                                                                                                                                                                                                                                                                                                                                                                                                                                                                                            |
|---------------------|-------------------------------------------------------------------------------------------------------------------------------------------------------------------------------------------------------------------------------------------------------------------------------------------------------------------------------------------------------------------------------------------------------------------------------------------------------------------------------------------------------------------------------------------------------------------------------------------------------------------------------------------------------------------------------------------------------------------------------------------------------------------------------------------------------------------------------------------------------------------------------------------------------------------------------------------------------------------------------------------------------------------------------------------------------------------------------------------------------------------------------------------------------------------------------------------------------------------------------------------------------------------------------------------------------------------------------------------------------------------------------------------------------------------------------------------------------------------------------------------------------------------------------------------------------------------------------------------------------------------------------------------------|
| Algorithm           | <p>Field that appears only when the Request field is set to either Client-Certificate or Server-Certificate. Specify the following certificate field information to insert into the HTTP request:</p> <ul style="list-style-type: none"> <li>• <b>Authority-Key-Id</b>—X.509 authority key identifier.</li> <li>• <b>Basic-Constraints</b>—X.509 basic constraints.</li> <li>• <b>Certificate-Version</b>—X.509 certificate version.</li> <li>• <b>Data-Signature-Algorithm</b>—X.509 hashing and encryption method.</li> <li>• <b>Fingerprint-SHA1</b>—SHA1 hash of the certificate.</li> <li>• <b>Issuer</b>—X.509 certificate issuer's distinguished name.</li> <li>• <b>Issuer-CN</b>—X.509 certificate issuer's common name.</li> <li>• <b>Not-After</b>—Date after which the certificate is not valid.</li> <li>• <b>Not-Before</b>—Date before which the certificate is not valid.</li> <li>• <b>Public-Key-Algorithm</b>—Algorithm used for the public key.</li> <li>• <b>RSA-Exponent</b>—Public RSA exponent.</li> <li>• <b>RSA-Modulus</b>—RSA algorithm modulus.</li> <li>• <b>RSA-Modulus-Size</b>—Size of the RSA public key.</li> <li>• <b>Serial-Number</b>—Certificate serial number.</li> <li>• <b>Signature</b>—Certificate signature.</li> <li>• <b>Signature-Algorithm</b>—Certificate signature algorithm.</li> <li>• <b>Subject</b>—X.509 subject's distinguished name.</li> <li>• <b>Subject-CN</b>—X.509 subject's common name.</li> <li>• <b>Subject-Key-Id</b>—X.509 subject key identifier.</li> </ul> <p>For more information, see the <i>Cisco Application Control Engine Module SSL Configuration Guide</i>.</p> |

Table 14-37 SSL Action Configuration Window Fields (continued)

| Header Action Field | Description / Action                                                                                                                                                                                                                                                                                                                                                                                                                                                                                                                                                                                                                                                                                                                                                                                                                                                                                                                                                                                                                                                                                                                                                                                                                                                                                                                                                                                                                                                                                                                                                                                                                                                                                                                                                                                                                                                                                                                                                |
|---------------------|---------------------------------------------------------------------------------------------------------------------------------------------------------------------------------------------------------------------------------------------------------------------------------------------------------------------------------------------------------------------------------------------------------------------------------------------------------------------------------------------------------------------------------------------------------------------------------------------------------------------------------------------------------------------------------------------------------------------------------------------------------------------------------------------------------------------------------------------------------------------------------------------------------------------------------------------------------------------------------------------------------------------------------------------------------------------------------------------------------------------------------------------------------------------------------------------------------------------------------------------------------------------------------------------------------------------------------------------------------------------------------------------------------------------------------------------------------------------------------------------------------------------------------------------------------------------------------------------------------------------------------------------------------------------------------------------------------------------------------------------------------------------------------------------------------------------------------------------------------------------------------------------------------------------------------------------------------------------|
| CipherKey           | <p>Field that appears only when the Request field is set to Session. Indicate the following session parameters to insert into the HTTP request:</p> <ul style="list-style-type: none"> <li>• <b>Cipher-Key-Size</b>—Symmetric cipher key size.</li> <li>• <b>Cipher-Name</b>—Symmetric cipher suite name.</li> <li>• <b>Cipher-Use-Size</b>—Symmetric cipher use size.</li> <li>• <b>Id</b>—SSL Session ID. The default is 0.</li> <li>• <b>Protocol-Version</b>—Version of SSL or TLS.</li> <li>• <b>Step-Up</b>—Use of SGC or StepUp cryptography to increase the level of security by using 128-bit encryption.</li> <li>• <b>Verify-Result</b>—SSL session verify result. Possible values are as follows: <ul style="list-style-type: none"> <li>– ok—The SSL session is established.</li> <li>– certificate is not yet valid—The client certificate is not yet valid.</li> <li>– certificate is expired—The client certificate has expired.</li> <li>– bad key size—The client certificate has a bad key size.</li> <li>– invalid not before field—The client certificate notBefore field is in an unrecognized format.</li> <li>– invalid not after field—The client certificate notAfter field is in an unrecognized format.</li> <li>– certificate has unknown issuer—The client certificate issuer is unknown.</li> <li>– certificate has bad signature—The client certificate contains a bad signature.</li> <li>– certificate has bad leaf signature—The client certificate contains a bad leaf signature.</li> <li>– unable to decode issuer public key—The ACE is unable to decode the issuer public key.</li> <li>– unsupported certificate—The client certificate is not supported.</li> <li>– certificate revoked— The client certificate has been revoked.</li> <li>– internal error—An internal error exists.</li> </ul> </li> </ul> <p>For more information, see the <i>Cisco Application Control Engine Module SSL Configuration Guide</i>.</p> |
| Value               | <p>Field that appears only when the Request field is set to either Client-Certificate or Server-Certificate. Choose one of the following options:</p> <ul style="list-style-type: none"> <li>• <b>N/A</b>—Specifies that the selected algorithm or cipher key is inserted without adding a prefix to it or renaming it.</li> <li>• <b>Prefix</b>—Enables you to specify a prefix string to place before the specified certificate or session field name. For example, if you specify the prefix Acme-SSL for the SSL session field name Cipher-Name, then the field name becomes Acme-SSL-Session-Cipher-Name.</li> <li>• <b>Rename</b>—Enables you to specify a new name for the specified certificate or session field name.</li> </ul>                                                                                                                                                                                                                                                                                                                                                                                                                                                                                                                                                                                                                                                                                                                                                                                                                                                                                                                                                                                                                                                                                                                                                                                                                           |
| Prefix              | <p>Field that appears only when the Value field is set to Prefix. Enter a quoted text string to place before the specified certificate or session field name. The maximum combined number of prefix string and field name characters that the ACE permits is 32.</p>                                                                                                                                                                                                                                                                                                                                                                                                                                                                                                                                                                                                                                                                                                                                                                                                                                                                                                                                                                                                                                                                                                                                                                                                                                                                                                                                                                                                                                                                                                                                                                                                                                                                                                |
| Rename              | <p>Field that appears only when the Value field is set to Rename. Enter a new name to the specified certificate or session field name. The name must be an unquoted text string with no spaces. The maximum number of field name string characters that the ACE permits is 32.</p>                                                                                                                                                                                                                                                                                                                                                                                                                                                                                                                                                                                                                                                                                                                                                                                                                                                                                                                                                                                                                                                                                                                                                                                                                                                                                                                                                                                                                                                                                                                                                                                                                                                                                  |

**Step 5** Repeat Step 4 for each certificate field or session parameter that you want the ACE to insert.

**Step 6** Do one of the following:

- Click **Deploy Now** to deploy this configuration on the ACE and save your entries to the running-configuration and startup-configuration files.
  - Click **Cancel** to exit this procedure without saving your entries.
  - Click **Next** to deploy your entries and to add another entry to the SSL Header Insert table.
- 

#### Related Topics

[Setting Policy Map Rules and Actions for Layer 7 Server Load-Balancing Traffic, page 14-61, Table 14-26](#)





# CHAPTER 15

## Configuring Application Acceleration and Optimization

---

**Date:** 3/28/12

With application acceleration and optimization features on ACE appliances, you can configure application delivery and application acceleration options that increase productivity and efficiency. The application acceleration features optimize network performance and improve access to critical business information. This capability accelerates the performance of Web applications, including customer relationship management, portals, and online collaboration by up to 10 times.



**Note**

Application acceleration performance on the ACE appliance is 50 to 100 Mbps throughput. With typical page sizes and browser usage patterns, this equates to roughly 1,000 concurrent connections. Subsequent connections bypass the application acceleration engine. This limitation applies only to traffic that is explicitly configured to receive application acceleration processing (for example, FlashForward, Delta Optimization). Traffic that is not configured to receive application acceleration processing is not subject to these limitations. Also, because the ACE HTTP compression is implemented separately in hardware, it is not subject to these limitations. For example, if you have a mix of application-accelerated and non-application-accelerated traffic, the former is limited; the latter is not. If you have 50 Mbps of application-accelerated traffic, the ACE can still deliver up to 1.9 Gbps throughput for the non-application-accelerated traffic.

---



**Note**

When naming ACE objects (such as a real server, virtual server, parameter map, class map, health probe, and so on), enter an alphanumeric string of 1 to 64 characters, which can include the following special characters: underscore (\_), hyphen (-), dot (.), and asterisk (\*). Spaces are not allowed.

If you are using ANM with an ACE module or ACE appliance and you configure a named object at the ACE CLI, keep in mind that ANM does not support all of the special characters that the ACE CLI allows you to use when configuring a named object. If you use special characters that ANM does not support, you may not be able to import or manage the ACE using ANM.

---

This chapter includes the following sections:

- [Optimization Overview, page 15-2](#)
- [Optimization Traffic Policies and Typical Configuration Flow, page 15-2](#)
- [Configuring an HTTP Optimization Action List, page 15-3](#)
- [Configuring Optimization Parameter Maps, page 15-6](#)

- [Configuring Traffic Policies for HTTP Optimization, page 15-6](#)
- [Enabling HTTP Optimization Using Virtual Servers, page 15-9](#)
- [Configuring Global Application Acceleration and Optimization, page 15-9](#)

## Optimization Overview

The application acceleration functions of the ACE appliance apply several optimization technologies to accelerate application performance. This functionality enables enterprises to optimize network performance and improve access to critical business information.

The ACE appliance provides the following application acceleration and optimization functionality:

- Delta optimization eliminates redundant traffic on the network by computing and transmitting only the changes that occur in a Web page between successive downloads of the same page or similar pages.
- FlashForward object acceleration technology eliminates network delays associated with embedded Web objects able to be cached, such as images, style sheets, and JavaScript files by placing the responsibility for validating object freshness on the ACE appliance, rather than on the client, making the client more efficient.
- Just-in-time object acceleration enables acceleration of non-cacheable embedded objects, resulting in improved application response time by eliminating the need for clients to download these objects on each request.
- Adaptive dynamic caching accelerates enterprise application performance and improves server system scalability by enabling the ACE appliance itself to fulfill requests for dynamic content, which offloads application servers and databases.

Refer to [Configuring Application Acceleration and Optimization, page 15-1](#) or the *Cisco 4700 Series Application Control Engine Appliance Application Acceleration and Optimization Configuration Guide* for more information about application acceleration and optimization.

### Related Topics

- [Optimization Traffic Policies and Typical Configuration Flow, page 15-2](#)
- [Configuring Traffic Policies for HTTP Optimization, page 15-6](#)
- [Configuring Global Application Acceleration and Optimization, page 15-9](#)

## Optimization Traffic Policies and Typical Configuration Flow

To define the different optimization and application acceleration functions that you want the ACE appliance to perform, you must configure at least one each of the following:

- HTTP optimization action list—This action list specifies the actions that the ACE is to perform for application acceleration and optimization. You can configure action lists when configuring a virtual server, or as a separate procedure. See:
  - [Configuring Application Acceleration and Optimization, page 7-53](#)
  - [Configuring an HTTP Optimization Action List, page 15-3](#)



- Layer 7 server load-balancing class map—This class map identifies the Layer 7 server load-balancing match criteria to apply to incoming traffic, such as URL, HTTP cookie, HTTP header, or source IP address. See [Configuring Virtual Context Policy Maps, page 14-32](#)
- Layer 7 HTTP optimization policy map—This policy map applies the HTTP optimization action list and optionally an optimization parameter map to Layer 7 HTTP traffic. See [Configuring Virtual Context Policy Maps, page 14-32](#).
- Layer 3 and Layer 4 class map—By using match criteria, this class map identifies the network traffic that can pass through the ACE appliance. The match criteria includes the VIP address for the network traffic. The ACE appliance uses these Layer 3 and Layer 4 traffic classes to perform server load balancing. See [Configuring Virtual Context Policy Maps, page 14-32](#).
- Layer 3 and Layer 4 policy map—This policy map associates server load-balancing actions and HTTP optimization action lists with the VIP. See [Setting Policy Map Rules and Actions for Layer 3/Layer 4 Network Traffic, page 14-41](#) and [Configuring Traffic Policies for HTTP Optimization, page 15-6](#).
- Layer 7 server load-balancing policy map—This policy map specifies the server load-balancing actions that the ACE appliance is to perform. See [Configuring Virtual Context Policy Maps, page 14-32](#).

You can also configure:

- Optimization parameter maps—Optimization parameter maps allow you to configure specific options for action list items. You can configure optimization parameter maps when configuring a virtual server or as a separate procedure.

When you configure a parameter map with an action list for a class map, the ACE appliance validates the action list and parameter map configurations before deploying them.

See:

- [Configuring Application Acceleration and Optimization, page 7-53](#)
- [Configuring Optimization Parameter Maps, page 10-12](#).
- Global application acceleration and optimization options—The acceleration and optimization options allow you to apply specific acceleration and optimization features for logging and debugging on a global level on the ACE appliance. See [Configuring Global Application Acceleration and Optimization, page 15-9](#).

#### Related Topics

- [Configuring Traffic Policies for HTTP Optimization, page 15-6](#)
- [Optimization Overview, page 15-2](#)

## Configuring an HTTP Optimization Action List

An HTTP optimization action list groups a series of individual application acceleration and optimization operations that you want the ACE to perform.

Use this procedure to configure an HTTP optimization action list.



**Tip**

You can also configure action lists when configuring a virtual server. For more information, see [“Configuring Application Acceleration and Optimization” section on page 7-53](#).

**Procedure**

- Step 1** Choose **Config > Devices > context > Expert > Optimization Action List**.  
The Action List table appears.
- Step 2** Click **Add** to add a new optimization action list, or choose an existing action list and click **Edit** to modify it.
- Step 3** Configure the optimization action list using the information in [Table 15-1](#).

**Table 15-1 Action List Configuration Options**

| Field            | Description                                                                                                                                                                                                                                                                                                                                                                                                                                                                                                                                                                                                                                                                                                                                                                               |
|------------------|-------------------------------------------------------------------------------------------------------------------------------------------------------------------------------------------------------------------------------------------------------------------------------------------------------------------------------------------------------------------------------------------------------------------------------------------------------------------------------------------------------------------------------------------------------------------------------------------------------------------------------------------------------------------------------------------------------------------------------------------------------------------------------------------|
| Action List Name | Unique name for the action list. Valid entries are unquoted text strings with a maximum of 64 alphanumeric characters.                                                                                                                                                                                                                                                                                                                                                                                                                                                                                                                                                                                                                                                                    |
| Enable Delta     | <p>Check box that enables delta optimization for the specified URLs. Delta optimization dynamically updates client browser caches directly with content differences, or deltas, resulting in faster page downloads.</p> <p>Uncheck the check box to disable delta optimization for the specified URLs.</p> <p><b>Note</b> The ACE restricts you from enabling delta optimization if you have previously specified either Cache Dynamic or Dynamic Dynamic Entity Tag.</p>                                                                                                                                                                                                                                                                                                                 |
| Enable AppScope  | <p>Check box that enables AppScope performance monitoring for use with the ACE appliance. AppScope runs on the Management Console of the optional Cisco AVS 3180A Management Station and measures end-to-end application performance.</p> <p>Uncheck the check box to disable AppScope performance monitoring for use with the ACE appliance.</p>                                                                                                                                                                                                                                                                                                                                                                                                                                         |
| Flash Forward    | <p>Feature that reduces bandwidth usage and accelerates embedded object downloading by combining local object storage with dynamic renaming of embedded objects, thereby enforcing object freshness within the parent HTML page.</p> <p>Specify how the ACE appliance is to implement FlashForward:</p> <ul style="list-style-type: none"> <li>• <b>N/A</b>—Indicates that this feature is not enabled.</li> <li>• <b>FlashForward</b>—Indicates that FlashForward is to be enabled for the specified URLs and that embedded objects are to be transformed.</li> <li>• <b>FlashForward Object</b>—Indicates that FlashForward static caching is to be enabled for the objects that the corresponding URLs refer to, such as Cascading Style Sheets (CSS), JPEG, and GIF files.</li> </ul> |
| Cache Dynamic    | <p>Check box that enables Adaptive Dynamic Caching for the specified URLs even if the expiration settings in the response indicate that the content is dynamic. The expiration of cache objects is controlled by the cache expiration settings based on time or server load.</p> <p>Uncheck the check box to disable this feature.</p> <p><b>Note</b> The ACE restricts you from enabling Cache Dynamic if you have previously specified either Enable Delta or Dynamic Dynamic Entity Tag.</p>                                                                                                                                                                                                                                                                                           |

**Table 15-1** Action List Configuration Options

| Field                      | Description                                                                                                                                                                                                                                                                                                                                                                                                                                                                                                                                                                                                        |
|----------------------------|--------------------------------------------------------------------------------------------------------------------------------------------------------------------------------------------------------------------------------------------------------------------------------------------------------------------------------------------------------------------------------------------------------------------------------------------------------------------------------------------------------------------------------------------------------------------------------------------------------------------|
| Cache Forward              | <p>Check box that enables the cache forward feature for the corresponding URLs. Cache forward allows the ACE to serve the object from its cache (static or dynamic) even when the object has expired if the maximum cache TTL time period has not yet expired (set by specifying the Cache Time-To-Live Duration (%): field in an Optimization parameter map). At the same time, the ACE sends an asynchronous request to the origin server to refresh its cache of the object.</p> <p>Uncheck this check box to disable this feature.</p>                                                                         |
| Dynamic Dynamic Entity Tag | <p>Check box that enables the acceleration of noncacheable embedded objects, which results in improved application response time. When enabled, this feature eliminates the need for users to download noncacheable objects on each request.</p> <p>Check the check box to indicate that the ACE appliance is to implement just-in-time object acceleration for noncacheable embedded objects.</p> <p>Uncheck this check box to disable this feature.</p> <p><b>Note</b> The ACE restricts you from enabling Dynamic Dynamic Entity Tag if you have previously specified either Enable Delta or Cache Dynamic.</p> |

**Step 4** Do one of the following:

- Click **Deploy Now** to deploy this configuration on the ACE and save your entries to the running-configuration and startup-configuration files. The ACE appliance validates the action list configuration.
- Click **Cancel** to exit this procedure without saving your entries.
- Click **Next** to save your entries and to configure another action list.

**Related Topics**

- [Optimization Traffic Policies and Typical Configuration Flow, page 15-2](#)
- [Configuring Optimization Parameter Maps, page 15-6](#)
- [Configuring Traffic Policies for HTTP Optimization, page 15-6](#)
- [Configuring Global Application Acceleration and Optimization, page 15-9](#)

# Configuring Optimization Parameter Maps

You can configure an Optimization parameter map for use with a Layer 3/Layer 4 policy map.



## Tip

You can also configure optimization parameter maps when configuring a virtual server. For more information, see [“Configuring Application Acceleration and Optimization”](#) section on page 7-53.

## Procedure

- 
- Step 1** Choose **Config > Devices > context > Load Balancing > Parameter Maps > Optimization Parameter Maps**.
- The Optimization Parameter Maps table appears.
- Step 2** Click **Add** to add a new parameter map, or choose an existing parameter map and click **Edit** to modify it. The Optimization Parameter Maps configuration window appears.
- Step 3** In the Parameter Name field, enter a unique name for this parameter map. Valid entries are unquoted text strings with no spaces and a maximum of 64 alphanumeric characters.
- Step 4** Configure optimization using the information in [Table 10-6](#).
- Step 5** Do one of the following:
- Click **Deploy Now** to immediately deploy this configuration on the ACE and save your entries to the running-configuration and startup-configuration files. The ACE validates the parameter map configuration and deploys it. This option appears for virtual contexts.
  - Click **Cancel** to exit this procedure without saving your entries and to return to the Parameter Map table.
  - Click **Next** to accept your entries and to add another parameter map.
- 

## Related Topics

- [Optimization Traffic Policies and Typical Configuration Flow, page 15-2](#)
- [Configuring an HTTP Optimization Action List, page 15-3](#)
- [Configuring Traffic Policies for HTTP Optimization, page 15-6](#)
- [Configuring Global Application Acceleration and Optimization, page 15-9](#)

# Configuring Traffic Policies for HTTP Optimization

[Table 15-2](#) provides a high-level overview of the steps required to configure HTTP optimization on an ACE appliance.



## Note

[Table 15-2](#) includes only the significant steps in each task. For detailed information on configuring these items, select the links provided, click **Help** in the ANM GUI, or refer to [Configuring Traffic Policies, page 14-1](#).

---

**Assumption**

A virtual IP address has been configured for the context in which you configure HTTP optimization.

**Table 15-2** Configuring Traffic Policies for HTTP Optimization

| Task                                                                                                                                                                                                          | Procedure                                                                                                                                                                                                                                                                                                                                                                                                                                                                                                                                                                                                                                                                                                                                                                                                                                                                                                                                            |
|---------------------------------------------------------------------------------------------------------------------------------------------------------------------------------------------------------------|------------------------------------------------------------------------------------------------------------------------------------------------------------------------------------------------------------------------------------------------------------------------------------------------------------------------------------------------------------------------------------------------------------------------------------------------------------------------------------------------------------------------------------------------------------------------------------------------------------------------------------------------------------------------------------------------------------------------------------------------------------------------------------------------------------------------------------------------------------------------------------------------------------------------------------------------------|
| <b>Step 1</b><br>Create a Layer 7 class map for server load balancing.                                                                                                                                        | <ol style="list-style-type: none"> <li>a. Choose <b>Config &gt; Devices &gt; context &gt; Expert &gt; Class Maps</b>.</li> <li>b. Click <b>Add</b> to add a new class map.</li> <li>c. In the Class Map Type field, choose <b>Layer 7 Server Load Balancing</b>.</li> <li>d. In the Match Type field, choose the method the ACE appliance is to use to evaluate multiple match statements when multiple match conditions exist in the class map.</li> <li>e. Click <b>Deploy Now</b> to deploy this configuration on the ACE and save your entries to the running-configuration and startup-configuration files.</li> <li>f. Configure match conditions for this class map.</li> </ol> For more information, see: <ul style="list-style-type: none"> <li>• <a href="#">Configuring Virtual Context Class Maps, page 14-6</a></li> <li>• <a href="#">Setting Match Conditions for Layer 7 Server Load Balancing Class Maps, page 14-14</a></li> </ul> |
| <b>Step 2</b><br>Create an HTTP optimization action list to specify the optimization actions that are to be performed.                                                                                        | <ol style="list-style-type: none"> <li>a. Choose <b>Config &gt; Devices &gt; context &gt; Expert &gt; Action Lists</b>.</li> <li>b. Click <b>Add</b> to add a new action list.</li> <li>c. Configure the action list using the information in <a href="#">Table 15-1</a>.</li> <li>d. Click <b>Deploy Now</b> to deploy this configuration on the ACE and save your entries to the running-configuration and startup-configuration files.</li> </ol> For more information, see <a href="#">Configuring an HTTP Optimization Action List, page 15-3</a> .                                                                                                                                                                                                                                                                                                                                                                                             |
| <b>Step 3</b><br>Create a Layer 7 HTTP optimization policy map and associate it with the server load-balancing class map in <a href="#">Step 1</a> and the action list configured in <a href="#">Step 2</a> . | <ol style="list-style-type: none"> <li>a. Choose <b>Config &gt; Devices &gt; context &gt; Expert &gt; Policy Maps</b>.</li> <li>b. Click <b>Add</b> to add a new policy map.</li> <li>c. In the Type field, choose <b>Layer 7 HTTP Optimization</b>.</li> <li>d. Click <b>Deploy Now</b> to deploy this configuration on the ACE and save your entries to the running-configuration and startup-configuration files.</li> <li>e. In the Rules table, add the server load-balancing class map created in <a href="#">Step 1</a>.</li> <li>f. In the Action table, add the action list created in <a href="#">Step 2</a>.</li> </ol> For more information, see: <ul style="list-style-type: none"> <li>• <a href="#">Configuring Virtual Context Policy Maps, page 14-32</a></li> <li>• <a href="#">Setting Policy Map Rules and Actions for Layer 7 HTTP Optimization, page 14-57</a></li> </ul>                                                      |

Table 15-2 Configuring Traffic Policies for HTTP Optimization (continued)

| Task                                                                                                                                                                                                                                                                                                                                                                                                         | Procedure                                                                                                                                                                                                                                                                                                                                                                                                                                                                                                                                                                                                                                                                                                                                                                                                                                                                                                                                                                                                                                                        |
|--------------------------------------------------------------------------------------------------------------------------------------------------------------------------------------------------------------------------------------------------------------------------------------------------------------------------------------------------------------------------------------------------------------|------------------------------------------------------------------------------------------------------------------------------------------------------------------------------------------------------------------------------------------------------------------------------------------------------------------------------------------------------------------------------------------------------------------------------------------------------------------------------------------------------------------------------------------------------------------------------------------------------------------------------------------------------------------------------------------------------------------------------------------------------------------------------------------------------------------------------------------------------------------------------------------------------------------------------------------------------------------------------------------------------------------------------------------------------------------|
| <p><b>Step 4</b> Create a Layer 3/Layer 4 class map for server load balancing.</p>                                                                                                                                                                                                                                                                                                                           | <ol style="list-style-type: none"> <li>Choose <b>Config &gt; Devices &gt; context &gt; Expert &gt; Class Maps</b>.</li> <li>Click <b>Add</b> to add a new class map.</li> <li>In the Class Map Type field, choose <b>Layer 3/4 Network Traffic</b>.</li> <li>In the Match Type field, choose the method the ACE appliance is to use to evaluate multiple match statements when multiple match conditions exist in the class map.</li> <li>Click <b>Deploy Now</b> to deploy this configuration on the ACE and save your entries to the running-configuration and startup-configuration files.</li> <li>Configure Virtual Address match conditions for this class map.</li> </ol> <p>For more information, see:</p> <ul style="list-style-type: none"> <li><a href="#">Configuring Virtual Context Class Maps, page 14-6</a></li> <li><a href="#">Setting Match Conditions for Layer 3/Layer 4 Network Traffic Class Maps, page 14-9</a></li> </ul>                                                                                                               |
| <p><b>Step 5</b> Create a Layer 7 policy map for server load balancing and associate it with the Layer 7 server load-balancing class map from <a href="#">Step 1</a>.</p>                                                                                                                                                                                                                                    | <ol style="list-style-type: none"> <li>Choose <b>Config &gt; Devices &gt; context &gt; Expert &gt; Policy Maps</b>.</li> <li>Click <b>Add</b> to add a new policy map.</li> <li>In the Type field, choose <b>Layer 7 Server Load Balancing</b>.</li> <li>Click <b>Deploy Now</b> to deploy this configuration on the ACE and save your entries to the running-configuration and startup-configuration files.</li> <li>Associate the Layer 7 server load-balancing class map configured in <a href="#">Step 1</a> with this policy map by adding it to the Rule table.</li> </ol> <p>For more information, see:</p> <ul style="list-style-type: none"> <li><a href="#">Configuring Virtual Context Policy Maps, page 14-32</a></li> <li><a href="#">Setting Policy Map Rules and Actions for Layer 7 Server Load-Balancing Traffic, page 14-61</a></li> </ul>                                                                                                                                                                                                     |
| <p><b>Step 6</b> Create a Layer 3/Layer 4 network traffic policy map and associate it with the:</p> <ul style="list-style-type: none"> <li>Layer 3/Layer 4 server load-balancing class map configured in <a href="#">Step 4</a></li> <li>Layer 7 server load-balancing policy map configured in <a href="#">Step 5</a></li> <li>HTTP optimization policy map configured in <a href="#">Step 3</a></li> </ul> | <ol style="list-style-type: none"> <li>Choose <b>Config &gt; Devices &gt; context &gt; Expert &gt; Policy Maps</b>.</li> <li>Click <b>Add</b> to add a new policy map.</li> <li>In the Type field, choose <b>Layer 3/4 Network Traffic</b>.</li> <li>Click <b>Deploy Now</b> to deploy this configuration on the ACE and save your entries to the running-configuration and startup-configuration files.</li> <li>In the Rule table, add the Layer 3/Layer 4 server load-balancing class map configured in <a href="#">Step 4</a>.</li> <li>In the Action table, add the: <ul style="list-style-type: none"> <li>Layer 7 server load-balancing policy map created in <a href="#">Step 5</a></li> <li>HTTP optimization policy map created in <a href="#">Step 3</a></li> </ul> </li> </ol> <p>For more information, see:</p> <ul style="list-style-type: none"> <li><a href="#">Configuring Virtual Context Policy Maps, page 14-32</a></li> <li><a href="#">Setting Policy Map Rules and Actions for Layer 3/Layer 4 Network Traffic, page 14-41</a></li> </ul> |

**Related Topics**

- [Optimization Traffic Policies and Typical Configuration Flow, page 15-2](#)
- [Configuring an HTTP Optimization Action List, page 15-3](#)
- [Optimization Overview, page 15-2](#)

## Enabling HTTP Optimization Using Virtual Servers

You can configure HTTP optimization using virtual servers.

**Procedure**

- 
- Step 1** Create a virtual server by following the instructions in “[Configuring Virtual Servers](#)” section on [page 7-2](#).
- Step 2** Configure HTTP optimization by following the instructions in “[Configuring Application Acceleration and Optimization](#)” section on [page 7-53](#).
- 

**Related Topics**

- [Configuring Traffic Policies for HTTP Optimization, page 15-6](#)
- [Optimization Traffic Policies and Typical Configuration Flow, page 15-2](#)

## Configuring Global Application Acceleration and Optimization

**Note**

This functionality is available for Admin contexts only and only on ACE appliances.

ANM allows you to configure global application acceleration and optimization options for logging and debugging as performed by the ACE appliance.

**Procedure**

- 
- Step 1** Choose **Config > Virtual Contexts > *admin\_context* > System > Application Acceleration And Optimization**. The Application Acceleration And Optimization configuration window appears.
- Step 2** In the Debug Level field, enter the maximum level of system log messages to be sent to the syslog server, using the values in [Table 6-5](#). The severity level that you specify indicates that you want syslog messages at that level and the more severe levels. For example, if you enter 3 for Error, syslog displays Error, Critical, Alert, and Emergency messages.
- Step 3** Check the **AppScope Log** check box to indicate that the ACE appliance is to upload optimization statistical log information to the optional AVS 3180A Management station. Clear the check box to indicate that the ACE appliance is not to upload this information.
- Step 4** Click **Deploy Now** to immediately deploy this configuration on the ACE and save your entries to the running-configuration and startup-configuration files.
-

**Related Topics**

- [Optimization Overview, page 15-2](#)
- [Optimization Traffic Policies and Typical Configuration Flow, page 15-2](#)





# CHAPTER 16

## Using Configuration Building Blocks

---

Date: 3/28/12



### Note

Beginning with ANM software Version 5.1, the building block feature by default is hidden. If you have used the building block feature in the past and want to continue using it after upgrading to ANM 5.1, you must enable it (see the [“Enabling the Building Block Feature”](#) section on page 16-5).

---



### Note

When naming ACE objects (such as a real server, virtual server, parameter map, class map, health probe, and so on), enter an alphanumeric string of 1 to 64 characters, which can include the following special characters: underscore (\_), hyphen (-), dot (.), and asterisk (\*). Spaces are not allowed.

If you are using ANM with an ACE module or ACE appliance and you configure a named object at the ACE CLI, keep in mind that ANM does not support all of the special characters that the ACE CLI allows you to use when configuring a named object. If you use special characters that ANM does not support, you may not be able to import or manage the ACE using ANM.

---

Building blocks allow authorized users to create and design reusable configuration attributes which can then be applied to virtual contexts. The ANM also allows you to extract the configuration of an existing virtual context and tag it as a building block.

In many cases, the same configuration settings can be used in several virtual contexts (for example, it can offer the same service bundle to many customers). To avoid repeating virtual context configuration and testing each time you create a virtual context, you can create a building block of many configuration attributes that can be applied to virtual contexts as appropriate or as needed.

With building blocks, you can also create a variety of configurations that address customers' differing needs. The ability to customize configurations to customer needs also allows you to use network resources most efficiently.

Benefits of configuration building blocks include:

- You can establish baseline versions of working configurations.
- Users can make real-time changes to configurations and roll back to a previously working configuration, if needed.
- Building blocks can be extracted from proven, working configurations.
- Building blocks can be placed under version control, with tagged versions that cannot be modified.

Table 16-1 lists the configuration options that are available for each building block type and provides links to related topics. For descriptive information about the menu options, see “Configuring Virtual Contexts” section on page 6-8.

**Table 16-1 Building Block Configuration Options**

| Menu Option                               | Building Block Type |                    | Related Topic                                                                    |
|-------------------------------------------|---------------------|--------------------|----------------------------------------------------------------------------------|
|                                           | ACE 2.0             | ACE 4710 Appliance |                                                                                  |
| <b>System</b>                             |                     |                    |                                                                                  |
| Primary Attributes                        | X                   | X                  | <a href="#">Configuring Building Block Primary Attributes, page 16-8</a>         |
| Syslog                                    | X                   | X                  | <a href="#">Configuring Virtual Context Syslog Settings, page 6-19</a>           |
| SNMP                                      | X                   | X                  | <a href="#">Configuring SNMP for Virtual Contexts, page 6-27</a>                 |
| Global Policies                           | X                   | X                  | <a href="#">Applying a Policy Map Globally to All VLAN Interfaces, page 6-35</a> |
| Licenses                                  |                     |                    |                                                                                  |
| Application Acceleration and Optimization |                     |                    |                                                                                  |
| Resource Classes                          |                     |                    |                                                                                  |
| Checkpoints                               |                     |                    |                                                                                  |
| Backup/Restore <sup>1</sup>               |                     |                    |                                                                                  |
| <b>Load Balancing</b>                     |                     |                    |                                                                                  |
| Virtual Servers                           |                     |                    |                                                                                  |
| Real Servers                              | X                   | X                  | <a href="#">Configuring Real Servers, page 8-5</a>                               |
| Server Farms                              | X                   | X                  | <a href="#">Configuring Server Farms, page 8-30</a>                              |
| Health Monitoring                         | X                   | X                  | <a href="#">Configuring Health Monitoring for Real Servers, page 8-51</a>        |
| Stickiness                                | X                   | X                  | <a href="#">Configuring Sticky Groups, page 9-7</a>                              |
| HTTP Parameter Map                        | X                   | X                  | <a href="#">Configuring HTTP Parameter Maps, page 10-9</a>                       |
| Connection Parameter Maps                 | X                   | X                  | <a href="#">Configuring Connection Parameter Maps, page 10-3</a>                 |
| Optimization Parameter Maps               |                     | X                  | <a href="#">Configuring Optimization Parameter Maps, page 10-12</a>              |
| Generic Parameter Maps                    | X                   | X                  | <a href="#">Configuring Generic Parameter Maps, page 10-8</a>                    |
| RTSP Parameter Maps                       | X                   | X                  | <a href="#">Configuring RTSP Parameter Maps, page 10-20</a>                      |
| SIP Parameter Maps                        | X                   | X                  | <a href="#">Configuring SIP Parameter Maps, page 10-21</a>                       |
| Skinny Parameter Maps                     | X                   | X                  | <a href="#">Configuring Skinny Parameter Maps, page 10-23</a>                    |
| DNS Parameter Maps                        | X                   | X                  |                                                                                  |
| Secure KAL-AP                             | X                   | X                  | <a href="#">Configuring Secure KAL-AP, page 8-77</a>                             |
| <b>SSL</b>                                |                     |                    |                                                                                  |
| Setup Sequence                            |                     |                    |                                                                                  |
| Certificates                              |                     |                    |                                                                                  |
| Keys                                      | X                   | X                  | <a href="#">Using SSL Keys, page 11-10</a>                                       |

Table 16-1 Building Block Configuration Options (continued)

| Menu Option                              | Building Block Type |                    | Related Topic                                                                                |
|------------------------------------------|---------------------|--------------------|----------------------------------------------------------------------------------------------|
|                                          | ACE 2.0             | ACE 4710 Appliance |                                                                                              |
| Parameter Maps                           | X                   | X                  | <a href="#">Configuring SSL Parameter Maps, page 11-18</a>                                   |
| Chain Group Parameters                   |                     |                    |                                                                                              |
| CSR Parameters                           | X                   | X                  | <a href="#">Configuring SSL CSR Parameters, page 11-24</a>                                   |
| Proxy Service                            |                     |                    |                                                                                              |
| Auth Group Parameters                    | X                   | X                  | <a href="#">Configuring SSL Authentication Groups, page 11-31</a>                            |
| Certificate Revocation Lists (CSL)       | X                   | X                  | <a href="#">Configuring CRLs for Client Authentication, page 11-33</a>                       |
| <b>Security</b>                          |                     |                    |                                                                                              |
| ACLs                                     | X                   | X                  | <a href="#">Creating ACLs, page 6-79</a>                                                     |
| Object Groups                            | X                   | X                  | <a href="#">Configuring Object Groups, page 6-89</a>                                         |
| <b>Network</b>                           |                     |                    |                                                                                              |
| Port Channel                             |                     |                    |                                                                                              |
| Gigabit Ethernet Interfaces              |                     |                    |                                                                                              |
| VLAN Interfaces                          | X                   | X                  | <a href="#">Configuring Virtual Context VLAN Interfaces, page 12-6</a>                       |
| BVI Interfaces                           | X                   | X                  | <a href="#">Configuring Virtual Context BVI Interfaces, page 12-19</a>                       |
| NAT Pools <sup>2</sup>                   | X                   |                    | <a href="#">Configuring VLAN Interface NAT Pools, page 12-26</a>                             |
| Static Routes                            | X                   | X                  | <a href="#">Configuring Virtual Context Static Routes, page 12-28</a>                        |
| Global IP DHCP                           | X                   | X                  | <a href="#">Configuring Global IP DHCP, page 12-29</a>                                       |
| Static NAT Overwrite                     | X                   |                    | <a href="#">Configuring Static VLANs for Over 8000 Static NAT Configurations, page 12-31</a> |
| <b>High Availability</b>                 |                     |                    |                                                                                              |
| Setup                                    |                     |                    |                                                                                              |
| <b>HA Tracking and Failure Detection</b> |                     |                    |                                                                                              |
| Interfaces                               |                     |                    |                                                                                              |
| Hosts                                    |                     |                    |                                                                                              |
| HSRP Groups                              |                     |                    |                                                                                              |
| <b>Role-Based Access Control</b>         |                     |                    |                                                                                              |
| Users                                    | X                   | X                  | <a href="#">Configuring Device RBAC Users, page 5-53</a>                                     |
| Roles                                    | X                   | X                  | <a href="#">Configuring Device RBAC Roles, page 5-56</a>                                     |
| Domains                                  | X                   | X                  | <a href="#">Configuring Device RBAC Domains, page 5-61</a>                                   |
| <b>Expert</b>                            |                     |                    |                                                                                              |
| Class Map                                | X                   | X                  | <a href="#">Configuring Virtual Context Class Maps, page 14-6</a>                            |
| Policy Map                               | X                   | X                  | <a href="#">Configuring Virtual Context Policy Maps, page 14-32</a>                          |
| HTTP Header Modify Action Lists          | X                   | X                  | <a href="#">Configuring an HTTP Header Modify Action List, page 14-85</a>                    |

Table 16-1 Building Block Configuration Options (continued)

| Menu Option               | Building Block Type |                    | Related Topic                                                           |
|---------------------------|---------------------|--------------------|-------------------------------------------------------------------------|
|                           | ACE 2.0             | ACE 4710 Appliance |                                                                         |
| Optimization Action Lists |                     | X                  | <a href="#">Configuring an HTTP Optimization Action List, page 15-3</a> |
| Building Block Audit      |                     |                    |                                                                         |

1. Backup/Restore is only supported for software version A2(3.0) and higher for the ACE module.
2. NAT pools as a selection under Network is only supported for software version A2(3.0) and higher for the ACE module.

This chapter includes the following sections:

- [Information About Building Block Versions and Tagging, page 16-4](#)
- [Enabling the Building Block Feature, page 16-5](#)
- [Creating Building Blocks, page 16-5](#)
- [Extracting Building Blocks from Virtual Contexts, page 16-6](#)
- [Configuring Building Blocks, page 16-7](#)
- [Tagging Building Blocks, page 16-9](#)
- [Applying Building Blocks, page 16-9](#)
- [Displaying Building Block Use, page 16-11](#)

## Information About Building Block Versions and Tagging

The ANM maintains version history for the building blocks that you create, design, and tag. You can tag a working building block version at any point during design or configuration, and reuse any tagged version of a building block.

A building block is not available for deployment until it has been *tagged*. When you tag a building block, the ANM publishes it with a version tag, such as 1.0 or 1.1.

You cannot edit tagged versions of a building block. After a building block is tagged, it is “frozen” and can no longer be modified in any way. When you open a tagged building block for editing, the ANM does not modify the tagged version, but instead creates a new working copy of the building block for you to work in. Any changes you make to the working copy are not available for deployment until you tag the building block under a new version tag.

### Related Topics

- [Enabling the Building Block Feature, page 16-5](#)
- [Using Configuration Building Blocks, page 16-1](#)
- [Creating Building Blocks, page 16-5](#)
- [Extracting Building Blocks from Virtual Contexts, page 16-6](#)
- [Applying Building Blocks, page 16-9](#)
- [Tagging Building Blocks, page 16-9](#)
- [Displaying Building Block Use, page 16-11](#)

# Enabling the Building Block Feature

Beginning with ANM software Version 5.1, the building block feature by default is hidden because it has been replaced with the application template feature introduced in the same release. The application template feature provides a more efficient and easier way of configuring ACE devices (see [Chapter 4, “Using Application Template Definitions”](#)). If you have used the building block feature in the past and want to continue using it after upgrading to ANM 5.1, you must enable it.

This procedure shows how to enable the building block feature on ANM server and ANM Virtual Appliance.

## Procedure

- 
- Step 1** Enable the building block feature as follows:
- ANM Server—Open the `/opt/CSCOanm/etc/cs-config.properties` file in a text editor and add the following line:  
**`web.buildingblocks.enable=true`**
  - ANM Virtual Appliance—Enter the following command:  
**`anm-property set web.buildingblocks.enable true`**
- Step 2** Restart ANM as follows:
- ANM Server—Enter the following command:  
**`/opt/CSCOanm/bin/anm-tool restart`**
  - ANM Virtual Appliance—Enter the following command:  
**`anm-tool restart`**
- Step 3** From the ANM client devices, close all open ANM browser instances, clear the browser cache, and log in again.
- Failure to clear the browser cache after enabling the building block feature can result in the Extract Building Block function buttons not displaying.
- 

# Creating Building Blocks

Use this procedure to create a building block without using an existing configuration.

To create a building block from an existing virtual context, see [Extracting Building Blocks from Virtual Contexts, page 16-6](#).

## Procedure

- 
- Step 1** Choose **Config > Building Blocks**.  
The All Building Blocks table appears.
- Step 2** In the All Building Blocks table, click **Add**.  
The New Building Block window appears.
- Step 3** In the Name field of the New Building Block window, enter a unique name for this building block.

- Step 4** In the Type field, choose the type of building block to create:
- **ACE v1.0**—Use with virtual contexts on ACE modules using the specified software version.
  - **ACE v2.0**—Use with virtual contexts on ACE modules using the specified software version.
  - **ACE v2.3**—Use with virtual contexts on ACE modules using the specified software version.
  - **ACE v4.1**—Use with virtual contexts on ACE modules using the specified software version.
  - **ACE v4.2**—Use with virtual contexts on ACE modules using the specified software version.
  - **ACE4710 V 1.0**—Use with virtual contexts on ACE appliances using the specified software version.
  - **ACE4710 V 2.0**—Use with virtual contexts on ACE appliances using the specified software version.
  - **ACE4710 V 4.1**—Use with virtual contexts on ACE appliances using the specified software version.
  - **ACE4710 V 4.2**—Use with virtual contexts on ACE appliances using the specified software version.

See [Table 16-1](#) for a list of the available configuration options for each building block type.

- Step 5** In the Description field, enter a brief description for this building block.

- Step 6** Do one of the following:

- Click **Save** to save your entries and to continue with building block configuration. The Primary Attributes configuration window appears.
- Click **Cancel** to exit this procedure without saving your entries and to return to the All Building Blocks table.
- Click **Tag** to save your entries and tag the building block. After you tag a building block, the window refreshes and provides fields for applying the building block. For more information, see [Applying Building Blocks, page 16-9](#).

---

#### Related Topics

- [Enabling the Building Block Feature, page 16-5](#)
- [Using Configuration Building Blocks, page 16-1](#)
- [Extracting Building Blocks from Virtual Contexts, page 16-6](#)
- [Information About Building Block Versions and Tagging, page 16-4](#)
- [Applying Building Blocks, page 16-9](#)
- [Tagging Building Blocks, page 16-9](#)
- [Displaying Building Block Use, page 16-11](#)

## Extracting Building Blocks from Virtual Contexts

An alternative to creating a new configuration building block and configuring each attribute individually is to extract a configuration building block from an existing virtual context. By extracting a building block from a virtual context, you can reduce the time you spend configuring and testing the configuration.

Use this procedure to create a working building block from a virtual context configuration.

### Procedure

---

- Step 1** Choose **Config > Devices**.  
The device tree appears.
- Step 2** In the device tree, choose the ACE with the virtual context whose configuration you want to use as a building block.  
The Virtual Contexts table appears.
- Step 3** In the Virtual Contexts table, choose the context with the configuration that you want to extract, and click **Extract Building Block**.  
A popup window appears, asking for a building block name.
- Step 4** In the Name field of the popup window, enter a name for this building block, and click **OK**. The window refreshes with the Primary Attributes window for the newly created building block (Config > Global > *building\_block*).
- Step 5** Modify the building block as desired using the information in [Table 16-1](#), or tag and deploy it as described in “[Tagging Building Blocks](#)” section on page 16-9 and “[Applying Building Blocks](#)” section on page 16-9).
- 

### Related Topics

- [Enabling the Building Block Feature, page 16-5](#)
- [Applying Building Blocks, page 16-9](#)
- [Tagging Building Blocks, page 16-9](#)
- [Displaying Building Block Use, page 16-11](#)

## Configuring Building Blocks

You can modify a working version of a configuration building block.



**Note** You can modify only working versions of building blocks; you cannot modify tagged versions of building blocks. If you select a tagged building block version, and then select a configuration option (such as **Load Balancing > Health Monitoring**), you can view the entries for that tagged version, but you cannot modify them.

---

### Procedure

---

- Step 1** Choose **Config > Building Blocks**.  
The All Building Blocks table appears.
- Step 2** Choose the working version of the building block that you want to modify, then choose the attributes that you want to configure. For information about building block configuration options, see [Table 16-1](#).



**Note** While it is possible to configure VLAN and BVI interfaces in a building block, we recommend that you do not do so. Applying a building block with these attributes configured to a virtual context with different settings can disrupt network traffic.

**Step 3** To apply this building block, tag it, and deploy it as described in “[Tagging Building Blocks](#)” section on page 16-9 and “[Applying Building Blocks](#)” section on page 16-9.

#### Related Topics

- [Enabling the Building Block Feature](#), page 16-5
- [Using Configuration Building Blocks](#), page 16-1
- [Information About Building Block Versions and Tagging](#), page 16-4
- [Creating Building Blocks](#), page 16-5
- [Extracting Building Blocks from Virtual Contexts](#), page 16-6
- [Tagging Building Blocks](#), page 16-9
- [Displaying Building Block Use](#), page 16-11

## Configuring Building Block Primary Attributes

Use this procedure to change the description of a configuration building block.

#### Procedure

- Step 1** Choose **Config > Building Blocks**.
- The All Building Blocks table appears.
- Step 2** In the All Building Blocks table, choose the building block that you want to modify, and choose **System > Primary Attributes**.
- The Primary Attributes window appears.
- Step 3** In the Description field of the Primary Attributes window, modify the description as desired.
- Step 4** Do one of the following:
- Click **Save** to save your entries. The window refreshes with the saved information.
  - Click **Tag** to tag the building block. To deploy the tagged building block, see “[Applying Building Blocks](#)” section on page 16-9.

#### Related Topics

- [Enabling the Building Block Feature](#), page 16-5
- [Creating Building Blocks](#), page 16-5
- [Configuring Building Blocks](#), page 16-7
- [Tagging Building Blocks](#), page 16-9



# Tagging Building Blocks

You can tag a working copy of a building block. After creating a building block, you must tag it before you can apply it to virtual contexts.

## Procedure

---

**Step 1** Choose **Config > Building Blocks**.

The All Building Blocks table appears.

**Step 2** In the All Building Blocks table, choose the working copy of the building block that you want to tag, and click **Tag**.

The All Building Blocks table refreshes with the newly tagged building block identified by its version, such as 1.2 or 1.3. A working copy of the building block remains available so that you can use it for future building block versions.

To apply the tagged building block to virtual contexts on your network, see [“Applying Building Blocks” section on page 16-9](#).

---

## Related Topics

- [Enabling the Building Block Feature, page 16-5](#)
- [Using Configuration Building Blocks, page 16-1](#)
- [Information About Building Block Versions and Tagging, page 16-4](#)
- [Creating Building Blocks, page 16-5](#)
- [Applying Building Blocks, page 16-9](#)
- [Extracting Building Blocks from Virtual Contexts, page 16-6](#)
- [Displaying Building Block Use, page 16-11](#)

# Applying Building Blocks

You can apply building blocks in two ways:

- By selecting a virtual context, then applying the building block. See [“Applying a Building Block to a Single Virtual Context” section on page 16-10](#).
- By selecting the tagged building block, then applying it to one or more virtual contexts. See [“Applying a Building Block to Multiple Virtual Contexts” section on page 16-10](#).

## Applying a Building Block to a Single Virtual Context

You can apply a tagged building block to a virtual context using virtual context configuration screens.



### Note

Before applying a building block to a virtual context, confirm that the VLAN and BVI interfaces are defined correctly for the virtual context. If needed, remove VLAN and BVI interface configuration information from the building block and then apply it.

### Procedure

- 
- Step 1** Choose **Config > Devices > All Devices**.  
The device tree appears.
- Step 2** Choose the virtual context that you want to apply a building block to, and choose **System > Primary Attributes**.  
The Primary Attributes window appears.
- Step 3** In the Tagged Building Block to Apply field, choose the building block you want to apply to the virtual context.
- Step 4** Click **Deploy Now**.
- 

### Related Topics

- [Enabling the Building Block Feature, page 16-5](#)
- [Applying a Building Block to Multiple Virtual Contexts, page 16-10](#)
- [Using Configuration Building Blocks, page 16-1](#)
- [Information About Building Block Versions and Tagging, page 16-4](#)
- [Extracting Building Blocks from Virtual Contexts, page 16-6](#)
- [Tagging Building Blocks, page 16-9](#)

## Applying a Building Block to Multiple Virtual Contexts

You can apply a tagged building block to one or more contexts by using the building block configuration screens.



### Note

Before applying a building block to a virtual context, confirm that the VLAN and BVI interfaces are defined correctly for the virtual context. If needed, remove VLAN and BVI interface configuration information from the building block and then apply it.

### Procedure

- 
- Step 1** Choose **Config > Building Blocks**.  
The All Building Blocks table appears.

- Step 2** In the All Building Blocks table, choose the tagged building block that you want to apply to one or more virtual contexts.
- Step 3** Choose **System > Primary Attributes**.  
The Primary Attributes configuration window appears.
- Step 4** In the Push Building Block to VCs field of the Primary Attributes configuration window, choose the contexts that you want to apply the building block to in the Available Items list, and click **Add**.  
They appear in the Selected Items list.  
To remove contexts that you do not want to apply the building block to, choose them in the Selected Items list, then click **Remove**. They items appear in the Available Items list.
- Step 5** Click **Save**. A progress bar reports status and the window refreshes when the operation is complete.
- 

#### Related Topics

- [Enabling the Building Block Feature, page 16-5](#)
- [Applying a Building Block to a Single Virtual Context, page 16-10](#)
- [Using Configuration Building Blocks, page 16-1](#)
- [Information About Building Block Versions and Tagging, page 16-4](#)
- [Creating Building Blocks, page 16-5](#)

## Displaying Building Block Use

You can identify the virtual contexts using a building block.

#### Procedure

---

- Step 1** Choose **Config > Devices**.  
The device tree appears.
- Step 2** In the device tree, choose **All VC**.  
The Virtual Contexts table appears.
- Step 3** In the Virtual Contexts table, use one of the following methods to display the building blocks being used:
- For a small number of contexts, scan the Building Block column to see which building blocks are in use on virtual contexts.
  - For a large number of contexts, click **Filter**. The window refreshes so that you can enter search criteria. In the field beneath the Building Block column heading, enter a building block name or search string, then click **Go**. The table refreshes with entries that match the search criteria.
- 

#### Related Topics

- [Enabling the Building Block Feature, page 16-5](#)
- [Using Configuration Building Blocks, page 16-1](#)
- [Information About Building Block Versions and Tagging, page 16-4](#)

- [Creating Building Blocks, page 16-5](#)
- [Extracting Building Blocks from Virtual Contexts, page 16-6](#)
- [Tagging Building Blocks, page 16-9](#)



# CHAPTER 17

## Monitoring Your Network

---

Date: 3/28/12



### Note

When naming ACE objects (such as a real server, virtual server, parameter map, class map, health probe, and so on), enter an alphanumeric string of 1 to 64 characters, which can include the following special characters: underscore (\_), hyphen (-), dot (.), and asterisk (\*). Spaces are not allowed.

If you are using ANM with an ACE module or ACE appliance and you configure a named object at the ACE CLI, keep in mind that ANM does not support all of the special characters that the ACE CLI allows you to use when configuring a named object. If you use special characters that ANM does not support, you may not be able to import or manage the ACE using ANM.

---

The ANM Monitor function allows you to monitor key areas of system usage. The following functionality is provided under Monitor in ANM:

- Dashboards—Operate as a central location for you to view monitoring results and track potential issues. There are three types of dashboards in ANM: ANM/Group Dashboard, ACE Dashboard, and Context Dashboard. Each dashboard provides quick access to all relevant monitoring pages. See [“Using Dashboards to Monitor Devices and Virtual Contexts” section on page 17-4](#).
- Events—Lists events originated from devices through syslog, SNMP traps. See [“Monitoring Events” section on page 17-55](#).
- Alarm Notifications—Allows you to define thresholds and view alarms. See [“Configuring Alarm Notifications on ANM” section on page 17-57](#) and [“Displaying Alarm Notifications” section on page 17-65](#).
- Settings—Allows you to do the following:
  - Display the current polling status of all the objects that ANM manages. See the [“Displaying the Polling Status of All Managed Objects” section on page 17-44](#).
  - Set global polling and SMTP configurations. See [“Setting Polling Parameters” section on page 17-46](#).
  - Export historical data. See [“Exporting Historical Data” section on page 52](#).
- Topology maps—Allows you to display a network topology map based on a selected virtual or real server. See [“Displaying Network Topology Maps” section on page 68](#).
- Tools—Allows you to verify connectivity (using the ping command) between a virtual context and an IP address that you specify. See [“Testing Connectivity” section on page 71](#).

**Note**

When ANM is unable to retrieve information for a monitored statistic, it displays one of the following status conditions in the table cell:

- N/A (Not Available)—Indicates that ANM was unable to poll the device for the information for one of the following reasons:
  - ANM is experiencing polling errors with the device.
  - ANM is not able to communicate with the device.
  - If a poll was recently initiated, ANM is in the process of gathering information from the device.
- Not Supported—Indicates that the device does not have the capability to provide the information. This condition can be caused when the device does not have the necessary SNMP instrumentation. It is possible that another similar device type is able to provide the statistical information because it has been updated with the necessary SNMP instrumentation.
- Not Applicable—Indicates that the particular information is not valid or not applicable for the device type, or ANM is unable to retrieve the information from the device because the information is not available through SNMP for the device type.

Before using the Monitoring functions, make sure that your devices are properly configured for polling (see [“Setting Up Devices for Monitoring” section on page 17-2](#)).

## Setting Up Devices for Monitoring

In order for ANM to successfully monitor your devices, you must configure the devices correctly for polling as show in [Table 17-1](#).

**Table 17-1**     *Configuring Devices for Monitoring*

| Device Type    | How to Configure                                | Parameters to Configure                                                                                                                                                                                                                                                                                                                                                                                                                                                                                                                                                                                             |
|----------------|-------------------------------------------------|---------------------------------------------------------------------------------------------------------------------------------------------------------------------------------------------------------------------------------------------------------------------------------------------------------------------------------------------------------------------------------------------------------------------------------------------------------------------------------------------------------------------------------------------------------------------------------------------------------------------|
| ACE modules    | Configure parameters on the Admin context only. | <ul style="list-style-type: none"> <li>• All devices must have a routable IP address from the ANM.</li> <li>• The management policy with the SNMP protocol must be associated to the IP address.</li> <li>• You must enable SNMPv2c with a matching SNMP community string between ANM and the devices to be polled. (See the <a href="#">“Configuring Virtual Contexts” section on page 6-1</a>.)</li> <li>• Before using the Monitoring functions, you must enable monitoring on all devices that you want ANM to monitor (see the <a href="#">“Setting Polling Parameters” section on page 17-46</a>).</li> </ul> |
| ACE appliances | Configure parameters on the Admin context only. |                                                                                                                                                                                                                                                                                                                                                                                                                                                                                                                                                                                                                     |

Table 17-1 Configuring Devices for Monitoring (continued)

| Device Type | How to Configure                                                                                                                            | Parameters to Configure                                                                                                                                                                                                                                                                                                                                                                                                                                                                                                                                                                                                                                                                                                                                             |
|-------------|---------------------------------------------------------------------------------------------------------------------------------------------|---------------------------------------------------------------------------------------------------------------------------------------------------------------------------------------------------------------------------------------------------------------------------------------------------------------------------------------------------------------------------------------------------------------------------------------------------------------------------------------------------------------------------------------------------------------------------------------------------------------------------------------------------------------------------------------------------------------------------------------------------------------------|
| CSS         | Configure parameters on the CSS devices that you want ANM to monitor. You cannot use ANM to configure the CSS.                              | <ul style="list-style-type: none"> <li>All devices must have a routable IP address from the ANM.</li> <li>For CSS devices, you must enable SNMPv2c with a matching SNMP community string between ANM and the devices to be polled. (See the <a href="#">“Configuring CSS Primary Attributes”</a> section on page 5-35.)</li> <li>For CSM devices, you must enable SNMPv2c with a matching SNMP community string on the Cat6K chassis in which the CSM resides. (See the <a href="#">“Configuring CSM Primary Attributes”</a> section on page 5-34.)</li> <li>Before using the Monitoring functions, you must enable monitoring on all devices that you want ANM to monitor (see the <a href="#">“Setting Polling Parameters”</a> section on page 17-46).</li> </ul> |
| CSM         | Configure parameters on the Cat6K chassis (in which the CSM resides) that you want ANM to monitor. You cannot use ANM to configure the CSM. |                                                                                                                                                                                                                                                                                                                                                                                                                                                                                                                                                                                                                                                                                                                                                                     |

**Related Topics**

- [Device Monitoring Features, page 17-3](#)
- [Using Dashboards to Monitor Devices and Virtual Contexts, page 17-4](#)
- [Monitoring Devices, page 17-24](#)

## Device Monitoring Features

ANM provides several features that allow you to monitor your devices when you click **Monitor**:

- **Dashboards**—Operate as a central location for you to view device and context monitoring results and track potential issues. There are three types of Dashboards in ANM: ANM/Group Dashboard, ACE Dashboard, and ACE Virtual Context Dashboard. Each Dashboard provides quick access to all relevant monitoring pages. See [“Using Dashboards to Monitor Devices and Virtual Contexts”](#) section on page 17-4.
- **System View**—Provides device information and a general overview of your system as a whole, including High Availability (HA) information and licensing information. System View is available only for CSS and CSM devices. See [“Monitoring the System”](#) section on page 17-25.
- **Resource Usage**—Provides resource usage information on connections and features. See [“Monitoring Resource Usage”](#) section on page 17-26. Resource usage is not available for CSS or CSM devices.
- **Traffic Summary**—Provides traffic information for your devices. Traffic Summary is available only for the ACE module, ACE appliance, and CSS. See [“Monitoring Traffic”](#) section on page 17-30.
- **Load Balancing**—Provides virtual server information and load balancing statistics. See [“Monitoring Load Balancing”](#) section on page 17-33 and [“Monitoring Load Balancing Statistics”](#) section on page 17-41.

- **Application Acceleration**—Displays optimization statistics for ACE appliances on which you have configured application acceleration functions. See the [“Monitoring Application Acceleration” section on page 17-43](#). This feature is only available on ACE appliances.
- **Polling Settings**—Allows you to set polling parameters. See the [“Setting Polling Parameters” section on page 17-46](#).
- **Historical Graphs**—Allows you to view historical data for a group of monitoring page statistics. See the [“Configuring Historical Trend and Real Time Graphs for Devices” section on page 17-48](#).

## Using Dashboards to Monitor Devices and Virtual Contexts

ANM dashboards allow for faster and more accurate assessment and analysis of device and virtual context health and usage, as well as performance. Corresponding monitoring views allow for quick access to details for further investigation into potential problems highlighted in the dashboards. Graphs, as well as monitoring screens, allow you to view historical data and compare the performance with the peer objects.



### Note

All client browsers require that you enable Adobe Flash Player 9 to properly display the monitoring graphs provided in ANM.

Dashboards in ANM provide:

- A central location for you to view monitoring highlights.
- Emphasis on potential issues that require your attention.
- Quick access to relevant ANM pages for more detailed monitoring data.

In each dashboard, there are a relevant set of dashboard panes. The information shown in the dashboard panes differ based on the device or groups that you select in the device tree. The dashboard panes are moveable element inside the dashboard that can be minimized/maximized, moved, and, if desired, removed from view. You can also display a larger (full) window view for a dashboard window.



### Note

Changes made to dashboard layout or pane selections are only applicable for the current session. Those changes are not maintained by ANM the next time you access an ANM dashboard.

The dashboard tables and graphs autorefresh every two minutes. If desired, you can disable autofreshing by clicking the Pause Autofresh button in the upper-right corner of the dashboard.



### Note

All dashboard contents are under Role-Based Access Control (RBAC). Options will be grayed or not displayed if proper permission has not been granted to the logged in user by the administrator. See the [“How ANM Handles Role-Based Access Control” section on page 18-8](#) for more information about RBAC in ANM.

This section includes the following topics:

- [ACE Dashboard, page 17-5](#)
- [ACE Virtual Context Dashboard, page 17-12](#)
- [ANM Group Dashboard, page 17-16](#)



## ACE Dashboard

The ACE Dashboard displays the information related to the ACE module or ACE appliance that is selected in the device tree. You access the ACE Dashboard by selecting **Monitor > Devices > ACE > Dashboard**.

Figure 17-1 illustrates the individual components of the ACE Dashboard.



### Note

The ANM software version that displays across the top of the window varies depending on your version of ANM.

**Figure 17-1 Example ACE Device Dashboard**



To enhance your viewing of the monitoring information in the ACE Dashboard, you can perform the following actions:

- Click and drag an individual dashboard pane to move it to another location within the ACE Dashboard.
- Use the Collapse/Expand buttons at the top right side of each dashboard pane to minimize/maximize a pane within the ACE Dashboard.
- Click the **Remove** button to remove a dashboard pane from the ACE Dashboard. Click the **Bring Back Closed Dashboard Panes** button at the top of the ACE Dashboard to open the closed dashboard pane.



### Note

When you close any of the panes in a dashboard by clicking the Remove button, all of the headers in the other dashboard panes turn black to indicate that a pane has been closed. To return the dashboard panes to normal, click the **Bring Back Closed Dashboard Panes** button to reload the removed dashboard pane.

- Click the **Screen View (Full)/Screen View (Normal)** buttons to display a larger (full) window view for the ACE Dashboard.

Changes made to dashboard layout or pane selections are only applicable for the current session. Those changes are not maintained by ANM the next time you access the ACE Dashboard.

The components of the individual ACE Dashboard panes are described in the following sections.

- [Device Information Table](#), page 17-6
- [License Status Table](#), page 17-6
- [High Availability Table](#), page 17-7
- [ACE Device Configuration Summary Table](#), page 17-7
- [Context With Denied Resource Usage Detected Table](#), page 17-8
- [Device Resource Usage Graph](#), page 17-9
- [Top 10 Current Resources Table](#), page 17-10
- [Control Plane CPU/Memory Graphs](#), page 17-11

## Device Information Table

The Device Information table lists the details that will identify the status of the selected ACE. It includes the following fields:

- **Host Name**—Host name of the ACE module or ACE appliance.
- **Device Status**—Device reachability status through SNMP and XML connectivity (Up or Down).
- **Device Type**—ACE device specifics for the ACE module or ACE appliance.
- **Management IP**—Management IP address of the admin virtual context.
- **Number of Contexts**—Number of configured contexts, including the Admin context and configured user contexts.
- **Software Version**—Release software version of the ACE module or ACE appliance.
- **Last Boot Reason**—Reason for the last reboot of the ACE (if available).
- **Uptime**—Length of time that the ACE has been up and running.

The data shown in this table is collected during device discovery as well as during periodic monitor polling. The timestamp shown in the status bar is from the last polled time of the Admin virtual context.

## License Status Table

The License Status table lists the license status of the selected ACE device. ANM uses the ACE **show license status** CLI command to obtain the license details. The timestamp shown in the status bar is from the last polled time of the Admin virtual context.

## High Availability Table

The HA Peer Information table lists the details of the HA peer, if configured in HA mode. It includes the following information:

- HA/FT Interface State—State of the local ACE. See the [“ACE High Availability Polling”](#) section on page 13-7.
- My IP Address—IP address of the local ACE.
- Peer IP Address—IP address of the peer ACE.
- Software Compatibility—Status of whether the software version of the local ACE and the software version of the peer ACE are compatible. Possible states are the INIT, COMPATIBLE, or INCOMPATIBLE state.
- License Compatibility—Status of whether the license of the local ACE and the license of the peer ACE are compatible. Possible states are the INIT, COMPATIBLE, or INCOMPATIBLE state.
- Number of FT Groups—Number of configured FT groups.
- Number of Heartbeats Transmitted—Total number of heartbeat packets transmitted.
- Number of Heartbeats Received—Total number of heartbeat packets received.

This data is collected during periodic monitoring polling. The timestamp shown in the status bar is from the last polled time of the Admin virtual context.

## ACE Device Configuration Summary Table

The Device Configuration Summary table displays the following information:

- Virtual Servers—Total count of virtual servers configured in all contexts and the count of virtual servers that are in the In Service or Out of Service state. ANM also identifies virtual servers that have a Status Not Available state (due to polled failing, polled disable, and so on) and have a Status Not Supported state (due to a lack of ACE SNMP support). A hyperlink enables you to view load balancing virtual server monitoring information based on the identified state (see the [“Monitoring Load Balancing on Virtual Servers”](#) section on page 17-33). For example, if you click the In Service hyperlink, you will see only the virtual servers that are currently in service.
- Real Servers—Total count of real servers configured in all contexts and the count of real servers that are in In Service and Out of Service. A hyperlink enables you to view load balancing real server monitoring information based on the identified state (see the [“Monitoring Load Balancing on Real Servers”](#) section on page 17-37). For example, if you click the In Service hyperlink, you will see only the real servers that are currently in service.
- Probes—Total count of probes configured in all contexts and the count of probes that are in the In Service and Out of Service state. A hyperlink enables you to view load balancing probe monitoring information based on the identified state (see the [“Monitoring Load Balancing on Probes”](#) section on page 17-40). For example, if you click the In Service hyperlink, you will see only the probes that are currently in service.
- Gigabit Ethernets—(ACE appliance only) Total count of Gigabit Ethernet physical interfaces configured on the ACE appliance based on their operational status of Up and Down. A hyperlink enables you to view traffic summary information based on the identified state (see the [“Monitoring Traffic”](#) section on page 17-30). For example, if you click the Up hyperlink, you will see only the Gigabit Ethernet physical interfaces that currently have an operational status of Up.

- VLANs—Total count of VLANs configured and the count of VLANs based on operational status - Up and Down. A hyperlink enables you to view traffic summary information based on the identified state (see the [“Monitoring Traffic” section on page 17-30](#)). For example, if you click the Up hyperlink, you will see only the VLAN interfaces that currently have an operational status of Up.
- Port Channels—(ACE appliance only) Total count of port channels configured on the ACE appliance based on their operational status of Up and Down. A hyperlink enables you to view traffic summary information based on the identified state (see the [“Monitoring Traffic” section on page 17-30](#)). For example, if you click the Up hyperlink, you will see only the port channels that currently have an operational status of Up.
- BVIs—Total count of BVI interfaces and the count of BVI interfaces based on their operational status of Up and Down. A hyperlink enables you to view traffic summary information based on the identified state (see the [“Monitoring Traffic” section on page 17-30](#)). For example, if you click the Up hyperlink, you will see only the BVI interfaces that currently have an operational status of Up.
- Certificates—Total count of SSL certificates and the count of SSL certificates that are expiring beyond 30 days, expired, or that are expiring within 30 days. A hyperlink accesses a popup window for you to view the SSL certificates list based on the selection, displaying the certificate name, device name, days to expire, expiration date, and the date it was evaluated for you to determine the days to expire. Certificates are considered expired if their expiration date is within the next day (rounded down the next day). A hyperlink in the device name allows you to navigate to the context-based SSL Certificate configuration page (see the [“Using SSL Certificates” section on page 11-5](#)).

This data is collected during discovery as well as during periodic monitoring polling. The timestamp shown in the status bar indicates a varying poll time; that is, different virtual contexts were polled and those context had different time stamps. The earliest time stamp of the polled virtual contexts is displayed in the status bar.

All counts shown in the Device Configuration Summary table are based on the operational status of the monitored objects listed above.

- Out Of Service—Indicates any status other than In Service (for example, Out Of Service, Failed, or Disabled).
- Status not available—Indicates that ANM was unable to poll the operational status of this object. The display of this operational status could be due to polling errors or the device was unreachable. Also, if a poll was recently initiated, this operational status could indicate that ANM is in the process of collecting data.
- Status not supported—Indicates that the device does not have the capability to provide an operational status of this object. The display of this operational status could be due to missing SNMP instrumentation on earlier ACE devices.

## Context With Denied Resource Usage Detected Table

The Context With Denied Resource Usage Detected table lists all contexts for which the resource request is denied after reaching the maximum limit. An increase in the deny count (that is, the deny rate) results in the relevant context resource type appearing in this table. ANM obtains the count information by using the ACE **show resource usage** CLI command, which collects the information from the following MIBs: `crIResourceLimitReqsDeniedCount` and `crIRateLimitResourceReqsDeniedCount`.

This table includes the following information:

- Context—Name of the configured context that contains a denied resource.
- Resource Type—Type of system resource in the context.

- Denies/Second—Number of denied resources (per second) as a result of oversubscription or resource depletion.
- Total Deny Count—Number of denied uses of the resource since the resource statistics were last cleared.
- Last Polled Count—Date and time of the last time that ANM polled the device to display the current values.

**Note**

The Context With Denied Resource Usage Detected table does not display the sticky denied resource count because this count does not increment when the ACE sticky resources are exhausted. The ACE's sticky table can hold a maximum of four million entries (four million simultaneous users). When the table reaches the maximum number of entries, additional sticky connections cause the table to wrap and the first users become unstuck from their respective servers.

A hyperlink allows you to access the Resource Usage monitoring page to view a detailed list of resources used and denied counts (see the “[Monitoring Resource Usage](#)” section on page 17-26).

## Device Resource Usage Graph

For each resource type, the ACE Dashboard displays the Top 3 virtual contexts that consume the resources in the Device Resource Usage graph (Figure 17-2). A tooltip is added to display the Top 3 context names and their consumption, consumption of the resource by rest of the contexts and the total consumption by all contexts. This data is collected by ANM by using the ACE **show resource usage** CLI command. The timestamp shown in the status bar indicates a varying poll time; that is, different virtual contexts were polled and those context had different time stamps. The earliest time stamp of the polled virtual contexts is displayed in the status bar.

**Figure 17-2** Device Resource Usage Graph



To toggle the display of the Device Resource Usage graph in the monitoring window:

- Click **View As Chart** to display the object data as a graph.
- Click **View As Grid** to display the object data as a numerical line grid.

**Note**

If you want to save the graph as a JPEG file for archive or other purposes, click the **Show As Image** button. When you mouse over the graph, the Image Toolbar appears. From the Image Toolbar, you can save the graph as a JPEG or send it in an email. You can also print the graph if desired.

If you want to export object data to Microsoft Excel for archive or other purposes, click the **Export to Excel** link in the View As Grid object display.

Hyperlinks allow you to access the individual resource usage page for more details (see the “[Monitoring Resource Usage](#)” section on page 17-26).

**Note**

ACL Memory (for ACE module and ACE appliance) and Application Acceleration (for ACE appliance only) do not appear in the Device Resource Usage graph. To view the detailed counters, click the hyperlink to access individual resource usage page.

## Top 10 Current Resources Table

The Top 10 Resource Usage table (Figure 17-3) displays the Top 10 resource types that have been evaluated for high resource utilization. The resource with highest utilization appears at the top. This data is collected by ANM by using the ACE `show resource usage` CLI command.

**Figure 17-3** Top 10 Current Resources Table—ACE Dashboard

| Last Hour | Resource Name                             | Used By                      | Current Usage           | Avg.     | Max.     | Last Polled Time     |
|-----------|-------------------------------------------|------------------------------|-------------------------|----------|----------|----------------------|
|           | Syslog Buffer Size (Bytes)                | Global Pool of 192.168.85.35 | 116.558% (735232630784) | 116.558% | 116.558% | 04-Aug-2009 06:42:56 |
|           | Throughput (Bytes/Sec)                    | 192.168.85.35 Admin          | 0.001% (266/33554432)   | 0.001%   | 0.003%   | 04-Aug-2009 06:42:56 |
|           | Application Acceleration (Connections)    | Global Pool of 192.168.85.35 | 0.000% (0/10)           | 0.000%   | 0.000%   | 04-Aug-2009 06:42:56 |
|           | ACL Memory (Bytes)                        | Global Pool of 192.168.85.35 | 0.000% (0/7518784)      | 0.000%   | 0.000%   | 04-Aug-2009 06:42:56 |
|           | Bandwidth (Bytes/Sec)                     | Global Pool of 192.168.85.35 | 0.000% (0/140782272)    | 0.000%   | 0.000%   | 04-Aug-2009 06:42:56 |
|           | Concurrent Connections (Connections)      | Global Pool of 192.168.85.35 | 0.000% (0/0)            | 0.000%   | 0.000%   | 04-Aug-2009 06:42:56 |
|           | Connection Rate (Connections/Sec)         | Global Pool of 192.168.85.35 | 0.000% (1/1000000)      | 0.000%   | 0.000%   | 04-Aug-2009 06:42:56 |
|           | HTTP-comp Rate                            | Global Pool of 192.168.85.35 | 0.000% (0/9878560)      | 0.000%   | 0.000%   | 04-Aug-2009 06:42:56 |
|           | Inspect Connection Rate (Connections/Sec) | Global Pool of 192.168.85.35 | 0.000% (0/16000)        | 0.000%   | 0.000%   | 04-Aug-2009 06:42:56 |
|           | MAC Miss Rate (Connections/Sec)           | Global Pool of 192.168.85.35 | 0.000% (0/400)          | 0.000%   | 0.000%   | 04-Aug-2009 06:42:56 |

This table includes the following information:

- Last Hour—Plot of high resource utilization during the past hour.
- Resource Name—Type of system resource in the context.
- Used By—Name of the virtual context that is placing the high demands on the resource. The Global Pool usage is critical in the setup where one or more contexts are configured to make use of the global pool once their reserved resource are depleted and resource is free in the global pool. In this situation, if the global pool is depleted, multiple contexts may be starved for resource.

**Note**

Contexts configured to make use of the global pool will not be evaluated for the Top 10 Resource Usage table.

- Current Usage—Active concurrent instances or the current rate of the resource.
- Average—Average value of resource usage (based on the last hour).
- Max.—Highest value of resource usage (based on the last hour).
- Last Polled Time—Date and time of the last time that ANM polled the device to display the current values.

Hyperlinks allow you to access the individual resource usage page for more details (see the “[Monitoring Resource Usage](#)” section on page 17-26).

You can choose to show or hide the syslog buffer information that displays in the Top 10 Current Resources pane. You may want to hide this information because it will always show 100 percent after the buffer becomes full and starts to wrap. For more information, see the “[Managing the Syslog Buffer Display in the All Devices Dashboard](#)” section on page 18-66.

## Control Plane CPU/Memory Graphs

The Control Plane CPU/Memory graphs (Figure 17-4) show the utilization of the ACE CPU. This data consists of two graphs:

- The Control Plane CPU Usage graph shows the utilization of the ACE CPU as a percentage.
- The Control Plane Memory graph displays the consumed memory on Kbytes. A tooltip is added to display the Cache Memory, Total Memory, Shared Memory, Buffer Memory, and Free Memory usage as a percentage.

To toggle the display of the Control Plane CPU/Memory graph in the monitoring window:

- Click **View As Chart** to display the object data as a graph.
- Click **View As Grid** to display the object data as a numerical line grid.



### Note

If you want to save the graph as a JPEG file for archive or other purposes, click the **Show As Image** button. When you mouse over the graph, the Image Toolbar appears. From the Image Toolbar, you can save the graph as a JPEG or send it in an email. You can also print the graph if desired.

If you want to export object data to Microsoft Excel for archive or other purposes, click the **Export to Excel** link in the View As Grid object display.

**Figure 17-4** Control Plane CPU/Memory Graphs

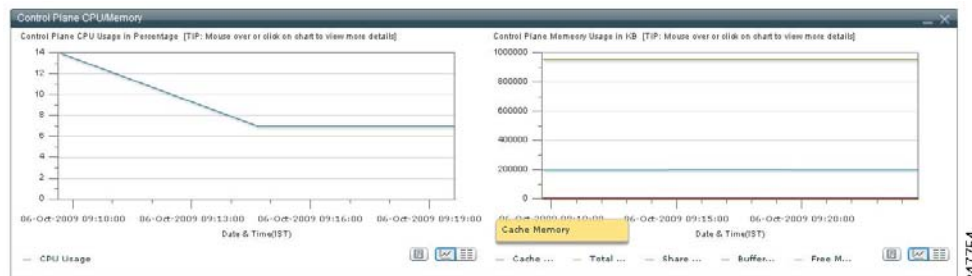

247754



## ACE Virtual Context Dashboard

The ACE Virtual Context Dashboard displays monitoring information for an ACE virtual context selected from the device tree. You access the ACE Virtual Context Dashboard by selecting **Monitor > Devices > virtual\_context > Dashboard**.

Figure 17-5 illustrates the individual components of the ACE Virtual Context Dashboard.



### Note

The ANM software version that displays across the top of the window varies depending on your version of ANM.

Figure 17-5 ACE Virtual Context Dashboard

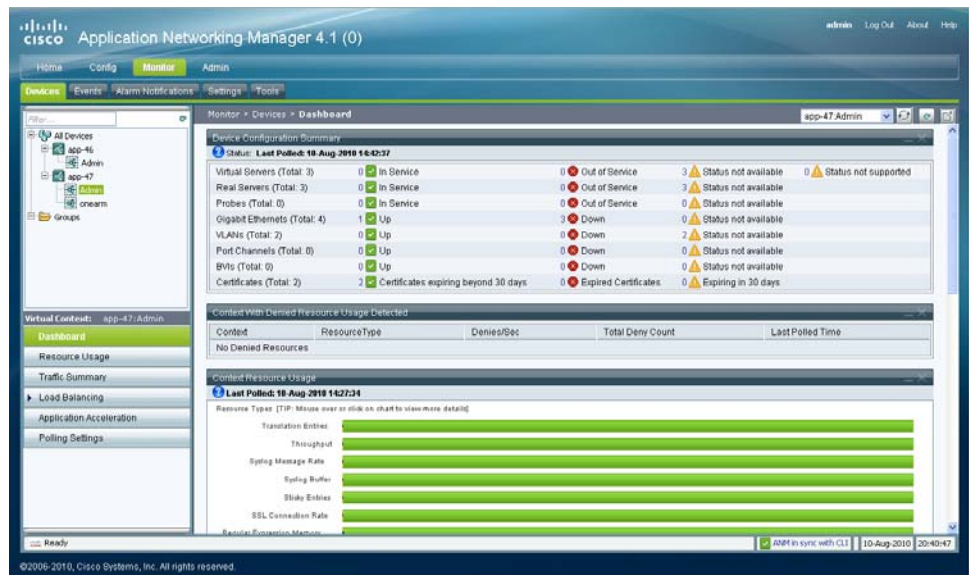

To enhance your viewing of the monitoring information in the ACE Virtual Context Dashboard, you can perform the following actions:

- Click and drag an individual dashboard pane to move it to another location within the ACE Virtual Context Dashboard.
- Use the Collapse/Expand buttons at the top right side of each dashboard pane to minimize/maximize a pane within the ACE Virtual Context Dashboard.
- Click the **Remove** button to remove a dashboard pane from the ACE Virtual Context Dashboard. Click the **Bring Back Closed Dashboard Panes** button at the top of the ACE Virtual Context Dashboard to open the closed dashboard pane.



### Note

When you close any of the panes in a dashboard by clicking the Remove button, all of the headers in the other dashboard panes turn black to indicate that a pane has been closed. To return the dashboard panes to normal, click the **Bring Back Closed Dashboard Panes** button to reload the removed dashboard pane.

- Click the **Screen View (Full)/Screen View (Normal)** buttons to display a larger (full) window view for the ACE Dashboard.



Changes made to dashboard layout or pane selections are only applicable for the current session. Those changes are not maintained by ANM the next time you access the ACE Virtual Context Dashboard.

The components of the individual ACE Virtual Context Dashboard panes are described in the following sections.

- [ACE Virtual Context Device Configuration Summary Table, page 17-13](#)
- [Context With Denied Resource Usage Detected Table, page 17-14](#)
- [Context Resource Usage Graph, page 17-15](#)
- [Load Balancing Servers Performance Graphs, page 17-15](#)

## ACE Virtual Context Device Configuration Summary Table

The Device Configuration Summary table displays the following information:

- **Virtual Servers**—Total count of virtual servers configured in all contexts and the count of virtual servers that are in the In Service and Out of Service state. ANM also identifies virtual servers that have a Status Not Available state (due to polled failing, polled disable, and so on) and have a Status Not Supported state (due to a lack of ACE SNMP support). A hyperlink enables you to view load balancing virtual server monitoring information based on the identified state (see the [“Monitoring Load Balancing on Virtual Servers” section on page 17-33](#)). For example, if you click the In Service hyperlink, you will see only the virtual servers that are currently in service.
- **Real Servers**—Total count of real servers configured in all contexts and the count of real servers that are in In Service and Out of Service. A hyperlink enables you to view load balancing real server monitoring information based on the identified state (see the [“Monitoring Load Balancing on Real Servers” section on page 17-37](#)). For example, if you click the In Service hyperlink, you will see only the real servers that are currently in service.
- **Probes**—Total count of probes configured in all contexts and the count of probes that are in the In Service and Out of Service state. A hyperlink enables you to view load balancing probe monitoring information based on the identified state (see the [“Monitoring Load Balancing on Probes” section on page 17-40](#)). For example, if you click the In Service hyperlink, you will see only the probes that are currently in service.
- **Gigabit Ethernets**—(ACE appliance only) Total count of Gigabit Ethernet physical interfaces configured on the ACE appliance based on their operational status of Up and Down. A hyperlink enables you to view traffic summary information based on the identified state (see the [“Monitoring Traffic” section on page 17-30](#)). For example, if you click the Up hyperlink, you will see only the Gigabit Ethernet physical interfaces that currently have an operational status of Up.
- **VLANs**—Total count of VLANs configured and the count of VLANs based on operational status - Up and Down. A hyperlink enables you to view traffic summary information based on the identified state (see the [“Monitoring Traffic” section on page 17-30](#)). For example, if you click the Up hyperlink, you will see only the VLAN interfaces that currently have an operational status of Up.
- **Port Channels**—(ACE appliance only) Total count of port channels configured on the ACE appliance based on their operational status of Up and Down. A hyperlink enables you to view traffic summary information based on the identified state (see the [“Monitoring Traffic” section on page 17-30](#)). For example, if you click the Up hyperlink, you will see only the port channels that currently have an operational status of Up.
- **BVIs**—Total count of BVI interfaces and the count of BVI interfaces based on their operational status of Up and Down. A hyperlink enables you to view traffic summary information based on the identified state (see the [“Monitoring Traffic” section on page 17-30](#)). For example, if you click the Up hyperlink, you will see only the BVI interfaces that currently have an operational status of Up.

- **Certificates**—Total count of SSL certificates and the count of SSL certificates that are expiring beyond 30 days, expired, or that are expiring within 30 days. A hyperlink accesses a popup window for you to view the SSL certificates list based on the selection, displaying the certificate name, device name, days to expire, expiration date, and the date it was evaluated for you to determine the days to expire. Certificates are considered expired if their expiration date is within the next day (rounded down the next day). A hyperlink in the device name allows you to navigate to the context-based SSL Certificate configuration page (see the [“Using SSL Certificates”](#) section on page 11-5).

Counts are based on the selected ACE virtual context and not for all ACE virtual contexts.

This data is collected during discovery as well as during periodic monitoring polling. The timestamp shown in the status bar indicates a varying poll time; that is, different virtual contexts were polled and the contexts had different time stamps. The earliest time stamp of the polled virtual contexts is displayed in the status bar.

All counts shown in the Device Configuration Summary table are based on the operational status of the monitored objects listed above.

- **Out Of Service**—Indicates any status other than In Service (for example, Out Of Service, Failed, or Disabled).
- **Status not available**—Indicates that ANM was unable to poll the operational status of this object. The display of this operational status could be due to polling errors or the device was unreachable. Also, if a poll was recently initiated, this operational status could indicate that ANM is in the process of collecting data.
- **Status not supported**—Indicates that the device does not have the capability to provide an operational status of this object. The display of this operational status could be due to missing SNMP instrumentation on earlier ACE devices.

## Context With Denied Resource Usage Detected Table

The Context With Denied Resource Usage Detected table lists all contexts for which the resource request is denied after reaching the maximum limit. An increase in the deny count (that is, the deny rate) will result in the relevant context resource type to appear in this table. This data is collected by ANM by using the ACE **show resource usage** CLI command.

This table includes the following information:

- **Context**—Name of the configured context that contains a denied resource.
- **Resource Type**—Type of system resource in the context.
- **Denies/Second**—Number of denied resources (per second) as a result of oversubscription or resource depletion.
- **Total Deny Count**—Number of denied uses of the resource since the resource statistics were last cleared.
- **Last Polled Count**—Date and time of the last time that ANM polled the device to display the current values.



### Note

---

This information is collected from the following MIBs: `crlResourceLimitReqsDeniedCount` and `crlRateLimitResourceReqsDeniedCount`.

---

A hyperlink allows you to access the Resource Usage monitoring page to view a detailed list of resources used and denied counts (see the [“Monitoring Resource Usage”](#) section on page 17-26).

## Context Resource Usage Graph

The Context Resource Usage graph (see [Figure 17-5](#)) displays the details of each resource type utilized by the selected contexts. For each resource type, the graph includes the following monitoring statistics: Used, Global Available, and Guaranteed. This data is collected by ANM by using the ACE **show resource usage** CLI command.

To toggle the display of the Context Resource Usage graph in the monitoring window:

- Click **View As Chart** to display the object data as a graph.
- Click **View As Grid** to display the object data as a numerical line grid.

**Note**

If you want to save the graph as a JPEG file for archive or other purposes, click the **Show As Image** button. When you mouse over the graph, the Image Toolbar appears. From the Image Toolbar, you can save the graph as a JPEG or send it in an email. You can also print the graph if desired.

If you want to export object data to Microsoft Excel for archive or other purposes, click the **Export to Excel** link in the View As Grid object display.

Hyperlinks allow you to access the individual resource usage page for more details (see the “[Monitoring Resource Usage](#)” section on page 17-26).

**Note**

ACL Memory (for ACE module and ACE appliance) and Application Acceleration (for ACE appliance only) do not appear in the Device Resource Usage graph. To view the detailed counters, click the hyperlink to access individual resource usage page.

## Load Balancing Servers Performance Graphs

The Load Balancing Servers Performance graphs ([Figure 17-6](#)) include:

- **Top 5 Virtual Servers**—Displays the top five virtual servers in the selected virtual context. You can select from server statistics (such as High Connection Rate, Dropped Connection Rate, and so on) that are collected by ANM polling for top performance evaluation.
- **Top 5 Real Servers**—Displays the top five real servers in the selected virtual context. You can select from server statistics (such as High Connection Rate, Dropped Connection Rate, and so on) that are collected by ANM polling for top performance evaluation.

You select the statistic from the Select Statistics drop-down list.

To toggle the display of a Load Balancing Servers Performance graph in the monitoring window:

- Click **View As Chart** to display the object data as a graph.
- Click **View As Grid** to display the object data as a numerical line grid.

**Note**

If you want to save the graph as a JPEG file for archive or other purposes, click the **Show As Image** button. When you mouse over the graph, the Image Toolbar appears. From the Image Toolbar, you can save the graph as a JPEG or send it in an email. You can also print the graph if desired.

If you want to export object data to Microsoft Excel for archive or other purposes, click the **Export to Excel** link in the View As Grid object display.

Hyperlinks allow you to access the corresponding monitoring screens for more details:

- [Monitoring Load Balancing on Virtual Servers, page 17-33](#)
- [Monitoring Load Balancing on Real Servers, page 17-37](#)

**Figure 17-6** Load Balancing Servers Performance Graphs

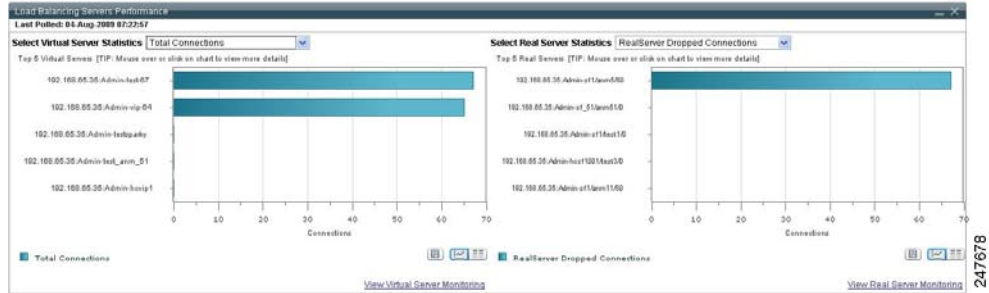

## ANM Group Dashboard

The ANM Group Dashboard displays overall information of the ANM server. You can specify to view details for the ANM-created All Devices Group and for a user-defined ANM device group (see the “Monitoring Device Groups” section on page 17-23). You access the ANM Group Dashboard by choosing **Monitor > Devices > Groups > All Devices > Dashboard**.

Figure 17-7 illustrates the individual components of the ANM Group Dashboard.



### Note

The ANM software version that displays across the top of the window varies depending on your version of ANM.

**Figure 17-7** ANM Group Dashboard

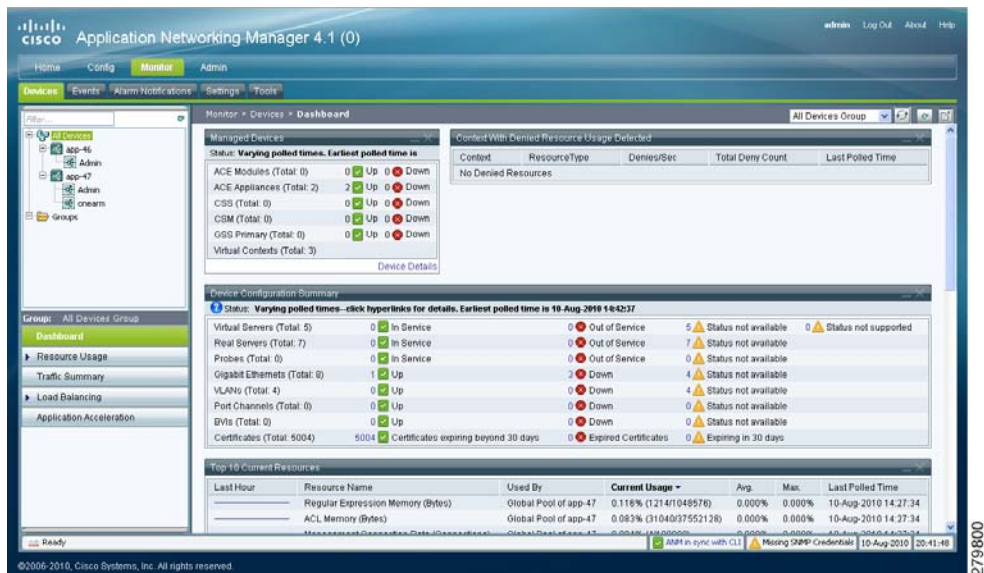

To enhance your viewing of the monitoring information in the ANM Group Dashboard, you can perform the following actions:

- Click and drag an individual dashboard pane to move it to another location within the ANM Group Dashboard.
- Use the Collapse/Expand buttons at the top right side of each dashboard pane to minimize/maximize a pane within the ANM Group Dashboard.
- Click the **Remove** button to remove a dashboard pane from the ANM Group Dashboard. Click the **Bring Back Closed Dashboard Panes** button at the top of the ANM Group Dashboard to open the closed dashboard pane.



**Note** When you close any of the panes in a dashboard by clicking the Remove button, all of the headers in the other dashboard panes turn black to indicate that a pane has been closed. To return the dashboard panes to normal, click the **Bring Back Closed Dashboard Panes** button to reload the removed dashboard pane.

- Click the **Screen View (Full)/Screen View (Normal)** buttons to display a larger (full) window view for the ACE Dashboard.

Changes made to dashboard layout or pane selections are only applicable for the current session. Those changes are not maintained by ANM the next time you access the ANM Group Dashboard.

The components of the individual ANM Group Dashboard panes are described in the following sections.

- [Managed Devices Table, page 17-17](#)
- [Context With Denied Resource Usage Detected Table, page 17-18](#)
- [ANM Group Device Configuration Summary Table, page 17-18](#)
- [Top 10 Current Resources Table, page 17-20](#)
- [Latest 5 Alarms Notifications Table, page 17-21](#)
- [Latest 5 Critical Events Table, page 17-21](#)
- [Contexts Performance Overview Graph, page 17-22](#)

## Managed Devices Table

The Managed Devices table displays the total count of devices in the selected ANM device group and the count based on the state (Up or Down) of the imported ACE modules, ACE appliances, CSM, GSS, and CSS devices. The data shown in this table are collected during device discovery as well as during periodic monitor polling. The state of the individual device is identified from its XML connectivity and SNMP status (whichever is applicable). The most recent information is used to identify device status.

Click the **Device Details** hyperlink to view a popup window containing the following device information:

- **Device Name**—Name of the device managed by ANM.
- **State**—Operational state of the device (Up or Down). If the State is Down, ANM displays whether the state has been detected through SNMP or XML.
- **Device Type**—Device type assigned to the imported device by ANM (for example, ACE v 2.0).
- **# of VCs**—Number of configured ACE virtual contexts, including the Admin context and configured user contexts. This value is only applicable for the ACE module and ACE appliance.

- Last Polled Time—Date and time of the last time that ANM polled the device to display the current values.

The data shown in this table is collected during device discovery as well as during periodic monitor polling. The timestamp shown in the status bar indicates a varying poll time; that is, different virtual contexts were polled and the contexts had different time stamps. The earliest time stamp of the polled virtual contexts is displayed in the status bar.

Hyperlinks in the popup window allow you to access the individual ACE Device Dashboard for more details (see the [“ACE Dashboard” section on page 17-5](#)).

## Context With Denied Resource Usage Detected Table

The Context With Denied Resource Usage Detected table lists all contexts for which the resource request is denied after reaching the maximum limit. An increase in the deny count (that is, the deny rate) will result in the relevant context resource type to appear in this table. This data is collected by ANM by using the ACE **show resource usage** CLI command.

This table includes the following information:

- Context—Name of the configured context that contains a denied resource.
- Resource Type—Type of system resource in the context.
- Denies/Second—Number of denied resources (per second) as a result of oversubscription or resource depletion.
- Total Deny Count—Number of denied uses of the resource since the resource statistics were last cleared.
- Last Polled Count—Date and time of the last time that ANM polled the device to display the current values.



### Note

This information is collected from the following MIBs: `crlResourceLimitReqsDeniedCount` and `crlRateLimitResourceReqsDeniedCount`.

A hyperlink allows you to access to Resource Usage monitoring page to view a detailed list of resources used and denied counts (see the [“Monitoring Resource Usage” section on page 17-26](#)).

## ANM Group Device Configuration Summary Table

The Device Configuration Summary table displays the following information:

- Virtual Servers—(ACE only) Total count of virtual servers configured in all contexts and the count of virtual servers that are in the In Service and Out of Service state. ANM also identifies virtual servers that have a Status Not Available state (due to polled failing, polled disable, and so on) and have a Status Not Supported state (due to a lack of ACE SNMP support). A hyperlink enables you to view load balancing virtual server monitoring information based on the identified state (see the [“Monitoring Load Balancing on Virtual Servers” section on page 17-33](#)). For example, if you click the In Service hyperlink, you will see only the virtual servers that are currently in service.
- Real Servers—(ACE only) Total count of real servers configured in all contexts and the count of real servers that are in In Service and Out of Service. A hyperlink enables you to view load balancing real server monitoring information based on the identified state (see the [“Monitoring Load Balancing on Real Servers” section on page 17-37](#)). For example, if you click the In Service hyperlink, you will see only the real servers that are currently in service.



- Probes—(ACE only) Total count of probes configured in all contexts and the count of probes that are in the In Service and Out of Service state. A hyperlink enables you to view load balancing probe monitoring information based on the identified state (see the [“Monitoring Load Balancing on Probes” section on page 17-40](#)). For example, if you click the In Service hyperlink, you will see only the probes that are currently in service.
- Gigabit Ethernets—(ACE appliance only) Total count of Gigabit Ethernet physical interfaces configured on the ACE appliance based on their operational status of Up and Down. A hyperlink enables you to view traffic summary information based on the identified state (see the [“Monitoring Traffic” section on page 17-30](#)). For example, if you click the Up hyperlink, you will see only the Gigabit Ethernet physical interfaces that currently have an operational status of Up.
- VLANs—(ACE only) Total count of VLANs configured and the count of VLANs based on operational status - Up and Down. A hyperlink enables you to view traffic summary information based on the identified state (see the [“Monitoring Traffic” section on page 17-30](#)). For example, if you click the Up hyperlink, you will see only the VLAN interfaces that currently have an operational status of Up.
- Port Channels—(ACE appliance only) Total count of port channels configured on the ACE appliance based on their operational status of Up and Down. A hyperlink enables you to view traffic summary information based on the identified state (see the [“Monitoring Traffic” section on page 17-30](#)). For example, if you click the Up hyperlink, you will see only the port channels that currently have an operational status of Up.
- BVIs—(ACE only) Total count of BVI interfaces and the count of BVI interfaces based on their operational status of Up and Down. A hyperlink enables you to view traffic summary information based on the identified state (see the [“Monitoring Traffic” section on page 17-30](#)). For example, if you click the Up hyperlink, you will see only the BVI interfaces that currently have an operational status of Up.
- Certificates—(ACE only) Total count of SSL certificates and the count of SSL certificates that are valid, expired, or that are expiring within 30 days. A hyperlink accesses a popup window for you to view the SSL certificates list based on the selection, displaying the certificate name, device name, days to expire, expiration date, and the date it was evaluated for you to determine the days to expire. Certificates are considered expired if their expiration date is within the next day (rounded down the next day). A hyperlink in the device name allows you to navigate to the context-based SSL Certificate configuration page (see the [“Using SSL Certificates” section on page 11-5](#)).
- GSS VIP Answers—(GSS only) Total number of configured VIP answers and their operating state, which is either Active or Other. The Other state can indicate any of the following states: Suspended, Operational Suspended, Unknown, Failed, or N/A.
- GSS DNS Rules—(GSS only) Total number of configured DNS rules and their operating state, which is either Active or Other. The Other state can indicate either the Suspended or N/A states.

This data is collected during discovery as well as during periodic monitoring polling. The timestamp shown in the status bar indicates a varying poll time; that is, different virtual contexts were polled and the contexts had different time stamps. The earliest time stamp of the polled virtual contexts is displayed in the status bar.

All counts shown in the Device Configuration Summary table are based on the operational status of the monitored objects listed above.

- Out Of Service—Indicates any status other than In Service (for example, Out Of Service, Failed, or Disabled).

- Status not available—Indicates that ANM was unable to poll the operational status of this object. The display of this operational status could be due to polling errors or the device was unreachable. Also, if a poll was recently initiated, this operational status could indicate that ANM is in the process of collecting data.
- Status not supported—Indicates that the device does not have the capability to provide an operational status of this object. The display of this operational status could be due to missing SNMP instrumentation on the CSS or on earlier ACE devices.

## Top 10 Current Resources Table

The Top 10 Resource Usage table (Figure 17-8) displays the top 10 resource types that have been evaluated for high resource utilization. The resource with highest utilization appears at the top. This data is collected by ANM by using the ACE **show resource usage** CLI command.

**Figure 17-8** Top 10 Current Resources Table—ANM Group Dashboard

| Last Hour | Resource Name                             | Used By                         | Current Usage ▾             | Avg.   | Max.   | Last Polled Time        |
|-----------|-------------------------------------------|---------------------------------|-----------------------------|--------|--------|-------------------------|
|           | Syslog Buffer Size (Bytes)                | Global Pool of scim-36          | 100.000%<br>(421888/421888) | 0.000% | 0.000% | 30-Jul-2009<br>23:44:11 |
|           | ACL Memory (Bytes)                        | <a href="#">c6k-130.9:Admin</a> | 3.990%<br>(313568/7858944)  | 3.990% | 3.990% | 31-Jul-2009<br>15:02:20 |
|           | Management Connection Rate (Connections)  | <a href="#">scim-36:Admin</a>   | 0.280% (14/5000)            | 0.000% | 0.000% | 30-Jul-2009<br>23:44:11 |
|           | Regular Expression Memory (Bytes)         | Global Pool of scim-36          | 0.218%<br>(914/419431)      | 0.000% | 0.000% | 30-Jul-2009<br>23:44:11 |
|           | ACL Memory (Bytes)                        | Global Pool of scim-36          | 0.185%<br>(6976/3761520)    | 0.000% | 0.000% | 30-Jul-2009<br>23:44:11 |
|           | Bandwidth (Bytes/Sec)                     | <a href="#">scim-36:Admin</a>   | 0.008%<br>(2210/26342170)   | 0.000% | 0.000% | 30-Jul-2009<br>23:44:11 |
|           | Management Traffic Rate (Connections/Sec) | <a href="#">scim-36:Admin</a>   | 0.008%<br>(2118/25000000)   | 0.000% | 0.000% | 30-Jul-2009<br>23:44:11 |
|           | Throughput (Bytes/Sec)                    | <a href="#">scim-36:Admin</a>   | 0.007%<br>(92/1342170)      | 0.000% | 0.000% | 30-Jul-2009<br>23:44:11 |
|           | Concurrent Connections (Connections)      | <a href="#">scim-36:Admin</a>   | 0.003% (21/600000)          | 0.000% | 0.000% | 30-Jul-2009<br>23:44:11 |
|           | Sticky Entries                            | <a href="#">c6k-130.9:Admin</a> | 0.000% (0/0)                | 0.000% | 0.000% | 31-Jul-2009<br>15:02:20 |

This table includes the following information:

- Last Hour—Plot of high resource utilization during the past hour.
- Resource Name—Type of system resource in the context.
- Used By—Name of the virtual context that is placing the high demands on the resource. The Global Pool usage is critical in the setup where one or more contexts are configured to make use of the global pool once their reserved resource are depleted and resource is free in the global pool. In this situation, if the global pool is depleted, multiple contexts may be starved for resource.



**Note** Contexts configured to make use of the global pool will not be evaluated for the Top 10 Resource Usage table.

- Current Usage—Active concurrent instances or the current rate of the resource.
- Average—Average value of resource usage (based on the last hour).



- Max.—Highest value of resource usage (based on the last hour).
- Last Polled Time—Date and time of the last time that ANM polled the device to display the current values.

Hyperlinks allow you to access the individual resource usage page for more details (see the “[Monitoring Resource Usage](#)” section on page 17-26).

You can choose to show or hide the syslog buffer information that displays in the Top 10 Current Resources pane. You may want to hide this information because it will always show 100 percent after the buffer becomes full and starts to wrap (see the “[Managing the Syslog Buffer Display in the All Devices Dashboard](#)” section on page 18-66).

## Latest 5 Alarms Notifications Table

The Latest 5 Alarm Notification table (Figure 17-9) displays the most recent five alarms for ANM along with a summary that explains the number of Critical, Major, Minor, and Informational alarms. This function interacts with the user-configured ANM alarm and threshold features (see the “[Configuring Alarm Notifications on ANM](#)” section on page 17-57).

**Figure 17-9** Latest 5 Alarms Notifications Table

| Device        | Severity | Time                 | Category                    | Details                                                                          |
|---------------|----------|----------------------|-----------------------------|----------------------------------------------------------------------------------|
| app-47_0nearm | Minor    | 10-Aug-2010 20:51:09 | Interface Operational State | vian1001 % Interface Operational State reached the Up state defined in           |
| app-47_Admin  | Minor    | 10-Aug-2010 20:51:09 | Interface Operational State | gigabitEthernet1/2 % Interface Operational State reached the Up state defined in |
| app-47_Admin  | Minor    | 10-Aug-2010 20:51:09 | Interface Operational State | gigabitEthernet1/1 % Interface Operational State reached the Up state defined in |
| app-47_Admin  | Minor    | 10-Aug-2010 20:51:09 | Interface Operational State | vian100 % Interface Operational State reached the Up state defined in            |



### Note

By default, no thresholds are configured in ANM.

This table includes the following information:

- Device—Name of the ACE device (appliance or module).
- Severity—Severity level of the threshold, which can be one of the following: Info, Critical, Major, Minor.
- Time—ANM timestamp at which the alarm occurred.
- Category—Alarm name.
- Details—Additional information about the alarm.

A hyperlink allow you to view alarm notifications (see the “[Displaying Alarm Notifications](#)” section on page 17-65).

## Latest 5 Critical Events Table

The Latest 5 Critical Events table display most recent five critical events that ANM receives from devices, including traps and high severity syslogs. ANM displays a summary that explains the number of Emergency, Alert, and Critical alarms. ANM displays critical events if the imported ACE device has been configured to send syslogs and traps to ANM. For information about configuring the ACE to send syslogs and traps, see either the *Cisco Application Control Engine Module System Message Guide* or the *Cisco 4700 Series Application Control Engine Appliance System Message Guide*.

Figure 17-10 Latest 5 Critical Events Table



| Device/Context | Severity | Time                 | Type   | Details                                                     |
|----------------|----------|----------------------|--------|-------------------------------------------------------------|
| app-47 Admin   | Critical | 11-Aug-2010 12:57:59 | Syslog | User 'admin' executed the 'nservice' command.               |
| app-47 Admin   | Critical | 11-Aug-2010 12:57:59 | Syslog | User 'admin' executed the 'nservice' command.               |
| app-47 Admin   | Critical | 11-Aug-2010 12:57:59 | Syslog | User 'admin' executed the 'serverfarm host test' command.   |
| app-47 Admin   | Critical | 11-Aug-2010 12:57:59 | Syslog | User 'admin' executed the 'server anm-vm-115' command.      |
| app-47 Admin   | Critical | 11-Aug-2010 12:57:59 | Syslog | User 'admin' executed the 'server host anm-vm-115' command. |

The following details are shown in the Critical Events table:

- Device/Context—ACE device name and virtual context where the event occurred.
- Time—ANM timestamp at which the alarm occurred.
- Type—Displays if the event appears in a syslog or a trap.
- Details—Additional information about the critical event.

A hyperlink allow you to view all events collected by ANM (see the “Monitoring Events” section on page 17-55).

## Contexts Performance Overview Graph

The Contexts Performance Overview graph displays the top five virtual contexts based on user-configurable resource statistic such as ACL Memory, Bandwidth, and so on. You select the resource from the Select Statistics drop-down list. This data is collected by ANM by using the ACE **show resource usage** CLI command.

Figure 17-11 Context Performance Graph

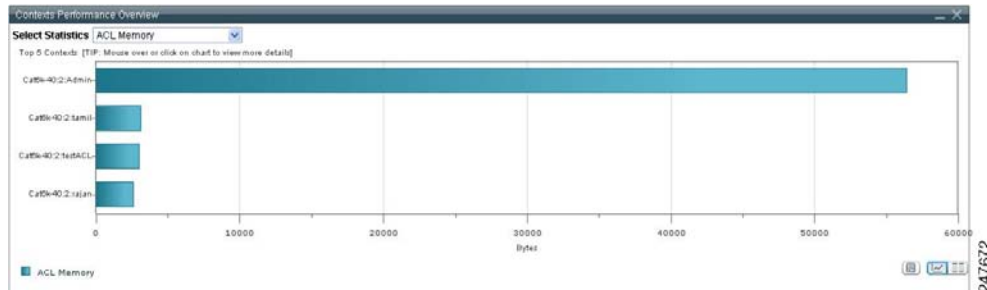

To toggle the display of the top five virtual context chart in the Contexts Performance Overview graph:

- Click **View As Chart** to display the resource statistic as a graph.
- Click **View As Grid** to display the resource statistic as a numerical line grid.



### Note

If you want to save the graph as a JPEG file for archive or other purposes, click the **Show As Image** button. When you mouse over the graph, the Image Toolbar appears. From the Image Toolbar, you can save the graph as a JPEG or send it in an email. You can also print the graph if desired.

If you want to export object data to Microsoft Excel for archive or other purposes, click the **Export to Excel** link in the View As Grid object display.

# Monitoring Device Groups

You can display monitoring information for device groups that you create in Cisco License Manager (see [Configuring User-Defined Groups, page 5-72](#)). When you choose **Monitor > Devices > Groups > *device\_group***, all monitoring features that are supported on any of the devices in the device group are displayed. Because some monitoring features, for example, Application Acceleration, are not supported on all device types, you can click the following buttons at the bottom of the Monitor screens to change what information appears:

- **Show Polled Devices**—By default, only the devices in the device group that support the specified feature are displayed.
- **Show All Devices**—All devices in the device group are shown on the Monitoring results window, whether or not the feature you selected is supported on all the devices.

For example, if you create a device group that contains an ACE appliance and several other different device types, then choose **Monitor > Devices > Groups > *device\_group* > Application Acceleration**, by default, only the ACE appliance appears in the Application Acceleration window because the other device types in the device group do not support this feature. If you click **Show Polled Devices**, all devices in the device group are displayed.

When viewing monitoring information, you might see *N/A*, which indicates that ACE Device Manager was not able to obtain the specified value. In addition, the monitoring window displays *N/A* in certain fields for which polling has not been executed.

## Related Topics

- [Setting Up Devices for Monitoring, page 17-2](#)
- [Device Monitoring Features, page 17-3](#)
- [Using Dashboards to Monitor Devices and Virtual Contexts, page 17-4](#)
- [Monitoring Devices, page 17-24](#)

# Monitoring Devices

ANM monitors activities on ACE, CSS, and CSM devices. When you choose **Monitor > Devices**, you can view device information. Using SNMP and CLI commands, ANM gathers information about your devices and displays the information.

**Note**

If you get a warning message indicating that monitoring is not enabled or functioning, you must enable statistic monitoring on the device. See the [“Setting Polling Parameters”](#) section on page 17-46.

[Table 17-2](#) lists the features that appear under **Monitor > Devices**, depending on which device type you choose in the device tree.

**Table 17-2 Supported Features According to Device Type**

| Device Type Selected in the Device Tree |               | Supported Features Displayed Under |             |                             |                 |                |                          |                  |
|-----------------------------------------|---------------|------------------------------------|-------------|-----------------------------|-----------------|----------------|--------------------------|------------------|
|                                         |               | Dashboard                          | System View | Resource Usage <sup>1</sup> | Traffic Summary | Load Balancing | Application Acceleration | Polling Settings |
| ACE module                              |               | X                                  | –           | X                           | X               | X              | –                        | –                |
|                                         | Admin context | X                                  | –           | X                           | X               | X              | –                        | X                |
|                                         | User context  | X                                  | –           | X                           | X               | X              | –                        | X                |
| ACE appliance                           |               | X                                  | –           | X                           | X               | X              | X                        | –                |
|                                         | Admin context | X                                  | –           | X                           | X               | X              | X                        | X                |
|                                         | User context  | X                                  | –           | X                           | X               | X              | X                        | X                |
| CSS                                     |               | –                                  | X           | –                           | X               | X <sup>2</sup> | –                        | X                |
| CSM                                     |               | –                                  | X           | –                           | –               | X              | –                        | X                |
| GSS                                     |               | –                                  | –           | –                           | –               | –              | –                        | X                |
| Groups <sup>3</sup>                     |               | X                                  | –           | X                           | X               | X              | X                        | –                |

1. See the [“Monitoring Resource Usage”](#) section on page 17-26 for information about the options available under Resource Usage.
2. CSS devices support Virtual Servers only, so you do not see the **Load Balancing > Statistics** menu option.
3. By default, all monitoring features that are supported on any of the devices in the device group appear when you select a device group. See the [“Using Dashboards to Monitor Devices and Virtual Contexts”](#) section on page 17-4 for more information about monitoring various device types within a device group.

## Related Topics

- [Using Dashboards to Monitor Devices and Virtual Contexts, page 17-4](#)
- [Monitoring the System, page 17-25](#)
- [Setting Up Devices for Monitoring, page 17-2](#)
- [Device Monitoring Features, page 17-3](#)
- [Setting Polling Parameters, page 17-46](#)
- [Configuring Historical Trend and Real Time Graphs for Devices, page 17-48](#)

# Monitoring the System

Cisco License Manager provides a System View that displays device information and a general overview of your system as a whole. System View is available only for CSS and CSM devices. If a CSM has crashed, you can use the System View to find out when and why the crash occurred and display information that affects the module. The System View also displays High Availability (HA) information and licensing information.

**Note**

To monitor the ACE module or appliance, use the Device Dashboard function of ANM. See the [“Using Dashboards to Monitor Devices and Virtual Contexts”](#) section on page 17-4 for details.

**Note**

ANM does not support monitoring of chassis.

## Procedure

**Step 1** Choose **Monitor > Devices > device > System View**.

The information that appears depends on what device type you select in the device tree.

The System View displays the following information:

- Device Information
- High Availability
- License Status
- Module Information (for CSS devices only)

**Note**

You can sort the information displayed in the table by clicking on a column heading.

**Step 2** Click Poll Now to instruct ANM to poll the devices and display the current values.

**Step 3** Click **OK** when asked if you want to poll the devices for data now.

## Related Topics

- [Setting Up Devices for Monitoring, page 17-2](#)
- [Device Monitoring Features, page 17-3](#)
- [Setting Polling Parameters, page 17-46](#)
- [Monitoring Traffic, page 17-30](#)
- [Configuring Historical Trend and Real Time Graphs for Devices, page 17-48](#)

# Monitoring Resource Usage

ANM provides resource usage so that you can easily determine if you need to reallocate resources to a particular virtual context, view traffic usage in your contexts, or determine available usage for your contexts. There are three modes in which ANM provides resource usage for ACEs:

- Virtual-context based resource usage—You must select a virtual context from the device tree to view resource usage specific to the context (see the “[Monitoring Virtual Context Resource Usage](#)” section on page 17-26).
- System-wide resource usage—You must select an ACE module or appliance from the device tree to view system-wide information and to display the following options:
  - Connections—Displays traffic resource usage information. See the “[Monitoring System Traffic Resource Usage](#)” section on page 17-27.
  - Features—Displays non-connection based resource usage information. See the “[Monitoring System Non-Connection Based Resource Usage](#)” section on page 17-29.
- Dashboard usage—You can select an ACE module, ACE appliance, or ACE virtual context from the device tree, and then choose **Monitor > Devices > ACE > Dashboard**. See the “[Using Dashboards to Monitor Devices and Virtual Contexts](#)” section on page 17-4.

See the “Configuring Virtualization” chapter of either the *Cisco Application Control Engine Module Virtualization Configuration Guide* or the *Cisco 4700 Series Application Control Engine Appliance Virtualization Configuration Guide* for the maximum resource usage value for each attribute.

## Monitoring Virtual Context Resource Usage

ANM displays resource usage for virtual contexts as explained in the following steps.

See the “Configuring Virtualization” chapter of either the *Cisco Application Control Engine Module Virtualization Configuration Guide* or the *Cisco 4700 Series Application Control Engine Appliance Virtualization Configuration Guide* for the maximum resource usage value for each attribute.

### Procedure

- 
- Step 1** Choose **Monitor > Devices > virtual\_context > Resource Usage**.

The information in [Table 17-3](#) appears in the Resource Usage window.

**Table 17-3** Virtual Context Resource Usage Field Descriptions

| Field                                  | Description                                                                                                                             |
|----------------------------------------|-----------------------------------------------------------------------------------------------------------------------------------------|
| ACL Memory (Bytes)                     | ACL memory usage                                                                                                                        |
| Application Acceleration (Connections) | Number of application acceleration connections.<br><b>Note</b> This field displays if you selected an ACE appliance in the device tree. |
| Bandwidth (Bytes/Sec)                  | Bandwidth in bytes per second.                                                                                                          |
| Concurrent Connections (Connections)   | Number of simultaneous connections.                                                                                                     |
| Connection Rate (Connections/Sec)      | Connections per second.                                                                                                                 |

**Table 17-3** Virtual Context Resource Usage Field Descriptions (continued)

| Field                                     | Description                                                                                                                                                                                                 |
|-------------------------------------------|-------------------------------------------------------------------------------------------------------------------------------------------------------------------------------------------------------------|
| HTTP-comp rate                            | HTTP compression rate.<br><b>Note</b> This field displays when you select one of the following device types from the device tree: An ACE appliance (any version) or an ACE module version A4(1.0) or later. |
| Inspect Connection Rate (Connections/Sec) | RTSP/FTP inspection connections per second.                                                                                                                                                                 |
| MAC Miss Rate (Connections/Sec)           | MAC miss traffic punted to CP packets per second.                                                                                                                                                           |
| Management Connection Rate (Connections)  | Number of management connections.                                                                                                                                                                           |
| Management Traffic Rate (Connections/Sec) | Management traffic bytes per second.                                                                                                                                                                        |
| Proxy Connection Rate (Connections)       | Proxy connections.                                                                                                                                                                                          |
| Regular Expression Memory (Bytes)         | Regular expressions usage in bytes.                                                                                                                                                                         |
| SSL Connection Rate (Transactions/Sec)    | SSL (Secure Sockets Layer) connections per second.                                                                                                                                                          |
| Sticky Entries                            | Number of sticky table entries.                                                                                                                                                                             |
| Syslog Buffer Size (Bytes)                | Syslog message buffer size in bytes.                                                                                                                                                                        |
| Syslog Message Rate (Messages/Sec)        | Syslog messages transmitted in messages per seconds.                                                                                                                                                        |
| Throughput (Bytes/Sec)                    | Displays through-the-ACE traffic. This is a derived value (you cannot configure it directly) and it is equal to the bandwidth rate minus the mgmt-traffic rate for the 1-Gbps and 2-Gbps licenses.          |
| Translation Entries                       | Current number of network and port address translations.                                                                                                                                                    |

**Step 2** (Optional) Click **Poll Now** to instruct ANM to poll the devices and display the current values, and click **OK** when prompted if you want to poll the devices for data now.

**Step 3** (Optional) To display a historical trend graph of resource data for the virtual context, select up to four resources from the list and click **Graph**.

The Resource Usage Graph appears (see the “[Configuring Historical Trend and Real Time Graphs for Devices](#)” section on page 17-48 for details).

#### Related Topics

- [Monitoring System Traffic Resource Usage, page 17-27](#)
- [Monitoring System Non-Connection Based Resource Usage, page 17-29](#)
- [Configuring Historical Trend and Real Time Graphs for Devices, page 17-48](#)

## Monitoring System Traffic Resource Usage

ANM displays system-wide traffic resource usage as explained in the following steps. See the “Configuring Virtualization” chapter of either the *Cisco Application Control Engine Module Virtualization Configuration Guide* or the *Cisco 4700 Series Application Control Engine Appliance Virtualization Configuration Guide* for the maximum resource usage value for each attribute.

**Note**

You must select an ACE module or appliance from the device tree to view system-wide traffic resource usage information as shown in the following steps.

**Procedure**

**Step 1** Choose **Monitor > Devices > ACE > Resource Usage > Connections**.

The current resource usage information appears as shown in [Table 17-4](#).

**Note**

There might be a slight delay because the resource usage information is gathered in real-time.

**Table 17-4** Resource Usage Connections Field Descriptions

| Field                          | Description                                                                                                                                                                                                |
|--------------------------------|------------------------------------------------------------------------------------------------------------------------------------------------------------------------------------------------------------|
| Context                        | Name of the virtual context                                                                                                                                                                                |
| Conc. Conn. %                  | Number of simultaneous connections                                                                                                                                                                         |
| Mgmt. Conn. %                  | Number of management connections                                                                                                                                                                           |
| Proxy Conn. %                  | Proxy connections                                                                                                                                                                                          |
| Bandwidth (Bytes/S) %          | Bandwidth in bytes per second                                                                                                                                                                              |
| Throughput (Bytes/S)           | <b>Note</b> This field appears when you select an ACE in the device tree.<br>Throughput in bytes per second                                                                                                |
| Conn. Rate (Conn./S) %         | Connections per second                                                                                                                                                                                     |
| SSL Conn. Rate (Trans./S) %    | SSL (Secure Sockets Layer) connections per second                                                                                                                                                          |
| Mgmt. Traffic Rate (Conn./S) % | Management traffic connections per second                                                                                                                                                                  |
| MAC Miss Rate (Conn./S) %      | MAC miss traffic punted to CP packets per second                                                                                                                                                           |
| Insp. Conn. Rate (Conn./S) %   | RTSP/FTP inspection connections per second                                                                                                                                                                 |
| App. Acc. Conn. %              | Number of application acceleration connections.<br><b>Note</b> This field appears when you select an ACE appliance in the device tree.                                                                     |
| HTTP-Comp Rate %               | HTTP compression rate.<br><b>Note</b> This field appears when you select one of the following device types from the device tree: An ACE appliance (any version) or an ACE module version A4(1.0) or later. |

**Note**

If any of the percentages that display in the Resource Usage Connections table exceed 100 percent, this is an indication that a license on the ACE was recently installed or uninstalled using either ANM or the CLI. To correct the display problem, manually synchronize the Admin context of the ACE with the CLI (see the [“Synchronizing Virtual Context Configurations”](#) section on page 6-105).

**Step 2** Click **Poll Now** to instruct ANM to poll the devices and display the current values.



**Step 3** Click **OK** when asked if you want to poll the devices for data now.

---

#### Related Topics

- [Monitoring Virtual Context Resource Usage, page 17-26](#)
- [Monitoring System Non-Connection Based Resource Usage, page 17-29](#)

## Monitoring System Non-Connection Based Resource Usage

ANM displays system-wide, non-connection-based resource usage as explained in the following steps.



#### Note

You must select an ACE module or appliance from the device tree to view the non-connection based resource usage information as shown in the following steps.

---

**Step 1** Choose **Monitor > Devices > ACE > Resource Usage > Features**.

The current resource usage information appears shown in [Table 17-5](#).



#### Note

There might be a slight delay because the resource usage information is gathered real-time.

---

**Table 17-5** *Resource Usage Features Field Descriptions*

| Field                              | Description                                             |
|------------------------------------|---------------------------------------------------------|
| Context                            | Name of the virtual context                             |
| Translation Entries %              | Current number of network and port address translations |
| ACL Memory (Bytes) %               | ACL memory usage in bytes                               |
| RegEx Memory (Bytes) %             | Regular expressions memory usage in bytes               |
| Syslog Buffer Size (Bytes) %       | Syslog message buffer size in bytes                     |
| Syslog Message Rate (Messages/S) % | Syslog messages per second                              |

**Step 2** Click **Poll Now** to instruct ANM to poll the devices and display the current values.

**Step 3** Click **OK** when asked if you want to poll the devices for data now.

---

#### Related Topics

- [Monitoring Virtual Context Resource Usage, page 17-26](#)
- [Monitoring System Traffic Resource Usage, page 17-27](#)
- [Configuring Historical Trend and Real Time Graphs for Devices, page 17-48](#)

# Monitoring Traffic

ANM determines traffic information for your ACE module, ACE appliance, or CSS devices by calculating the delta traffic values since the last polling cycle and displays the resulting values. You can view traffic summary information as shown in the steps below.

**Note**

To get traffic data polled directly from a device, click on an interface name that appears in the Interface column. See [Displaying Device-Specific Traffic Data, page 17-31](#).

**Procedure**

**Step 1** Choose **Monitor > Devices > device > Traffic Summary**.

The information shown in [Table 17-6](#) appears in the Traffic Summary page.

**Note**

You can click on any column heading to sort the table by that column.

**Table 17-6** Traffic Summary Fields

| Field              | Description                                                                                                                                                                                                                                                                                                                                                                                                                                                                           |
|--------------------|---------------------------------------------------------------------------------------------------------------------------------------------------------------------------------------------------------------------------------------------------------------------------------------------------------------------------------------------------------------------------------------------------------------------------------------------------------------------------------------|
| Device             | Fully-qualified device name. This field does not appear for CSS devices.                                                                                                                                                                                                                                                                                                                                                                                                              |
| Interface          | Name of the interface. Click the interface hyperlink to get traffic data polled directly from the device as shown in <a href="#">Table 17-7</a> .                                                                                                                                                                                                                                                                                                                                     |
| Admin Status       | User-specified status of the device, which can be one of the following states: <ul style="list-style-type: none"> <li>• Up</li> <li>• Down</li> <li>• Testing, which indicates that no operational packets can be passed.</li> </ul>                                                                                                                                                                                                                                                  |
| Operational Status | Current operational status of the device, which can be one of the following states: <ul style="list-style-type: none"> <li>• Up</li> <li>• Down</li> <li>• Testing, which indicates that no operational packets can be passed</li> <li>• Unknown</li> <li>• Dormant, which indicates the interface is waiting for external actions (such as a serial line waiting for an incoming connection)</li> <li>• Not present, which indicates the interface has missing components</li> </ul> |
| Packets In / Sec   | This field appears for ACEs only.<br>Per second, the number of packets delivered by this sub-layer to a higher (sub-)layer, which were not addressed to a multicast or broadcast address at this sub-layer.                                                                                                                                                                                                                                                                           |
| Packets Out / Sec  | This field appears for ACEs only.<br>Per second, the total number of packets that higher-level protocol requested be transmitted, and which were not addressed to a multicast or broadcast address at this sub-layer, including those that were discarded or not sent.                                                                                                                                                                                                                |

Table 17-6 Traffic Summary Fields (continued)

| Field            | Description                                                                                                                                                                                                                                                                                                                                     |
|------------------|-------------------------------------------------------------------------------------------------------------------------------------------------------------------------------------------------------------------------------------------------------------------------------------------------------------------------------------------------|
| Bytes In / Sec   | Number of octets received, including framing characters, per second.                                                                                                                                                                                                                                                                            |
| Bytes Out / Sec  | Number of octets per second transmitted out of the interface, including framing characters.                                                                                                                                                                                                                                                     |
| Errors In / Sec  | Number of inbound packets discarded per second because they contained errors or because of an unknown or unsupported protocol.                                                                                                                                                                                                                  |
| Errors Out / Sec | Number of outbound packets discarded per second because they contained errors or because of an unknown or unsupported protocol.                                                                                                                                                                                                                 |
| Last Polled      | Date and time of the last time that ANM polled the device to display the current values. This field appears if viewing traffic summary data at a device level or at a device group level in the device tree.<br><b>Note</b> The Last Polled time stamp appears in the table heading if viewing traffic summary data at a virtual context level. |

- Step 2** (Optional) Click **Poll Now** to instruct ANM to poll the devices and display the current values and click **OK** when prompted if you want to poll the devices for data now.
- Step 3** (Optional) To display a historical trend graph of traffic information, select up to four interfaces from the list and click **Graph**.  
The Resource Usage Graph appears (see the “[Configuring Historical Trend and Real Time Graphs for Devices](#)” section on page 17-48 for details).
- Step 4** (Optional) Choose a device, and click **Details** to see specific traffic information for the selected device (see the “[Displaying Device-Specific Traffic Data](#)” section on page 17-31).

#### Related Topic

- [Displaying Device-Specific Traffic Data, page 17-31](#)
- [Configuring Historical Trend and Real Time Graphs for Devices, page 17-48](#)

## Displaying Device-Specific Traffic Data

You can display device-specific traffic data.

#### Procedure

- Step 1** Choose **Monitor > Devices > device > Traffic Summary**.  
Hyperlinked device names appear in the **Interface** column.
- Step 2** Choose a hyperlinked device name.  
The Traffic Summary Details window appears. The information shown in [Table 17-7](#) appears.



**Note** You can click on a column heading to sort the table by that column.

**Table 17-7** Traffic Summary Details Window Description

| Device Type | Field                                 | Description                                                                                                                                                                                                  |
|-------------|---------------------------------------|--------------------------------------------------------------------------------------------------------------------------------------------------------------------------------------------------------------|
| ACE and CSS | Bytes In                              | Total number of octets received on the interface, including framing characters                                                                                                                               |
|             | Bytes Out                             | Total number of octets transmitted out of the interface, including framing characters                                                                                                                        |
|             | Discarded Inbound Packets             | Number of inbound packets which were discarded even though no errors were detected to prevent their being delivered to a higher-layer protocol                                                               |
|             | Discarded Outbound Packets            | Number of outbound packets which were discarded even though no errors were detected to prevent their being transmitted                                                                                       |
|             | Inbound Packet Errors                 | Total number of inbound packet errors                                                                                                                                                                        |
|             | Inbound Packets with Unknown Protocol | Total number of packets received via the interface which were discarded because of an unknown or unsupported protocol                                                                                        |
|             | Outbound Packet Errors                | Total number of outbound packet errors                                                                                                                                                                       |
|             | Packets In                            | Number of packets delivered by this sub-layer to a higher (sub-)layer, which were not addressed to a multicast or broadcast address at this sub-layer.                                                       |
|             | Packets Out                           | Number of packets that higher-level protocols requested be transmitted, and which were not addressed to a multicast or broadcast address at this sub-layer, including those that were discarded or not sent. |
| CSS only    | Active TCP                            | Current number of active TCP flows on the interface                                                                                                                                                          |
|             | Active UDP                            | Current number of active UDP flows on the interface                                                                                                                                                          |
|             | FCB Count                             | Number of unused fastpath flow control blocks for the interface                                                                                                                                              |
|             | TCP Average                           | Five second moving average of TCP flows per second on the interface                                                                                                                                          |
|             | TCP Current                           | Number of new TCP flows within last second on the interface                                                                                                                                                  |
|             | TCP High                              | Maximum number of TCP flows in any one second interval on the interface                                                                                                                                      |
|             | TCP Total                             | Total TCP flows on the interface                                                                                                                                                                             |
|             | UDP Average                           | Five second moving average of UCP flows per second on the interface                                                                                                                                          |
|             | UDP Current                           | Number of new UDP flows within last second on the interface                                                                                                                                                  |
|             | UDP High                              | Maximum number of UDP flows in any one second interval on the interface                                                                                                                                      |
| UDP Total   | Total UDP flows on the interface      |                                                                                                                                                                                                              |

**Step 3** Click **OK** to close the window and return to the Traffic Summary window.

#### Related Topic

[Monitoring Traffic, page 17-30](#)

# Monitoring Load Balancing

ANM monitors load balancing and allows you to view the information associated with virtual servers, real servers, probes, and load balancing statistics.

This section includes the following topics:

- [Monitoring Load Balancing on Virtual Servers, page 17-33](#)
- [Monitoring Load Balancing on Real Servers, page 17-37](#)
- [Monitoring Load Balancing on Probes, page 17-40](#)
- [Monitoring Load Balancing Statistics, page 17-41](#)

## Monitoring Load Balancing on Virtual Servers

ANM monitors load balancing and allows you to display the associated virtual server information as shown in the following steps.

**Note**

You can display additional load-balancing information about real servers, such as the number of servers that are functioning properly, and probes, such as viewing if an excessing number of probes are failing, by clicking the hyperlink in the respective columns in [Table 17-8](#).

---

**Procedure**

**Step 1** Choose **Monitor > Devices > *device* > Load Balancing > Virtual Servers**.

Depending on the device type you selected in the device tree, the information described in [Table 17-8](#) appears.

**Note**

For the ACE appliance and the ACE module running A2(3.0), click the **Advanced Editing Mode** button to show/hide additional load balancing virtual server monitoring fields.

**Note**

If you select a CSS device from the device tree, the navigation path does not include Load Balancing; the path is **Monitor > Devices > *CSS\_device* > Virtual Servers**.

**Table 17-8** Load Balancing Virtual Server Monitoring Information

| Device Type | Field               | Description                                                                                                                                                                                                                                                                                                                                                                                                                                                                                                            |
|-------------|---------------------|------------------------------------------------------------------------------------------------------------------------------------------------------------------------------------------------------------------------------------------------------------------------------------------------------------------------------------------------------------------------------------------------------------------------------------------------------------------------------------------------------------------------|
| All         | Virtual Server      | Name of the virtual server.<br><br><b>Note</b> If a virtual server is associated with primary and backup server farms, two entries appear in the table: One for the primary server farm and one for the backup server farm.<br><br>To view statistics for a selected virtual server, click the virtual server hyperlink. The Virtual Server Details popup window appears containing the individual statistic, associated counter value, and a description of the statistic. Click <b>OK</b> to close the popup window. |
|             | IP Address          | IP address of the virtual server.                                                                                                                                                                                                                                                                                                                                                                                                                                                                                      |
|             | Port                | Port to be used for the specified protocol.                                                                                                                                                                                                                                                                                                                                                                                                                                                                            |
|             | # Rservers Up       | Number of servers up/Number of total servers configured.<br><br><b>Note</b> You can click on the hyperlink in this column to view statistics for the real servers configured for the specified virtual server. See the <a href="#">“Monitoring Load Balancing on Real Servers”</a> section on page 17-37.                                                                                                                                                                                                              |
| ACEs, CSM   | # Probes Failed     | For the ACE, this field displays Number of probes failed/Number of probes configured.<br><br>For the CSM, this field displays Number of probes failed.<br><br><b>Note</b> For an ACE, you can click on the number displayed to view the statistics for the probes configured for the specified virtual server. See the <a href="#">“Monitoring Load Balancing on Probes”</a> section on page 17-40.                                                                                                                    |
|             | Operational Status  | The state of the server, which can be: <ul style="list-style-type: none"> <li>• Inservice—Indicates the server is in service.</li> <li>• Out of Service—Indicates the server is out of service.</li> </ul>                                                                                                                                                                                                                                                                                                             |
|             | Current Connections | Current number of connections.                                                                                                                                                                                                                                                                                                                                                                                                                                                                                         |
|             | Conns/Sec.          | Number of connections per second that the device receives.                                                                                                                                                                                                                                                                                                                                                                                                                                                             |

Table 17-8 Load Balancing Virtual Server Monitoring Information (continued)

| Device Type | Field              | Description                                                                                                                                                                                                                                                                                                                                                                                                                                                                                                                                                               |
|-------------|--------------------|---------------------------------------------------------------------------------------------------------------------------------------------------------------------------------------------------------------------------------------------------------------------------------------------------------------------------------------------------------------------------------------------------------------------------------------------------------------------------------------------------------------------------------------------------------------------------|
| ACEs only   | Device             | Fully-qualified device name.                                                                                                                                                                                                                                                                                                                                                                                                                                                                                                                                              |
|             | Protocol           | Protocol the virtual server supports, which can be: <ul style="list-style-type: none"> <li>Any—Indicates the virtual server is to accept connections using any IP protocol.</li> <li>TCP—Indicates that the virtual server is to accept connections that use TCP.</li> <li>UDP—Indicates that the virtual server is to accept connections that use UDP.</li> </ul>                                                                                                                                                                                                        |
|             | Service Policy     | Policy map applied to the device.                                                                                                                                                                                                                                                                                                                                                                                                                                                                                                                                         |
|             | DWS                | Operating state of the Dynamic Workload Scaling feature for the associated server farm, which can be: <ul style="list-style-type: none"> <li>N/A—Not applicable; the virtual server's server farm is not configured for Dynamic Workload Scaling.</li> <li>Local—The server farm is configured for Dynamic Workload Scaling, but the ACE is load-balancing traffic to the local VM Controller VMs only.</li> <li>Expanded—The server farm is configured for Dynamic Workload Scaling and the ACE is sending traffic to the local and remote VM Controller VMs.</li> </ul> |
|             | Dropped Conns/Sec. | Number of connections per second that the ACE discarded.                                                                                                                                                                                                                                                                                                                                                                                                                                                                                                                  |
|             | Server Farm        | Name of the server farm associated with the virtual server.                                                                                                                                                                                                                                                                                                                                                                                                                                                                                                               |
|             | Action             | Indicates if the device is functioning as a primary server (Primary) or a backup server (Backup).                                                                                                                                                                                                                                                                                                                                                                                                                                                                         |
|             | Algorithm          | Type of predictor algorithm specified on the load balancer, which can be: <ul style="list-style-type: none"> <li>Roundrobin</li> <li>Leastconn</li> <li>Hash URL</li> <li>Hash Address</li> <li>Hash Cookie</li> <li>Hash Header</li> </ul>                                                                                                                                                                                                                                                                                                                               |
|             | Last Polled        | Date and time of the last time that ANM polled the device to display the current values. This field appears if viewing virtual server data at a device level or at a device group level in the device tree. <p><b>Note</b> The Last Polled time stamp appears in the table heading if viewing virtual server data at a virtual context level.</p>                                                                                                                                                                                                                         |

**Table 17-8** Load Balancing Virtual Server Monitoring Information (continued)

| Device Type                                                                          | Field                        | Description                                                                                                                                                                                                                     |
|--------------------------------------------------------------------------------------|------------------------------|---------------------------------------------------------------------------------------------------------------------------------------------------------------------------------------------------------------------------------|
| ACE appliance,<br>ACE module<br>running A2(3.0)<br>(Advanced Editing<br>Mode button) | Client Packets/Sec           | Number of packets per second received from the client.                                                                                                                                                                          |
|                                                                                      | Client Bytes/Sec             | Number of bytes per second received from the client.                                                                                                                                                                            |
|                                                                                      | Server Packets/Sec           | Number of packets per second received from the server.                                                                                                                                                                          |
|                                                                                      | Server Bytes/Sec             | Number of bytes per second received from the server.                                                                                                                                                                            |
|                                                                                      | Drops/Sec Conn<br>Rate Limit | Number of active connection drops per second based on the connection rate limit of the real server                                                                                                                              |
|                                                                                      | Drops/Sec Max<br>Conn Limit  | Number of active connection drops per second based on the maximum allowable number of active connections to a real server.                                                                                                      |
| ACEs, CSS, CSM                                                                       | Admin Status                 | User-specified status of the virtual server, which can be: <ul style="list-style-type: none"> <li>• In Service—Indicates the server is in service.</li> <li>• Out of Service—Indicates the server is out of service.</li> </ul> |

**Step 2** (Optional) Use the display toggle button () located above the table to control which virtual servers ANM displays as follows:

- Show ANM Recognized Virtual Servers—Displays only virtual servers that match ANM’s virtual server definition (see the [“Virtual Server Configuration and ANM”](#) section on page 7-2).
- Show All Virtual Servers—Displays virtual servers that match ANM’s virtual server definition and those that do not match this definition but that ANM can recognize as virtual servers using SNMP polling.





**Note** The display toggle button displays only when you have the “Display All Virtual Servers in Monitoring & Operations page” advanced setting feature enabled (see the [“Managing the Display of Virtual Servers in the Operations and Monitoring Windows”](#) section on page 18-66).

**Step 3** (Optional) Use the function buttons described in [Table 17-9](#) to update the virtual server information displayed, view graph information, or view the topology map.



**Table 17-9** Virtual Server Monitoring Window Function Buttons

| Function Button | Description                                                                                                                                                                                                                                                                                                                                                                                                                                                                                                                                                                                                                                                                                                                                                                                            |
|-----------------|--------------------------------------------------------------------------------------------------------------------------------------------------------------------------------------------------------------------------------------------------------------------------------------------------------------------------------------------------------------------------------------------------------------------------------------------------------------------------------------------------------------------------------------------------------------------------------------------------------------------------------------------------------------------------------------------------------------------------------------------------------------------------------------------------------|
| Poll Now        | Instructs ANM to poll the devices and display the current values. Choose one or more virtual servers and click <b>Poll Now</b> .                                                                                                                                                                                                                                                                                                                                                                                                                                                                                                                                                                                                                                                                       |
| Graph           | Displays a historical trend graph of virtual server information for a specific virtual server. Choose 1 to 4 virtual servers and click <b>Graph</b> .<br>For more information, see the “ <a href="#">Configuring Historical Trend and Real Time Graphs for Devices</a> ” section on page 17-48.                                                                                                                                                                                                                                                                                                                                                                                                                                                                                                        |
| Topology        | Displays the network topology map for a specific virtual server. Choose a virtual server and click <b>Topology</b> .<br><br> <b>Note</b> The topology map feature is not available when the Virtual Server table is set to Show All Virtual Servers. Use the display toggle button (  ) to ensure that the Virtual Servers table is set to Show ANM Recognized Virtual Servers (see Step 2).<br><br>The ANM Topology window appears, displaying the virtual server and associated network nodes. For information about using the topology map, see the “ <a href="#">Displaying Network Topology Maps</a> ” section on page 17-68. |

**Related Topics**

- [Monitoring Load Balancing on Real Servers, page 17-37](#)
- [Monitoring Load Balancing on Probes, page 17-40](#)
- [Configuring Historical Trend and Real Time Graphs for Devices, page 17-48](#)

## Monitoring Load Balancing on Real Servers

ANM monitors load balancing and allows you to view the associated real server information.

**Procedure**

**Step 1** Choose **Monitor > Devices > device > Load Balancing > Real Servers**.

Depending on the device type you selected in the device tree, the information described in [Table 17-10](#) appears.

Table 17-10 Load Balancing Real Server Monitoring Information

| Device Type | Field              | Description                                                                                                                                                                                                                                                                                                                                                                                                                                                                                                                                                                                                                                                                                                                                                                                                                                                                                                                                                                               |
|-------------|--------------------|-------------------------------------------------------------------------------------------------------------------------------------------------------------------------------------------------------------------------------------------------------------------------------------------------------------------------------------------------------------------------------------------------------------------------------------------------------------------------------------------------------------------------------------------------------------------------------------------------------------------------------------------------------------------------------------------------------------------------------------------------------------------------------------------------------------------------------------------------------------------------------------------------------------------------------------------------------------------------------------------|
| All         | Real Server        | Name of the real server. To view statistics for a selected real server, click the real server hyperlink. The Real Server Details popup window appears containing the individual statistic, associated counter value, and a description of the statistic. Click <b>OK</b> to close the popup window.                                                                                                                                                                                                                                                                                                                                                                                                                                                                                                                                                                                                                                                                                       |
|             | IP Address         | IP address of the real server. This field appears only for real servers specified as hosts.                                                                                                                                                                                                                                                                                                                                                                                                                                                                                                                                                                                                                                                                                                                                                                                                                                                                                               |
|             | Port               | Port number used for the server port address translation (PAT).                                                                                                                                                                                                                                                                                                                                                                                                                                                                                                                                                                                                                                                                                                                                                                                                                                                                                                                           |
|             | Admin Status       | The specified state of the server, which can be: <ul style="list-style-type: none"> <li>• Inservice—Indicates the server is in service.</li> <li>• Out of Service—Indicates the server is out of service.</li> <li>• In Service Standby—Indicates the server is a backup server and remains inactive unless the primary server fails. If the primary server fails, the backup server becomes active and starts accepting connections.</li> </ul>                                                                                                                                                                                                                                                                                                                                                                                                                                                                                                                                          |
|             | Operational Status | The state of the server, which can be: <ul style="list-style-type: none"> <li>• Inservice—Indicates the server is in service.</li> <li>• Out of Service—Indicates the server is out of service.</li> <li>• Inservice Standby—Indicates the server is a backup server and remains inactive unless the primary server fails. If the primary server fails, the backup server becomes active and starts accepting connections.</li> <li>• Probe Failed—Indicates that ANM did not receive a response to a health probe that it sent to the server.</li> </ul>                                                                                                                                                                                                                                                                                                                                                                                                                                 |
| VM          |                    | Indicator that the real server is, or is not, a VMware virtual machine as follows: <ul style="list-style-type: none"> <li>• – (dash)—The real server is not a VMware VM.</li> <li>• Yes—The real server is a VMware VM. To view details about the VM, click <b>Yes</b>. The Virtual Machine Details popup window appears and provides the following information about the VM: <ul style="list-style-type: none"> <li>– Full path—Full path to the VM.</li> <li>– DNS Name—DNS name of the VM.</li> <li>– IP Address—VM IP address.</li> <li>– State—Operating state of the VM (for example, poweredOn).</li> <li>– Guest OS—Guest operating system (for example, Red Hat Enterprise Linux 5 (32-bit)).</li> <li>– Host—Host IP address.</li> <li>– Memory (MB)—Amount of memory.</li> <li>– CPU (MHz)—CPU frequency.</li> <li>– Triggered Alarms—Number of recorded triggered alarm conditions.</li> </ul> </li> </ul> Click <b>OK</b> to close the Virtual Machine Details popup window. |
|             | Weight             | Weight assigned to the real server.                                                                                                                                                                                                                                                                                                                                                                                                                                                                                                                                                                                                                                                                                                                                                                                                                                                                                                                                                       |

**Table 17-10** Load Balancing Real Server Monitoring Information (continued)

| Device Type | Field                    | Description                                                                                                                                                                                                                                                                                                                                                                                                                                                                                                                                                                                                                                                                                                                                                                                                                                                                                                       |
|-------------|--------------------------|-------------------------------------------------------------------------------------------------------------------------------------------------------------------------------------------------------------------------------------------------------------------------------------------------------------------------------------------------------------------------------------------------------------------------------------------------------------------------------------------------------------------------------------------------------------------------------------------------------------------------------------------------------------------------------------------------------------------------------------------------------------------------------------------------------------------------------------------------------------------------------------------------------------------|
| ACE, CSM    | Server Farm              | Primary server farm to use for load balancing.                                                                                                                                                                                                                                                                                                                                                                                                                                                                                                                                                                                                                                                                                                                                                                                                                                                                    |
|             | Current Connections      | Number of current connections to this server. If this field indicates <i>N/A</i> , the database does not have any information about current connections. If this field is 0, the database received an SNMP response of 0.                                                                                                                                                                                                                                                                                                                                                                                                                                                                                                                                                                                                                                                                                         |
|             | Connections Rate         | Connections per second.                                                                                                                                                                                                                                                                                                                                                                                                                                                                                                                                                                                                                                                                                                                                                                                                                                                                                           |
|             | Dropped Connections Rate | Dropped connections per second.                                                                                                                                                                                                                                                                                                                                                                                                                                                                                                                                                                                                                                                                                                                                                                                                                                                                                   |
| ACEs Only   | Device                   | Fully qualified device name.                                                                                                                                                                                                                                                                                                                                                                                                                                                                                                                                                                                                                                                                                                                                                                                                                                                                                      |
|             | Locality                 | Field that pertains to the ACE module A4(2.0), ACE appliance A4(2.0), and later releases of either device type only. Locality also requires that you have the ACE configured for Dynamic Workload Scaling (see the “ <a href="#">Configuring Dynamic Workload Scaling</a> ” section on page 8-26).<br><br>Possible values for real server locality are as follows: <ul style="list-style-type: none"> <li>• <i>N/A</i>—Not available; the ACE cannot determine the real server location (local or remote). A possible cause for this issue is that Dynamic Workload Scaling is not configured correctly.</li> <li>• <i>Local</i>—The real server is located in the local network.</li> <li>• <i>Remote</i>—The real server is located in the remote network. The ACE bursts traffic to this server when the local real server's CPU and/or memory usage reaches the specified maximum threshold value.</li> </ul> |
|             | Last Polled              | Date and time of the last time that ANM polled the device to display the current values. This field appears if viewing virtual server data at a device level or at a device group level in the device tree.<br><br><b>Note</b> The Last Polled time stamp appears in the table heading if viewing virtual server data at a virtual context level.                                                                                                                                                                                                                                                                                                                                                                                                                                                                                                                                                                 |
| CSSs Only   | Total Connections        | Total number of connections.                                                                                                                                                                                                                                                                                                                                                                                                                                                                                                                                                                                                                                                                                                                                                                                                                                                                                      |

**Step 2** (Optional) Use the function buttons described in [Table 17-11](#) to update or change the real server information displayed.

**Table 17-11 Real Server Monitoring Window Function Buttons**

| Function Button | Description                                                                                                                                                                                                                                                                                                                                                    |
|-----------------|----------------------------------------------------------------------------------------------------------------------------------------------------------------------------------------------------------------------------------------------------------------------------------------------------------------------------------------------------------------|
| <b>Poll Now</b> | Instructs ANM to poll the devices and display the current values. Choose one or more real servers and click <b>Poll Now</b> . Click <b>OK</b> when asked if you want to poll the devices for data now.                                                                                                                                                         |
| <b>Graph</b>    | Displays a historical trend graph of real server information for the specified real servers. Choose 1 to 4 real servers and click <b>Graph</b> . Choosing multiple real servers allows you to compare information.<br><br>For more information, see the <a href="#">“Configuring Historical Trend and Real Time Graphs for Devices”</a> section on page 17-48. |
| <b>Topology</b> | Displays the network topology map for the specified real server. Choose a real server and click <b>Topology</b> .<br><br>The ANM Topology window appears, displaying the real server and associated network nodes. For information about using the topology map, see the <a href="#">“Displaying Network Topology Maps”</a> section on page 17-68.             |

**Related Topics**

- [Monitoring Load Balancing, page 17-33](#)
- [Monitoring Load Balancing on Probes, page 17-40](#)
- [Configuring Historical Trend and Real Time Graphs for Devices, page 17-48](#)

## Monitoring Load Balancing on Probes

To check the health and availability of a real server, the ACE periodically sends a probe to the real server. If you notice an excessive number of probes failing, you can view the monitoring information as shown in the following steps.

**Procedure**

**Step 1** Choose **Monitor > Devices > ACE > Load Balancing > Probes**.

The probe information described in [Table 17-12](#) appears.

**Table 17-12** Load Balancing Probes Monitoring Information

| Field            | Description                                                                                                                                                                                                                                                                                                                                                                                                                                                                    |
|------------------|--------------------------------------------------------------------------------------------------------------------------------------------------------------------------------------------------------------------------------------------------------------------------------------------------------------------------------------------------------------------------------------------------------------------------------------------------------------------------------|
| Device           | Name of the ACE managed by ANM.                                                                                                                                                                                                                                                                                                                                                                                                                                                |
| Probe            | Name of the probe.<br>To view statistics for a selected probe, click the probe hyperlink. The Probe Details popup window appears containing the following probe statistics: <ul style="list-style-type: none"> <li>Failed Probes—Total number of failed probes.</li> <li>Health of Probes—Health of the probe. Possible values are PASSED or FAILED.</li> <li>Probes Passed—Total number of passed probes.</li> </ul> Click <b>OK</b> to close the Probe Details popup window. |
| Type             | Type of probe. For a complete list of probe types and their descriptions, see <a href="#">Table 8-11</a> .                                                                                                                                                                                                                                                                                                                                                                     |
| Real Server      | Name of the real server that the probe is associated with.                                                                                                                                                                                                                                                                                                                                                                                                                     |
| Server Farm      | Name of the server farm that the probe is associated with.                                                                                                                                                                                                                                                                                                                                                                                                                     |
| Port             | Port number that the probe uses. By default, the probe uses the port number based on its type.                                                                                                                                                                                                                                                                                                                                                                                 |
| Probe IP Address | Destination or source address for the probe.                                                                                                                                                                                                                                                                                                                                                                                                                                   |
| Probed Port      | Source of the probe's port number.                                                                                                                                                                                                                                                                                                                                                                                                                                             |
| Probe Health     | Health of the probe. Possible values are PASSED or FAILED.                                                                                                                                                                                                                                                                                                                                                                                                                     |
| Passed Rate      | Rate of passed probes                                                                                                                                                                                                                                                                                                                                                                                                                                                          |
| Failed Rate      | Rate of failed probes                                                                                                                                                                                                                                                                                                                                                                                                                                                          |
| Last Polled      | Time stamp for the last probe. This field appears if viewing probe data at a device level or at a device group level in the device tree.<br><b>Note</b> The Last Polled time stamp appears in the table heading if viewing probe data at a virtual context level.                                                                                                                                                                                                              |

**Step 2** (Optional) Click **Poll Now** to instruct ANM to poll the devices and display the current values.

**Step 3** (Optional) To view the details associated with a specific probe, choose a probe from the list and click **Details**.

The **show probe *probe\_name* detail** CLI command output appears in a popup window.

**Step 4** Click **OK** when asked if you want to poll the devices for data now.

#### Related Topics

- [Monitoring Load Balancing, page 17-33](#)
- [Monitoring Load Balancing Statistics, page 17-41](#)
- [Configuring Historical Trend and Real Time Graphs for Devices, page 17-48](#)

## Monitoring Load Balancing Statistics

You can monitor load balancing on your ACE and CSM devices as shown in the following procedure.

**Procedure**

**Step 1** Choose **Monitor > Devices > device > Load Balancing > Statistics**.

The Load Balancing Statistics Monitoring Information window displays the information described in [Table 17-13](#).

**Table 17-13** Load Balancing Statistics Monitoring Information

| Device Type | Field                                         | Description                                                                              |
|-------------|-----------------------------------------------|------------------------------------------------------------------------------------------|
| ACEs only   | Device                                        | Name of the device                                                                       |
|             | L4 Policy Connections                         | Number of Layer 4 policy connections                                                     |
|             | L7 Policy Connections                         | Number of Layer 7 policy connections                                                     |
|             | Failed Connections                            | Number of failed connections                                                             |
|             | Dropped L4 Policy Connections                 | Number of dropped Layer 4 policy connections                                             |
|             | Dropped L7 Policy Connections                 | Number of dropped Layer 7 policy connections                                             |
|             | Rejected Connections Due To No Policy Match   | Number of connections rejected because they did not match policies                       |
|             | Rejected Connections Due To ACL Deny          | Number of connections rejected due to ACL parameters                                     |
|             | Rejected Connections Due To L7 Config Changes | Number of rejected connections due to Layer 7 configuration changes                      |
|             | Connection Timed Out                          | Number of times the connection timed out.                                                |
|             | Last Polled                                   | Date and time of the last time that ANM polled the device to display the current values. |
| CSM only    | Statistic                                     | Name of the monitored statistic.                                                         |
|             | Value                                         | Statistic value.                                                                         |
|             | Rate                                          | Statistic rate.                                                                          |
|             | Description                                   | Explanation of the monitored CSM statistic.                                              |

**Step 2** (Optional) Click **Poll Now** to instruct ANM to poll the devices and display the current values and click **OK** when prompted if you want to poll the devices for data now.

**Step 3** (Optional) To display a historical trend graph of load balancing statistics, select up to four objects from the list and click **Graph**.

The Resource Usage Graph appears (see the “[Configuring Historical Trend and Real Time Graphs for Devices](#)” section on page 17-48 for details).

**Related Topic**

- [Testing Connectivity, page 17-71](#)
- [Configuring Historical Trend and Real Time Graphs for Devices, page 17-48](#)

# Monitoring Application Acceleration

If you have configured application acceleration functions on the ACE, you can monitor the optimization statistics as shown in the following steps.

**Step 1** Choose **Monitor > Devices > device > Application Acceleration**.

The Application Acceleration information appears as shown in [Table 17-14](#).



**Note** For connection-based syslogs, the following additional parameters are displayed: Source IP, Source Port, Destination IP, Destination Port, and Protocol Information. This allows you to sort and filter on these fields if desired.

**Table 17-14** Application Acceleration Monitoring View

| Field                                      | Statistic                                                                                                | Description                                                                                                |
|--------------------------------------------|----------------------------------------------------------------------------------------------------------|------------------------------------------------------------------------------------------------------------|
| Condenser Information                      | Total HTTP Unoptimized Requests Received                                                                 | Total number of end-user HTTP request the condenser has received that cannot be optimized                  |
|                                            | Accumulated Bytes Received                                                                               | Accumulated size (in bytes) of each end-user requested object                                              |
|                                            | Total Responses in Bytes                                                                                 | Accumulated size (in bytes) of responses, both for condensable and non-condensable end-user HTTP requests  |
|                                            | Total Abandons of Delta Optimization                                                                     | Total number of abandons of delta optimization requests                                                    |
| Cacheable Objects Statistics               | Total Objects Served from Cache                                                                          | Total number of cacheable objects served from the cache, excluding the not-modified replies                |
|                                            | Accumulated Bytes Served                                                                                 | Accumulated size (in bytes) of the cacheable objects served from the cache, excluding not-modified replies |
|                                            | Total Objects Not Found in Cache                                                                         | Total number of cacheable objects not found in the cache                                                   |
|                                            | Accumulated Bytes Not Found                                                                              | Accumulated size (in bytes) of the cacheable objects not found in the cache                                |
|                                            | Total IMS Requests for Valid Cache                                                                       | Total number of IMS requests for valid copies of objects in the cache                                      |
|                                            | Total Missed IMS Requests                                                                                | Total number of IMS request for objects that either do not exist or are stale in the cache                 |
|                                            | Total Non-Cacheable Object Requests                                                                      | Total number of non-cacheable object requests                                                              |
| Total Requests with Not Modified Responses | Total number of requests for stale objects that have the response from the origin server as not modified |                                                                                                            |

**Table 17-14** Application Acceleration Monitoring View (continued)

| Field                            | Statistic                    | Description                                                                                         |
|----------------------------------|------------------------------|-----------------------------------------------------------------------------------------------------|
| Flash Forward Objects Statistics | Successful Transformations   | Total number of successful transformations for FlashForward objects                                 |
|                                  | Unsuccessful Transformations | Total number of unsuccessful transformations for FlashForward objects                               |
|                                  | Total HTTP Requests          | Total number of HTTP requests (excluding the IMS requests) for the transformed FlashForward objects |
|                                  | Total IMS Requests           | Total number of IMS requests for transformed FlashForward objects                                   |

**Step 2** Click **Poll Now** to instruct ANM to poll the devices and display the current values.

**Step 3** Click **OK** when asked if you want to poll the devices for data now.

#### Related Topics

[Configuring Application Acceleration and Optimization, page 15-1](#)

## Displaying the Polling Status of All Managed Objects

You can display the polling status of the following objects that ANM manages: ACE virtual contexts and CSS, CSM, and GSS devices. Because ACE devices are partitioned into virtual contexts that can be polled individually, the polling status window displays the status of each ACE virtual context. From the polling status window, you have the option to restart polling to a virtual context or device that currently has polling disabled.

#### Guidelines and Restrictions

The time it takes the Polling Status window to reflect global changes that you make to the polling status or polling interval varies depending on the number of managed objects being polled. For information about making global polling changes, see the [“Enabling Polling on All Devices” section on page 17-47](#).

#### Procedure

**Step 1** Choose **Monitor > Settings > Polling Status**.

The Polling Status window appears.

**Table 17-15** Polling Status Window

| Field | Description                                                                                                                                             |
|-------|---------------------------------------------------------------------------------------------------------------------------------------------------------|
| Name  | Name of the object polled. For all ACE devices, the context names associated with each ACE. For all other object types, such as a GSS, the device name. |
| Type  | Type of object polled. The type will either be Virtual Context to indicate an ACE virtual context or a specific device type, such as GSS.               |



Table 17-15 Polling Status Window (continued)

| Field                       | Description                                                                                                                                                                                                                                                                                                                                                                                                                                                                                                                                                                                                                                                                                                                                                                                                                                                                                                                                                                                                                                                                                                                                                                                                                                                                                                                       |
|-----------------------------|-----------------------------------------------------------------------------------------------------------------------------------------------------------------------------------------------------------------------------------------------------------------------------------------------------------------------------------------------------------------------------------------------------------------------------------------------------------------------------------------------------------------------------------------------------------------------------------------------------------------------------------------------------------------------------------------------------------------------------------------------------------------------------------------------------------------------------------------------------------------------------------------------------------------------------------------------------------------------------------------------------------------------------------------------------------------------------------------------------------------------------------------------------------------------------------------------------------------------------------------------------------------------------------------------------------------------------------|
| Polling Config              | Polling configuration operational state: Enabled or Disabled. For more information, see the <a href="#">“Setting Polling Parameters”</a> section on page 17-46.                                                                                                                                                                                                                                                                                                                                                                                                                                                                                                                                                                                                                                                                                                                                                                                                                                                                                                                                                                                                                                                                                                                                                                   |
| Polling Interval            | Frequency at which ANM polls the object.                                                                                                                                                                                                                                                                                                                                                                                                                                                                                                                                                                                                                                                                                                                                                                                                                                                                                                                                                                                                                                                                                                                                                                                                                                                                                          |
| Polling Status              | <p>Current polling status of the managed object:</p> <ul style="list-style-type: none"> <li>• <b>Missing SNMP Credentials</b>—SNMP credentials are not configured for this object; statistics are not collected. Add SNMPv2c credentials to fix this error.</li> <li>• <b>Not Polled</b>—SNMP polling has not started. For a virtual context, this problem might occur when the virtual context is first created from ANM and the SNMP credentials are not configured. Add SNMPv2c credentials to fix this error.</li> <li>• <b>Polling Failed</b>—SNMP polling failed due to some internal error. Try restarting polling to enable SNMP collection again.</li> <li>• <b>Polling Started</b>—No action is required. Everything is working properly. Polling states will display activity.</li> <li>• <b>Polling Timed Out</b>—SNMP polling has timed out. This problem might occur if the wrong credentials were configured or might be caused by an internal error (such as SNMP was configured incorrectly or the destination is not reachable). Verify that SNMP credentials are correct. If the problem persists, restart polling to enable SNMP collection again.</li> <li>• <b>Unknown</b>—SNMP polling is not working due to one of the above-mentioned conditions. Check the SNMPv2c credential configuration.</li> </ul> |
| Last Polled Time            | Time stamp of the last time ANM polled the object.                                                                                                                                                                                                                                                                                                                                                                                                                                                                                                                                                                                                                                                                                                                                                                                                                                                                                                                                                                                                                                                                                                                                                                                                                                                                                |
| CLI Sync Status             | <p>(ACE virtual contexts only) Administrative configuration status of the context as follows:</p> <ul style="list-style-type: none"> <li>• <b>Import Failed</b>—The context did not import successfully. This problem could have occurred when the device was added to ANM or when the context was synchronized. Synchronize the context so that you can manage it (Config &gt; Devices &gt; ACE &gt; context &gt; Sync).</li> <li>• <b>OK</b>—The context is synchronized with the ACE CLI.</li> <li>• <b>Out of Sync</b>—The context is managed by ANM but the configuration for the context on the device differs from the configuration managed by ANM. For information on synchronizing contexts, see the <a href="#">“Synchronizing Virtual Context Configurations”</a> section on page 6-105.</li> <li>• <b>Unprovisioned</b>—The context has been removed from the ACE using the CLI but has not been removed from ANM. To remove unprovisioned contexts, synchronize the associated Admin context.</li> </ul> <p>For all polled objects that are not virtual contexts, the value <i>N/A</i> appears in this column because ANM does not support auto synchronization for the CSS, CSM, or GSS devices.</p>                                                                                                               |
| Last CLI Sync Status Change | <p>(ACE virtual contexts only) Time stamp of the last CLI synchronization with ANM.</p> <p>For all polled objects that are not virtual contexts, the value <i>N/A</i> appears in this column because ANM does not support auto synchronization for the CSS, CSM, or GSS devices.</p>                                                                                                                                                                                                                                                                                                                                                                                                                                                                                                                                                                                                                                                                                                                                                                                                                                                                                                                                                                                                                                              |

- Step 2** (Optional) To restart polling of an object, check the check box associated with the object and click **Restart Polling**.
- 

**Related Topics**

[Setting Polling Parameters, page 17-46](#)

## Setting Polling Parameters

You set polling parameters differently depending on the device type:

- ACE devices—You set polling on specific virtual contexts or configure global polling.
- CSM devices—You specify a single polling setting used by ANM.
- CSS devices—You specify a single polling setting used by ANM.
- GSS devices—You specify a single polling setting used by ANM for VIP Answers operation and configuration states and DNS Rules configuration states.

When you choose **Monitoring**, the monitoring data for your devices is extracted from cache. The Monitoring window refreshes every two minutes as new monitoring data is gathered.

When you import a context or device into ANM, the polling interval is set to 5 minutes by default. You can modify the polling parameter on each device (see the “[Enabling Polling on Specific Devices](#)” section on page 17-46) or you can modify the global parameter polling setting to change the polling parameters for all devices (see the “[Enabling Polling on All Devices](#)” section on page 17-47).

This section includes the following topics:

- [Enabling Polling on All Devices, page 17-47](#)
- [Disabling Polling on Specific Devices, page 17-47](#)
- [Enabling Polling on Specific Devices, page 17-46](#)
- [Disabling Polling on All Devices, page 17-48](#)

## Enabling Polling on Specific Devices

**Procedure**

---

- Step 1** Choose **Monitor > Devices > context > Polling Settings**.
- Step 2** In the Polling Stats field, click **Enable**.
- Step 3** From the Background Polling Interval field, choose a polling interval.
- Step 4** Click **Deploy Now** to save and apply the polling parameters.
- 

**Related Topics**

- [Disabling Polling on Specific Devices, page 17-47](#)
- [Enabling Polling on All Devices, page 17-47](#)
- [Disabling Polling on All Devices, page 17-48](#)

- [Displaying the Polling Status of All Managed Objects, page 17-44](#)

## Disabling Polling on Specific Devices

### Procedure

---

- Step 1** Choose **Monitor > Devices > context > Polling Settings**.
- Step 2** In the Polling Stats field, click **Disable**.
- Step 3** Click **Deploy Now** to disable polling.
- 

### Related Topics

- [Enabling Polling on Specific Devices, page 17-46](#)
- [Enabling Polling on All Devices, page 17-47](#)
- [Disabling Polling on All Devices, page 17-48](#)
- [Displaying the Polling Status of All Managed Objects, page 17-44](#)

## Enabling Polling on All Devices

You can enable polling and set the polling interval for all devices as shown in the following procedure.

### Guidelines and Restrictions

This topic includes the following guidelines and restrictions:

- Currently this feature is available for any user under the ANM Inventory role task. When a user is assigned this task, global polling configuration changes made are applied to all devices, irrespective of the domains that are assigned for this user.
- The time it takes the Polling Status window to reflect global changes that you make to the polling status or polling interval varies depending on the number of managed objects being polled. For information about viewing polling information, see the [“Displaying the Polling Status of All Managed Objects”](#) section on page 17-44.

### Procedure

---

- Step 1** Choose **Monitor > Settings > Global Polling Configuration**.
- Step 2** In the Polling Stats field, click **Enable**.
- Step 3** From the Background Polling Interval field, choose a polling interval.
- Step 4** Click **OK** to save and apply the polling parameters.
- 

### Related Topics

- [Enabling Polling on Specific Devices, page 17-46](#)
- [Disabling Polling on Specific Devices, page 17-47](#)

- [Disabling Polling on All Devices, page 17-48](#)
- [Displaying the Polling Status of All Managed Objects, page 17-44](#)

## Disabling Polling on All Devices

You can disable polling all devices as shown in the following steps.

### Procedure

- 
- Step 1** Choose **Monitor > Settings > Global Polling Configuration**.
- Step 2** In the Polling Stats field, click **Disable**.
- Step 3** Click **OK**.
- Polling is disabled.
- 

### Related Topics

- [Enabling Polling on Specific Devices, page 17-46](#)
- [Disabling Polling on Specific Devices, page 17-47](#)
- [Enabling Polling on All Devices, page 17-47](#)
- [Displaying the Polling Status of All Managed Objects, page 17-44](#)

## Configuring Historical Trend and Real Time Graphs for Devices

ANM allows you to store historical data for a selected list of statistics calculated over the last hour, 2-hour, 4-hour, 8-hour, 24-hour, or month interval. You can view this historical data as a statistical graph from specific Monitor > Devices monitoring screens. For each monitoring page, default statistics are defined and the graph is drawn for the selected object(s) from the page. ANM also allows you to display real-time statistical information related to the selected monitoring window.



### Note

---

All client browsers require that you enable Adobe Flash Player 9 to properly display the monitoring graphs provided in ANM.

---

Historical graphs are available from the following Monitor > Device monitoring windows:

- Traffic Summary window (CSS and ACE devices)
- Load Balancing > Virtual Server window (CSM and ACE)
- Load Balancing > Real Server window (CSM, CSS, and ACE devices)
- Load Balancing > Statistics window (ACE and CSM devices)
- Virtual Context-Based Resource Usage (ACE devices)

In each monitoring view window, click the **Graph** button to view the Graph page. From this page, you can view up to a maximum of four individual graphs of object data. Tooltips appears within each graph to allow you to see the datapoint values used for plotting.

If you choose, you can overlay multiple objects for comparison on the same graph. Each graph grid provides a comma-separated list of select statistics.

ANM supports a maximum of four lines per historical graph. The number of lines in a graph indicates the number of combinations of statistics and the objects (which can be a virtual server, real server, virtual context, and so on). For example, if you select two statistics and two real servers, then the number of possible combinations that can be displayed in a graph is four.

**Note**

The time displayed in all graphs is shown in ANM server time, not in client time.

**Procedure**

- Step 1** Choose **Monitor > Devices** to view device information.
- Step 2** Choose the specific monitoring window from which you want to display historical data graphs for a selected list of items.

Table 17-16 shows the different monitoring window types and how to select one.

**Table 17-16** *Selecting a Monitoring Window*

| To Access....          | Select..                                                                    |
|------------------------|-----------------------------------------------------------------------------|
| Resource Usage window  | <b>Monitor &gt; Devices &gt; <i>virtual_context</i> &gt; Resource Usage</b> |
| Traffic Summary window | <b>Monitor &gt; Devices &gt; Traffic Summary</b>                            |
| Virtual Servers window | <b>Monitor &gt; Devices &gt; Load Balancing &gt; Virtual Servers</b>        |
| Real Servers window    | <b>Monitor &gt; Devices &gt; Load Balancing &gt; Real Servers</b>           |
| Statistics window      | <b>Monitor &gt; Devices &gt; Load Balancing &gt; Statistics</b>             |

- Step 3** Check the check boxes of up to four objects in the selected monitoring window that you want to view and click **Graph**.
- The graph window appears. ANM updates the monitoring window with the graph of the selected objects (see Figure 17-12).

**Note**

The ANM software version that displays across the top of the window varies depending on your version of ANM.

Figure 17-12 Displaying Historical Graphs





- Step 4** (Optional) To enhance your viewing of the graphs, use the Collapse/Expand buttons to minimize or maximize a graph in the monitoring window.
- Step 5** (Optional) Use the graphing tools described in [Table 17-17](#) to modify the display.

Table 17-17 Historical Graph Tools

| Tool                                 | Description                                                                                                                                                                                                                                                       |
|--------------------------------------|-------------------------------------------------------------------------------------------------------------------------------------------------------------------------------------------------------------------------------------------------------------------|
| Add Graph button                     | Adds a graph to the selected monitoring window.                                                                                                                                                                                                                   |
| View As Chart and View As Grid icons | Toggles the display of an object graph in the monitoring window between a grid and a graph.<br>The grid displays include the <b>Export to Excel</b> hyperlink that allows you to export object data to Microsoft Excel for archiving or other purposes.           |
| Show As Image icon                   | Allows you to save the graph as a JPEG file for archiving or other purposes. When you mouse over the graph, the Image Toolbar appears. From the Image Toolbar, you can save the graph as a JPEG or send it in an e-mail. You can also print the graph if desired. |

Table 17-17 Historical Graph Tools

| Tool                  | Description                                                                                                                                                                                                                                                                                                                                                                                                                                                                                                                                                                                                                                                                                                                                                                                                                                                                                                                                                                                                                                                                                                                                                                                                                                                                                                                                                                                                                                                                     |
|-----------------------|---------------------------------------------------------------------------------------------------------------------------------------------------------------------------------------------------------------------------------------------------------------------------------------------------------------------------------------------------------------------------------------------------------------------------------------------------------------------------------------------------------------------------------------------------------------------------------------------------------------------------------------------------------------------------------------------------------------------------------------------------------------------------------------------------------------------------------------------------------------------------------------------------------------------------------------------------------------------------------------------------------------------------------------------------------------------------------------------------------------------------------------------------------------------------------------------------------------------------------------------------------------------------------------------------------------------------------------------------------------------------------------------------------------------------------------------------------------------------------|
| Select button (upper) | <p>Allows you to add one or more objects to a graph in the monitoring window to compare the performance of one object with its peer for the selected statistics. Do the following:</p> <ol style="list-style-type: none"> <li>a. In the graph that contains the object you want to replace, click the upper <b>Select</b> button.</li> </ol> <div style="border: 1px solid black; padding: 5px; margin: 10px 0;"> <p> <b>Note</b> You cannot perform this function from the Resource Usage graph window, which contains only one Select button. This button is used for selecting multiple statistics (see <a href="#">Select button (lower)</a>).</p> </div> <p>The Objects Selector popup window appears.</p> <ol style="list-style-type: none"> <li>b. From the Objects Selector popup window, choose up to four objects and do one of the following: <ul style="list-style-type: none"> <li>– Click <b>OK</b> to return to the graph window, which displays your selected objects.</li> <li>– Click <b>Cancel</b> to ignore any selections and return to the original graph.</li> </ul> </li> </ol>                                                                                                                                                                                                                                                                                        |
| Select button (lower) | <p>To select multiple statistics for display in a graph in the monitoring window, perform the following steps:</p> <ol style="list-style-type: none"> <li>a. In the graph of the object that you want to add statistics, click the lower <b>Select</b> button within the graph.</li> </ol> <p>The Select Stats popup window appears.</p> <div style="border: 1px solid black; padding: 5px; margin: 10px 0;"> <p> <b>Note</b> The Resource Usage graph window contains only one <b>Select</b> button; click this button.</p> </div> <ol style="list-style-type: none"> <li>b. From the Select Stats popup window, choose the statistics to add to the graph.</li> </ol> <p>You can choose up to four statistics for display in a graph and the object statistics must be of the same unit of measure (for example, bytes/sec.). The selected statistics appear in the existing object graph in the monitoring window.</p> <p>Do one of the following:</p> <ul style="list-style-type: none"> <li>– Click <b>OK</b> to return to the graph window, which displays your selected statistics.</li> <li>– Click <b>Set As Default And Draw Graph</b> to set the current selections as the default objects to graph and return to the graph window, which displays your selected statistics.</li> <li>– Click <b>Cancel</b> to ignore any selections and return to the original graph.</li> </ul> |

**Table 17-17** Historical Graph Tools

| Tool                | Description                                                                                                                                                                                                                                                                                                                                                                                                                                                                                                                                                                                                                                                                                                                                                                                                                                                                                                                                                                                                                                                                                                                                                                                                                                                                                                                                                                                                                                                   |
|---------------------|---------------------------------------------------------------------------------------------------------------------------------------------------------------------------------------------------------------------------------------------------------------------------------------------------------------------------------------------------------------------------------------------------------------------------------------------------------------------------------------------------------------------------------------------------------------------------------------------------------------------------------------------------------------------------------------------------------------------------------------------------------------------------------------------------------------------------------------------------------------------------------------------------------------------------------------------------------------------------------------------------------------------------------------------------------------------------------------------------------------------------------------------------------------------------------------------------------------------------------------------------------------------------------------------------------------------------------------------------------------------------------------------------------------------------------------------------------------|
| Time drop-down list | <p>Modifies the time interval for the accumulated statistics displayed in a graph. Time interval choices include the average data calculated during the last hour, 2-hour, 4-hour, 8-hour, 24-hour, or 30-day (last month) interval. The time choices also include the Real Time option, which displays a maximum of 3 minutes of data at 10-second intervals (not configurable).</p> <p>Note the following usage considerations for the time interval for accumulated statistics:</p> <ul style="list-style-type: none"> <li>• When you specify to view average data calculated during the last hour, 2-hour, 4-hour, or 8-hour interval, raw data points collected by ANM within the selected time period will be displayed. For example, when you specify to view the data of the last hour, if ANM has been collecting data for over an hour at a default 5-minute interval, you will see 12 data points on the graph.</li> <li>• When you specify to view average data calculated during the last 24-hour interval, consolidated hourly data points will be displayed. For example, if ANM has been collecting data for more than 24 hours, you will see 24 data points on the graph.</li> <li>• When you specify to view average data calculated during the last 30-day interval, consolidated daily data points will be displayed. For example, if ANM has been collecting data for over 30 days, you will see 30 data points on the graph.</li> </ul> |

**Step 6** To exit the display of graphs, click **Exit Graph**.

## Exporting Historical Data



### Note

The data export feature requires either the ANM\_ADMIN role or a role with a ANM\_System privilege other than no-access.

You can enable or disable the data export feature that allows ANM to export the historical data that it collects on the network devices that it manages. You create a data file purging policy to enable or disable the data export feature and define the purging attributes associated with this feature.

By default, the data export feature is enabled, allowing ANM to export the raw statistical data that it collects during a polling session to the comma-separated values (CSV) data files in the following directory:

```
/var/lib/anm/export/historical-data/date-stamp
```

where *date-stamp* is the directory name, which is based on the date when the file was created and uses the format YYYY-MM-DD. For example, 2010-05-25. The exported data is saved to the files according to device type (for example, ACE\_MODULE, CSS, or CSM) and its record type (for example, RT\_INT or RT\_CPU).



The data export feature includes a *data dictionary* (stats-export.dict), which defines the device type and record type and can be used to interpret the data content and format of the exported files. You can download the data dictionary, which is written in XML, and display its content using IE browser or any XML editor/viewer, such as Stylus Studio. The data dictionary can be used as a tool when writing a script to extract specific data from a data file. For example, you can create a script that extracts data based on a device type, such as an ACE, that shows interface statistics for a virtual context within the ACE.

Each record/row in the exported data file contains the following information:

- Timestamp (in the format defined by the data dictionary)
- Device-type
- Optional record-type (defined in the data dictionary and used to define the format of each record)
- Managed entity name (fully qualified name of the managed object with which the statistical data is associated; it should have the same name shown in the historical graph)
- List of statistical data (list order is defined in the data dictionary associated with the record-type)

The first line of each exported data file is a header describing the column of each row. Each field of the record is separated by the separator character, which is currently defined in the data dictionary as the comma. If the metric value is unknown, its value is left empty. Each record is separated by a new line character.

The following data file content sample shows the data file header followed by the statistical information:

```
DeviceType, RecordType, Timestamp, ManagedEntity, Current Connections, Total Connections,
Dropped Connections, Total Client Packets, Total Server Packets, Total Client Bytes, Total
Server Bytes, Total Drops Due To Maximum Connection Limit, Total Drops Due To Connection
Rate Limit, Total Drops Due To Bandwidth Limit
DT-ACE-VC,RT-VS,2010-05-28-14:21:08,172.23.244.130:2:Admin/test/global,0,0,0,0,0,0,0,0,0,0,0,0,0
DT-ACE-APPLIANCE-VC,RT-VS,2010-05-28-14:21:08,172.23.244.212:Admin/test_vs_3/global,0,0,0,
0,0,0,0,0,0,0,0,0,0
```

The header column names DeviceType, RecordType, Timestamp, and ManagedEntity are mandatory. The definitions of the mandatory headers can be found in the following data dictionary XML tags:

- DeviceType definition is inside the *device-type* tag.
- RecordType definition is inside the *record-type* tag.
- ManagedEntity definition is inside the *managed-entity* tag.

The column names that follow the mandatory names are the display names of the statistic.

#### Guidelines and Restrictions:

The data export guidelines and restrictions are as follows:

- The time at which ANM exports the data file is not configurable.
- By default, ANM exports raw historical data only. Snapshots and consolidated historical data (average, minimum, maximum) are not exported.

The data export purging operation guidelines and restrictions are as follows:

- ANM purges exported data according to the configurable purging policy. By default, the purging policy instructs ANM to purge the data file if it stays for more than 32 days or the total combined export data is bigger than 10000 M (10 G) of disk space or the disk usage is more than 80 percent.
- You can configure ANM to send an email notification to up to five recipients when the disk space usage is higher than the defined threshold.
- Each purge action removes at least one day of exported statistical data.

**Procedure**

- Step 1** Choose **Monitor > Settings > Historical Data Export**.  
The Historical Data Export window appears.
- Step 2** Configure the data export purging policy as shown in [Table 17-18](#).

**Table 17-18** Historical Data Export Fields

| Item                                                                                                         | Description                                                                                                                                                                                                                                                                                                                                                                                                                                                                                                                                                                                                                                                                                                                                                                                                                                                                                                     |
|--------------------------------------------------------------------------------------------------------------|-----------------------------------------------------------------------------------------------------------------------------------------------------------------------------------------------------------------------------------------------------------------------------------------------------------------------------------------------------------------------------------------------------------------------------------------------------------------------------------------------------------------------------------------------------------------------------------------------------------------------------------------------------------------------------------------------------------------------------------------------------------------------------------------------------------------------------------------------------------------------------------------------------------------|
| Retention Period (In Days)                                                                                   | Maximum number of days that ANM is to keep the exported data files. The valid range is 1 to 365 days. The default is 32.                                                                                                                                                                                                                                                                                                                                                                                                                                                                                                                                                                                                                                                                                                                                                                                        |
| Maximum Size Of Exported Data (In MBytes)                                                                    | Maximum allowable size of the data file to export. The valid range is 100 MB to 100000 MB. The default is 10000 MB.                                                                                                                                                                                                                                                                                                                                                                                                                                                                                                                                                                                                                                                                                                                                                                                             |
| Current Size Of Exported Data (In MBytes)                                                                    | (Read only) Current size of the data file.                                                                                                                                                                                                                                                                                                                                                                                                                                                                                                                                                                                                                                                                                                                                                                                                                                                                      |
| Disk Space Utilization Threshold (In %)                                                                      | Percentage of disk space that the data file can utilize.                                                                                                                                                                                                                                                                                                                                                                                                                                                                                                                                                                                                                                                                                                                                                                                                                                                        |
| Current Disk Space Utilization (In %)                                                                        | (Read only) Current amount of disk space that the data file is utilizing.                                                                                                                                                                                                                                                                                                                                                                                                                                                                                                                                                                                                                                                                                                                                                                                                                                       |
| Do You Want To Disable Data Export                                                                           | Check box for enabling or disabling the data export feature as follows: <ul style="list-style-type: none"> <li>Unchecked—Data export is enabled. This is the default setting.</li> <li>Checked—Data export is disabled.</li> </ul>                                                                                                                                                                                                                                                                                                                                                                                                                                                                                                                                                                                                                                                                              |
| E-mail Address To Send Notification When Disk Usage Is Greater Than Disk Space Utilization Threshold Setting | <p>Email addresses that ANM sends a notification to when the amount of disk space utilized by the data file exceeds the specified Disk Space Utilization Threshold value. ANM sends an email notification only once every 24 hours even when threshold-exceeding condition persists.</p> <p>Enter an email address and click the right arrow to add it to the list of email addresses to receive notifications. You can specify up to five email addresses. To edit or remove an address from the list, use the left arrow or double-click the address to move it to the edit box where you can modify or delete it.</p> <p> <b>Note</b> For email notifications, you must specify an SMTP server to use for outgoing emails (see the <a href="#">“Configuring SMTP for Email Notifications”</a> section on page 17-68).</p> |
| Status                                                                                                       | <p>Current status of the data export feature as follows:</p> <ul style="list-style-type: none"> <li>RUNNING—Data export is enabled. An alert message may display in parenthesis next to the Running status.</li> <li>STOP—Data export is disabled.</li> </ul> <p>To change the status, see the Do You Want To Disable Data Export checkbox.</p>                                                                                                                                                                                                                                                                                                                                                                                                                                                                                                                                                                 |
| Statistical Data Last Purge At                                                                               | (Read only) Server time when ANM last purged the data file.                                                                                                                                                                                                                                                                                                                                                                                                                                                                                                                                                                                                                                                                                                                                                                                                                                                     |
| Reason For Purging                                                                                           | (Read only) Reason why ANM purged the data file; retention period, total size of the exported data file, or disk space usage.                                                                                                                                                                                                                                                                                                                                                                                                                                                                                                                                                                                                                                                                                                                                                                                   |
| Location Of Exported Data                                                                                    | (Read only) Path to the exported data files:<br>/var/lib/anm/export/historical-data.                                                                                                                                                                                                                                                                                                                                                                                                                                                                                                                                                                                                                                                                                                                                                                                                                            |

- Step 3** (Optional) To download a copy of the data dictionary in zip file format, click **Download Data Dictionary**.
- Step 4** To save the current data file purging policy, click **Save**.

#### Related Topics

- [Configuring SMTP for Email Notifications, page 17-68](#)

## Monitoring Events

The events captured in the Events table include both ACE syslog events and SNMP trap events. A procedure for viewing both types of events and details of information extracted from the syslog are shown below. Fields providing traffic-oriented sorting capability, specifically the information signified by the column heads in the Events Fields window, shown in [Table 17-19](#) (Source IP, Source Port, Destination IP, Destination Port, and Protocol) are only available for the ACE syslogs.



#### Note

We do not recommend that you send a high volume of syslogs to ANM. ANM will only process and persist syslogs at 100 messages per second. Any additional syslogs sent to ANM beyond that rate will be discarded. To address this behavior, set the syslog severity level to a setting that is no higher than the warning level (a severity level of 4-Warning). See the [“Configuring Virtual Context Syslog Settings” section on page 6-19](#) for details.

#### Assumptions

To receive events from devices, the devices must have syslog and SNMP traps configured correctly. See the [“Configuring Virtual Context Syslog Settings” section on page 6-19](#) and the [“Configuring SNMP for Virtual Contexts” section on page 6-27](#).

#### Procedure

- Step 1** Choose **Monitor > Events**.

ANM displays all events received from ACE for Syslog and SNMP traps for all virtual contexts. See [Table 17-19](#) for a description of the displayed information, which is extracted from the syslog.

You can sort information in the table by clicking on a column heading. This allows you to group events and help troubleshooting traffic information.

**Table 17-19** *Monitor > Events Fields*

| Field             | Description                                                                                                      |
|-------------------|------------------------------------------------------------------------------------------------------------------|
| Syslog ID/SNMP ID | Displays the Syslog ID and SNMP ID. If the event is a trap, this field is empty.                                 |
| Severity          | Indicates the syslog severity level as described in <a href="#">Table 6-5</a> .                                  |
| Origination Time  | Date and time that the event was last changed in the database.                                                   |
| Source IP         | Displays the source name that is reporting the event, for example, <i>&lt;chassis/slot&gt;:virtual_context</i> . |
| Source Port       | Displays the source port.                                                                                        |
| Destination IP    | Displays the IP address of the destination if available.                                                         |

**Table 17-19** Monitor > Events Fields (continued)

| Field            | Description                                 |
|------------------|---------------------------------------------|
| Destination Port | Displays the destination port if available. |
| Protocol         | Protocol used in the syslog.                |
| Detail           | Provides additional detail about the event. |

[Table 17-20](#) displays the complete list of published ACE syslogs where source and destination IP, ports and protocols are parsed so that the designated table fields populate.

**Note**

Only the ACE syslog messages shown in this table will populate the Events window fields explained in [Table 17-19](#). Syslogs and traps not in this table will populate fields with a 0.

**Table 17-20 ACE Syslogs Fields with Perishable Traffic Oriented Sorting Information**

| Syslog       | Message Contents                                                                                                                                                                                                           |
|--------------|----------------------------------------------------------------------------------------------------------------------------------------------------------------------------------------------------------------------------|
| ACE-1-106021 | <i>Deny protocol reverse path check from source_address to dest_address on interface interface_name</i>                                                                                                                    |
| ACE-4-106023 | <i>Deny protocol number   name src incoming-interface:src-ip dst outgoing-interface:dst-ip by access-group "acl-name" (hash 1, hash 2)</i>                                                                                 |
| ACE-6-302022 | <i>Built TCP connection id for interface:real-address/real-port (mapped-address/mapped-port) to interface:real-address/real-port (mapped-address/mapped-port)</i>                                                          |
| ACE-6-302023 | <i>Teardown TCP connection id for interface:real-address/real-port to interface:real-address/real-port duration hh:mm:ss bytes bytes [reason]</i>                                                                          |
| ACE-6-302024 | <i>Built UDP connection id for interface:real-address/real-port (mapped-address/mapped-port) to interface:real-address/real-port (mapped-address/mapped-port)</i>                                                          |
| ACE-6-302025 | <i>Teardown UDP connection id for interface:real-address/real-port to interface:real-address/real-port duration hh:mm:ss bytes bytes</i>                                                                                   |
| ACE-6-302026 | <i>Built ICMP connection for faddr/NATed_ID gaddr/icmp_type laddr/icmpID</i>                                                                                                                                               |
| ACE-6-302027 | <i>Teardown ICMP connection for faddr/NATed ID gaddr/icmp_type laddr/icmpID</i>                                                                                                                                            |
| ACE-6-302028 | <i>Built TCP connection id for interface: real-address/real-port (mapped-address/mapped-port) to interface: real-address/real-port (mapped-address/mapped-port)</i>                                                        |
| ACE-6-302029 | <i>Teardown TCP connection id for interface: real-address/real-port to interface: real-address/real-port duration hh:mm:ss bytes bytes [reason]</i>                                                                        |
| ACE-6-302030 | <i>Built UDP connection id for interface: real-address/real-port (mapped-address/mapped-port) to interface: real-address/real-port (mapped-address/mapped-port)</i>                                                        |
| ACE-6-302031 | <i>Teardown UDP connection id for interface: real-address/real-port to interface: real-address/real-port duration hh:mm:ss bytes bytes</i>                                                                                 |
| ACE-4-313004 | <i>Denied ICMP type=icmp_type, from source_address on interface interface_name to dest_address:no matching session</i>                                                                                                     |
| ACE-4-410001 | <i>Dropped UDP DNS packet_type from source_interface:source_address/source_port to dest_interface:dest_address/dest_port; error_length_type length length bytes exceeds max_length_type limit of maximum_length bytes.</i> |

**Related Topics**

- [Monitoring Devices, page 17-24](#)
- [Performing Device Audit Trail Logging, page 18-59](#)

## Configuring Alarm Notifications on ANM

To set up Monitoring alarm notifications, you define a threshold group and specify the statistics to be monitored by ANM for the threshold group. When the value for a specific statistic rises above the setting you specify, an alarm is issued to alert you.

**Note**

CISCO-EPM-NOTIFICAITON-MIB is used for ANM alarms notification.

You can specify how you are notified when thresholds are crossed:

- Alarm notification, which you view at **Monitor > Alarm Notifications > Alarms**.
- Email notification.
- Traps.
- Mobile device alarm notification. This method requires ANM 5.1 or later and a supported mobile device with the Cisco ANM Mobile app. For more information about ANM Mobile, see [Chapter 19, “Using ANM Mobile.”](#)

**Note**

Threshold crossing is detected using periodic polling. If a threshold is crossed *between* polling cycles, it is possible that ANM License Manager might not issue an alert if the condition recovers before the next polling cycle.

**Guidelines and Restrictions**

For certificates that you have loaded on the ACE, you can configure ANM to issue an alarm notification when the certificate expiration date is approaching. ANM performs certificate expiration computations every 24 hours. The computation begins each time ANM is started. Every subsequent computation occurs 24 hours thereafter.

**Note**

The Certificates window (Config > Devices > context > SSL > Certificates) contains the Expiry Date field, which displays the certificate expiration date. Due to a known issue with the ACE module and appliance, it is possible that this field displays either “Null” or characters that cannot be parsed or that are unreadable. When this issue occurs, ANM cannot track the certificate expiration date. If the certificate is defined in a threshold group configured for certificate expiration alarm notifications and this issue occurs, ANM may not issue an expiration alarm when expected or it may issue a false alarm. If you encounter this issue, remove the certificate from the ACE, reimport it, and then verify that the correct expiration date appears in the Certificates window.

**Prerequisites**

For email notifications, you have specified an SMTP server to use for outgoing emails (see the [“Configuring SMTP for Email Notifications”](#) section on page 17-68).

**Procedure**

- Step 1** Choose **Monitor > Alarm Notifications > Threshold Groups**, and click **Add**.
- Step 2** In the Properties section, enter the name and description for the threshold group.
- Step 3** In the Threshold Settings section, click **Add** and then enter the following information shown in [Table 17-21](#).

**Table 17-21** Threshold Settings Fields

| Field           | Description                                                                                                                                                                                                                                                                                                                                                                                                                                                                                                                                                                                   |
|-----------------|-----------------------------------------------------------------------------------------------------------------------------------------------------------------------------------------------------------------------------------------------------------------------------------------------------------------------------------------------------------------------------------------------------------------------------------------------------------------------------------------------------------------------------------------------------------------------------------------------|
| Device Type     | Choose the device type to include in the threshold group. <i>VC</i> indicates ACE virtual context.                                                                                                                                                                                                                                                                                                                                                                                                                                                                                            |
| Category        | Choose a statistic to include in the threshold group. <a href="#">Table 17-22</a> identifies and describes the types of statistics available for each device type.<br><br><b>Note</b> We do not recommend that you include ACL Memory (ACE module and ACE appliance) or Current Application Acceleration Connections (ACE appliance only) as statistics in a threshold group. The values provide through the associated <b>show resource usage</b> CLI command regarding the utilization of these two threshold parameters does not accurately reflect the real usage of these two resources. |
| Assert on Value | Enter a value to define the threshold. When the statistic exceeds this value, an alarm is issued. Some values are displayed as percentages as indicated by the percent sign (%).<br><br>In the case of SSL certificate expiration, assert on value indicates the number of days before certificate expiration. Alarms will be updated daily to indicate the number of days remaining until certificate expiration. If the email is configured, you will be sent email daily alerting you to the number of days left before expiration.                                                        |
| Clear Value     | Enter a value on which to clear the alarm.<br><br>In the case of SSL certificate expiration, the setting has no relevance. When an expired certificate is deleted, the alarm is removed from ANM on the subsequent certificate evaluation. This happens every 24 hours.                                                                                                                                                                                                                                                                                                                       |
| Notify on Clear | Check the <b>Notify on Clear</b> check box to receive an email notification to the specified address when the alarm is cleared.                                                                                                                                                                                                                                                                                                                                                                                                                                                               |
| Severity        | Choose a severity level for this threshold, which can be <b>Critical</b> , <b>Info</b> , <b>Major</b> , or <b>Minor</b> .                                                                                                                                                                                                                                                                                                                                                                                                                                                                     |

[Table 17-22](#) provides details for the [Category](#) field found in [Table 17-21](#).

Table 17-22 Monitoring Thresholds by Device Type

| Category                     | Threshold                                    | Description                                                                                                                                                                                                                                                                                                                                                                                               |
|------------------------------|----------------------------------------------|-----------------------------------------------------------------------------------------------------------------------------------------------------------------------------------------------------------------------------------------------------------------------------------------------------------------------------------------------------------------------------------------------------------|
| <b>ACE 4710 Appliance</b>    |                                              |                                                                                                                                                                                                                                                                                                                                                                                                           |
|                              | ACL Memory                                   | Percentage of memory allocated for ACLs.<br><b>Note</b> We do not recommend that you include ACL Memory as a statistic in a threshold group. The value provided through the associated <b>show resource usage</b> CLI command regarding the utilization of ACL memory does not accurately reflect the real usage of this resource.                                                                        |
|                              | Bandwidth                                    | Percentage of throughput.                                                                                                                                                                                                                                                                                                                                                                                 |
|                              | Concurrent Connections                       | Percentage of simultaneous connections.                                                                                                                                                                                                                                                                                                                                                                   |
|                              | Current Application Acceleration Connections | Percentage of application acceleration connections.<br><b>Note</b> We do not recommend that you include Current Application Acceleration Connections as a statistic in a threshold group. The value provided through the associated <b>show resource usage</b> CLI command regarding the utilization of application acceleration connections does not accurately reflect the real usage of this resource. |
|                              | Current Connection Rate                      | Percentage of connections of any kind.                                                                                                                                                                                                                                                                                                                                                                    |
|                              | Current HTTP Compression Rate                | Percentage of compression for HTTP data.                                                                                                                                                                                                                                                                                                                                                                  |
|                              | Inspect Connection Rate                      | Percentage of application protocol inspection connections.                                                                                                                                                                                                                                                                                                                                                |
|                              | MAC Miss Rate                                | Percentage of messages destined for the ACE that are sent to the control plane when the encapsulation is not correct in packets.                                                                                                                                                                                                                                                                          |
|                              | Management Connections                       | Percentage of management connections.                                                                                                                                                                                                                                                                                                                                                                     |
|                              | Management Traffic Rate                      | Percentage of management traffic connections.                                                                                                                                                                                                                                                                                                                                                             |
|                              | Proxy Connections Rate                       | Percentage of proxy connections.                                                                                                                                                                                                                                                                                                                                                                          |
|                              | Regular Expression Memory                    | Percentage of regular expression memory.                                                                                                                                                                                                                                                                                                                                                                  |
|                              | SSL Connection Rate                          | Percentage of SSL connections.                                                                                                                                                                                                                                                                                                                                                                            |
|                              | Syslog Buffer Size                           | Percentage of the syslog buffer.                                                                                                                                                                                                                                                                                                                                                                          |
|                              | Syslog Message Rate                          | Percentage of syslog messages per second.                                                                                                                                                                                                                                                                                                                                                                 |
|                              | Translation Entries                          | Percentage of network and port address translations.                                                                                                                                                                                                                                                                                                                                                      |
| Device                       | Device Status                                | ACE operating status changes from Up to Down and vice versa.                                                                                                                                                                                                                                                                                                                                              |
| <b>ACE 4710 Appliance VC</b> |                                              |                                                                                                                                                                                                                                                                                                                                                                                                           |
| Application Acceleration     | Condenser State                              | State of the condenser.                                                                                                                                                                                                                                                                                                                                                                                   |



Table 17-22 Monitoring Thresholds by Device Type (continued)

| Category                    | Threshold                            | Description                                                                                                                                                                                                                                                                                                                                                                                                                     |
|-----------------------------|--------------------------------------|---------------------------------------------------------------------------------------------------------------------------------------------------------------------------------------------------------------------------------------------------------------------------------------------------------------------------------------------------------------------------------------------------------------------------------|
| HA                          | Redundancy State                     | ACE virtual context HA or fault tolerance (FT) state changes. Possible FT states are Active, Standby Hot, and Other, which represents all other FT states, including the following: <ul style="list-style-type: none"> <li>• Non-Redundant—Virtual context is not included in any FT group.</li> <li>• Unknown—Virtual context becomes inaccessible, for example if the ACE that it resides in becomes unresponsive.</li> </ul> |
| Interface                   | Interface Operational State          | Operational state of the interface.                                                                                                                                                                                                                                                                                                                                                                                             |
| Probes                      | Probe Health State                   | Operational health of the health monitoring probe.                                                                                                                                                                                                                                                                                                                                                                              |
| Real Server <sup>1</sup>    | Real Server Current Connections      | Number of current connections on a real server.                                                                                                                                                                                                                                                                                                                                                                                 |
|                             | Real Server Operational State        | Operational state of a real server.                                                                                                                                                                                                                                                                                                                                                                                             |
| SLB Stat                    | Layer 4 Policy Connections           | Number of Layer 4 policy connections.                                                                                                                                                                                                                                                                                                                                                                                           |
|                             | Layer 7 Policy Connections           | Number of Layer 7 policy connections.                                                                                                                                                                                                                                                                                                                                                                                           |
| SSL Certificate Management  | SSL certificate expiration (in days) | Number of days left before SSL certificate expires whose value minus one will send a warning email with the specified severity. ANM updates this field daily.                                                                                                                                                                                                                                                                   |
| Virtual Server <sup>1</sup> | Virtual Server Current Connections   | Number of active virtual server connections.                                                                                                                                                                                                                                                                                                                                                                                    |
|                             | Virtual Server Operational State     | Operational state of a virtual server.                                                                                                                                                                                                                                                                                                                                                                                          |

Table 17-22 Monitoring Thresholds by Device Type (continued)

| Category          | Threshold                     | Description                                                                                                                                                                                                                                                                                                                                                                                                             |
|-------------------|-------------------------------|-------------------------------------------------------------------------------------------------------------------------------------------------------------------------------------------------------------------------------------------------------------------------------------------------------------------------------------------------------------------------------------------------------------------------|
| <b>ACE Module</b> |                               |                                                                                                                                                                                                                                                                                                                                                                                                                         |
|                   | ACL Memory                    | Percentage of memory allocated for ACLs.<br><br><b>Note</b> We do not recommend that you include ACL Memory as a statistic in a threshold group. The value provided through the associated <b>show resource usage</b> CLI command regarding the utilization of ACL memory does not accurately reflect the real usage of this resource.                                                                                  |
|                   | Bandwidth                     | Percentage of bandwidth.                                                                                                                                                                                                                                                                                                                                                                                                |
|                   | Concurrent Connections        | Percentage of simultaneous connections.                                                                                                                                                                                                                                                                                                                                                                                 |
|                   | Current Connection Rate       | Percentage of connections of any kind.                                                                                                                                                                                                                                                                                                                                                                                  |
|                   | Current HTTP Compression Rate | Percentage of compression for HTTP data. This field appears only for an ACE module version A4(1.0) or later.                                                                                                                                                                                                                                                                                                            |
|                   | Inspect Connection Rate       | Percentage of application protocol inspection connections.                                                                                                                                                                                                                                                                                                                                                              |
|                   | MAC Miss Rate                 | Percentage of messages destined for the ACE that are sent to the control plane when the encapsulation is not correct in packets.                                                                                                                                                                                                                                                                                        |
|                   | Management Connections        | Percentage of management connections.                                                                                                                                                                                                                                                                                                                                                                                   |
|                   | Management Traffic Rate       | Percentage of management traffic connections.                                                                                                                                                                                                                                                                                                                                                                           |
|                   | Proxy Connections Rate        | Percentage of proxy connections.                                                                                                                                                                                                                                                                                                                                                                                        |
|                   | Regular Expression Memory     | Percentage of regular expression memory.                                                                                                                                                                                                                                                                                                                                                                                |
|                   | SSL Connection Rate           | Percentage of SSL connections.                                                                                                                                                                                                                                                                                                                                                                                          |
|                   | Syslog Buffer Size            | Percentage of the syslog buffer.                                                                                                                                                                                                                                                                                                                                                                                        |
|                   | Syslog Message Rate           | Percentage of syslog messages per second.                                                                                                                                                                                                                                                                                                                                                                               |
|                   | Throughput                    | Percentage of throughput.                                                                                                                                                                                                                                                                                                                                                                                               |
|                   | Translation Entries           | Percentage of network and port address translations.                                                                                                                                                                                                                                                                                                                                                                    |
| Device            | Device Status                 | ACE operating status changes from Up to Down and vice versa.                                                                                                                                                                                                                                                                                                                                                            |
| <b>ACE VC</b>     |                               |                                                                                                                                                                                                                                                                                                                                                                                                                         |
| HA                | Redundancy State              | ACE virtual context HA or fault tolerance (FT) state changes. Possible FT states are Active, Standby Hot, and Other, which represents all other FT states, including the following: <ul style="list-style-type: none"> <li>• Non-Redundant—Virtual context is not included in any FT group.</li> <li>• Unknown—Context becomes inaccessible, for example if the ACE that it resides in becomes unresponsive.</li> </ul> |
| Interface         | Interface Operational State   | Operational state of the interface.                                                                                                                                                                                                                                                                                                                                                                                     |

**Table 17-22** *Monitoring Thresholds by Device Type (continued)*

| Category                    | Threshold                            | Description                                                                                                                                                   |
|-----------------------------|--------------------------------------|---------------------------------------------------------------------------------------------------------------------------------------------------------------|
| Probes                      | Probe Health State                   | Operational health of the health monitoring probe.                                                                                                            |
| Real Server <sup>1</sup>    | Real Server Current Connections      | Number of current connections on a real server.                                                                                                               |
|                             | Real Server Operational State        | Operational state of a real server.                                                                                                                           |
| SLB Stat                    | Layer 4 Policy Connections           | Number of Layer 4 policy connections.                                                                                                                         |
|                             | Layer 7 Policy Connections           | Number of Layer 7 policy connections.                                                                                                                         |
| SSL Certificate Management  | SSL certificate expiration (in days) | Number of days left before SSL certificate expires whose value minus one will send a warning email with the specified severity. ANM updates this field daily. |
| Virtual Server <sup>1</sup> | Virtual Server Current Connections   | Number of active virtual server connections.                                                                                                                  |
|                             | Virtual Server Operational State     | Operational state of a virtual server.                                                                                                                        |
| <b>CSM Module</b>           |                                      |                                                                                                                                                               |
| Real Server                 | Real Server Connections              | Number of real server connections.                                                                                                                            |
|                             | Real Server Current State            | Operational state of a real server.                                                                                                                           |
| SLB Stat                    | Current Opened Connections           | Number of open connections.                                                                                                                                   |
|                             | Layer 4 Policy Connections           | Number of Layer 4 policy connections.                                                                                                                         |
|                             | Layer 7 Policy Connections           | Number of Layer 7 policy connections.                                                                                                                         |
| SLB Virtual Server          | Virtual Server Connections           | Number of virtual server connections.                                                                                                                         |
|                             | Virtual Server State                 | Operational state of a virtual server.                                                                                                                        |
| System                      | CSM Fault Tolerance State            | Fault tolerance state of the CSM.                                                                                                                             |
| Device                      | Device Status                        | CSM operating status changes from Up to Down and vice versa.                                                                                                  |
| <b>CSS</b>                  |                                      |                                                                                                                                                               |
| Interface                   | Average TCP Packets                  | Average number of TCP packets.                                                                                                                                |
|                             | Interface Operational State          | Operational state of the interface.                                                                                                                           |
|                             | Max TCP Packets                      | Maximum number of TCP packets.                                                                                                                                |
| Real Server                 | Active Service Connections           | Number of active real server connections.                                                                                                                     |
|                             | Real Server State                    | State of a real server.                                                                                                                                       |
| System                      | CSS Fault Tolerance State            | Fault tolerance state of the CSS.                                                                                                                             |
|                             | CSS Module State                     | State of a CSS module.                                                                                                                                        |
| Virtual Server              | Virtual Server State                 | Current state of a virtual server.                                                                                                                            |
| Device                      | Device Status                        | CSS operating status changes from Up to Down and vice versa.                                                                                                  |
| <b>GSS</b>                  |                                      |                                                                                                                                                               |
| Device                      | Device Status                        | GSS operating status changes from Up to Down and vice versa.                                                                                                  |

1. Category choices support mobile device notifications.

**Step 4** Click **OK**.

**Step 5** In Device Selection, choose the device type to include in the threshold group.

The available devices appear in the Available Items field.



---

**Note** Make sure that the device type you select in this field is supported by the threshold that you selected in the Category field in Step 3. If the device type you select is not supported by the threshold you selected, you will not receive alarm notifications.

---

**Step 6** Click on a device in the Available Items field, and then the arrow (>) to move the device to the Selected Items field.

**Step 7** In the Notify By section, do the following:

- a. In the E-mail field, enter the email address that you want to receive notification email.

See the [“Displaying Email Notifications” section on page 17-66](#) for information contained in the email notifications. If you do not select this field, you must view alarm notifications by selecting **Monitor > Alarm Notifications > Alarm**.



---

**Note** You must configure the required host parameters, IP address and port, to send email notifications. See the [“Configuring SMTP for Email Notifications” section on page 17-68](#).

---

- b. Check the Domain sensitive email notification check box to receive filtered email about certificate expirations for the certificates defined in the current domain only. The emails are sent to the email address configured for the RBAC user definition (see the [“Managing User Accounts” section on page 18-17](#)). Uncheck this check box to disable this feature.



---

**Note** This attribute appears only when the selected device type is either the ACE 4710 VC or the ACE VC and the category type is set to SSL Certificate expirations (in days).

---

- c. In the Traps field, enter the host IP Address and port number of the machine to which the traps are sent.

See the [“Displaying Traps” section on page 17-67](#) for information contained in the traps.

- d. Check the **Mobile Notifications** check box to allow ANM to send alarm notifications to supported smart devices that use the ANM Mobile app. This notification option is available when you choose threshold settings in [Step 3](#) for real or virtual servers for device types ACE 4710 VC and ACE VC.

See the [“Setting Up and Viewing Mobile Device Alarm Notifications” section on page 19-13](#) for information about setting up alarm notifications on your mobile device.

**Step 8** Do one of the following:

- Click **Save** to save the threshold group settings.
  - Click **Cancel** to cancel the threshold group settings and return to the Threshold Groups page.
- 

#### Related Topics

- [Configuring SMTP for Email Notifications, page 17-68](#)
- [Displaying Alarm Notifications, page 17-65](#)

# Displaying Alarm Notifications

You can display the alarm notification that ANM issues when the value for a statistic exceeds a specified threshold value. Depending on how you specified to be notified when a threshold is crossed, you can view all alarm notifications, email notifications, or alarm traps.

## Guidelines and Restrictions

Threshold crossing is detected using periodic polling. If a threshold is crossed *between* polling cycles, it is possible that ANM License Manager might not issue an alert if the condition recovers before the next polling cycle.

## Prerequisites

You have configured alarm notifications as described in the “[Configuring Alarm Notifications on ANM](#)” section on page 17-57.

This section includes the following topics:

- [Displaying Alarms in ANM](#), page 17-65.
- [Displaying Email Notifications](#), page 17-66.
- [Displaying Traps](#), page 17-67.

## Displaying Alarms in ANM

You can display the alarms that ANM issues when the value for a statistic exceeds a specified threshold value.

## Guidelines and Restrictions

This topic includes the following guidelines and restrictions:

- ANM displays only the alarms for the devices that are in the domain definition of the RBAC user logged into ANM.
- If an alarm has been cleared, it does not appear on the Monitor > Alarm Notifications > Alarms page. This page displays active alarms only.

## Prerequisites

You have configured alarm notifications as described in the “[Configuring Alarm Notifications on ANM](#)” section on page 17-57.

## Procedure

---

**Step 1** Choose **Monitor > Alarm Notifications > Alarms**.

The Alarms window appears, displaying the list of alarm notifications issued by ANM. [Table 17-23](#) describes the information displayed for each notification.

**Table 17-23 ANM Alarm Notification Content**

| Field            | Description                                                                                                                                                                                  |
|------------------|----------------------------------------------------------------------------------------------------------------------------------------------------------------------------------------------|
| Source ID        | ANM server IP address that issued the alarm                                                                                                                                                  |
| Severity         | Specified severity level of the threshold, which can be one of the following: <ul style="list-style-type: none"> <li>• Info</li> <li>• Critical</li> <li>• Major</li> <li>• Minor</li> </ul> |
| Origination Time | Time the alarm was issued                                                                                                                                                                    |
| Threshold Group  | Specified threshold group name                                                                                                                                                               |
| Category         | Alarm name                                                                                                                                                                                   |
| Component        | Component name, for example, VLAN20                                                                                                                                                          |
| State/Value      | Specified state or value of the alarm                                                                                                                                                        |
| Detail           | Displays additional information about the alarm.                                                                                                                                             |
| Notes            | Allows you to add any notes to this alarm.                                                                                                                                                   |

**Step 2** (Optional) To view a statistical graph of a component with an issue, choose an alarm notification and click **Graph The Component With Issue**.

The Graph popup window appears, showing an analysis of the default statistical units being measured (y-axis) to date and time (x-axis). The component type determines the default statistical units being measured. For example, the units being measured for the real server component type is the number of connections.



**Note** This button can only be used with alarm notifications for the following component types: real server, virtual server, or interface.

#### Related Topics

- [Configuring SMTP for Email Notifications, page 17-68](#)
- [Configuring Alarm Notifications on ANM, page 17-57](#)
- [Displaying Email Notifications, page 17-66](#)

## Displaying Email Notifications

After you configure alarm notifications (see the “[Configuring Alarm Notifications on ANM](#)” section on [page 17-57](#)) and specify to receive notification email, when the value for a specific statistic rises above the setting you specify, ANM sends an email to alert you.

[Table 17-24](#) describes the information contained in the email alarm notification.

**Table 17-24** Email Alarm Notification Content

| Field                  | Description                                                                                                                                                                                  |
|------------------------|----------------------------------------------------------------------------------------------------------------------------------------------------------------------------------------------|
| ANM Server Host Name   | ANM server host name                                                                                                                                                                         |
| ANM Server IP Address  | ANM server IP address                                                                                                                                                                        |
| Device ID              | Device name                                                                                                                                                                                  |
| Component Name         | Component name, for example, VLAN20                                                                                                                                                          |
| Severity               | Specified severity level of the threshold, which can be one of the following: <ul style="list-style-type: none"> <li>• Info</li> <li>• Critical</li> <li>• Major</li> <li>• Minor</li> </ul> |
| Time                   | Time the alarm was issued                                                                                                                                                                    |
| Alarm Name             | Specified name of the alarm                                                                                                                                                                  |
| Alarm Value            | Specified value of the alarm                                                                                                                                                                 |
| Threshold Assert Value | Specified value on when to issue the alarm                                                                                                                                                   |
| Threshold Group Name   | Specified threshold group name                                                                                                                                                               |
| Alarm State            | State of the alarm which can be one of the following: <ul style="list-style-type: none"> <li>• Active</li> <li>• Clear</li> </ul>                                                            |

**Related Topics**

- [Configuring Alarm Notifications on ANM, page 17-57](#)
- [Displaying Alarm Notifications, page 17-65](#)

## Displaying Traps

After you configure alarm notifications (see the “[Configuring Alarm Notifications on ANM](#)” section on [page 17-57](#)) and specify to send traps to a trap receiver, when the value for a specific statistic rises above the setting you specify, ANM issues a trap to alert you.

**Related Topics**

- [Configuring Alarm Notifications on ANM, page 17-57](#)
- [Displaying Alarm Notifications, page 17-65](#)

# Configuring SMTP for Email Notifications

You can specify that email notifications be sent each time a monitoring threshold is crossed. You can request alert emails when configuring a threshold group (Monitor > Alarm Notifications > Threshold Groups) or when enabling the historical data export feature (Monitor > Settings > Historical Data Export).

**Note**

---

You must configure ANM with your SMTP server information to receive email notifications.

---

**Assumption**

You have configured threshold crossing alerts (see the [“Configuring Alarm Notifications on ANM” section on page 17-57](#)) or enabled the historical data export feature (see the [“Exporting Historical Data” section on page 17-52](#)).

**Procedure**

- 
- Step 1** Choose **Monitor > Settings > SMTP Configuration**.
- Step 2** In the SMTP Server to Send E-mail Notifications field, enter your SMTP server.
- Step 3** (Optional) In the MAIL FROM for all Email notifications field, enter the source email address to use for email notifications.
- By default, the Mail From address is `anm@hostname`.
- Step 4** Click **Deploy Now** to apply the SMTP configuration.
- 

**Related Topics**

- [Exporting Historical Data, page 17-52](#)
- [Monitoring Events, page 17-55](#)
- [Configuring Alarm Notifications on ANM, page 17-57](#)
- [Displaying Email Notifications, page 17-66](#)

# Displaying Network Topology Maps

This section shows how to display and use the network topology maps that display the nodes on your network based on the virtual or real server that you select. [Figure 17-13](#) shows a sample network topology map.

**Note**

---

The ANM software version that displays across the top of the window varies depending on your version of ANM.

---



Figure 17-13 Sample ANM Topology Map

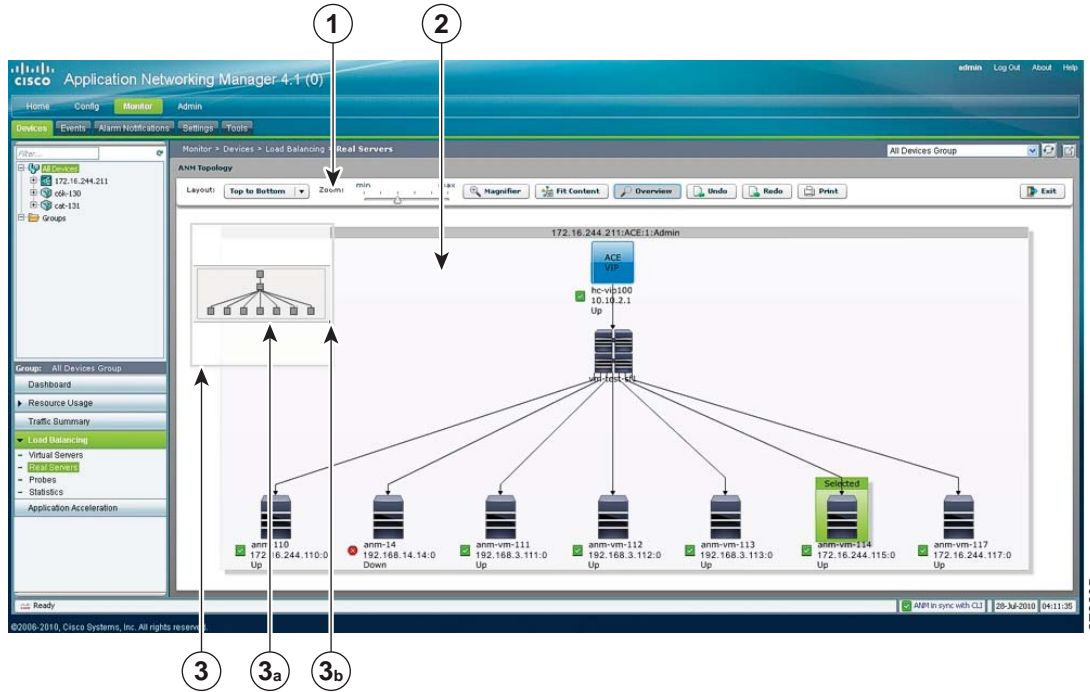

Table 17-25 describes the callouts shown in Figure 17-13.

Table 17-25 Network Topology Map Components

| Item | Description                                                                                                                                                                                                                                                                                                                                                                                                                                                                                                                                                                                                                                                                                                                                                                                                                                                                                                                                                                                                                                                                                                                 |
|------|-----------------------------------------------------------------------------------------------------------------------------------------------------------------------------------------------------------------------------------------------------------------------------------------------------------------------------------------------------------------------------------------------------------------------------------------------------------------------------------------------------------------------------------------------------------------------------------------------------------------------------------------------------------------------------------------------------------------------------------------------------------------------------------------------------------------------------------------------------------------------------------------------------------------------------------------------------------------------------------------------------------------------------------------------------------------------------------------------------------------------------|
| 1    | <p>Topology map tool bar that contains the following tools:</p> <ul style="list-style-type: none"> <li>• <b>Layout</b>—Changes the direction in which the network map appears. Choose one of the following options from the drop-down list: Top to Bottom or Left to Right.</li> <li>• <b>Zoom</b>—Modifies the size of the network map. Click and drag the slide bar pointer to adjust the map size.</li> <li>• <b>Magnifier</b>—Toggle button that enables or disables the magnifier tool. When enabled, moving your mouse over the the topology map magnifies the area that the mouse is over.</li> <li>• <b>Fit Content</b>—Fits the topology map to the window.</li> <li>• <b>Overview</b>—Toggle button that enables or disables the Overview Window tool (see Callout 3).</li> <li>• <b>Undo</b>—Sets the network node icons back to their previous positions.</li> <li>• <b>Redo</b>—Redoes the changes that you made before you clicked Undo.</li> <li>• <b>Print</b>—Sends the topology map to the network printer.</li> <li>• <b>Exit</b>—Closes the topology map and returns to the previous window.</li> </ul> |

**Table 17-25** Network Topology Map Components (continued)

| Item | Description                                                                                                                                                                                                                                                                                                                                                                                                                                                                                                                                                                                                                                                                                                                                                                                                                                                                                                                                                                                                                                                                                                                                                                                                                                                                                                                                                                                                                                                                                                                                                                                                                                                                                                                                                                                                                                                                                                                                                                                                                                                  |
|------|--------------------------------------------------------------------------------------------------------------------------------------------------------------------------------------------------------------------------------------------------------------------------------------------------------------------------------------------------------------------------------------------------------------------------------------------------------------------------------------------------------------------------------------------------------------------------------------------------------------------------------------------------------------------------------------------------------------------------------------------------------------------------------------------------------------------------------------------------------------------------------------------------------------------------------------------------------------------------------------------------------------------------------------------------------------------------------------------------------------------------------------------------------------------------------------------------------------------------------------------------------------------------------------------------------------------------------------------------------------------------------------------------------------------------------------------------------------------------------------------------------------------------------------------------------------------------------------------------------------------------------------------------------------------------------------------------------------------------------------------------------------------------------------------------------------------------------------------------------------------------------------------------------------------------------------------------------------------------------------------------------------------------------------------------------------|
| 2    | <p>Topology Map—Displays network node mapping.</p> <p>The node icons display the following information related to the node:</p> <ul style="list-style-type: none"> <li>• Name</li> <li>• IP address (virtual and real servers only)</li> <li>• Port (real servers only)</li> <li>• Operational state (virtual and real servers only)</li> </ul> <p>When you hover over a network node icon, the node type appears, for example ACE Virtual Server, Server Farm, or Real Server. Other possible operations when you hover over a network node icon are as follows:</p> <ul style="list-style-type: none"> <li>• Real servers only—When you have an ACE configured for Dynamic Workload Scaling and you mouseover an associated real server icon, information appears that identifies which data center the real server is located in: local or remote. A timestamp also appears that specifies when the information was obtained.</li> <li>• Server farms only—When you mouseover a server farm icon, the following Dynamic Workload Scaling status information appears: <ul style="list-style-type: none"> <li>– Local—The ACE is using the server farm’s local real servers only for load balancing. A timestamp specifies when the information was obtained.</li> <li>– Burst—The ACE is bursting traffic to the server farm’s remote real servers because the load of the local real servers has exceeded the specified usage threshold (based on the average CPU and/or memory usage). A timestamp specifies when the information was obtained.</li> <li>– N/A—Not applicable (Dynamic Workload Scaling is not available).</li> </ul> </li> </ul> <p>For more information about Dynamic Workload Scaling, see the <a href="#">“Dynamic Workload Scaling Overview” section on page 8-4</a>.</p> <p>To view details about a network node, right-click on the node and choose <b>Show Details</b> from the popup menu. To reposition a node in the map, click and drag the node icon to a new position. The node interconnect lines move with the node.</p> |
| 3    | <p>Overview Window—Provides a combined functionality of the scroll bars and zoom tool as follows:</p> <ul style="list-style-type: none"> <li>• Position tool (a)—Click and drag the shaded box to move around the topology map.</li> <li>• Zoom tool (b)—Click and drag the shaded box handle (located in lower right corner) and to zoom in or out of the topology map.</li> </ul> <p>Click the Overview toggle button in the map tool bar to display or hide the Overview window.</p>                                                                                                                                                                                                                                                                                                                                                                                                                                                                                                                                                                                                                                                                                                                                                                                                                                                                                                                                                                                                                                                                                                                                                                                                                                                                                                                                                                                                                                                                                                                                                                      |

[Table 17-26](#) shows the locations in the ANM GUI where you can access the topology maps for real servers and virtual servers.

**Table 17-26** ANM Topology Map GUI Locations

| GUI location                                        | For more information, see . . .                                  |
|-----------------------------------------------------|------------------------------------------------------------------|
| Config > Operations > Real Servers                  | <a href="#">Using the Real Server Topology Map, page 8-23</a>    |
| Config > Operations > Virtual Servers               | <a href="#">Using the Virtual Server Topology Map, page 7-85</a> |
| Monitor > Devices > Loadbalancing > Real Servers    | This section.                                                    |
| Monitor > Devices > Loadbalancing > Virtual Servers |                                                                  |

### Procedure

- 
- Step 1** Do one of the following:
- Display the list of virtual servers by choosing **Monitor > Devices > context > Loadbalancing > Virtual Servers**.  
The Virtual Servers window appears with the table of configured virtual servers.
  - Display the list of real servers, choose **Monitor > Devices > context > Loadbalancing > Real Servers**.  
The Real Servers window appears with the table of configured virtual servers.
- Step 2** From the servers table, check the check box next to the server whose topology map you want to display.
- Step 3** From the servers window, click **Topology**.  
The ANM Topology window displays the topology map for the selected virtual or real server. For information about using the topology map tools, see [Figure 17-13](#) and [Table 17-25](#).
- Step 4** (Optional) To close the topology map and return to the previous window, from the ANM Topology window, click **Exit**.
- 

## Testing Connectivity

You can verify the connectivity (using the **ping** command) between ANM and the IP address you specify.



### Note

The Ping feature is disabled if you have not imported any devices into the ANM server.

### Procedure

- 
- Step 1** Choose **Monitor > Tools > Ping**.
- Step 2** From the object selector field, choose the device you want to test.
- Step 3** Enter the information shown in [Table 17-27](#).

**Table 17-27 Ping Fields**

| Field           | Description                                                                                                                                                                                                 |
|-----------------|-------------------------------------------------------------------------------------------------------------------------------------------------------------------------------------------------------------|
| IP Address Type | Choose either <b>IPv4</b> or <b>IPv6</b> for the address type of the real server. This field appears only for ACE module and ACE appliance software version A5(1.0) or later, which supports IPv4 and IPv6. |
| IP Address      | IP address of the real server to which you want to ping.                                                                                                                                                    |
| Elapsed Time    | Elapsed time before the ping request is declared a failure.                                                                                                                                                 |
| Repeat          | Number of times to repeat the test.                                                                                                                                                                         |
| Datagram Size   | Value for the argument size (size of the packet) of the ping command.                                                                                                                                       |

- Step 4** Click **Start** to run the connectivity test.

After the test completes, the results are displayed.

**Step 5** Do one of the following:

- Click **New** to enter new parameters and create a new ping test.
  - Click **Restart** to rerun the connectivity test.
- 

**Related Topic**

[Setting Up Devices for Monitoring, page 17-2](#)



# CHAPTER 18

## Administering the Cisco Application Networking Manager

---

**Date:** 3/28/12

This chapter describes how to administer, maintain, and manage the ANM management system. Previous topics described how to manage your network devices on ANM, while this topic describes how to perform procedures on the system itself.



**Note**

---

When naming ACE objects (such as a real server, virtual server, parameter map, class map, health probe, and so on), enter an alphanumeric string of 1 to 64 characters, which can include the following special characters: underscore (\_), hyphen (-), dot (.), and asterisk (\*). Spaces are not allowed.

If you are using ANM with an ACE module or ACE appliance and you configure a named object at the ACE CLI, keep in mind that ANM does not support all of the special characters that the ACE CLI allows you to use when configuring a named object. If you use special characters that ANM does not support, you may not be able to import or manage the ACE using ANM.

---

This chapter includes the following sections:

- [Overview of the Admin Function, page 18-2](#)
- [Controlling Access to Cisco ANM, page 18-3](#)
- [How ANM Handles Role-Based Access Control, page 18-8](#)
- [Configuring User Authentication and Authorization, page 18-9](#)
- [Managing User Accounts, page 18-17](#)
- [Displaying or Terminating Current User Sessions, page 18-24](#)
- [Managing User Roles, page 18-25](#)
- [Managing Domains, page 18-32](#)
- [Using an AAA Server for Remote User Authentication and Authorization, page 18-38](#)
- [Disabling the ANM Login Window Change Password Feature, page 18-50](#)
- [Managing ANM, page 18-51](#)
- [Administering the ANM Mobile Feature, page 18-67](#)
- [Lifeline Management, page 18-72](#)

# Overview of the Admin Function

**Note**

Some of the Admin options might not be visible to some users; the roles assigned to your login determine which options are available.

[Table 18-1](#) describes the options that are displayed when you click **Admin**.

**Table 18-1** Admin Menu Options

| Menu                      | Option        | Description                                                      | Reference                                                                                |
|---------------------------|---------------|------------------------------------------------------------------|------------------------------------------------------------------------------------------|
| Role-Based Access Control | Organizations | Manage organizations, configure remote authentication mechanisms | <a href="#">“Configuring User Authentication and Authorization” section on page 18-9</a> |
|                           | Users         | Manage users                                                     | <a href="#">“Managing User Accounts” section on page 18-17</a>                           |
|                           | Active Users  | Display active users                                             | <a href="#">“Displaying or Terminating Current User Sessions” section on page 18-24</a>  |
|                           | Roles         | Manage user roles                                                | <a href="#">“Managing User Roles” section on page 18-25</a>                              |
|                           | Domains       | Manage domains                                                   | <a href="#">“Managing Domains” section on page 18-32</a>                                 |

Table 18-1 Admin Menu Options (continued)

| Menu                | Option                                                                                        | Description                                                                                                                                                                                                                                                                                                                                                         | Reference                                                                                               |
|---------------------|-----------------------------------------------------------------------------------------------|---------------------------------------------------------------------------------------------------------------------------------------------------------------------------------------------------------------------------------------------------------------------------------------------------------------------------------------------------------------------|---------------------------------------------------------------------------------------------------------|
| ANM Management      | ANM                                                                                           | Checks the status of the ANM server.                                                                                                                                                                                                                                                                                                                                | <a href="#">“Checking the Status of the ANM Server” section on page 18-52</a>                           |
|                     | License Management                                                                            | Views ANM license state, add more licenses, and tracks license information on your ACE                                                                                                                                                                                                                                                                              | <a href="#">“Using ANM License Manager to Manage ANM Server or Demo Licenses” section on page 18-54</a> |
|                     | Statistics                                                                                    | Displays ACE statistics (for example, CPU, disk, and memory usage).                                                                                                                                                                                                                                                                                                 | <a href="#">“Displaying ANM Server Statistics” section on page 18-56</a>                                |
|                     | Statistics Collection                                                                         | Enables ACE server statistics polling.                                                                                                                                                                                                                                                                                                                              | <a href="#">“Configuring ANM Statistics Collection” section on page 18-57</a>                           |
|                     | Audit Log Settings                                                                            | Allows you to specify number of audit logs saved and how many days logs are saved.                                                                                                                                                                                                                                                                                  | <a href="#">“Configuring Audit Log Settings” section on page 18-58</a>                                  |
|                     | ANM Change Audit Log                                                                          | Allows you to display audit logs recording any user input.                                                                                                                                                                                                                                                                                                          | <a href="#">“Displaying Change Audit Logs” section on page 18-61</a>                                    |
|                     | ANM Auto-Sync Settings                                                                        | Allows you to specify ANM server auto sync settings                                                                                                                                                                                                                                                                                                                 | <a href="#">“Configuring Auto Sync Settings” section on page 18-61</a>                                  |
|                     | Advanced Settings                                                                             | Allows you to configure the following Advanced Settings functions: <ul style="list-style-type: none"> <li>• Enable or disable overwrite of the ACE logging device-id while setting up syslog for autosync using Config &gt; Devices &gt; Setup Syslog for Autosync.</li> <li>• Enable or disable write memory on a Config &gt; Operations configuration.</li> </ul> | <a href="#">“Configuring Advanced Settings” section on page 18-62</a>                                   |
| Lifeline Management | Use this tool to report a problem to the Cisco support line and generate a diagnostic package | <a href="#">“Lifeline Management” section on page 18-72</a>                                                                                                                                                                                                                                                                                                         |                                                                                                         |

## Controlling Access to Cisco ANM

Access to ANM is based on usernames and passwords, which can be authenticated to a local database on the ANM system or to a remote RADIUS, Active Directory/Lightweight Directory Access Protocol (AD/LDAPS), or TACACS+ server. For detailed procedures about remote authentication, see the “Configuring Authentication and Accounting Services” chapter of either the *Cisco ACE Module Security Configuration Guide* or *Cisco ACE 4700 Series Appliance Security Configuration Guide* on [www.cisco.com](http://www.cisco.com).



### Note

ANM supports LDAPS through Active Directory (AD) only.

When a user logs into the system, the specific tasks they can perform and areas of the system that they can use are controlled by *organizations*, *roles*, and *domains*. An organization is a virtual group of users, their roles, and domains managed by a specific server that provides authentication to its users. Each organization has its own set of users. See the “[Understanding Organizations](#)” section on page 18-7 for information about organizations.

The role assigned to a user defines the tasks that a user can perform and the items in the hierarchy that they can see. Roles are either pre-defined or set up by the system administrator. See the “[Understanding Roles](#)” section on page 18-6 for more information.

A domain is a collection of managed objects. When a user is given access to a domain, it acts as a filter for a sub-set of objects on the network which are displayed as a virtual context. The types of objects in the system that are domain controlled are as follows:

- Chassis (with VLANs)
- Virtual contexts
- Resource classes
- Real servers
- Virtual servers

Thus, role-based access control ensures that a user or organization can view only the devices or services or perform the actions that are included in the domains to which they have been given access (see [Figure 18-1](#)).

**Figure 18-1 Role-Based Access Control Containment Overview**

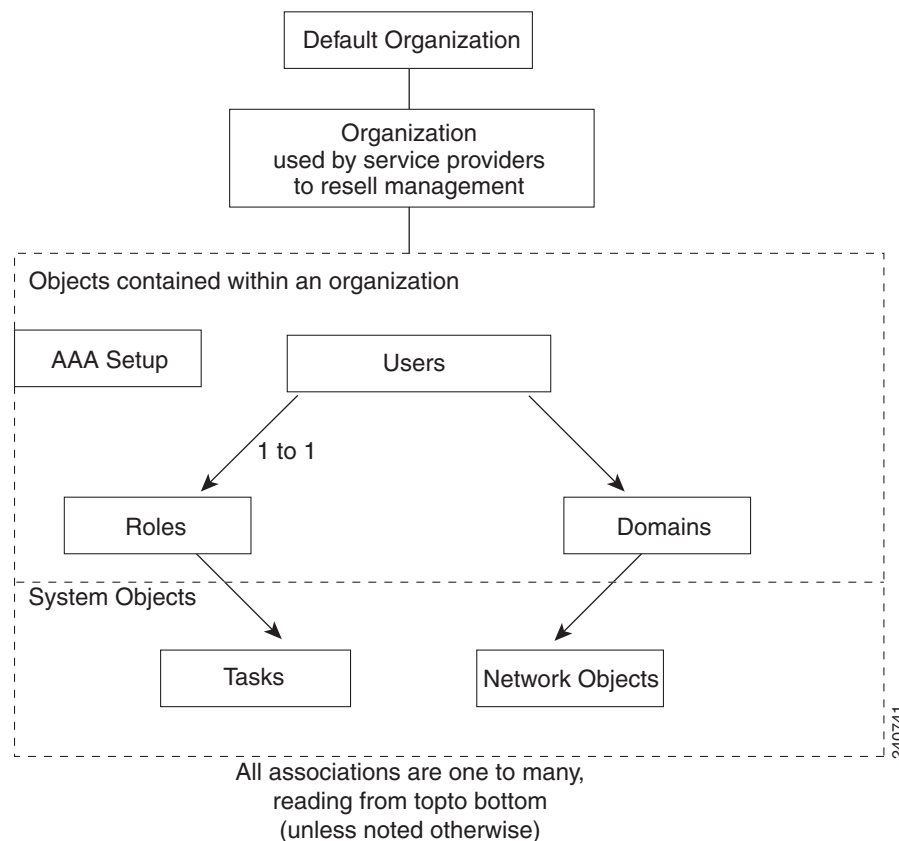



The following is an example of RBAC containment.

|                          |                                                                                                                                               |                    |
|--------------------------|-----------------------------------------------------------------------------------------------------------------------------------------------|--------------------|
| <b>Organization</b>      |                                                                                                                                               |                    |
| Webmasters               |                                                                                                                                               |                    |
| <b>Domains</b>           |                                                                                                                                               |                    |
| East Coast servers       | Central servers                                                                                                                               | West Coast servers |
| <b>Role</b>              |                                                                                                                                               |                    |
| Web server administrator |                                                                                                                                               |                    |
| <b>Users</b>             |                                                                                                                                               |                    |
| User A                   | User B                                                                                                                                        | User C             |
| <b>Note</b>              | Each association is one-to-many. Because the organization itself is a collection, it is possible for a role to be used in many organizations. |                    |

All other user interfaces, such as configuration and monitoring, respect this role-based access control policy:

- Roles limit the screens (or functions on those screens) that a user can see.
- Domains limit the objects that are listed on any window that the roles allow.
- Users (other than the system administrator) can only create subdomains of the domains to which they are assigned.
- The system administrator user can see and modify all objects. All other users are subject to the role-based access controls illustrated in [Figure 18-1](#).

#### Related Topics

- [Types of Users, page 18-5](#)
- [Understanding Roles, page 18-6](#)
- [Understanding Operations Privileges, page 18-6](#)
- [Understanding Domains, page 18-7](#)
- [Understanding Organizations, page 18-7](#)
- [Managing User Accounts, page 18-17](#)

## Types of Users

Two types of users configure and monitor the ANM system:

- Default users—Individuals associated with the data center or IT department where ANM is installed. The default administrative account (user ID is admin) is a system user account that is preconfigured on ANM. The default administrative password (admin) is also preconfigured on ANM. You can change the password for the admin user account in the same manner as any other user password (see the “[Managing User Accounts](#)” section on [page 18-17](#)).

System roles are defined by the system administrator when ANM is first set up. System roles are specified in terms of resource types and operations privileges. For each system role, the system administrator specifies which resource types a role can work with and what operations a role can perform on each resource type.

- Organization users—Users who work for the customer of a service provider or AAA server that segments your users and to whom you want to grant access to ANM. Organization users automatically have their access limited to the organization to which they belong.

#### Related Topics

- [Configuring User Authentication and Authorization, page 18-9](#)
- [Managing User Accounts, page 18-17](#)
- [Using an AAA Server for Remote User Authentication and Authorization, page 18-38](#)

## Understanding Roles

Roles in ANM are defined by the system administrator. Roles are specified in terms of resource types and operations privileges. For each role, the system administrator specifies which resource types a role can work with and what operations a role can perform on each resource type.

When users are created, they are assigned at least one system role and inherit the operations privileges specified for each of the resource types assigned to that role.

The options a user sees in the menu are filtered according to that user's role (see the “[Displaying User Roles and Associated Tasks and ANM Menu Privileges](#)” section on page 18-28).

Roles can be applied to both default and organization users. All users are strictly limited by the combination of their operations privileges and user access. For example, a user cannot create another user who has greater privileges or access.

#### Related Topics

- [Configuring User Authentication and Authorization, page 18-9](#)
- [Managing User Accounts, page 18-17](#)
- [Managing User Roles, page 18-25](#)

## Understanding Operations Privileges

Operations privileges define what users can do in the designated resource types. For example, each command and function on ANM has an assigned privilege. If a user's privileges are not sufficient, the command or function will not be available to them. The following operations privileges can be granted:

- No Access—The user has no access to this command or function.



---

**Note** If a user is configured with no access to virtual contexts, it means absolutely no access to them. The most a user with this access can do is activate or suspend real servers.

---

- View—Allows the user to view statistics and specify parameter collection and threshold settings. Gives the user read-only or view access to system objects and information.
- Modify—Allows the user to change the persistent information associated with system objects, such as an organization record, or configuration.
- Debug—Gives the user read-only or view access to system objects and information.

- **Create**—Allows the user to control system objects, for example, creating them, enabling them, or powering up. Also allows the user to control system objects, for example, deleting them, disabling them, or powering down.



**Note** The Create privilege includes the functions associated with the Modify privilege; however, the reverse is not true (a user with Modify privileges cannot create items).

Privileges are hierarchical. If a user has Modify privileges, they have View privileges as well. If a user has Create or Debug privileges, they have View privileges as well.

#### Related Topics

- [How ANM Handles Role-Based Access Control, page 18-8](#)
- [Managing User Roles, page 18-25](#)
- [Guidelines for Managing User Roles, page 18-25](#)
- [Understanding Predefined Roles, page 18-26](#)
- [Using an AAA Server for Remote User Authentication and Authorization, page 18-38](#)

## Understanding Domains

Domains in ANM are defined by the system administrator. A domain is a collection of managed objects to which a user is given access. By setting up a domain, you are filtering for a subset of objects on the network. The user is then given access to this virtual context.

The table rows that a user sees in any table are filtered according to the domain to which that user has access.

## Understanding Organizations

An organization allows you to configure AAA server lookup for your users or set up users who work for a service provider customer. Organizations in ANM are defined by the system administrator.

When you use an ACE device as a AAA server, you may want to segment them for customer, business, or security reasons. If you use more than one authentication server, then you can use organizations to configure them to authenticate your users.

For example, if your company has four servers, one each for local, RADIUS, TACACS+, and LDAPS authentication, then organizations could reflect that. The Default organization in ANM is set up to act as the local server.

ANM supports different device types that have unique ways of configuring authentication access, which helps with future device support. ANM can configure which users are authenticated by which authentication servers, but does not act as an AAA server itself because this would be in conflict of its role as a RBAC administrator and allows for the separation of authority that is needed to perform RBAC successfully.

#### Related Topics

- [Using an AAA Server for Remote User Authentication and Authorization, page 18-38](#)

# How ANM Handles Role-Based Access Control

This section describes how and why a system administrator might want to use the ANM RBAC features.

ANM supports two distinct, but related RBAC capabilities as follows:

- ANM RBAC—ANM acts as a system and network device overseer allowing it to globally implement its use of RBAC.
- Device RBAC—ANM devices enforce RBAC.

## Understanding ANM RBAC

ANM is a central place where you can globally set the RBAC for users, roles, and domains (as well as for virtual contexts or device types using device RBAC).

As a system administrator, you may need to delegate authority to allow another administrator to perform specific tasks on specific devices, such as activating, suspending, and monitoring traffic flow to specific real servers, yet restrict them from accessing all other capabilities. ANM enables you to accomplish this delegation with more control. For a description of how the roles map to the functions, see [“Displaying User Roles and Associated Tasks and ANM Menu Privileges” section on page 18-28](#).

## Understanding Device RBAC

ANM’s device RBAC allows you to set up device permission levels of a more granular nature. You no longer have to provide “all-or-nothing” roles-based access of devices and device modules. Without ANM, some devices may be open to users who can perform every task on that device or module, regardless of their authorization due to permission level requirements on modules and or switches. ANM provides a central place to grant special access to users you specify. Device users, roles, and domain data are not part of, nor can they be used by ANM. Device RBAC is only for CLI access directly to the context.

For example, some users may need level 3 access when direct troubleshooting of ACE hardware is required. You can set up these users with or without ANM, but ANM centralizes the capability to do so. If you want to configure a network engineer with a special role, for example either ACE-Admin or Network-Admin, to provide the level 3 access. ANM accesses the ACE as a level 15 user and an admin supervisor and uses the RBAC to determine the level of access (to device types, segments, elements, subelements, and so on).

Some Cisco devices have the ability to configure RBAC directly on the device, for example the ACE. The CSS and CSM are examples of Cisco devices that do not have the capability to have its their own RBAC.

When you configure remote authentication (AAA, RADIUS, LDAPS, or TACACs+) for the ACE through ANM, users no longer have to log out to access their device using Telnet. When you manually log into a CSS, the CSS performs user authentication in a Telnet session. Telnet does not provide any domain enforcement, so it is less secure. For an overview of the steps that you perform to configure remote authentication using an AAA server, see the [“Using an AAA Server for Remote User Authentication and Authorization” section on page 18-38](#).

If you are an admin using a CSS module outside of the ANM application, then you might have permission to do anything on this switch. If you are using ANM, you can set up better authorization for your administrators for specific devices. Better authorization controls are one of the advantages of using the ANM rather than using only the CLI on the ACE hardware. You can now configure separate access for one function for this user in this domain only. ANM allows this high level of granularity and with it, more control over who does what to your devices.

**Note**

When configuring device RBAC through Config > Devices, a message displays reminding you that you are configuring RBAC outside of ANM for direct access. Be aware that this may contradict your ANM settings.

For more information on centralizing direct access to devices through RBAC on individual devices, see the [“Configuring ACE Module and Appliance Role-Based Access Controls”](#) section on page 5-53.

**Case Example**

In this example, a CSM device must have a level 15 access which by default makes the admin a supervisor on everything in the switch (and everything in the module). Another way of looking at this is providing read-only access to everything or configuration access to everything.

ACE hardware can be configured on a virtual context to perform that task on a subset domain for every individual module, on every context, but this type of configuration must be configured individually.

A system administrator might need to configure a network admin to manage two CSM modules, one out of six virtual contexts, and all East Coast web servers. With ANM, the admin could create one configuration set that includes a user account with a Network-Admin role and a domain that includes these objects. ANM then becomes the security window through which this user passes to get to their destination for that domain and for that virtual context.

If there were six users, nine domains, and three virtual contexts, there would be 54 entries required into a AAA Server and ACE module. In ANM there is one entry completed for each of the six users.

## Configuring User Authentication and Authorization

In ANM, you can configure authentication for your users by specifying the authentication method to use for specific user; the local method using ANM or a remote method using an AAA servers. You do this through *organizations*. An organization allows you to configure your local or AAA server lookup for your users, then associate specific users, roles, and domains with those organizations.

The following sections describe the organization authentication tasks that you can complete in ANM:

- [Adding a New Organization, page 18-10](#)
- Configuring AAA Server lookup for your users—See [Adding a New Organization, page 18-10](#)
- Changing server passwords—See [Changing Authentication Server Passwords, page 18-14](#)
- [Modifying Organizations, page 18-14](#)
- [Duplicating an Organization, page 18-15](#)
- [Displaying Authentication Server Organizations, page 18-16](#)
- [Deleting Organizations, page 18-16](#)

The Default organization (in which all users belong) authenticates users through the ANM internal mechanism, which is based on the RBAC security model. This mechanism authenticates users through the local authentication module and a local database of user IDs and passwords. If you choose to use a remote authentication method, you must specify the authentication server and port.

Many organizations, however, already have an authentication service. To use your own authentication service instead of the local module, you can choose one of the alternate modules:

- TACACS+
- RADIUS

- AD/LDAPS

**Note**

For detailed procedures about remote authentication, see the “Configuring Authentication and Accounting Services” chapter of either the *Cisco ACE Module Security Configuration Guide* or *Cisco ACE 4700 Series Appliance Security Configuration Guide* on [www.cisco.com](http://www.cisco.com).

After you configure an organization, all authentication transactions are performed by the authentication service associated with that organization. Users log in with the user ID and password associated with the current authentication module.

**Related Topics**

- [Managing User Accounts, page 18-17](#)
- [Managing User Roles, page 18-25](#)
- [Managing Domains, page 18-32](#)
- [Using an AAA Server for Remote User Authentication and Authorization, page 18-38](#)

## Adding a New Organization

You can add organizations, which define the mechanism for authenticating ANM users: local using ANM or remote using RADIUS, TACACS+, or AD/LDAPS. When you configure an organization for remote authentication, users within that organization have their passwords validated using the specified remote AAA server.

You can also configure an organization to use a TACACS+ server for remote authorization of ANM users. To use remote authorization, you must also configure the TACACS+ server with the role and domains associated with a user or user group (see the “[Configuring Remote User Authorization Using a TACACS+ Server](#)” section on page 18-45).

When you use the services of a remote AAA server, you can configure the organization to fall back to using local authentication and authorization when the remote AAA server becomes unavailable.

**Procedure**

- 
- Step 1** Choose **Admin > Role-Based Access Control > All Organizations**.
- Step 2** Click **Add**.
- Step 3** Enter the name of the new organization and notes if required, and click **Save**.
- Step 4** Enter the attributes described in [Table 18-2](#).
- Certain attributes will display when specific options are selected.

**Table 18-2**      **Organization Attributes**

| Attribute               | Description                                                                                                                                                                                                                                                                                                                                                                                                                                                                                                                                                                                                                                                                                                                                                                                                                                                                                                                                   |
|-------------------------|-----------------------------------------------------------------------------------------------------------------------------------------------------------------------------------------------------------------------------------------------------------------------------------------------------------------------------------------------------------------------------------------------------------------------------------------------------------------------------------------------------------------------------------------------------------------------------------------------------------------------------------------------------------------------------------------------------------------------------------------------------------------------------------------------------------------------------------------------------------------------------------------------------------------------------------------------|
| Notes                   | Description of the organization or notes to administrator.                                                                                                                                                                                                                                                                                                                                                                                                                                                                                                                                                                                                                                                                                                                                                                                                                                                                                    |
| Organization Name       | Company, department, or division of the organization that administers the ANM server. This can be different from the organization name above. Default name entered appears.                                                                                                                                                                                                                                                                                                                                                                                                                                                                                                                                                                                                                                                                                                                                                                   |
| Account Number          | Account number for the organization.                                                                                                                                                                                                                                                                                                                                                                                                                                                                                                                                                                                                                                                                                                                                                                                                                                                                                                          |
| Contact Name            | Name of the individual who is the contact in the organization.                                                                                                                                                                                                                                                                                                                                                                                                                                                                                                                                                                                                                                                                                                                                                                                                                                                                                |
| Email                   | Address for the organization's contact person.                                                                                                                                                                                                                                                                                                                                                                                                                                                                                                                                                                                                                                                                                                                                                                                                                                                                                                |
| Telephone #             | Telephone number for the organization's contact person. The format is free text with no embedded spaces.                                                                                                                                                                                                                                                                                                                                                                                                                                                                                                                                                                                                                                                                                                                                                                                                                                      |
| Alternative Telephone # | Alternative telephone number for the organization's contact person.                                                                                                                                                                                                                                                                                                                                                                                                                                                                                                                                                                                                                                                                                                                                                                                                                                                                           |
| Street Address          | Street for the organization.                                                                                                                                                                                                                                                                                                                                                                                                                                                                                                                                                                                                                                                                                                                                                                                                                                                                                                                  |
| City                    | City where the organization is located.                                                                                                                                                                                                                                                                                                                                                                                                                                                                                                                                                                                                                                                                                                                                                                                                                                                                                                       |
| Zip Code                | Zip code for the organization's address.                                                                                                                                                                                                                                                                                                                                                                                                                                                                                                                                                                                                                                                                                                                                                                                                                                                                                                      |
| Country                 | Country where the organization is located.                                                                                                                                                                                                                                                                                                                                                                                                                                                                                                                                                                                                                                                                                                                                                                                                                                                                                                    |
| Authentication          | <p>Mechanism that the system uses to authenticate users. The default authentication mechanism is ANM's internal mechanism (local), which is based on ANM's security model. For remote authentication, you must specify the authentication server and port number.</p> <p>Options are as follows:</p> <ul style="list-style-type: none"> <li>• Local—Specifies the use of the local database.</li> <li>• RADIUS</li> <li>• TACACS+</li> <li>• AD/LDAPS (ANM requires that a Domain Controller Server certificate be installed on the Active Directory Server. For a document containing the detailed instructions, see the “Configuring an LDAP Server” section in the “Configuring Authentication and Accounting Services” chapter of either the <i>Cisco ACE Module Security Configuration Guide</i> or <i>Cisco ACE 4700 Series Appliance Security Configuration Guide</i> on <a href="http://www.cisco.com">www.cisco.com</a>.)</li> </ul> |

**Note:** The attributes listed below appear only when the Authentication attribute is set to AD/LDAPS, RADIUS, or TACACS+. For detailed instructions about configuring these attributes, see the “Configuring Authentication and Accounting Services” chapter of either the *Cisco ACE Module Security Configuration Guide* or *Cisco ACE 4700 Series Appliance Security Configuration Guide* on [www.cisco.com](http://www.cisco.com).

Table 18-2 Organization Attributes (continued)



| Attribute                       | Description                                                                                                                                                                                                                                                                                                                                                                                                                                                                                                                                                                                                                                                                                                                                                                                                                                                                                                                                  |
|---------------------------------|----------------------------------------------------------------------------------------------------------------------------------------------------------------------------------------------------------------------------------------------------------------------------------------------------------------------------------------------------------------------------------------------------------------------------------------------------------------------------------------------------------------------------------------------------------------------------------------------------------------------------------------------------------------------------------------------------------------------------------------------------------------------------------------------------------------------------------------------------------------------------------------------------------------------------------------------|
| Authentication Server           | <p>Hostname or IP address of a RADIUS, TACACS+, or LDAPS server for remote user authentication.</p> <p><b>Note</b> Setting the server with this command is mandatory if you set the Authentication attribute to anything other than the default (local).</p> <p>If you select a remote authentication method, you might need to specify a separate user ID for the authentication server.</p> <p>For AD/LDAPS, you must provide the FQDN of the server (which must be in the users authenticating domain).</p> <hr/> <p> <b>Note</b> ANM supports LDAPS only through Active Directory (AD).</p>                                                                                                                                                                                                                                                             |
| Authentication Port             | <p>(Optional) Destination port for communicating authentication requests to the authentication server as follows:</p> <ul style="list-style-type: none"> <li>• RADIUS—By default, the RADIUS authentication port is 1812 (as defined in RFC 2138 and RFC 2139). If your RADIUS server uses a port other than 1812, configure ANM for the appropriate port. Valid values are from 1 to 65535.</li> <li>• TACACS+—By default, the TACACS+ authentication port is 49 (as defined in RFC 1492). If your TACACS+ server uses a port other than 49, configure ANM for the appropriate port. Valid values are from 1 to 65535.</li> <li>• LDAPS—By default, the LDAP server port is 636. If your LDAP server uses a port other than 636, configure ANM for the appropriate port. Valid values are from 1 to 65535.</li> </ul>                                                                                                                       |
| Secondary Authentication Server | (Optional) Hostname or IP address for the secondary RADIUS, TACACS+, or LDAPS server used for authentication in case the primary server is unavailable.                                                                                                                                                                                                                                                                                                                                                                                                                                                                                                                                                                                                                                                                                                                                                                                      |
| Secondary Authentication Port   | (Optional) Destination port on the secondary RADIUS, TACACS+, or LDAPS server for communicating authentication requests if the primary server is unavailable.                                                                                                                                                                                                                                                                                                                                                                                                                                                                                                                                                                                                                                                                                                                                                                                |
| Authentication Secret           | String used to encrypt the traffic between Cisco ANM and the AAA server. This string must be identical on both servers.                                                                                                                                                                                                                                                                                                                                                                                                                                                                                                                                                                                                                                                                                                                                                                                                                      |
| Remote Authorization            | <p>(Optional) Field that appears only when the Authentication attribute is set to TACACS+.</p> <p>Determines whether ANM or the TACACS+ server performs user authorization. Uncheck the check box to have ANM perform user authorization locally (this is the default setting). Check the check box to enable remote authorization by the TACACS+ server.</p> <p>If you enable remote authorization, you must configure the TACACS+ server with the role and domain information associated with each user (see the <a href="#">“Configuring Remote User Authorization Using a TACACS+ Server”</a> section on page 18-45).</p> <hr/> <p> <b>Note</b> All role and domain definitions are stored locally on ANM (see the <a href="#">“Managing User Roles”</a> section on page 18-25 and the <a href="#">“Managing Domains”</a> section on page 18-32).</p> |



Table 18-2 Organization Attributes (continued)

| Attribute         | Description                                                                                                                                                                                                                                                                                                                                                                                                                                                                                                                                                                                                                                                                                                                                                                                                                                                                                                                                                                                                                                                                                                                                                                                                                                                                                                                                                                                                                                                                                                                                                                                                       |
|-------------------|-------------------------------------------------------------------------------------------------------------------------------------------------------------------------------------------------------------------------------------------------------------------------------------------------------------------------------------------------------------------------------------------------------------------------------------------------------------------------------------------------------------------------------------------------------------------------------------------------------------------------------------------------------------------------------------------------------------------------------------------------------------------------------------------------------------------------------------------------------------------------------------------------------------------------------------------------------------------------------------------------------------------------------------------------------------------------------------------------------------------------------------------------------------------------------------------------------------------------------------------------------------------------------------------------------------------------------------------------------------------------------------------------------------------------------------------------------------------------------------------------------------------------------------------------------------------------------------------------------------------|
| ANM Unique IDs    | <p>Field that appears only when the Remote Authorization check box is checked for a TACACS+ server. Enter the value that matches the ANM identifier that you configure on the TACACS+ server (see the <a href="#">“Configuring Remote User Authorization Using a TACACS+ Server”</a> section on page 18-45). The default value is ANM.</p> <p>Depending on how you configure the TACACS+ server for user authorization, you may need to specify multiple, comma-separated ANM IDs in the ANM Unique IDs field as follows:</p> <pre>anm_1 , anm2 , anm3</pre> <p>For example, when configuring ANM user authorization on the TACACS+ server, you can use a maximum of 160 characters to specify an ANM unique ID and associated user role and user domain information. To work around this limitation, on the TACACS+ server you can specify additional domain information for the role by entering multiple ANM identifiers.</p> <p>When multiple ANM organizations share the same TACACS+ server, specify a different ANM identifier for each organization.</p> <p>When multiple ANMs share the same TACACS+ server, specify a different ANM identifier for each ANM.</p>                                                                                                                                                                                                                                                                                                                                                                                                                                        |
| Fallback to Local | <p>Enables ANM to use local authentication (and local user authorization for TACACS+ applications) if the remote primary and secondary AAA servers are not available, such as when there is a timeout issue, connectivity issue, wrong IP address, and so forth.</p> <p> <b>Note</b> To use the fallback option, you must configure a local user on ANM that ANM can use when fallback is invoked.</p> <p>When you enable Fallback to Local for RADIUS and AD/LDAP, ANM falls back to local user authentication only when the AAA server is unreachable. If the AAA server is reachable but remote authentication fails, ANM does not fall back to local and the login is rejected.</p> <p>When you enable Fallback to Local for TACACS+, ANM falls back to local user authentication and authorization only when the AAA server is unreachable. If the remote server is reachable but remote authentication fails, ANM does not fall back to local and the login is rejected. If Remote Authorization is not enabled, after remote authentication is complete, ANM performs user authorization by checking the local user for role and domain information. If Remote Authorization is enabled and no valid role or domain information is found on the TACACS+ server, including the ANM IP attributes not being set on the TACACS+ server, ANM does not fall back to the local user and rejects the login (see the <a href="#">“Configuring Remote User Authorization Using a TACACS+ Server”</a> section on page 18-45).</p> |

**Step 5** Click **Save**.

#### Related Topics

- [Managing User Accounts, page 18-17](#)

- [Changing the Admin Password, page 18-14](#)

## Changing Authentication Server Passwords



**Note** Your user role determines whether you can use this option.

You can change the authentication server password.

### Procedure

- 
- Step 1** Choose **Admin > Role-Based Access Control > Organization**.
- Step 2** Choose the organization that you want to modify and click **Edit**.
- Step 3** Change the password attribute in the attributes table (see [Table 18-5](#)).
- Step 4** Click **Save**.
- The Edit User Details window appears.
- Step 5** Make any changes and click **Save**.
- Step 6** When all the details are correct, click **Cancel**.
- The User Management table is displayed.
- 

### Related Topics

- [Managing User Accounts, page 18-17](#)
- [Changing the Admin Password, page 18-14](#)

## Changing the Admin Password

Each ANM has an admin user account built into the device. The root user ID is admin, and the password is set when the system is installed. For information about changing the Admin password, see the [“Changing Your Account Password”](#) section on page 1-6.



**Note** For details about resetting the Admin password, see the *Installation Guide for Cisco Application Networking Manager 3.0*.

## Modifying Organizations



**Note** Your user role determines whether you can use this option.

You can modify an existing organization.

**Assumptions**

This topic assumes the following:

- ANM is installed and running.
- The organization exists in the ANM database.
- You have reviewed the guidelines for managing customer organizations (see the [“Adding a New Organization” section on page 18-10](#)).

**Procedure**

- 
- Step 1** Choose **Admin > Role-Based Access Control > Organizations**.
- Step 2** Choose the organization that you want to modify and click **Edit**.  
The Edit Organization window appears.
- Step 3** In the attributes table of the Edit Organization window, modify any of the attributes in the attributes table (see [Table 18-2](#)).
- Step 4** Click **Save**.
- 

**Related Topics**

- [Configuring User Authentication and Authorization, page 18-9](#)

## Duplicating an Organization

**Note**

---

Your user role determines whether you can use this option.

---

You can create a new organization from an existing one.

**Assumptions**

This topics assumes the following:

- ANM is installed and running.
- The organization exists in the ANM database.
- You have reviewed the guidelines for managing customer organizations (see the [“Adding a New Organization” section on page 18-10](#)).

**Procedure**

- 
- Step 1** Choose **Admin > Role-Based Access Control > Organizations**.  
The Organizations window appears.
- Step 2** In the Organizations window, choose the organization that you want to copy.
- Step 3** Click **Duplicate**.  
A script popup window appears.
- Step 4** At the prompt in the popup window, enter a name for the new organization.

- Step 5** Click **OK**.  
The popup window closes and the new organization copy is added to the Organization window.
- Step 6** (Optional) Choose the new organization and click **Edit** to make changes to the organization settings.  
The Edit Organization window appears.
- Step 7** In the attributes table of the Edit Organization window, modify any of the attributes in the attributes table (see [Table 18-2](#)).
- Step 8** Click **Save**.
- 

**Related Topics**

- [Configuring User Authentication and Authorization, page 18-9](#)

## Displaying Authentication Server Organizations

**Note**

Your user role determines whether you can use this option.

---

To display the authentication server organizations, choose **Admin > Role-Based Access Control > All Organizations**. The Organizations window appears with a list of customer organizations. From this window you can create a users, roles, and domains that are associated with this specific organization. You can also access organizations by selecting the organization from the object selector that displays in the top right portion of the content area.

**Related Topics**

- [Understanding Organizations, page 18-7](#)
- [Configuring User Authentication and Authorization, page 18-9](#)

## Deleting Organizations

**Note**

Your user role determines whether you can use this option.

---

You can delete an organization.

**Assumptions**

This topic assumes the following:

- ANM is installed and running.
- The organization exists in the ANM database.
- You have reviewed the guidelines for managing customer organizations (see [Adding a New Organization, page 18-10](#)).

### Procedure

- 
- Step 1** Choose **Admin > Role-Based Access Control > Organizations**.  
The Organizations window appears.
- Step 2** In the Organizations window, choose the organization to delete.
- Step 3** Click **Delete**.  
All users, domains, and roles within that organization are removed.
- 

### Related Topics

[Configuring User Authentication and Authorization, page 18-9](#)

## Managing User Accounts

You use the User Management feature to specify the people that are allowed to log onto the system.



### Note

---

You can create users in the organization in which you are a member. You will see users only in the organizations in which you are a member.

---

This section includes the following topics:

- [Guidelines for Managing User Accounts, page 18-17](#)
- [Displaying a List of Users, page 18-18](#)
- [Creating User Accounts, page 18-19](#)
- [Duplicating a User Account, page 18-20](#)
- [Modifying User Accounts, page 18-21](#)
- [Resetting Another User's Password, page 18-22](#)
- [Deleting User Accounts, page 18-23](#)

## Guidelines for Managing User Accounts

This topic includes the following guidelines:

- A user cannot log in until they have one domain and one user role associated through an organization. This can be the Default domain but a role must be specified.
- Users cannot be moved from one organization to another. Organizations are designed to be separate and distinct.
- Only users with create permissions can reset other user's password. See the [“Resetting Another User's Password”](#) section on page 18-22.

## Displaying a List of Users

You can display a list of ANM users, which includes ANM Mobile users if you have ANM configured to use this feature (for more information, see [Chapter 19, “Using ANM Mobile”](#)).

### Guidelines and Restrictions

The list of ANM users does not include users that are remotely authenticated and authorized using a AAA server unless ANM is configured as a backup for user authentication and authorization.

### Procedure

- Step 1** Choose **Admin > Role-Based Access Control > Organization > Active Users**.  
The Users table appears. [Table 18-3](#) describes the default user information that displays.

**Table 18-3** Users Table Default Fields

| Field      | Description                        |
|------------|------------------------------------|
| Login Name | Full name of the user.             |
| Role       | Role assigned to the user.         |
| Domains    | Domains to which the user belongs. |

- Step 2** (Optional: Mobile ANM users only) To display the list of mobile devices used by a user, choose a user from the list and click **Mobile Notifications**.  
The Mobile Devices popup window appears, displaying device-specific information (see [Table 18-18](#)).
- Step 3** (Optional: Mobile ANM users only) To display the list of favorite objects associated with a user, choose the user from the list and click **Favorites**.  
The User Favorites popup window appears. [Table 18-4](#) describes the information displayed.

**Table 18-4** Mobile Device User's Favorites

| Field       | Description                                                                 |
|-------------|-----------------------------------------------------------------------------|
| Object Type | ACE object type accessed by the user, such a real server or virtual server. |
| Device Name | ACE device (virtual context) name accessed by the user.                     |
| Object Name | Name assigned to the object.                                                |

- Step 4** (Optional) To specify the user information that displays in the Users table, hover over the **Customize** button (  ) to display and choose one of the following options:
- Default**—Displays only the fields described in [Table 18-3](#).
  - Configure**—Opens the Users List Configuration popup window that allows you to specify the user information that displays (see the [“Customizing Tables”](#) section on page 1-15).



**Note** The list of user fields that you can choose from includes the Available Objects option, which lists the domain objects available to the user. Because the list of available domain objects for a user can be too extensive to display in the User table, the Excel spreadsheet is the only output format that displays this information (see [Step 5](#)).

- Step 5** (Optional) To output the user information as raw data or in an Excel spreadsheet, hover over the **Save** button (  ) to display and choose one of the following output options:
- **Raw data**—Displays the user information as raw data in a new window.
  - **Excel spreadsheet**—Displays user information in an Excel spreadsheet in a new window.

#### Related Topics

- [Creating User Accounts, page 18-19](#)
- [Duplicating a User Account, page 18-20](#)
- [Modifying User Accounts, page 18-21](#)
- [Resetting Another User's Password, page 18-22](#)
- [Deleting User Accounts, page 18-23](#)
- [Displaying Mobile Device Notifications and Testing the Notification Channel, page 18-70](#)
- [Chapter 19, "Using ANM Mobile"](#)

## Creating User Accounts



#### Note

Your user role determines whether or not you can use this option.

You can create new user accounts for an organization.

#### Procedure

- Step 1** Choose **Admin > Role-Based Access Control > Organization > Users**.  
The Users table appears.
- Step 2** Click **Add**.  
The New Organization User window appears.
- Step 3** In the New Organization User window, configure the user attributes as described in [Table 18-5](#):



#### Note

If your web browser supports the Remember Passwords option and you enable this option, the web browser may fill in the Name and Password fields when the New Organization User window loads. By default, these fields should be empty. You can change the name and password fields from whatever the web browser inserts into the two fields.

**Table 18-5** *User Attributes*

| Field      | Description                                                                                                                                                                        |
|------------|------------------------------------------------------------------------------------------------------------------------------------------------------------------------------------|
| Login Name | Name by which the user is to be identified in the system (up to 24 characters). Only letters, numbers, underscore (_), and backslash (\) can be used. The field is case sensitive. |
| Name       | Full name of the user. The format is free text.                                                                                                                                    |
| Password   | Password for the user account.                                                                                                                                                     |

Table 18-5 User Attributes (continued)

| Field            | Description                                                                                                                                                                                                                                                                                                                                                                                                                                                                                                                                                                                                                                                                                           |
|------------------|-------------------------------------------------------------------------------------------------------------------------------------------------------------------------------------------------------------------------------------------------------------------------------------------------------------------------------------------------------------------------------------------------------------------------------------------------------------------------------------------------------------------------------------------------------------------------------------------------------------------------------------------------------------------------------------------------------|
| Confirm          | Password confirmation for the account.                                                                                                                                                                                                                                                                                                                                                                                                                                                                                                                                                                                                                                                                |
| Email            | Email address for the user.                                                                                                                                                                                                                                                                                                                                                                                                                                                                                                                                                                                                                                                                           |
| Telephone#       | Telephone number for the user. The format is free text with no embedded spaces.                                                                                                                                                                                                                                                                                                                                                                                                                                                                                                                                                                                                                       |
| Role             | Predefined role from the drop-down list.                                                                                                                                                                                                                                                                                                                                                                                                                                                                                                                                                                                                                                                              |
| Domains          | Domains to which this user belongs. Use the <b>Add</b> and <b>Remove</b> buttons to choose the domains to which this user belongs.                                                                                                                                                                                                                                                                                                                                                                                                                                                                                                                                                                    |
| Allowed Login IP | IP address or a subnetwork from which the user is allowed to log in. You can define up to ten different addresses for a single user. Unless you specifically define IP addresses or subnetworks using this option, the user can log in from any IP address. When you enter an allowed single IP address or an allowed subnet, then the user is only allowed to log in from the specified addresses. To restrict access to a specific subnetwork, enter the IP address and the mask, for example, 10.1.200.60/255.255.255.0.<br><br><br><b>Note</b> IP addresses 1.1.1.1 and 0.0.0.0 cannot be entered in this field. |
| Description      | Notes about the user.                                                                                                                                                                                                                                                                                                                                                                                                                                                                                                                                                                                                                                                                                 |
| First menu       | Menu that displays when this user first logs in. Choose one from the drop-down list.                                                                                                                                                                                                                                                                                                                                                                                                                                                                                                                                                                                                                  |
| Last Login       | Last time (local time) this user logged in.                                                                                                                                                                                                                                                                                                                                                                                                                                                                                                                                                                                                                                                           |

**Step 4** Click **Save** to save the user account information.

#### Related Topics

- [Displaying a List of Users, page 18-18](#)
- [Duplicating a User Account, page 18-20](#)
- [Modifying User Accounts, page 18-21](#)
- [Resetting Another User's Password, page 18-22](#)
- [Deleting User Accounts, page 18-23](#)

## Duplicating a User Account



#### Note

Your user role determines whether you can use this option.

You can create a new user account using settings from an existing user.

#### Procedure

**Step 1** Choose **Admin > Role-Based Access Control > Organization > Users**.

The Users table appears.

**Step 2** Choose the user account you want to copy and click **Duplicate**.



A script popup window appears.

**Step 3** At the prompt in the popup window, enter a name for the new user account and click **OK**.

The popup window closes and the Users table displays the new user account.

**Step 4** (Optional) To make changes to the user account, from the Users table, choose the user account and click **Edit**.

The Edit Organization User window appears.

**Step 5** In the Edit Organization User window, modify the user account settings as described in [Table 18-6](#).

**Step 6** Click **Save** to save the user account information.

The Users window appears.

#### Related Topics

- [Displaying a List of Users, page 18-18](#)
- [Creating User Accounts, page 18-19](#)
- [Modifying User Accounts, page 18-21](#)
- [Resetting Another User's Password, page 18-22](#)
- [Deleting User Accounts, page 18-23](#)

## Modifying User Accounts



#### Note

Your user role determines whether you can use this option.

You can modify existing user accounts.

#### Procedure

**Step 1** Choose **Admin > Role-Based Access Control > Organization > Users**.

The Users table appears.

**Step 2** Choose the user account you want to modify and click **Edit**.

The Edit Organization User window appears.

**Step 3** In the Edit Organization User window, modify any of the attributes in the attributes table (see [Table 18-6](#)).

**Table 18-6** *Modify User Attributes*

| Field      | Description                                                                                                                                                                                                                                     |
|------------|-------------------------------------------------------------------------------------------------------------------------------------------------------------------------------------------------------------------------------------------------|
| Login Name | Name you specified when you created the user you want to duplicate. This is the name by which the user is to be identified in the system (up to 24 characters). Only letters, numbers, and underscore can be used. The field is case sensitive. |
| Name       | Full name of the user. The format is free text.                                                                                                                                                                                                 |
| Email      | Email address for this user.                                                                                                                                                                                                                    |

Table 18-6 Modify User Attributes (continued)

| Field            | Description                                                                                                                                                                                                                                                                                                                                                                                                                                                                                                                                                                                                      |
|------------------|------------------------------------------------------------------------------------------------------------------------------------------------------------------------------------------------------------------------------------------------------------------------------------------------------------------------------------------------------------------------------------------------------------------------------------------------------------------------------------------------------------------------------------------------------------------------------------------------------------------|
| Telephone#       | Telephone number for this user. The format is free text with no embedded spaces.                                                                                                                                                                                                                                                                                                                                                                                                                                                                                                                                 |
| Role             | Predefined role from the list.                                                                                                                                                                                                                                                                                                                                                                                                                                                                                                                                                                                   |
| Domains          | Domains to which this user belongs. Use the <b>Add</b> and <b>Remove</b> buttons to choose domains to which this user belongs.                                                                                                                                                                                                                                                                                                                                                                                                                                                                                   |
| Allowed Login IP | IP address or a subnetwork from which the user is allowed to log in. You can define up to ten different addresses for a single user. Unless you specifically define IP addresses or subnetworks using this option, the user can log in from any IP address. When you enter an allowed single IP address or an allowed subnet, then the user is only allowed to log in from the specified addresses. To restrict access to a specific subnetwork, enter the IP address and the mask, for example, 10.1.200.60/255.255.255.0.<br> |
|                  | <b>Note</b> IP addresses 1.1.1.1 and 0.0.0.0 cannot be entered in this field.                                                                                                                                                                                                                                                                                                                                                                                                                                                                                                                                    |
| Description      | Notes about the user.                                                                                                                                                                                                                                                                                                                                                                                                                                                                                                                                                                                            |
| First Menu       | Menu that is displayed when this user first logs in. Choose one from the drop-down list.                                                                                                                                                                                                                                                                                                                                                                                                                                                                                                                         |
| Last Login       | Last time (local time) that this user logged in and the IP address that was used.                                                                                                                                                                                                                                                                                                                                                                                                                                                                                                                                |

**Step 4** Click **Save** to save the user account information.

#### Related Topics

- [Displaying a List of Users, page 18-18](#)
- [Creating User Accounts, page 18-19](#)
- [Duplicating a User Account, page 18-20](#)
- [Resetting Another User's Password, page 18-22](#)
- [Deleting User Accounts, page 18-23](#)

## Resetting Another User's Password



#### Note

You must have create permissions in order to reset another user's password.

Use this procedure to reset another users's password.

**Step 1** Log in to Cisco License Manager making sure the login username has create permissions.

**Step 2** Choose **Admin > Users**.

The Users window appears.

**Step 3** In the Users window, choose the username for which the password needs to be reset and click the **Reset Password** button.

The Reset Password popup window appears with the selected username in the username field.

**Step 4** Enter and confirm the new password.

- Step 5** Click **OK** to save the password information.  
The **Password has been reset** message displays if there are no errors.
- 

**Related Topics**

- [Displaying a List of Users, page 18-18](#)
- [Creating User Accounts, page 18-19](#)
- [Duplicating a User Account, page 18-20](#)
- [Modifying User Accounts, page 18-21](#)
- [Deleting User Accounts, page 18-23](#)
- [Displaying or Terminating Current User Sessions, page 18-24](#)

## Deleting User Accounts

**Note**

Your user role determines whether you can use this option.

---

You can delete a user account.

**Procedure**

- 
- Step 1** Choose **Admin > Role-Based Access Control > Organization > Users**.  
The Users table appears.
- Step 2** Choose the user account to delete and click **Delete**.
- Step 3** The confirmation popup window appears.
- Step 4** In the confirmation popup window, do one of the following:
- Click **OK** to confirm the deletion request. The user account is removed from the ANM database.
  - Click **Cancel** to ignore the deletion request.
- 

**Related Topics**

- [Displaying a List of Users, page 18-18](#)
- [Creating User Accounts, page 18-19](#)
- [Duplicating a User Account, page 18-20](#)
- [Modifying User Accounts, page 18-21](#)
- [Resetting Another User's Password, page 18-22](#)

# Displaying or Terminating Current User Sessions



## Note

Your user role determines whether you can use this option.

You can display a list of the users currently logged into the system and end their sessions, if required. You can only display the users in your organization.

## Procedure

**Step 1** Choose **Admin > Role-Based Access Control > Active Users**.

The Active User Sessions window displays the following information for each active user who is logged in:

**Table 18-7 Active User Session Information**

| Column        | Description                                                                                                                                                                                                                                         |
|---------------|-----------------------------------------------------------------------------------------------------------------------------------------------------------------------------------------------------------------------------------------------------|
| Name          | Name used to log into the Cisco ANM.                                                                                                                                                                                                                |
| Type Of Login | Method used to log in, for example WEB.                                                                                                                                                                                                             |
| User Type     | Method used to authenticate and authorize the user: <ul style="list-style-type: none"> <li>Local—ANM is used to authenticate and/or authorize the user.</li> <li>Remote— AAA server is used to both authenticate and authorize the user.</li> </ul> |
| Login From IP | IP address of host.                                                                                                                                                                                                                                 |
| Time Of Login | Time user logged in.                                                                                                                                                                                                                                |

**Step 2** (Optional) To terminate an active session, click **Terminate**.

When a user session is terminated, the user is logged out of the interface from which the user session was initiated. If the user was making changes to a configuration, the configuration lock is released and any uncommitted configuration change is discarded.

If a user session is terminated while an operation is in progress, the current operation is not stopped, but any subsequent operation is denied.

For more details on terminating active users, see the [“Displaying or Terminating Current User Sessions” section on page 18-24](#).

## Related Topics

- [Controlling Access to Cisco ANM, page 18-3](#)
- [Managing User Accounts, page 18-17](#)

# Managing User Roles

You use the Roles Management feature to add, modify, and delete user-defined roles and to modify predefined roles. A user's role determines the tasks the user can access. Each role is associated with permissions or rules that define what feature access this role contains. For example, if you design a role that provides access to virtual servers, the role automatically includes access to all real servers that could be included in the virtual server.

ANM provides several predefined user roles that you can modify but not delete. For more information about predefined user roles, including the list of the predefined user roles, see the [“Understanding Predefined Roles”](#) section on page 18-26.

This section includes the following topics:

- [Guidelines for Managing User Roles](#), page 18-25
- [Understanding Predefined Roles](#), page 18-26
- [Displaying User Role Relationships](#), page 18-27
- [Displaying User Roles and Associated Tasks and ANM Menu Privileges](#), page 18-28
- [Creating User Roles](#), page 18-29
- [Duplicating a User Role](#), page 18-31
- [Modifying User Roles](#), page 18-31
- [Deleting User Roles](#), page 18-32

## Guidelines for Managing User Roles

This topic includes the following guidelines:

- System Administrators can view and modify all roles.
- Organization administrator users can only see and modify the users, roles, and domains in their organization.
- Other users can only view the user, roles, and domains assigned to them.
- User-defined roles can be created but follow strict rules about which tasks can be selected or deselected. See the user interface for specific dependencies or the [“Displaying User Roles and Associated Tasks and ANM Menu Privileges”](#) section on page 18-28 for role to task mapping information.
- You must have the ability to create real servers in your role and at least one virtual context in your domain before you can create real servers.
- You must have the ability to create virtual contexts in your role and an Admin context in your domain before you can create virtual contexts.
- If you upgrade to ANM 2.2 any custom roles that are migrated retain their associations but have different role definitions. We encourage you to use the ANM 2.2 predefined default roles.

## Understanding Predefined Roles

You must have one of the predefined roles in the Admin context in order to use the `changeto` command, which allows users to visit other contexts. Non-admin/user contexts do not have access to the `changeto` command; they can only visit their home context. Context administrators, who have access to multiple contexts, must explicitly log in to other contexts to which they have access.

The predefined roles and their default privileges are defined in [Table 18-8](#). For information about viewing user role details, see the [“Displaying User Roles and Associated Tasks and ANM Menu Privileges” section on page 18-28](#). For detailed information on RBAC, see either the *Cisco Application Control Engine Module Virtualization Configuration Guide* or the *Cisco 4700 Series Application Control Engine Appliance Virtualization Configuration Guide*.

**Table 18-8 ANM Predefined Role Tasks**

| Predefined Role | Description                                                                                                         | Role Tasks/Operation Privileges <sup>1</sup>                                                                                                                                                                           |
|-----------------|---------------------------------------------------------------------------------------------------------------------|------------------------------------------------------------------------------------------------------------------------------------------------------------------------------------------------------------------------|
| ACE-Admin       | Access to create virtual contexts and monitor threshold information.                                                | <ul style="list-style-type: none"> <li>View Threshold</li> <li>Create Device Events</li> <li>Create Virtual Context+</li> </ul>                                                                                        |
| ANM-Admin       | Access to create virtual contexts and monitor threshold information. Provides access to all features and functions. | <ul style="list-style-type: none"> <li>Create ANM System</li> <li>Create ANM User Access</li> <li>Create VM Mapping</li> <li>Create ANM Inventory+</li> </ul>                                                          |
| Network-Admin   | Admin for L3 (IP and Routes) and L4 VIPs                                                                            | <ul style="list-style-type: none"> <li>View Threshold</li> <li>Create Device Events</li> <li>Create Switch</li> <li>Create Routing</li> <li>Create Interface</li> <li>Create NAT</li> <li>Create Connection</li> </ul> |
| Network-Monitor | Monitoring for all features                                                                                         | <ul style="list-style-type: none"> <li>View ANM Inventory+</li> </ul>                                                                                                                                                  |
| Org-Admin       | Access to create role-based access control and import and update device data.                                       | <ul style="list-style-type: none"> <li>Create ANM User</li> <li>Create VM Mapping</li> <li>Create ANM Inventory+</li> </ul>                                                                                            |
| Security-Admin  | Security features                                                                                                   | <ul style="list-style-type: none"> <li>Create AAA</li> <li>Modify Interface</li> <li>Create NAT</li> <li>Create Inspect</li> <li>Create Connection</li> </ul>                                                          |

Table 18-8 ANM Predefined Role Tasks (continued)

| Predefined Role          | Description                                   | Role Tasks/Operation Privileges <sup>1</sup>                                                                                                                                                                                                                                  |
|--------------------------|-----------------------------------------------|-------------------------------------------------------------------------------------------------------------------------------------------------------------------------------------------------------------------------------------------------------------------------------|
| Server-Appln-Maintenance | Server maintenance and L7 policy application  | <ul style="list-style-type: none"> <li>View Threshold</li> <li>View VIP</li> <li>View Virtual Inservice</li> <li>Create LoadBalancer+</li> </ul>                                                                                                                              |
| Server-Maintenance       | Server maintenance, monitoring, and debugging | <ul style="list-style-type: none"> <li>View Threshold</li> <li>View VIP+</li> <li>Modify Real Server</li> <li>Debug Probe</li> <li>Create Real Inservice</li> </ul>                                                                                                           |
| SLB-Admin                | Load-balancing features                       | <ul style="list-style-type: none"> <li>View Threshold</li> <li>Create Building Block</li> <li>Modify Interface</li> <li>Create Expert+</li> </ul>                                                                                                                             |
| SSL-Admin                | SSL features                                  | <ul style="list-style-type: none"> <li>Create SSL+</li> </ul>                                                                                                                                                                                                                 |
| SSL-Cert-Key-Admin       | SSL certificate and key management features   | <ul style="list-style-type: none"> <li>Import, generate, or delete keys</li> <li>Import or delete certificates</li> <li>Generate a certificate signing request (CSR)</li> <li>Monitor certificate expiration through the dashboard GUI and threshold modifications</li> </ul> |
| VM-Mapper                | Virtual machine (VM) mapping feature          | <ul style="list-style-type: none"> <li>Create VM to real server map</li> </ul>                                                                                                                                                                                                |

1. Where the plus sign (+) is indicated, all permissions included in this folder are included at the same privilege level, unless otherwise noted. For example, Virtual Contexts tasks are comprised of tasks such as AAA, Building Blocks, and so on. These tasks are depicted as columns in the Roles table.

## Displaying User Role Relationships



### Note

Your user role determines whether you can use this option.

You can display which users are associated to specific roles.

### Procedure

- Step 1** Choose **Admin > Role-Based Access Control > Organizations > Roles**.  
The Roles table appears.
- Step 2** In the Roles table, choose a role and click **Users**.

The Users With Role window appears. From this window you can delete or duplicate a user. For information about how roles map to users, see the “[Displaying User Roles and Associated Tasks and ANM Menu Privileges](#)” section on page 18-28.

#### Related Topics

- [Duplicating a User Account, page 18-20](#)
- [Managing User Roles, page 18-25](#)

## Displaying User Roles and Associated Tasks and ANM Menu Privileges



#### Note

Your user role determines whether you can use this option.

You can view the list of predefined and user defined roles and see how each role is configured to manage what a user can do within ANM. [Figure 18-2](#) shows a sample of the role information available for the predefined ANM-Admin role. Each Role Task is assigned a privilege level (No Access, View, Modify, Debug, or Create) that determines what displays in the Resulting Menu Items list on the right. This list indicates which ANM GUI items the role allows a user to access.

**Figure 18-2** Edit Role Window

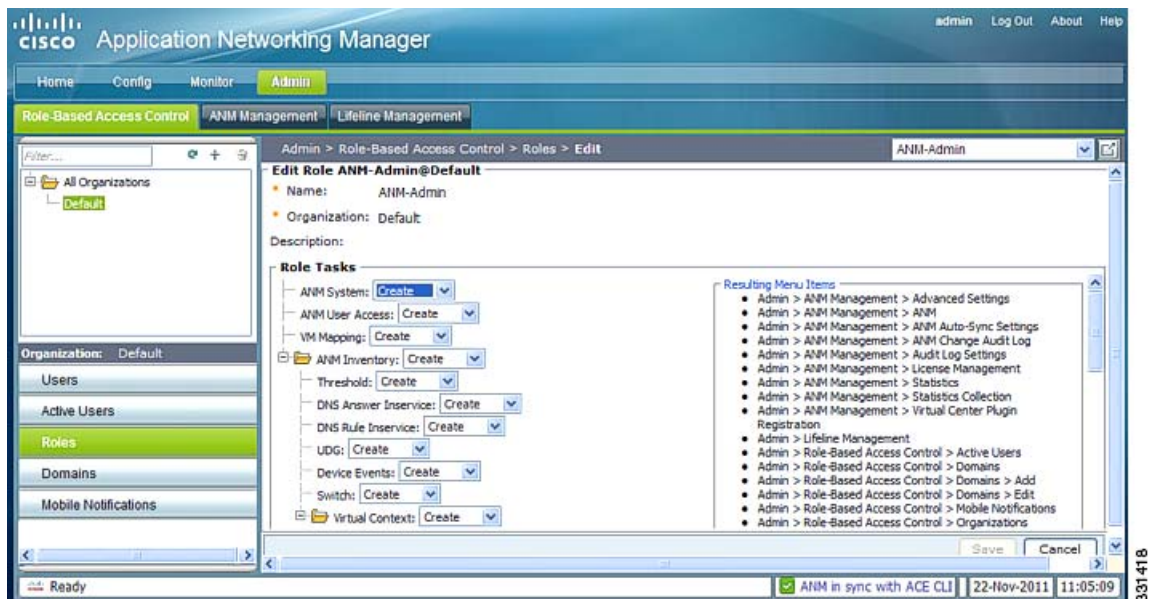

#### Procedure

**Step 1** Choosing **Admin > Role-Based Access Control > Organizations > Roles**.

The Roles table appears, displaying the list of predefined and user defined roles. The table includes the available role tasks and associated privilege level: No Access, View, Modify, Debug, or Create.

**Step 2** To view the ANM menu items available to a specific user role, choose a user role and click the **Edit** icon.



The Edit Role window appears (see [Figure 18-2](#)), displaying the Role Task tree and list of Resulting Menu Items, which is based on the privilege levels selected for each role task.



---

**Note** The information available from the Edit Role window can vary depending on the version of ANM being used.

---

- Step 3** (Optional) Click **Cancel** to return to the Roles table where you can perform the following tasks:
- Create a new role (see the [“Creating User Roles”](#) section on page 18-29).
  - View the users assigned to a role (see the [“Displaying User Role Relationships”](#) section on page 18-27).
  - Modify an existing role to which you have access (see the [“Modifying User Roles”](#) section on page 18-31).
  - Duplicate any existing role to which you have access (see the [“Duplicating a User Role”](#) section on page 18-31).
  - Delete any existing role to which you have access (see the [“Deleting User Roles”](#) section on page 18-32).
- 

#### Related Topics

- [Understanding Operations Privileges, page 18-6](#)
- [Managing User Roles, page 18-25](#)

## Creating User Roles



---

**Note** Your user role determines whether you can use this option.

---

You can edit the predefined roles, or you can create new, user-defined roles. When you create a new role, you specify a name and description of the new role, then choose the privileges for each task. You can also assign this role to one or more users.

#### Procedure

---

- Step 1** Choose **Admin > Role-Based Access Control > Organization > Roles**.  
The Roles table appears.
- Step 2** Click **Add**.  
The New Role window appears.

**Step 3** Enter the following attributes as shown in [Table 18-9](#).

**Table 18-9** *Role Attributes*

| Attribute            | Description                                                                                                                                                                                                                                                                                                                                                                                                                                                                                                                                                                                                                                                                                                                                                                                                                                                                                                                                                                                                                                                                                                                                                                                                                                                                                                                                                                                                                                                                               |
|----------------------|-------------------------------------------------------------------------------------------------------------------------------------------------------------------------------------------------------------------------------------------------------------------------------------------------------------------------------------------------------------------------------------------------------------------------------------------------------------------------------------------------------------------------------------------------------------------------------------------------------------------------------------------------------------------------------------------------------------------------------------------------------------------------------------------------------------------------------------------------------------------------------------------------------------------------------------------------------------------------------------------------------------------------------------------------------------------------------------------------------------------------------------------------------------------------------------------------------------------------------------------------------------------------------------------------------------------------------------------------------------------------------------------------------------------------------------------------------------------------------------------|
| Name                 | Name of the role.                                                                                                                                                                                                                                                                                                                                                                                                                                                                                                                                                                                                                                                                                                                                                                                                                                                                                                                                                                                                                                                                                                                                                                                                                                                                                                                                                                                                                                                                         |
| Description          | Brief description of the role.                                                                                                                                                                                                                                                                                                                                                                                                                                                                                                                                                                                                                                                                                                                                                                                                                                                                                                                                                                                                                                                                                                                                                                                                                                                                                                                                                                                                                                                            |
| Role Tasks           | <p>Role task tree that defines the operation privileges associated with each task. The tasks are arranged in a hierarchy of parent and subordinate tasks. Click on the + sign of a parent task to display its subordinate tasks as shown in the following example for the ANM Inventory task.</p> <ul style="list-style-type: none"> <li>- ANM Inventory --&gt;parent task <ul style="list-style-type: none"> <li>Threshold --&gt;subordinate tasks</li> <li>DNS Answer</li> <li>UDG</li> <li>Device Events</li> <li>Switch</li> </ul> </li> <li>+ Virtual Context --&gt;subordinate task that has its own set of subordinate tasks as indicated by the + sign</li> </ul> <p>You assign one of the following operating privileges to each of the tasks: No Access, View, Modify, Debug, or Create. When you assign an operating privilege to a parent task, by default, the same privilege is assigned the subordinates. You can assign a different operating privilege to the subordinates if needed; however, you can only assign an operating privilege that is greater than or equal to the operating privilege assigned to the parent task.</p> <p>If you set the parent task to Modify or Debug, the Create privilege is the only privilege allowed for the subordinate tasks and by default, is assigned to the subordinate tasks.</p> <p>For more information about operating privileges, see the <a href="#">“Understanding Operations Privileges” section on page 18-6</a>.</p> |
| Resulting Menu Items | Synchronized list of features in the form of menus that this role is able to access after setting the role task operation privileges.                                                                                                                                                                                                                                                                                                                                                                                                                                                                                                                                                                                                                                                                                                                                                                                                                                                                                                                                                                                                                                                                                                                                                                                                                                                                                                                                                     |

**Step 4** Click **Save**.

The new role is added to the list of user roles.

**Step 5** (Optional) To assign this new role to one or more users, go to **Admin > Organizations > Users**.

For detailed steps, see the [“Modifying User Accounts” section on page 18-21](#).

#### Related Topics

- [Understanding Operations Privileges, page 18-6](#)
- [Managing User Roles, page 18-25](#)

## Duplicating a User Role



**Note** Your user role determines whether you can use this option.

You can create a new user-defined role from an existing one.

### Procedure

- 
- Step 1** Choose **Admin > Role-Based Access Control > Organization > Roles**.  
The Roles table appears.
- Step 2** In the Roles table, choose the role you want to copy and click **Duplicate**.  
A script popup window appears.
- Step 3** At the prompt in the script popup window, enter a name for the new role.
- Step 4** Click **OK**.
- Step 5** The script popup window closes and Roles tables displays the new role.
- Step 6** (Optional) To make changes to the new role's attributes, in the Roles table, choose the role and click **Edit**.  
The Edit Role window appears.
- Step 7** Make the required changes and click **Save** to save the changes.
- 

### Related Topics

- [Understanding Operations Privileges, page 18-6](#)
- [Managing User Roles, page 18-25](#)

## Modifying User Roles



**Note** Your user role determines whether you can use this option.

You can modify any user-defined roles.

### Procedure

- 
- Step 1** Choose **Admin > Role-Based Access Control > Organization > Roles**.  
The Roles table appears.
- Step 2** Choose the role you want to modify and click **Edit**.  
The Edit Role window appears.
- Step 3** Make the required modifications.

**Step 4** Click **Save**.

---

#### Related Topics

- [Understanding Operations Privileges, page 18-6](#)
- [Managing User Roles, page 18-25](#)

## Deleting User Roles



#### Note

Your user role determines whether you can use this option.

---

You can delete any user-defined roles.

#### Procedure

---

**Step 1** Choose **Admin > Role-Based Access Control > Organization > Roles**.

The Users table appears.

**Step 2** Choose the role to delete and click **Delete**.

**Step 3** The confirmation popup window appears.

**Step 4** In the confirmation popup window, click **OK** to confirm the deletion.

Users that have the deleted role no longer have that access.

---

#### Related Topics

[Managing User Roles, page 18-25](#)

## Managing Domains

Network domains provide a means for organizing the devices and their components (physical and logical) in your network and permitting access according to the way your site is organized. You can allow access to a domain by assigning it to an organization. Examples are specific virtual contexts or specific servers within a context.

The following sections describe how to manage domains:

- [Guidelines for Managing Domains, page 18-33](#)
- [Displaying Network Domains, page 18-33](#)
- [Creating a Domain, page 18-34](#)
- [Duplicating a Domain, page 18-35](#)
- [Modifying a Domain, page 18-36](#)
- [Deleting a Domain, page 18-37](#)

## Guidelines for Managing Domains

This topic includes the following guidelines:

- Domains are *logical* concepts. You do not delete a member of a domain when you delete the domain.
- Domains can include supported Cisco chassis, ACE modules, ACE appliances, and CSS or CSM devices, as well as their virtual contexts, building blocks, resource classes, and real and virtual servers.
- Choose the Allow All setting to include current and future device objects in a domain.
- Objects must already exist in ANM. To add objects, see the [“Importing Network Devices into ANM” section on page 5-10](#).
- You must have the ability to create real servers in your role and at least one virtual context in your domain before you can create real servers.
- You must have the ability to create virtual contexts in your role and an Admin context in your domain before you can create virtual contexts.
- Domains continue to display device information even after you remove that device from ANM. This allows the domain information to be easily reassociated if you reimport the device. The device name must remain the same for this to work properly.
- (GSS domain objects only) ANM does not allow you to add a VIP answer to a domain if the answer contains a space in its name.



### Caution

---

Domain objects are hierarchical. If you include a parent object in a domain, the child object is also included even though they do not display in the Object selector tree when you add or edit domains.

---

For example:

- Inclusion of a Catalyst 6500 series switch includes all cards, virtual contexts, real servers and virtual servers.
- Inclusion of an ACE 4710 includes all virtual contexts, real servers, and virtual servers.
- Inclusion of a virtual context, CSM module or CSS device includes all associated objects.

### Related Topics

- [Creating a Domain, page 18-34](#)
- [Modifying a Domain, page 18-36](#)
- [Displaying Network Domains, page 18-33](#)
- [Duplicating a Domain, page 18-35](#)
- [Deleting a Domain, page 18-37](#)

## Displaying Network Domains



### Note

---

Your user role determines whether you can use this option.

---

You can display the network domains and a domain's attributes.

**Procedure**

- 
- Step 1** Choose **Admin > Role-Based Access Control > Organization > Domains**.  
The Domains table appears.
- Step 2** Expand the table until you can see all the network domains.
- Step 3** Choose a domain from the Domains table to view and click **Edit**.  
The Edit Domains window appears, displaying the domain's attributes.
- 

**Related Topics**

- [Managing Domains, page 18-32](#)
- [Guidelines for Managing Domains, page 18-33](#)
- [Creating a Domain, page 18-34](#)
- [Duplicating a Domain, page 18-35](#)
- [Modifying a Domain, page 18-36](#)
- [Deleting a Domain, page 18-37](#)

## Creating a Domain



**Note** Your user role determines whether you can use this option.

---

You can create a new domain.

**Procedure**

- 
- Step 1** Choose **Admin > Role-Based Access Control > Organization > Domains**.  
The Domains table appears.
- Step 2** Click **Add**.
- Step 3** Define the domain attributes as described in [Table 18-10](#).

**Table 18-10**     **Domain Attributes**

| Field       | Description                |
|-------------|----------------------------|
| Name        | Name of the domain.        |
| Description | Description of the domain. |

**Table 18-10** Domain Attributes (continued)

| Field     | Description                                                                                                                                                                                                                                                                                                                                                                                                                                                                                                                                                                                                                                                                                                                                                                                                                                                                           |
|-----------|---------------------------------------------------------------------------------------------------------------------------------------------------------------------------------------------------------------------------------------------------------------------------------------------------------------------------------------------------------------------------------------------------------------------------------------------------------------------------------------------------------------------------------------------------------------------------------------------------------------------------------------------------------------------------------------------------------------------------------------------------------------------------------------------------------------------------------------------------------------------------------------|
| Allow All | Check box that enables all objects within this domain (current and future objects). If this check box is left unchecked, the Objects tree displays.                                                                                                                                                                                                                                                                                                                                                                                                                                                                                                                                                                                                                                                                                                                                   |
| Objects   | <p>Collection of objects that comprise this domain. Choose an object name and use the arrows to move it from the available to selected column.</p> <p>For example, selecting a virtual context selects all real servers within that virtual context, or selecting a chassis selects the virtual contexts on that chassis. The interface does not explicitly display this in the table, but the objects are, in fact, selected.</p> <p> <b>Note</b> When you add objects such as real servers to a domain on an ACE that has an HA peer, ANM automatically adds the redundant objects from the HA peer to the list of selected objects.</p> <p>See the “<a href="#">Guidelines for Managing Domains</a>” section on page 18-33 for domain rules about creating virtual contexts and real servers.</p> |

**Step 4** Click **Save**.

The Domains Edit window updates and displays the total object number next to the object name.

**Related Topics**

- [Managing Domains, page 18-32](#)
- [Guidelines for Managing Domains, page 18-33](#)
- [Displaying Network Domains, page 18-33](#)
- [Creating a Domain, page 18-34](#)
- [Duplicating a Domain, page 18-35](#)
- [Modifying a Domain, page 18-36](#)
- [Deleting a Domain, page 18-37](#)

## Duplicating a Domain



**Note** Your user role determines whether you can use this option.

You can create a new domain from an existing one.

**Procedure**

**Step 1** Choose **Admin > Role-Based Access Control > Organization > Domains**.

The Domains table appears.

**Step 2** Choose the domain to copy and click **Duplicate**.

**Step 3** A script popup window appears.

- Step 4** At the prompt in the script popup window, enter a name for the new domain and click **OK**.  
The script popup window closes and the Domains table displays the new domain.
- Step 5** Click **Save**.
- 

**Related Topics**

- [Managing Domains, page 18-32](#)
- [Guidelines for Managing Domains, page 18-33](#)
- [Displaying Network Domains, page 18-33](#)
- [Creating a Domain, page 18-34](#)
- [Modifying a Domain, page 18-36](#)
- [Deleting a Domain, page 18-37](#)

## Modifying a Domain

**Note**

---

Your user role determines whether you can use this option.

---

You can modify the settings in a domain.

**Procedure**

- 
- Step 1** Choose **Admin > Role-Based Access Control > Organization > Domains**.  
The Domains table appears.
- Step 2** In the Domains table, choose the domain you want to change and click **Edit**.  
The Edit Domains window appears.
- Step 3** In the Edit Domains window, modify the domain settings.  
For detailed domain attribute descriptions, see [Table 18-10 on page 18-34](#).
- Step 4** Click **Save**.
- 

**Related Topics**

- [Managing Domains, page 18-32](#)
- [Guidelines for Managing Domains, page 18-33](#)
- [Displaying Network Domains, page 18-33](#)
- [Creating a Domain, page 18-34](#)
- [Duplicating a Domain, page 18-35](#)
- [Deleting a Domain, page 18-37](#)



## Deleting a Domain



---

**Note** Your user role determines whether you can use this option.

---

You can delete a network domain from the systems. You do not delete objects associated with that domain when you delete the domain.

### Procedure

---

**Step 1** Choose **Admin > Role-Based Access Control > Organization > Domains**.

The Domains table appears.

**Step 2** In the Domains table, choose the domain to delete and click **Delete**.

The confirmation popup window appears.

**Step 3** In the confirmation popup window, click **OK**.

The domain is removed from the ANM database.

---

### Related Topics

- [Managing Domains, page 18-32](#)
- [Guidelines for Managing Domains, page 18-33](#)
- [Displaying Network Domains, page 18-33](#)
- [Creating a Domain, page 18-34](#)
- [Duplicating a Domain, page 18-35](#)
- [Modifying a Domain, page 18-36](#)

# Using an AAA Server for Remote User Authentication and Authorization

ANM allows you to centrally control user authentication and authorization. User authentication, which manages access to ANM, can be performed locally using a database that resides in ANM or remotely using a database that resides on an AAA server, such as an Active Directory (AD) server using LDAPS, RADIUS, or TACACS+. In ANM, you can configure authentication for your users by specifying which AAA servers are used for specific users. You configure authentication through organizations. An organization allows you to configure your AAA server lookup for your users and then associate specific users, roles, and domains with those organizations.

User authorization, which manages access to different ANM functionality, can also be performed locally using a database that resides in ANM or remotely using a database that resides on a TACACS+ server. ANM supports the use of a TACACS+ server only for remote authorization.

The information provided in this section is intended as a guide to help you ensure proper communication with the AAA server and ANM operating as the AAA client. For details about configuring the Cisco Secure ACS, Active Directory, or another AAA server, see the documentation that is provided with the software.

This section includes the following topics:

- [Information About Using AD/LDAPS for Remote User Authentication, page 18-38](#)
- [Configuring Remote User Authentication Using a TACACS+ Server, page 18-39](#)
- [Configuring Remote User Authorization Using a TACACS+ Server, page 18-45](#)

## Information About Using AD/LDAPS for Remote User Authentication

This section describes how ANM uses AD/LDAPS for remote user authentication. ANM performs the following steps to authenticate and authorize a user when configured to use AD/LDAPS for user authentication:

1. ANM verifies that the user organization exists locally on the ANM database. ANM makes this determination based on the part of the user login name that follows the @ character.
2. ANM uses the configured AD server to authenticate the user.
3. ANM authorizes the user locally. ANM verifies that the user's name is associated with one of the defined roles in the Roles table (Admin > Role-Based Access Control > *Organization* > Roles).

After ANM completes these three steps, the user is permitted access according to their account settings in the Roles table and Domains table (Admin > Role-Based Access Control > *Organization* > Domains).

If any of the authentication and authorization checks fail, ANM logs the error in the audit log (Admin > ANM Management > ANM Change Audit Log).

One of the following error messages display depending on when the failure occurs:

- If Step 1 fails, the message is as follows:  
User authentication failed: Organization <org\_name> does not exist.
- If Step 2 fails, the message is as follows:  
User authentication failed: ... , reason=User password check failed - error code XXX - <error\_description>.

This message means that the AD server rejected the user. The list of possible error codes and respective descriptions are as follows:

- 525—User is not found
  - 52e—User credentials are invalid
  - 530—User is not permitted to log on at this time
  - 531—User is not permitted to log on from this workstation
  - 532—Password has expired
  - 533—Account is disabled
  - 701—Account has expired
  - 773—User must reset their password
  - 775—Account is locked out
- If Step 3 fails, the message is as follows:  
User authorization failed: User is not defined in the <org\_name> organization.

## Configuring Remote User Authentication Using a TACACS+ Server

This section describes how to configure ANM and a TACACS+ server for remote user authentication.



### Note

For background information about configuring an AAA server, see the “Configuring Authentication and Accounting Services” chapter of either the *Cisco ACE Module Security Configuration Guide* or *Cisco ACE 4700 Series Appliance Security Configuration Guide* on [www.cisco.com](http://www.cisco.com).

### Assumptions

This topic assumes the following:

- For purposes of this example, assume usage of a Cisco Secure ACS version 4.1 server.
- Your user role determines whether you can perform the procedures outlined in this section.
- Administrative login rights are required to access the Cisco Secure ACS HTML interface.

[Table 18-11](#) provides a high-level overview of the steps required to authenticate ANM users with a TACACS+ server.

Table 18-11 Authenticating ANM Users with a TACACS+ Server

| Task                                                                                        | Procedure                                                                                                                                                                                                                                                                                                                                                                                                                                                                                                                                                                                                                                                                                                                                                                                                                                                                                                                                                                                                                                                                                                                                                                                                                                                                                                                                                         |
|---------------------------------------------------------------------------------------------|-------------------------------------------------------------------------------------------------------------------------------------------------------------------------------------------------------------------------------------------------------------------------------------------------------------------------------------------------------------------------------------------------------------------------------------------------------------------------------------------------------------------------------------------------------------------------------------------------------------------------------------------------------------------------------------------------------------------------------------------------------------------------------------------------------------------------------------------------------------------------------------------------------------------------------------------------------------------------------------------------------------------------------------------------------------------------------------------------------------------------------------------------------------------------------------------------------------------------------------------------------------------------------------------------------------------------------------------------------------------|
| <p><b>Step 1</b> Create an organization and define the remote TACACS+ server used (ANM)</p> | <p><b>Note</b> Your user role determines whether you can use this option.</p> <p>Remote authentication servers are defined in ANM as organizations. A single server can be used in multiple organizations. To configure authentication for your users by creating an organization and defining TACACS+ as the method of authentication, do the following:</p> <ol style="list-style-type: none"> <li>a. Choose <b>Admin &gt; Role-Based Access Control &gt; All Organizations</b>. The Organizations window appears.</li> <li>b. Click <b>Add</b>.</li> <li>c. Enter the name of the new organization and notes if required.</li> <li>d. Click <b>Save</b>.</li> <li>e. Choose the new organization and click <b>Edit</b>.</li> <li>f. Enter the attributes as described in <a href="#">Table 18-2</a>. Certain attributes appear when you choose specific options. Include the following organization attributes to authenticate ANM users with a TACACS+ server: <ul style="list-style-type: none"> <li>- Organization name</li> <li>- TACACS+ as authentication method</li> <li>- IP address of TACACS+ server</li> <li>- Authentication port number</li> <li>- Authentication secret</li> </ul> </li> <li>g. Click <b>Save</b>.</li> </ol> <p>See the <a href="#">“Adding a New Organization”</a> section on page 18-10 for details about this procedure.</p> |
| <p><b>Step 2</b> Creating a role for RBAC (ANM)</p>                                         | <p><b>Note</b> Your user role determines whether you can use this option.</p> <p>You can edit the predefined roles or you can create user-defined roles. When you create a role, you specify a name and description of the new role, and then choose the privileges for each task. You can also assign this role to one or more users.</p> <p>Do the following:</p> <ol style="list-style-type: none"> <li>a. Choose <b>Admin &gt; Role-Based Access Control &gt; Organization &gt; Roles</b>. The Roles table appears.</li> <li>b. Click <b>Add</b>. The New Role form appears.</li> <li>c. Enter the attributes as described in <a href="#">Table 18-9</a>.</li> <li>d. Click <b>Save</b>. The new role is added to the list of user roles.</li> </ol> <p>See the <a href="#">“Creating User Roles”</a> section on page 18-29 for details on this procedure.</p>                                                                                                                                                                                                                                                                                                                                                                                                                                                                                                |

Table 18-11 Authenticating ANM Users with a TACACS+ Server (continued)

| Task                                                        | Procedure                                                                                                                                                                                                                                                                                                                                                                                                                                                                                                                                                                                                                                                                                                                                                                                                                                                                                                                                                                                                                                                                                                                                                                                                                                                                                                                                                                                                                                                                                                                   |
|-------------------------------------------------------------|-----------------------------------------------------------------------------------------------------------------------------------------------------------------------------------------------------------------------------------------------------------------------------------------------------------------------------------------------------------------------------------------------------------------------------------------------------------------------------------------------------------------------------------------------------------------------------------------------------------------------------------------------------------------------------------------------------------------------------------------------------------------------------------------------------------------------------------------------------------------------------------------------------------------------------------------------------------------------------------------------------------------------------------------------------------------------------------------------------------------------------------------------------------------------------------------------------------------------------------------------------------------------------------------------------------------------------------------------------------------------------------------------------------------------------------------------------------------------------------------------------------------------------|
| <p><b>Step 3</b> Create a domain for an RBAC user (ANM)</p> | <p><b>Note</b> Your user role determines whether you can use this option.</p> <p>A domain defines which objects that the RBAC user will have access to. The assigned role defines which actions that user will be able to perform on those objects.</p> <p>To configure a domain for an RBAC user, do the following:</p> <ol style="list-style-type: none"> <li>Choose <b>Admin &gt; Role-Based Access Control &gt; Organization &gt; Domains</b>. The Domains table appears.</li> <li>In the Domains table, click <b>Add</b>.</li> <li>For the new domain, enter the attributes as described in <a href="#">Table 18-10</a>.</li> </ol> <hr/> <p> <b>Note</b> If you check the Allow All checkbox, this selection enables all objects within this domain (current and future objects). If you leave this check box unchecked, the Objects tree displays. To allow a user to have access to the entire context, highlight the Virtual Contexts folder in the Objects tree, locate the specific user context, and then click the arrow to send it to the Selected box. The context name format is &lt;chassis-name&gt;:&lt;slot-number&gt;:&lt;context-name&gt;</p> <hr/> <ol style="list-style-type: none"> <li>Click <b>Save</b> when all the objects that you want to allow access to are listed in the Selected box.</li> </ol> <p>See the <a href="#">“Creating a Domain” section on page 18-34</a> for details on this procedure.</p> |
| <p><b>Step 4</b> Create an organization user (ANM)</p>      | <p><b>Note</b> Your user role determines whether you can use this option.</p> <p>Organization users are users who work for the customer of a service provider or AAA server that segments your users and to whom you want to grant access to ANM.</p> <p>Do the following:</p> <ol style="list-style-type: none"> <li>Choose <b>Admin &gt; Role-Based Access Control &gt; Organization &gt; Users</b>. The Users window appears.</li> <li>In the Users window, click <b>Add</b>.</li> <li>Enter the attributes as described in <a href="#">Table 18-5</a>. Include the following organization user attributes: <ul style="list-style-type: none"> <li>– Login name</li> <li>– Predefined role</li> <li>– Domains to which this user belongs</li> </ul> </li> <li>Click <b>Save</b>. The Users table appears.</li> </ol> <p>See the <a href="#">“Creating User Accounts” section on page 18-19</a> for details on this procedure.</p>                                                                                                                                                                                                                                                                                                                                                                                                                                                                                                                                                                                        |

Table 18-11 Authenticating ANM Users with a TACACS+ Server (continued)

| Task                                                                     | Procedure                                                                                                                                                                                                                                                                                                                                                                                                                                                                                                                                                                                                                                                                                                                                                                                                    |
|--------------------------------------------------------------------------|--------------------------------------------------------------------------------------------------------------------------------------------------------------------------------------------------------------------------------------------------------------------------------------------------------------------------------------------------------------------------------------------------------------------------------------------------------------------------------------------------------------------------------------------------------------------------------------------------------------------------------------------------------------------------------------------------------------------------------------------------------------------------------------------------------------|
| <b>Step 5</b><br>Access the AAA server (Cisco Secure ACS server)         | <p><b>Note</b> Administrative login rights are required to access the Cisco Secure ACS HTML interface.</p> <p>To access the Cisco Secure ACS HTML interface, do the following:</p> <ol style="list-style-type: none"> <li><b>a.</b> Open a web browser for the URL of the Cisco Secure ACS HTML interface.</li> <li><b>b.</b> In the Username box, type a valid Cisco Secure ACS administrator name.</li> <li><b>c.</b> In the Password box, type the password for the administrator name that you specified.</li> <li><b>d.</b> Click <b>Login</b>. The Cisco Secure ACS HTML interface appears.</li> </ol> <p>For details on configuring the Cisco Secure ACS HTML server, see the documentation that is provided with the software.</p>                                                                   |
| <b>Step 6</b><br>Create a network device group (Cisco Secure ACS Server) | <p>To create a group of TACACS+ clients and servers on the Cisco Secure ACS HTML server, do the following:</p> <ol style="list-style-type: none"> <li><b>a.</b> Go to the Network Configuration section of the Cisco Secure ACS HTML interface.</li> <li><b>b.</b> In the navigation bar, click the <b>Network Configuration</b> button. The Network Configuration page appears in the Cisco Secure ACS HTML interface.</li> <li><b>c.</b> Under the Network Device Groups table, click the <b>Add Entry</b> button to create a new group of TACACS+ clients and servers. Type the name of the new group (for example ANM).</li> <li><b>d.</b> Click <b>Submit</b>.</li> </ol> <p>For details on configuring the Cisco Secure ACS HTML server, see the documentation that is provided with the software.</p> |

Table 18-11 Authenticating ANM Users with a TACACS+ Server (continued)

| Task                                                                                | Procedure                                                                                                                                                                                                                                                                                                                                                                                                                                                                                                                                                                                                                                                                                                                                                                                                                                                                                                                                                                                                                                                                                                                                                                                                                                                    |
|-------------------------------------------------------------------------------------|--------------------------------------------------------------------------------------------------------------------------------------------------------------------------------------------------------------------------------------------------------------------------------------------------------------------------------------------------------------------------------------------------------------------------------------------------------------------------------------------------------------------------------------------------------------------------------------------------------------------------------------------------------------------------------------------------------------------------------------------------------------------------------------------------------------------------------------------------------------------------------------------------------------------------------------------------------------------------------------------------------------------------------------------------------------------------------------------------------------------------------------------------------------------------------------------------------------------------------------------------------------|
| <p><b>Step 7</b> Specify the AAA client setup for ANM (Cisco Secure ACS Server)</p> | <p>To define the AAA client setup for ANM on the Cisco Secure ACS HTML server, do the following:</p> <ol style="list-style-type: none"> <li>a. Click <b>Add Entry</b> below the AAA Clients table. The Add AAA Client window appears.</li> <li>b. In the Add AAA Client window, specify the following attributes: <ul style="list-style-type: none"> <li>– AAA Client IP Address—Client IP address of ANM that will be used for communicating with the TACACS+ server</li> <li>– Shared Secret—Shared secret specified on ANM</li> <li>– Network Device Group—ANM</li> <li>– Authenticate Using—TACACS+ (Cisco IOS)</li> </ul> </li> </ol> <p> <b>Note</b> The TACACS+ (Cisco IOS) drop-down item specifies the Cisco TACACS+ authentication function. This selection activates the TACACS+ option when using Cisco Systems access servers, routers, and firewalls that support the TACACS+ authentication protocol, including support for ANM as well.</p> <ol style="list-style-type: none"> <li>c. Click <b>Submit + Apply</b>.</li> </ol> <p>For details on configuring the Cisco Secure ACS HTML server, see the documentation that is provided with the software.</p> |
| <p><b>Step 8</b> Specify the AAA server setup (Cisco Secure ACS Server)</p>         | <p>To define the AAA server setup for ANM on the Cisco Secure ACS HTML server, do the following:</p> <ol style="list-style-type: none"> <li>a. Click <b>Add Entry</b> below the AAA Servers table. The Add AAA Servers window appears.</li> <li>b. In the Add AAA Servers window, specify the following attributes: <ul style="list-style-type: none"> <li>– AAA Server IP Address—IP address of the TACACS+ server</li> <li>– Key—Shared secret specified on ANM</li> <li>– Log Update/Watchdog Packets from This Remote AAA Server—Enabled</li> <li>– Network Device Group—ANM</li> <li>– AAA Server Type—TACACS+</li> <li>– Traffic Type—Inbound/Outbound</li> </ul> </li> <li>c. Click <b>Submit + Apply</b>.</li> </ol> <p>For details on configuring the Cisco Secure ACS HTML server, see the documentation that is provided with the software.</p>                                                                                                                                                                                                                                                                                                                                                                                                   |

Table 18-11 Authenticating ANM Users with a TACACS+ Server (continued)

| Task                                                                                    | Procedure                                                                                                                                                                                                                                                                                                                                                                                                                                                                                                                                                                                                                                                                                                                                                                                                                                                                                                                                                                                                  |
|-----------------------------------------------------------------------------------------|------------------------------------------------------------------------------------------------------------------------------------------------------------------------------------------------------------------------------------------------------------------------------------------------------------------------------------------------------------------------------------------------------------------------------------------------------------------------------------------------------------------------------------------------------------------------------------------------------------------------------------------------------------------------------------------------------------------------------------------------------------------------------------------------------------------------------------------------------------------------------------------------------------------------------------------------------------------------------------------------------------|
| <b>Step 9</b><br>Create the ANM user on the TACACS+ server<br>(Cisco Secure ACS Server) | <p>To create the ANM user on the Cisco Secure ACS HTML server, do the following:</p> <ol style="list-style-type: none"> <li>a. Click the <b>User Setup</b> button. The User Setup window appears.</li> <li>b. In the User text box of the User Setup window, enter the user name of the organization user that you created in ANM (see Step 3, the Create an domain for a RBAC user task).</li> <li>c. Click the <b>Add/Edit</b> button.</li> <li>d. Specify the following user attributes:               <ul style="list-style-type: none"> <li>– Real Name—Real name of the ANM user.</li> <li>– Description—Brief description of the user for the administrator.</li> <li>– Password Authentication—ACS Internal Database.</li> <li>– Password—Password for this user account. Enter this password a second time in the Confirm Password text box.</li> </ul> </li> </ol> <p>For details on configuring the Cisco Secure ACS HTML server, see the documentation that is provided with the software.</p> |



Table 18-11 Authenticating ANM Users with a TACACS+ Server (continued)

| Task                                                  | Procedure                                                                                                                                                                                                                                                                                                                                                                                                                                                                                                                                                                                                                                                                                                         |
|-------------------------------------------------------|-------------------------------------------------------------------------------------------------------------------------------------------------------------------------------------------------------------------------------------------------------------------------------------------------------------------------------------------------------------------------------------------------------------------------------------------------------------------------------------------------------------------------------------------------------------------------------------------------------------------------------------------------------------------------------------------------------------------|
| Step 10 Log in to ANM using the newly created account | <p>To test the new login credentials for user authentication, do the following:</p> <ol style="list-style-type: none"> <li>Log in to ANM by entering the new user account in the ANM login window. Enter the username using the following format:<br/>&lt;username&gt;@&lt;organization&gt;.</li> <li>Click <b>Login</b>. Authentication occurs between ANM and the TACACS+ server (see Figure 18-3). All authentication transactions are performed by the TACACS+ authentication service associated with the associated organization.</li> <li>ANM appears with the virtual contexts that you included as part of the domain for the RBAC user in Step 3 (the Create an domain for a RBAC user task).</li> </ol> |

Figure 18-3 Example of Authentication Communication Between ANM and a TACACS+ Server

| No. - | Time      | Source        | Destination   | Protocol | Info                                                 |
|-------|-----------|---------------|---------------|----------|------------------------------------------------------|
| 13    | 98.089267 | 10.86.179.214 | 10.86.178.80  | TCP      | 57176 > 49 [SYN] Seq=0 Len=0 MSS=1460 TSV=2488002454 |
| 14    | 0.000049  | 10.86.178.80  | 10.86.179.214 | TCP      | 49 > 57176 [SYN, ACK] Seq=0 Ack=1 win=16384 Len=0 M  |
| 15    | 0.000113  | 10.86.179.214 | 10.86.178.80  | TCP      | 57176 > 49 [ACK] Seq=1 Ack=1 win=5840 Len=0 TSV=258  |
| 16    | 0.101786  | 10.86.179.214 | 10.86.178.80  | TACACS   | Q: Authentication                                    |
| 17    | 0.002134  | 10.86.178.80  | 10.86.179.214 | TACACS   | R: Authentication                                    |
| 18    | 0.000118  | 10.86.179.214 | 10.86.178.80  | TCP      | 57176 > 49 [ACK] Seq=29 Ack=29 win=5840 Len=0 TSV=2  |
| 19    | 0.000113  | 10.86.179.214 | 10.86.178.80  | TACACS   | Q: Authentication                                    |
| 20    | 0.069255  | 10.86.178.80  | 10.86.179.214 | TACACS   | R: Authentication                                    |
| 21    | 0.000178  | 10.86.179.214 | 10.86.178.80  | TCP      | 57176 > 49 [FIN, ACK] Seq=54 Ack=47 win=5840 Len=0   |
| 22    | 0.000046  | 10.86.178.80  | 10.86.179.214 | TCP      | 49 > 57176 [ACK] Seq=47 Ack=55 win=65482 Len=0 TSV=  |
| 23    | 0.000061  | 10.86.178.80  | 10.86.179.214 | TCP      | 49 > 57176 [FIN, ACK] Seq=47 Ack=55 win=65482 Len=0  |
| 24    | 0.000107  | 10.86.179.214 | 10.86.178.80  | TCP      | 57176 > 49 [ACK] Seq=55 Ack=48 win=5840 Len=0 TSV=2  |

### Related Topics

- [Controlling Access to Cisco ANM, page 18-3](#)
- [How ANM Handles Role-Based Access Control, page 18-8](#)
- [Configuring Remote User Authorization Using a TACACS+ Server, page 18-45](#)

## Configuring Remote User Authorization Using a TACACS+ Server

You can configure a TACACS+ server to perform remote authorization of ANM users by configuring the authorization settings on the AAA server, which includes a unique ANM identifier, user role, and domain information. After you configure the TACACS+ server and ANM for remote authorization, when ANM authorizes a user, it sends an authorization request to the TACACS+ server, which returns with the names of the role and domains that are assigned to the user and defined on ANM.

### Guidelines and Restrictions

This topic includes the following guidelines and restrictions:

- You can configure ANM remote authorization on a TACACS+ server only. This feature is not available for AD/LDAPS or RADIUS.
- Cisco has approved the use of Cisco Secure Access Control System (ACS) only for remote authorization (Cisco has not approved the use of other TACACS+ servers for this purpose). The Cisco Secure ACS can accept an authorization request and send the following attribute in the request:

*ANM\_UniqueID=RoleName<space>Domain1<space>Domain2 . . .*

ANM/IP should be used as the TACACS\_Service/TACACS\_Protocol pair for an authorization request and response.

- You configure the user authorization attributes on the TACACS+ server using the following format:

*ANM\_UniqueID=RoleName<space>Domain1<space>Domain2 . . .*

The number of characters allowed for the ANM identifier, role, and domain information is limited to 160 characters, including spaces. You can use additional characters by adding a new ANMUnique ID entry for domain attributes as follows:

*ANM\_UniqueID\_1=RoleName<space>Domain1<space>Domain2*

*ANM\_UniqueID\_2=Domain3<space>Domain4*

*ANM\_UniqueID\_3=Domain5*

You must assign a different ANM identifier to each entry. Make sure that you configure the ANM organization with each ANM unique ID (see the [“Adding a New Organization” section on page 18-10](#)).

- You can define user authorization at the user level, user group level, or both. We recommend configuring authorization at the user group level, which allows you to assign a common set of authorization attributes to multiple users. When you configure the authorization attributes at both the user level and user group level, the user attributes take precedence over user group attributes. The procedure in this section includes all three configuration options.
- You can configure ANM to revert to local user authorization if the TACACS+ server becomes unavailable (see the [“Adding a New Organization” section on page 18-10](#)).

#### Prerequisites

ANM has a user organization that is configured for remote authorization (see the [“Adding a New Organization” section on page 18-10](#)).

This section includes the following topics:

- [Configuring Remote User Authorization Using Cisco Secure ACS Version 5.1, page 18-46](#)
- [Configuring Remote User Authorization Using Cisco Secure ACS Version 4.2, page 18-48](#)

## Configuring Remote User Authorization Using Cisco Secure ACS Version 5.1

You can use Cisco Secure ACS Version 5.1 for configuring a remote server to perform remote authorization of ANM users.



#### Note

This procedure describes only the ANM-specific attributes for creating user groups and users on Cisco Secure ACS. For information about configuring the other attributes, see the *User Guide for Cisco Secure Access Control Server* located on [Cisco.com](http://Cisco.com).

#### Procedure

- Step 1** From the Cisco Secure ACS HTML GUI, create a new Device Type to identify requests coming from the ANM server.

Do the following:

- a. From the sidebar menu, choose **Network Device Groups > Device Type**. The Device Group General window appears.
- b. In the Name field, enter **ANM**.
- c. (Optional) In the Description Field, enter a description. For example, ANM Server.
- d. In the Parent field, select **All Device Types**.
- e. Click **Submit**.

**Step 2** From the sidebar menu, choose **Network Device Groups > Network Devices and AAA Clients** to add a device. The Network Devices and AAA Clients window appears.

Do the following:

- a. In the Name field, enter **ANM**.
- b. From the Network Device Groups pane, do the following:
  - In the Location field, select **All Locations**.
  - In the Device Type field, select **All device Types:ANM**, which is the device type that you created in [Step 1](#).
- c. From the IP Address pane, do the following:
  - Choose the **IP Range(s)** radio button.
  - From the IP and Mask fields, enter the IP address and Mask to use and click **Add** to add the values to the IP/Mask table.
- d. From the Authentication Options pane, check the **TACACS+** check box.
- e. Click **Submit**.

**Step 3** From the sidebar menu, choose **Users and Identity Stores > Identity Groups** to create an Identity Group, which will be used later to map users to a specific role. The Identity Groups General window appears.

Do the following:

- a. In the Name field, enter a name for the group. For example, ACE-Admin.
- b. (Optional) In the Description field, enter a description for the group. For example, ACE devices admin.
- c. In the Parent field, select **ALL Groups:ANM-Groups**.
- d. Click **Submit**. The Identity Groups window appears.
- e. From the Identity Groups window, drill down and check the check box of an organization division/roll to associate with the group. For example, check the ACE-Groups check box (All Groups > ANM-Groups > ACE-Admin).
- f. Click **Create**.
- g. Repeat [Step 3](#) for every Identity Group that you need to create.

**Step 4** From the sidebar menu, choose **Users and Identity Stores > Internal Identity Stores > Users** to create a user. The Users General window appears.

Do the following:

- a. In the Name field, enter a user name.
- b. From the Status drop-down list, set the status for the user account. For example, **Enabled**.

- c. (Optional) In the Description field, enter a description for the user account.
- d. In the Identity Group field, select one of the groups created in [Step 3](#) to associate with the user.
- e. Click **Submit**.

**Step 5** From the sidebar menu, choose **Policy Elements > Authorization and Permissions > Device Administration > Shell Profiles** to create a shell profile for each Identity Group that you created in [Step 3](#). The shell is used to pass the user's role and domain list to the ANM server. The Shell Profiles window appears.

Do the following:

- a. Click the **Custom Attributes** tab.
- b. From the Attribute field, enter the attribute name, which is the ANM unique ID that you configured in the ANM organization on ANM. The ANM unique ID is followed by the role and domain names as a name/value pair (NV Pair) using the following format:

```
ANM_UniqueID=RoleName<space>Domain1<space>Domain2 . . .
```

For example:

```
ANM=Role1 Domain1 Domain2 Domain6
```

The *ANM\_UniqueID* variable must match the ANM unique ID that you configured in the ANM organization on ANM (see the “[Adding a New Organization](#)” section on page 18-10). This line cannot exceed 254 characters. If you need to use more than 254 characters, add another ANM Unique ID entry to specify the domains associated with the role specified in the first entry (for details, see the [Guidelines and Restrictions](#) associated with this topic).

- c. Click **Add**. The attribute name is added to the Manually Entered pane.
- d. Click **Submit**.

#### Related Topics

- [Managing User Roles, page 18-25](#)
- [Managing Domains, page 18-32](#)
- [Adding a New Organization, page 18-10](#)
- [Using an AAA Server for Remote User Authentication and Authorization, page 18-38](#)
- [Configuring Remote User Authorization Using Cisco Secure ACS Version 4.2, page 18-48](#)

## Configuring Remote User Authorization Using Cisco Secure ACS Version 4.2

You can use Cisco Secure ACS Version 4.2 for configuring a remote server to perform remote authorization of ANM users.



#### Note

This procedure describes only the ANM-specific attributes for creating user groups and users on Cisco Secure ACS. For information about configuring the other attributes, see the *User Guide for Cisco Secure Access Control Server* located on [Cisco.com](http://Cisco.com).

## Procedure

- Step 1** From the Cisco Secure ACS HTML GUI, configure the interface as follows:
- From the side menu bar, click **Interface Configuration**.  
The Interface Configuration window appears.
  - From the Advanced Options pane of the Interface Configuration window, check the **Per-user TACACS+/RADIUS Attributes** check box and click **Submit**.
  - From the New Services pane of the Interface Configuration window, check the **Service** and **Protocol** check boxes and add a new service as follows:
    - In the Service text box, enter **ANM**.
    - In the Protocol text box, enter **IP**.
  - Click **Submit**.
- Step 2** Do one of the following:
- Configure a user group for the users that you create—Go to [Step 3](#).
  - Configure a user only—Skip to [Step 4](#).
- Step 3** To configure a user group, do the following:
- From the side menu bar, click **Group Setup**.  
The Group Setup window appears.
  - From the Group Setup window, create a user group and set the following ANM attributes:
    - Check the **ANM IP service** check box.
    - Check the **Custom attributes** check box and enter the ANM unique identifier followed by the role and domain names as a name/value pair (NV Pair) in the Custom Attributes pane using the following format:  
*ANM\_UniqueID=RoleName<space>Domain1<space>Domain2 . . .*  
For example:  
`ANM=Role1 Domain1 Domain2 Domain6`

The *ANM\_UniqueID* variable must match the ANM unique ID that you configured in the ANM organization on ANM (see the “[Adding a New Organization](#)” section on page 18-10). This line cannot exceed 160 characters. If you need to use more than 160 characters, add another ANM Unique ID entry to specify the domains associated with the role specified in the first entry (for details, see the [Guidelines and Restrictions](#) associated with this topics).
  - Click **Submit**.  
The user group is now ready for adding users (go to [Step 4](#)).
- Step 4** Create a user as follows:
- From the side menu bar, click **User Setup**.  
The User Setup window appears.
  - To assign the user to the user group that you created in [Step 3](#), from the User Setup window, choose the group from the following drop-down list: Group to which the user is assigned.  
Skip this step if the user is not to be included in a user group.

c. Configure the ANM-specific attributes. Perform this step for either of the following reasons; otherwise, skip this step:

- The user is not to be included in a user group.
- The user is included in a user group but requires different authorization attributes (user attributes have precedence over user group attributes).

To configure the ANM-specific attributes, from the User Setup window, do the following:

- Check the **ANM IP service** check box.
- Check the **Custom attributes** check box, enter the ANM unique ID and role and domain names as NV Pair in the Custom Attributes pane using the following format:

```
ANM_UniqueID=RoleName<space>Domain1<space>Domain2 . . .
```

For example:

```
ANM=Role1 Domain1 Domain2 Domain6
```

The *ANM\_UniqueID* variable must match the ANM Unique ID that you configured in the ANM organization (see the “[Adding a New Organization](#)” section on page 18-10). This line cannot exceed 160 characters. If you need to use more than 160 characters, add another ANM Unique ID entry to specify the domains associated with the role (for details, see this topic’s [Guidelines and Restrictions](#)):

d. Click **Submit**.

#### Related Topics

- [Managing User Roles, page 18-25](#)
- [Managing Domains, page 18-32](#)
- [Adding a New Organization, page 18-10](#)
- [Using an AAA Server for Remote User Authentication and Authorization, page 18-38](#)
- [Configuring Remote User Authorization Using Cisco Secure ACS Version 5.1, page 18-46](#)

## Disabling the ANM Login Window Change Password Feature

When you log into ANM from the login window, you have the option to change your password at that time. This feature is enabled by default; however, you can disable it by modifying the ANM `cs-config.properties` file. When disabled, the login window no longer displays the Change Password hyperlink.

#### Procedure

**Step 1** Disable the Change Password option on the ANM login window as follows:

- ANM Server—Open the `/opt/CSCOanm/etc/cs-config.properties` file in a text editor and change the state of the following line from true to false:

```
changeANMPassword.enable=false
```

- ANM Virtual Appliance—Enter the following command:  
**anm-property set changeANMPassword.enable false**

**Step 2** Restart ANM as follows:

- ANM Server—Enter the following command:  
**/opt/CSCOanm/bin/anm-tool restart**
  - ANM Virtual Appliance—Enter the following command:  
**anm-tool restart**
- 

#### Related Topics

- [Logging In To the Cisco Application Networking Manager, page 1-5](#)
- [Changing Your Account Password, page 1-6](#)

## Managing ANM

When you choose **Admin > ANM Management**, you can display the following information:

- ANM—Allows you to check the status of your ANM server. See the “[Checking the Status of the ANM Server](#)” section on page 18-52.
- License Management—Displays the ANM license information. See the “[Using ANM License Manager to Manage ANM Server or Demo Licenses](#)” section on page 18-54.
- Statistics—Displays the ANM server statistics. See the “[Displaying ANM Server Statistics](#)” section on page 18-56.
- Statistics Collection—Allows you to enable or disable ANM server statistic collection. See the “[Configuring ANM Statistics Collection](#)” section on page 18-57.
- Audit Log Settings—Allows you to determine how long audit log records are kept. See the “[Configuring Audit Log Settings](#)” section on page 18-58.
- Change Audit Log—Displays ANM server logs. See the “[Displaying Change Audit Logs](#)” section on page 18-61.
- Auto Sync Settings—Allows you to allow ANM to automatically sync with CLI when it detects out of band changes between itself and the ACE. See the “[Configuring Auto Sync Settings](#)” section on page 18-61.
- Advanced Settings—Allows you to set the following advanced settings for ANM:
  - Enable or disable overwrite of the ACE logging device-id while setting up syslog for autosync using `Config > Devices > Setup Syslog for Autosync`.
  - Enable or disable write memory on a `Config > Operations` configuration.
  - Enable features for displaying details about real or virtual servers.
  - Enable mobile notifications from ANM.
  - Hide syslog buffer details in the Dashboard pane Top 10 Current Resources.
  - Display all virtual servers that have class-map and policy-map definitions in the monitoring and operations windows.

See the “[Configuring Advanced Settings](#)” section on page 18-62.

- Virtual Center Plugin Registration—Allows you register the ANM plugin to integrate ANM in a VMware virtual data center environment. See [Appendix B, “Using the ANM Plug-In With Virtual Data Centers.”](#)

## Checking the Status of the ANM Server



### Note

Your user role determines whether you can use this option.

You can check if ANM has a backup server and to view the server status.

The ANM server can be configured as either of the following:

- A non-HA ANM. The non-HA ANM consists of only one host and is referred to as a standalone ANM.
- An HA (high availability or fault-tolerant) ANM, which consists of two hosts: an active ANM and a standby ANM. An HA ANM has a virtual IP address that is always assigned to the active ANM. Users log into this virtual IP address—they never log into the real IP addresses of the hosts. In addition, an HA ANM has a secondary NIC and IP address on each host over which “heartbeat” messages are used to arbitrate which host is active and which is standby.

### Procedure

**Step 1** Choose **Admin > ANM Management > ANM**.

The ANM Server status window appears. This window contains the following information:

**Table 18-12 ANM Server Status Information**

| Field                            | Description                                                                                                                                                                                                                                                                                                                                                                                                                                                                                                                                                                                                                                                                                                                                                                                                                                                                      |
|----------------------------------|----------------------------------------------------------------------------------------------------------------------------------------------------------------------------------------------------------------------------------------------------------------------------------------------------------------------------------------------------------------------------------------------------------------------------------------------------------------------------------------------------------------------------------------------------------------------------------------------------------------------------------------------------------------------------------------------------------------------------------------------------------------------------------------------------------------------------------------------------------------------------------|
| HA Replication State             | HA replication state as follows: <ul style="list-style-type: none"> <li>• OK—This is an HA ANM and is running properly.</li> <li>• Standalone—This is a non-HA ANM; therefore, the HA attributes and operations are not meaningful.</li> <li>• Stopped—This is HA ANM and this state indicates that the active ANM is copying its entire database contents to the standby ANM. This normally happens when the standby ANM initially starts up or it has been stopped and restarted later. This process normally takes a few seconds to a few minutes depending on the size of the ANM configuration data and monitoring data. During this time, the active ANM cannot be stopped, restarted, or failover.</li> <li>• Failed—This is an HA ANM and database replication cannot proceed. Most likely this is because the standby ANM is unresponsive or is unreachable.</li> </ul> |
| Version                          | Version of the ANM software.                                                                                                                                                                                                                                                                                                                                                                                                                                                                                                                                                                                                                                                                                                                                                                                                                                                     |
| Build Number and Build Timestamp | Build identification information.                                                                                                                                                                                                                                                                                                                                                                                                                                                                                                                                                                                                                                                                                                                                                                                                                                                |
| Time Server Started              | Date and time the ANM server started.                                                                                                                                                                                                                                                                                                                                                                                                                                                                                                                                                                                                                                                                                                                                                                                                                                            |



Table 18-12 ANM Server Status Information (continued)

| Field                        | Description                                                                                                                                                                                                                                                                                                                                                                                                                                                                                                                                                                                                                                                                                                                                                                                                                                                         |
|------------------------------|---------------------------------------------------------------------------------------------------------------------------------------------------------------------------------------------------------------------------------------------------------------------------------------------------------------------------------------------------------------------------------------------------------------------------------------------------------------------------------------------------------------------------------------------------------------------------------------------------------------------------------------------------------------------------------------------------------------------------------------------------------------------------------------------------------------------------------------------------------------------|
| Virtual IP Address           | Virtual IP address that associates with the active host. This IP address must be on the same subnet as the primary IP addresses of both Node 1 and Node 2.                                                                                                                                                                                                                                                                                                                                                                                                                                                                                                                                                                                                                                                                                                          |
| Active Name                  | Name of Node 1, which can be displayed by issuing the <b>uname -n</b> command on the host.                                                                                                                                                                                                                                                                                                                                                                                                                                                                                                                                                                                                                                                                                                                                                                          |
| Active IP                    | IP address used by Node 1 for normal (non-heartbeat related) communication. This IP address must be on the same subnet as the primary address for Node 2.                                                                                                                                                                                                                                                                                                                                                                                                                                                                                                                                                                                                                                                                                                           |
| Active Heartbeat IP          | IP address associated with the crossover network interface for Node 1. This IP address must be on the same subnet as the Heartbeat IP address for Node 2.                                                                                                                                                                                                                                                                                                                                                                                                                                                                                                                                                                                                                                                                                                           |
| Standby Name                 | Name of Node 2, which can be returned by issuing the <b>uname -n</b> command on the host.                                                                                                                                                                                                                                                                                                                                                                                                                                                                                                                                                                                                                                                                                                                                                                           |
| Standby IP                   | IP address used by Node 2 for normal (non-heartbeat related) communication. This IP address must be on the same subnet as the primary IP address for Node 1.                                                                                                                                                                                                                                                                                                                                                                                                                                                                                                                                                                                                                                                                                                        |
| Standby Heartbeat IP         | IP address associated with the crossover network interface for Node 2. This IP address must be on the same subnet as the Heartbeat IP address for Node 1.                                                                                                                                                                                                                                                                                                                                                                                                                                                                                                                                                                                                                                                                                                           |
| License Server State         | <p>License server state as follows:</p> <ul style="list-style-type: none"> <li>OK—There is a valid license on the host.</li> <li>Invalid—The host either contains an invalid license or there is no license present.</li> <li>Unknown—It is not possible to communicate with the host's license manager, therefore, the license state is unknown.</li> </ul> <p><b>Note</b> The Unknown and Invalid states will not display for the active (local) ANM. If the standby ANM has an Invalid license state, you should install a valid license. If the standby ANM has an Unknown license state, check that the standby ANM has been installed correctly.</p> <ul style="list-style-type: none"> <li>DEMO—Used for the demonstration purposes. It lasts for 30, 60, or 90 days from the issue day of the license. It allows you to use all features.</li> </ul>        |
| Standby License Server State | <p>Standby license server state as follows:</p> <ul style="list-style-type: none"> <li>OK—There is a valid license on Node 2.</li> <li>Invalid—Node 2 either contains an invalid license or there is no license present.</li> <li>Unknown—It is not possible to communicate with the license manager on Node 2, therefore, the license state is unknown.</li> </ul> <p><b>Note</b> The Unknown and Invalid states will not display for the active (local) ANM. If the standby ANM has an Invalid license state, you should install a valid license. If the standby ANM has an Unknown license state, check that the standby ANM has been installed correctly.</p> <ul style="list-style-type: none"> <li>DEMO—Used for the demonstration purposes. It lasts for 30, 60, or 90 days from the issue day of the license. It allows you to use all features.</li> </ul> |

#### Related Topics

- [Using ANM License Manager to Manage ANM Server or Demo Licenses, page 18-54](#)
- [Displaying ANM Server Statistics, page 18-56](#)

- [Configuring ANM Statistics Collection, page 18-57](#)

## Using ANM License Manager to Manage ANM Server or Demo Licenses

You can use the ANM License Manager feature to manage to the ANM license required to use ANM beyond the 90-day evaluation period.

**Note**

Your user role determines whether you can use this option.

[Table 18-13](#) describes the available ANM licenses and their purpose.

**Table 18-13 ANM License Descriptions**

| License Name     | Description                                                                                                                                                  |
|------------------|--------------------------------------------------------------------------------------------------------------------------------------------------------------|
| ANM-DEMO or DEMO | Used for demonstration purposes. It lasts for 90 days from the issue day of the license and allows you to use all features.                                  |
| ANM-SERVER-50-K9 | Used to allow access to the ANM server. Beginning with ANM 4.1, ANM does not perform a license version number check; it will accept any version ANM license. |

ANM licenses are available at no charge. When you install the ANM software, you are provided with a 90-day evaluation period that does not require a license; however, to continue using ANM beyond the evaluation period, you must install the ANM server license as follows:

- To install the server license *before* the evaluation period expires, you can use ANM License Manager (see the [“Displaying and Adding ANM Licenses to License Management”](#) section on page 18-54). Optionally, you can use the CLI to install the license as described in the next bullet.
- To install the server license *after* the evaluation period expires, you must use the CLI (see the [Installation Guide for Cisco Application Networking Manager 5.2](#) or the [Installation Guide for the Cisco Application Networking Manager 5.2 Virtual Appliance](#) for instructions).

**Note**

ANM uses TCP port 10444 for the ANM License Manager. For other port numbers, see [Appendix A, “ANM Ports Reference.”](#)

This section includes the following topics:

- [Displaying and Adding ANM Licenses to License Management, page 18-54](#)
- [Removing an ANM License File, page 18-55](#)

## Displaying and Adding ANM Licenses to License Management

**Note**

Your user role determines whether you can use this option.

You can add a license to the license manager. You need to add a license before the 90-day evaluation period expires or when you convert from a demo license to an ANM server license.

**Guidelines and Restrictions**

The license manager does not display information related to the 90-day evaluation period that allows you to use ANM immediately after you install the software. When there are 10 days or less remaining to the evaluation period, ANM issues daily warnings that the evaluation period is about to expire. You must install the ANM server license to continue using ANM.

**Procedure**

**Step 1** Choose **Admin > ANM Management > License Management**.

The Licenses table appears. [Table 18-14](#) describes the contents of this table.

**Table 18-14 License Files**

| Field          | Description                                                                                                                                                                                                                                                                                                                                                                                                          |
|----------------|----------------------------------------------------------------------------------------------------------------------------------------------------------------------------------------------------------------------------------------------------------------------------------------------------------------------------------------------------------------------------------------------------------------------|
| File Name      | Name of the ANM server or demo license file that you have installed on the ANM host.                                                                                                                                                                                                                                                                                                                                 |
| Install Status | Status of the license file. Any licensing errors display here. For ANM server, if errors display, see the <a href="#">“Removing an ANM License File”</a> section on page 18-55 for details about how to remove this file and import a working file. You cannot remove a license from ANM Virtual Appliance; however, a license that displays in error is not a problem as long as a valid license is also installed. |

**Step 2** To add new license, from the Licenses table, click **Add**.

The New License window appears.

**Step 3** In the New License window, click **Browse** to locate the new license name.

Use the browser to choose the license file.

**Step 4** Click **Upload** to install the license you added onto the ANM Server or **Cancel** to exit.

The license file appears in the License Files table.

From the License Files table you can see the Install Status of the license file and if there are any errors.

**Related Topics**

- [ANM Licenses, page 1-7](#)
- [Managing ACE Licenses, page 6-36](#)
- [Using ANM License Manager to Manage ANM Server or Demo Licenses, page 18-54](#)
- [Removing an ANM License File, page 18-55](#)

**Removing an ANM License File**

For ANM server, if your license file does not work in ANM due to file errors, you need to remove it from the ANM host and request another license file from Cisco. There is no ANM GUI remove license command. You must remove the license from the operating system by deleting the file.

### Guidelines and Restrictions

You can remove a license file from ANM server; however, you cannot remove a license file from ANM Virtual Appliance. If you are using ANM Virtual Appliance and have a license that displays in error, it is not an issue as long as a valid license is also installed.

### Procedure

---

**Step 1** Log in as the root user.

**Step 2** To remove the license file, enter the following:

```
rm /opt/CSCOanm/etc/license/<ANM_LICENSE_FILE>
```

The license file is removed from the ANM host.

**Step 3** Restart ANM to allow it to update the licenses table data.

To restart ANM, see instructions in the [Installation Guide for Cisco Application Networking Manager 5.2](#).

To request another license from Cisco to replace the one that had errors, open a service request using the [TAC Service Request Tool](#) or call the Technical Assistance Center. Add the license into ANM.

---

### Related Topics

- [ANM Licenses, page 1-7](#)
- [Using ANM License Manager to Manage ANM Server or Demo Licenses, page 18-54](#)
- [Displaying and Adding ANM Licenses to License Management, page 18-54](#)

## Displaying ANM Server Statistics

You can display ANM statistics (for example, CPU, disk, and memory usage on the ACE).

### Procedure

---

**Step 1** Choose **Admin > ANM Management > Statistics**.

The statistics viewer displays the fields in [Table 18-15](#).

**Table 18-15** ACE Server Statistics

| Name        | Description                                                                                                                                                                                                                                                                                                                                                                                                                                                                                                                                 |
|-------------|---------------------------------------------------------------------------------------------------------------------------------------------------------------------------------------------------------------------------------------------------------------------------------------------------------------------------------------------------------------------------------------------------------------------------------------------------------------------------------------------------------------------------------------------|
| Owner       | Process where statistics are collected.                                                                                                                                                                                                                                                                                                                                                                                                                                                                                                     |
| Statistic   | Statistical information, includes the following: <ul style="list-style-type: none"> <li>• CPU Usage—Overall ACE CPU busy percentage in the last 5-minute period.</li> <li>• Disk Usage—Amount of disk space being used by the ANM server or ACE device.</li> <li>• Memory Usage—Amount of memory being used by the ANM server or ACE hardware.</li> <li>• Process Uptime—Amount of time since this system was last initialized, or the amount of time since the network management portion of the system was last reinitialized.</li> </ul> |
| Value       | Value of the statistic.                                                                                                                                                                                                                                                                                                                                                                                                                                                                                                                     |
| Description | Information that the statistic gathered.                                                                                                                                                                                                                                                                                                                                                                                                                                                                                                    |

**Related Topics**

- [Checking the Status of the ANM Server, page 18-52](#)
- [Configuring ANM Statistics Collection, page 18-57](#)

## Configuring ANM Statistics Collection

You can enable ACE server statistics polling.

**Procedure**

- 
- Step 1** Choose **Admin > ANM Management > Statistics Collection**.
- The Primary Attributes configuration window appears.
- Step 2** In the Polling Stats field, click **Enable** to start background polling or **Disable** to stop background polling.
- Step 3** In the Background Polling Interval field, choose the polling interval appropriate for your networking environment.
- Step 4** Click **Deploy Now** to save your entries.
- 

**Related Topics**

- [Checking the Status of the ANM Server, page 18-52](#)
- [Displaying ANM Server Statistics, page 18-56](#)

## Configuring Audit Log Settings

You can determine how long audit logs are kept in the database.

Audit Log Purge Settings allow you to specify the following:

- How many days the log records in the database will be kept (default is 31).
- The maximum of log records that will be stored in the ANM database (default 100,000).

Audit Log File Purge Settings allows you to specify the following:

- The number of days worth of log record files that will be stored in the ANM database (default 31 days).
- The number of daily rolling files that will be stored in the ANM database (default 10 files each day, allowable file size is 2 Megabytes and is not configurable).

### Procedure

---

**Step 1** Choose **Admin > ANM Management > Audit Log Settings**.

The Audit Log Settings configuration window appears. Audit Log Purge Settings fields let you determine whether audit log table entries will be deleted after a certain number of days (default is 31 days) or after the table entries reach a certain size (default is 100 entries).

**Step 2** Enter the greatest number of days that you would like entries to be retained in the **Number of Days** field.

**Step 3** Enter the maximum amount of log records to be stored in the ANM database in the audit log tables in the **Number of Entries (Thousand)** field (default 100,000).

Audit Log File Purge Settings fields let you determine whether to retain log files according by age (default is 31 days) or by amount saved in a given day (default is 10 entries).

**Step 4** Enter the greatest number of days that you would like entries to be retained in **Number of Days** field.

**Step 5** Enter the greatest number of log files that you would like retained in the **Number of Daily Rolling Log Files** field.

**Step 6** Do one of the following:

- Click **Reset to Default** to erase changes and restore the default values.
  - Click **Save Now** to save your entries.
- 

### Related Topics

- [Performing Device Audit Trail Logging, page 18-59](#)
- [Displaying Change Audit Logs, page 18-61](#)

## Performing Device Audit Trail Logging

Certain configuration and deployment changes are logged in the ANM database and available for displaying according to your role, which is restricted by the ACE virtual context as established by RBAC. Log files are located `/var/lib/anm/events/date/audit`, where *date* is in YYYYMMDD format (for example, 20091109 for November 9, 2009).

The following changes are logged in ANM:

- Configuration deployments to devices
- Device or virtual context synchronization operations
- Device or virtual context import and deletions
- Creation/updates/deletion of the to-be-deployed later by the virtual server

### Procedure

---

**Step 1** Choose **Config > device(s) to view > Device Audit**.

ANM displays all operations described above on the specified devices. See [Table 18-16](#) for a description of the displayed information, some of which is extracted from the syslog.

You can sort information in the table by clicking on a column heading, adjust the viewable time range using the drop-down list, and export the table for reporting and troubleshooting purposes.

**Table 18-16 Config > Device Audit Fields**

| Field     | Description                                                                                                                                                                                                                                                                                                                                                                                                                                                                                                                                                                                                                                                                                                                                                                                     |
|-----------|-------------------------------------------------------------------------------------------------------------------------------------------------------------------------------------------------------------------------------------------------------------------------------------------------------------------------------------------------------------------------------------------------------------------------------------------------------------------------------------------------------------------------------------------------------------------------------------------------------------------------------------------------------------------------------------------------------------------------------------------------------------------------------------------------|
| Time      | ANM server timestamp when the action is complete.                                                                                                                                                                                                                                                                                                                                                                                                                                                                                                                                                                                                                                                                                                                                               |
| Client IP | Source IP address initiating action.                                                                                                                                                                                                                                                                                                                                                                                                                                                                                                                                                                                                                                                                                                                                                            |
| User      | Email address in the following format: <i>username@organization name</i> for example, admin@cisco.com.                                                                                                                                                                                                                                                                                                                                                                                                                                                                                                                                                                                                                                                                                          |
| Device    | Device or ACE virtual context target of user action.                                                                                                                                                                                                                                                                                                                                                                                                                                                                                                                                                                                                                                                                                                                                            |
| Action    | The action name of the operation, including the following: <ul style="list-style-type: none"> <li>• add staging object</li> <li>• allocate vlan</li> <li>• change credential</li> <li>• create</li> <li>• create vc</li> <li>• create vc-template</li> <li>• create-vip</li> <li>• delete</li> <li>• delete-vip</li> <li>• deploy staging object</li> <li>• disable polling</li> <li>• enable polling</li> <li>• export-certificate-key</li> <li>• generate-csr</li> <li>• import device</li> <li>• import-certificate-key</li> <li>• import module</li> <li>• remove device</li> <li>• remove vc</li> <li>• restart monitoring</li> <li>• syncup config</li> <li>• syslog-setup</li> <li>• unmanage module</li> <li>• update</li> <li>• update staging object</li> <li>• update-vip</li> </ul> |
| Target    | Name of the target configuration object (for example, Serverfarm sf1).                                                                                                                                                                                                                                                                                                                                                                                                                                                                                                                                                                                                                                                                                                                          |
| Status    | Indicates whether operation succeeded or not.                                                                                                                                                                                                                                                                                                                                                                                                                                                                                                                                                                                                                                                                                                                                                   |



**Table 18-16** Config > Device Audit Fields (continued)

| Field  | Description                                                                                                                                                                                                                 |
|--------|-----------------------------------------------------------------------------------------------------------------------------------------------------------------------------------------------------------------------------|
| Detail | CLI commands sent to the device and/or error messages. ANM truncates the display if the number of characters for the CLI commands exceeds 100,000 characters. You can view the complete audit output in the audit log file. |

**Related Topics**

- [Configuring Audit Log Settings, page 18-58](#)
- [Displaying Change Audit Logs, page 18-61](#)

## Displaying Change Audit Logs

You can display ANM change audit logs for example, user login attempts, create/update/delete objects such as RBAC, Global Resource Class, Credential, device group, and threshold setting. Any key or change related activities to the ANM server will be logged and viewed according to your role.

To display the change audit logs, choose **Admin > ANM Management > ANM Change Audit Log**. The audit log displays the fields in [Table 18-17](#).

**Table 18-17** Server Audit Log

| Name      | Description                                                                                                           |
|-----------|-----------------------------------------------------------------------------------------------------------------------|
| Time      | Server time stamp when user action is complete.                                                                       |
| Client IP | IP address where action originated.                                                                                   |
| User      | Email address in the following format: <i>username@organization name</i> for example, admin@cisco.com.                |
| Message   | Boilerplate text descriptive of action taken, usually self-explanatory (for example “User authentication succeeded.”) |

**Related Topics**

- [Checking the Status of the ANM Server, page 18-52](#)
- [Configuring Audit Log Settings, page 18-58](#)
- [Performing Device Audit Trail Logging, page 18-59](#)

## Configuring Auto Sync Settings

You can configure ANM server auto sync settings.

**Procedure**

- 
- Step 1** Choose **Admin > ANM Management > ANM Auto Sync Settings**.  
The Setup ANM Auto-Sync Settings window appears.
- Step 2** In the ANM Auto-Sync field of the Setup ANM Auto-Sync Settings window, do one of the following:

- Click **Enable** to have the ANM server automatically sync with ACE CLI when it detects out of band changes.
  - Click **Disable** to have the ANM server warn but not take independent action when it detects out of band changes between the server and ACE CLI.
- Step 3** In the Polling Interval field, choose the polling interval you want the ANM server to employ.
- Step 4** Click **OK** to save your entries.
- 

**Related Topic**

[Synchronizing Virtual Context Configurations, page 6-105](#)

## Configuring Advanced Settings

This section discusses the Advanced Settings window.

This section includes the following topics:

- [Configuring the Overwrite ACE Logging device-id for the Syslog Option, page 18-62](#)
- [Configuring the Enable Write Mem on the Config > Operations Option, page 18-63](#)
- [Enabling the ACE Real Server Details Popup Window Option, page 18-64](#)
- [Enabling the ACE Server Farm Details Popup Window Option for Virtual Servers, page 18-65](#)
- [Enable Mobile Notifications from ANM, page 18-66](#)
- [Managing the Syslog Buffer Display in the All Devices Dashboard, page 18-66](#)
- [Managing the Display of Virtual Servers in the Operations and Monitoring Windows, page 18-66](#)

### Configuring the Overwrite ACE Logging device-id for the Syslog Option

You can overwrite the ACE logging device-id.

By default, ANM Autosync relies on the ACE logging device-id to be of type “String.” A device-id setting adds explicit information that is appended to the syslog message and is used by ANM to identify the source of a syslog message. If you configure ANM to manage syslog settings for Autosync on a virtual context (Config > Devices > Setup Syslog for Autosync) and the logging device-id is defined as something other than type “String” for the context, the operation fails and ANM displays “Syslog device is already configured for other purpose.”

You can instruct ANM to overwrite the ACE logging device-id when you enable the synchronization of syslog messages setup of syslog for Autosync from the ACE. If any of the contexts that you are trying to set up a syslog the syslog for Autosync has a device-id setup for a type other than string, ANM will override the device-id with the ANM preferred string.

**Procedure**

- 
- Step 1** Choose **Admin > ANM Management > Advanced Settings**.  
The Advanced Settings configuration window appears.
- Step 2** In the Overwrite ACE Logging Device ID field of the Advanced Settings configuration window, do one of the following:

- Click **Enable** to overwrite the logging device-id during Setup Syslog for Autosync.
- Click **Disable** to prevent overwriting the existing logging device-id if it has been previously set up with a type other than string. If the selected context from Setup Syslog for Autosync already has a device-id that is set up with a type other than string, then the operation reports an error and ANM does not overwrite this setting. This is the default setting.

**Step 3** Click **OK** to accept your entries on the Advanced Settings configuration window.

---

#### Related Topics

- [Enabling a Setup Syslog for Autosync for Use With an ACE, page 5-27](#)

## Configuring the Enable Write Mem on the Config > Operations Option

You can configure the Enable Write Mem on the Config > Operations feature.

By default, ANM initiates a **write memory** command action after you activate or suspend changes on the ACE, CSM, or CSS through the different ANM Operations Pages (Config > Operations). In certain situations, such as those that involve large configurations, a **write memory** action can take an extended period of time to complete. In this case, the ANM GUI may time out. If a **write memory** action is not performed before a device reload occurs, the changes will be lost. You can instruct ANM to enable or disable write memory on a Config > Operations configuration.



#### Note

The **write memory** command is the same as the **copy running-config startup-config** command; both commands save changes to the configuration.

---



#### Note

The CSS Expert mode must be disabled if you wish to disable the Write Mem on Config > Operations feature. The Expert mode allows you to turn the CSS confirmation capability on or off; turning Expert mode on disables the CSS from prompting for confirmation when configuration changes are made. If Expert mode is enabled on the CSS, this function will cause the CSS to perform an implicit write memory action after each operational change.

---

#### Procedure

---

**Step 1** Choose **Admin > ANM Management > Advanced Settings**.

The Advanced Settings configuration window appears.

**Step 2** In the Enable Write Mem on Config > Operations field of the Advanced Settings configuration window, do one of the following:

- Click **Enable** to instruct ANM to activate the write memory action on the Config > Operations window. This is the default.
- Click **Disable** to deactivate the write memory action on the Config > Operations window. This option will require you to periodically access the CLI for the ACE context, the CSM, or the CSS and enter the **write memory** command to commit the change to the startup-configuration file.

**Step 3** Click **OK** to accept your entries on the Advanced Settings configuration window.

---

## Enabling the ACE Real Server Details Popup Window Option

You can enable the ACE real server Details popup window option that displays real server details by issuing the **show rserver detail** command to the selected ACE in the real servers operation window (Config > Operations > Real Servers). This top level real server **show** command displays information that includes total statistics about every serverfarm real server associated with the selected rserver. The ACE real server Details popup window feature is disabled by default.



### Caution

When you enable the ACE real server Details popup window option, the information that displays in the Details popup window may exceed the RBAC restrictions assigned to the user.

The following example shows how enabling the ACE real server Details popup window option in ANM can display information that may exceed the RBAC restrictions assigned to a user. In the following CLI example, the ACE displays information for rbac-test:80 and rbac-test:443 in response to the **show rserver rbac-test detail** command:

```
switch/Admin# sh rserver rbac-test detail

rserver : rbac-test, type: HOST
state : OUTFSERVICE

 real weight state -----connections-----
 +-----+-----+-----+-----+-----+
serverfarm: sf-rbac-test
 0.0.0.0:80 8 OUTFSERVICE 0 0
serverfarm: sf1-rbac-test
 0.0.0.0:443 8 OUTFSERVICE 0 0
switch/Admin(config-sfarm-host-rs)#
```

When you enable the Details option in ANM, the popup window displays the same information even if the user requesting the information is configured in ANM to have access to rbac-test:80 only.

### Procedure

**Step 1** Choose **Admin > ANM Management > Advanced Settings**.

The Advanced Settings configuration window appears.

**Step 2** In the Enable Details popup window for Config > Operations > Real Servers field of the Advanced Settings configuration window, do one of the following:

- Click **Enable** to enable the ACE real server Details popup window option.
- Click **Disable** to disable the ACE real server Details popup window option. This is the default.

**Step 3** Click **OK** to accept your entries on the Advanced Settings configuration window.

### Related Topics

- [Displaying Real Servers, page 8-18](#)

## Enabling the ACE Server Farm Details Popup Window Option for Virtual Servers

You can enable the ACE Server Farm Details popup window option that displays details about the server farms associated with a virtual server. When you enable this feature, the server farms listed in the virtual servers operation window (Config > Operations > Virtual Servers) become hyperlinks that open a popup details window. When you click a server farm associated with a virtual server, ANM issues the **show serverfarm detail** command to the ACE and displays the command output in the popup window.

This top level virtual server **show** command displays information that includes statistical information related to the real servers associated with the server farm. The ACE Server Farm Details popup window feature is disabled by default.



### Caution

When you enable the ACE Server Farm Details popup window option, the information that displays in the popup window may exceed the RBAC restrictions assigned to the user. For example, information related to real servers that a user is not permitted to access may display.

The following is an example of the **show serverfarm test-sf detail** command output:

```
serverfarm : test-sf, type: REDIRECT
total rservers : 1
active rservers: 0
description : -
state : INACTIVE
predictor : ROUNDROBIN
failaction : -
back-inservice : 0
partial-threshold : 0
num times failover : 0
num times back inservice : 0
total conn-dropcount : 0

 real weight state -----connections-----
 +-----+-----+-----+-----+-----+-----+
rserver: anm-vm-119
 0.0.0.0:0 8 OUTFSERVICE 0 0 0
 description : -
 max-conns : - , out-of-rotation count : -
 min-conns : -
 conn-rate-limit : - , out-of-rotation count : -
 bandwidth-rate-limit : - , out-of-rotation count : -
 retcode out-of-rotation count : -
```

### Procedure

**Step 1** Choose **Admin > ANM Management > Advanced Settings**.

The Advanced Settings configuration window appears.

**Step 2** In the “Enable Details popup window for Config > Operations > Virtual Servers” field of the Advanced Settings configuration window, do one of the following:

- Click **Enable** to enable the ACE Server Farm Details popup window option.
- Click **Disable** to disable the ACE Server Farm Details popup window option. This is the default.

**Step 3** Click **OK** to accept your entries on the Advanced Settings configuration window.

**Related Topic**

[“Displaying Virtual Servers” section on page 7-81](#)

**Enable Mobile Notifications from ANM**

You can enable ANM to send alarm notifications to supported mobile devices that are using the ANM Mobile app. By default, this feature is disabled. For details about the enabling this advanced setting, see the [“Globally Enabling or Disabling Mobile Device Notifications” section on page 18-69](#).

**Related Topics**

- [Globally Enabling or Disabling Mobile Device Notifications, page 18-69](#)
- [Configuring Alarm Notifications on ANM, page 17-57](#)
- [Administering the ANM Mobile Feature, page 18-67](#)
- [Chapter 19, “Using ANM Mobile”](#)

**Managing the Syslog Buffer Display in the All Devices Dashboard**

You can choose to show or hide the syslog buffer information that displays in the Top 10 Current Resources pane of the All Devices Dashboard window (**Monitor > Devices > Dashboard > All Devices**). You may want to hide this information because it will always show 100 percent after the buffer becomes full and starts to wrap.

**Procedure**

- 
- Step 1** Choose **Admin > ANM Management > Advanced Settings**.
- The Advanced Settings configuration window appears.
- Step 2** Check the **Hide 'Syslog Buffer' details in 'Top 10 Current Resources' in Dashboard Pane (All devices dashboard)** check box to hide the syslog information. Uncheck the check box to display the syslog information.
- Step 3** Click **OK** to accept your entries on the Advanced Settings configuration window.
- Step 4** (Optional) Choose **Monitor > Devices > Dashboard > All Device** to view the change to the Top 10 Current Resources pane. For more information, see the [“Top 10 Current Resources Table” section on page 17-20](#).
- 

**Managing the Display of Virtual Servers in the Operations and Monitoring Windows**

You can choose to show only ANM recognized virtual servers or all virtual servers in the virtual server windows for Config Operations (Config > Operations > Virtual Servers) and Monitor Devices (Monitor > Devices > Load Balancing > Virtual Servers).

ANM recognized virtual servers are virtual servers that match ANM’s virtual server definition (see [“Virtual Server Configuration and ANM” section on page 7-2](#)). When you have the display set to display all virtual servers, it includes virtual servers that match ANM’s virtual server definition and those that do not match this definition but that ANM can recognize as virtual servers using SNMP polling

### Procedure

- 
- Step 1** Choose **Admin > ANM Management > Advanced Settings**.
- The Advanced Settings configuration window appears.
- Step 2** Do one of the following to specify the virtual server types that display in the Operations and Monitor windows for virtual servers:
- Check the **Display All Virtual Servers in Monitoring & Operations page (Virtual Servers that have class-map/policy-map definitions)** check box to display virtual servers that match ANM's virtual server definition and those that do not match this definition but that ANM can recognize as virtual servers using SNMP polling.
- When this option is checked, the virtual server windows for Config Operations and Monitor Devices includes a display toggle button () located above the table that allows you to change from viewing all virtual servers to viewing only ANM recognized virtual servers.
- Uncheck the check box to display only virtual servers that match ANM's virtual server definition (see the [“Information About Using ANM to Configure Virtual Servers”](#) section on page 7-4. This is the default.
- Step 3** Click **OK** to accept your entries on the Advanced Settings configuration window.
- Step 4** (Optional) Choose **Config > Operations > Virtual Servers** to view the change.
- 

## Administering the ANM Mobile Feature

ANM Mobile is a mobile device app that allows supported mobile devices to access your [ANM server](#) or [ANM Virtual Appliance](#) and manage the network objects in much the same way you do from an ANM client as described in [Chapter 19, “Using ANM Mobile.”](#) This section describes how to configure ANM to send alarm notifications to ANM Mobile, which requires configuring ANM with a push notification proxy server and globally enabling the mobile notification feature. For remotely authorized users, you must also modify the ANM configuration to allow ANM to send this user type mobile notifications.

After you have ANM configured to issue mobile notifications, you can send a test message to test the notification channel between ANM and the mobile device. You can also view a list that shows the last notification that ANM issued to each mobile device.

This section includes the following topics:

- [Configuring ANM with a Proxy Server for ANM Mobile Push Notifications, page 18-67](#)
- [Enabling Mobile Device Notifications for Remotely Authorized Users, page 18-69](#)
- [Globally Enabling or Disabling Mobile Device Notifications, page 18-69](#)
- [Displaying Mobile Device Notifications and Testing the Notification Channel, page 18-70](#)

## Configuring ANM with a Proxy Server for ANM Mobile Push Notifications

You can modify the ANM properties file for ANM Mobile push (or *alarm*) notifications. ANM is preconfigured to send ANM Mobile notifications directly to the Cisco proxy service. If your network does not allow direct access to the proxy service, you can configure ANM to send notifications to your proxy server, which in turn forwards the notifications to the Cisco proxy service.

**Prerequisites**

ANM has alarm threshold groups configured for mobile device alarm notifications (see the [“Configuring Alarm Notifications on ANM”](#) section on page 17-57).

**Procedure**

- 
- Step 1** Specify a proxy server to use as follows:
- ANM Server—Open the `/opt/CSCOanm/etc/cs-config.properties` file in a text editor and modify the following lines:
    - **proxy-type=type**  
Specify a type of either **ssl** or **socks** depending on your network requirements.
    - **proxy-server=proxy\_IPaddress**  
Specify the IP address of your proxy server.
    - **proxy-server-port=port\_number**  
Specify the port to use to communicate with your proxy server.
  - ANM Virtual Appliance—Enter the following commands:
    - **anm-property set proxy-type type**  
Specify a type of either **ssl** or **socks** depending on your network requirements.
    - **anm-property set proxy-server proxy\_IPaddress**  
Specify the IP address of your proxy server.
    - **anm-property set proxy-server-port port\_number**  
Specify the port to use to communicate with your proxy server.
- Step 2** Restart ANM as follows:
- ANM Server—Enter the following command:  
**/opt/CSCOanm/bin/anm-tool restart**
  - ANM Virtual Appliance—Enter the following command:  
**anm-tool restart**
- Step 3** Allow ANM to send alarm notifications to supported mobile devices.  
For more information, see the [“Globally Enabling or Disabling Mobile Device Notifications”](#) section on page 18-69.
- Step 4** (Optional) Send a test notification to a mobile device.  
For more information, see the [“Displaying Mobile Device Notifications and Testing the Notification Channel”](#) section on page 18-70.
- 

**Related Topics**

- [Enabling Mobile Device Notifications for Remotely Authorized Users](#), page 18-69
- [Globally Enabling or Disabling Mobile Device Notifications](#), page 18-69
- [Displaying Mobile Device Notifications and Testing the Notification Channel](#), page 18-70
- [Chapter 19, “Using ANM Mobile”](#)



## Enabling Mobile Device Notifications for Remotely Authorized Users

You can modify the ANM configuration when you need to send mobile device alarm notifications to users that are authorized remotely using an AAA server.

### Guidelines and Restrictions

When you enable alarm notifications to remotely authorized users, ANM does not perform any RBAC filtering of alarms to users, which means that remotely authorized users receive all alarm notifications regardless of the roles and domains assigned to them.

### Procedure

- 
- Step 1** Enable mobile device notifications for remotely authorized users as follows:
- ANM Server—Open the `/opt/CSCOanm/etc/cs-config.properties` file in a text editor and change the state of the following line from false to true:  
**`send.mobile.notifications.to.remote.users=true`**
  - ANM Virtual Appliance—Enter the following command:  
**`anm-property set send.mobile.notifications.to.remote.users true`**
- Step 2** Restart ANM as follows:
- ANM Server—Enter the following command:  
**`/opt/CSCOanm/bin/anm-tool restart`**
  - ANM Virtual Appliance—Enter the following command:  
**`anm-tool restart`**
- Step 3** Globally enable ANM to send mobile device alarm notifications (see the [“Globally Enabling or Disabling Mobile Device Notifications”](#) section on page 18-69).
- 

### Related Topics

- [Configuring ANM with a Proxy Server for ANM Mobile Push Notifications](#), page 18-67
- [Globally Enabling or Disabling Mobile Device Notifications](#), page 18-69
- [Displaying Mobile Device Notifications and Testing the Notification Channel](#), page 18-70
- [Chapter 19, “Using ANM Mobile”](#)

## Globally Enabling or Disabling Mobile Device Notifications

You can globally enable or disable mobile device notifications from ANM.

### Prerequisites

This topic includes the following prerequisites:

- ANM has alarm threshold groups configured for mobile device alarm notifications (see the [“Configuring Alarm Notifications on ANM”](#) section on page 17-57).

- ANM is allowed to send alarm notifications outside your network to the Cisco proxy service either directly (default) or through a specified proxy server (see the [“Configuring ANM with a Proxy Server for ANM Mobile Push Notifications”](#) section on page 18-67).
- For remotely authorized users only, you must modify the ANM config.properties file to allow ANM to send notifications to this user type (see the [“Enabling Mobile Device Notifications for Remotely Authorized Users”](#) section on page 18-69).

### Procedure

---

- Step 1** Choose **Admin > ANM Management > Advanced Settings**.
- The Advanced Settings configuration window appears.
- Step 2** In the “Enable mobile notifications from ANM” field of the Advanced Settings configuration window, do one of the following:
- Click **Enable** to allow ANM to send alarm notifications to mobile devices using ANM Mobile.
  - Click **Disable** to not allow ANM to send alarm notification to mobile devices. This is the default.
- Step 3** Click **OK** to accept your entries on the Advanced Settings configuration window.
- Step 4** (Optional) Send a test notification to a mobile device.
- For more information, see the [“Displaying Mobile Device Notifications and Testing the Notification Channel”](#) section on page 18-70.
- 

### Related Topics

- [Configuring Advanced Settings](#), page 18-62
- [Configuring ANM with a Proxy Server for ANM Mobile Push Notifications](#), page 18-67
- [Enabling Mobile Device Notifications for Remotely Authorized Users](#), page 18-69
- [Displaying Mobile Device Notifications and Testing the Notification Channel](#), page 18-70
- [Chapter 19, “Using ANM Mobile”](#)

## Displaying Mobile Device Notifications and Testing the Notification Channel

You can display the list of ANM Mobile alarm notifications and send a customized test message to a mobile device.

### Guidelines and Restrictions

This topic includes the following guidelines and restrictions:

- ANM displays only the last notification sent to a mobile device.
- You can send a test message to a mobile device even when you have globally disabled mobile device alarm notifications in ANM. For information about managing mobile device alarm notifications, see the [“Globally Enabling or Disabling Mobile Device Notifications”](#) section on page 18-69.

### Procedure

---

- Step 1** Choose **Admin > Role-Based Access Control > Mobile Notifications**.

The Mobile Notifications window appears. [Table 18-18](#) describes the information displayed.

**Table 18-18 Mobile Notifications Window**

| Field                               | Description                                                             |
|-------------------------------------|-------------------------------------------------------------------------|
| Owner                               | Mobile device owner.                                                    |
| UUID                                | Unique ID of the user who last logged in to ANM from the mobile device. |
| Device Type                         | Mobile device type.                                                     |
| Device OS                           | Mobile device operating system information.                             |
| Last Registration Time              | Last time the mobile device passed a device token to ANM.               |
| Time Zone <sup>1</sup>              | Time zone associated with the mobile device.                            |
| Last Notification Time <sup>1</sup> | Last time that ANM sent an alarm notification to the mobile device.     |

1. This field is not shown in the default view of the Mobile Notifications window. See [Step 2](#) to manage which fields display.

**Step 2** (Optional) To manage which fields display in the Mobile Notifications window, do the following:

- a. Click the **Customize** button (  ) and choose **Configure** from the menu that appears. The Mobile Notifications List Configuration popup window appears.
- b. From the popup window, choose the fields that you want to display and make any other display modifications that you want to see. Be sure to enter a name in the List Customization Name field if you want to assign a name to the customized display. This option allows you to recall the customized display if you return to the default display.
- c. Do one of the following:
  - Click **Save** to save the settings to the name that you provided in the List Customization Name field.
  - Click **Cancel** to exit the popup window without making any changes.
  - Click **Apply** to apply the changes to the Mobile Notifications window without saving the display settings to a new name.

**Step 3** (Optional) To test the notification channel between ANM and a mobile device, send the device a test message by doing the following:

- a. Choose the device from the Mobile Devices window and click **Send Test Message**.  
The Send Test Message to Device dialog box appears.
- b. In the dialog box, enter a message (150 characters maximum) to send the device and click **Send**.  
ANM sends the test message, which can be verified on the targeted device.

#### Related Topics

- [Displaying a List of Users, page 18-18](#)
- [Configuring ANM with a Proxy Server for ANM Mobile Push Notifications, page 18-67](#)
- [Enabling Mobile Device Notifications for Remotely Authorized Users, page 18-69](#)
- [Globally Enabling or Disabling Mobile Device Notifications, page 18-69](#)
- [Chapter 19, “Using ANM Mobile”](#)

# Lifeline Management

You can use the troubleshooting and diagnostics tools provided by the Lifeline feature to report a critical problem to the Cisco support line and generate a diagnostic package. For more information about this feature, see the [“Using Lifeline” section on page 20-7](#).



# CHAPTER 19

## Using ANM Mobile

---

**Date:** 3/28/12

This chapter describes Cisco ANM Mobile, which allows you to access your ANM server or ANM Virtual Appliance and manage your devices using a mobile device such as an iPhone or Android smartphone.

This chapter contains the following sections:

- [Information About ANM Mobile, page 19-2](#)
- [ANM Mobile Prerequisites and Supported Devices, page 19-4](#)
- [Guidelines and Restrictions, page 19-5](#)
- [Using ANM Mobile, page 19-5](#)

# Information About ANM Mobile

ANM Mobile allows supported mobile devices to access to your ANM server or ANM Virtual Appliance and manage the network objects in much the same way you do from an ANM client. Using a mobile device, you can run ANM Mobile as a native application (app) or inside the mobile device browser. Using either the native app or the mobile device browser, you can perform the following tasks:

- Activate or suspend a real server, virtual server, VIP answer, or DNS rule.
- Access the status and details of a real server, virtual server, VIP answer, or DNS rule.
- Change the weight of a real server.
- Display a real-time chart of a real or virtual server statistical metric, such as the number of connections.
- Display the Operation Summary (similar to the Device Configuration Summary Panel inside the ANM dashboard) by object type (Real Server, Virtual Server, VIP Answer or DNS Rule) in category of healthy, unhealthy, and others. You can drill down to see the list of objects in the selected category and object type.
- (Native app only) Receive alarm notifications from ANM when conditions exist that require your attention.
- Add frequently accessed objects to the Favorite screen.
- Use the search feature to find managed objects, such as a device, real server, virtual server, VIP answer, or DNS rule.
- View the alarm summary and details.
- Change the real time chart polling interval and connection time out values.
- Save your access credentials.
- From ANM's Mobile Devices window (Admin > Role-Based Access Control > Mobile Devices), system administrators can view the list of registered mobile users and send a test push notification message to a user's mobile device.

Table 19-1 shows the main differences between using ANM Mobile as a native app or using it in the mobile device's browser.

**Table 19-1 Major ANM Mobile Differences Between Native App and Mobile Browser**

| Category                                                  | Native Application                                   | Mobile Browser                         |
|-----------------------------------------------------------|------------------------------------------------------|----------------------------------------|
| ANM Notification Service (native app only)                | Supported                                            | Not supported                          |
| Client application (ANM Mobile) download and installation | Required                                             | Not required <sup>1</sup>              |
| Upgrade                                                   | Required download and installation of latest version | Part of the ANM server upgrade process |

1. When using a mobile device browser, you enter the ANM server IP address in the browser address bar, at which point you are redirected to ANM Mobile.

Figure 19-1 provides an overview of ANM Mobile, including the components that are available with the native app only.

Figure 19-1 ANM Mobile Overview

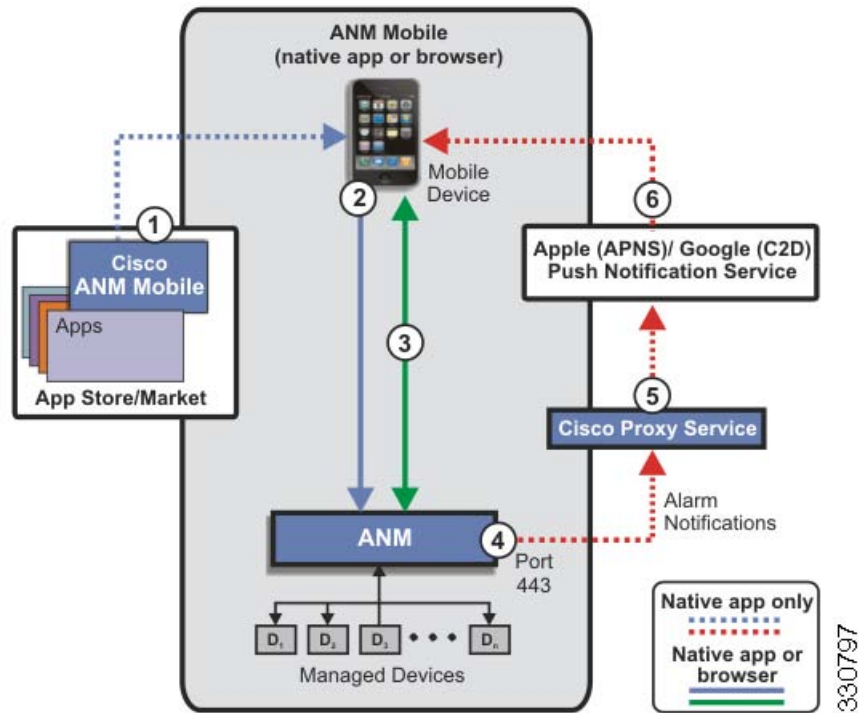

The components in Figure 19-1 are as follows:

1. ANM Mobile app—Obtain the no-cost Cisco ANM Mobile app from the app store or market associated with the mobile device.
2. Mobile device login—Enter ANM IP address, username, and password to log in to ANM server or ANM Virtual Appliance from the mobile device. After a successful login, ANM associates the mobile device with the user (see the “[Displaying a List of Users](#)” section on page 18-18).
3. Access ANM—Access ANM functionality to monitor your network and perform operational tasks. For more information, see the “[Using ANM Mobile](#)” section on page 19-5.
4. Alarm Notifications—ANM sends alarm notifications to a mobile device (native app required) through a proxy service.

For more information, see the “[Setting Up and Viewing Mobile Device Alarm Notifications](#)” section on page 19-13.

5. Cisco Proxy Service—Standalone server (managed by Cisco IT) that forwards notification messages from ANM to the Apple or Google Push Notification Service. The proxy service, which is hosted by Cisco and used for alarm notifications, manages the push notification messages that ANM issues by forwarding them to the Apple or Android Push Notification Services.

For more information, see the “[Configuring ANM with a Proxy Server for ANM Mobile Push Notifications](#)” section on page 18-67.

6. Push notification service—Allows a third-party server, such as the ANM server, to send notification messages securely to a mobile device. The push notification services provided by APPLE and Google are used for alarm notifications and are best effort; therefore, the push notification service provided by Cisco is also best-effort.

**Related Topics**

- [ANM Mobile Prerequisites and Supported Devices, page 19-4](#)
- [Guidelines and Restrictions, page 19-5](#)
- [Using ANM Mobile, page 19-5](#)

## ANM Mobile Prerequisites and Supported Devices

This section describes the ANM and mobile device requirements needed to use ANM Mobile.

**ANM Server and ANM Virtual Appliance Requirements**

Your ANM server or ANM Virtual Appliance must be using ANM software Version 5.1 or later to access ANM Mobile. To utilize the alarm notification feature, ANM must be configured to send notifications (see the “[Administering the ANM Mobile Feature](#)” section on page 18-67).

**Mobile Device Requirements**

[Table 19-2](#) shows the mobile devices that ANM Mobile version 1.0 supports.

**Table 19-2**      *Supported Devices*

| OS Platform | Tested Version    | Native Application | Mobile Browser          | Tested Device Types                                                                                                                                                                                                                                |
|-------------|-------------------|--------------------|-------------------------|----------------------------------------------------------------------------------------------------------------------------------------------------------------------------------------------------------------------------------------------------|
| Apple iOS   | 4.2 and 4.3       | Yes                | Safari                  | iPhone, iPod, iPad                                                                                                                                                                                                                                 |
| Android     | 2.2, 2.3.3, 2.3.6 | Yes                | Default Android Browser | Tested on the following Android handsets: HTC Inspire 4G, HTC Desire, Google Nexus One, Cisco Cius<br><br><b>Note</b> ANM Mobile may also work on other Android devices, but testing was performed on the above-mentioned set of Android handsets. |

Use following links to download the ANM Mobile app to your smartphone:

- [ANM Mobile on iPhone](#)
- [ANM Mobile on Android](#)
- [ANM Mobile on Cisco Cius](#)

**Related Topics**

- [Information About ANM Mobile, page 19-2](#)
- [Guidelines and Restrictions, page 19-5](#)
- [Using ANM Mobile, page 19-5](#)



# Guidelines and Restrictions

ANM Mobile includes the following guidelines and restrictions:

- Communication guidelines are as follows:
  - Communication between ANM Mobile and ANM is secure over HTTPS.



---

**Note** Ensure that your mobile device network setting permits access to ANM.

---

- User authentication is required to access the web services.
- The existing ANM user account is used to log in to ANM from the mobile device.
- All the existing RBAC (role-based access control) for the login user are enforced.
- The alarm notification feature requires access to the Internet. Depending on your network requirements, ANM can communicate directly with the Cisco proxy service or you can configure ANM to use your proxy server when issuing alarm notifications to the proxy service. For more information, see the [“Configuring ANM with a Proxy Server for ANM Mobile Push Notifications” section on page 18-67](#).
- The number of ANM Mobile users that can simultaneously connect to a single ANM server or ANM Virtual Appliance is limited to 35.
- (Android devices only) When navigating within the ANM Mobile native app, you must use the navigation tools provided by the native app because the native Android navigation tools are not supported.

## Related Topics

- [Information About ANM Mobile, page 19-2](#)
- [ANM Mobile Prerequisites and Supported Devices, page 19-4](#)
- [Using ANM Mobile, page 19-5](#)

# Using ANM Mobile

This section shows how to log in to ANM Mobile from your mobile device and then use its features to manage your network. If you are using the ANM Mobile app and want to use the alarm notification feature, this section also describes how to configure ANM and the ANM Mobile to enable this feature.

This section includes the following topics:

- [Logging In and Out of ANM Mobile, page 19-6](#)
- [Using the Favorites Feature, page 19-6](#)
- [Monitoring Managed Object Status, page 19-7](#)
- [Modifying an Object’s Operating State or Weight, page 19-10](#)
- [Displaying Real Time Charts, page 19-12](#)
- [Using the ANM Mobile Setting Feature, page 19-12](#)
- [Setting Up and Viewing Mobile Device Alarm Notifications, page 19-13](#)

## Logging In and Out of ANM Mobile

This section shows how to log in to and out of ANM Mobile from your mobile device.

### Prerequisite

If you want to log in and use the native app version of ANM Mobile, you must have the Cisco ANM Mobile app loaded on your mobile device. This no-charge app is available at the application store or market associated with any supported mobile device type.

### Procedure

---

- Step 1** From your mobile device, do one of the following depending on whether you are using a browser to access ANM Mobile or using the ANM Mobile native app:
- **Browser**—Open the browser and in the address box, enter the IP address of the ANM server or ANM VA using the following format:  
`https://ANM_IPaddress`  
The Login window appears. Enter your username and password.
  - **ANM Mobile app**—Do the following:
    - a. Click the **ANM Mobile** app icon to launch the application. The Login window appears.
    - b. From the login window, enter the IP address and port number of the ANM server or ANM Virtual Appliance and your username and password.
    - c. (Optional) Change the Save Credentials setting by doing the following:
      - Click **ON** to save your user credentials. This is the default. When set to ON, you just have to click **Log In** to log back in to ANM Mobile.
      - Click **OFF** to not save your user credentials.
- Step 2** Click **Log In**.
- The monitor page appears unless you have at least one favorite object specified, in which case the Favorites windows appears (see the “[Using the Favorites Feature](#)” section on page 19-6).
- Step 3** To log out of ANM Mobile, click **Settings** and click **Log Out**.
- 

## Using the Favorites Feature

The favorites feature allows you to create short cuts to ANM objects that you frequently access. When you specify at least one favorite object, the Favorites window becomes the home page that appears when you log in to ANM Mobile.

### Guidelines and Restrictions

- Favorite objects that are no longer available are grayed out. Object may no longer be available for the following reasons:
  - The object no longer exists in the ANM server because the object or the object’s host Virtual Context was deleted.
  - An RBAC change was made that prevents access by the user.

To remove a grayed out object from the favorites list, you must delete it.

- If you are using the ANM Mobile native app and want to receive alarm notifications from ANM, you must specify favorites on ANM Mobile that match the objects that you select for alarm notifications when configuring an alarm threshold group on ANM. For more information, see the [“Setting Up and Viewing Mobile Device Alarm Notifications”](#) section on page 19-13.

### Procedure

- 
- Step 1** Display the Favorites window by clicking the **Favorites** button located at the bottom of the window. The Favorites window appears.
- Step 2** To view a favorite object, click the object from the Favorites list.
- Step 3** To add an object to the Favorites window, do one of the following:
- From the Favorites window, click the **Add** icon (+) to open the search GUI, from which you can locate and choose the object. To add multiple objects, repeat this step for each object.
  - From the detailed managed object window, click the **Add** icon (+). For more information, see the [“Monitoring Managed Object Status”](#) section on page 19-7.
- Step 4** To delete a favorite from the list, do the following:
- a. Click the favorite to delete and click **Edit**. The Edit view appears.
  - b. From the Edit view, click the red **Delete** icon (–) located next to the favorite listing to delete. ANM Mobile removes the favorite from the list.
- 

## Monitoring Managed Object Status

You can monitor the operating status of the managed objects and drill down for details. [Figure 19-2](#) shows a sample of the Device Monitor windows, which can display objects sorted as follows:

- **Service**—Displays objects sorted by the following service types: Real Server, Virtual Servers, VIP Answers, and DNS Rules.
- **Device**—Displays objects sorted by the following device types: ACE Modules, ACE Appliance, CSS, CSM, and GSS.

**Figure 19-2 ANM Mobile Monitor Windows: Service Type and Device Type**

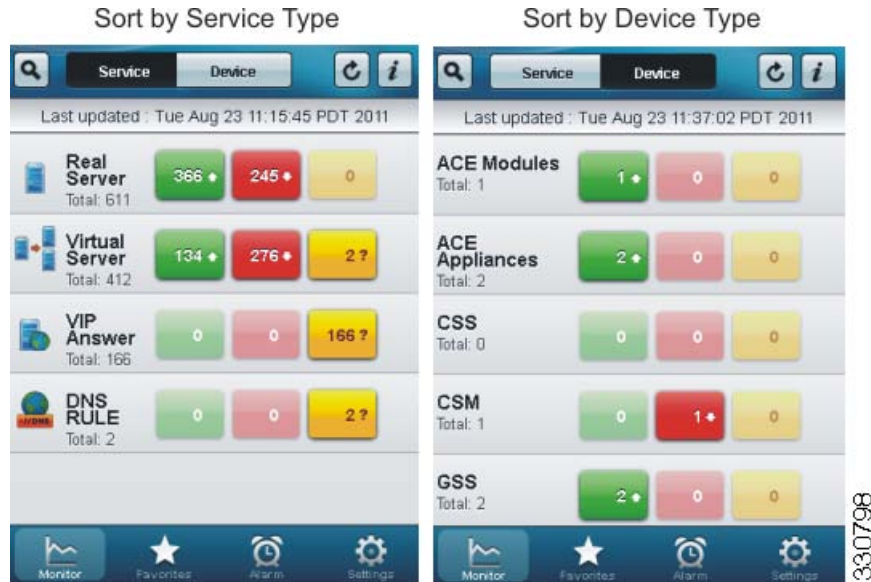

Each object type includes three color-coded status function buttons that list the number of object types in each of the following operational states:

- Up (green)—Objects in service.
- Down (red)—Objects out of service.
- Unknown (yellow)—Object operating state cannot be determined by ANM.

The status function buttons allow you to display only the objects of the specified object type and operating state.

Table 19-3 lists the details that you can view for each object type when you set the monitor display to Service.

**Table 19-3 Managed Object Details**

| Object Type    | Attribute                             |
|----------------|---------------------------------------|
| Virtual Server | Name                                  |
|                | Policy Map                            |
|                | IP address, protocol, and port number |
|                | Device                                |
|                | Admin status                          |
|                | Operating status                      |
|                | Server Farm                           |
|                | Current Connections                   |
|                | Connections per second                |
|                | Dropped Connections per second        |
|                | Dynamic Workload Scaling (DWS)        |
| Stat Age       |                                       |

**Table 19-3** *Managed Object Details (continued)*

| <b>Object Type</b> | <b>Attribute</b>                                                    |
|--------------------|---------------------------------------------------------------------|
| Real Server        | Name                                                                |
|                    | IP address                                                          |
|                    | Port                                                                |
|                    | Server Farm                                                         |
|                    | Device                                                              |
|                    | Admin status                                                        |
|                    | Operating status                                                    |
|                    | Weight                                                              |
|                    | Current connections                                                 |
|                    | Connections per second                                              |
|                    | Dropped connections per second                                      |
|                    | Virtual Machine (indicates if the real server is a virtual machine) |
|                    | Locality (OTV)                                                      |
|                    | Statistics Age                                                      |
| VIP Answer         | SLB name                                                            |
|                    | VIP answer name                                                     |
|                    | IP address                                                          |
|                    | Config state                                                        |
|                    | PGSSM operation status                                              |
|                    | Answer group                                                        |
|                    | Location                                                            |
|                    | PGSSM time                                                          |
| DNS Rule           | Device name                                                         |
|                    | DNS Rule name                                                       |
|                    | Source name                                                         |
|                    | Domains                                                             |
|                    | Config state                                                        |
|                    | Answer group                                                        |
|                    | Owner                                                               |
|                    | PGSSM time                                                          |

**Guidelines and Restrictions**

ANM Mobile is limited to approximately 7 KB of memory for the monitored objects list. If you have more than 100 monitored objects, ANM Mobile may exhibit performance issues. To avoid performance issues associated with a large number of monitored objects, do the following:

- Do not drill down to the detail list screen from the Monitor home page (see [Figure 19-2](#)). To display the detail information or the health status of a monitored object, use the search function from the Monitor home page by clicking the search icon (magnifying glass) and entering the object identifier.

If needed, refine your search criteria until the number of objects displayed is reduced to less than 100.

When in the search window, limit your use of the drill down (>) option, which can also create performance issues.

- For monitored objects that you track frequently, add them to your list of Favorites and access their information from there (see the [“Using the Favorites Feature”](#) section on page 19-6).

### Procedure

---

**Step 1** Click **Monitor**.

The View All window appears.

**Step 2** Click one of the color-coded function buttons associated with an object type to drill down and display a list of objects associated with an object type and operating state (up, down, or unknown).

The specified object type details windows appears, displaying a list of the objects in the chosen operating state (up, down, or unknown).

**Step 3** Do any of the following:

- Click a specific object from the list to display details about the object. The information that displays varies depending on the object type (see [Table 19-3](#)).

From the object details window, you can do the following:

- Activate, suspend, or change the weight of an object (see the [“Modifying an Object’s Operating State or Weight”](#) section on page 19-10).
  - Display a real time chart of monitored statistics (see the [“Displaying Real Time Charts”](#) section on page 19-12).
  - Click the **Search** icon to open the search text box and search for a specific object. Begin entering the search criteria. Object matches display and become more specific as you narrow the search by entering additional search criteria.
  - Click the **Refresh** icon to refresh the display.
  - Click **Back** to return to the object details window.
- 

### Related Topics

- [Modifying an Object’s Operating State or Weight, page 19-10](#)
- [Displaying Real Time Charts, page 19-12](#)

## Modifying an Object’s Operating State or Weight

You can use ANM Mobile to activate or suspend a real server, virtual server, VIP answer or DNS rule. For real servers only, you can change the weight assigned to the server.

### Procedure

---

**Step 1** Use one of the following methods to display the details window of a specific object:

- Choose **Monitor > Service**, choose a specific device type, and drill down (>) to the object details window.
- Click **Favorites**, choose a specific favorite and drill down (>) to the object details window.
- Click the **Search** icon (magnifying glass), enter the device search criteria, choose the device, and drill down (>) to the object details window.
- Click **Alarm**, choose a specific device type and drill down (>) to the object details window.

**Step 2** From the object details window, do one of the following:

- Click **Activate** to activate an object that is currently suspended. The Activate dialog box appears. In the dialog box, do the following:
  - a. Enter a reason for the change.
  - b. Click **Deploy** to execute the change or **Cancel** to ignore the change.
- Click **Suspend** to suspend an object currently activated. The Suspend dialog box appears. In the dialog box, do the following:
  - a. Enter a reason for the change.
  - b. Choose one of the following types of suspend operations from the drop-down list:
    - **Suspend**—Takes the object out of service.  
For a real server, the ACE resets all non-TCP connections to the server. For TCP connections, existing flows are allowed to complete before the ACE takes the real server out of service. No new connections are allowed. The ACE resets all Secure Sockets Layer (SSL) connections to the real server.
    - **Graceful**—When executed on a primary server, the ACE gracefully shuts down the server with sticky connections as follows:
      - Tears down existing non-TCP connections to the server.
      - Allows current TCP connections to complete.
      - Allows new sticky connections for existing server connections that match entries in the sticky database.
      - Load balances all new connections (other than the matching sticky connections mentioned above) to the other servers in the server farm.
      - When executed on a backup real server, the ACE places the backup server in service standby mode.
    - **Suspend and Clear Connections**—The ACE performs the tasks described for Suspend and clears the existing connections to this server.
  - c. Click **Deploy** to execute the change or **Cancel** to ignore the change.
- (Real server only) Click **Change Weight** to change weight assigned to a real server. The Change Weight dialog box appears. In the dialog box, do the following:
  - a. Enter a reason for the change.
  - b. Enter the new weight value. The valid range is 1 to 100.
  - c. Click **Deploy** to execute the change or **Cancel** to ignore the change.

The activity indicator appears for 30 seconds until it is determined that the operation succeeded, failed, or timed out. If the operation is successful, the object detail window is reloaded with the latest data and updated timestamp.

## Displaying Real Time Charts

You can display real time statistical information about the connections of a real server or a virtual server. Information that you can display in chart form are current connections, connections per second, or dropped connections per second.

### Guidelines and Restrictions

The chart never displays more than 5 minutes worth of statistical information.

### Procedure

---

- Step 1** Use one of the following methods to display the details window of a specific real server or a virtual server:
- Choose **Monitor > Service**, choose a specific device type, and drill down (>) to the object details window.
  - Click **Favorites**, choose a specific favorite and drill down (>) to the object details window.
  - Click the **Search** icon (magnifying glass), enter the device search criteria, choose the device, and drill down (>) to the object details window.
  - Click **Alarm**, choose a specific device type and drill down (>) to the object details window.
- Step 2** From the details window, click the **Chart** icon located next to the statistic to chart.  
The chart window appears.
- Step 3** Do the following:
- Click the **Refresh** icon to refresh the display.
  - To adjust the polling time, click **Settings** (see the [“Using the ANM Mobile Setting Feature”](#) section on page 19-12). The default polling time is 10 seconds.
  - Click **Back** to return to the object details window.
- 

## Using the ANM Mobile Setting Feature

The ANM Mobile Setting feature allows you to do the following:

- Display the ANM IP address.
- Display ANM Mobile software information.
- Adjust the connection timeout value and polling interval.
- Enable or disable push notifications, sound, and alerts.
- Submit an ANM user feedback form to Cisco.

### Procedure

---

- Step 1** From the All Devices or Favorites window, click **Settings**.  
The Settings window appears.
- Step 2** From the Settings window, do the following:



- Click **About** to do the following:
  - Display details about the version of ANM Mobile that you are using and the version of ANM software being used by the ANM server or ANM Virtual Appliance that you are accessing.
  - Click **UDID** to display the unique device ID (UDID).
- Click **Advanced** to access the Advanced Details window and modify the following settings:
  - Connection Timeout—Sets the amount of idle time (in seconds) at which the connection closes. Choose 10, 30 (default), or 60.
  - Polling Interval—Sets the frequency (in seconds) at which real time information, such as graph information, is updated. Choose 5, 10 (default), or 30.
- Click the **ON/OFF** toggle buttons to enable or disable the following features:
  - Push Notifications—When enabled (ON), allows your mobile device to receive alarm notifications that ANM issues to a push notification service. For more information, see the [“Setting Up and Viewing Mobile Device Alarm Notifications”](#) section on page 19-13.
  - Sound—(Android only) When enabled (ON), your mobile device sounds an alert to let you know that it received an alarm notification from ANM.



---

**Note** To modify this setting on an iPod, see the [“Managing iPod Alarm Notification Sound and Alerts”](#) section on page 19-16.

---

- Alert—(Android only) When enabled (ON), your mobile device displays an alert message to let you know that it received an alarm notification from ANM.



---

**Note** To modify this setting on an iPod, see the [“Managing iPod Alarm Notification Sound and Alerts”](#) section on page 19-16.

---

- Click the **Form** pen icon (  ) to fill out and submit the ANM user feedback form hosted on [www.ciscofeedback.vovici.com](http://www.ciscofeedback.vovici.com).

## Setting Up and Viewing Mobile Device Alarm Notifications



---

**Note** The alarm notifications feature requires the ANM Mobile app on your mobile device.

---

You can receive alarm notifications that ANM sends to your mobile device (see [Figure 19-1](#)) when specific virtual context alarm thresholds are exceeded. ANM Mobile app users can enable or disable the alarm notification feature, which allows them to choose when to receive alarm notifications from ANM. ANM administrators can enable or disable the alarm notification feature, which allows them to choose when to transmit alarm notifications to the ANM Mobile app.

Supported real and virtual server alarm conditions are as follows:

- Current connections—ANM can send an alarm notification when the number of active connections to a server exceeds a specific amount.
- Operational state—ANM can send an alarm when a server’s operational state changes.

### Guidelines and Restrictions

This topic includes the following guidelines and restrictions:

- The ANM objects that you select for alarm notifications when configuring an alarm threshold group must match objects that you select as favorites on ANM Mobile. Alarm threshold groups are configured at the virtual context level; therefore, to receive alarm notifications for an object that you specify as a favorite, the object favorite must be part of the virtual context in the threshold group.
- The alarms that ANM Mobile displays depends on how the user is authorized as follows:
  - Locally authorized users—ANM displays only alarms that are permitted based on the domains and roles assigned to the user account (see the [Prerequisites](#) for this topic).
  - Remotely authorized users—By default, ANM does not send alarm notifications to remotely authorized user accounts; however, you can modify the ANM configuration so that ANM sends all alarm notifications to this user type regardless of the domains and roles assigned to them (see the [Prerequisites](#) for this topic).
- From ANM, you can do the following:
  - Enable or disable the alarm notification feature, which allows you to choose when to transmit alarm notifications to the ANM Mobile app (see the [“Enabling Alarm Notifications on ANM Mobile”](#) section on page 19-15).
  - Send a test alarm notification to a mobile device to test the notification channel (see the [“Displaying Mobile Device Notifications and Testing the Notification Channel”](#) section on page 18-70). You can send a test message to a mobile device even when you have globally disabled mobile alarm notifications in ANM.

### Prerequisites

The prerequisites for this topic are as follows:

- ANM prerequisites:
  - ANM software Version 5.1 or later.
  - Alarm threshold groups are configured on ANM for mobile device alarm notifications. For details about creating an alarm threshold group, see the [“Configuring Alarm Notifications on ANM”](#) section on page 17-57.
  - Alarm notifications are enabled globally in ANM. For details, see the [“Enable Mobile Notifications from ANM”](#) section on page 18-66.
  - For locally authorized users, their user account has the required role and domains associated with it.



---

**Note** The user role must have the `anm_threshold` attribute set at least to **View**.

---

For more information, see the [“Managing User Accounts”](#) section on page 18-17.

- For remotely authorized users, the ANM configuration is modified to enable ANM to send these users alarm notifications. For more information, see the [“Enabling Mobile Device Notifications for Remotely Authorized Users”](#) section on page 18-69.
- Mobile device prerequisites:
  - The ANM Mobile app is loaded on your supported mobile device.
  - ANM objects specified as favorites on your mobile device match the objects in an ANM alarm threshold group. For example, specific real or virtual servers that are favorites on your mobile device are also specified as objects in an ANM alarm threshold group.

For information about specifying favorites on your mobile device, see the “[Using the Favorites Feature](#)” section on page 19-6.

This section includes the following topics:

- [Enabling Alarm Notifications on ANM Mobile](#), page 19-15
- [Viewing Alarm Notifications from ANM Mobile](#), page 19-15

## Enabling Alarm Notifications on ANM Mobile

From your mobile device, you can specify whether to receive or not receive alarm notifications from ANM by using the Setting button to modify the ANM Mobile operational settings. For details about using this button, see the “[Using the ANM Mobile Setting Feature](#)” section on page 19-12.

### Related Topics

- [Using the ANM Mobile Setting Feature](#), page 19-12
- [Setting Up and Viewing Mobile Device Alarm Notifications](#), page 19-13
- [Viewing Alarm Notifications from ANM Mobile](#), page 19-15
- [Managing iPod Alarm Notification Sound and Alerts](#), page 19-16

## Viewing Alarm Notifications from ANM Mobile

From your mobile device, you can view alarm notifications that ANM sends to the device. For each notification, you can drill down to view the device details.

### Procedure

- 
- Step 1** Click **Alarms**.
- The Alarm Summary window appears, displaying the list of received alarms that you are permitted to view (see the [Prerequisites](#) for this topic).
- Step 2** (Optional) Click the drill-down icon (>) associated with a specific alarm to display details about the alarm.
- The Alarm Detail window appears, displaying the following information:
- Timestamp
  - Severity
  - Device
  - Service
  - Threshold Group
  - Category
  - Stat/Value
- Step 3** (Optional) From the Service category, click the drill-down (>) icon to display the object Details window related to the real or virtual server associated with the alarm notification.
- Step 4** (Optional) From the object Details window, do any of the following:

- Click **View Graph** to display the graphs associated the following real server and virtual server items: Current Connections, Connections/Sec, or Dropped Connection/Sec. For more information, see the “[Displaying Real Time Charts](#)” section on page 19-12.
- Click **Activate**, **Suspend**, or **Change Weight** to change the object’s operating state or weight. For more information, see the “[Modifying an Object’s Operating State or Weight](#)” section on page 19-10.

---

#### Related Topics

- [Setting Up and Viewing Mobile Device Alarm Notifications](#), page 19-13
- [Enabling Alarm Notifications on ANM Mobile](#), page 19-15
- [Managing iPod Alarm Notification Sound and Alerts](#), page 19-16
- [Using the ANM Mobile Setting Feature](#), page 19-12

## Managing iPod Alarm Notification Sound and Alerts

You can manage the alarm notification sound and alert features on your iPod that let you know when an alarm notification is received from ANM.



#### Note

To manage the alarm notification sound and alert features on your Android device, see the “[Using the ANM Mobile Setting Feature](#)” section on page 19-12.

#### Procedure

- 
- Step 1** From your iPod Setting window, choose **Notifications > ANM Mobile** to drill down to the ANM Mobile settings.
- The Notifications, ANM Mobile window appears.
- Step 2** From the Notifications, ANM Mobile window, click the **ON/OFF** toggle buttons to enable or disable the following features:
- Sound—When enabled (ON), your iPod sounds an alert to let you know that it received an alarm notification from ANM.
  - Alert—When enabled (ON), your iPod displays an alert message to let you know that it received an alarm notification from ANM.
- 

#### Related Topics

- [Enabling Alarm Notifications on ANM Mobile](#), page 19-15
- [Viewing Alarm Notifications from ANM Mobile](#), page 19-15



## CHAPTER 20

# Troubleshooting Cisco Application Networking Manager Problems

Date: 3/28/12

This chapter describes how to troubleshoot ANM issues.



### Note

When naming ACE objects (such as a real server, virtual server, parameter map, class map, health probe, and so on), enter an alphanumeric string of 1 to 64 characters, which can include the following special characters: underscore (\_), hyphen (-), dot (.), and asterisk (\*). Spaces are not allowed.

If you are using ANM with an ACE module or ACE appliance and you configure a named object at the ACE CLI, keep in mind that ANM does not support all of the special characters that the ACE CLI allows you to use when configuring a named object. If you use special characters that ANM does not support, you may not be able to import or manage the ACE using ANM.

This chapter includes the following sections:

- [Changing ANM Software Configuration Attributes, page 20-1](#)
- [Discovering and Adding a Device Does Not Work, page 20-7](#)
- [Cisco License Manager Server Not Receiving Syslog Messages, page 20-7](#)
- [Using Lifeline, page 20-7](#)
- [Backing Up and Restoring Your ANM Configuration, page 20-11](#)

For additional troubleshooting information, see the *Installation Guide for Cisco Application Networking Manager 5.2* or the *Installation Guide for Cisco Application Networking Manager 5.2 Virtual Appliance*

## Changing ANM Software Configuration Attributes

After you have installed the ANM, you can reconfigure ANM software configuration attributes, such as enabling HTTP(S) for Web Services, or the ports that ANM uses for communication with the network devices. For information about the ports that ANM uses, see [Appendix A, “ANM Ports Reference.”](#)

This section includes the following topics:

- [Changing ANM Configuration Properties, page 20-2](#)
- [Example ANM Standalone Configuration, page 20-4](#)
- [Example ANM HA Configuration, page 20-5](#)

- [Example ANM Advanced Options Configuration Session, page 20-6](#)

## Changing ANM Configuration Properties

This section shows how to change the ANM configuration properties. The procedure varies slightly depending on the ANM application type; ANM server or ANM Virtual Appliance.

### Procedure

- 
- Step 1** Do one of the following depending on the ANM application type:
- ANM server: From the Linux command line, log in as the root user.
  - ANM Virtual Appliance: Log in as administrator using SSH or console.
- Step 2** Do one of the following:
- For a standard configuration change, enter the following depending on the ANM application type:
    - ANM server: `/opt/CSCOanm/bin/anm-tool configure`
    - ANM Virtual Appliance: `anm-tool configure`
  - To reconfigure with the advanced-options, enter the following depending on the ANM application type:
    - ANM server: `/opt/CSCOanm/bin/anm-tool --advanced-options=1 configure`
    - ANM Virtual Appliance: `anm-tool configure advanced-options`
  - (ANM server only) To switch between an HA and a non-HA system configuration, do one of the following:
    - To switch from a HA to a non-HA system configuration, enter the following:  
`/opt/CSCOanm/bin/anm-tool --ha=0 configure`
    - To switch from a non-HA to a HA system configuration, enter the following:  
`/opt/CSCOanm/bin/anm-tool --ha=1 configure`

The **Keep existing ANM configuration?** [y/n]: prompt appears.

- Step 3** At the prompt, enter **n** (no).
- The current configuration information appears. For each configuration property, the current value is displayed in square brackets.

- Step 4** Do one of the following:
- To accept the current value for a configuration property, press **Enter**.
  - To change a configuration property, enter the appropriate information.

When reconfiguring ANM using the **advanced-options** command, the configuration sequence includes prompts applicable to the web server that serves requests for the ANM Web Service API. The Web Service API provides SOAP-based programmatic access to the functionality of ANM. By default, it is disabled. You can enable it using this option.

The advanced options attributes and their default setting are as follows:

- Enable HTTP for Web Server: false

**Caution**

---

Remember that enabling HTTP makes the connection to ANM less secure.

---

- Inbound Port for HTTP traffic to ANM Default: 80
- Enable HTTPS for Web Server: true
- Inbound Port for HTTPS traffic to ANM Default: 443
- HTTP Port of Web Services: 8080
- Enable HTTP for Web Services: false
- HTTPS Port of Web Services: 8443
- Enable HTTPS for Web Services: false
- Idle session timeout in msec: 1800000

The idle session timeout applies to user sessions for the ANM GUI. Users who are idle for an amount of time greater than this value are automatically logged off the application. By default, this setting is 1800000 milliseconds, or 30 minutes.

- Change the memory available to ANM process: low

Check the available physical memory; if it is less than 3.5 G, then set the memory size to **low** (1 G), which is the default. If the available physical memory is greater than 3.5 G, set the memory size to **high** (2 G).



---

**Note** If you set the memory size to **high** and ANM determines that there is not enough available physical memory, it sets the memory size to **low**.

---



---

**Note** (ANM server only) When modifying the memory size in an ANM HA configuration, perform the change as follows:

- a. Stop both ANM servers (active and standby).
- b. Change the memory size on both ANM servers (Steps 1 to 4 above).
- c. Restart the ANM server that you want to operate in the active state (Step 5 below).
- d. Restart the standby ANM server (Step 5 below).

---

After you have accepted or changed all of the configuration property values, a list of all the properties appears and the “Commit these values? [y/n/q]” prompt appears.

**Step 5** At the Commit prompt, do one of the following:

- To accept the value and restart the ANM, enter **y** (yes).



---

**Note** If you modified the advanced options, restarting ANM may interfere with active sessions in the ANM web interface.

---



---

**Note** If you receive errors when attempting to change the HA properties configuration values, check the node ID to be sure they are not switched.

---

- To go through the list of configuration properties again, enter **n** (no).

- To retain the original property values and exit the configuration session, enter **q** (quit).

## Example ANM Standalone Configuration

This section contains an example of a configuration session for an ANM standalone system. The values shown in the brackets are the currently configured values.

```

/opt/CSCOanm/bin/anm-tool configure
Configuring ANM

Checking ANM configuration files
 Keep existing ANM configuration? [y/n]: n
 Creating config file (/opt/CSCOanm/etc/cs-config.properties)

Enable HTTP for Web Server [true]:
Inbound Port for HTTP traffic to ANM Default [80]:
Enable HTTPS for Web Server [true]:
Inbound Port for HTTPS traffic to ANM Default [443]:

These are the values:
Enable HTTP for Web Server: true
Inbound Port for HTTP traffic to ANM Default: 80
Enable HTTPS for Web Server: true
Inbound Port for HTTPS traffic to ANM Default: 443

Commit these values? [y/n/q]: y
Committing values ... done
 Keeping existing configuration: /opt/CSCOanm/lib/java/thirdparty/ctm_config.txt

Stopping services
 Stopping monit services (/etc/monit.conf) ... (0)
 Stopping monit ... Stopped
 Stopping heartbeat ... Stopped

Installing system configuration files
 Backing up //opt/CSCOanm/etc/my-local.cnf

Setting service attributes
 Enabling mysql for SELinux
setsebool: SELinux is disabled.
 Service monit is started by OS at boot time

Starting mysql ... Started
mysql status ... Ready

Configuring mysql
 Checking mysql user/password
 Setting mysql privileges
 Disabling mysql replication

Starting services
 Starting monit ...Starting monit daemon with http interface at [*:2812]
 Started

```



## Example ANM HA Configuration



### Note

The information in this section pertains to the ANM server application only.

The following is an example of a configuration session for an ANMHA system. Standalone systems will not contain any HA properties but will include a limited property value configuration. The values shown in the brackets are the currently configured values.

```

/opt/CSCOanm/bin/anm-tool configure
Configuring ANM

Checking ANM configuration files
Keep existing ANM configuration? [y/n]: n
Creating config file (/opt/CSCOanm/etc/cs-config.properties)

Enable HTTP for Web Server [false]: true
Inbound Port for HTTP traffic to ANM Default [80]: 80
Enable HTTPS for Web Server [true]:
Inbound Port for HTTPS traffic to ANM Default [443]:
Database Password [nI4ewPbmV5lS]: passme
HA Node 1 UName []: anm49.cisco.com
HA Node 2 UName []: anm50.cisco.com
HA Node 1 Primary IP [0.0.0.0]: 10.77.240.126
HA Node 2 Primary IP [0.0.0.0]: 10.77.240.100
HA Node 1 HeartBeat IP [0.0.0.0]: 10.10.10.1
HA Node 2 HeartBeat IP [0.0.0.0]: 10.10.10.2
HA Virtual IP [0.0.0.0]: 10.77.240.101
HA Node ID [1 or 2] []: 1

These are the values:
Enable HTTP for Web Server: true
Inbound Port for HTTP traffic to ANM Default: 80
Enable HTTPS for Web Server: true
Inbound Port for HTTPS traffic to ANM Default: 443
Database Password: passme
HA Node 1 UName: anm49.cisco.com
HA Node 2 UName: anm50.cisco.com
HA Node 1 Primary IP: 10.77.240.126
HA Node 2 Primary IP: 10.77.240.100
HA Node 1 HeartBeat IP: 10.10.10.1
HA Node 2 HeartBeat IP: 10.10.10.2
HA Virtual IP: 10.77.240.101
HA Node ID [1 or 2]: 1

Commit these values? [y/n/q]: y
Committing values ... done
Keeping existing configuration: /opt/CSCOanm/lib/java/thirdparty/ctm_config.txt

Stopping services
Stopping monit services (/etc/monit.conf) ... (0)
Stopping monit ... Stopped
Stopping heartbeat ... Stopped

Installing system configuration files

Setting service attributes
Enabling mysql for SELinux
Service monit is started by OS at boot time

```

```

Starting mysql ... Started

Configuring mysql
Checking mysql user/password
Setting mysql privileges
Enabling mysql replication
Setting up database
executing /opt/CSCOanm/lib/install/etc/dcmdb.sql ... done

Starting services
Starting monit ... Started

```

## Example ANM Advanced Options Configuration Session

The following is an example of a configuration session for an ANM advanced options. The values shown in the brackets are the currently configured values.



### Note

The **anm-tool** command in the example uses the ANM server version of the command for modifying the advanced options. The ANM Virtual Appliance version of the command is **anm-tool configure advanced-options**. The information that displays after entering the command is the same for both applications.

```

/opt/CSCOanm/bin/anm-tool --advanced-options=1 configure
Configuring ANM

Checking ANM configuration files
 Keep existing ANM configuration? [y/n]: n
 Creating config file (/opt/CSCOanm/etc/cs-config.properties)
Enable HTTP for Web Server [false]:
Inbound Port for HTTP traffic to ANM Default [80]:
Enable HTTPS for Web Server [true]:
Inbound Port for HTTPS traffic to ANM Default [443]:
HTTP Port of Web Services [8080]:
Enable HTTP for Web Services [false]:
HTTPS Port of Web Services [8443]:
Enable HTTPS for Web Services [false]:
Idle session timeout in msec [1800000]:
Change the memory available to ANM process [low|high] [low]:
These are the values:
Enable HTTP for Web Server: false
Inbound Port for HTTP traffic to ANM Default: 80
Enable HTTPS for Web Server: true
Inbound Port for HTTPS traffic to ANM Default: 443
HTTP Port of Web Services: 8080
Enable HTTP for Web Services: false
HTTPS Port of Web Services: 8443
Enable HTTPS for Web Services: false
Idle session timeout in msec: 1800000

```

```
Change the memory available to ANM process [low|high]: low
Commit these values? [y/n/q]: y
Committing values ... done
 Keeping existing configuration: /opt/CSCOanm/lib/java/thirdparty/ctm_config.txt
Stopping services
 Stopping monit services (/etc/monit.conf) ... (0)
```

## Discovering and Adding a Device Does Not Work

After IP discovery has checked the network and made a list of devices of each type, the device import may have failed when you tried to import the device. The device import may not have worked because IP discovery uses Telnet and SNMP to discover potential devices, while ANM requires SSH to import a device. So it is likely that IP discovery may have found some devices that cannot be imported or may not have found devices that could be imported.

To update the device so that it can be imported by ANM, see the [“Preparing Devices for Import” section on page 5-4](#).

To add the device, use the Config > Devices > Add method. For detailed procedures, see the [“Importing Network Devices into ANM” section on page 5-10](#).

## Cisco License Manager Server Not Receiving Syslog Messages

Firewall settings are implemented as IP tables with Red Hat Enterprise Linux 5.2, and might drop syslog traffic.

If you are not receiving syslog messages even after following the procedure documented in the [“Enabling a Setup Syslog for Autosync for Use With an ACE” section on page 5-27](#), perform the procedure in this section.

### Procedure

- 
- |               |                                                                                                              |
|---------------|--------------------------------------------------------------------------------------------------------------|
| <b>Step 1</b> | Update the rules in your IP tables using the command line.                                                   |
| <b>Step 2</b> | Make sure the default syslog port 514 is open as noted in <a href="#">Appendix A, “ANM Ports Reference.”</a> |
- 

## Using Lifeline

Diagnosing network or system-related problems that happen in real time can consume a considerable amount of time and lead to frustration even for a system expert. When a critical problem occurs within the ANM system or the network components managed by the ANM, you can use the troubleshooting and diagnostics tools provided by the Lifeline feature to report to the Cisco support line and generate a diagnostic package. Support engineers and developers can subsequently reconstruct your system and debug the problem using the comprehensive information captured in the lifeline.

Lifeline takes a snapshot of the running system configuration, status, buffers, logs, thread dumps, messages, CLI device configuration commands, device **show run** commands, and so on. It gathers a period of historical network and system events that have been recorded directly preceding the event. If required, Lifeline can back up and package the ANM database or a file subdirectory or trace and package a period of traffic flow packets for a specified virtual context.

The following sections describe how to use the Lifeline feature:

- [Guidelines for Using Lifeline, page 20-8](#)
- [Creating a Lifeline Package, page 20-8](#)
- [Downloading a Lifeline Package, page 20-9](#)
- [Adding a Lifeline Package, page 20-10](#)
- [Deleting a Lifeline Package, page 20-11](#)

## Guidelines for Using Lifeline

Lifelines can be created when unwanted events occur. Under such circumstances, available resources could be extremely low (CPU and memory could be nearly drained). You should be aware of the following:

- Create a Lifeline package after you encounter a problem that might require customer support assistance. The package is meant to be viewed by customer support.
- Lifeline collects debug data from diagnostic generators based on priority – most important to least important. When the total data size reaches 200 MB, the collector stops collecting, and data from generators with lower priorities can be lost. For details on content, size, time, state, and any dropped data, see the Readme file included in each Lifeline package.
- Lifeline collects the last 25 MB of data from the file and truncates the beginning content.
- Lifelines are automatically packaged by the system in zip files. The naming convention for a lifeline package is “lifeline-yyMMdd-hhmmss.zip”. For example, lifeline-07062-152140.zip is a Lifeline package created at 3:21:40 PM, June 22, 2007.
- Only one Lifeline package is created at a time. The system will reject a second request made before the first Lifeline has been packaged.
- Lifeline times out in 60 minutes.
- A maximum of 20 Lifeline packages are stored at a time.

## Creating a Lifeline Package

You can create a lifeline package.

### Assumptions

This section assumes the following:

- ANM is installed and running.
- You have reviewed the guidelines for managing lifelines (see the [“Guidelines for Using Lifeline” section on page 20-8](#)).

- You have opened a case with Cisco technical support.

### Procedure



**Note** Your user role determines whether you can use this option.

**Step 1** Choose **Admin > Lifeline Management**.

**Step 2** Enter a description for the package (required).

The description can include information about why the package is being created, who requested the package, and so forth.

**Step 3** Click **Save**.

The package is created in the following format: lifeline-yyMMdd-hhmmss.zip, and displays in the Lifelines pane. The package size, name, and generation date display in the New Lifeline window.



**Note** Do not perform any module maintenance until the package is created.

**Step 4** After the package is created, do one of the following:

- Click **Download** to save the package to a directory on your computer or to view the package contents. See the [“Downloading a Lifeline Package” section on page 20-9](#).
- Click **Add** to add the package to the ANM database. See the [“Adding a Lifeline Package” section on page 20-10](#).
- Click **Delete** to delete the package. See the [“Deleting a Lifeline Package” section on page 20-11](#).

### Related Topics

- [Using Lifeline, page 20-7](#)
- [Creating a Lifeline Package, page 20-8](#)
- [Adding a Lifeline Package, page 20-10](#)
- [Downloading a Lifeline Package, page 20-9](#)

## Downloading a Lifeline Package



**Note** Your user role determines whether you can use this option.

You can download a package for displaying or saving to your local drive.

### Assumption

You have created a package (see the [“Creating a Lifeline Package” section on page 20-8](#)).

### Procedure

**Step 1** Choose **Admin > Lifeline Management**.

**Step 2** Choose the package (Lifeline) from the list.

**Step 3** Click **Download**.

The package is sent to your web browser, with which you can save or view the package.



**Note** Do not perform any module maintenance until the package download to your web browser has completed.

---

#### Related Topics

- [Using Lifeline, page 20-7](#)
- [Creating a Lifeline Package, page 20-8](#)
- [Adding a Lifeline Package, page 20-10](#)
- [Deleting a Lifeline Package, page 20-11](#)

## Adding a Lifeline Package



**Note** Your user role determines whether you can use this option.

---

You can add a package to the ANM database.

#### Assumption

You have created a package (see the [“Creating a Lifeline Package”](#) section on page 20-8).

#### Procedure

---

**Step 1** Choose **Admin > Lifeline Management**.

The Lifeline Management window appears.

**Step 2** In the Lifeline Management window, enter a description and click **Add**.

The package is added to the Lifelines list, and the window refreshes.



**Note** Do not perform any module maintenance until the package is added to the list.

---

#### Related Topics

- [Using Lifeline, page 20-7](#)
- [Creating a Lifeline Package, page 20-8](#)
- [Downloading a Lifeline Package, page 20-9](#)
- [Deleting a Lifeline Package, page 20-11](#)

## Deleting a Lifeline Package

**Note**

Your user role determines whether you can use this option.

You can delete a package.

**Procedure**

- 
- Step 1** Choose **Admin > Others > Lifeline Management**.  
The Lifeline Management window appears.
- Step 2** From the list of lifelines in the Lifeline Management window, choose a lifeline to delete.  
The details of the lifeline display.
- Step 3** Click **Delete**.  
A confirmation popup window displays that requests you confirm the deletion.
- Step 4** Click **OK** to delete the package.  
The Lifeline Management window display updates.
- 

**Related Topics**

- [Using Lifeline, page 20-7](#)
- [Creating a Lifeline Package, page 20-8](#)
- [Adding a Lifeline Package, page 20-10](#)
- [Downloading a Lifeline Package, page 20-9](#)

## Backing Up and Restoring Your ANM Configuration

You can create a backup of your ANM configuration and restore it if necessary. We recommend that you periodically create a backup of ANM.

The procedures for creating a backup and restoring your ANM configuration vary depending on which of the following ANM applications you are using:

- ANM server: See the [Installation Guide for Cisco Application Networking Manager 5.2](#) for the backup and restore procedures.
- ANM Virtual Appliance: See the [Installation Guide for Cisco Application Networking Manager 5.2 Virtual Appliance](#) for the backup and restore procedures.

**Note**

For details about using the ACE device backup and restore functions in ANM, see the [“Performing Device Backup and Restore Functions”](#) section on page 6-59. The backup and restore functions allow you to back up or restore the configuration and dependencies of an entire ACE or of a particular virtual context.

---







## APPENDIX **A**

# ANM Ports Reference

---

**Date:** 3/28/12

ANM uses specific ports for its processes. [Figure A-1](#) illustrates a typical ANM server deployment in a network. This illustration identifies the protocols and ports used by the different network devices in a typical deployment.

- [Table A-1](#) lists the ports used for ANM client (browser) or ANM server and ANM high availability communication.
- [Table A-2](#) lists the ports used for communication between ANM and managed devices.

Figure A-1 ANM Server Deployment

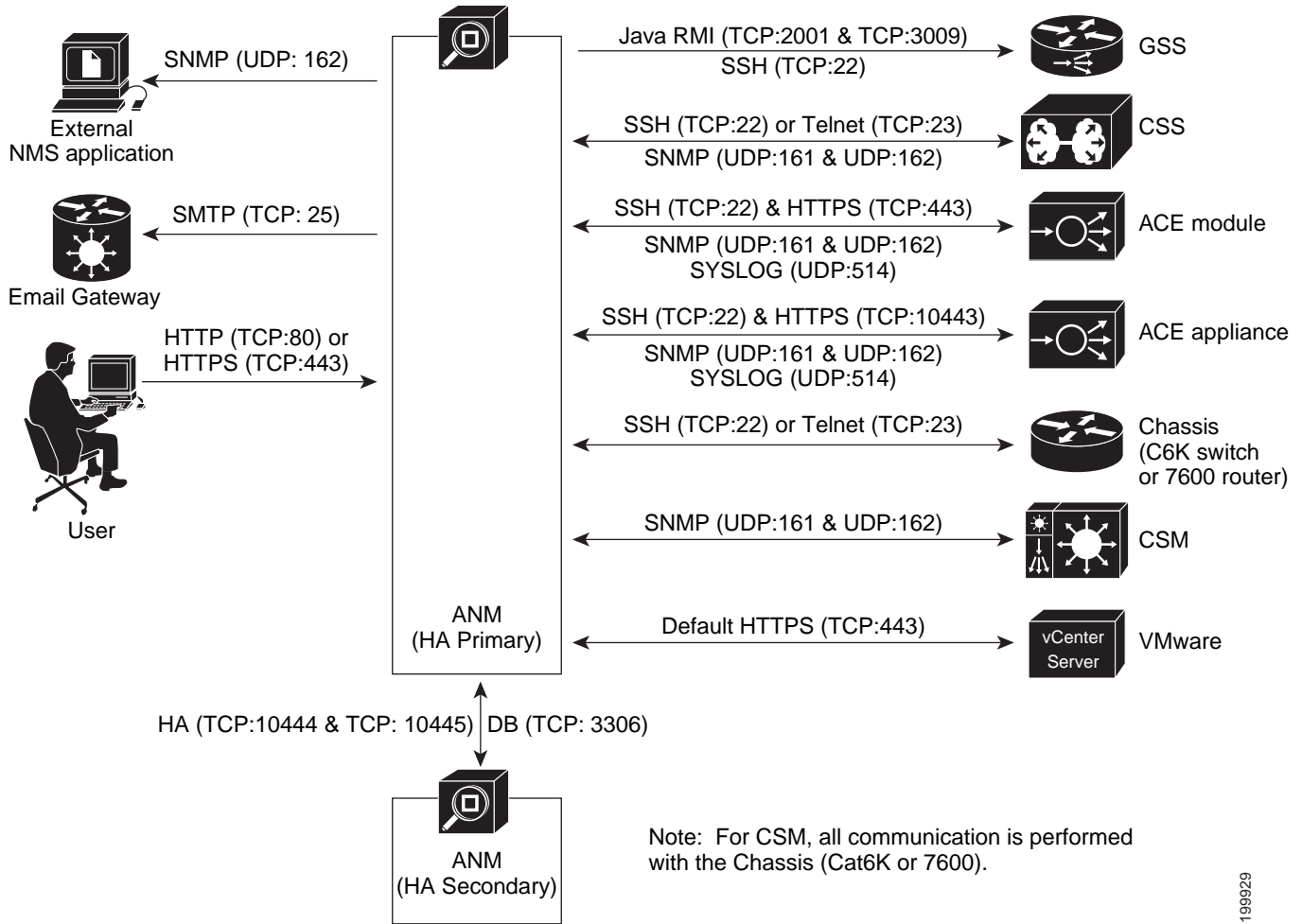

199929

**Table A-1 Ports Used by ANM in a Network Deployment<sup>1</sup>**

| Port                        | Description                                                                                       |
|-----------------------------|---------------------------------------------------------------------------------------------------|
| TCP (80)                    | Default port if ANM is configured for access using HTTP (using anm-installer).                    |
| TCP (443)                   | Default port if ANM is configured for access using HTTPS (using default install option).          |
| TCP (3306)                  | MySQL Database system (ANM HA installation opens this port to communicate with the peer ANM).     |
| TCP (10444) and TCP (10445) | ANM License Manager (ANM HA installation opens these two ports to communicate with the peer ANM). |
| TCP (25)                    | Port used by ANM server to communicate to Email Gateway through SMTP.                             |
| UDP (162)                   | Port used by ANM server to send out trap notification to external NMS application.                |
| HTTP(8080) and HTTPS (8443) | Web service ports.                                                                                |

1. It is highly recommended that you run ANM on a stand-alone device. However, if you run ANM on a shared device, please note that ANM locally opens the following ports for internal communication:

TCP Ports: 8980, 10003, 10004, 10023, 10443, 40000, 40001, 40002, 40003  
 UDP Ports: 6120, 10003

**Table A-2 Ports Used by ANM for Communication with Managed Devices**

| Device Type                                         | Port                            | Description                                                                                                                            |
|-----------------------------------------------------|---------------------------------|----------------------------------------------------------------------------------------------------------------------------------------|
| Chassis (Catalyst 6500 switch or Cisco 7600 router) | SSH (TCP:22) or Telnet (TCP:23) | Discover chassis configuration.                                                                                                        |
| ACE (appliance or module)                           | HTTPS (TCP:443)                 | For ACE module: XML/HTTPS interface on the device used to discover, configure, and monitor using specific <b>show</b> CLI commands.    |
|                                                     | HTTPS (TCP:10443)               | For ACE appliance: XML/HTTPS interface on the device used to discover, configure, and monitor using specific <b>show</b> CLI commands. |
|                                                     | SSH (TCP: 22)                   | Discovery and configuration of ACE licenses, certificates/keys (crypto) licensing, scripts, and checkpoints.                           |
|                                                     | SNMP (UDP: 161 & UDP:162)       | Monitor ACE through SNMP requests (UDP: 161) and receive trap notifications (UDP: 162).                                                |
| CSM                                                 | SNMP (UDP: 161 & UDP:162)       | Monitor CSM through SNMP requests (UDP: 161) and receive trap notifications (UDP: 162).                                                |

**Table A-2** Ports Used by ANM for Communication with Managed Devices (continued)

| Device Type    | Port                            | Description                                                                                                                                                                                                                                                                                                                           |
|----------------|---------------------------------|---------------------------------------------------------------------------------------------------------------------------------------------------------------------------------------------------------------------------------------------------------------------------------------------------------------------------------------|
| CSS            | SSH (TCP:22) or Telnet (TCP:23) | Discover chassis configuration.                                                                                                                                                                                                                                                                                                       |
|                | SNMP (UDP: 161 & UDP:162)       | Monitor CSS through SNMP requests (UDP: 161) and receive trap notifications (UDP: 162)                                                                                                                                                                                                                                                |
| GSS            | SSH (TCP:22)                    | Discover chassis configuration and monitoring operational status of DNS rules and VIP answers.                                                                                                                                                                                                                                        |
|                | RMI (TCP:2001 & TCP:3009)       | Activate/suspend DNS rules and VIP answers.                                                                                                                                                                                                                                                                                           |
| vCenter Server | Default HTTPS (TCP:443)         | Communicate with the vCenter Server and vSphere Client in a VMware virtual data center environment.<br><br>For more information about using the plug-in that is available with ANM to integrate ANM with a VMware virtual data center environment, see <a href="#">Appendix B, "Using the ANM Plug-In With Virtual Data Centers."</a> |



## APPENDIX **B**

# Using the ANM Plug-In With Virtual Data Centers

---

**Date:** 3/28/12

This appendix describes how to integrate ANM sever with VMware vCenter Server, which is a third-party product for creating and managing virtual data centers. Using VMware vSphere Client, you can access ANM functionality and manage the ACE real servers that provide load-balancing services for the virtual machines in your virtual data center.



**Note**

---

When naming ACE objects (such as a real server, virtual server, parameter map, class map, health probe, and so on), enter an alphanumeric string of 1 to 64 characters, which can include the following special characters: underscore (\_), hyphen (-), dot (.), and asterisk (\*). Spaces are not allowed.

If you are using ANM with an ACE module or ACE appliance and you configure a named object at the ACE CLI, keep in mind that ANM does not support all of the special characters that the ACE CLI allows you to use when configuring a named object. If you use special characters that ANM does not support, you may not be able to import or manage the ACE using ANM.

---

This appendix includes the following sections:

- [Information About Using ANM With VMware vCenter Server, page B-2](#)
- [Information About the Cisco ACE SLB Tab in vSphere Client, page B-3](#)
- [Prerequisites for Using ANM With VMware vSphere Client, page B-4](#)
- [Guidelines and Restrictions, page B-5](#)
- [Registering or Unregistering the ANM Plug-in, page B-5](#)
- [Logging In To ANM from VMware vSphere Client, page B-7](#)
- [Using the Cisco ACE SLB Tab, page B-8](#)
- [Managing ACE Real Servers From vSphere Client, page B-12](#)
- [Using the VMware vSphere Plug-in Manager, page B-22](#)

## Information About Using ANM With VMware vCenter Server

This section describes how you can integrate ANM server into a VMware virtual data center environment. This feature enables you to access ANM functionality from within the VMware environment to provision the application delivery services that the ACE real servers provide.

ANM version 3.1 and later includes the ANM plug-in for vCenter Server that enables the integration of ANM with the VMware environment as shown in [Figure B-1](#).

**Figure B-1** ANM Integrated With VMware vCenter Server and vSphere Client

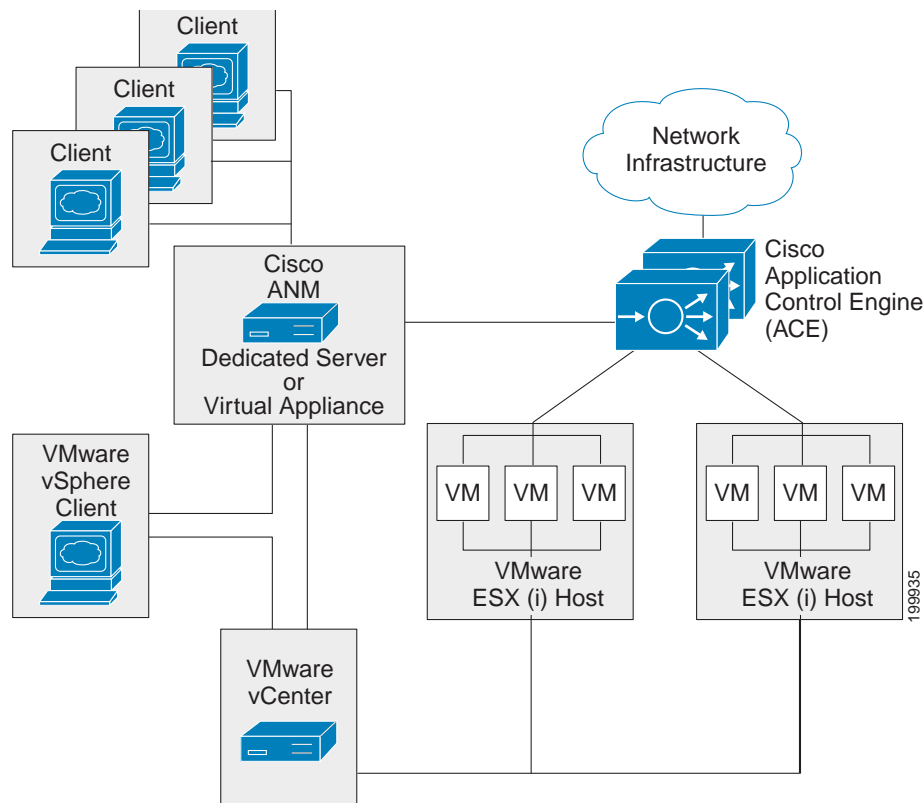

From the ANM GUI, you register the ANM plug-in by specifying a VMware vCenter Server and ANM server attributes that enables ANM to communicate with VMware vCenter Server and vSphere Client using HTTPS and default port 443. When the plug-in is registered, the VMware vSphere Client GUI displays the Cisco ACE SLB tab when you select a virtual machine (VM) from the client GUI.

You click on the Cisco ACE SLB tab to log into ANM from the VMware vSphere Client and perform the following tasks:

- Define a virtual machine (VM) as a real server on ANM and associate it with an existing ACE virtual context and server farm.
- Monitor application traffic flow for virtual machines through the ACE.
- Activate and suspend application traffic flows through the ACE for the associated real servers.
- Add or delete real servers from the list of servers associated with a VM.

**Note**

In addition to ACE devices, the Cisco ACE SLB tab also displays services on the Content Services Switch (CSS) and real servers on the Cisco Content Switching Module (CSM) devices associated with a virtual machine. For these device types, from the Cisco ACE SLB tab, you can activate or suspend the services or real servers but you cannot add or delete these items.

For information about how ANM maps real servers to VMware virtual machines, see the “[Mapping Real Servers to VMware Virtual Machines](#)” section on page 5-68.

For more information about the Cisco ACE SLB tab, see the “[Information About the Cisco ACE SLB Tab in vSphere Client](#)” section on page B-3 and “[Using the Cisco ACE SLB Tab](#)” section on page B-8.

## Information About the Cisco ACE SLB Tab in vSphere Client

This section describes the components of the Cisco ACE SLB tab that display in vSphere Client when you choose a VM from the VM tree (see [Figure B-2](#)).

**Figure B-2** Cisco ACE SLB Tab in vSphere Client

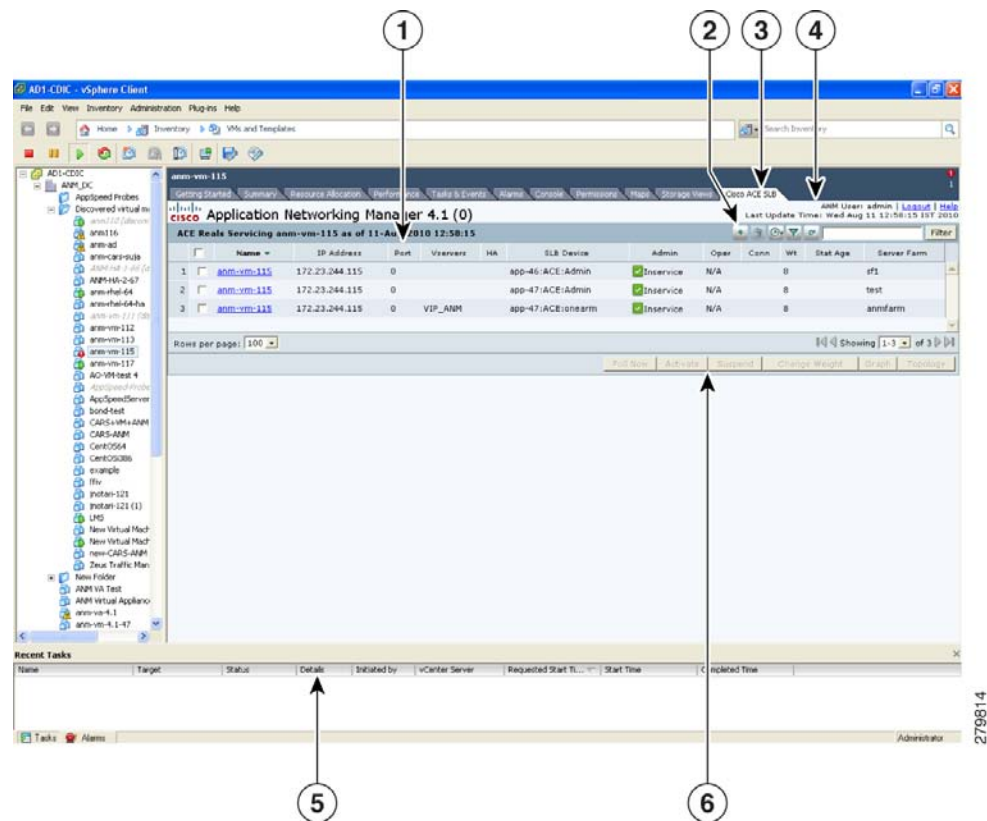

Table B-1 describes the callouts in [Figure B-2](#).

Table B-1 Cisco ACE SLB Tab Components

| Item | Description                                                                                                                                                                                                                                                                                                                                                                                                                                                                                                                                                                              |
|------|------------------------------------------------------------------------------------------------------------------------------------------------------------------------------------------------------------------------------------------------------------------------------------------------------------------------------------------------------------------------------------------------------------------------------------------------------------------------------------------------------------------------------------------------------------------------------------------|
| 1    | Content area that displays the ACE real servers associated with the VM that you select from the VM tree located on the left (see the <a href="#">“Using the Cisco ACE SLB Tab”</a> section on page B-8).                                                                                                                                                                                                                                                                                                                                                                                 |
| 2    | Upper set of function buttons that enable you to add or delete real servers from the content area and manage the displayed information (see the <a href="#">“Using the Cisco ACE SLB Tab”</a> section on page B-8).                                                                                                                                                                                                                                                                                                                                                                      |
| 3    | Cisco ACE SLB tab that you click to display and manage the ACE real servers for the selected VM.                                                                                                                                                                                                                                                                                                                                                                                                                                                                                         |
| 4    | Session information that provides the following information and functions: <ul style="list-style-type: none"> <li>• Current user logged into ANM.</li> <li>• Logout link that you click on to close the session.</li> <li>• Help link that you click on to open the ANM online help for the Cisco ACE SLB tab.</li> <li>• ANM server time stamp of when the information displayed in the tab was last updated.</li> </ul>                                                                                                                                                                |
| 5    | Recent Tasks area that displays VMware tasks.                                                                                                                                                                                                                                                                                                                                                                                                                                                                                                                                            |
| 6    | Lower set of function buttons that you use to update the information displayed, activate or suspend a real sever, change the weight assigned to a real server, view real server connection information in graph form, view the topology map associated with a real server.<br><br>For more information about these function buttons, see the following sections: <ul style="list-style-type: none"> <li>• <a href="#">“Using the Cisco ACE SLB Tab”</a> section on page B-8</li> <li>• <a href="#">“Managing ACE Real Servers From vSphere Client”</a> section on page B-12).</li> </ul> |

## Prerequisites for Using ANM With VMware vSphere Client

The prerequisites for integrating ANM with VMware vCenter Server and vSphere Client are as follows:

- You must use ANM version 3.1 or later with VMware vSphere 4 or vSphere 5.
- You must register the ANM plug-in from within ANM to enable communication between the two applications (see the [“Registering or Unregistering the ANM Plug-in”](#) section on page B-5).
- If you are running VMware vSphere Client on a Windows Server 2003 or 2008 operating system, make sure that the following Internet security options (Internet options > Security setting) are enabled:
  - Allow META REFRESH
  - Allow scripting of Internet Explorer web browser control

These options are not enabled by default. If they are disabled, the ANM plug-in will not allow you to log in to ANM for security reasons or you may encounter refresh problems with the Cisco ACE SLB tab.



### Note

We recommend that you have VMware Tools installed on the guest OS of each VM to allow ANM to match a real server with a VM based on the IP address rather than a server name (see the [“Mapping Real Servers to VMware Virtual Machines”](#) section on page 5-68).



# Guidelines and Restrictions

Follow these guidelines and restrictions when integrating ANM with VMware vCenter Server and vSphere Client:

- There are no shared logins or trust established between ANM and vCenter Server when you open a session between the two servers.
- You can configure both ANM and vCenter Server to use Active Directory for authentication.
- From ANM, you must register the ANM plug-in before you can see the Cisco ACE SLB tab from VMware vSphere Client (see the [“Registering or Unregistering the ANM Plug-in” section on page B-5](#)). When you register the plug-in, the VMware vSphere Client display refreshes and displays the Cisco ACE SLB tab.
- ANM supports one registered ANM plug-in instance only, which means that you can register only one plug-in at any given time.

For example, if you register the plug-in from ANM Server A and then register the plug-in from ANM Server B, the following actions occur:

- The ANM Server A plug-in is unregistered.
- Any VMware vSphere Client that was running when the ANM Server B plug-in was registered will continue to display ANM Server A’s information in the Cisco ACE SLB tab. You must restart VMware vSphere Client to access and display ANM Server B’s information.
- If you are going to uninstall ANM from the ANM server, make sure that you unregister the ANM plug-in before you uninstall ANM. If you do not unregister the plug-in before the uninstall, from VMware vSphere Client, the plug-in will display as registered but will fail to load.

For information about unregistering the ANM plug-in, see the [“Registering or Unregistering the ANM Plug-in” section on page B-5](#). For information about uninstalling ANM, see one of the following guides depending on your ANM application:

- [Installation Guide for Cisco Application Networking Manager 5.2](#)
- [Installation Guide for the Cisco Application Networking Manager 5.2 Virtual Appliance](#)

## Registering or Unregistering the ANM Plug-in

**Note**

---

This feature requires the admin role for ANM.

---

This section describes how to register the ANM plug-in from ANM, which allows you to access ANM ACE real server functionality from VMware vSphere Client. Registering the plug-in provides the client with a URL to access ANM and retrieve the required XML definition file. ANM uses HTTPS for communication with VMware vCenter Server.

You can also unregister the ANM plug-in from ANM.

**Note**

---

Unregistering the ANM plug-in does not prevent access to the ANM server or remove the Cisco ACE SLB tab from any VMware vSphere Client display that was running when you unregistered the plug-in. You must restart the client to remove the Cisco ACE SLB tab from the display. A VMware vSphere Client restart is also required when you unregister a ANM plug-in from one ANM server and register another plug-in from a second ANM server.

---

**Guidelines and Restrictions**

When registering the ANM plug-in, you specify the VMware vCenter Server and ANM server. If you specify the servers using server names rather than IP addresses, the names must be in DNS and must be consistent throughout the network. If the server names reside only in local /etc/host files, then use IP addresses in place of the server names; otherwise, the ANM server and vCenter Server may not be able to communicate and errors may occur, including the inability to enable the plug-in or the inability for real server mapping (empty tables).



**Procedure**

**Step 1** From ANM, choose **Admin > ANM Management > Virtual Center Plugin Registration**.

The VMware Virtual Center PlugIn Registration window appears.

**Step 2** Register or unregister the ANM plug-in using the information in [Table B-2](#).

**Table B-2** Virtual Center Plugin Registration

| Field                          | Description                                                                                                                                                                                                                                                                                                                                                                                                                                                                                                                                                                                                                                                                                                                                                                                                    |
|--------------------------------|----------------------------------------------------------------------------------------------------------------------------------------------------------------------------------------------------------------------------------------------------------------------------------------------------------------------------------------------------------------------------------------------------------------------------------------------------------------------------------------------------------------------------------------------------------------------------------------------------------------------------------------------------------------------------------------------------------------------------------------------------------------------------------------------------------------|
| Virtual Center Server          | IP address of the VMware vCenter Server.<br><br><b>Note</b> Do not use a DNS name to specify the vCenter Server.                                                                                                                                                                                                                                                                                                                                                                                                                                                                                                                                                                                                              |
| Port                           | Port number of the VMware vCenter Server.                                                                                                                                                                                                                                                                                                                                                                                                                                                                                                                                                                                                                                                                                                                                                                      |
| Virtual Center Server Username | VMware vCenter Server username that has the administrator role or an equivalent role that has privilege on “Extension.”                                                                                                                                                                                                                                                                                                                                                                                                                                                                                                                                                                                                                                                                                        |
| Virtual Center Server Password | Password that corresponds to the VMware vCenter Server username.                                                                                                                                                                                                                                                                                                                                                                                                                                                                                                                                                                                                                                                                                                                                               |
| ANM Server                     | DNS name or IP address of the ANM server that will be used by VMware vSphere Client. By default, ANM populates this field with the virtual IP address or hostname or all of the available IP addresses. If you enter a DNS name, make sure that the name can be resolved on the VMware vSphere Client side of the network.<br><br><b>Note</b> For ANM servers operating in an HA configuration, choose the shared alias IP address or VIP address for the HA pair so that the plug-in can still be used after an HA failover occurs.                                                                                                                                                                                        |
| Status                         | Current status of the registration or unregistration operation.<br>Possible status states are as follows: <ul style="list-style-type: none"> <li>• Blank (no status displayed)—The registration operation has not been invoked.</li> <li>• Success in registration—ANM has successfully completed the registration operation.</li> <li>• Failure—ANM is unable to complete the registration operation and displays an error message that indicates the problem encountered (see <a href="#">Table B-3</a>).</li> <li>• Registering—ANM is in the process of registering the ANM plug-in. This state displays when you click the Registration button a second time before the process is complete.</li> <li>• Success in unregistration—ANM has successfully completed the unregistration operation.</li> </ul> |

**Step 3** Do one of the following:

- Click **Register** to register the ANM plug-in. ANM can now be accessed through VMware vSphere Client (see the [“Logging In To ANM from VMware vSphere Client”](#) section on page B-7).
- Click **UnRegister** to unregister the ANM plug-in.

[Table B-3](#) describes the error messages that ANM can display when it encounters a problem with registering the plug-in.

**Table B-3** Virtual Center Registration Failure Messages

| Error Message                                                                                                                                                        | Root Cause                                                                                                                                                                                                                                |
|----------------------------------------------------------------------------------------------------------------------------------------------------------------------|-------------------------------------------------------------------------------------------------------------------------------------------------------------------------------------------------------------------------------------------|
| Virtual center is not reachable, please correct value for the virtual center IP address or DNS name.                                                                 | The ANM server is unable to ping the specified VMware vCenter Server DNS name or IP address.                                                                                                                                              |
| Cannot access virtual center web service interface, please make sure that the value of the virtual center server is correct or the virtual server is up and running. | The ANM server is able to ping VMware vCenter Server but it cannot connect to the webservice API. Most likely, the specified DNS name or IP address does not have the virtual center server running or the virtual server is not running. |
| Invalid username or password for virtual center, please make sure that the username and password is correct.                                                         | The specified username or password for VMware vCenter Server is not valid.                                                                                                                                                                |
| User does not have permission to register or unregister plugin on virtual center server.                                                                             | The specified username is not the VMware vCenter Server administrator or does not have privilege on extension (plugin register/unregister/update).                                                                                        |

## Logging In To ANM from VMware vSphere Client

This section describes how to log into ANM from VMware vSphere Client and establish a session for accessing ANM functionality. The session remains active unless there is a web timeout, you log out, or there is an ANM or VMware vCenter Server restart. The default web session inactivity timeout is 30 minutes.

### Prerequisites

From ANM, you must have the ANM plug-in registered before you can log into ANM from VMware vSphere Client (see the [“Registering or Unregistering the ANM Plug-in”](#) section on page B-5).

### Guidelines and Restrictions

This topic includes the following guidelines and restrictions:

- When registering the ANM plug-in, you specify the VMware vCenter Server and ANM server. If you specify the servers using server names rather than IP addresses, the names must be in DNS and must be consistent throughout the network. If the server names reside only in local /etc/host files, then use IP addresses in place of the server names; otherwise, the ANM server and vCenter Server may not be able to communicate and errors may occur, including the inability to enable the plug-in and log in to ANM or the inability for real server mapping (empty tables). For information about registering the plug-in, see the [“Registering or Unregistering the ANM Plug-in”](#) section on page B-5.

- When logging into ANM from VMware vSphere Client and you have ANM configured to use remote authentication, such as RADIUS, TACACS+, or LDAPS/AD, use the credentials assigned to you for the specific remote authentication method.

### Procedure

- 
- Step 1** From VMware vSphere Client, do one of the following:
- To access ANM within the VMware vSphere Client window, choose a VM from the VM tree and click the **Cisco ACE SLB** tab.
  - To access ANM in a new browser window, right-click on a VM in the VM tree to open the submenu and choose **Cisco ACE Activate/Suspend**.
- The Security Alert popup window appears. This popup appears because ANM uses a Cisco self-signed certificate.
- Step 2** From the Security Alert popup window, click **Yes** to proceed.
- The popup window closes and the ANM login window appears. By default, the name of the user currently logged into VMware vSphere Client displays in the User Name field.
- Step 3** Enter your username (if it is not already displayed) and password.
- Step 4** Click **Login**.
- The Cisco Application Networking Manager window appears in the Cisco ACE SLB tab. For information about what displays in this window, see the [“Using the Cisco ACE SLB Tab” section on page B-8](#). For information about how to use this window to manage the real servers, see the [“Managing ACE Real Servers From vSphere Client” section on page B-12](#).
- Step 5** (Optional) To log out of ANM, click **Logout**.
- The session closes and the ANM login window appears in the Cisco ACE SLB tab.
- 

## Using the Cisco ACE SLB Tab

This section describes the Cisco device information and management functionality that is available when you click the Cisco ACE SLB tab.



### Note

The ACE real server information displays only after you log into ANM from VMware vSphere Client (see the [“Logging In To ANM from VMware vSphere Client” section on page B-7](#)).

The Cisco ACE SLB tab contains the ACE Reals (real servers) table. [Table B-4](#) describes the real server information available in the table.

**Table B-4** *ACE Reals Table Fields*

| Field       | Description                                                                                                                                                                                                                                                                                                                                                                                                                                                                                                                                                                                                                                                                                                                                 |
|-------------|---------------------------------------------------------------------------------------------------------------------------------------------------------------------------------------------------------------------------------------------------------------------------------------------------------------------------------------------------------------------------------------------------------------------------------------------------------------------------------------------------------------------------------------------------------------------------------------------------------------------------------------------------------------------------------------------------------------------------------------------|
| Name        | <p>Name of real server on the ACE, CSS, CSM, or CSM-S. Although the Cisco ACE SLB tab is primarily used to monitor and manage ACE real servers, you can also monitor, activate, and suspend CSS, CSM, and CSM-S devices from this tab.</p> <p>The real server name is a link that displays the Real Server Details popup window, which provides operating information about the server (see the <a href="#">“Monitoring Real Server Details Using vSphere Client”</a> section on page B-19).</p>                                                                                                                                                                                                                                            |
| IP Address  | Real server IP address.                                                                                                                                                                                                                                                                                                                                                                                                                                                                                                                                                                                                                                                                                                                     |
| Port        | Real server port number.                                                                                                                                                                                                                                                                                                                                                                                                                                                                                                                                                                                                                                                                                                                    |
| Admin State | <p>Administrative state of the real server as follows:</p> <ul style="list-style-type: none"> <li>• In Service</li> <li>• Out Of Service</li> <li>• In Service Standby.</li> </ul> <p> <b>Note</b> For CSM and CSM-S real servers, ANM infers the admin state based on the operational state that it receives through SNMP rather than the CLI, which may result in an admin state display that is not correct. For example, when you change the operational state of a CSM real server from Out of Service to Inservice, the admin state display should also change to In Service; however, the admin state display may remain set to Out of Service.</p> |

Table B-4 ACE Reals Table Fields (continued)

| Field       | Description                                                                                                                                                                                                                                                                                                                                                                                                                                                                                                                                                                                                                                                                                                                                                                                                                                                                                                                                                                                                                                                                                                                                                                                                                                                                                                                                                                                                                                                                                                                                                                                                                                                                                                                                                                                                                                                                                                                                                                                                                                                                                                                                        |
|-------------|----------------------------------------------------------------------------------------------------------------------------------------------------------------------------------------------------------------------------------------------------------------------------------------------------------------------------------------------------------------------------------------------------------------------------------------------------------------------------------------------------------------------------------------------------------------------------------------------------------------------------------------------------------------------------------------------------------------------------------------------------------------------------------------------------------------------------------------------------------------------------------------------------------------------------------------------------------------------------------------------------------------------------------------------------------------------------------------------------------------------------------------------------------------------------------------------------------------------------------------------------------------------------------------------------------------------------------------------------------------------------------------------------------------------------------------------------------------------------------------------------------------------------------------------------------------------------------------------------------------------------------------------------------------------------------------------------------------------------------------------------------------------------------------------------------------------------------------------------------------------------------------------------------------------------------------------------------------------------------------------------------------------------------------------------------------------------------------------------------------------------------------------------|
| Oper State  | <p>Operational state of the real server as follows:</p> <ul style="list-style-type: none"> <li>• ARP Failed—Corresponding VLAN interface is not configured for the real server.</li> <li>• Failed—Server has failed and will not be retried for the amount of time specified by its retry timer.</li> <li>• Inband probe failed—Server has failed the inband Health Probe agent.</li> <li>• Inservice—Server is in use as a destination for server load balancing client connections.</li> <li>• Inservice standby—Server is the backup real server, which remains inactive unless the primary real server fails.</li> <li>• Operation wait—Server is ready to become operational but is waiting for the associated redirect virtual server to be in service.</li> <li>• Out of service—Server is not in use by a server load balancer as a destination for client connections.</li> <li>• Probe failed—Server load-balancing probe to this server has failed. No new connections will be assigned to this server until a probe to this server succeeds.</li> <li>• Probe testing—Server has received a test probe from the server load balancer.</li> <li>• Ready to test—Server has failed and its retry timer has expired; test connections will begin flowing to it soon.</li> <li>• Return code failed—Server has been disabled because it returned an HTTP code that matched a configured value.</li> <li>• Test wait—Server is ready to be tested. This state is applicable only when the server is used for HTTP redirect load balancing.</li> <li>• Testing—Server has failed and has been given another test connection. The success of this connection is not known.</li> <li>• Throttle: DFP—DFP has lowered the weight of the server to throttle level; no new connections will be assigned to the server until DFP raises its weight.</li> <li>• Throttle: max clients—Server has reached its maximum number of allowed clients.</li> <li>• Throttle: max connections—Server has reached its maximum number of connections and is no longer being given connections.</li> <li>• Unknown—State of the server is not known.</li> </ul> |
| Conns       | Number of concurrent connections.                                                                                                                                                                                                                                                                                                                                                                                                                                                                                                                                                                                                                                                                                                                                                                                                                                                                                                                                                                                                                                                                                                                                                                                                                                                                                                                                                                                                                                                                                                                                                                                                                                                                                                                                                                                                                                                                                                                                                                                                                                                                                                                  |
| Weight      | Weight assigned to the real server.                                                                                                                                                                                                                                                                                                                                                                                                                                                                                                                                                                                                                                                                                                                                                                                                                                                                                                                                                                                                                                                                                                                                                                                                                                                                                                                                                                                                                                                                                                                                                                                                                                                                                                                                                                                                                                                                                                                                                                                                                                                                                                                |
| Server Farm | Server farm that the real server is associated with.                                                                                                                                                                                                                                                                                                                                                                                                                                                                                                                                                                                                                                                                                                                                                                                                                                                                                                                                                                                                                                                                                                                                                                                                                                                                                                                                                                                                                                                                                                                                                                                                                                                                                                                                                                                                                                                                                                                                                                                                                                                                                               |
| Vserver     | Name of the Vserver.                                                                                                                                                                                                                                                                                                                                                                                                                                                                                                                                                                                                                                                                                                                                                                                                                                                                                                                                                                                                                                                                                                                                                                                                                                                                                                                                                                                                                                                                                                                                                                                                                                                                                                                                                                                                                                                                                                                                                                                                                                                                                                                               |

**Table B-4** ACE Reals Table Fields (continued)

| Field  | Description                                                                                                                                                                                                                                                                                                                                                                                                                                                                                                                                                                                                                                                                                                                                                                                                                       |
|--------|-----------------------------------------------------------------------------------------------------------------------------------------------------------------------------------------------------------------------------------------------------------------------------------------------------------------------------------------------------------------------------------------------------------------------------------------------------------------------------------------------------------------------------------------------------------------------------------------------------------------------------------------------------------------------------------------------------------------------------------------------------------------------------------------------------------------------------------|
| Device | ACE, CSS, CSM, or CSM-S on which the real server is configured.                                                                                                                                                                                                                                                                                                                                                                                                                                                                                                                                                                                                                                                                                                                                                                   |
| HA     | <p>Indicators that display when the real server is part of a high availability pair. The indicators are as follows:</p> <ul style="list-style-type: none"> <li>Asterisk (*)—The real server is associated with an HA pair and the HA configuration is complete.</li> <li>Red dash (-)—The real server is associated with an HA pair; however, the HA configuration is incomplete. Typically, the HA pair are not properly configured for HA or only one of the servers has been imported into ANM. Ensure that both servers are imported into ANM and that they are configured as described in the “<a href="#">Configuring ACE High Availability</a>” section on page 13-14.</li> </ul> <p>The table displays HA pair real servers together in the same row and they remain together no matter how you sort the information.</p> |

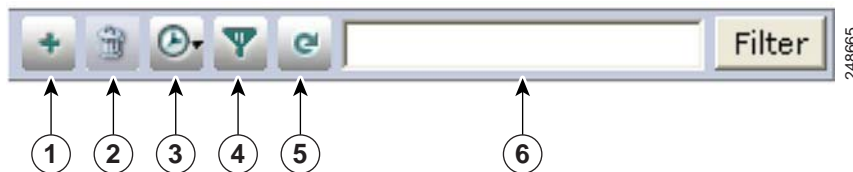

In the table, N/A indicates that either the information is not available from the database or that it is not being collected through SNMP.

The Cisco ACE SLB tab also contains a number of function buttons that enable you to manage the displayed information and the real servers. [Figure B-3](#) shows the function buttons that are located at the top of the ACE Reals table.

**Figure B-3** Cisco ACE SLB Tab Upper Function Buttons

[Table B-5](#) describes each of the function buttons shown in [Figure B-3](#)

**Table B-5** The Cisco ACE SLB Tab Upper Function Button Descriptions

| Number | Function    | Description                                                                                                                                                                                                                                                                                                                              |
|--------|-------------|------------------------------------------------------------------------------------------------------------------------------------------------------------------------------------------------------------------------------------------------------------------------------------------------------------------------------------------|
| 1      | Add         | <p>Adds a real server to the list of servers that can service the VM (see the “<a href="#">Adding a Real Server</a>” section on page B-13).</p> <p> <b>Note</b> This feature is available for ACE devices only.</p>                                   |
| 2      | Delete      | <p>Deletes the selected server from the list of servers that can service the VM (see the “<a href="#">Deleting a Real Server Using vSphere Client</a>” section on page B-14).</p> <p> <b>Note</b> This feature is available for ACE devices only.</p> |
| 3      | AutoRefresh | Enables the auto refresh feature and sets the refresh cycle time. Values are Off, 30 seconds, 1 minute, 2 minutes, or 5 minutes.                                                                                                                                                                                                         |
| 4      | Filter      | Enables the column filter and provides access to saved filters.                                                                                                                                                                                                                                                                          |

**Table B-5** The Cisco ACE SLB Tab Upper Function Button Descriptions

| Number | Function    | Description               |
|--------|-------------|---------------------------|
| 5      | Refresh     | Refreshes the window.     |
| 6      | Filter tool | Filters over all columns. |

Table B-6 describes the function buttons located across the bottom of the Cisco ACE SLB tab.

**Table B-6** Cisco ACE SLB Tab Lower Function Button Descriptions

| Function      | Description                                                                                                                                                                                                                    |
|---------------|--------------------------------------------------------------------------------------------------------------------------------------------------------------------------------------------------------------------------------|
| Poll Now      | Polls the device to update the displayed information (see the <a href="#">“Refreshing the Displayed Real Server Information”</a> section on page B-20).                                                                        |
| Activate      | Activates the services of the selected server (see the <a href="#">“Activating Real Servers Using vSphere Client”</a> section on page B-15).                                                                                   |
| Suspend       | Suspends the services of the selected server (see the <a href="#">“Suspending Real Servers Using vSphere Client”</a> section on page B-16).                                                                                    |
| Change Weight | Changes the weight of the selected server (see the <a href="#">“Modifying Real Server Weight Value Using vSphere Client”</a> section on page B-18).                                                                            |
| Graph         | Displays connection information for a selected real server in graph form. To exit a graph view and return to the ACE Real Server table, click <b>Exit Graph</b> .                                                              |
| Topology      | Displays a network topology map for a selected real server (see <a href="#">“Displaying Network Topology Maps”</a> section on page 17-68). To exit a topology map and return to the ACE Real Server table, click <b>Exit</b> . |

**Related Topics**

- [Information About Using ANM With VMware vCenter Server, page B-2](#)
- [Logging In To ANM from VMware vSphere Client, page B-7](#)
- [Managing ACE Real Servers From vSphere Client, page B-12](#)
- [Using the VMware vSphere Plug-in Manager, page B-22](#)

## Managing ACE Real Servers From vSphere Client

This section describes how to perform real server management tasks from the Cisco ACE SLB tab after you log into ANM from VMware vSphere Client (see the [“Logging In To ANM from VMware vSphere Client”](#) section on page B-7). These tasks include adding a VM as a real server to an existing server farm or suspending and activating the operation of a real server associated with a VM.

This section includes the following topics:

- [Adding a Real Server, page B-13](#)
- [Deleting a Real Server Using vSphere Client, page B-14](#)
- [Activating Real Servers Using vSphere Client, page B-15](#)
- [Suspending Real Servers Using vSphere Client, page B-16](#)
- [Modifying Real Server Weight Value Using vSphere Client, page B-18](#)
- [Monitoring Real Server Details Using vSphere Client, page B-19](#)



- [Refreshing the Displayed Real Server Information, page B-20](#)

## Adding a Real Server

You can add one or more real servers to the list of ACE real servers associated with a VM. The Cisco ACE SLB tab allows you select a VM and define it as a real server on ANM, associating it with an existing ACE virtual context and server farm.

### Guidelines and Limitations

You can add only one real server at a time. Repeat the procedure in this section for each real server that you want to add.

### Procedure

- 
- Step 1** From the VM tree in VMware vSphere Client, do one of the following:
- To display the ACE real server information in the current window, click on a VM and then click the **Cisco ACE SLB** tab.
  - To display the ACE real server information in a new window, right-click on a VM to open the submenu and choose **Cisco ACE Activate/Suspend**.
- The Security Alert popup window appears. This popup window appears because ANM uses a Cisco self-signed certificate.
- Step 2** From the Security Alert popup window, click **Yes** to proceed.
- The popup window closes and the Cisco Application Networking Manager window appears, displaying the ACE Reals table.
- Step 3** From the ACE Reals table, click **Add**.
- The Real Server Configurations dialog box appears.
- Step 4** From the Real Server Configurations dialog window, configure the real server to add using the information in [Table B-7](#).

**Table B-7** Real Server Attributes

| Field                  | Description                                                                                                                                                                                                                                                    |
|------------------------|----------------------------------------------------------------------------------------------------------------------------------------------------------------------------------------------------------------------------------------------------------------|
| Real Server Name       | Unique name for this server. By default, the name of the selected VM is displayed. Valid entries are unquoted text strings with no spaces and a maximum of 64 characters.                                                                                      |
| Real Server IP Address | Unique IP address in dotted-decimal format (such as 192.168.11.1). The drop-down list is populated with the IP address or addresses assigned to the selected VM. If no IP addresses were found for the VM, you can manually enter an IP address in this field. |
| Real Server Port       | Real server port number. Valid entries are from 1 to 65535.                                                                                                                                                                                                    |
| Real Server Weight     | Weight to assign to this real server in a server farm. Valid entries are 1 to 100. The default is 8.                                                                                                                                                           |

**Table B-7** Real Server Attributes (continued)

| Field               | Description                                                                                                                                                                                                                                                                                                                                                                                     |
|---------------------|-------------------------------------------------------------------------------------------------------------------------------------------------------------------------------------------------------------------------------------------------------------------------------------------------------------------------------------------------------------------------------------------------|
| Real Server State   | State of the real server: <ul style="list-style-type: none"> <li>In Service—ANM places the real server in the in service state when it is added. This is the default setting.</li> <li>In Service Standby—ANM places the real server in the service standby state when it is added.</li> <li>Out Of Service—ANM places the real server in the out of service state when it is added.</li> </ul> |
| ACE Virtual Context | ACE virtual context that has the server farm that the real server is to be associated with.                                                                                                                                                                                                                                                                                                     |
| Serverfarm          | Server farms associated with the selected ACE virtual context.                                                                                                                                                                                                                                                                                                                                  |
| Virtual Servers     | Virtual server names and VIPs that are associated with the selected server farm.                                                                                                                                                                                                                                                                                                                |

**Step 5** Do one of the following:

- Click **Deploy Now**. The Real Server Configurations dialog box closes and ANM adds the real server to the list of servers that can service the VM depending on how you set the Real Server State attribute.
- Click **Cancel**. The Real Server Configurations dialog box closes and no real server is added.

#### Related Topics

- [Logging In To ANM from VMware vSphere Client, page B-7](#)
- [Using the Cisco ACE SLB Tab, page B-8](#)
- [Deleting a Real Server Using vSphere Client, page B-14](#)
- [Activating Real Servers Using vSphere Client, page B-15](#)
- [Suspending Real Servers Using vSphere Client, page B-16](#)
- [Modifying Real Server Weight Value Using vSphere Client, page B-18](#)
- [Monitoring Real Server Details Using vSphere Client, page B-19](#)
- [Refreshing the Displayed Real Server Information, page B-20](#)

## Deleting a Real Server Using vSphere Client

You can remove a real server from the list of servers that service the VM.

#### Procedure

**Step 1** From the VM tree in VMware vSphere Client, do one of the following:

- To display the ACE real server information in the current window, click on a VM and then click the **Cisco ACE SLB** tab.
- To display the ACE real server information in a new window, right-click on a VM to open the submenu and choose **Cisco ACE Activate/Suspend**.

The Security Alert popup window appears. This popup window appears because ANM uses a Cisco self-signed certificate.

**Step 2** From the Security Alert popup window, click **Yes** to proceed.

The popup window closes and the Cisco Application Networking Manager window appears, displaying the ACE Reals table.

**Step 3** From the ACE Reals table, check the checkbox of each server that you want to delete from the table.

**Step 4** Click **Delete**.

The confirmation popup window appears requesting you to verify that you want to delete the server.

**Step 5** In the confirmation popup window, click **OK**.

The popup window closes and ANM removes the selected servers from the list of real servers.

### Related Topics

- [Logging In To ANM from VMware vSphere Client, page B-7](#)
- [Using the Cisco ACE SLB Tab, page B-8](#)
- [Adding a Real Server, page B-13](#)
- [Activating Real Servers Using vSphere Client, page B-15](#)
- [Suspending Real Servers Using vSphere Client, page B-16](#)
- [Modifying Real Server Weight Value Using vSphere Client, page B-18](#)
- [Monitoring Real Server Details Using vSphere Client, page B-19](#)
- [Refreshing the Displayed Real Server Information, page B-20](#)

## Activating Real Servers Using vSphere Client

You can activate a real server that services a VM.



### Note

If you are not using the ANM plug-in for vCenter Server to access ANM, see the [“Activating Real Servers”](#) section on page 8-14.

### Procedure

**Step 1** From the VM tree in VMware vSphere Client, do one of the following:

- To display the ACE real server information in the current window, click on a VM and then click the **Cisco ACE SLB** tab.
- To display the ACE real server information in a new window, right-click on a VM to open the submenu and choose **Cisco ACE Activate/Suspend**.

The Security Alert popup window appears. This popup window appears because ANM uses a Cisco self-signed certificate.

**Step 2** From the Security Alert popup window, click **Yes** to proceed.

The popup window closes and the Cisco Application Networking Manager window appears, displaying the ACE Reals table.

**Step 3** From the ACE Reals table, check the check box of the servers that you want to activate and click **Activate**.

The Activate Server window appears.

**Step 4** In the Reason field of the Activate Server window, enter a reason for this action.

You might enter a trouble ticket, an order ticket, or a user message.



---

**Note** Do not enter a password in this field.

---

**Step 5** Do one of the following:

- Click **OK** to activate the server and to return to the ACE Reals table. The server appears in the table with the status Inservice.
  - Click **Cancel** to exit this procedure without activating the server and to return to the ACE Reals table.
- 

#### Related Topics

- [Logging In To ANM from VMware vSphere Client, page B-7](#)
- [Using the Cisco ACE SLB Tab, page B-8](#)
- [Suspending Real Servers Using vSphere Client, page B-16](#)
- [Modifying Real Server Weight Value Using vSphere Client, page B-18](#)
- [Monitoring Real Server Details Using vSphere Client, page B-19](#)
- [Refreshing the Displayed Real Server Information, page B-20](#)

## Suspending Real Servers Using vSphere Client

You can suspend a real server that services a VM.



---

**Note** If you are not using the ANM plug-in for vCenter Server to access ANM, see the [“Suspending Real Servers” section on page 8-15](#).

---

#### Procedure

---

**Step 1** From the VM tree in VMware vSphere Client, do one of the following:

- To display the ACE real server information in the current window, click on a VM and then click the **Cisco ACE SLB** tab.
- To display the ACE real server information in a new window, right-click on a VM to open the submenu and choose **Cisco ACE Activate/Suspend**.

The Security Alert popup window appears. This popup window appears because ANM uses a Cisco self-signed certificate.

**Step 2** From the Security Alert popup window, click **Yes** to proceed.

The popup window closes and the Cisco Application Networking Manager window appears, displaying the ACE Reals table.

**Step 3** In the ACE Reals table, check the check box of the servers that you want to suspend and click **Suspend**. The Suspend Real Servers window appears.

**Step 4** In the Reason field of the Suspend Real Servers window, enter the reason for this action. You might enter a trouble ticket, an order ticket, or a user message.



---

**Note** Do not enter a password in this field.

---

**Step 5** From the Suspend Real Servers Type drop-down list, choose one of the following:

- **Graceful**—When executed on a primary server, the ACE gracefully shuts down the server with sticky connections as follows:
  - Tears down existing non-TCP connections to the server
  - Allows current TCP connections to complete
  - Allows new sticky connections for existing server connections that match entries in the sticky database
  - Load balances all new connections (other than the matching sticky connections mentioned above) to the other servers in the server farm

When executed on a backup real server, the ACE places the backup server in service standby mode.



---

**Note** For the CSS, when the device is in the In Service admin state and you perform a graceful suspend operation, ANM saves the last known non-zero service (or real server) weight, and then sets the weight to zero. ANM references the saved weight when performing an Activate operation. If the current weight is zero, and a non-zero weight has been saved for that service (or real server), the Activate operation also sets the weight to the saved value.

To allow ANM to save and reset the weight value when gracefully suspending and then activating the CSS, you must have the device configured to permit SNMP traffic. For each device type, see the corresponding configuration guide to configure the device to permit SNMP traffic.

When the CSS is in the In Service Standby admin state and you perform a graceful suspend operation, ANM does not set the weight to zero.

---

- **Suspend**—The ACE resets all non-TCP connections to the server. For TCP connections, existing flows are allowed to complete before the ACE takes the real server out of service. No new connections are allowed. The ACE resets all Secure Sockets Layer (SSL) connections to the real server.
- **Suspend and Clear Connections**—The ACE performs the tasks described for Suspend and clears the existing connections to this server.

**Step 6** Do one of the following:

- Click **Deploy Now** to suspend the server and to return to the ACE Reals table. The server appears in the table with the status Out Of Service.
- Click **Cancel** to exit this procedure without suspending the server and to return to the ACE Reals table.

---

#### Related Topics

- [Logging In To ANM from VMware vSphere Client, page B-7](#)
- [Using the Cisco ACE SLB Tab, page B-8](#)
- [Adding a Real Server, page B-13](#)
- [Deleting a Real Server Using vSphere Client, page B-14](#)
- [Activating Real Servers Using vSphere Client, page B-15](#)
- [Modifying Real Server Weight Value Using vSphere Client, page B-18](#)
- [Monitoring Real Server Details Using vSphere Client, page B-19](#)
- [Refreshing the Displayed Real Server Information, page B-20](#)

## Modifying Real Server Weight Value Using vSphere Client

You can modify the weight value assigned to a real server that defines the connection capacity of the server in relation to the other real servers. The ACE uses the weight value that you specify for a server in the weighted round-robin and least-connections load-balancing predictors. Servers with a higher configured weight value have a higher priority with respect to connections than servers with a lower weight. For example, a server with a weight of 5 would receive five connections for every one connection for a server with a weight of 1.



#### Note

If you are not using the ANM plug-in for vCenter Server to access ANM, see the [“Modifying Real Server Weight Value” section on page 8-17](#).

#### Procedure

**Step 1** From the VM tree in VMware vSphere Client, do one of the following:

- To display the ACE real server information in the current window, click on a VM and then click the **Cisco ACE SLB** tab.
- To display the ACE real server information in a new window, right-click on a VM tree to open the submenu and choose **Cisco ACE Activate/Suspend**.

The Security Alert popup window appears. This popup window appears because ANM uses a Cisco self-signed certificate.

**Step 2** From the Security Alert popup window, click **Yes** to proceed.

The popup window closes and the Cisco Application Networking Manager window appears, displaying the ACE Reals table.

**Step 3** In the ACE Reals table, check the check box of the server that you want modify and click **Change Weight**.

The Change Weight Real Servers window appears.

- Step 4** In the Change Weight Real Servers window, enter the following information for the selected server:
- Reason for change such as trouble ticket, order ticket, or user message.



---

**Note** Do not enter a password in this field.

---

- Weight value (for allowable ranges for each device type, see [Table 8-5](#)).
- Step 5** Do one of the following:
- Click **Deploy Now** to accept your entries and to return to the ACE Reals table. The server appears in the table with the updated information.
  - Click **Cancel** to exit this procedure without saving your entries and to return to the ACE Reals table.
- 

#### Related Topics

- [Logging In To ANM from VMware vSphere Client, page B-7](#)
- [Using the Cisco ACE SLB Tab, page B-8](#)
- [Adding a Real Server, page B-13](#)
- [Deleting a Real Server Using vSphere Client, page B-14](#)
- [Activating Real Servers Using vSphere Client, page B-15](#)
- [Monitoring Real Server Details Using vSphere Client, page B-19](#)
- [Refreshing the Displayed Real Server Information, page B-20](#)

## Monitoring Real Server Details Using vSphere Client

You can display detailed operating information about a real server.

#### Procedure

---

- Step 1** From the VM tree in VMware vSphere Client, do one of the following:
- To display the ACE real server information in the current window, click on a VM and then click the **Cisco ACE SLB** tab.
  - To display the ACE real server information in a new window, right-click on a VM to open the submenu and choose **Cisco ACE Activate/Suspend**.

The Security Alert popup window appears. This popup window appears because ANM uses a Cisco self-signed certificate.

- Step 2** From the Security Alert popup window, click **Yes** to proceed.

The popup window closes and the Cisco Application Networking Manager window appears, displaying the ACE Reals table.

- Step 3** In the ACE Reals table, click on the name of the real server whose details you want to view.

The Real Server Details popup window appears and displays the following ACE statistical information:

- Total Connections—Total number of load-balanced connections to this real server in the serverfarm.

- Connections Rate—Connections per second.
- Dropped Connections—Total number of dropped connections because the current connection count exceeds the maximum number of allowed connections.
- Dropped Connections Rate—Dropped connections per second.
- Minimum Connections—Minimum number of connections that need to be supported by the real server in the serverfarm.
- Maximum Connections—Maximum number of connections that can be supported by this real server in the serverfarm.

**Note**

The statistical information that ANM displays for the CSM and CSM-S is different from the ACE information described above. Also, ANM does not display the Real Server Details popup window for the CSS.

**Note**

To close the Real Server Details popup window, you may need to expand the display to access the “X” (close) located in the upper right hand section of the window.

**Related Topics**

- [Logging In To ANM from VMware vSphere Client, page B-7](#)
- [Using the Cisco ACE SLB Tab, page B-8](#)
- [Adding a Real Server, page B-13](#)
- [Deleting a Real Server Using vSphere Client, page B-14](#)
- [Activating Real Servers Using vSphere Client, page B-15](#)
- [Suspending Real Servers Using vSphere Client, page B-16](#)
- [Modifying Real Server Weight Value Using vSphere Client, page B-18](#)
- [Refreshing the Displayed Real Server Information, page B-20](#)

## Refreshing the Displayed Real Server Information

You can refresh the information that ANM displays for a real server.

**Procedure****Step 1**

From the VM tree in VMware vSphere Client, do one of the following:

- To display the ACE real server information in the current window, click on a VM and then click the **Cisco ACE SLB** tab.
- To display the ACE real server information in a new window, right-click on a VM to open the submenu and choose **Cisco ACE Activate/Suspend**.

The Security Alert popup window appears. This popup window appears because ANM uses a Cisco self-signed certificate.



- Step 2** From the Security Alert popup window, click **Yes** to proceed.
- The popup window closes and the Cisco Application Networking Manager window appears, displaying the ACE Reals table.
- Step 3** In the ACE Reals table, check the checkbox next to the name of the real server whose information you want to refresh.
- Step 4** Click **Poll Now**.
- ANM polls the selected device and updates the displayed information.
- 

**Related Topics**

- [Logging In To ANM from VMware vSphere Client, page B-7](#)
- [Using the Cisco ACE SLB Tab, page B-8](#)
- [Adding a Real Server, page B-13](#)
- [Deleting a Real Server Using vSphere Client, page B-14](#)
- [Activating Real Servers Using vSphere Client, page B-15](#)
- [Suspending Real Servers Using vSphere Client, page B-16](#)
- [Modifying Real Server Weight Value Using vSphere Client, page B-18](#)

# Using the VMware vSphere Plug-in Manager

You can use the VMware vSphere Client Plug-in Manager to verify that the ANM plug-in (Cisco ACE) is registered, view error messages, and enable or disable the plug-in.

## Procedure

- Step 1** From the VMware vSphere Client main menu, choose **Plug-ins > Manage Plug-ins**.  
The Plug-in Manager window appears. [Table B-8](#) describes the Cisco plug-in information that displays in the Plug-in Manager window.

**Table B-8** VMware vSphere Client Plug-in Manager

| Item         | Description                                                                                                                                           |
|--------------|-------------------------------------------------------------------------------------------------------------------------------------------------------|
| Plug-in Name | Name of the Cisco plug-in, which is Cisco ACE.                                                                                                        |
| Vendor       | This field is blank. The vendor name, Cisco, is included in the plug-in name.                                                                         |
| Version      | Plug-in version number.                                                                                                                               |
| Status       | Plug-in operating status: Enabled or Disabled.                                                                                                        |
| Description  | Plug-in description, which is Cisco ACE.                                                                                                              |
| Progress     | N/A                                                                                                                                                   |
| Errors       | Errors related to the Cisco ACE plug-in, such as when the VMware vSphere Client cannot find the ANM server because it cannot resolve the server name. |

- Step 2** (Optional) To enable or disable the plug-in, from the list of plug-ins, right-click on the Cisco ACE plug-in and do one of the following:
- Choose **Enable**. The Cisco ACE SLB tab appears in the VMware vSphere Client content area. This is the default setting.
  - Choose **Disable**. The Cisco ACE SLB tab is removed from the VMware vSphere Client content area.

## Related Topics

[Registering or Unregistering the ANM Plug-in, page B-5](#)



## GLOSSARY

Date: 3/28/12

---

### A

- ACE** Cisco Application Control Engine, available as a module that resides in a Cisco Catalyst 6500 series chassis, Cisco 7600 series router, or as a standalone appliance. The ACE offers high-performance server load balancing (SLB), routing and bridging configuration, traffic policies, redundancy (high availability), virtualization for resource management, SSL, security features, and application acceleration and optimization.
- ACL** Access Control List. A mechanism in computer security used to enforce privilege separation. An ACL identifies the privileges and access rights a user or client has to a particular object, such as a server, file system, or application.
- activate** Places an entity into the resource pool for load balancing content requests or connections and starts the keepalive function. *See also* [suspend](#).
- administrative distance** The first criterion a router uses to determine which routing protocol to use if two protocols provide route information for the same destination. Administrative distance is a measure of the trustworthiness of the source of the routing information. Administrative distance has only local significance, and is not advertised in routing updates.
- The smaller the administrative distance value, the more reliable the protocol. The values range from 0 (zero) for a connected interface and 1 for a static route, to 255 for an unknown protocol.
- AES** Advanced Encryption Standard. One of the possible encryption algorithms available for use in SNMP communications.
- ANM Mobile** ANM feature that allows supported mobile devices to access to your ANM server or ANM Virtual Appliance and manage the network objects in much the same way you do from an ANM client. Using a mobile device, you can run ANM Mobile as a native application (app) or inside the mobile device browser.
- ANM server** Dedicated server with ANM server software and Red Hat Enterprise Linux (RHEL) operating system installed on it.
- ANM Virtual Appliance** VMware virtual appliance with ANM server software and Cisco Application Delivery Engine Operating System (ADE OS) installed on it. Cisco distributes ANM Virtual Appliance in Open Virtual Appliance (.OVA) format.
- ARP** Address Resolution Protocol. Internet protocol used to map an IP address to a MAC address. Defined in RFC 826.

---

**B**

- building block** Reusable configuration attributes that can be applied to virtual contexts for consistent, standardized implementation.
- BVI** Bridge-Group Virtual Interface. Logical Layer 3-only interface associated with a bridge group when integrated routing and bridging (IRB) is configured.

---

**C**

- CCM** Cisco CallManager. A Cisco product that provides the software-based, call-processing component of the Cisco IP Telephony Solutions for the Enterprise, part of Cisco AVVID (Architecture for Voice, Video, and Integrated Data). CallManager acts as a signaling proxy for call events initiated over other common protocols such as [SIP](#), ISDN (Integrated Services Digital Network), or MGCP (Media Gateway Control Protocol).
- certificate chain** A certificate chain is a hierarchal list of certificates used in SSL that includes the subject's certificate, the root CA certificate, and any intermediate CA certificates.
- certificate signing request** *See* [CSR](#).
- checkpoint** A snapshot in time of a known stable ACE running configuration before you begin to modify it. If you encounter a problem with the modifications to the running configuration, you can roll back the configuration to the previous stable configuration checkpoint.
- Cisco.com** Replaces the Cisco Connection Online website. Use this site to access customer service and support.
- class map** A mechanism for classifying types of network traffic. The ANM uses class maps to classify the network traffic that is received and transmitted by the ACE. Types of traffic include Layer 3/Layer 4 traffic that can pass through the ACE, network management traffic that can be received by the ACE, and Layer 7 HTTP load-balancing traffic.
- CSR** Certificate Signing Request. A message sent to a certificate authority, such as VeriSign and Thawte to apply for a digital identity certificate for use with SSL. The request includes information that identifies the SSL site, such as location and serial number, and a public key that you choose. The request may also provide any additional proof of identity required by the certificate authority.
- Cisco IOS Software** The Cisco system software that allows centralized, integrated, and automated installation and management of internetworks, while ensuring support for a wide variety of protocols, media, services, and platforms.
- context** *See* [virtual context](#).

---

**D**

- DES** Data Encryption Standard. One of the possible encryption algorithms available for use in SNMP communications.

|                                       |                                                                                                                                                                                      |
|---------------------------------------|--------------------------------------------------------------------------------------------------------------------------------------------------------------------------------------|
| <b>DFP</b>                            | Dynamic Feedback Protocol. A protocol that allows load-balanced servers (both local and remote) to dynamically report changes in their status and their ability to provide services. |
| <b>distinguished name</b>             | Used for SSL, a set of attributes that provides the certificate authority with the information it needs to authenticate your site.                                                   |
| <b>Dynamic Workload Scaling (DWS)</b> | ACE feature that permits on-demand access to remote resources, such as VMs, that you own or lease from an Internet service provider or cloud service provider.                       |

---

## E

|                   |                                                                                                                                                               |
|-------------------|---------------------------------------------------------------------------------------------------------------------------------------------------------------|
| <b>event</b>      | A message from the ANM that informs you of activities on parts of the system, including each virtual context, the management system, and hardware components. |
| <b>event type</b> | Alarm, Log, Audit, Attack Log                                                                                                                                 |
| <b>exception</b>  | A group of related faults.                                                                                                                                    |

---

## F

|                               |                                                                                                                                                                |
|-------------------------------|----------------------------------------------------------------------------------------------------------------------------------------------------------------|
| <b>fault</b>                  | An abnormal condition that occurs when a system component exceeds a performance threshold or is not functioning properly.                                      |
| <b>File Transfer Protocol</b> | See <a href="#">FTP</a> .                                                                                                                                      |
| <b>FTP</b>                    | File Transfer Protocol. Application protocol, part of the TCP/IP protocol stack, used for transferring files between network nodes. FTP is defined in RFC 959. |

---

## H

|              |                                                                                                                                                                                                                                                                                                                                                                                                                                                                                                                                                                                                                                                           |
|--------------|-----------------------------------------------------------------------------------------------------------------------------------------------------------------------------------------------------------------------------------------------------------------------------------------------------------------------------------------------------------------------------------------------------------------------------------------------------------------------------------------------------------------------------------------------------------------------------------------------------------------------------------------------------------|
| <b>H.323</b> | An umbrella recommendation from the ITU Telecommunication Standardization Sector (ITU-T) that defines the protocols that provide audio-visual communication sessions on any packet network. It is a part of the H.32x series of protocols which also address communications over Integrated Services Digital Network (ISDN), Public switched telephone network (PSTN) or Signaling System 7 (SS7). H.323 is commonly used in Voice over IP (VoIP, Internet Telephony, or IP Telephony) and Internet Protocol (IP)-based videoconferencing. H.323 defines a common set of CODECs, call setup and negotiating procedures, and basic data transport methods. |
| <b>HSRP</b>  | Hot Standby Router Protocol. A networking protocol that provides network redundancy for IP networks, ensuring that user traffic immediately and transparently recovers from first hop failures in network edge devices or access circuits.                                                                                                                                                                                                                                                                                                                                                                                                                |

---

**I**

- ICMP** Internet Control Message Protocol. Network layer Internet protocol that reports errors and provides other information relevant to IP packet processing. Documented in RFC 792.
- Internet Control Message Protocol** *See* [ICMP](#).
- interface**
1. A network connection.
  2. A connection between two systems or devices.
  3. In telephony, a shared boundary defined by common physical interconnection characteristics, signal characteristics, and meanings of interchanged signals.

---

**L**

- load balancing** An action that spreads network requests among available servers within a cluster of servers, based on a variety of algorithms.

---

**M**

- MD5** Message Digest 5 or Message-Digest Algorithm. One of the possible encryption algorithms available for use in SNMP communications.
- MIB** Database of network management information that is used and maintained by a network management protocol, such as SNMP or CMIP. The value of a MIB object can be changed or retrieved using SNMP or CMIP commands, usually through a GUI network management system. MIB objects are organized in a tree structure that includes public (standard) and private (proprietary) branches.

---

**N**

- NAT** Name Address Translation. A method of connecting multiple computers to the Internet (or any other IP network) using one IP address.

---

**O**

- object group** A logical grouping of similar objects, such as servers, clients, services, or networks. Creating an object group allows you to apply common attributes to a number of objects without specifying each object individually.
- organizations** An organization allows you to configure AAA server lookup for your users or set up users who work for a service provider customer. Organizations in the Cisco ANM system are defined by the system administrator.

---

**P**

- PAT** Port Address Translation. A mechanism that allows many devices on a LAN to share one IP address by allocating a unique port address at Layer 4.
- ping** A common method for troubleshooting the accessibility of devices.
- A ping tests an ICMP echo message and its reply. Because ping is the simplest test for a device, it is the first to be used. If ping fails, try using traceroute.
- Run ping to view the packets transmitted, packets received, percentage of packet loss, and round-trip time in milliseconds.
- port**
1. An interface on an internetworking device (such as a router); a physical entity.
  2. In IP terminology, an upper-layer process that receives information from lower layers. Ports are numbered, and each numbered port is associated with a specific process. For example, SMTP is associated with port 25. A port number is also called a well-known address.
  3. To rewrite software or microcode so that it will run on a different hardware platform or in a different software environment than that for which it was originally designed.

---

**R**

- RAS** Registration, Admission, and Status Protocol. Protocol that is used between endpoints and the gatekeeper to perform management functions. RAS signalling function performs registration, admissions, bandwidth changes, status, and disengage procedures between the VoIP gateway and the gatekeeper.
- RBAC** Role-Based Access Control. A mechanism that allows privileges to be assigned to defined roles. The roles are then assigned to real users, allowing or limiting access to specific features as appropriate for each role.
- real server** A real server is a physical device assigned to a server farm.
- redundancy** In internetworking, the duplication of devices, services, or connections so that, in the event of a failure, the redundant devices, services, or connections can perform the work of those that failed.
- resource class** A defined set of resources and allocations available for use by a device (such as an ACE). Using resource classes prevents a single device from using all available resources.
- role** *See* [user role](#).
- RSA** Rivest, Shamir, and Adelman Signatures. A public-key cryptographic system used for authentication.
- RTSP** Real Time Streaming Protocol. A client-server multimedia presentation control protocol, designed to address the needs for efficient delivery of streamed multimedia over IP networks.

---

**S**

|                                         |                                                                                                                                                                                                                                                                                                                                                                                                                                                                                                                                                           |
|-----------------------------------------|-----------------------------------------------------------------------------------------------------------------------------------------------------------------------------------------------------------------------------------------------------------------------------------------------------------------------------------------------------------------------------------------------------------------------------------------------------------------------------------------------------------------------------------------------------------|
| <b>SCCP</b>                             | Skiny Client Control Protocol. A proprietary terminal control protocol owned and defined by Cisco as a messaging set between a skinny client and the Cisco CallManager (CCM). Examples of skinny clients include the Cisco 7900 series of IP phone such as the Cisco 7960, Cisco 7940 and the 802.11b wireless Cisco 7920, along with Cisco Unity voicemail server. <i>See also</i> <a href="#">Skinny</a> .                                                                                                                                              |
| <b>server farm</b>                      | A collection of servers that contain the same content.                                                                                                                                                                                                                                                                                                                                                                                                                                                                                                    |
| <b>Server Load Balancer</b>             | <i>See</i> <a href="#">SLB</a> .                                                                                                                                                                                                                                                                                                                                                                                                                                                                                                                          |
| <b>service</b>                          | A destination location where a piece of content resides physically. Also referred to in general terms for this release as including content rules, owners, virtual servers, real servers, and so on.                                                                                                                                                                                                                                                                                                                                                      |
| <b>Simple Message Transfer Protocol</b> | <i>See</i> <a href="#">SMTP</a> .                                                                                                                                                                                                                                                                                                                                                                                                                                                                                                                         |
| <b>SIP</b>                              | Session Initiation Protocol. Protocol developed by the IETF MMUSIC Working Group as an alternative to <a href="#">H.323</a> . SIP features are compliant with IETF RFC 2543, published in March 1999. SIP equips platforms to signal the setup of voice and multimedia calls over IP networks.                                                                                                                                                                                                                                                            |
| <b>Skinny</b>                           | Skinny is a lightweight protocol which allows for efficient communication with Cisco CallManager. <i>See also</i> <a href="#">SCCP</a> .                                                                                                                                                                                                                                                                                                                                                                                                                  |
| <b>SLB</b>                              | Server Load Balancer. A device that makes load balancing decisions based on application availability, server capacity, and load distribution algorithms, such as round robin or least connections. Using load balancing and server/application feedback, an SLB device determines a real server for the packet flow and sends this information to the requesting forwarding agent. After the optimal destination is decided on, all other packets in the packet flow are directed to a real server by the forwarding agent, increasing packet throughput. |
| <b>special configuration file</b>       | Managed file resource on an ACE module, such as a piece of a configuration file or a keep-alive script.                                                                                                                                                                                                                                                                                                                                                                                                                                                   |
| <b>SMTP</b>                             | Simple Message Transfer Protocol. Internet protocol that provides email services.                                                                                                                                                                                                                                                                                                                                                                                                                                                                         |
| <b>sticky</b>                           | A feature that ensures that the same client gets the same server for multiple connections. It is used when applications require a consistent and constant connection to the same server. If you are connecting to a system that keeps state tables about your connection, sticky allows you to get back to the same real server again and retain the statefulness of the system.                                                                                                                                                                          |
| <b>suspend</b>                          | Removes an entity from the resource pool for future load-balancing content requests or connections. Suspending a service or device does not affect existing content flows, but it prevents additional connections from accessing the suspended entity or content. <i>See also</i> <a href="#">activate</a> .                                                                                                                                                                                                                                              |

---

**T**

|                 |                                                                                                                                                                          |
|-----------------|--------------------------------------------------------------------------------------------------------------------------------------------------------------------------|
| <b>TCP</b>      | Transport Control Protocol. Connection-oriented transport layer protocol that provides reliable full-duplex data transmission. TCP is part of the TCP/IP protocol stack. |
| <b>template</b> | <i>See</i> <a href="#">building block</a> .                                                                                                                              |



|                                   |                                                                                                                                                                                                                   |
|-----------------------------------|-------------------------------------------------------------------------------------------------------------------------------------------------------------------------------------------------------------------|
| <b>threshold</b>                  | A range in which you expect your network to perform. If a threshold is exceeded or goes below the expected bounds, you examine the areas for potential problems. You can create thresholds for a specific device. |
| <b>traceroute</b>                 | A diagnostic tool that helps you understand why ping fails or why applications time out. Using it, you can view each hop (or gateway) on the route to your device and how long each took.                         |
| <b>Transport Control Protocol</b> | See <a href="#">TCP</a> .                                                                                                                                                                                         |

---

## U

|                  |                                                                                                                                                                                                                                                                                                                                   |
|------------------|-----------------------------------------------------------------------------------------------------------------------------------------------------------------------------------------------------------------------------------------------------------------------------------------------------------------------------------|
| <b>URI</b>       | Uniform Resource Identifier. Type of formatted identifier that encapsulates the name of an Internet object, and labels it with an identification of the name space, thus producing a member of the universal set of names in registered name spaces and of addresses referring to registered protocols or name spaces. [RFC 1630] |
| <b>user role</b> | A mechanism for granting access to features and functionality to a user account. The Cisco Application Networking Manager includes four predefined roles: System Administrator, Server Manager, Network Manager, and Service Provider Customer.                                                                                   |

---

## V

|                               |                                                                                                                                                                                                                                                                                                                                                                                                                                                                                                                                                                                                                                                                                                                                                                                                                                                                                                                                                                                                                                                                                                                                                                                                                                                                                                                                                                                                                                                                                |
|-------------------------------|--------------------------------------------------------------------------------------------------------------------------------------------------------------------------------------------------------------------------------------------------------------------------------------------------------------------------------------------------------------------------------------------------------------------------------------------------------------------------------------------------------------------------------------------------------------------------------------------------------------------------------------------------------------------------------------------------------------------------------------------------------------------------------------------------------------------------------------------------------------------------------------------------------------------------------------------------------------------------------------------------------------------------------------------------------------------------------------------------------------------------------------------------------------------------------------------------------------------------------------------------------------------------------------------------------------------------------------------------------------------------------------------------------------------------------------------------------------------------------|
| <b>virtual context</b>        | <p>A concept that allows users to partition an ACE into multiple virtual devices. Each virtual context contains its own set of policies, interfaces, resources, and administrators, allowing administrators to more efficiently manage system resources and services.</p> <p>There are two types of contexts; the Admin context and a user context. The Admin context is the default context that the ACE provides. The Admin context, which contains the basic settings for each virtual device or context, allows a user to configure and manage all contexts. When a user logs into the Admin context, he or she has full system administrator access to the entire ACE and all contexts and objects within it. The Admin context provides access to network-wide resources, for example, a syslog server or context configuration server. All global commands for ACE settings, contexts, resource classes, and so on, are available only in the Admin context.</p> <p>A user context, which is created by a user, has access to the resources in which the context was created. For example, a user context that was created by an administrator while in Admin context, by default, has access to all resources in an ACE device. Any user created by someone in a user-defined context, only has access to the resources within that context. In addition, roles are assigned to users, which determine the commands and resources that are available to that user.</p> |
| <b>VLAN</b>                   | Virtual LAN. Group of devices on one or more LANs that are configured (using management software) so that they can communicate as if they were attached to the same wire, when in fact they are located on a number of different LAN segments. Because VLANs are based on logical instead of physical connections, they are extremely flexible.                                                                                                                                                                                                                                                                                                                                                                                                                                                                                                                                                                                                                                                                                                                                                                                                                                                                                                                                                                                                                                                                                                                                |
| <b>VLAN Trunking Protocol</b> | See <a href="#">VTP</a> .                                                                                                                                                                                                                                                                                                                                                                                                                                                                                                                                                                                                                                                                                                                                                                                                                                                                                                                                                                                                                                                                                                                                                                                                                                                                                                                                                                                                                                                      |
| <b>virtual server</b>         | A virtual server represents groups of real servers and are associated with a real server farm.                                                                                                                                                                                                                                                                                                                                                                                                                                                                                                                                                                                                                                                                                                                                                                                                                                                                                                                                                                                                                                                                                                                                                                                                                                                                                                                                                                                 |

- VMware vCenter Server** Third-party product for creating and managing virtual data centers, which includes VMware vSphere Client and virtual machines.
- VTP** VLAN Trunking Protocol. A Layer 2 messaging protocol that maintains VLAN configuration consistency by managing the addition, deletion, and renaming of VLANs within a VTP domain. VTP minimizes misconfigurations and configuration inconsistencies that can result in a number of problems, such as duplicate VLAN names, incorrect VLAN-type specifications, and security violations.
- VTP domain** Also called a VLAN management domain, a domain composed of one or more network devices that share the same VTP domain name and that are interconnected with trunks.

---

## W

- Web server** A machine that contains Web pages that are accessible by others.



## INDEX

---

### Numerics

#### 7600 series router

adding VLANs [5-48](#)

#### configuring

access ports [5-43](#)

interfaces [5-42](#)

primary attributes [5-38](#)

routed ports [5-46](#)

switch virtual interfaces [5-45](#)

trunk ports [5-44](#)

managing [5-66](#)

synchronizing configurations [5-66](#)

#### viewing

all modules [5-79](#)

ports [5-42](#)

#### VLAN

managing [5-48](#)

modifying [5-51](#)

viewing [5-49](#)

---

### A

AAA server, authenticating ANM users [18-38](#)

About button [1-9](#)

#### acceleration

configuring [7-53](#)

configuring globally on ACE appliances [15-9](#)

FlashForward [15-2](#)

traffic policies [15-2](#)

typical configuration flow [15-2](#)

access control, configuring on VLAN interfaces [12-14](#)

access control list (ACL) [6-78](#)

access credentials, configuring [5-29](#)

access ports, configuring [5-43](#)

account password [1-6](#)

#### accounts

user, managing [18-17](#)

#### ACE

changing passwords [5-77](#)

#### class map

configuring [14-7](#)

match conditions [14-8](#)

configuration options [6-11](#)

definition [GL-1](#)

#### license

ANM license requirements [6-36](#)

details [6-42](#)

managing [6-36](#)

removing [6-39](#)

updating [6-40](#)

viewing [6-36](#)

parameter maps [10-2](#)

#### policy map

configuring [14-32](#)

rules and actions [14-34](#)

traffic policies [14-2](#)

viewing license details [6-42](#)

virtual server protocols [7-11](#)

#### ACE 1.0 module

class maps [14-7](#)

configuration building block [16-6](#)

parameter maps [10-2](#)

policy maps [14-32](#)

traffic policies [14-2](#)

virtual server protocols [7-11](#)

- ACE 2.0 module
  - class map
    - types [14-7](#)
  - configuration building block [16-6](#)
  - parameter map
    - generic [10-8](#)
    - RTSP [10-20](#)
    - SIP [10-21](#)
    - Skippy [10-23](#)
  - parameter maps [10-2](#)
  - policy maps [14-32](#)
  - sticky types [9-2](#)
  - traffic policies [14-2](#)
  - virtual server protocols [7-11](#)
- ACE appliance
  - changing passwords [5-75](#)
  - class maps [14-7](#)
  - configuration building block [16-6](#)
  - configuring [5-34](#)
  - licenses
    - configuration [6-42](#)
    - statistics [6-42](#)
  - optimization parameter map [10-12](#)
  - parameter maps [10-2](#)
  - policy maps [14-32](#)
  - synchronizing configurations [5-66](#)
  - traffic policies [14-2](#)
  - updating passwords [5-75](#)
  - virtual server protocols [7-11](#)
- ACE appliances
  - SSH, enabling [5-6](#)
- ACE license
  - and required ANM licenses [6-36](#)
  - details [6-42](#)
  - managing [6-36](#)
  - removing [6-39](#)
  - updating [6-40](#)
  - viewing [6-36](#)
- ACE module
  - configuring [5-34](#)
  - configuring access credentials [5-29](#)
  - discovery
    - enabling SSH access [5-28](#)
    - process [5-31](#)
  - monitoring discovery status [5-33](#)
  - replace [5-82](#)
  - synchronizing configurations [5-67](#)
  - viewing
    - by 7600 series router [5-79](#)
    - by chassis [5-79](#)
- ACE modules
  - ACE 2.0 SNMP polling [5-7](#)
  - adding to ANM [5-16](#)
  - HTTPS, enabling [5-6](#)
  - OK/Pass state requirement [5-16](#)
  - SSH, enabling [5-6](#)
- ACE network topology
  - overview [3-12](#)
- ACL
  - configuration overview [6-78](#)
  - configuring
    - EtherType attributes [6-87](#)
    - extended ACL attributes [6-82](#)
    - for VLANs [12-14](#)
    - object groups [6-89](#)
  - creating [6-79](#)
  - deleting [6-100](#)
  - managing [6-99](#)
  - objects
    - ICMP service parameters [6-97](#)
    - IP addresses [6-91](#)
    - protocols [6-93](#)
    - subnet objects [6-92](#)
    - TCP/UDP service parameters [6-94](#)
  - resequencing [6-87](#)
  - viewing by context [6-99](#)
- ACL object group
  - configuring [6-89](#)

- network objects
  - IP addresses [6-91](#)
  - subnet objects [6-92](#)
- service objects
  - ICMP service parameters [6-97](#)
  - protocols [6-93](#)
  - TCP/UDP service parameters [6-94](#)
- ACLs, creating [6-79](#)
- action, setting for policy maps [14-34](#)
- action list
  - application acceleration, configuring [14-85, 15-3](#)
  - configuration options [7-55](#)
  - HTTP header modify, configuring [14-85](#)
  - HTTP header modify, SSL header insertion, configuring [14-85](#)
  - HTTP header modify, SSL URL rewrite, configuring [14-85](#)
- activate, definition [GL-1](#)
- activating
  - DNS rules for GSS [7-75](#)
  - real servers [8-14, B-15](#)
  - virtual servers [7-71](#)
- adding
  - ACE modules [5-16](#)
  - CSM [5-19, 5-20](#)
  - devices to ANM [5-10](#)
  - domains [5-63](#)
  - resource classes [6-46](#)
  - SSL
    - CSR parameters [11-25](#)
    - parameter map cipher info [11-20](#)
    - parameter maps [11-18, 11-27](#)
    - user-defined groups [5-72](#)
- Admin context, first virtual context [6-2](#)
- administrative distance, definition [GL-1](#)
- admin password [18-14](#)
- advanced editing mode [1-16](#)
- AES, definition [GL-1](#)
- alarms
  - configuring for notification [17-57](#)
  - viewing [17-65](#)
- all-match policy map [14-32](#)
- ANM
  - customizing default page [2-4](#)
  - homepage [2-1, 2-3](#)
  - ANM applications [1-2](#)
  - ANM interface
    - logging in [1-5](#)
    - overview [1-8](#)
    - password, changing
      - account [1-7](#)
      - login [1-7](#)
    - table
      - conventions [1-14](#)
      - customizing [1-15](#)
  - ANM server
    - auto-sync settings [18-61](#)
    - change audit logs [18-61](#)
    - change audit logs, viewing [18-61](#)
    - configuring
      - attributes [18-57](#)
      - license file name [18-54](#)
      - polling, enabling [18-57](#)
      - statistics [18-56](#)
  - ANM template editor
    - edit application template definition [4-18](#)
    - overview [4-29](#)
  - application acceleration
    - configuring [7-53](#)
      - action lists [7-55](#)
      - globally on ACE appliances [15-9](#)
    - monitoring [17-43](#)
    - overview [15-2](#)
    - traffic policies [15-2](#)
    - typical configuration flow [15-2](#)
    - virtual server, additional configuration options [7-57](#)
  - application definition definitions
    - create [4-20](#)

- delete [4-29](#)
- export [4-26](#)
- import [4-26](#)
- test [4-28](#)
- application template definitions
  - ANM template editor [4-29](#)
  - edit [4-15](#)
  - edit with ANM template editor [4-18](#)
  - edit with external editor [4-19](#)
  - managing [4-15](#)
  - overview [4-1](#)
  - system template [4-1](#)
  - user-defined template [4-2](#)
- application template instance
  - overview [4-2](#)
- application template instances
  - create [4-4](#)
  - delete
    - deleting
      - application template instance [4-13](#)
  - deploy [4-7](#)
  - duplicate [4-10](#)
  - edit [4-9](#)
  - list of instances [4-3](#)
  - managing [4-3](#)
  - view details [4-12](#)
- applying configuration building blocks [16-9](#)
- Appscope, configuration options [7-60](#)
- ARP
  - definition [GL-1](#)
- attributes
  - BVI interfaces [12-20](#)
  - DNS probes [8-57](#)
  - Echo-TCP probes [8-58](#)
  - Echo-UDP probes [8-58](#)
  - Finger probes [8-58](#)
  - for sticky group types [9-11](#)
  - FTP probes [8-59](#)
  - health monitoring [8-53](#)
  - high availability [13-15](#)
  - HTTP content sticky group [9-11](#)
  - HTTP cookie sticky group [9-12](#)
  - HTTP header sticky group [9-13](#)
  - HTTP probes [8-60](#)
  - HTTPS probes [8-61](#)
  - IMAP probes [8-63](#)
  - IP netmask sticky group [9-13](#)
  - Layer 4 payload sticky group [9-14](#)
  - new device [5-12](#)
  - parameter map
    - connection [10-3](#)
    - DNS [10-25](#)
    - generic [10-8](#)
    - HTTP [10-10](#)
    - optimization [10-12](#)
    - RTSP [10-20](#)
    - SIP [10-21](#)
    - Skinny [10-24](#)
  - POP probes [8-64](#)
  - predictor method [7-42, 8-40](#)
  - RADIUS
    - sticky groups [9-14](#)
  - RADIUS probes [8-65](#)
  - real servers [8-6, 8-37](#)
  - resource class [6-45](#)
  - resource classes [6-45](#)
  - RTSP
    - header sticky groups [9-15](#)
    - probes [8-65](#)
  - scripted probes [8-66](#)
  - server farms [7-34, 8-31](#)
  - SIP-TCP probes [8-67](#)
  - SIP-UDP probes [8-68](#)
  - SMTP probes [8-69](#)
  - SNMP [6-27](#)
  - SNMP probes [8-69](#)
  - SSL
    - certificate export [11-16](#)

- certificate import [11-8, 11-9](#)
- CSR parameters [11-25](#)
- for virtual servers [7-17](#)
- key export [11-17](#)
- key pair import [11-12](#)
- parameter map cipher info [11-20](#)
- parameter maps [11-18, 11-27](#)
- sticky group [9-8](#)
- TCP probes [8-70](#)
- Telnet probes [8-70](#)
- UDP probes [8-71](#)
- V6 prefix sticky group [9-13](#)
- virtual context [6-3, 6-13, 6-14](#)
- virtual servers [7-8](#)
- VLAN interfaces [12-6](#)
- VM probes [8-72](#)
- auditing
  - building block configuration [6-101](#)
  - resource classes [6-49](#)
- audit log
  - configuring
    - purge settings [18-58](#)
- audit logs
  - ANM server change audit [18-61](#)
- audit sync settings
  - configuring [18-61](#)
- authenticating ANM users with AAA server [18-38](#)
- authorization group certificate, configuring for SSL [11-32](#)
- autostate, enabling supervisor VLAN notification [12-5](#)
- autosync
  - setting up syslog settings for [6-105](#)

---

## B

- backup
  - defaults [6-61](#)
- bandwidth optimization, configuring [7-53](#)
- building block
  - applying [16-9](#)

- configuration
  - audit [6-101](#)
  - changes and version numbers [16-4](#)
  - options [16-2](#)
  - primary attributes [16-8](#)
- configuring [16-7](#)
- creating [16-5](#)
- enable feature [16-5](#)
- extracting from virtual contexts [16-6](#)
- overview [16-1](#)
- primary attributes [16-8](#)
- tagging [16-4, 16-9](#)
- types [16-6](#)
- using [16-1](#)
- versions [16-4](#)
- viewing use [16-11](#)

- buttons
  - descriptions [1-11](#)
  - Graph The Component With Issue [17-66](#)
- BVI, definition [GL-2](#)
- BVI interfaces
  - attributes [12-20](#)
  - configuring [12-19](#)
  - viewing by context [12-25](#)

---

## C

- caching, dynamic [15-2](#)
- certificate
  - exporting for SSL [11-15](#)
  - importing for SSL [11-7](#)
  - SSL [11-5](#)
- certificate chain, definition [GL-2](#)
- certificate signing request, definition [GL-2](#)
- chain group certificate, configuring for SSL [11-23](#)
- chain group parameters, configuring for SSL [11-23](#)
- changing
  - account password [1-7](#)
  - admin password [18-14](#)

- domain information [5-63](#)
- login password [1-7](#)
- role rules [5-61](#)
- user passwords [18-14](#)
- chassis
  - adding VLANs [5-48](#)
  - changing passwords [5-75](#)
  - configuring [5-34](#)
    - access credentials [5-29](#)
    - access ports [5-43](#)
    - interfaces [5-42](#)
    - primary attributes [5-38](#)
    - routed ports [5-46](#)
    - switch virtual interfaces [5-45](#)
    - trunk ports [5-44](#)
  - discovery process [5-31](#)
  - managing [5-66](#)
  - monitoring
    - discovery status [5-33](#)
  - running discovery [5-31](#)
  - SSH, enabling [5-5](#)
  - synchronizing configurations [5-66](#)
  - Telnet default [5-5](#)
  - viewing
    - all modules [5-79](#)
    - ports [5-42](#)
  - VLAN
    - managing [5-48](#)
    - modifying [5-51](#)
    - viewing [5-49](#)
- checking status of the Cisco ANM server [18-52](#)
- checkpoint, configuration
  - creating [6-55](#)
  - deleting [6-56](#)
  - displaying [6-57](#)
  - rolling back to [6-56](#)
- Cisco IOS software, definition [GL-2](#)
- cisco-sample-cert [11-6](#)
- cisco-sample-key [11-6](#)
- class map
  - ACE device support [14-7, 14-8](#)
  - configuring [14-6](#)
  - definition [GL-2](#)
  - deleting [14-6, 14-8](#)
  - match conditions
    - generic server load balancing [14-23](#)
    - Layer 3/4 management traffic [14-12](#)
    - Layer 3/4 network traffic [14-9](#)
    - Layer 7 FTP command inspection [14-22](#)
    - Layer 7 HTTP deep packet inspection [14-17](#)
    - Layer 7 server load balancing [14-14](#)
    - Layer 7 SIP deep packet inspection [14-30](#)
    - RADIUS server load balancing [14-25](#)
    - RTSP server load balancing [14-26](#)
    - SIP server load balancing [14-27](#)
  - overview [14-2, 14-3](#)
  - setting match conditions [14-8](#)
  - use with real servers [8-3](#)
- command inspection, FTP commands [14-22](#)
- configuration
  - back up and restore overview [6-59](#)
  - create a backup [6-62](#)
  - restore [6-66](#)
- configuration attributes
  - Appscope [7-60](#)
  - delta optimization [7-57](#)
  - device VLAN [5-48](#)
  - extended ACL [6-83](#)
  - health monitoring [8-53](#)
  - high availability [13-15](#)
  - HTTP return code maps [8-46](#)
  - parameter map
    - connection [10-3](#)
    - DNS [10-25](#)
    - generic [10-8](#)
    - HTTP [10-10](#)
    - optimization [10-12](#)
    - RTSP [10-20](#)



- SIP [10-21](#)
- Skinnyp [10-24](#)
- predictor method [7-42, 8-40](#)
- probe
  - DNS [8-57](#)
  - Echo-TCP [8-58](#)
  - Echo-UDP [8-58](#)
  - Finger [8-58](#)
  - FTP [8-59](#)
  - HTTP [8-60](#)
  - HTTPS [8-61](#)
  - IMAP [8-63](#)
  - POP [8-64](#)
  - RADIUS [8-65](#)
  - RTSP [8-65](#)
  - scripted [8-66](#)
  - SIP-TCP [8-67](#)
  - SIP-UDP [8-68](#)
  - SMTP [8-69](#)
  - SNMP [8-69](#)
  - TCP [8-70](#)
  - Telnet [8-70](#)
  - UDP [8-71](#)
  - VM [8-72](#)
- real server [8-6, 8-37](#)
- resource class [6-45](#)
- server farm [7-34, 8-31](#)
- SNMP users [6-30](#)
- SSL [7-17](#)
- sticky group [9-8](#)
- sticky type [7-47](#)
- syslog [6-20](#)
- trunk ports [5-44](#)
- virtual context [6-3](#)
- virtual server [7-8](#)
- configuration building block
  - applying [16-9](#)
  - configuring [16-7](#)
  - creating [16-5](#)
  - options [16-2](#)
  - overview [16-1](#)
  - tagging [16-4, 16-9](#)
  - using [16-1](#)
  - versions [16-4](#)
- configuration checkpoint and rollback service
  - creating configuration checkpoint [6-55](#)
  - deleting configuration checkpoint [6-56](#)
  - displaying checkpoint information [6-57](#)
  - overview [6-54](#)
  - rolling back configuration [6-56](#)
- configuration options
  - building blocks [16-2](#)
  - by ACE device type [6-11](#)
  - virtual contexts [6-9](#)
- configuration primary attributes
  - virtual context [6-14](#)
- configurations
  - synchronizing
    - for ACE modules [5-67](#)
    - for devices [5-66](#)
    - for high availability [13-30](#)
    - for virtual contexts [6-105](#)
- configuration synchronization [13-11](#)
- configuration template. See building block.
- configuration values, changing [20-1](#)
- configuring
  - 7600 series router [5-34, 5-38](#)
    - access ports [5-43](#)
    - interfaces [5-42](#)
    - switch virtual interfaces [5-45](#)
    - trunk ports [5-44](#)
  - acceleration [7-53](#)
  - access credentials [5-29](#)
  - access ports [5-43](#)
  - ACE appliance passwords [5-75](#)
  - ACE passwords [5-77](#)
  - ACE SNMP for polling [5-7](#)
  - ACE syslog messages [5-27, 18-62](#)

- ACLs [6-79, 12-14](#)
  - EtherType [6-87](#)
  - extended [6-82](#)
  - object groups [6-89](#)
  - resequencing [6-87](#)
- action lists [7-55](#)
- action lists for application acceleration [15-3](#)
- action lists for HTTP header modify [14-85](#)
- application acceleration action lists [7-55](#)
- bandwidth optimization [7-53](#)
- building block primary attributes [16-8](#)
- building blocks [16-7](#)
- BVI interfaces [12-19](#)
- chassis [5-34, 5-38](#)
  - access ports [5-43](#)
  - interfaces [5-42](#)
  - trunk ports [5-44](#)
- chassis passwords [5-75](#)
- class map match conditions
  - generic server load balancing [14-23](#)
  - Layer 3/4 management traffic [14-12](#)
  - Layer 3/4 network traffic [14-9](#)
  - Layer 7 FTP command inspection [14-22](#)
  - Layer 7 HTTP deep packet inspection [14-17](#)
  - Layer 7 server load balancing [14-14](#)
  - Layer 7 SIP deep packet inspection [14-30](#)
  - RADIUS server load balancing [14-25](#)
  - RTSP server load balancing [14-26](#)
  - SIP server load balancing [14-27](#)
- class maps [14-6](#)
- CSM [5-34](#)
- CSS [5-34, 5-35](#)
- CSS passwords [5-75](#)
- devices [5-34](#)
- DNS probe expect address [8-73](#)
- gigabit Ethernet interfaces [12-32](#)
- global
  - application acceleration on ACE appliances [15-9](#)
  - optimization on ACE appliances [15-9](#)
- GSS [5-36](#)
- GSS passwords [5-75](#)
- health monitoring general attributes [8-53](#)
- high availability
  - groups [13-17, 13-19](#)
  - host tracking [13-25](#)
  - interface tracking [13-24](#)
  - peer host probes [13-28](#)
  - peers [13-15](#)
  - synchronization [13-11](#)
  - tracking and failure detection [13-23](#)
- host probes for high availability [13-26](#)
- HTTP probe headers [8-74](#)
- HTTP retcode maps [8-46](#)
- HTTPS probe headers [8-74](#)
- latency optimization [7-53](#)
- Layer 2 VLANs [5-50](#)
- Layer 3 VLANs [5-51](#)
- Layer 7 default load balancing [7-50](#)
- load balancing
  - real servers [8-5](#)
  - server farms [8-30](#)
  - sticky groups [9-7](#)
  - virtual servers [7-30](#)
- NAT [7-63, 12-26](#)
- object groups
  - ICMP service parameters [6-97](#)
  - IP addresses [6-91](#)
  - protocols [6-93](#)
  - subnet objects [6-92](#)
  - TCP/UDP service parameters [6-94](#)
- OID for SNMP probes [8-76](#)
- optimization [7-53](#)
  - action lists [7-55](#)
  - traffic policies [15-6](#)
- organization passwords [18-10](#)
- parameter maps
  - connection [10-3](#)
  - DNS [10-25](#)

- generic [10-8](#)
- HTTP [10-9](#)
- optimization [10-12, 15-6](#)
- RTSP [10-20](#)
- SIP [10-21](#)
- Skinny [10-23](#)
- PAT [12-27](#)
- policy map rules and actions [14-34](#)
  - generic server load balancing [14-35](#)
  - Layer 3/4 management traffic [14-39](#)
  - Layer 3/4 network traffic [14-41](#)
  - Layer 7 FTP command inspection [14-48](#)
  - Layer 7 HTTP deep packet inspection [14-51](#)
  - Layer 7 HTTP optimization [14-57](#)
  - Layer 7 server load balancing [14-61](#)
  - Layer 7 SIP deep packet inspection [14-68](#)
  - Layer 7 Skinny deep packet inspection [14-71](#)
  - RADIUS server load balancing [14-73](#)
  - RDP server load balancing [14-75](#)
  - RTSP server load balancing [14-76](#)
  - SIP server load balancing [14-79](#)
- policy maps [14-32](#)
- port channel interfaces [12-35](#)
- probe attributes [8-56](#)
- probe expect status [8-74](#)
- protocol inspection [7-18](#)
- real servers [8-17, B-18](#)
- resource classes
  - global [6-46](#)
  - local [6-52](#)
- routed ports [5-46](#)
- server farm predictor method [8-39](#)
- shared objects [7-10](#)
- SNMP [6-27](#)
  - communities [6-28](#)
  - credentials [5-30](#)
  - notification [6-33](#)
  - on virtual contexts [6-27](#)
  - trap destination hosts [6-32](#)
  - version 3 users [6-29](#)
- SSL
  - chain group parameters [11-23](#)
  - CSR parameters [11-24](#)
  - for virtual servers [7-17](#)
  - OCSP service [11-29](#)
  - parameter map [11-18](#)
  - parameter map cipher [11-20](#)
  - proxy service [11-27](#)
- static routes [5-39, 12-28](#)
- sticky groups [7-47, 9-7](#)
- sticky statics [9-15](#)
- switch virtual interfaces [5-45](#)
- syslog
  - logging [6-19](#)
  - log hosts [6-23](#)
  - log messages [6-24](#)
  - log rate limits [6-26](#)
- Telnet
  - credentials [5-29](#)
- Telnet on chassis [5-5](#)
- traffic policies [14-1](#)
- trunk ports [5-44](#)
- virtual context [6-1, 6-8, 6-106](#)
  - class maps [14-6](#)
  - global policies [6-35](#)
  - policy maps [14-32](#)
  - primary attributes [6-14](#)
  - resource classes [6-52](#)
  - system attributes [6-13](#)
- virtual server
  - configuration overview [7-2](#)
  - default load balancing [7-50](#)
  - Layer 7 load balancing [7-30](#)
  - NAT [7-63](#)
  - optimization [15-9](#)
  - properties [7-11](#)
  - protocol inspection [7-18](#)
  - shared objects [7-9](#)

- SSL termination service [7-17](#)
- VLAN
  - interface access control [12-14](#)
  - interface policy maps [12-14](#)
  - interfaces [12-6](#)
  - Layer 2 [5-50](#)
  - Layer 3 [5-51](#)
  - VLAN groups [5-52](#)
  - VSS passwords [5-75](#)
- connection parameter map
  - attributes [10-3](#)
  - configuring [10-3](#)
  - TCP options [10-7](#)
  - using [8-77](#)
- connectivity, testing between devices [17-71](#)
- context
  - back up and restore overview [6-59](#)
  - configuration options [6-9](#)
  - configuring [6-8](#)
    - application acceleration [15-1](#)
    - BVI interfaces [12-19](#)
    - global policies [6-35](#)
    - load balancing [7-1](#)
    - optimization [15-1](#)
    - primary attributes [6-14](#)
    - resource classes [6-52](#)
    - static routes [12-28](#)
    - traffic policies [14-1](#)
    - virtual servers [7-1](#)
    - VLAN interfaces [12-6](#)
  - create a configuration backup [6-62](#)
  - creating [6-2](#)
  - definition [GL-7](#)
  - deleting [6-107](#)
  - editing [6-106](#)
  - extracting configurations for building blocks [16-6](#)
  - modifying [6-106](#)
  - polling
    - restarting [6-108](#)
    - viewing status [6-104](#)
  - restore a configuration [6-66](#)
  - synchronizing configurations [6-105](#)
  - sync status [6-103](#)
  - upgrading [6-107](#)
  - using for configuration building blocks [16-6](#)
- controlling access to Cisco ANM [18-3](#)
- conventions in ANM
  - table [1-14](#)
- cookie
  - client [9-3](#)
  - sticky client identification [9-3](#)
- copying
  - ACE licenses [6-37](#)
- creating
  - ACLs [6-79](#)
  - application template definition [4-20](#)
  - application template instance [4-4](#)
  - building blocks [16-5](#)
  - domains [18-34](#)
  - user accounts [18-19](#)
  - user roles [18-29](#)
  - virtual contexts [6-2](#)
- creating ACLs [6-79](#)
- credentials
  - modifying [5-30](#)
  - SNMP [5-30](#)
  - Telnet [5-29](#)
- CSM
  - adding to ANM [5-19, 5-20](#)
  - configuring [5-34](#)
  - primary attributes [5-34](#)
  - viewing by chassis [5-79](#)
- CSR
  - configuring parameters [11-24](#)
  - definition [GL-2](#)
  - generating for SSL [11-26](#)
- CSS
  - changing passwords [5-75](#)

- configuring [5-34](#)
- primary attributes [5-35](#)
- synchronizing configurations [5-66](#)

customizing

- tables [1-15](#)

---

## D

Data Center Interconnect (DCI)

- overview [1-3](#)

data dictionary [17-53](#)

deep packet inspection

HTTP

- class map match conditions [14-17](#)
- policy map rules and actions [14-51](#)

SIP

- class map match conditions [14-30](#)
- policy map rules and actions [14-68](#)

- Skippy policy map rules and actions [14-71](#)

default distance values [5-40](#)

deleting

- ACLs [6-100](#)

- application template definition [4-29](#)

- class map in use [14-6](#)

- device RBAC user accounts [5-56](#)

- domains [5-65, 18-37](#)

- high availability groups [13-23](#)

- host probes for high availability [13-27](#)

- organizations [18-16](#)

- peer host probes [13-29](#)

- resource classes [6-51, 6-53](#)

- role rules [5-61](#)

- roles or domains [5-54](#)

- SSL objects [11-2](#)

- user accounts [18-23](#)

- user-defined groups [5-75](#)

- user roles [5-60, 18-32](#)

- virtual contexts [6-107](#)

delta optimization

- configuration options [7-57](#)

- description [15-2](#)

deploying

- application template instance [4-7](#)

- configuration building blocks [16-9](#)

- staged virtual servers [7-87](#)

DES, definition [GL-2](#)

device

- adding to ANM [5-10](#)

- back up and restore overview [6-59](#)

- configuring [5-34](#)

- create a configuration backup [6-62](#)

- management overview [5-2](#)

- managing [5-1](#)

- monitoring [17-24](#)

polling

- restarting [5-78](#)

- status [5-79](#)

- restore a configuration [6-66](#)

viewing

- All Devices table [5-78](#)

device audit trail logs

- monitoring [18-59](#)

device groups, monitoring [17-23](#)

device tree

- overview [1-10](#)

discovery

enabling

- SSH on ACE modules [5-28](#)

- monitoring progress [5-31, 5-33](#)

- process [5-31](#)

- running [5-31](#)

displaying

- current user sessions [18-24](#)

- list of users [18-18](#)

- network domains [18-33](#)

- organizations [18-16](#)

- user roles [18-28](#)

- users who have a selected role [18-29](#)

distinguished name, definition [GL-3](#)

## DNS

configuring protocol inspection [7-19](#)

parameter map

attributes [10-25](#)

configuring [10-25](#)

probe

attributes [8-57](#)

expect address [8-73](#)

DNS rules, and GSS [7-75](#)

domains

deleting [5-54](#)

duplicate

application template instance [4-10](#)

duplicating

domains [18-35](#)

organizations [18-15](#)

user accounts [18-20](#)

user-defined groups [5-74](#)

user roles [18-31](#)

dynamic caching [15-2](#)

Dynamic Workload Scaling

brief summary and illustration [1-3](#)

configure

Nexus 7000 [8-27](#)

overview [8-26](#)

VM controller [8-29](#)

server farm [7-36, 8-33](#)

role rules [5-61](#)

enabling

ACE syslog messages [5-27](#)

setup syslog for Autosync [5-27](#)

SNMP polling from ANM [5-7](#)

write mem on Config > Operations [18-63](#)

Ethernet interfaces, configuring [12-32](#)

EtherType ACL, configuring [6-87](#)

event

definition [GL-3](#)

monitoring [17-55](#)

event type, definition [GL-3](#)

exception, definition [GL-3](#)

expert options, for virtual contexts [6-101](#)

export

application template definition [4-26](#)

export historical statistics [17-52](#)

exporting

SSL

certificates [11-15](#)

key [11-17](#)

key pair [11-16](#)

extended ACL

configuration options [6-83](#)

resequencing entries [6-87](#)

## E

Echo-TCP probe attributes [8-58](#)

Echo-UDP probe attributes [8-58](#)

e-commerce

applications, sticky requirements [9-1](#)

using stickiness [9-4](#)

edit

application template definition [4-15](#)

application template instance [4-9](#)

## F

failover [13-9](#)

fault, definition [GL-3](#)

fault tolerance

groups [13-8](#)

task overview [13-14](#)

Feedback button [1-9](#)

filtering tables [1-14](#)

Finger probe attributes [8-58](#)

first-match policy map [14-32](#)

FlashForward object acceleration [15-2](#)

FTP, configuring protocol inspection [7-19](#)

- FTP command inspection
    - available commands [14-22](#)
    - class map match conditions [14-22](#)
    - policy map rules and actions [14-48](#)
  - FTP probe attributes [8-59](#)
  - FTP strict, and RFP standards [14-48](#)
  - FT VLAN [13-10](#)
- 
- ## G
- generic parameter map
    - attributes [10-8](#)
    - configuring [10-8](#)
  - generic server load balancing
    - class map match conditions [14-23](#)
    - policy map rules and actions [14-35](#)
  - global acceleration and optimization, ACE appliances [15-9](#)
  - global policies, configuring for virtual contexts [6-35](#)
  - global resource class [6-44](#)
    - applying to contexts [6-47](#)
    - auditing [6-49](#)
    - configuring [6-46](#)
    - deleting [6-51](#)
    - deploying [6-48](#)
    - modifying [6-50](#)
    - using [6-46](#)
  - graphs, historical trend and real time [17-48](#)
  - Graph The Component With Issue button [17-66](#)
  - groups
    - GSS DNS rules, managing [7-76](#)
    - GSS VIP answers, managing [7-76](#)
    - real servers, managing [8-10](#)
    - virtual servers, managing [7-67](#)
    - VLAN, assigning [12-4](#)
    - VLAN, creating [12-3](#)
  - GSS
    - Answer Table [7-73, 7-75](#)
    - changing passwords [5-75](#)
    - DNS rules, activating suspending [7-75](#)
    - DNS rules groups, managing [7-76](#)
    - primary attributes [5-36](#)
    - VIP answer groups, managing [7-76](#)
    - VIP Answer table, managing [7-73](#)
  - guided setup
    - ACE hardware setup [3-5](#)
    - ACE network topology overview [3-12](#)
    - application setup [3-14](#)
    - importing devices [3-4](#)
    - operating considerations [3-4](#)
    - overview [3-1](#)
    - tasks and related topics [3-2](#)
    - virtual context setup [3-10](#)
  - guidelines for managing
    - domains [18-33](#)
    - user accounts [18-17](#)
    - user roles [18-25](#)
- 
- ## H
- hash load-balancing methods
    - address [8-2](#)
    - cookie [8-2](#)
    - header [8-2](#)
    - url [8-3](#)
  - header
    - deletion [14-86](#)
    - insertion [14-85, 14-86](#)
    - rewrite [14-85, 14-86](#)
  - health monitoring
    - configuring [8-49](#)
    - for real servers [8-51](#)
    - general attributes [8-53](#)
    - inband [7-37, 8-34](#)
    - overview [8-49](#)
    - probe types [8-51](#)
    - TCL scripts [8-50](#)
  - heartbeat packets [13-9](#)

- Help button [1-9](#)
- high availability
  - ANM requirements [5-8](#)
  - clearing
    - links between ACE appliances [13-17](#)
    - pairs [13-17](#)
  - configuration attributes [13-15](#)
  - configuring
    - groups [13-17](#)
    - host probes [13-26](#)
    - host tracking process [13-25](#)
    - interface tracking process [13-24](#)
    - overview [13-6](#)
    - peer host probes [13-28](#)
    - peers [13-15](#)
  - deleting
    - groups [13-23](#)
    - host probes [13-27](#)
    - peer host probes [13-29](#)
  - failover detection [13-23](#)
  - importance of synchronizing configurations [13-30](#)
  - modifying groups [13-19](#)
  - protocol [13-8](#)
  - reconciling an SSL certificate/key pair [13-32](#)
  - switching over a group [13-22](#)
  - task overview [13-14](#)
  - tracking status [13-23](#)
- historical statistics, export [17-52](#)
- historical trend graph [17-48](#)
- homepage
  - customizing default page [2-4](#)
  - link descriptions [2-1](#)
  - overview [2-1](#)
  - pages in ANM [2-3](#)
- HSRP, definition [GL-3](#)
- HTTP
  - configuring protocol inspection [7-20](#)
  - content
    - sticky group attributes [9-11](#)
    - sticky type [9-3](#)
  - cookie
    - sticky group attributes [9-12](#)
    - sticky type [9-3](#)
  - deep packet inspection
    - class map match conditions [14-17](#)
    - policy map rules and actions [14-51](#)
  - header
    - sticky client identification [9-4](#)
    - sticky group attributes [9-13](#)
    - sticky type [9-4](#)
  - load balancing conditions and options [7-32](#)
  - optimization policy map rules and actions [14-57](#)
  - parameter map
    - attributes [10-10](#)
    - configuring [10-9](#)
  - parameter maps [8-77](#)
  - probe
    - attributes [8-60](#)
    - configuring headers [8-74](#)
    - retcode maps [8-46](#)
    - return code map configuration options [8-46](#)
  - protocol inspection conditions and options [7-23](#)
- HTTP header
  - deletion [14-86](#)
  - insertion [14-85, 14-86](#)
  - rewrite [14-85, 14-86](#)
- HTTP header insertion [14-85](#)
- HTTPS
  - ACE modules, enabling [5-6](#)
  - configuring protocol inspection [7-20](#)
  - load balancing conditions and options [7-32](#)
  - probe
    - attributes [8-61](#)
    - configuring headers [8-74](#)
  - protocol inspection conditions and options [7-23](#)



- 
- I**
- ICMP service parameters, for object groups [6-97](#)
  - IMAP probe attributes [8-63](#)
  - import
    - application definition definition [4-26](#)
  - Import Failed, configuration status [6-103](#), [6-105](#)
  - importing
    - ACE licenses [6-37](#)
    - ACE modules [5-16](#)
    - CSM [5-19](#), [5-20](#)
    - device failures [20-7](#)
    - overview [5-10](#)
    - SSL
      - certificates [11-7](#)
      - keys [11-11](#)
  - inband health monitoring [7-37](#), [8-34](#)
    - connection failure count [7-37](#), [8-34](#)
    - reset timeout [7-37](#), [8-34](#)
    - resume service [7-38](#), [8-35](#)
  - installing ACE appliance licenses [6-37](#)
  - interface
    - ANM [1-8](#)
    - buttons [1-11](#)
    - configuring
      - on 7600 series routers [5-42](#)
      - on chassis [5-42](#)
    - definition [GL-4](#)
    - gigabit Ethernet, configuring [12-32](#)
    - table conventions [1-14](#)
  - IP addresses, for object groups [6-91](#)
  - IP discovery
    - failure [20-7](#)
  - IP netmask
    - for sticky client identification [9-4](#)
    - sticky group attributes [9-13](#)
    - sticky type [9-4](#)
  - IPv6 considerations [1-3](#)
  - IPv6 prefix
    - sticky type [9-4](#)
- 
- K**
- key
    - exporting for SSL [11-17](#)
    - importing for SSL [11-11](#)
    - SSL [11-10](#)
  - key pair, generating [11-14](#)
- 
- L**
- latency optimization, configuring [7-53](#)
  - Layer 2 VLANs, configuring [5-50](#)
  - Layer 3/4
    - management traffic
      - class map match conditions [14-12](#)
      - policy map rules and actions [14-39](#)
    - network traffic
      - class map match conditions [14-9](#)
      - policy map rules and actions [14-41](#)
  - Layer 3 VLANs, configuring [5-51](#)
  - Layer 4 payload
    - sticky group attributes [9-14](#)
    - sticky type [9-4](#)
  - Layer 7
    - configuring load balancing [7-30](#)
    - default load balancing on virtual servers [7-50](#)
    - FTP command inspection
      - class map match conditions [14-22](#)
      - policy map rules and actions [14-48](#)
    - HTTP deep packet inspection
      - class map match conditions [14-17](#)
      - policy map rules and actions [14-51](#)
    - HTTP optimization policy map rules and actions [14-57](#)
    - load balancing
      - HTTP/HTTPS conditions and options [7-32](#)
      - setting match conditions [7-31](#)

- server load balancing
  - class map match conditions [14-14](#)
  - policy map rules and actions [14-61](#)
- SIP deep packet inspection
  - class map match conditions [14-30](#)
  - policy map rules and actions [14-68](#)
- Skinny deep packet inspection policy map rules and actions [14-71](#)
- least bandwidth, load-balancing method [8-3](#)
- leastconns, load-balancing method [8-3](#)
- least loaded, load-balancing method [8-3](#)
- license
  - errors, removing [18-55](#)
  - managing for ACE devices [6-36](#)
  - relationship between ANM and ACE licenses [6-36](#)
  - removing ACE licenses [6-39](#)
  - updating ACE licenses [6-40](#)
  - viewing ACE license details [6-42](#)
- licenses
  - ANM, removing [18-55](#)
  - installing [6-37](#)
- lifeline
  - guidelines for use [20-8](#)
  - overview [20-7](#)
- lifeline management [18-72](#)
- load balancing
  - configuration overview [7-1](#)
  - configuring
    - real servers [8-1, 8-5](#)
    - server farms [8-1, 8-30](#)
    - sticky groups [9-7](#)
    - virtual servers [7-30](#)
  - definition [GL-4](#)
  - hash address [8-2](#)
  - hash cookie [8-2](#)
  - hash header [8-2](#)
  - hash url [8-3](#)
  - least bandwidth [8-3](#)
  - leastconns [8-3](#)

- least loaded [8-3](#)
- monitoring on probes [17-40](#)
- monitoring on real servers [17-37](#)
- monitoring on statistics [17-41](#)
- monitoring on virtual servers [17-33](#)
- overview [7-1, 8-1](#)
- predictors [8-2](#)
- response [8-3](#)
- roundrobin [8-3](#)
- local resource class [6-44](#)
  - auditing [6-49](#)
  - configuring [6-52](#)
  - deleting [6-53](#)
  - using [6-51](#)
- logging, syslog levels [6-19](#)
- logging in
  - to ANM [1-5](#)
- Logout button [1-9](#)

---

## M

- managing
  - 7600 series routers [5-66](#)
  - ACLs [6-99](#)
  - ANM [18-51](#)
  - chassis [5-66](#)
  - devices [5-1](#)
  - domains [18-32](#)
  - organizations [18-9](#)
  - real servers [8-9](#)
  - resource classes [6-43](#)
  - user accounts [18-17](#)
  - user roles [18-25](#)
  - virtual contexts [6-103](#)
  - virtual servers [7-66](#)
  - VLANs [5-48](#)
- map real server to vCenter Server [5-68](#)
- match condition
  - class map

- generic server load balancing [14-23](#)
  - Layer 3/4 management traffic [14-12](#)
  - Layer 3/4 network traffic [14-9](#)
  - Layer 7 FTP command inspection [14-22](#)
  - Layer 7 HTTP deep packet inspection [14-17](#)
  - Layer 7 server load balancing [14-14](#)
  - Layer 7 SIP deep packet inspection [14-30](#)
  - RADIUS server load balancing [14-25](#)
  - RTSP server load balancing [14-26](#)
  - SIP server load balancing [14-27](#)
  - setting for
    - class maps [14-8](#)
    - Layer 7 load balancing [7-31](#)
    - optimization [7-54](#)
    - SIP protocol inspection [7-27](#)
  - MD5, definition [GL-4](#)
  - menus, understanding [1-9](#)
  - merged ACL [6-78](#)
  - MIB, definition [GL-4](#)
  - MIME types, supported [10-26](#)
  - mobile device
    - registered devices [18-70](#)
  - modifying
    - deployed virtual servers [7-88](#)
    - domains [5-65, 18-36](#)
    - global resource class [6-50](#)
    - high availability groups [13-19](#)
    - organizations [18-14](#)
    - real servers [8-17, B-18](#)
    - staged virtual servers [7-88](#)
    - user accounts [5-55, 18-21](#)
    - user-defined groups [5-73](#)
    - user roles [5-60, 18-31](#)
    - virtual contexts [6-106](#)
  - module
    - configuring access credentials [5-29](#)
    - discovery process [5-31](#)
    - monitoring discovery progress [5-31](#)
    - running discovery [5-31](#)
  - viewing
    - by chassis [5-79](#)
    - by router [5-79](#)
  - monitoring
    - alarms [17-65](#)
    - device audit trail logs [18-59](#)
    - devices [17-3](#)
    - events [17-55](#)
    - load balancing [17-33, 17-37, 17-40](#)
    - load balancing statistics [17-41](#)
    - traffic [17-30](#)
  - MSFC, adding switched virtual interface to [12-5](#)
  - multi-match policy map [14-32](#)
- 
- ## N
- Name Address Translation
    - configuring [12-26](#)
    - definition [GL-4](#)
  - NAT
    - configuring [12-26](#)
    - configuring for virtual servers [7-63](#)
    - definition [GL-4](#)
  - Navigation pane [1-9](#)
  - network object group
    - configuring [6-89](#)
    - IP addresses [6-91](#)
    - subnet objects [6-92](#)
  - network topology maps [17-68](#)
- 
- ## O
- object, configuring for virtual servers [7-9](#)
  - object group
    - configuring
      - for ACLs [6-89](#)
      - GSS VIP answers and DNS rules [7-76](#)
      - real servers [8-10](#)

- virtual servers [7-67](#)
  - ICMP service parameters [6-97](#)
  - IP addresses [6-91](#)
  - protocols [6-93](#)
  - subnet objects [6-92](#)
  - TCP/UDP service parameters [6-94](#)
  - OCSP service, configuring for SSL [11-29](#)
  - optimization
    - additional configuration options [7-57](#)
    - configuration overview [15-6](#)
    - configuring [7-53](#)
      - action lists [7-55](#)
      - globally on ACE appliances [15-9](#)
      - match conditions [7-54](#)
      - parameter maps [15-6](#)
      - traffic policies [15-6](#)
    - delta optimization [15-2](#)
    - enabling on virtual servers [15-9](#)
    - match criteria [7-54](#)
    - overview [15-2](#)
    - parameter maps [8-77](#)
    - traffic policies [15-2](#)
    - typical configuration flow [15-2](#)
    - virtual server, additional configuration options [7-57](#)
  - optimization parameter map
    - attributes [10-12](#)
    - configuring [10-12](#)
  - organizations
    - definition [GL-4](#)
  - Out of Sync, configuration status [6-103, 6-105](#)
  - Overlay Transport Virtualization (OTV) [1-3](#)
  - overview
    - ACL configuration [6-78](#)
    - adding supported devices [5-10](#)
    - admin icon [18-2](#)
    - application acceleration [15-2](#)
    - building blocks [16-1](#)
    - class maps [14-2, 14-3](#)
    - configuration building blocks [16-1](#)
    - global and local resource classes [6-44](#)
    - health monitoring [8-49](#)
    - importing devices [5-10](#)
    - load balancing [7-1, 8-1](#)
    - load-balancing predictors [8-2](#)
    - managing devices [5-2](#)
    - optimization [15-2](#)
    - optimization traffic policies [15-6](#)
    - parameter maps [10-1](#)
    - policy maps [14-2, 14-4](#)
    - protocol inspection [14-6](#)
    - real server [8-3](#)
    - resource classes [6-43](#)
    - server farm [8-3, 8-5](#)
    - server health monitoring [8-49](#)
    - server load balancing [8-1](#)
    - SSL [11-1](#)
    - stickiness [9-1](#)
    - sticky group [9-6](#)
    - sticky table [9-6](#)
    - traffic policies [14-1](#)
    - user-defined groups [5-72](#)
    - using SSL keys and certificates [11-3](#)
    - virtual server [7-2](#)
- 
- ## P
- parameter expander functions [7-61, 10-18](#)
  - parameter map
    - ACE device support [10-2](#)
    - attributes
      - connection [10-3](#)
      - DNS [10-25](#)
      - generic [10-8](#)
      - HTTP [10-10](#)
      - optimization [10-12](#)
      - RTSP [10-20](#)
      - SIP [10-21](#)
      - Skinny [10-24](#)

- configuring
  - connection [10-3](#)
  - DNS [10-25](#)
  - for SSL [11-18](#)
  - generic [10-8](#)
  - HTTP [10-9](#)
  - optimization [10-12, 15-6](#)
  - RTSP [10-20](#)
  - SIP [10-21](#)
  - Skippy [10-23](#)
- overview [10-1](#)
- types of [10-2](#)
- using with
  - Layer 3/Layer 4 policy maps [14-5](#)
  - policy maps [10-1](#)
  - using with Layer 3/Layer 4 policy maps [8-77](#)
- parameter map cipher, configuring for SSL [11-20](#)
- passwords, changing
  - admin [18-14](#)
  - for accounts [1-7](#)
  - for ACE appliance [5-75](#)
  - for chassis [5-75](#)
  - for CSS [5-75](#)
  - for GSS [5-75](#)
  - for the ACE [5-77](#)
  - for VSS [5-75](#)
  - in login window [1-7](#)
- PAT
  - configuring [12-27](#)
  - definition [GL-5](#)
- peers, high availability [13-15](#)
- ping
  - between devices [17-71](#)
  - definition [GL-5](#)
- policy map [14-34](#)
  - ACE device support [14-32](#)
  - associating with VLAN interface [12-14](#)
  - configuring [14-32](#)
  - match type
    - all-match [14-32](#)
    - first-match [14-32](#)
    - multi-match [14-32](#)
  - overview [14-2, 14-4](#)
  - rule and action topic reference [14-34](#)
  - rules and actions
    - generic server load balancing [14-35](#)
    - Layer 3/4 management traffic [14-39](#)
    - Layer 3/4 network traffic [14-41](#)
    - Layer 7 FTP command inspection [14-48](#)
    - Layer 7 HTTP deep packet inspection [14-51](#)
    - Layer 7 HTTP optimization [14-57](#)
    - Layer 7 server load balancing [14-61](#)
    - Layer 7 SIP deep packet inspection [14-68](#)
    - Layer 7 Skinny deep packet inspection [14-71](#)
    - RADIUS server load balancing [14-73](#)
    - RDP server load balancing [14-75](#)
    - RTSP server load balancing [14-76](#)
    - SIP server load balancing [14-79](#)
  - setting rules and actions [14-34](#)
- polling
  - enabling [18-57](#)
  - parameters, setting [17-46](#)
  - restarting
    - for devices [5-78](#)
    - for virtual contexts [6-108](#)
  - status
    - for devices [5-79](#)
    - for virtual contexts [6-104](#)
- POP probe attributes [8-64](#)
- port
  - number, configuring for probes [8-54](#)
- Port Address Translation
  - configuring [12-27](#)
  - definition [GL-5](#)
- port channel interfaces
  - attributes [12-37](#)
  - configuring [12-35](#)
- ports

- ANM, used for ANM client (browser) to ANM server communication [A-1](#)
  - ANM, used for managed device communication [A-1](#)
  - definition [GL-5](#)
  - reference [A-1](#)
  - predictor
    - hash address [8-2](#)
    - hash cookie [8-2](#)
    - hash header [8-2](#)
    - hash url [8-3](#)
    - least bandwidth [8-3](#)
    - leastconns [8-3](#)
    - least loaded [8-3](#)
    - response [8-3](#)
    - roundrobin [8-3](#)
  - predictor method
    - attributes [7-42, 8-40](#)
    - configuring for server farms [8-39](#)
  - primary attributes
    - 7600 series routers [5-38](#)
    - chassis [5-38](#)
    - configuration building blocks [16-8](#)
    - CSM [5-34](#)
    - CSS [5-35](#)
    - GSS [5-36](#)
    - virtual contexts [6-14](#)
  - probe
    - attribute tables [8-56](#)
    - configuring expect status [8-74](#)
    - configuring for health monitoring [8-51](#)
    - configuring SNMP OIDs [8-76](#)
    - DNS [8-57](#)
    - Echo-TCP [8-58](#)
    - Echo-UDP [8-58](#)
    - Finger [8-58](#)
    - FTP [8-59](#)
    - HTTP [8-60](#)
    - HTTPS [8-61](#)
    - IMAP [8-63](#)
    - POP [8-64](#)
    - port number [8-54](#)
    - RADIUS [8-65](#)
    - RTSP [8-65](#)
    - scripted [8-66](#)
    - scripting using TCL [8-50](#)
    - SIP-TCP [8-67](#)
    - SIP-UDP [8-68](#)
    - SMTP [8-69](#)
    - SNMP [8-69](#)
    - TCP [8-70](#)
    - Telnet [8-70](#)
    - types for real server monitoring [8-51](#)
    - UDP [8-71](#)
    - VM [8-72](#)
  - process, for traffic classification [14-3](#)
  - protocol inspection
    - configuring for virtual servers [7-18](#)
    - configuring match criteria
      - HTTP and HTTPS [7-22](#)
      - SIP [7-27](#)
    - HTTP/HTTPS conditions and options [7-23](#)
    - overview [14-6](#)
    - SIP conditions and options [7-28](#)
    - virtual server options [7-19](#)
  - protocol names and numbers [6-86](#)
  - protocols
    - for object groups [6-93](#)
    - for virtual servers [7-11](#)
  - proxy service, configuring for SSL [11-27](#)
- 
- ## R
- RADIUS
    - probe attributes [8-65](#)
    - server load balancing
      - class map match conditions [14-25](#)
      - policy map rules and actions [14-73](#)
    - sticky group attributes [9-14](#)

- sticky type [9-5](#)
- RBAC, definition [GL-5](#)
- RDP server load balancing policy map rules and actions [14-75](#)
- real server
  - activating [8-14, B-15](#)
  - adding to server farm [8-37](#)
  - configuration attributes [8-6, 8-37](#)
  - configuring [8-5](#)
    - load balancing service [8-1](#)
  - definition [GL-5](#)
  - groups [8-10](#)
  - health monitoring [8-49, 8-51](#)
  - modifying [8-17, B-18](#)
  - overview [8-3](#)
  - suspending [8-15, B-16](#)
  - viewing all [8-18](#)
- real time graph [17-48](#)
- redundancy
  - configuration requirements [13-12](#)
  - configuration synchronization [13-11](#)
  - definition [GL-5](#)
  - FT VLAN [13-10](#)
  - protocol [13-8](#)
  - task overview [13-14](#)
- registered mobile device list [18-70](#)
- removing
  - ACE license [6-39](#)
  - ANM license files [18-55](#)
  - rules from roles [5-61](#)
- resource, required for sticky groups [9-7](#)
- resource class
  - adding [6-46](#)
  - allocation constraints [6-44](#)
  - applying global resource classes [6-47](#)
  - attributes [6-45](#)
  - auditing local and global resource classes [6-49](#)
  - configuring
    - globally [6-46](#)
    - locally [6-52](#)
  - definition [GL-5](#)
  - deleting
    - global resource class [6-51](#)
    - local resource class [6-53](#)
  - deploying global resource class [6-48](#)
  - global [6-44](#)
  - local [6-44](#)
  - managing [6-43](#)
  - modifying [6-50](#)
  - overview [6-43](#)
  - using
    - global classes [6-46](#)
    - local classes [6-51](#)
    - viewing use by contexts [6-54](#)
- resources, allocation constraints [6-44](#)
- resource usage, viewing [17-26](#)
- response load-balancing method [8-3](#)
- restarting
  - ANM (see the Installation Guide) [18-56](#)
  - restarting device polling [5-78](#)
- restore
  - defaults [6-61](#)
- role
  - definition [GL-7](#)
  - deleting [5-54](#)
- role-based access control
  - authenticating ANM users with AA server [18-38](#)
  - containment overview [18-4](#)
  - definition [GL-5](#)
- roundrobin, load-balancing predictor [8-3](#)
- routed ports, configuring [5-46](#)
- routes, configuring static routes [5-39](#)
- RSA, definition [GL-5](#)
- RTSP
  - header
    - sticky group attributes [9-15](#)
    - sticky type [9-5](#)
  - parameter map

- attributes [10-20](#)
  - configuring [10-20](#)
  - probe attributes [8-65](#)
  - server load balancing
    - class map match conditions [14-26](#)
    - policy map rules and actions [14-76](#)
  - rule
    - changing for roles [5-61](#)
    - setting for policy maps [14-34](#)
- 
- S**
- sample SSL certificate and key pair [11-6](#)
  - screens, understanding [1-9](#)
  - scripted probe
    - attributes [8-66](#)
    - overview [8-50](#)
  - secondary IP addresses [12-14](#)
  - secondary IP groups [12-14](#)
  - security ACL [6-78](#)
  - server
    - activating
      - real [8-14, B-15](#)
      - virtual [7-71](#)
    - managing [8-9](#)
    - suspending
      - real [8-15, B-16](#)
      - virtual [7-72](#)
  - server farm
    - adding real servers [8-37](#)
    - configuration attributes [7-34, 8-31](#)
    - configuring
      - HTTP return error-code checking [8-46](#)
      - load balancing [8-1, 8-30](#)
      - predictor method [8-39](#)
    - definition [GL-6](#)
    - Dynamic Workload Scaling [7-36, 8-33](#)
    - health monitoring [8-49](#)
    - inband health monitoring [7-37, 8-34](#)
    - overview [8-3, 8-5](#)
    - predictor method attributes [7-42, 8-40](#)
    - viewing list of [8-48](#)
  - Server Load Balancer (SLB), definition [GL-6](#)
  - server load balancing
    - generic class map match conditions [14-23](#)
    - generic policy map rules and actions [14-35](#)
    - Layer 7 class map match conditions [14-14](#)
    - Layer 7 policy map rules and actions [14-61](#)
    - overview [7-1, 8-1](#)
    - RADIUS class map match conditions [14-25](#)
    - RADIUS policy map rules and actions [14-73](#)
    - RDP policy map rules and actions [14-75](#)
    - RTSP class map match conditions [14-26](#)
    - RTSP policy map rules and actions [14-76](#)
    - SIP class map match conditions [14-27](#)
    - SIP policy map rules and actions [14-79](#)
  - service, definition [GL-6](#)
  - service object group
    - configuring [6-89](#)
    - ICMP service parameters [6-97](#)
    - protocols [6-93](#)
    - TCP/UDP service parameters [6-94](#)
  - setup sequence
    - SSL [11-4](#)
  - setup syslog for Autosync, enabling [5-27](#)
  - shared object
    - and deleting virtual servers [7-10](#)
    - configuring [7-10](#)
    - configuring for virtual servers [7-9](#)
  - SIP
    - configuring protocol inspection [7-21](#)
    - deep packet inspection
      - class map match conditions [14-30](#)
      - policy map rules and actions [14-68](#)
    - header sticky type [9-5](#)
    - parameter map
      - attributes [10-21](#)
      - configuring [10-21](#)



- protocol inspection conditions and options [7-28](#)
- server load balancing
  - class map match conditions [14-27](#)
  - policy map rules and actions [14-79](#)
- SIP-TCP probe attributes [8-67](#)
- SIP-UDP probe attributes [8-68](#)
- Skinny
  - deep packet inspection policy map rules and actions [14-71](#)
  - parameter map
    - attributes [10-24](#)
    - configuring [10-23](#)
- SMTP
  - configuring for email notifications [17-68](#)
  - probe attributes [8-69](#)
- SNMP
  - configuration attributes [6-27](#)
  - configuring
    - communities [6-28](#)
    - for virtual contexts [6-27](#)
    - notification [6-33](#)
    - trap destination hosts [6-32](#)
    - version 3 users [6-29](#)
  - credentials [5-30](#)
  - enabling collection [6-108](#)
  - enabling polling [5-7](#)
  - probe attributes [8-69](#)
  - supported versions [5-7](#)
  - trap destination host configuration [6-32](#)
  - user configuration attributes [6-30](#)
- special characters for matching string expressions [14-84](#)
- special configuration file, definition [GL-6](#)
- SSH
  - ACE appliance, enabling [5-6](#)
  - ACE modules, enabling [5-6](#)
  - chassis, enabling [5-5](#)
  - enabling on ACE modules for discovery [5-28](#)
- SSHv2, chassis requirement in ANM [5-6](#)
- SSL
  - certificate
    - exporting [11-15](#)
    - exporting attributes [11-16](#)
    - importing [11-7](#)
    - importing attributes [11-8, 11-9](#)
    - overview [11-3](#)
    - sample [11-6](#)
    - using [11-5](#)
  - configuring
    - authorization group certificates [11-32](#)
    - chain group certificates [11-23](#)
    - chain group parameters [11-23](#)
    - CSR parameters [11-24](#)
    - for virtual servers [7-17](#)
    - OCSPservice [11-29](#)
    - parameter map [11-18](#)
    - parameter map cipher [11-20](#)
    - proxy service [11-27](#)
  - CSR parameters [11-25](#)
  - editing
    - CSR parameters [11-25](#)
    - parameter map cipher info [11-20](#)
    - parameter maps [11-18, 11-27](#)
  - exporting
    - certificates [11-15](#)
    - key pairs [11-16](#)
    - keys [11-17](#)
  - generating
    - CSR [11-26](#)
    - key pair [11-14](#)
  - header insertion, configuring [14-89](#)
  - importing
    - certificates [11-7](#)
    - keys [11-11](#)
  - key
    - exporting [11-17](#)
    - importing [11-11](#)
    - overview [11-3](#)
    - using [11-10](#)

- key pair
  - exporting [11-16](#)
  - generating [11-14](#)
  - importing attributes [11-12](#)
  - sample [11-6](#)
- objects, deleting [11-2](#)
- overview [11-1](#)
- parameter map cipher table [11-20](#)
- parameter maps [11-18, 11-27](#)
- procedure overview [11-3](#)
- redirect authentication failure [11-21](#)
- sample certificate and key pair [11-6](#)
- setup sequence
  - using [11-4](#)
- URL rewrite, configuring [14-88](#)
- SSL certificate, using [11-5](#)
- SSL header insertion, configuring [14-85, 14-89](#)
- SSL key, using [11-10](#)
- SSL setup sequence, using [11-4](#)
- SSL URL rewrite, configuring [14-85](#)
- staged virtual server
  - deploying [7-87](#)
  - viewing all [7-87](#)
- static route
  - configuring [5-39, 12-28](#)
- statistics
  - ANM server [18-56](#)
- status, Cisco ANM server [18-52](#)
- Status bar [1-9](#)
- stickiness
  - cookie-based [9-3](#)
  - HTTP content [9-3](#)
  - HTTP cookie [9-3](#)
  - HTTP header [9-4](#)
  - IP netmask [9-4](#)
  - IPv6 prefix [9-4](#)
  - Layer 4 payload [9-4](#)
  - overview [9-1](#)
  - RADIUS [9-5](#)
  - RTSP header [9-5](#)
  - SIP header [9-5](#)
  - sticky group [9-6](#)
  - sticky table [9-6](#)
  - types [9-2](#)
- sticky
  - cookies for client identification [9-3](#)
  - definition [GL-6](#)
  - e-commerce application requirements [9-1](#)
  - groups [9-6](#)
  - HTTP header for client identification [9-4](#)
  - IP netmask for client identification [9-4](#)
  - overview [9-2](#)
  - types [9-2](#)
- sticky group
  - attributes
    - HTTP content [9-11](#)
    - HTTP cookie [9-12](#)
    - HTTP header [9-13](#)
    - IP netmask [9-13](#)
    - Layer 4 payload [9-14](#)
    - RADIUS [9-14](#)
    - RTSP header [9-15](#)
    - V6 prefix [9-13](#)
  - configuration options [7-47, 9-8](#)
  - configuring
    - load balancing [9-7](#)
    - sticky statics [9-15](#)
  - overview [9-6](#)
  - required resource allocation [9-7](#)
  - type-specific attributes [9-11](#)
  - viewing [9-15](#)
- sticky statics, configuring for sticky groups [9-15](#)
- sticky table overview [9-6](#)
- sticky type
  - IP netmask [9-4](#)
  - HTTP content [9-3](#)
  - HTTP cookie [9-3](#)

- HTTP header [9-4](#)
- IPv6 prefix [9-4](#)
- Layer 4 payload [9-4](#)
- RADIUS [9-5](#)
- RTSP header [9-5](#)
- SIP header [9-5](#)
- string expression, special characters [14-84](#)
- subnet objects, for object groups [6-92](#)
- supervisor
  - assigning VLAN groups to the ACE [12-4](#)
- supervisor module, viewing by chassis [5-79](#)
- suspend, definition [6L-6](#)
- suspending
  - DNS rules for GSS [7-75](#)
  - real servers [8-15, B-16](#)
  - virtual servers [7-72](#)
- switched virtual interface, adding to MSFC [12-5](#)
- switchover [13-9](#)
- switch virtual interfaces, configuring [5-45](#)
- synchronization of configuration [13-11](#)
- synchronizing
  - ACE module configurations [5-67](#)
  - configurations for high availability [13-30](#)
  - contexts created in CLI [7-2, 7-4](#)
  - device configurations [5-66](#)
  - virtual context configurations [6-105](#)
- sync status, virtual contexts [6-103](#)
- syslog
  - configuration attributes [6-20](#)
  - configuring
    - logging [6-19](#)
    - logging levels [6-19](#)
    - log hosts [6-23](#)
    - log messages [6-24](#)
    - log rate limits [6-26](#)
  - settings for synchronizing with ACE CLI autosync [6-105](#)
- syslog, setup for Autosync [5-27](#)
- syslog logging, configuring [6-19](#)

- syslog messages
  - enabling ACE [5-27](#)
  - overwriting the ACE logging device-id [18-62](#)
- system templates [4-1](#)

---

## T

- table
  - conventions [1-14](#)
  - customizing [1-15](#)
  - default distance values [5-40](#)
  - filtering information in [1-14](#)
  - ICMP type numbers and names [6-98](#)
  - protocol names and numbers [6-86](#)
  - topic reference for policy map rules and actions [14-34](#)
- table conventions [1-14](#)
- tables
  - for probe attributes [8-56](#)
  - for sticky group attributes [9-11](#)
- TACACS+ server, authenticating ANM users [18-38](#)
- tagging building blocks [16-4, 16-9](#)
- takeover, forcing in high availability [13-22](#)
- task overview, redundancy [13-14](#)
- TCL script
  - health monitoring [8-50](#)
  - overview [8-50](#)
- TCP
  - options for connection parameter maps [10-7](#)
  - probe attributes [8-70](#)
  - service parameters for object groups [6-94](#)
- Telnet
  - configuring credentials [5-29](#)
  - import method for chassis [5-5](#)
  - probe attributes [8-70](#)
- template. See building block.
- template editor [4-29](#)
  - edit application template definition [4-18](#)
- templates
  - system [4-1](#)

- user-defined [4-2](#)
- terminating
  - current user sessions [18-24](#)
- test
  - application definition definition [4-28](#)
- threshold, definition [GL-7](#)
- topic reference for configuring rules and actions [14-34](#)
- topology maps [17-68](#)
- traceroute, definition [GL-7](#)
- traffic, monitoring [17-30](#)
- traffic class components [14-4](#)
- traffic classification process [14-3](#)
- traffic policy
  - ACE device support [14-2](#)
  - components [14-4](#)
  - configuring [14-1](#)
  - for application acceleration [15-2](#)
  - for optimization [15-2](#)
  - lookup order [14-5](#)
  - overview [14-1](#)
- troubleshooting
  - importing, ACE module state [5-16](#)
  - IP discovery [20-7](#)
- troubleshooting, using lifeline [20-7](#)
- trunk ports, configuring [5-44](#)
- types of user [18-5](#)

---

## U

- UDP probe attributes [8-71](#)
- UDP service parameters, for object groups [6-94](#)
- understanding
  - domains [18-7](#)
  - operations privileges [18-6](#)
  - roles [18-6](#)
  - user groups [18-7](#)
- Unprovisioned, configuration status [6-103, 6-105](#)
- updating, configuration values [20-1](#)
- updating ACE licenses [6-40](#)

- upgrading virtual contexts [6-107](#)
- URL rewrite, configuring [14-88](#)
- user-defined groups
  - adding [5-72](#)
  - deleting [5-75](#)
  - duplicating [5-74](#)
  - modifying [5-73](#)
  - overview [5-72](#)
- user-defined templates [4-2](#)
- user roles, definition [GL-7](#)
- using
  - ACLs [6-78](#)
  - building blocks [16-1](#)
  - virtual contexts [6-2](#)

---

## V

- V6 prefix
  - sticky group attributes [9-13](#)
- versions of building blocks [16-4](#)
- view
  - application template instance details [4-12](#)
- viewing [18-61](#)
  - 7600 series router VLANs [5-49](#)
  - ACE license details [6-36](#)
  - ACLs by context [6-99](#)
  - all devices [5-78](#)
  - all real servers [8-18](#)
  - all server farms [8-48](#)
  - all sticky groups [9-15](#)
  - all virtual servers [7-81](#)
  - building block use [16-11](#)
  - BVI interfaces by context [12-25](#)
  - chassis VLANs [5-49](#)
  - configuration building block use [16-11](#)
  - current user sessions [18-24](#)
  - license information [6-42](#)
  - ports [5-42](#)
  - resource class use on contexts [6-54](#)

- staged virtual servers [7-87](#)
- virtual server details [7-81](#)
- virtual servers by context [7-65](#)
- VLAN interfaces by context [12-18](#)
- VIP Answer table, and GSS [7-73](#)
- virtual context
  - back up and restore overview [6-59](#)
  - comparing configuration with building block [6-101](#)
  - configuration
    - attributes [6-3](#)
    - audit [6-101](#)
    - options [6-8, 6-9](#)
    - primary attributes [6-14](#)
  - configuring [6-1](#)
  - BVI interfaces [12-19](#)
  - class map match conditions [14-8](#)
  - class maps [14-6](#)
  - global policies [6-35](#)
  - load balancing services [7-1](#)
  - policy map rules and actions [14-34](#)
  - policy maps [14-32](#)
  - primary attributes [6-14](#)
  - resource classes [6-52](#)
  - SNMP [6-27](#)
  - static routes [12-28](#)
  - syslog [6-19](#)
  - system attributes [6-13](#)
  - VLAN interfaces [12-6](#)
- create a configuration backup [6-62](#)
- creating [6-2](#)
- definition [GL-7](#)
- deleting [6-107](#)
- description [6-2](#)
- expert options [6-101](#)
- managing [6-103](#)
- modifying [6-106](#)
- monitoring resource usage [17-26](#)
- polling
  - restarting [6-108](#)
  - viewing status [6-104](#)
- restore a configuration [6-66](#)
- synchronizing configurations [6-105](#)
- sync status [6-103](#)
- syslog setup for autosync [6-105](#)
- upgrading [6-107](#)
- using
  - for configuration building blocks [16-6](#)
  - overview [6-2](#)
- viewing
  - all contexts [6-103](#)
  - BVI interfaces [12-25](#)
  - polling status [6-104](#)
  - resource class use [6-54](#)
  - sync status [6-103](#)
  - VLANS [12-18](#)
- virtual data center [B-1, B-2](#)
- Virtual Local Area Network (VLAN), definition [GL-7](#)
- virtual server [7-30, 7-57](#)
  - activating [7-71](#)
  - additional options [7-3](#)
  - advanced view properties [7-12](#)
  - and user roles [7-3](#)
  - application acceleration [7-53](#)
  - application acceleration, additional configuration options [7-57](#)
  - basic view properties [7-16](#)
  - configuration
    - methods [7-4](#)
    - recommendations [7-4](#)
  - configuration subsets [7-8](#)
  - configuring [7-1, 7-2, 7-7](#)
    - application acceleration [7-53](#)
    - default Layer 7 load balancing [7-50](#)
    - in ANM [7-2](#)
    - in CLI [7-2, 7-4](#)
    - Layer 7 load balancing [7-30](#)
    - NAT [7-63](#)
    - optimization [7-53, 15-9](#)

- properties [7-11](#)
- protocol inspection [7-18](#)
- shared objects [7-9](#)
- SSL [7-17](#)
- definition [GL-7](#)
- deleting and shared objects [7-10](#)
- deployed servers, modifying [7-88](#)
- deploying staged servers [7-87](#)
- groups [7-67](#)
- GSS answer table [7-73, 7-75](#)
- load balancing
  - default [7-50](#)
  - Layer 7 [7-30](#)
- managing [7-66](#)
- minimum configuration [7-2](#)
- modifying
  - deployed servers [7-88](#)
  - staged servers [7-88](#)
- optimization [7-53](#)
- overview [7-2](#)
- properties
  - advanced view [7-12](#)
  - basic view [7-16](#)
- protocols [7-11](#)
- recommendations for configuring [7-4](#)
- shared objects [7-5, 7-9](#)
- SSL attributes [7-17](#)
- staged servers
  - deploying [7-87](#)
  - modifying [7-88](#)
  - viewing [7-87](#)
- suspending [7-72](#)
- viewing
  - all [7-81](#)
  - by context [7-65](#)
  - details [7-81](#)
  - servers [7-65](#)
  - staged servers [7-87](#)

## VLAN

- adding to 7600 series router [5-48](#)
- adding to chassis [5-48](#)
- configuring
  - access control [12-14](#)
  - ACLs [12-14](#)
  - Layer 2 VLANs [5-50](#)
  - Layer 3 VLANs [5-51](#)
  - NAT [12-26](#)
  - policy maps [12-14](#)
- creating VLAN groups [5-52](#)
- definition [GL-7](#)
- FT VLAN for redundancy [13-10](#)
- interface
  - access control [12-14](#)
  - attributes [12-6](#)
  - configuring [12-6](#)
  - NAT pools [12-26](#)
  - policy maps [12-14](#)
  - viewing [12-18](#)
- managing [5-48](#)
- modifying
  - on 7600 series router [5-51](#)
  - on chassis [5-51](#)
- viewing
  - by 7600 series router [5-49](#)
  - by chassis [5-49](#)
- VLAN group, creating [5-52](#)
- VLAN interfaces
  - attributes [12-6](#)
  - configuring [12-6](#)
    - access control [12-14](#)
    - for virtual contexts [12-6](#)
    - policy maps [12-14](#)
  - viewing by context [12-18](#)
- VLANs
  - configuring [12-3](#)
  - configuring on the supervisor [12-3](#)
  - enabling autostate supervisor notification [12-5](#)
  - groups, assigning [12-4](#)

- groups, creating [12-3](#)
- secondary IP addresses, configuring [12-14](#)
- switched virtual interfaces, adding to MSFC [12-5](#)
- VLAN Trunking Protocol, definition [GL-8](#)
- VM probe attributes [8-72](#)
- VMware
  - ANM plug-in [B-2](#)
  - Cisco ACE SLB tab
    - details [B-3](#)
    - overview [B-3](#)
  - information about [B-2](#)
  - managing real servers [B-12](#)
  - map real server to vCenter Server [5-68](#)
  - vCenter Server [B-2](#)
  - vSphere Client [B-2](#)
- VSS
  - changing passwords [5-75](#)
- VTP, definition [GL-8](#)
- VTP domain, definition [GL-8](#)

---

## W

- Web server, definition [GL-8](#)
- weighted roundrobin. See roundrobin
- write mem on Config > Operations, enabling [18-63](#)

