

# Intel® Desktop Board DG965SS Product Guide

---

Order Number: D46815-003

# Revision History

Revision	Revision History	Date
-001	First release of the Intel® Desktop Board DG965SS Product Guide	June 2006
-002	Second release of the Intel® Desktop Board DG965SS Product Guide	September 2006
-003	Added operating system support	December 2006

If an FCC declaration of conformity marking is present on the board, the following statement applies:

## FCC Declaration of Conformity

This device complies with Part 15 of the FCC Rules. Operation is subject to the following two conditions: (1) this device may not cause harmful interference, and (2) this device must accept any interference received, including interference that may cause undesired operation.

For questions related to the EMC performance of this product, contact:

Intel Corporation, 5200 N.E. Elam Young Parkway, Hillsboro, OR 97124  
1-800-628-8686

This equipment has been tested and found to comply with the limits for a Class B digital device, pursuant to Part 15 of the FCC Rules. These limits are designed to provide reasonable protection against harmful interference in a residential installation. This equipment generates, uses, and can radiate radio frequency energy and, if not installed and used in accordance with the instructions, may cause harmful interference to radio communications. However, there is no guarantee that interference will not occur in a particular installation. If this equipment does cause harmful interference to radio or television reception, which can be determined by turning the equipment off and on, the user is encouraged to try to correct the interference by one or more of the following measures:

- Reorient or relocate the receiving antenna.
- Increase the separation between the equipment and the receiver.
- Connect the equipment to an outlet on a circuit other than the one to which the receiver is connected.
- Consult the dealer or an experienced radio/TV technician for help.

Any changes or modifications to the equipment not expressly approved by Intel Corporation could void the user's authority to operate the equipment.

Tested to comply with FCC standards for home or office use.

## Canadian Department of Communications Compliance Statement

This digital apparatus does not exceed the Class B limits for radio noise emissions from digital apparatus set out in the Radio Interference Regulations of the Canadian Department of Communications.

Le présent appareil numérique n'émet pas de bruits radioélectriques dépassant les limites applicables aux appareils numériques de la classe B prescrites dans le Règlement sur le brouillage radioélectrique édicté par le ministère des Communications du Canada.

## Disclaimer

INFORMATION IN THIS DOCUMENT IS PROVIDED IN CONNECTION WITH INTEL® PRODUCTS. NO LICENSE, EXPRESS OR IMPLIED, BY ESTOPPEL OR OTHERWISE, TO ANY INTELLECTUAL PROPERTY RIGHTS IS GRANTED BY THIS DOCUMENT. EXCEPT AS PROVIDED IN INTEL'S TERMS AND CONDITIONS OF SALE FOR SUCH PRODUCTS, INTEL ASSUMES NO LIABILITY WHATSOEVER, AND INTEL DISCLAIMS ANY EXPRESS OR IMPLIED WARRANTY, RELATING TO SALE AND/OR USE OF INTEL PRODUCTS INCLUDING LIABILITY OR WARRANTIES RELATING TO FITNESS FOR A PARTICULAR PURPOSE, MERCHANTABILITY, OR INFRINGEMENT OF ANY PATENT, COPYRIGHT OR OTHER INTELLECTUAL PROPERTY RIGHT. Intel products are not intended for use in medical, life saving, or life sustaining applications. Intel may make changes to specifications and product descriptions at any time, without notice.

Desktop Board DG965SS may contain design defects or errors known as errata which may cause the product to deviate from published specifications. Current characterized errata are available on request.

Contact your local Intel sales office or your distributor to obtain the latest specifications and before placing your product order.

Copies of documents which have an ordering number and are referenced in this document, or other Intel literature, may be obtained from Intel Corporation by going to the World Wide Web site at: <http://www.intel.com/> or by calling 1-800-548-4725.

Intel, Pentium, and Celeron are registered trademarks of Intel Corporation or its subsidiaries in the United States and other countries.

\* Other names and brands may be claimed as the property of others.

Copyright © 2006, Intel Corporation. All rights reserved.

# Preface

---

This Product Guide gives information about board layout, component installation, BIOS update, and regulatory requirements for Intel® Desktop Board DG965SS.

## Intended Audience

The Product Guide is intended for technically qualified personnel. It is not intended for general audiences.

## Use Only for Intended Applications

All Intel desktop boards are evaluated as Information Technology Equipment (I.T.E.) for use in personal computers (PC) for installation in homes, offices, schools, computer rooms, and similar locations. The suitability of this product for other PC or embedded non-PC applications or other environments, such as medical, industrial, alarm systems, test equipment, etc. may not be supported without further evaluation by Intel.

## Document Organization

The chapters in this Product Guide are arranged as follows:

- 1 Desktop Board Features: a summary of product features
- 2 Installing and Replacing Desktop Board Components: instructions on how to install the desktop board and other hardware components
- 3 Updating the BIOS: instructions on how to update the BIOS
- A Error Messages and Indicators: information about BIOS error messages and beep codes
- B Regulatory Compliance: safety and EMC regulations and product certifications

## Conventions

The following conventions are used in this manual:



### **CAUTION**

*Cautions warn the user about how to prevent damage to hardware or loss of data.*



### **NOTE**

*Notes call attention to important information.*

## Terminology

The table below gives descriptions of some common terms used in the product guide.

<b>Term</b>	<b>Description</b>
GB	Gigabyte (1,073,741,824 bytes)
GHz	Gigahertz (one billion hertz)
KB	Kilobyte (1024 bytes)
MB	Megabyte (1,048,576 bytes)
Mbit	Megabit (1,048,576 bits)
MHz	Megahertz (one million hertz)

## Box Contents

- Intel® Desktop Board DG965SS
- I/O shield
- One ATA-66/100 cable
- Two locking Serial ATA cables
- One Floppy Drive cable
- Quick Reference poster
- Configuration and battery caution statement label
- Intel® Express Installer driver CD-ROM
- Intel® Express Installer software CD-ROM

# Contents

---

## 1 Desktop Board Features

Supported Operating Systems.....	10
Desktop Board Components.....	11
Processor.....	13
Main Memory.....	14
Intel® G965 Express Chipset.....	15
Intel G965 Graphics Subsystem.....	15
Intel® Graphics Media Accelerator X3000 (Intel® GMA X3000) .....	15
Onboard Audio Subsystem .....	16
Input/Output (I/O) Controller .....	16
LAN Subsystem .....	17
LAN Subsystem Software.....	17
RJ-45 LAN Connector LEDs.....	17
Hi-Speed USB 2.0 Support .....	18
Enhanced IDE Interface .....	18
Serial ATA.....	18
Expandability.....	18
BIOS.....	19
Serial ATA and IDE Auto Configuration.....	19
PCI and PCI Express* Auto Configuration .....	19
Security Passwords.....	19
Hardware Management Features .....	20
Hardware Monitoring and Fan Speed Control .....	20
Chassis Intrusion.....	20
Power Management Features .....	21
ACPI.....	21
Power Connectors.....	21
Fan Headers .....	21
LAN Wake Capabilities.....	22
Instantly Available PC Technology.....	22
+5 V Standby Power Indicator LED .....	23
Wake from USB.....	23
Wake from PS/2 Keyboard/Mouse .....	23
PME# Signal Wake-up Support .....	24
WAKE# Signal Wake-up Support.....	24
Speaker.....	24
Battery .....	24
Real-Time Clock.....	24

## 2 Installing and Replacing Desktop Board Components

Before You Begin .....	25
Installation Precautions.....	26
Prevent Power Supply Overload .....	26
Observe Safety and Regulatory Requirements.....	26
Installing the I/O Shield .....	27
Installing and Removing the Desktop Board .....	28

Installing and Removing a Processor .....	29
Installing a Processor .....	29
Installing the Processor Fan Heat Sink .....	32
Connecting the Processor Fan Heat Sink Cable .....	32
Removing the Processor .....	33
Installing and Removing Memory .....	33
Guidelines for Dual Channel Memory Configuration .....	33
Two or Four DIMMs .....	33
Three DIMMs .....	34
Installing DIMMs .....	35
Removing DIMMs .....	37
Installing and Removing a PCI Express x16 Card .....	38
Installing a PCI Express x16 Card .....	38
Removing the PCI Express x16 Card .....	39
Connecting the IDE Cable .....	40
Connecting the Serial ATA (SATA) Cable .....	41
Connecting to Internal Headers .....	42
Connecting to the HD Audio Link Header .....	43
Connecting to the IEEE 1394a Header .....	43
Installing a Front Panel Audio Solution for Intel® High Definition Audio .....	43
Connecting to the Serial Port Header .....	45
Connecting to the Alternate Front Panel Power LED Header .....	45
Connecting to the Front Panel Header .....	46
Connecting to the USB 2.0 Headers .....	46
Connecting to the Flexible Audio System .....	47
Connecting Chassis Fan and Power Cables .....	48
Connecting Chassis Fan Cables .....	48
Connecting Power Cables .....	49
Other Connectors and Headers .....	50
Setting the BIOS Configuration Jumper .....	51
Clearing Passwords .....	52
Back Panel Connectors .....	53
<b>3 Updating the BIOS</b>	
Updating the BIOS with the Intel® Express BIOS Update Utility .....	59
Updating the BIOS with the ISO Image BIOS Update File or the Iflash Memory Update Utility .....	60
Obtaining the BIOS Update File .....	60
Updating the BIOS with the ISO Image BIOS Update File .....	60
Updating the BIOS with Iflash .....	61
Recovering the BIOS .....	62
<b>A Error Messages and Indicators</b>	
BIOS Beep Codes .....	63
BIOS Error Messages .....	63
<b>B Regulatory Compliance</b>	
Safety Regulations .....	65
Place Battery Marking .....	65
European Union Declaration of Conformity Statement .....	66
Product Ecology Statements .....	67
Lead-Free Desktop Board .....	70

EMC Regulations .....	71
Ensure Electromagnetic Compatibility (EMC) Compliance .....	72
Product Certifications.....	73
Board-Level Certification Markings .....	73
Chassis and Component Certifications.....	74

## Figures

1. Desktop Board DG965SS Components .....	11
2. LAN Connector LEDs .....	17
3. Location of Standby Power Indicator.....	23
4. Installing the I/O Shield .....	27
5. Desktop Board DG965SS Mounting Screw Hole Locations .....	28
6. Lift Socket Lever .....	29
7. Lift the Load Plate.....	29
8. Remove the Protective Socket Cover .....	30
9. Remove the Processor from the Protective Processor Cover .....	30
10. Install Processor.....	31
11. Close the Load Plate .....	31
12. Connecting the Processor Fan Heat Sink Cable to the Processor Fan Header .....	32
13. Dual Channel Memory Configuration Example 1 .....	33
14. Dual Channel Memory Configuration Example 2 .....	34
15. Dual Channel Memory Configuration Example 3 .....	34
16. Use DDR2 DIMMs .....	35
17. Installing a DIMM .....	36
18. Installing a PCI Express x16 Card .....	38
19. Removing a PCI Express x16 Card .....	39
20. Connecting the IDE Cable .....	40
21. Connecting the Serial ATA Cable .....	41
22. Internal Headers .....	42
23. Back Panel Audio Connectors .....	47
24. Location of Chassis Fan Headers .....	48
25. Connecting Power Supply Cables .....	49
26. Location of Other Connectors and Headers .....	50
27. Location of the BIOS Configuration Jumper Block .....	51
28. Back Panel Connectors .....	53
29. Removing the Battery .....	58

**Tables**

1. Feature Summary.....	9
2. Desktop Board DG965SS Components.....	12
3. LAN Connector LEDs.....	17
4. HD Audio Link Header Signal Names.....	43
5. IEEE 1394a Signal Header Names.....	43
6. Front Panel Audio Header Signal Names for Intel High Definition Audio.....	43
7. AC '97 Audio Header Signal Names.....	44
8. Serial Port Header Signal Names.....	45
9. Alternate Front Panel Power LED Header.....	45
10. Front Panel Header.....	46
11. USB 2.0 Header Signal Names.....	46
12. Jumper Settings for the BIOS Setup Program Modes.....	51
13. Beep Codes.....	63
14. BIOS Error Messages.....	63
15. Safety Regulations.....	65
16. Lead-Free Board Markings.....	70
17. EMC Regulations.....	71
18. Product Certification Markings.....	73



# 1 Desktop Board Features

This chapter briefly describes the main features of Intel® Desktop Board DG965SS. Table 1 summarizes the major features of the desktop board.

**Table 1. Feature Summary**

<b>Form Factor</b>	microATX (243.84 millimeters [9.60 inches] x 243.84 millimeters [9.60 inches])
<b>Processor</b>	Support for an Intel® processor in the LGA775 package
<b>Main Memory</b>	<ul style="list-style-type: none"> <li>• Four 240-pin, DDR2 1.8 V ( only) SDRAM Dual Inline Memory Module (DIMM) sockets</li> <li>• 800/677/533 MHz single or dual channel DDR2 SDRAM interface</li> <li>• Support for up to 8 GB of system memory</li> </ul>
<b>Chipset</b>	Intel® G965 Express Chipset consisting of: <ul style="list-style-type: none"> <li>• Intel® G965 Express Chipset Graphics Memory Controller Hub (GMCH)</li> <li>• Intel® 82801HB I/O Controller Hub (ICH8)</li> </ul>
<b>Graphics</b>	<ul style="list-style-type: none"> <li>• Intel® G965 Express Chipset with Intel® Graphics Media Accelerator X3000 (Intel® GMA X3000)</li> <li>• One PCI Express* x16 connector supporting PCI Express graphics cards</li> </ul>
<b>Audio</b>	<ul style="list-style-type: none"> <li>• 6-channel (5.1) onboard subsystem, featuring:               <ul style="list-style-type: none"> <li>– Intel® High Definition Audio interface</li> <li>– SigmaTel* STAC9227 audio codec</li> </ul> </li> <li>• HD Audio Link header</li> </ul>
<b>Expansion Capabilities</b>	<ul style="list-style-type: none"> <li>• One PCI Express x1 connector</li> <li>• One PCI Express x16 connector</li> <li>• Two PCI connectors</li> </ul>
<b>Peripheral Interfaces</b>	<ul style="list-style-type: none"> <li>• Up to 10 USB 2.0 ports               <ul style="list-style-type: none"> <li>– Six ports routed to the back panel</li> <li>– Four ports routed to two USB headers</li> </ul> </li> <li>• Up to two IEEE 1394a ports               <ul style="list-style-type: none"> <li>– One port routed to the back panel</li> <li>– One port routed to an IEEE 1394a header</li> </ul> </li> <li>• Four Serial ATA (SATA) channels (3.0 Gb/s), via the ICH8, one device per channel</li> <li>• One IDE interface with ATA-66/100 support (two devices)</li> <li>• One diskette drive interface</li> <li>• One parallel port</li> <li>• PS/2* keyboard and mouse ports</li> </ul>

continued

**Table 1. Feature Summary** (continued)

<b>BIOS</b>	<ul style="list-style-type: none"> <li>• Intel® Platform Innovation Framework for extensible firmware interface</li> <li>• 8 Mbit symmetrical flash memory</li> <li>• Support for SMBIOS</li> <li>• Intel® Rapid BIOS Boot</li> <li>• Intel® Express BIOS Update</li> </ul>
<b>Power Management</b>	<ul style="list-style-type: none"> <li>• Support for Advanced Configuration and Power Interface (ACPI)</li> <li>• Suspend to RAM (STR)</li> <li>• Wake on USB, PCI Express, PS/2, LAN, and front panel</li> </ul>
<b>Hardware Management</b>	<p>Hardware monitor with:</p> <ul style="list-style-type: none"> <li>• Two fan sensing inputs used to monitor fan activity</li> <li>• Remote diode temperature sensing</li> <li>• Intel® Quiet System Technology fan speed control</li> <li>• Voltage sensing to detect out of range values</li> </ul>
<b>LAN Support</b>	Intel 82566DC Gigabit (10/100/1000 Mb/s) Ethernet LAN controller

**Related Links:**

For more information about Desktop Board DG965SS, including the Technical Product Specification (TPS), BIOS updates, and device drivers, go to:

<http://support.intel.com/support/motherboards/desktop/>

## Supported Operating Systems

The desktop board supports the following operating systems:

- Microsoft Windows Vista\* Ultimate
- Microsoft Windows Vista Enterprise
- Microsoft Windows Vista Business
- Microsoft Windows Vista Home Premium
- Microsoft Windows Vista Home Basic
- Microsoft Windows Vista Ultimate 64-bit edition
- Microsoft Windows Vista Enterprise 64-bit edition
- Microsoft Windows Vista Business 64-bit edition
- Microsoft Windows Vista Home Premium 64-bit edition
- Microsoft Windows Vista Home Basic 64-bit edition
- Microsoft Windows\* XP Media Center Edition 2005
- Microsoft Windows XP Professional
- Microsoft Windows XP Professional x64 Edition
- Microsoft Windows XP Home
- Microsoft Windows 2000

# Desktop Board Components

Figure 1 shows the approximate location of the major components on Desktop Board DG965SS.

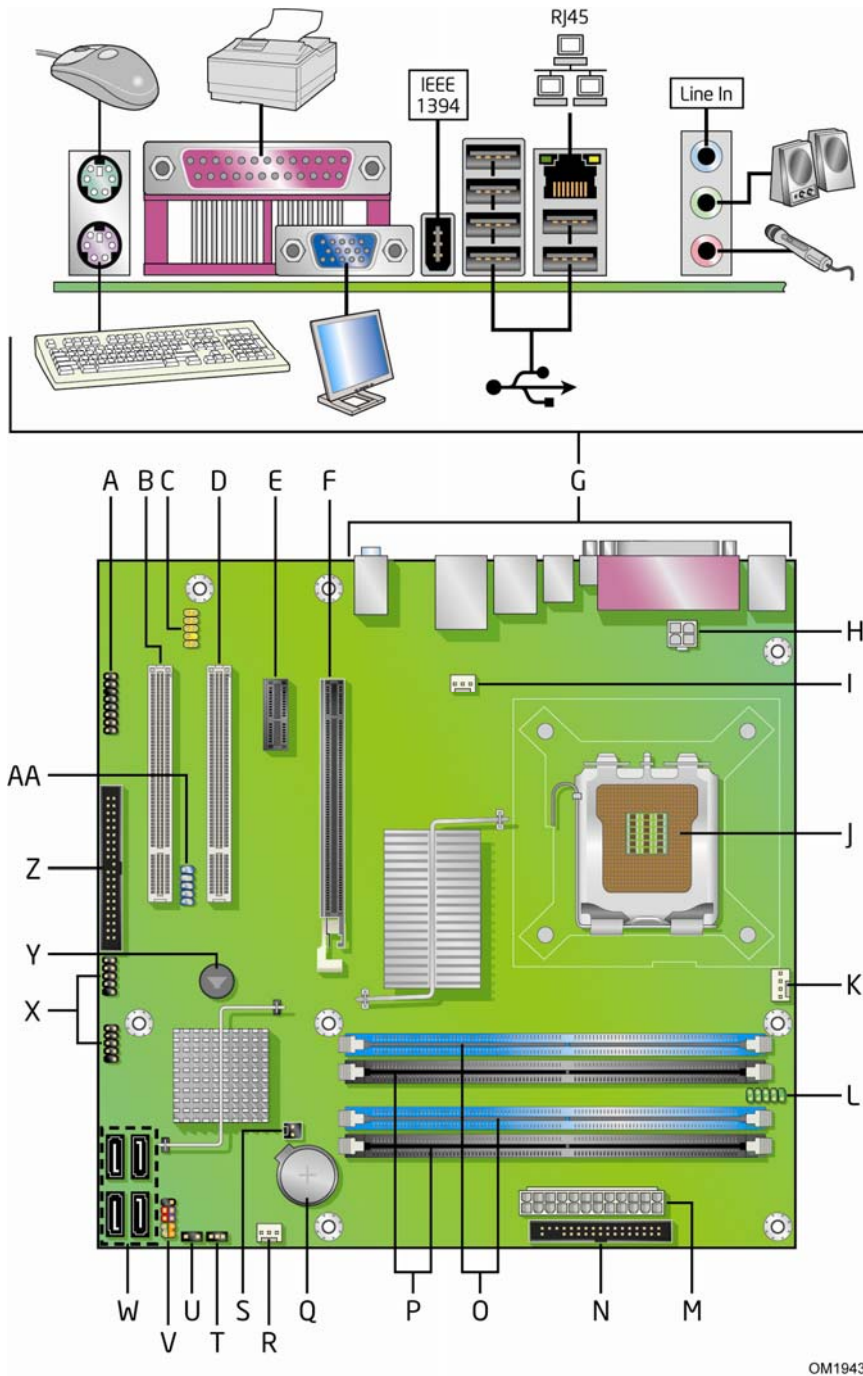

**Figure 1. Desktop Board DG965SS Components**

**Table 2. Desktop Board DG965SS Components**

Label	Description
A	High Definition Audio Link header
B	PCI bus connector 2
C	Front panel audio header
D	PCI bus connector 1
E	PCI Express x 1 connector
F	PCI Express x 16 connector
G	Back panel connectors
H	12 V processor core voltage connector (2 x 2 pin )
I	Rear chassis fan header (3-pin)
J	Processor socket
K	Processor fan header (4-pin)
L	Serial header
M	Main power connector (2 x 12 pin)
N	Diskette drive connector
O	DDR2 DIMM 0 sockets
P	DDR2 DIMM 1 sockets
Q	Battery
R	Front chassis fan header (3-pin)
S	Chassis intrusion header
T	BIOS configuration jumper block
U	Alternate front panel power LED header
V	Front panel header
W	Serial ATA connectors
X	High-speed USB 2.0 headers
Y	Speaker
Z	IDE connector
AA	IEEE 1394a header

**Related Links:**

Go to the following links for more information about:

- Desktop Board DG965SS <http://www.intel.com/design/motherbd>  
<http://support.intel.com/support/motherboards/desktop>
- Supported processors <http://support.intel.com/support/motherboards/desktop>
- Audio software and utilities <http://www.intel.com/design/motherbd>
- LAN software and drivers <http://www.intel.com/design/motherbd>

## Processor



### CAUTION

*Failure to use the appropriate power supply and/or not connecting the 12 V (2 x 2 pin) power connector to the desktop board may result in damage to the board, or the system may not function properly.*

Desktop Board DG965SS supports an Intel® processor in the LGA775 package. Processors are not included with the desktop board and must be purchased separately. The processor connects to the desktop board through the LGA775 socket.

The supported processors list for Desktop Board DG965SS is located on the web at:

<http://support.intel.com/support/motherboards/desktop/>

### Related Links:

Go to the following page for more information about:

Instructions on installing or upgrading the processor, page 29 in Chapter 2

## Main Memory



### NOTE

To be fully compliant with all applicable Intel® SDRAM memory specifications, the board should be populated with DIMMs that support the Serial Presence Detect (SPD) data structure. If your memory modules do not support SPD, you will see a notification to this effect on the screen at power up. The BIOS will attempt to configure the memory controller for normal operation.

The desktop board supports the dual or single channel memory configurations defined below.

- Four 240-pin Double Data Rate 2 (DDR2) SDRAM Dual Inline Memory Module (DIMM) connectors with gold-plated contacts.
- Support for:
  - Unbuffered, non-registered single or double-sided DIMMs
  - Non-ECC DDR2 memory
  - DIMM Type and Timings listed below:

Type	Timing
DDR2-800	5-5-5 or 6-6-6 only
DDR2-667	5-5-5 only
DDR2-533	4-4-4 only
  - Serial Presence Detect (SPD) memory only
  - Memory configurations listed below:
    - Up to 2.0 GB utilizing 256 Mb technology
    - Up to 4.0 GB utilizing 512 Mb or 1 Gb technology
    - Up to 8.0 GB utilizing 1 Gb technology



### NOTE

1 Gb memory technology is not supported on DDR2-800 DIMMs.

Intel recommends using memory from the tested memory lists, available at:

<http://www.cmtlabs.com/mbsearch.asp>

or

[http://www.intel.com/products/motherboard/index.htm?iid=HMPAGE+Header\\_2\\_Product\\_MB](http://www.intel.com/products/motherboard/index.htm?iid=HMPAGE+Header_2_Product_MB)

### Related Links:

Go to the following links or pages for more information about:

- SDRAM specifications, <http://www.intel.com/technology/memory/>
- Installing memory, page 33 in Chapter 2

## Intel® G965 Express Chipset

The Intel G965 Express Chipset consists of the following devices:

- Intel G965 Express Chipset Graphics Memory Controller Hub (GMCH)
- Intel 82801HB I/O Controller Hub (ICH8)

### Related Links:

Go to the following link for more information about the Intel G965 Express Chipset:

<http://developer.intel.com/design/nav/pcserver.htm>

## Intel G965 Graphics Subsystem

The Intel G965 Express Chipset contains two separate, mutually exclusive graphics options. Either the integrated Intel GMA X3000 is used or a PCI Express x16 add-in card can be used. When a PCI Express x16 add-in card is installed, the Intel GMA X3000 is disabled.

## Intel® Graphics Media Accelerator X3000 (Intel® GMA X3000)

The Intel GMA X3000 features the following:

- 667 MHz core frequency
- Enhanced 3D graphics
- Supports flat panel displays up to 2048 x 1536 at 75 Hz refresh rate (in dual-channel mode) or digital CRT/HDTV up to 1920 x 1080 at 85 Hz refresh rate
- Advanced Digital Display 2 card or Media Expansion Card (ADD2/MEC) support
- Dynamic Video Memory Technology support
- Digital Video Interface (DVI) support



### NOTE

*A minimum of 512 MB of system memory is required in order for the Intel GMA X3000 integrated graphics controller to operate properly.*

## Onboard Audio Subsystem

Desktop Board DG965SS has a flexible 6-channel (5.1) onboard audio subsystem that includes a SigmaTel STAC9227 audio codec and an HD Audio Link header.

The audio subsystem features:

- Intel High Definition Audio interface
- Advanced jack sense, for the back panel connectors, that enables the audio codec to recognize the device that is connected to an audio port and retask the connector via the audio driver.
- S/N (signal-to-noise) ratio: 95 dB
- Microphone input supporting:
  - Stereo microphone
  - Microphone boost

The subsystem includes the following connectors:

- Front panel audio connector, including functionality for:
  - Line out
  - Microphone in
- Back panel audio connectors that are configurable through the drivers of the audio devices:
  - Line in/retasking jack
  - Line out/retasking jack
  - Mic in/retasking jack

### Related Links:

Go to the following link or pages for more information about:

- Audio drivers and utilities <http://support.intel.com/support/motherboards/desktop/>
- Installing the front panel audio solution, page 43
- The location of audio connectors, Figure 23 on page 47

## Input/Output (I/O) Controller

The super I/O controller features the following:

- Low pin count (LPC) interface
- One serial port header
- One parallel port with Extended Capabilities Port (ECP) and Enhanced Parallel Port (EPP) support
- Serial IRQ interface compatible with serialized IRQ support for PCI systems
- PS/2-style mouse and keyboard interfaces
- Interface for one 1.2 MB or 1.44 MB diskette drive
- Intelligent power management, including a programmable wake up event interface
- PCI power management support



## LAN Subsystem

The LAN subsystem, with Intel 82801HB (ICH8) provides the following functions:

- Intel 82566DC Gigabit (10/100/1000 Mb/s) Ethernet LAN controller
- Intel 82801HB I/O Controller Hub (ICH8)
- Support for RJ-45 connector with status indicator LEDs
- Programmable transit threshold
- Configurable EEPROM that contains the MAC address

## LAN Subsystem Software

For LAN software and drivers, refer to the DG965SS link on Intel's World Wide Web site at:

<http://support.intel.com/support/motherboards/desktop>

## RJ-45 LAN Connector LEDs

Two LEDs are built into the RJ-45 LAN connector located on the back panel (see Figure 2). These LEDs indicate the status of the LAN.

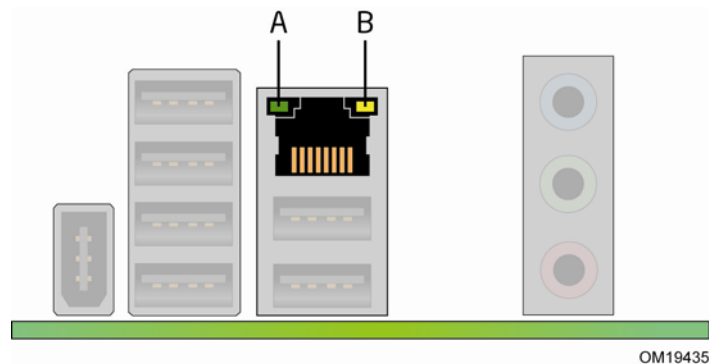

**Figure 2. LAN Connector LEDs**

Table 3 describes the LED states when the board is powered up and the LAN subsystem is operating.

**Table 3. LAN Connector LEDs**

LED	LED Color	LED State	Indicates
A	Green	Off	LAN link is not established
		On	LAN link is established
		Blinking	LAN activity is occurring
B	N/A	Off	10 Mb/s data rate
	Green	On	100 Mb/s data rate
	Yellow	On	1000 Mb/s data rate

## Hi-Speed USB 2.0 Support



### NOTE

*Computer systems that have an unshielded cable attached to a USB port might not meet FCC Class B requirements, even if no device or a low-speed USB device is attached to the cable. Use a shielded cable that meets the requirements for a full-speed USB device.*

The desktop board supports up to 10 USB 2.0 ports via ICH8 (six ports routed to the back panel and four ports routed to two internal USB 2.0 headers). USB 2.0 ports are backward compatible with USB 1.1 devices. USB 1.1 devices will function normally at USB 1.1 speeds.

USB 2.0 support requires both an operating system and drivers that fully support USB 2.0 transfer rates. Disabling Hi-Speed USB in the BIOS reverts all USB 2.0 ports to USB 1.1 operation. This may be required to accommodate operating systems that do not support USB 2.0.

## Enhanced IDE Interface

The ICH8's IDE interface handles the exchange of information between the processor and peripheral devices such as hard disk drives and CD-ROM drives. The interface supports:

- Up to two IDE devices (such as hard drives)
- ATAPI-style devices (such as CD-ROM drives)
- Older PIO Mode devices
- Ultra DMA-33 and ATA-66/100 protocols

## Serial ATA

The desktop board supports four Serial ATA channels (3.0 Gb/s) via ICH8, connecting one device per channel.

## Expandability

For system expansion, the desktop board provides the following:

- One PCI Express x1 connector
- One PCI Express x 16 connector
- Two PCI bus connectors

## BIOS

The BIOS provides the Power-On Self-Test (POST), the BIOS Setup program, the PCI/PCI Express and IDE auto-configuration utilities, and the video BIOS. The BIOS is stored in the Serial Peripheral Interface (SPI) Flash.

The BIOS can be updated by following the instructions on page 59 in Chapter 3.

## Serial ATA and IDE Auto Configuration

If you install a Serial ATA or IDE device (such as a hard drive) in your computer, the auto-configuration utility in the BIOS automatically detects and configures the device for your computer. You do not need to run the BIOS Setup program after installing a Serial ATA or IDE device. You can override the auto-configuration options by specifying manual configuration in the BIOS Setup program.

## PCI and PCI Express\* Auto Configuration

If you install a PCI/PCI Express add-in card in your computer, the PCI/PCI Express auto-configuration utility in the BIOS automatically detects and configures the resources (IRQs, DMA channels, and I/O space) for that add-in card. You do not need to run the BIOS Setup program after you install a PCI/PCI Express add-in card.

## Security Passwords

The BIOS includes security features that restrict whether the BIOS Setup program can be accessed and who can boot the computer. A supervisor password and a user password can be set for the BIOS Setup and for booting the computer, with the following restrictions:

- The supervisor password gives unrestricted access to view and change all Setup options. If only the supervisor password is set, pressing <Enter> at the password prompt of Setup gives the user restricted access to Setup.
- If both the supervisor and user passwords are set, you must enter either the supervisor password or the user password to access Setup. Setup options are then available for viewing and changing depending on whether the supervisor or user password was entered.
- Setting a user password restricts who can boot the computer. The password prompt is displayed before the computer is booted. If only the supervisor password is set, the computer boots without asking for a password. If both passwords are set, you can enter either password to boot the computer.

### Related Links:

For instructions on resetting the password, see Clearing Passwords on page 52.

## Hardware Management Features

The hardware management features of Desktop Board DG965SS enable the board to be compatible with the Wired for Management (WfM) specification. The board has several hardware management features including the following:

- Fan speed monitoring and control
- Thermal and voltage monitoring
- Chassis intrusion detection

## Hardware Monitoring and Fan Speed Control

The features of the hardware monitoring and fan speed control include:

- Monitoring of power supply voltages to detect levels above and below acceptable values
- Intel Quiet System Technology fan speed control, delivering acoustically-optimized thermal management



### **NOTE**

*Memory must be installed in the Channel A, DIMM 0 socket to enable Intel® Quiet System Technology.*

- Fan speed controllers and sensors integrated into the ICH8
- Thermal sensors in the processor, GMCH, and ICH8 plus an onboard remote sensor
- Thermally monitored closed-loop fan control, for all onboard fans, that can adjust fan speed or switch the fans off as needed

## Chassis Intrusion

The board supports a chassis security feature that detects if the chassis cover has been removed. The security feature uses a mechanical switch on the chassis that can be connected to the chassis intrusion header on the desktop board. See Figure 26 on page 50 for the location of the chassis intrusion header.

## Power Management Features

Power management is implemented at several levels, including:

- Software support through the Advanced Configuration and Power Interface (ACPI)
- Hardware support:
  - Power connectors
  - Fan headers
  - LAN wake capabilities
  - Instantly Available PC technology (Suspend to RAM)
  - +5 V standby power indicator LED
  - Wake from USB
  - Wake from PS/2 keyboard/mouse
  - Power Management Event signal (PME#) wakeup support
  - WAKE# signal wake-up support

### ACPI

ACPI gives the operating system direct control over the power management and Plug and Play functions of a computer. The use of ACPI with the desktop board requires an operating system that provides full ACPI support.

### Power Connectors

ATX12V-compliant power supplies can turn off the computer power through system control. When an ACPI-enabled computer receives the correct command, the power supply removes all non-standby voltages.

When resuming from an AC power failure, the computer returns to the power state it was in before power was interrupted (either on or off). The computer's response can be set by using the Last Power State feature in the BIOS Setup program's Boot menu.

The desktop board has two power connectors. See Figure 25 on page 49 for the location of the power connectors.

### Fan Headers

The function/operation of the fans is as follows:

- The fans are on when the computer is in the ACPI S0 state.
- The fans are off when the computer is in the ACPI S3, S4, or S5 state.
- Each fan header is wired to a tachometer input of the hardware monitoring and control device
- All fan headers support closed-loop fan control that can adjust the fan speed or switch the fan on or off as needed.
- All fan headers have a +12 V dc connection.

The desktop board has a 4-pin processor fan header and two 3-pin chassis fan headers.

## LAN Wake Capabilities



### CAUTION

*For LAN wake capabilities, the 5 V standby line for the power supply must be capable of delivering adequate +5 V standby current. Failure to provide adequate standby current when using this feature can damage the power supply.*

LAN wakeup capabilities enable remote wake-up of the computer through a network. The LAN subsystem monitors network traffic and upon detecting a Magic Packet\* frame, it asserts a wake-up signal that powers up the computer.

## Instantly Available PC Technology



### CAUTIONS

*For Instantly Available PC technology, the 5 V standby line for the power supply must be capable of delivering adequate +5 V standby current. Failure to provide adequate standby current when using this feature can damage the power supply and/or effect ACPI S3 sleep state functionality.*

*Power supplies used with this desktop board must be able to provide enough standby current to support the standard Instantly Available (ACPI S3 sleep state) configuration. If the standby current necessary to support multiple wake events from the PCI and/or USB buses exceeds power supply capacity, the desktop board may lose register settings stored in memory.*

Instantly Available PC technology enables the board to enter the ACPI S3 (Suspend-to-RAM) sleep state. While in the S3 sleep state, the computer will appear to be off. If the computer has a dual-colored power LED on the front panel, the sleep state is indicated by the LED turning amber. When signaled by a wake-up device or event, the computer quickly returns to its last known awake state.

The desktop board supports the *PCI Bus Power Management Interface Specification*. Add-in cards that support this specification can participate in power management and can be used to wake the computer.

## +5 V Standby Power Indicator LED



### CAUTION

*If the AC power has been switched off and the standby power indicator is still lit, disconnect the power cord before installing or removing any devices connected to the board. Failure to do so could damage the board and any attached devices.*

The desktop board's standby power indicator, shown in Figure 3, is lit when there is standby power still present on the board even when the computer appears to be off. For example, when this LED is lit, standby power is still present at the memory module sockets and the PCI bus connectors.

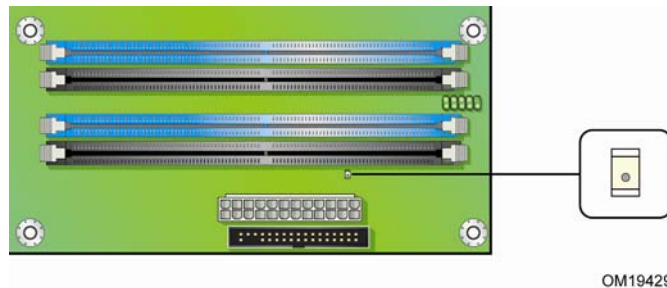

**Figure 3. Location of Standby Power Indicator**

### Related Links:

For more information on standby current requirements for the desktop board, refer to the Technical Product Specification by going to the following link, finding the product, and selecting Product Documentation from the left-hand menu:

<http://support.intel.com/support/motherboards/desktop/>

## Wake from USB



### NOTE

*Wake from USB requires the use of a USB peripheral that supports Wake from USB.*

USB bus activity wakes the computer from an ACPI S3 state.

## Wake from PS/2 Keyboard/Mouse

PS/2 keyboard/mouse activity wakes the computer from an ACPI S3 state.

## **PME# Signal Wake-up Support**

When the PME# signal on the PCI bus is asserted, the computer wakes from an ACPI S3, S4, or S5 state.

## **WAKE# Signal Wake-up Support**

When the WAKE# signal on the PCI Express bus is asserted, the computer wakes from an ACPI S2, S3, S4, or S5 state.

## **Speaker**

A speaker is mounted on the desktop board. The speaker provides audible error code (beep code) information during the Power-On Self-Test (POST).

## **Battery**

A battery on the desktop board keeps the values in CMOS RAM and the clock current when the computer is turned off. Go to page 54 for instructions on how to replace the battery.

## **Real-Time Clock**

The desktop board has a time-of-day clock and 100-year calendar. The battery on the desktop board keeps the clock current when the computer is turned off.



## 2 Installing and Replacing Desktop Board Components

---

This chapter tells you how to:

- Install the I/O shield
- Install and remove the desktop board
- Install and remove a processor
- Install and remove memory
- Install and remove a PCI Express x16 card
- Connect the IDE and Serial ATA cables
- Connect to the internal headers
- Connect to the flexible audio system
- Connect the chassis fan and power cables
- Set the BIOS configuration jumper
- Clear passwords
- Replace the battery

### Before You Begin



#### CAUTIONS

*The procedures in this chapter assume familiarity with the general terminology associated with personal computers and with the safety practices and regulatory compliance required for using and modifying electronic equipment.*

*Disconnect the computer from its power source and from any telecommunications links, networks, or modems before performing any of the procedures described in this chapter. Failure to disconnect power, telecommunications links, networks, or modems before you open the computer or perform any procedures can result in personal injury or equipment damage. Some circuitry on the board can continue to operate even though the front panel power button is off.*

Follow these guidelines before you begin:

- Always follow the steps in each procedure in the correct order.
- Set up a log to record information about your computer, such as model, serial numbers, installed options, and configuration information.
- Electrostatic discharge (ESD) can damage components. Perform the procedures described in this chapter only at an ESD workstation using an antistatic wrist strap and a conductive foam pad. If such a station is not available, you can provide some ESD protection by wearing an antistatic wrist strap and attaching it to a metal part of the computer chassis.

## **Installation Precautions**

When you install and test the Intel desktop board, observe all warnings and cautions in the installation instructions.

To avoid injury, be careful of:

- Sharp pins on connectors
- Sharp pins on printed circuit assemblies
- Rough edges and sharp corners on the chassis
- Hot components (such as processors, voltage regulators, and heat sinks)
- Damage to wires that could cause a short circuit

Observe all warnings and cautions that instruct you to refer computer servicing to qualified technical personnel.

## **Prevent Power Supply Overload**

Do not overload the power supply output. To avoid overloading the power supply, make sure that the calculated total current loads of all the modules within the computer is less than the output current rating of each of the power supplies output circuits.

## **Observe Safety and Regulatory Requirements**

Read and adhere the instructions in this section and the instructions supplied with the chassis and associated modules. If you do not follow these instructions and the instructions provided by the chassis and module suppliers, you increase safety risk and the possibility of noncompliance with regional laws and regulations. If the instructions for the chassis are inconsistent with these instructions or the instructions for associated modules, contact the supplier's technical support to find out how you can ensure that your computer meets safety and regulatory requirements.

### **Related Links**

For information about regulatory compliance, go to Appendix B on page 65.

## Installing the I/O Shield

The desktop board comes with an I/O shield. When installed in the chassis, the shield blocks radio frequency transmissions, protects internal components from dust and foreign objects, and promotes correct airflow within the chassis.

Install the I/O shield before installing the desktop board in the chassis. Place the shield inside the chassis as shown in Figure 4. Press the shield into place so that it fits tightly and securely. If the shield does not fit, obtain a properly sized shield from the chassis supplier.

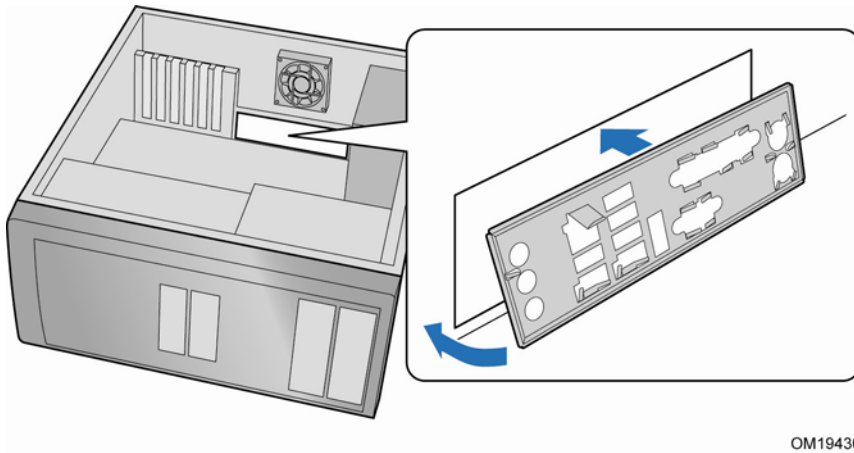

OM19430

**Figure 4. Installing the I/O Shield**

## Installing and Removing the Desktop Board



### CAUTION

*Only qualified technical personnel should do this procedure. Disconnect the computer from its power source before performing the procedures described here. Failure to disconnect the power before you open the computer can result in personal injury or equipment damage.*

Refer to your chassis manual for instructions on installing and removing the desktop board.

Figure 5 shows the location of the mounting screw holes for Desktop Board DG965SS.

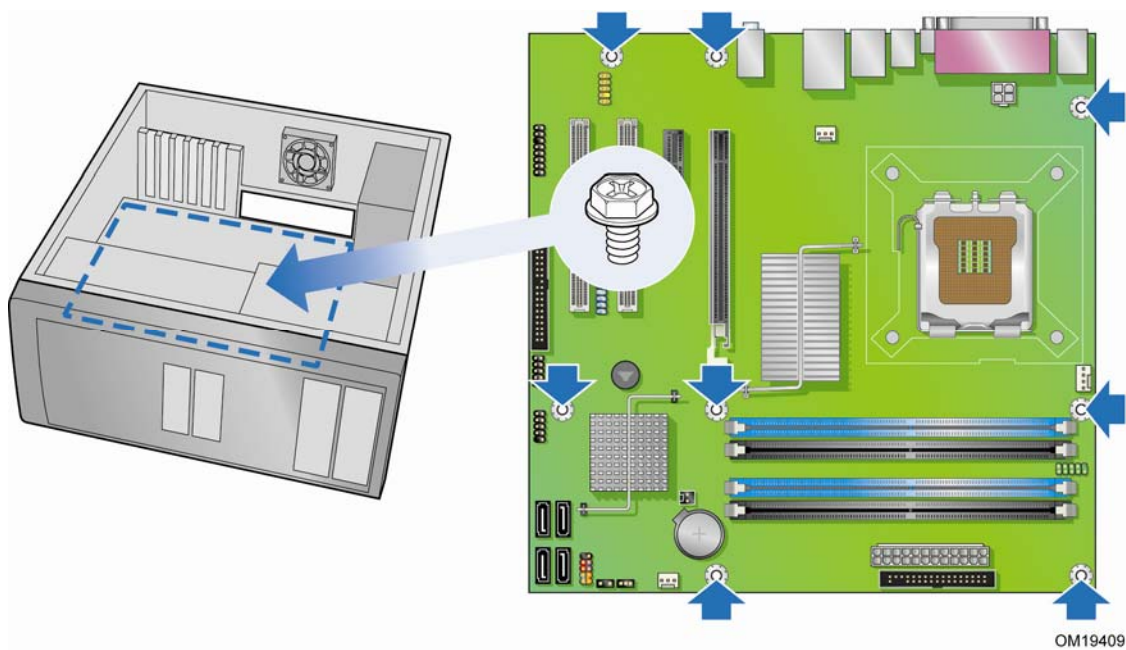

**Figure 5. Desktop Board DG965SS Mounting Screw Hole Locations**

## Installing and Removing a Processor

Instructions on how to install the processor to the desktop board are given below.

### Installing a Processor



#### CAUTION

*Before installing or removing the processor, make sure the AC power has been removed by unplugging the power cord from the computer; the standby power LED should not be lit (see Figure 3 on page 23). Failure to do so could damage the processor and the board.*

To install a processor, follow these instructions:

1. Observe the precautions in "Before You Begin" on page 25.
2. Open the socket lever by pushing the lever down and away from the socket (Figure 6, A and B).

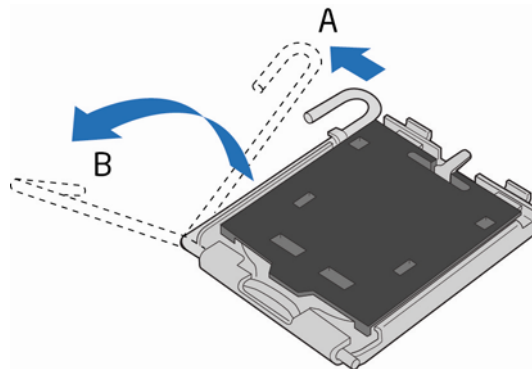

OM19410

**Figure 6. Lift Socket Lever**

3. Lift the load plate (Figure 7, A). Do not touch the socket contacts (Figure 7, B).

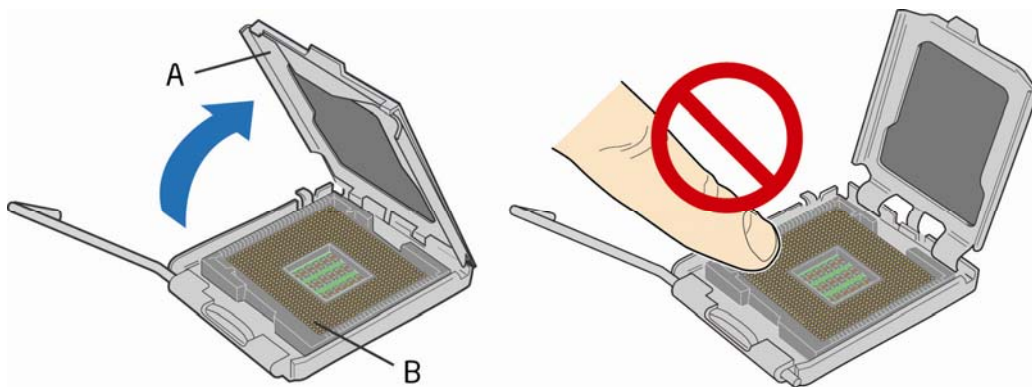

OM19411

**Figure 7. Lift the Load Plate**

4. Remove the plastic protective socket cover from the load plate (Figure 8). Do not discard the protective socket cover. Always replace the socket cover if the processor is removed from the socket.

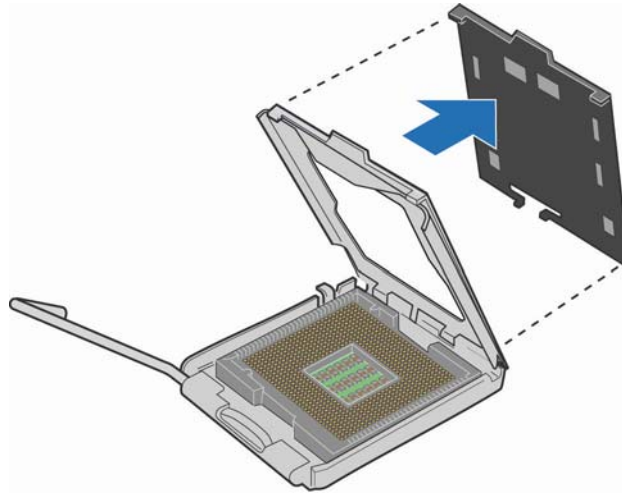

OM19412

**Figure 8. Remove the Protective Socket Cover**

5. Remove the processor from the protective processor cover. Hold the processor only at the edges, being careful not to touch the bottom of the processor (see Figure 9). Do not discard the protective processor cover. Always replace the processor cover if the processor is removed from the socket.



OM19413

**Figure 9. Remove the Processor from the Protective Processor Cover**

## Installing and Replacing Desktop Board Components

6. Hold the processor with your thumb and index fingers oriented as shown in Figure 10. Make sure fingers align to the socket cutouts (Figure 10, A). Align notches (Figure 10, B) with the socket (Figure 10, C). Lower the processor straight down without tilting or sliding the processor in the socket.

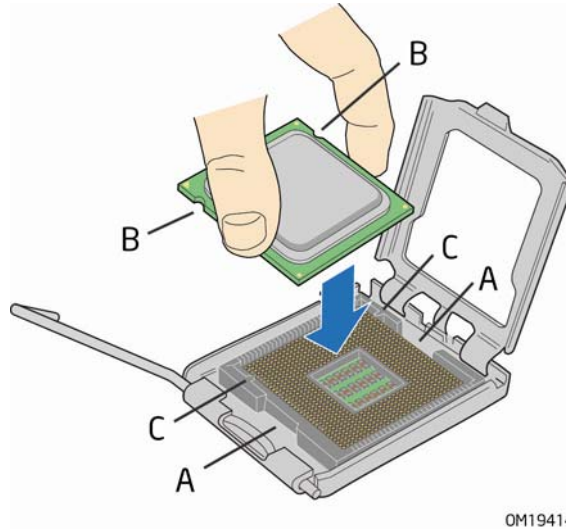

**Figure 10. Install Processor**

7. Pressing down on the load plate (Figure 11, A) close and engage the socket lever (Figure 11, B).

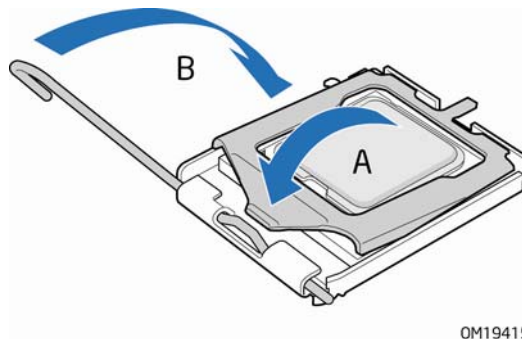

**Figure 11. Close the Load Plate**

## Installing the Processor Fan Heat Sink

Desktop Board DG965SS has an integrated processor fan heat sink retention mechanism (RM). For instructions on how to attach the processor fan heat sink to the integrated processor fan heat sink RM, refer to the boxed processor manual or the Intel World Wide Web site at:

[Integration of the Boxed Intel® Pentium® 4 Processor in the 775-Land Package](#)

## Connecting the Processor Fan Heat Sink Cable

Connect the processor fan heat sink cable to the 4-pin processor fan header (see Figure 12). A fan with a 4-pin connector as shown in Figure 12, A is recommended; however, a fan with a 3-pin connector (Figure 12, B) can be used. Since the 3-pin fan cannot use the onboard fan control, the fan will always operate at full speed.

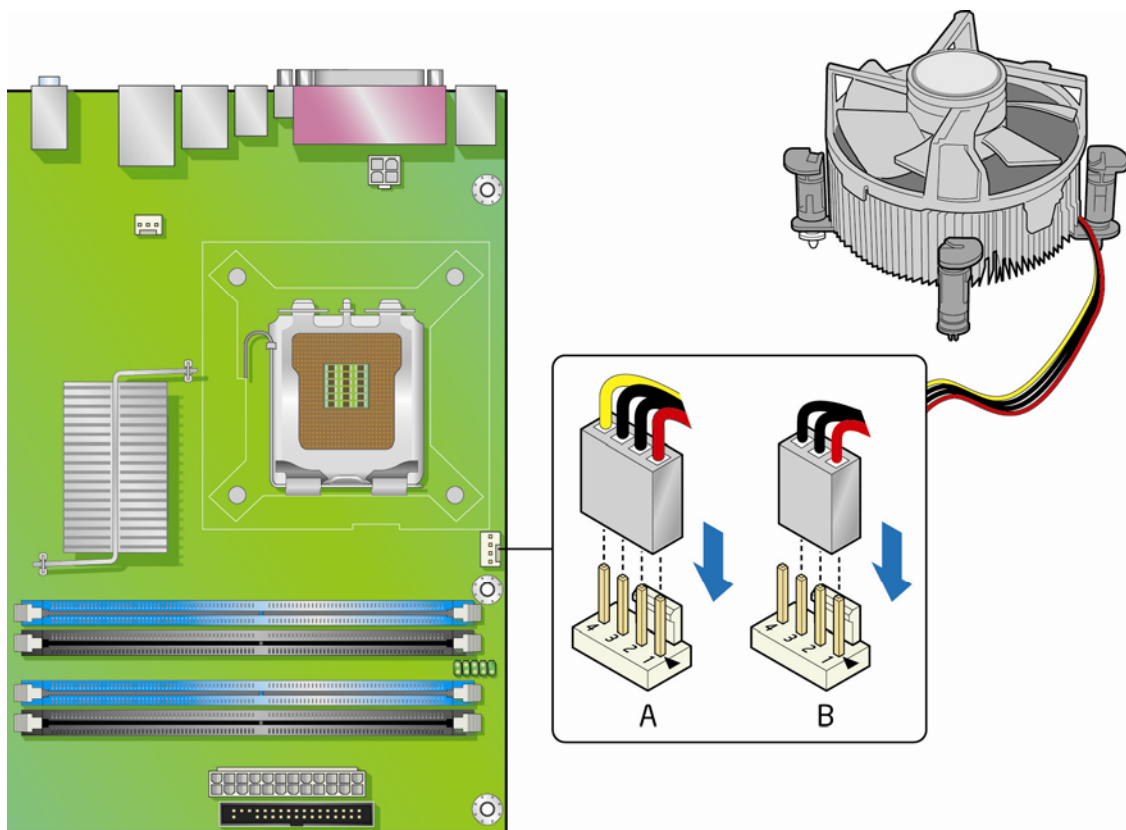

**Figure 12. Connecting the Processor Fan Heat Sink Cable to the Processor Fan Header**



## Removing the Processor

For instructions on how to remove the processor fan heat sink and processor, refer to the processor installation manual or the Intel World Wide Web site at:

[Integration of the Boxed Intel® Pentium® 4 Processor in the 775-Land Package](#)

## Installing and Removing Memory



### NOTE

To be fully compliant with all applicable Intel SDRAM memory specifications, the board requires DIMMs that support the Serial Presence Detect (SPD) data structure. You can access the PC Serial Presence Detect Specification at:

[http://www.intel.com/technology/memory/ddr/specs/dda18c32\\_64\\_128x72ag\\_a.pdf](http://www.intel.com/technology/memory/ddr/specs/dda18c32_64_128x72ag_a.pdf)

Desktop board DG965SS has four 240-pin DDR2 DIMM sockets arranged as DIMM 0 and DIMM 1 in both Channel A and Channel B.

## Guidelines for Dual Channel Memory Configuration

Before installing DIMMs, read and follow these guidelines for dual channel configuration.

### Two or Four DIMMs

Install a matched pair of DIMMs equal in speed and size (see Figure 13) in DIMM 0 (blue) of both channels A and B.



**Figure 13. Dual Channel Memory Configuration Example 1**

If additional memory is to be used, install another matched pair of DIMMs in DIMM 1 (black) in both channels A and B (see Figure 14).



Figure 14. Dual Channel Memory Configuration Example 2

### Three DIMMs

Install a matched pair of DIMMs equal in speed and size in DIMM 0 (blue) and DIMM 1 (black) of channel A. Install a DIMM equal in speed and total size of the DIMMs installed in channel A in either DIMM 0 or DIMM 1 of channel B (see Figure 15).

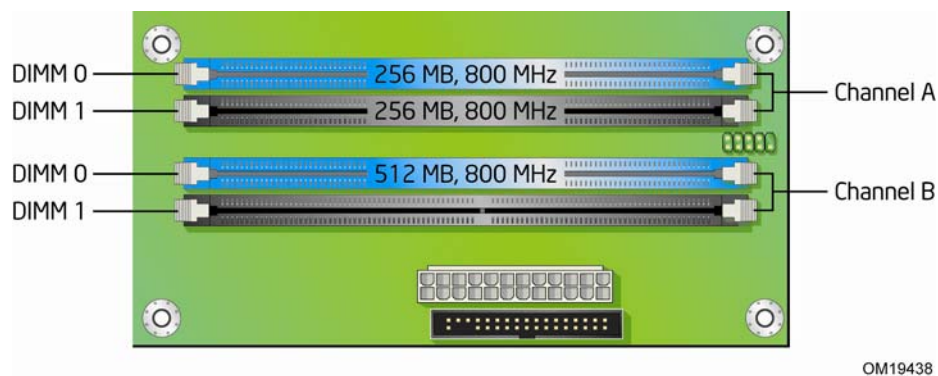

Figure 15. Dual Channel Memory Configuration Example 3



**NOTE**

*All other memory configurations will result in single channel memory operation.*

## Installing DIMMs

To make sure you have the correct DIMM, place it on the illustration of the DDR2 DIMM in Figure 16. All the notches should match with the DDR2 DIMM.

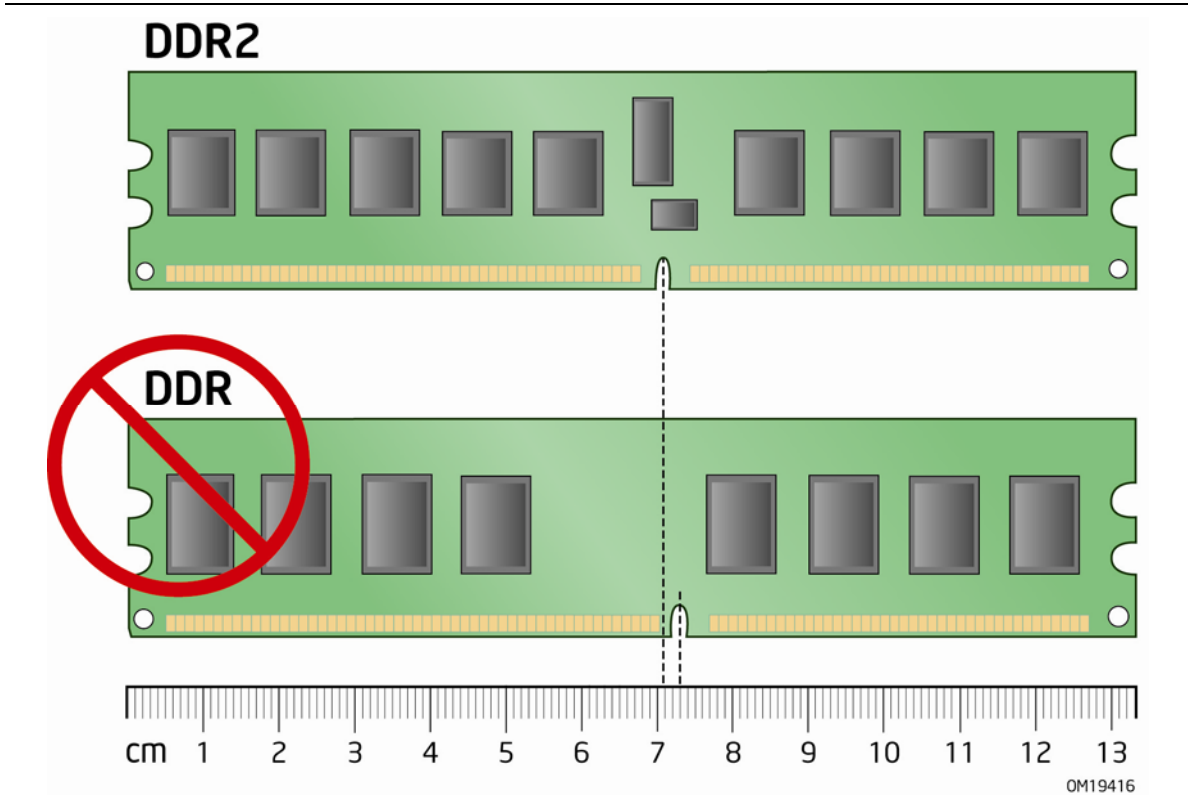

Figure 16. Use DDR2 DIMMs



**NOTE**

Memory must be installed in the Channel A, DIMM 0 socket to enable Intel Quiet System Technology.

To install a DIMM, follow these steps:

1. Observe the precautions in "Before You Begin" on page 25.
2. Turn off all peripheral devices connected to the computer. Turn off the computer and disconnect the AC power cord.
3. Remove the computer's cover and locate the DIMM sockets (see Figure 17).

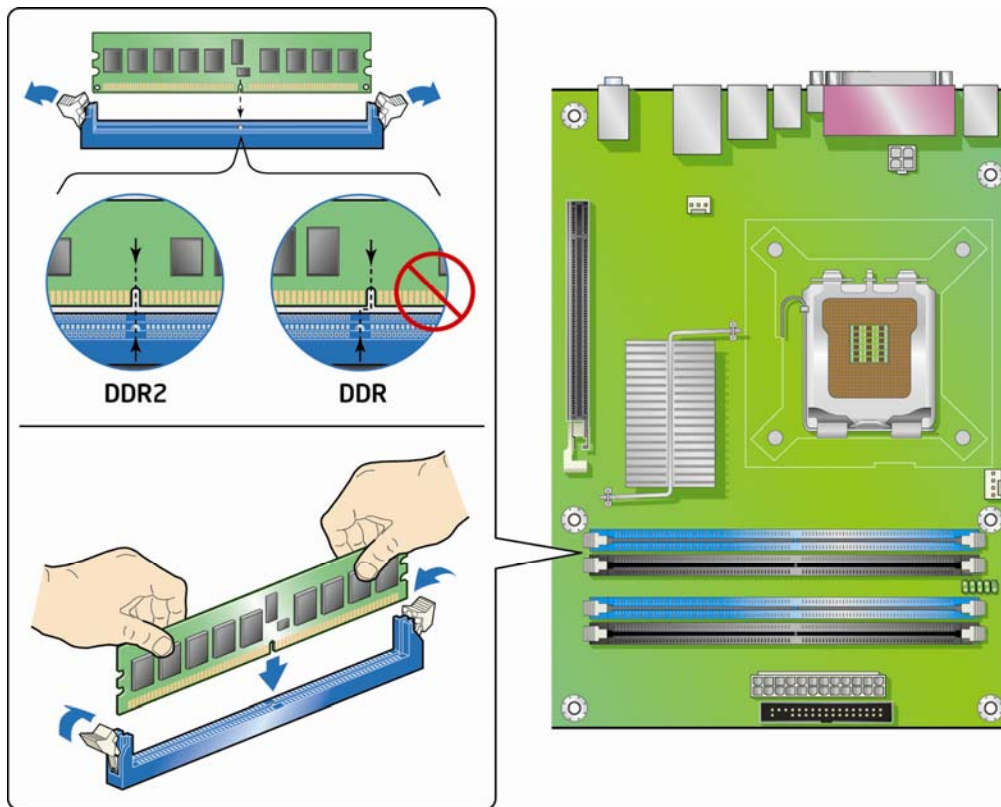

OM19417

**Figure 17. Installing a DIMM**

4. Make sure the clips at either end of the DIMM socket(s) are pushed outward to the open position.
5. Holding the DIMM by the edges, remove it from its anti-static package.
6. Position the DIMM above the socket. Align the small notch at the bottom edge of the DIMM with the keys in the socket (see inset in Figure 17).
7. Insert the bottom edge of the DIMM into the socket.
8. When the DIMM is inserted, push down on the top edge of the DIMM until the retaining clips snap into place. Make sure the clips are firmly in place.
9. Replace the computer's cover and reconnect the AC power cord.

## **Removing DIMMs**

To remove a DIMM, follow these steps:

1. Observe the precautions in "Before You Begin" on page 25.
2. Turn off all peripheral devices connected to the computer. Turn off the computer.
3. Remove the AC power cord from the computer.
4. Remove the computer's cover.
5. Gently spread the retaining clips at each end of the DIMM socket. The DIMM pops out of the socket.
6. Hold the DIMM by the edges, lift it away from the socket, and store it in an anti-static package.
7. Reinstall and reconnect any parts you removed or disconnected to reach the DIMM sockets.
8. Replace the computer's cover and reconnect the AC power cord.

## Installing and Removing a PCI Express x16 Card



### CAUTION

When installing a PCI Express x16 card on the desktop board, ensure that the card is fully seated in the PCI Express x16 connector before you power on the system. If the card is not fully seated in the PCI Express connector, an electrical short may result across the PCI Express connector pins. Depending on the over-current protection of the power supply, certain desktop board components and/or traces may be damaged.

### Installing a PCI Express x16 Card

1. Observe the precautions in "Before You Begin" on page 25.
2. Place the card in the PCI Express x16 connector (Figure 18, A) and press down on the card until it is completely seated in the connector and the card retention notch snaps into place around the retention mechanism pin.
3. Secure the card's metal bracket to the chassis back panel with a screw (Figure 18, B).

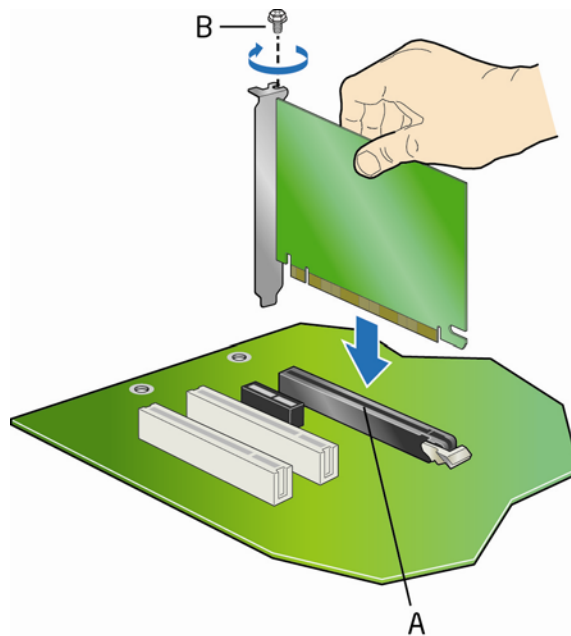

OM19418

Figure 18. Installing a PCI Express x16 Card

## Removing the PCI Express x16 Card

Follow these instructions to remove the PCI Express x16 card from the connector:

1. Observe the precautions in "Before You Begin" on page 25.
2. Remove the screw (Figure 19, A) that secures the card's metal bracket to the chassis back panel.
3. Push back on the card ejector lever (Figure 19, B) to release the card from the connector (C).
4. Pull the card straight up.

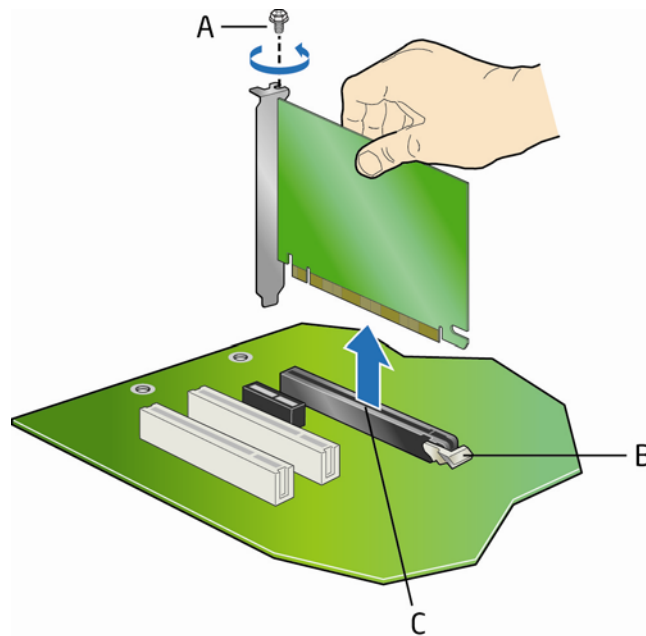

OM19419

**Figure 19. Removing a PCI Express x16 Card**

## Connecting the IDE Cable

The IDE cable can connect two drives to the desktop board. The cable supports the ATA-66/100 transfer protocol. Figure 20 shows the correct installation of the cable.



### NOTES

*ATA-66/100 compatible cables are backward compatible with drives using slower IDE transfer protocols. If an ATA-66/100 disk drive and a disk drive using any other IDE transfer protocol are attached to the same cable, the maximum transfer rate between the drives may be reduced to that of the slowest drive.*

*Do not connect an ATA device as a slave on the same IDE cable as an ATAPI master device. For example, do not connect an ATA hard drive as a slave to an ATAPI CD-ROM drive.*

For correct function of the cable:

- Observe the precautions in "Before You Begin" on page 25.
- Attach the cable end with the single connector (blue) to the Intel desktop board (Figure 20, A).
- Attach the cable end with the two closely spaced connectors (gray and black) to the drives (Figure 20, B).

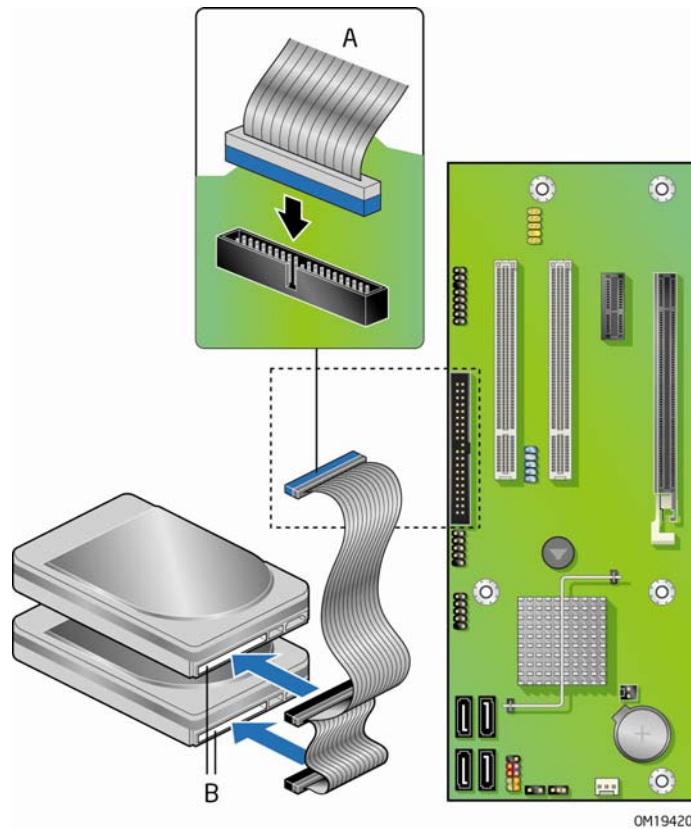

**Figure 20. Connecting the IDE Cable**



## Connecting the Serial ATA (SATA) Cable

The SATA cable supports the Serial ATA protocol and connects a single drive to the desktop board. For correct cable function:

1. Observe the precaution in "Before You Begin" on page 25.
2. Attach the locking cable end to the connector on the board (Figure 21, A).
3. Attach the cable end without the lock to the drive (Figure 21, B).

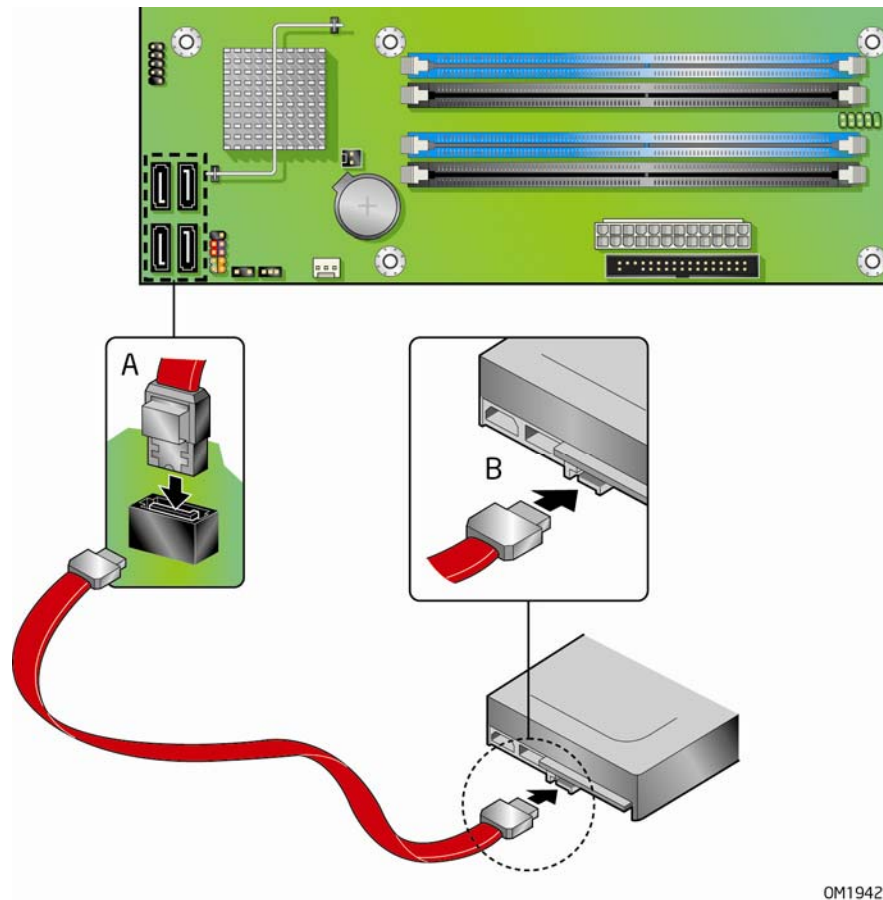
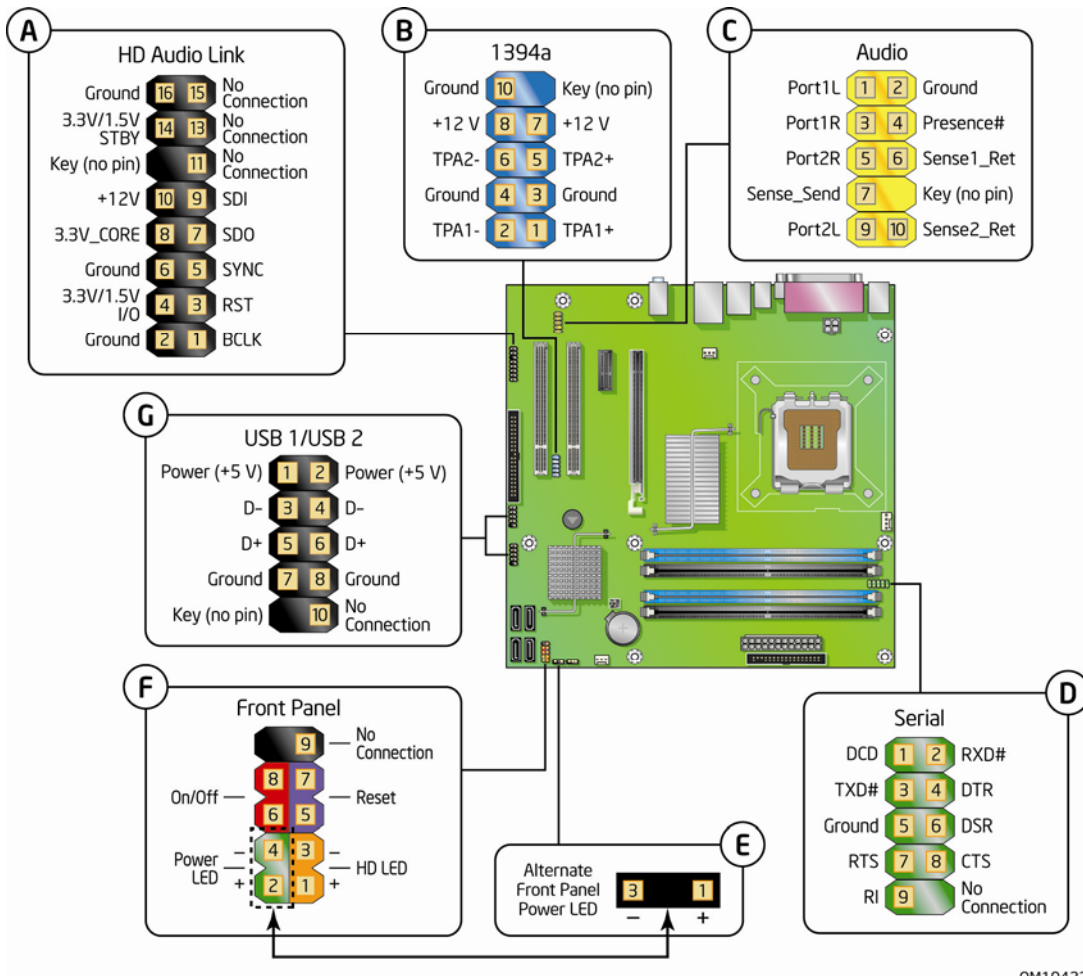

Figure 21. Connecting the Serial ATA Cable

## Connecting to Internal Headers

Before connecting cables to the internal headers, observe the precautions in "Before You Begin" on page 25. Figure 22 shows the location of the internal headers.



OM19422

Item	Description
A	HD Audio Link
B	IEEE 1394a
C	Front panel audio
D	Serial port
E	Alternate front panel power LED
F	Front panel
G	USB 2.0

**Figure 22. Internal Headers**

## Connecting to the HD Audio Link Header

See Figure 22, A for the location of the HD Audio Link header. Table 4 shows the pin assignments for the header.

**Table 4. HD Audio Link Header Signal Names**

Pin	Signal Name	Pin	Signal Name
1	BCLK	2	Ground
3	RST	4	3.3V/1.5V I/O
5	SYNC	6	Ground
7	SDO	8	3.3V_Core
9	SDI	10	+12V
11	No Connection	12	Key
13	No Connection	14	3.3V/1.5V STBY
15	No Connection	16	Ground

## Connecting to the IEEE 1394a Header

See Figure 22, B for the location of the blue IEEE 1394a header. Table 5 shows the pin assignments for the header.

**Table 5. IEEE 1394a Signal Header Names**

Pin	Signal Name	Pin	Signal Name
1	TPA1+	2	TPA1-
3	Ground	4	Ground
5	TPA2+	6	TPA2-
7	+12 V	8	+12 V
9	Key (no pin)	10	Ground

## Installing a Front Panel Audio Solution for Intel® High Definition Audio

Figure 22, C on page 42 shows the location of the yellow front panel audio header. Table 6 shows the pin assignments for the front panel audio header.

**Table 6. Front Panel Audio Header Signal Names for Intel High Definition Audio**

Pin	Signal Name	Pin	Signal Name
1	PORT 1L	2	GND
3	PORT 1R	4	PRESENCE#
5	PORT 2R	6	SENSE1_RETURN
7	SENSE_SEND	8	KEY (no pin)
9	PORT 2L	10	SENSE2_RETURN

To install the cable that connects the front panel audio solution to the front panel audio header, follow these steps:

1. Observe the precautions in "Before You Begin" on page 25.
2. Turn off all peripheral devices connected to the computer. Turn off the computer and disconnect the AC power cord.
3. Remove the cover.
4. Install a correctly keyed and shielded front panel audio cable.



**NOTE**

*Some chassis still use a front panel audio solution based on the AC '97 audio specification. Refer to Table 7 below to connect an AC '97 front panel solution to the front panel audio header on the board. The front panel audio jacks will need to be manually configured for microphone or line out functionality in the Intel® Audio Studio application.*

**Table 7. AC '97 Audio Header Signal Names**

Pin	Signal Name	Pin	Signal Name
1	MIC	2	AUD_GND
3	MIC_BIAS	4	AUD_GND
5	FP_OUT_R	6	FP_RETURN_R
7	AUD_5V	8	KEY
9	FP_OUT_L	10	FP_RETURN_L

5. Connect the audio cable to the front panel audio solution.
6. Replace the cover.

To restore back panel audio, follow these steps:

1. Observe the precautions in "Before You Begin" on page 25.
2. Turn off all peripheral devices connected to the computer. Turn off the computer and disconnect the AC power cord.
3. Remove the cover.
4. Remove the front panel audio cable.
5. Replace the cover.

## Connecting to the Serial Port Header

See Figure 22, D for the location of the green serial port header. Table 8 shows the pin assignments for the header.

**Table 8. Serial Port Header Signal Names**

Pin	Signal Name	Pin	Signal Name
1	DCD	2	RXD#
3	TXD#	4	DTR
5	Ground	6	DSR
7	RTS	8	CTS
9	RI	10	No Connection

## Connecting to the Alternate Front Panel Power LED Header

Figure 22, E on page 42 shows the location of the alternate front panel power LED header. Pins 1 and 3 of this header duplicate the signals on pins 2 and 4 of the front panel header. If your chassis has a three-pin power LED cable, connect it to this header.

Table 9 shows the pin assignments for the alternate front panel header.

**Table 9. Alternate Front Panel Power LED Header**

Pin	Description	In/Out
1	Front panel green LED	Out
2	No pin	
3	Front panel yellow LED	Out

## Connecting to the Front Panel Header

Before connecting to the front panel header, observe the precautions in "Before You Begin" on page 25. See Figure 22, F on page 42 for the location of the multi-colored front panel header.

Table 10 shows the pin assignments for the front panel header.

**Table 10. Front Panel Header**

Pin	Description	In/Out	Pin	Description	In/Out
<b>Hard Drive Activity LED</b>			<b>Power LED</b>		
1	Hard disk LED pull-up to +5 V	Out	2	Front panel green LED	Out
3	Hard disk active LED	Out	4	Front panel yellow LED	Out
<b>Reset Switch</b>			<b>On/Off Switch</b>		
5	Ground		6	Power switch	In
7	Reset switch	In	8	Ground	
<b>Power</b>			<b>Not Connected</b>		
9	Power	Out	10	No pin	

## Connecting to the USB 2.0 Headers

Before connecting to the USB 2.0 headers, observe the precautions in "Before You Begin" on page 25. See Figure 22, G on page 42 for the location of the black USB 2.0 headers. Table 11 shows the pin assignments for each USB 2.0 header.

**Table 11. USB 2.0 Header Signal Names**

<b>USB Port A</b>		<b>USB Port B</b>	
Pin	Signal Name	Pin	Signal Name
1	Power (+5 V)	2	Power (+5 V)
3	D-	4	D-
5	D+	6	D+
7	Ground	8	Ground
9	Key	10	No Connection

Note: USB ports may be assigned as needed.

## Connecting to the Flexible Audio System

After installing the SigmaTel audio driver from the Intel Express Installer driver CD-ROM, the multi-channel audio feature can be enabled. Figure 23 shows the back panel audio connectors. The default connector assignments are shown in the table. The connectors are retaskable using the audio driver interface.

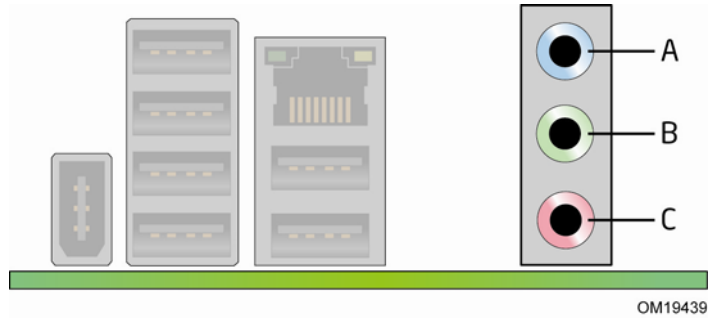

Item	Description
A	Line in/retasking jack
B	Line out/retasking jack
C	Mic in/retasking jack

**Figure 23. Back Panel Audio Connectors**

## Connecting Chassis Fan and Power Cables

### Connecting Chassis Fan Cables

Connect the chassis fan cables to the 3-pin chassis fan headers on the desktop board. Figure 24 shows the location of the chassis fan headers.

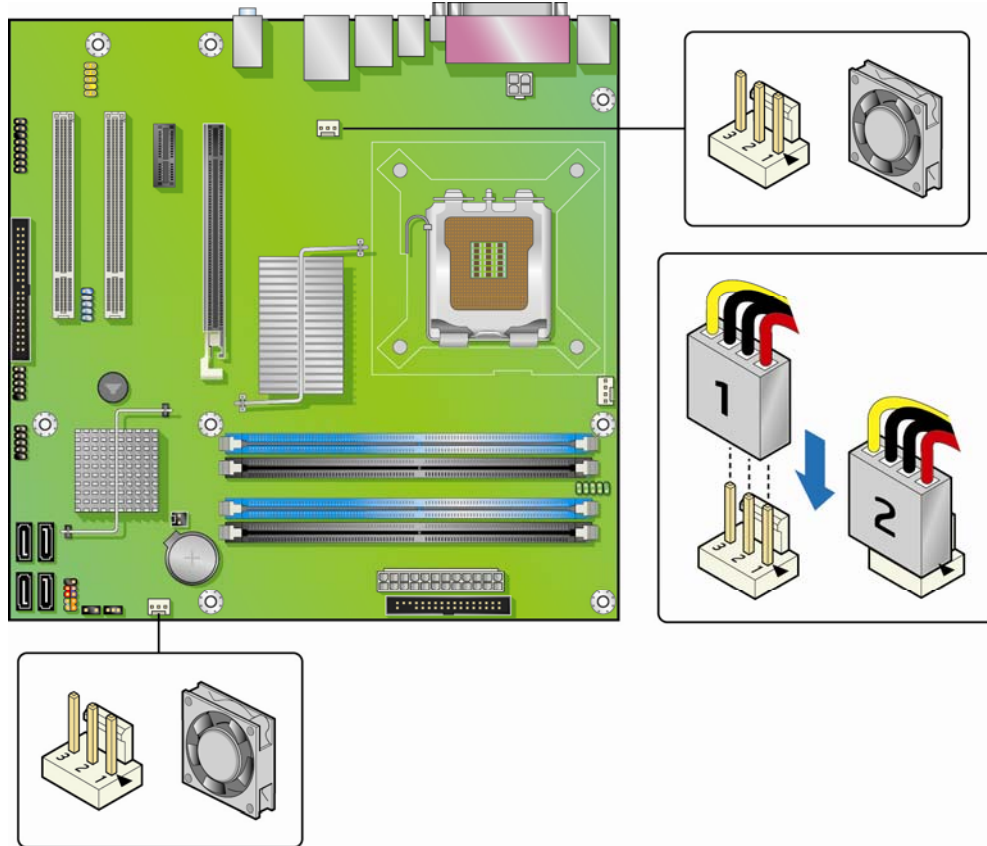

OM19423

Figure 24. Location of Chassis Fan Headers



## Connecting Power Cables



### CAUTION

Failure to use the appropriate power supply and/or not connecting the 12 V (2 x 2 pin) power connector to the desktop board may result in damage to the board or the system may not function properly.

The 2 x 12 pin main power connector on the desktop board is backwards compatible with ATX12V power supplies with 2 x 10 connectors. Figure 25 shows the location of the desktop board power connectors.

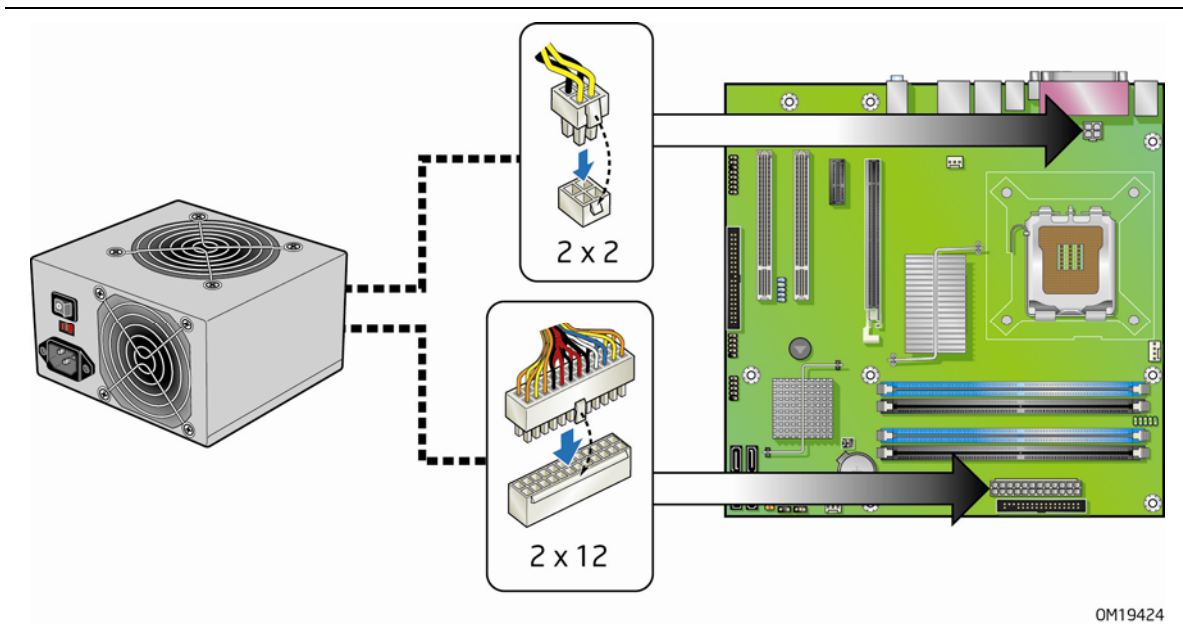

OM19424

**Figure 25. Connecting Power Supply Cables**

1. Observe the precautions in "Before You Begin" on page 25.
2. Connect the main power supply cable to the 2 x 12 pin connector.
3. Connect the 12 V processor core voltage power supply cable to the 2 x 2 pin connector.

## Other Connectors and Headers

Figure 26 shows the location of the other connectors and headers on the desktop board.

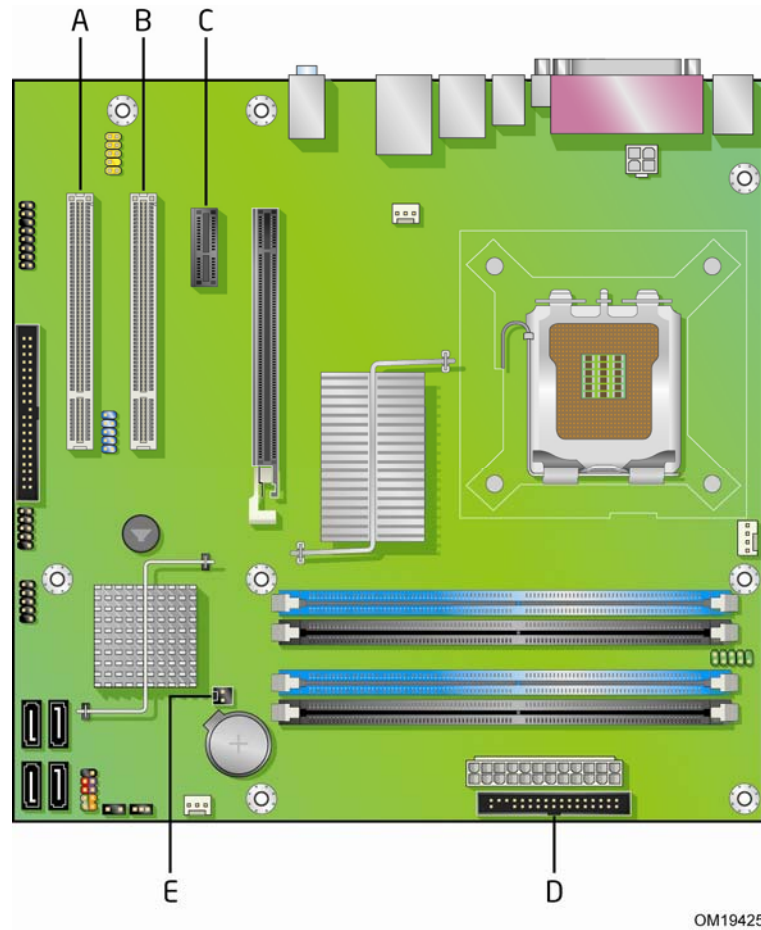

Item	Description
A	PCI bus connector 2
B	PCI bus connector 1
C	PCI Express x1 connector
D	Diskette drive connector
E	Chassis intrusion header

**Figure 26. Location of Other Connectors and Headers**

## Setting the BIOS Configuration Jumper



**NOTE**

Always turn off the power and unplug the power cord from the computer before moving the jumper. Moving the jumper with the power on may result in unreliable computer operation.

Figure 27 shows the location of the desktop board’s BIOS configuration jumper block.

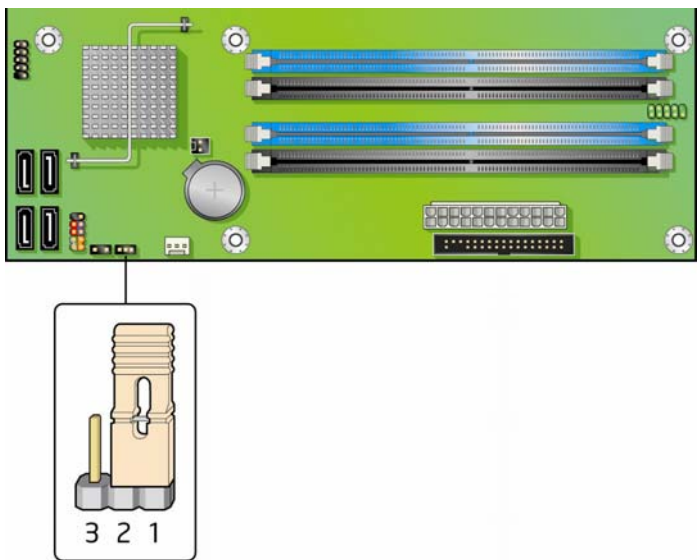

OM19426

**Figure 27. Location of the BIOS Configuration Jumper Block**

The three-pin BIOS jumper block enables all board configurations to be done in the BIOS Setup program. Table 12 shows the jumper settings for the BIOS Setup program modes.

**Table 12. Jumper Settings for the BIOS Setup Program Modes**

Jumper Setting	Mode	Description
	Normal (default) (1-2)	The BIOS uses the current configuration and passwords for booting.
	Configure (2-3)	After the Power-On Self-Test (POST) runs, the BIOS displays the Maintenance Menu. Use this menu to clear passwords.
	Recovery (None)	The BIOS recovers data in the event of a failed BIOS update.

## Clearing Passwords

This procedure assumes that the board is installed in the computer and the configuration jumper block is set to normal mode.

1. Observe the precautions in "Before You Begin" on page 25.
2. Turn off all peripheral devices connected to the computer. Turn off the computer. Disconnect the computer's power cord from the AC power source (wall outlet or power adapter).
3. Remove the computer cover.
4. Find the configuration jumper block (see Figure 27).
5. Place the jumper on pins 2-3 as shown below.

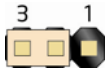

6. Replace the cover, plug in the computer, turn on the computer, and allow it to boot.
7. The computer starts the Setup program. Setup displays the Maintenance menu.
8. Use the arrow keys to select Clear Passwords. Press <Enter> and Setup displays a pop-up screen requesting that you confirm clearing the password. Select Yes and press <Enter>. Setup displays the maintenance menu again.
9. Press <F10> to save the current values and exit Setup.
10. Turn off the computer. Disconnect the computer's power cord from the AC power source.
11. Remove the computer cover.
12. To restore normal operation, place the jumper on pins 1-2 as shown below.



13. Replace the cover, plug in the computer, and turn on the computer.

## Back Panel Connectors



**NOTE**

The line out connector, located on the back panel, is designed to power either headphones or amplified speakers only. Poor audio quality may occur if passive (non-amplified) speakers are connected to this output.

Figure 28 shows the back panel connectors.

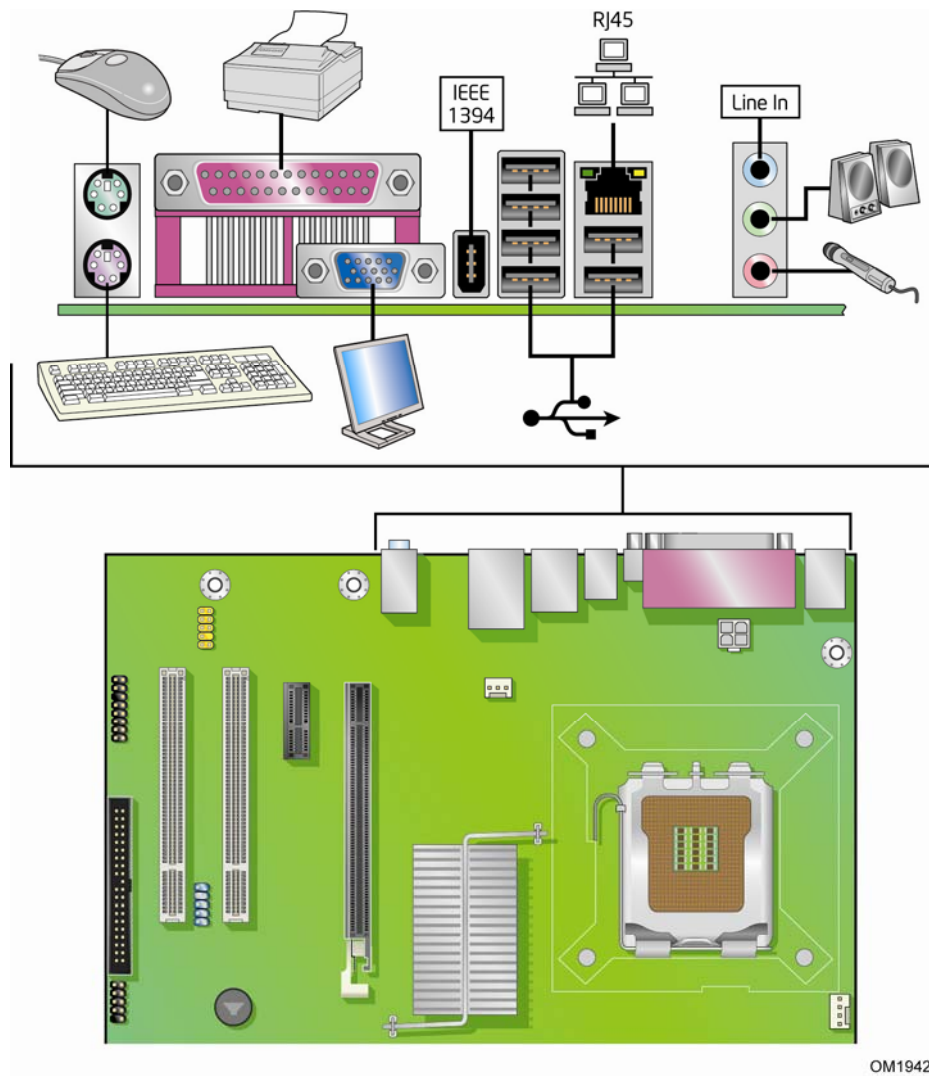

**Figure 28. Back Panel Connectors**

## Replacing the Battery

A coin-cell battery (CR2032) powers the real-time clock and CMOS memory. When the computer is not plugged into a wall socket, the battery has an estimated life of three years. When the computer is plugged in, the standby current from the power supply extends the life of the battery. The clock is accurate to  $\pm 13$  minutes/year at 25 °C with 3.3 VSB applied.

When the voltage drops below a certain level, the BIOS Setup program settings stored in CMOS RAM (for example, the date and time) might not be accurate. Replace the battery with an equivalent one. Figure 29 on page 58 shows the location of the battery.



### CAUTION

*Risk of explosion if the battery is replaced with an incorrect type. Batteries should be recycled where possible. Disposal of used batteries must be in accordance with local environmental regulations.*



### PRECAUTION

*Risque d'explosion si la pile usagée est remplacée par une pile de type incorrect. Les piles usagées doivent être recyclées dans la mesure du possible. La mise au rebut des piles usagées doit respecter les réglementations locales en vigueur en matière de protection de l'environnement.*



### FORHOLDSREGEL

*Eksplussionsfare, hvis batteriet erstattes med et batteri af en forkert type. Batterier bør om muligt genbruges. Bortskaffelse af brugte batterier bør foregå i overensstemmelse med gældende miljølovgivning.*



### OBS!

*Det kan oppstå eksplosjonsfare hvis batteriet skiftes ut med feil type. Brukte batterier bør kastes i henhold til gjeldende miljølovgivning.*



### VIKTIGT!

*Risk för explosion om batteriet ersätts med felaktig batterityp. Batterier ska kasseras enligt de lokala miljövårdsbestämmelserna.*



### VARO

*Räjähdyksvaara, jos pariston tyyppi on väärä. Paristot on kierrätettävä, jos se on mahdollista. Käytetyt paristot on hävitettävä paikallisten ympäristömääräysten mukaisesti.*



### VORSICHT

*Bei falschem Einsetzen einer neuen Batterie besteht Explosionsgefahr. Die Batterie darf nur durch denselben oder einen entsprechenden, vom Hersteller empfohlenen*

Batterietyp ersetzt werden. Entsorgen Sie verbrauchte Batterien den Anweisungen des Herstellers entsprechend.



### AVVERTIMENTO

Esiste il pericolo di un esplosione se la pila non viene sostituita in modo corretto. Utilizzare solo pile uguali o di tipo equivalente a quelle consigliate dal produttore. Per disfarsi delle pile usate, seguire le istruzioni del produttore.



### PRECAUCIÓN

Existe peligro de explosión si la pila no se cambia de forma adecuada. Utilice solamente pilas iguales o del mismo tipo que las recomendadas por el fabricante del equipo. Para deshacerse de las pilas usadas, siga igualmente las instrucciones del fabricante.



### WAARSCHUWING

Er bestaat ontploffingsgevaar als de batterij wordt vervangen door een onjuist type batterij. Batterijen moeten zoveel mogelijk worden gerecycled. Houd u bij het weggooien van gebruikte batterijen aan de plaatselijke milieuwetgeving.



### ATENÇÃO

Haverá risco de explosão se a bateria for substituída por um tipo de bateria incorreto. As baterias devem ser recicladas nos locais apropriados. A eliminação de baterias usadas deve ser feita de acordo com as regulamentações ambientais da região.



### AŠCIAROŽNAŚĆ

Існуе рызыка выбуху, калі заменены акумулятар неправільнага тыпу. Акумулятары павінны, па магчымасці, перепрацоўвацца. Пазбаўляцца ад старых акумулятараў патрэбна згодна з мясцовым заканадаўствам па экалогіі.



### UPOZORNĚNÍ

V případě výměny baterie za nesprávný druh může dojít k výbuchu. Je-li to možné, baterie by měly být recyklovány. Baterie je třeba zlikvidovat v souladu s místními předpisy o životním prostředí.



### Προσοχή

Υπάρχει κίνδυνος για έκρηξη σε περίπτωση που η μπαταρία αντικατασταθεί από μία λανθασμένου τύπου. Οι μπαταρίες θα πρέπει να ανακυκλώνονται όταν κάτι τέτοιο είναι δυνατό. Η απόρριψη των χρησιμοποιημένων μπαταριών πρέπει να γίνεται σύμφωνα με τους κατά τόπο περιβαλλοντικούς κανονισμούς.



### VIGYAZAT

Ha a telepet nem a megfelelő típusú telepre cseréli, az felrobbanhat. A telepeket lehetőség szerint újra kell hasznosítani. A használt telepeket a helyi környezetvédelmi előírásoknak megfelelően kell kiselejtezni.



**注意**

異なる種類の電池を使用すると、爆発の危険があります。リサイクルが可能な地域であれば、電池をリサイクルしてください。使用後の電池を破棄する際には、地域の環境規制に従ってください。



**AWAS**

*Risiko letupan wujud jika bateri digantikan dengan jenis yang tidak betul. Bateri sepatutnya dikitar semula jika boleh. Pelupusan bateri terpakai mestilah mematuhi peraturan alam sekitar tempatan.*



**OSTRZEŻENIE**

*Istnieje niebezpieczeństwo wybuchu w przypadku zastosowania niewłaściwego typu baterii. Zużyte baterie należy w miarę możliwości utylizować zgodnie z odpowiednimi przepisami ochrony środowiska.*



**PRECAUȚIE**

*Risc de explozie, dacă bateria este înlocuită cu un tip de baterie necorespunzător. Bateriile trebuie reciclate, dacă este posibil. Depozitarea bateriilor uzate trebuie să respecte reglementările locale privind protecția mediului.*



**ВНИМАНИЕ**

*При использовании батареи несоответствующего типа существует риск ее взрыва. Батареи должны быть утилизированы по возможности. Утилизация батарей должна проводиться по правилам, соответствующим местным требованиям.*



**UPOZORNENIE**

*Ak batériu vymeníte za nesprávny typ, hrozí nebezpečenstvo jej výbuchu. Batérie by sa mali podľa možnosti vždy recyklovať. Likvidácia použitých batérií sa musí vykonávať v súlade s miestnymi predpismi na ochranu životného prostredia.*



**POZOR**

*Zamenjava baterije z baterijo drugačnega tipa lahko povzroči eksplozijo. Če je mogoče, baterije reciklirajte. Rabljene baterije zavrzite v skladu z lokalnimi okoljevarstvenimi predpisi.*



**คำเตือน**

*ระวังการระเบิดที่เกิดจากเปลี่ยนแบตเตอรี่ผิดประเภท หากเป็นไปได้ ควรนำแบตเตอรี่ไปรีไซเคิล การทิ้งแบตเตอรี่ใช้แล้วต้องเป็นไปตามกฎข้อบังคับด้านสิ่งแวดล้อมของท้องถิ่น.*



**UYARI**

*Yanlış türde pil takıldığında patlama riski vardır. Piller mümkün olduğunda geri dönüştürülmelidir. Kullanılmış piller, yerel çevre yasalarına uygun olarak atılmalıdır.*





### ОСТОРОГА

Використовуйте батареї правильного типу, інакше існуватиме ризик вибуху. Якщо можливо, використані батареї слід утилізувати. Утилізація використаних батарей має бути виконана згідно місцевих норм, що регулюють охорону довкілля.



### UPOZORNĚNÍ

V případě výměny baterie za nesprávný druh může dojít k výbuchu. Je-li to možné, baterie by měly být recyklovány. Baterie je třeba zlikvidovat v souladu s místními předpisy o životním prostředí.



### ETTEVAATUST

Kui patarei asendatakse uue ebasobivat tüüpi patareiga, võib tekkida plahvatusoht. Tühjad patareid tuleb võimaluse korral viia vastavasse kogumispunkti. Tühjade patareide äraviskamisel tuleb järgida kohalikke keskkonnakaitse alaseid reegleid.



### FIGYELMEZTETÉS

Ha az elemet nem a megfelelő típusúra cseréli, felrobbanhat. Az elemeket lehetőség szerint újra kell hasznosítani. A használt elemeket a helyi környezetvédelmi előírásoknak megfelelően kell kiselejtezni.



### UZMANĪBU

Pastāv eksplozijas risks, ja baterijas tiek nomainītas ar nepareiza veida baterijām. Ja iespējams, baterijas vajadzētu nodot attiecīgos pieņemšanas punktus. Bateriju izmešanai atkritumos jānotiek saskaņā ar vietējiem vides aizsardzības noteikumiem.



### DĒMESIO

Naudojant netinkamo tipo baterijas įrenginys gali sprogti. Kai tik įmanoma, baterijas reikia naudoti pakartotinai. Panaudotas baterijas išmesti būtina pagal vietinius aplinkos apsaugos nuostatus.



### ATTENZJONI

Riskju ta' splużjoni jekk il-batterija tinbidel b'tip ta' batterija mhux korrett. Il-batteriji għandhom jiġu riċiklati fejn hu possibbli. Ir-rimi ta' batteriji użati għandu jsir skond ir-regolamenti ambjentali lokali.



### OSTRZEŻENIE

Ryzyko wybuchu w przypadku wymiany na baterie niewłaściwego typu. W miarę możliwości baterie należy poddać recyklingowi. Zużytych baterii należy pozbywać się zgodnie z lokalnie obowiązującymi przepisami w zakresie ochrony środowiska.

To replace the battery, follow these steps:

1. Observe the precautions in "Before You Begin" (see page 25).
2. Turn off all peripheral devices connected to the computer. Disconnect the computer's power cord from the AC power source (wall outlet or power adapter).
3. Remove the computer cover.

4. Locate the battery on the board (see Figure 29).
5. With a medium flat-bladed screwdriver, gently pry the battery free from its connector. Note the orientation of the "+" and "-" on the battery.
6. Install the new battery in the connector, orienting the "+" and "-" correctly.
7. Replace the computer cover.

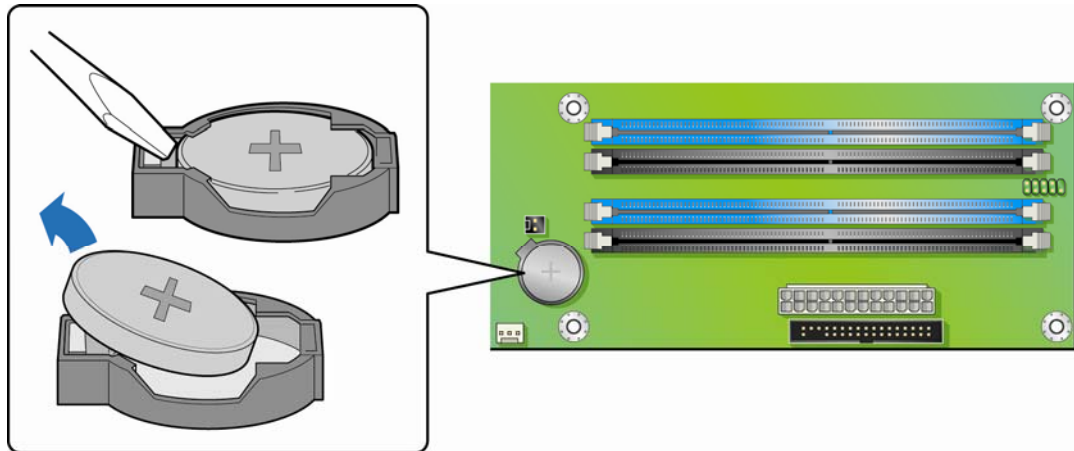

OM19428

**Figure 29. Removing the Battery**

## 3 Updating the BIOS

---

The BIOS Setup program can be used to view and change the BIOS settings for the computer. You can access the BIOS Setup program by pressing the <F2> key after the Power-On Self-Test (POST) memory test begins and before the operating system boot begins.

This chapter tells you how to update the BIOS by either using the Intel Express BIOS Update utility or the Iflash Memory Update utility, and how to recover the BIOS if an update fails.

### Updating the BIOS with the Intel<sup>®</sup> Express BIOS Update Utility

With the Intel Express BIOS Update utility you can update the system BIOS while in the Windows environment. The BIOS file is included in an automated update utility that combines the functionality of the Intel<sup>®</sup> Flash Memory Update Utility and the ease of use of Windows-based installation wizards.

To update the BIOS with the Intel Express BIOS Update utility:

1. Go to the Intel World Wide Web site:  
<http://support.intel.com/support/motherboards/desktop/>
2. Navigate to the DG965SS page, click "[view] Latest BIOS updates," and select the Express BIOS Update utility file.
3. Download the file to your hard drive. (You can also save this file to a removable USB device. This is useful if you are updating the BIOS for multiple identical systems.)
4. Close all other applications. This step is required. Your system will be rebooted at the last Express BIOS Update window.
5. Double-click the executable file from the location on your hard drive where it was saved. This runs the update program.
6. Follow the instructions provided in the dialog boxes to complete the BIOS update.

## Updating the BIOS with the ISO Image BIOS Update File or the Iflash Memory Update Utility

You can use the information in this section to update the BIOS using either the Iflash Memory Update Utility or the ISO Image BIOS update file.

### Obtaining the BIOS Update File

You can update to a new version of the BIOS by using the ISO Image BIOS update file (recommended), or Iflash BIOS update file.

The ISO Image BIOS update file is a standardized image of a bootable CD-ROM that can be used to create a bootable CD that will update the BIOS.

The IFlash BIOS update file is a compressed file that contains the files you need to update the BIOS. The IFlash BIOS update file contains:

- New BIOS file (including the Intel® Management Engine Firmware Image)
- Intel® Integrator Toolkit Configuration File (optional)
- Intel Flash Memory Update Utility

You can obtain either of these files through your computer supplier or by navigating to the Desktop Board DG965SS page on the Intel World Wide Web site at:

<http://support.intel.com/support/motherboards/desktop>

Navigate to the DG965SS page, click "[view] Latest BIOS updates," and select the ISO Image BIOS Update or Iflash BIOS Update utility file.

### Updating the BIOS with the ISO Image BIOS Update File

The ISO Image BIOS update allows for the update of an Intel® Desktop Board BIOS to the latest production release regardless of the operating system installed on the computer's hard drive and without the need to remove the BIOS configuration jumper. It requires a blank CD-R, a read/writeable CD drive, and software capable of uncompressing and writing the ISO image file to CD.

The image uses ISOLINUX\* bootloader and automatically launches a script to upgrade the BIOS via the Iflash utility.



#### **CAUTION**

*Do not interrupt the process or the system may not function properly.*

Follow these instructions to upgrade the BIOS using the ISO Image BIOS file:

1. Download the ISO Image BIOS file.
2. Using software capable of uncompressing and writing an ISO image file to CD, burn the data to a blank CD.



### NOTE

*Copying the ISO Image BIOS file to CD will not work. The completed CD should contain multiple files and a directory.*

3. Insert the CD that was created in the CD-ROM drive of the computer to be upgraded and boot the system.
4. When the "Press ENTER to continue booting from CD-ROM" prompt appears, press the Enter key. The system will boot from the hard drive if no key is pressed within 15 seconds.
5. At the "Welcome to the Intel Desktop Board BIOS Upgrade CD-ROM" page, press any key to confirm the BIOS upgrade operation.
6. Wait for the BIOS upgrade process to complete.



### CAUTION

*DO NOT POWER DOWN YOUR COMPUTER before the update is complete. The update may take up to 5 minutes.*

## Updating the BIOS with Iflash

With the Iflash Memory update utility you can update the system BIOS from a bootable CD-ROM, bootable USB flash drive, or other bootable USB media. The utility available on the Intel World Wide Web site provides a simple method for creating a bootable CD-ROM that will automatically update your BIOS. The Iflash BIOS update files can also be extracted locally to your hard drive and copied to a bootable USB flash drive or other bootable USB media.

The Iflash Memory update utility allows you to:

- Update the BIOS and Intel Management Engine in flash memory
- Update the language section of the BIOS



### NOTE

*Review the instructions distributed with the update utility before attempting a BIOS update.*



**CAUTION**

*Do not interrupt the process or the system may not function properly.*

1. Uncompress the BIOS update file and copy the .BIO file, IFLASH.EXE, and .ITK file (optional) to a bootable USB flash drive or other bootable USB media.
2. Configure the BIOS or use the F10 option during POST to boot to the USB device.
3. Manually run the IFLASH.EXE file from the USB device and manually update the BIOS.

## Recovering the BIOS

It is unlikely that anything will interrupt the BIOS update; however, if an interruption occurs, the BIOS could be damaged. Due to BIOS size and recovery requirements, a CD-R with the .BIO file in the root directory will be required. For more information about recovering the BIOS for desktop board DG965SS, go to:

<http://support.intel.com/support/motherboards/desktop/>

# A Error Messages and Indicators

---

Desktop Board DG965SS reports POST errors in two ways:

- By sounding a beep code
- By displaying an error message on the monitor

## BIOS Beep Codes

The BIOS also issues a beep code (one long tone followed by two short tones) during POST if the video configuration fails (a faulty video card or no card installed) or if an external ROM module does not properly checksum to zero. Table 13 lists the BIOS codes.

**Table 13. Beep Codes**

Beep	Description
3	No memory
Siren	Processor overheat (on reboot)

## BIOS Error Messages

When a recoverable error occurs during the POST, the BIOS displays an error message describing the problem. Table 14 gives an explanation of the BIOS error messages.

**Table 14. BIOS Error Messages**

Error Message	Explanation
PROCESSOR_THERMAL_TRIP_ERROR	Processor was previously shutdown due to a thermal event (overheating).
MULTI_BIT_ECC_ERROR	The firmware has detected that a Multi-Bit ECC Error occurred.
SINGLE_BIT_ECC_ERROR	The firmware has detected that a Single-Bit ECC Error occurred.
CMOS_BATTERY_ERROR	The firmware has detected that a CMOS battery failure occurred.
CMOS_CHECKSUM_ERROR	The firmware has detected that a CMOS Checksum Error occurred.
CMOS_TIMER_ERROR	The firmware has detected that the system date/time has not been set.
MEMORY_SIZE_DECREASE_ERROR	The firmware has detected that the system memory has decreased.
INTRUDER_DETECTION_ERROR	The system chassis was opened.
SPD_TOLER_ERROR	SERIAL PRESENCE DETECT (SPD) device data missing or inconclusive. Properly programmed SPD device data is required for reliable operation. DDR2 533 MHz memory assumed at slowest timings.
MEM_OPTIMAL_ERROR	The installed amount of memory in Channel A is not equal to the amount of memory in Channel B. Maximum memory performance is achieved with equal amounts of memory installed in each channel.





# B Regulatory Compliance

---

This appendix contains the following regulatory compliance information for Desktop Board DG965SS:

- Safety regulations
- European Union Declaration of Conformity statement
- Product Ecology statements
- Electromagnetic Compatibility (EMC) regulations
- Product certifications

## Safety Regulations

Desktop Board DG965SS complies with the safety regulations stated in Table 15 when correctly installed in a compatible host system.

**Table 15. Safety Regulations**

Regulation	Title
UL 60950-1:2003/ CSA C22.2 No. 60950-1-03	Information Technology Equipment – Safety - Part 1: General Requirements (USA and Canada)
EN 60950-1:2002	Information Technology Equipment – Safety - Part 1: General Requirements (European Union)
IEC 60950-1:2001, First Edition	Information Technology Equipment – Safety - Part 1: General Requirements (International)

## Place Battery Marking

There is insufficient space on this desktop board to provide instructions for replacing and disposing of the Lithium ion coin cell battery. For system safety certification, the statement below or an equivalent statement is required to be permanently and legibly marked on the chassis near the battery.



### **CAUTION**

*Risk of explosion if the battery is replaced with an incorrect type. Batteries should be recycled where possible. Disposal of used batteries must be in accordance with local environmental regulations.*

### **Related Links**

For information about replacing the battery, go to page 54.

## European Union Declaration of Conformity Statement

We, Intel Corporation, declare under our sole responsibility that the product Intel® Desktop Board DG965SS is in conformity with all applicable essential requirements necessary for CE marking, following the provisions of the European Council Directive 89/336/EEC (EMC Directive) and Council Directive 73/23/EEC (Safety/Low Voltage Directive).

The product is properly CE marked demonstrating this conformity and is for distribution within all member states of the EU with no restrictions.



This product follows the provisions of the European Directives 89/336/EEC and 73/23/EEC.

**Čeština** Tento výrobek odpovídá požadavkům evropských směrnic 89/336/EEC a 73/23/EEC.

**Dansk** Dette produkt er i overensstemmelse med det europæiske direktiv 89/336/EEC & 73/23/EEC.

**Dutch** Dit product is in navolging van de bepalingen van Europees Directief 89/336/EEC & 73/23/EEC.

**Eesti** Antud toode vastab Euroopa direktiivides 89/336/EEC ja 73/23/EEC kehtestatud nõuetele.

**Suomi** Tämä tuote noudattaa EU-direktiivin 89/336/EEC & 73/23/EEC määräyksiä.

**Français** Ce produit est conforme aux exigences de la Directive Européenne 89/336/EEC & 73/23/EEC.

**Deutsch** Dieses Produkt entspricht den Bestimmungen der Europäischen Richtlinie 89/336/EEC & 73/23/EEC.

**Ελληνικά** Το παρόν προϊόν ακολουθεί τις διατάξεις των Ευρωπαϊκών Οδηγιών 89/336/ΕΟΚ και 73/23/ΕΟΚ.

**Magyar** E termék megfelel a 89/336/EEC és 73/23/EEC Európai Irányelv előírásainak.

**Icelandic** Þessi vara stenst reglugerð Evrópska Efnahags Bandalagsins númer 89/336/ EEC & 73/23/EEC.

**Italiano** Questo prodotto è conforme alla Direttiva Europea 89/336/EEC & 73/23/EEC.

**Latviešu** Šis produkts atbilst Eiropas Direktīvu 89/336/EEC un 73/23/EEC noteikumiem.

**Lietuvių** Šis produktas atitinka Europos direktyvų 89/336/EEC ir 73/23/EEC nuostatas.

**Malti** Dan il-prodott hu konformi mal-provvedimenti tad-Direttivi Ewropej 89/336/EEC u 73/23/EEC.

**Norsk** Dette produktet er i henhold til bestemmelsene i det europeiske direktivet 89/336/ EEC & 73/23/EEC.

**Polski** Niniejszy produkt jest zgodny z postanowieniami Dyrektyw Unii Europejskiej 89/336/EWG i 73/23/EWG.

**Portuguese** Este produto cumpre com as normas da Diretiva Européia 89/336/EEC & 73/23/EEC.

**Español** Este producto cumple con las normas del Directivo Europeo 89/336/EEC & 73/23/EEC.

**Slovensky** Tento produkt je v súlade s ustanoveniami európskych direktív 89/336/EEC a 73/23/EEC.

**Slovenščina** Izdelek je skladen z določbami evropskih direktiv 89/336/EGS in 73/23/EGS.

**Svenska** Denna produkt har tillverkats i enlighet med EG-direktiv 89/336/EEC & 73/23/EEC.

**Türkçe** Bu ürün, Avrupa Birliği'nin 89/336/EEC ve 73/23/EEC yönergelerine uyar.

## Product Ecology Statements

The following information is provided to address worldwide product ecology concerns and regulations.

## Recycling Considerations

As part of its commitment to environmental responsibility, Intel has implemented the Intel® Product Recycling Program to allow retail consumers of Intel's branded products to return used products to select locations for proper recycling.

Please consult the

[http://www.intel.com/intel/other/ehs/product\\_ecology/Recycling\\_Program.htm](http://www.intel.com/intel/other/ehs/product_ecology/Recycling_Program.htm)

for the details of this program, including the scope of covered products, available locations, shipping instructions, terms and conditions, etc.

### 中文

作为其对环境责任之承诺的部分，英特尔已实施 Intel Product Recycling Program（英特尔产品回收计划），以允许英特尔品牌产品的零售消费者将使用过的产品退还至指定地点作恰当的重复使用处理。

请参考[http://www.intel.com/intel/other/ehs/product\\_ecology/Recycling\\_Program.htm](http://www.intel.com/intel/other/ehs/product_ecology/Recycling_Program.htm)了解此计划的详情，包括涉及产品之范围、回收地点、运送指导、条款和条件等。

## **Deutsch**

Als Teil von Intels Engagement für den Umweltschutz hat das Unternehmen das Intel Produkt-Recyclingprogramm implementiert, das Einzelhandelskunden von Intel Markenprodukten ermöglicht, gebrauchte Produkte an ausgewählte Standorte für ordnungsgemäßes Recycling zurückzugeben.

Details zu diesem Programm, einschließlich der darin eingeschlossenen Produkte, verfügbaren Standorte, Versandanweisungen, Bedingungen usw., finden Sie auf der [http://www.intel.com/intel/other/ehs/product\\_ecology/Recycling\\_Program.htm](http://www.intel.com/intel/other/ehs/product_ecology/Recycling_Program.htm)

## **Español**

Como parte de su compromiso de responsabilidad medioambiental, Intel ha implantado el programa de reciclaje de productos Intel, que permite que los consumidores al detalle de los productos Intel devuelvan los productos usados en los lugares seleccionados para su correspondiente reciclado.

Consulte la

[http://www.intel.com/intel/other/ehs/product\\_ecology/Recycling\\_Program.htm](http://www.intel.com/intel/other/ehs/product_ecology/Recycling_Program.htm)

para ver los detalles del programa, que incluye los productos que abarca, los lugares disponibles, instrucciones de envío, términos y condiciones, etc.

## **Français**

Dans le cadre de son engagement pour la protection de l'environnement, Intel a mis en œuvre le programme Intel Product Recycling Program (Programme de recyclage des produits Intel) pour permettre aux consommateurs de produits Intel de recycler les produits usés en les retournant à des adresses spécifiées.

Visitez la page Web

[http://www.intel.com/intel/other/ehs/product\\_ecology/Recycling\\_Program.htm](http://www.intel.com/intel/other/ehs/product_ecology/Recycling_Program.htm) pour en savoir plus sur ce programme, à savoir les produits concernés, les adresses disponibles, les instructions d'expédition, les conditions générales, etc.

## **日本語**

インテルでは、環境保護活動の一環として、使い終わったインテルブランド製品を指定の場所へ返送していただき、リサイクルを適切に行えるよう、インテル製品リサイクルプログラムを発足させました。

対象製品、返送先、返送方法、ご利用規約など、このプログラムの詳細情報は、[http://www.intel.com/intel/other/ehs/product\\_ecology/Recycling\\_Program.htm](http://www.intel.com/intel/other/ehs/product_ecology/Recycling_Program.htm) (英語)をご覧ください。

## Malay

Sebagai sebahagian daripada komitmennya terhadap tanggungjawab persekitaran, Intel telah melaksanakan Program Kitar Semula Produk untuk membenarkan pengguna-pengguna runcit produk jenama Intel memulangkan produk terguna ke lokasi-lokasi terpilih untuk dikitar semula dengan betul.

Sila rujuk

[http://www.intel.com/intel/other/ehs/product\\_ecology/Recycling\\_Program.htm](http://www.intel.com/intel/other/ehs/product_ecology/Recycling_Program.htm) untuk mendapatkan butir-butir program ini, termasuklah skop produk yang dirangkumi, lokasi-lokasi tersedia, arahan penghantaran, terma & syarat, dsb.

## Portuguese

Como parte deste compromisso com o respeito ao ambiente, a Intel implementou o Programa de Reciclagem de Produtos para que os consumidores finais possam enviar produtos Intel usados para locais selecionados, onde esses produtos são reciclados de maneira adequada.

Consulte o site

[http://www.intel.com/intel/other/ehs/product\\_ecology/Recycling\\_Program.htm](http://www.intel.com/intel/other/ehs/product_ecology/Recycling_Program.htm) (em Inglês) para obter os detalhes sobre este programa, inclusive o escopo dos produtos cobertos, os locais disponíveis, as instruções de envio, os termos e condições, etc.

## Russian

В качестве части своих обязательств к окружающей среде, в Intel создана программа утилизации продукции Intel (Product Recycling Program) для предоставления конечным пользователям марок продукции Intel возможности возврата используемой продукции в специализированные пункты для должной утилизации.

Пожалуйста, обратитесь на веб-сайт

[http://www.intel.com/intel/other/ehs/product\\_ecology/Recycling\\_Program.htm](http://www.intel.com/intel/other/ehs/product_ecology/Recycling_Program.htm) за информацией об этой программе, принимаемых продуктах, местах приема, инструкциях об отправке, положениях и условиях и т.д.

## Türkçe

Intel, çevre sorumluluğuna bağlılığının bir parçası olarak, perakende tüketicilerin Intel markalı kullanılmış ürünlerini belirlenmiş merkezlere iade edip uygun şekilde geri dönüştürmesini amaçlayan Intel Ürünleri Geri Dönüşüm Programı'nı uygulamaya koymuştur.



Bu programın ürün kapsamı, ürün iade merkezleri, nakliye talimatları, kayıtlar ve şartlar v.s dahil bütün ayrıntılarını öğrenmek için lütfen

[http://www.intel.com/intel/other/ehs/product\\_ecology/Recycling\\_Program.htm](http://www.intel.com/intel/other/ehs/product_ecology/Recycling_Program.htm) web sayfasına gidin.

## Lead-Free Desktop Board

This desktop board is lead-free although certain discrete components used on the board contain a small amount of lead which is necessary for component performance and/or reliability. This desktop board is referred to as "Lead-free second level interconnect." The board substrate and the solder connections from the board to the components (second-level connections) are all lead-free. Table 16 shows the various forms of the "Lead-Free 2<sup>nd</sup> Level Interconnect" mark as it appears on the board and accompanying collateral.

**Table 16. Lead-Free Board Markings**

Description	Mark
<p><b>Lead-Free 2<sup>nd</sup> Level Interconnect:</b> This symbol is used to identify electrical and electronic assemblies and components in which the lead (Pb) concentration level in the desktop board substrate and the solder connections from the board to the components (second-level interconnect) is not greater than 0.1% by weight (1000 ppm).</p>	<div style="border: 1px solid black; padding: 5px; margin-bottom: 10px;">  </div> <p style="text-align: center;">or</p> <div style="border: 1px solid black; padding: 5px; margin-bottom: 10px; width: fit-content; margin: auto;">  </div> <p style="text-align: center;">or</p> <div style="border: 1px solid black; padding: 5px; margin-bottom: 10px; width: fit-content; margin: auto;">  </div>

## EMC Regulations

Desktop Board DG965SS complies with the EMC regulations stated in Table 17 when correctly installed in a compatible host system.

**Table 17. EMC Regulations**

Regulation	Title
FCC Class B	Title 47 of the Code of Federal Regulations, Parts 2 and 15, Subpart B, Radio Frequency Devices. (USA)
ICES-003 (Class B)	Interference-Causing Equipment Standard, Digital Apparatus. (Canada)
EN55022: 1998 (Class B)	Limits and methods of measurement of Radio Interference Characteristics of Information Technology Equipment. (European Union)
EN55024: 1998	Information Technology Equipment – Immunity Characteristics Limits and methods of measurement. (European Union)
AS/NZS CISPR22 (Class B)	Australian Communications Authority, Standard for Electromagnetic Compatibility. (Australia and New Zealand)
CISPR 22, 3 <sup>rd</sup> Edition, (Class B)	Limits and methods of measurement of Radio Disturbance Characteristics of Information Technology Equipment. (International)
CISPR 24: 1997	Information Technology Equipment – Immunity Characteristics – Limits and Methods of Measurement. (International)
VCCI (Class B)	Voluntary Control for Interference by Information Technology Equipment (Japan)

Japanese Kanji statement translation: This is a Class B product based on the standard of the Voluntary Control Council for Interference from Information Technology Equipment (VCCI). If this is used near a radio or television receiver in a domestic environment, it may cause radio interference. Install and use the equipment according to the instruction manual.

この装置は、情報処理装置等電波障害自主規制協議会（VCCI）の基準に基づくクラスB 情報技術装置です。この装置は、家庭環境で使用することを目的としていますが、この装置がラジオやテレビジョン受信機に近接して使用されると、受信障害を引き起こすことがあります。  
取扱説明書に従って正しい取り扱いをして下さい。

Korean Class B statement translation: This is household equipment that is certified to comply with EMC requirements. You may use this equipment in residential environments and other non-residential environments.

이 기기는 가정용으로 전자파적합등록을 한 기기로서  
주거지역에서는 물론 모든 지역에서 사용할 수 있습니다.

## **Ensure Electromagnetic Compatibility (EMC) Compliance**

Before computer integration, make sure that the power supply and other modules or peripherals, as applicable, have passed Class B EMC testing and are marked accordingly.

Pay close attention to the following when reading the installation instructions for the host chassis, power supply, and other modules:

- Product certifications or lack of certifications
- External I/O cable shielding and filtering
- Mounting, grounding, and bonding requirements
- Keying connectors when mating the wrong connectors could be hazardous

If the power supply and other modules or peripherals, as applicable, are not Class B EMC compliant before integration, then EMC testing may be required on a representative sample of the newly completed computer.











# Product Certifications

## Board-Level Certification Markings

Desktop Board DG965SS has the following product certification markings:

**Table 18. Product Certification Markings**

Description	Mark
UL joint US/Canada Recognized Component mark. Includes adjacent UL file number for Intel desktop boards: E210882.	
FCC Declaration of Conformity logo mark for Class B equipment. Includes Intel name and DG965SS model designation.	
CE mark. Declaring compliance to European Union (EU) EMC directive (89/336/EEC) and Low Voltage directive (73/23/EEC).	
Australian Communications Authority (ACA) C-tick mark. Includes adjacent Intel supplier code number, N-232.	
Japan VCCI (Voluntary Control Council for Interference) mark.	
S. Korea MIC (Ministry of Information and Communication) mark. Includes adjacent MIC certification number: CPU-DG965SS. For information about MIC certification, go to <a href="http://support.intel.com/support/motherboards/desktop/">http://support.intel.com/support/motherboards/desktop/</a>	
Taiwan BSMI (Bureau of Standards, Metrology and Inspections) mark. Includes adjacent Intel company number, D33025.	
Printed wiring board manufacturer's recognition mark. Consists of a unique UL recognized manufacturer's logo, along with a flammability rating (solder side).	

## Chassis and Component Certifications

Ensure that the chassis and certain components; such as the power supply, peripheral drives, wiring, and cables; are components certified for the country or market where used. Agency certification marks on the product are proof of certification. Typical product certifications include:

### **In Europe**

The CE marking signifies compliance with all applicable European requirements. If the chassis and other components are not properly CE marked, a supplier's Declaration of Conformity statement to the European EMC directive and Low Voltage directive (as applicable), should be obtained. Additionally, other directives, such as the Radio and Telecommunications Terminal Equipment (R&TTE) directive may also apply depending on product features.

### **In the United States**

A certification mark by a Nationally Recognized Testing Laboratory (NRTL) such as UL, CSA, or ETL signifies compliance with safety requirements. Wiring and cables must also be UL listed or recognized and suitable for the intended use. The FCC Class B logo for home or office use signifies compliance with electromagnetic interference (EMI) requirements.

### **In Canada**

A nationally recognized certification mark such as CSA or cUL signifies compliance with safety requirements. The Industry Canada statement at the front of this product guide demonstrates compliance with Canadian EMC regulations.