

# **XP-243 245 247 Series User's Guide**

## Copyright

# Copyright

No part of this publication may be reproduced, stored in a retrieval system, or transmitted in any form or by any means, electronic, mechanical, photocopying, recording, or otherwise, without the prior written permission of Seiko Epson Corporation. No patent liability is assumed with respect to the use of the information contained herein. Neither is any liability assumed for damages resulting from the use of the information herein. The information contained herein is designed only for use with this Epson product. Epson is not responsible for any use of this information as applied to other products.

Neither Seiko Epson Corporation nor its affiliates shall be liable to the purchaser of this product or third parties for damages, losses, costs, or expenses incurred by the purchaser or third parties as a result of accident, misuse, or abuse of this product or unauthorized modifications, repairs, or alterations to this product, or (excluding the U.S.) failure to strictly comply with Seiko Epson Corporation's operating and maintenance instructions.

Seiko Epson Corporation and its affiliates shall not be liable for any damages or problems arising from the use of any options or any consumable products other than those designated as Original Epson Products or Epson Approved Products by Seiko Epson Corporation.

Seiko Epson Corporation shall not be held liable for any damage resulting from electromagnetic interference that occurs from the use of any interface cables other than those designated as Epson Approved Products by Seiko Epson Corporation.

© 2016 Seiko Epson Corporation. All rights reserved.

The contents of this manual and the specifications of this product are subject to change without notice.

# Trademarks

- ❑ EPSON® is a registered trademark, and EPSON EXCEED YOUR VISION or EXCEED YOUR VISION is a trademark of Seiko Epson Corporation.
- ❑ PRINT Image Matching™ and the PRINT Image Matching logo are trademarks of Seiko Epson Corporation. Copyright © 2001 Seiko Epson Corporation. All rights reserved.
- ❑ Epson Scan 2 software is based in part on the work of the Independent JPEG Group.
- ❑ libtiff

Copyright © 1988-1997 Sam Leffler

Copyright © 1991-1997 Silicon Graphics, Inc.

Permission to use, copy, modify, distribute, and sell this software and its documentation for any purpose is hereby granted without fee, provided that (i) the above copyright notices and this permission notice appear in all copies of the software and related documentation, and (ii) the names of Sam Leffler and Silicon Graphics may not be used in any advertising or publicity relating to the software without the specific, prior written permission of Sam Leffler and Silicon Graphics.

THE SOFTWARE IS PROVIDED "AS-IS" AND WITHOUT WARRANTY OF ANY KIND, EXPRESS, IMPLIED OR OTHERWISE, INCLUDING WITHOUT LIMITATION, ANY WARRANTY OF MERCHANTABILITY OR FITNESS FOR A PARTICULAR PURPOSE.

IN NO EVENT SHALL SAM LEFFLER OR SILICON GRAPHICS BE LIABLE FOR ANY SPECIAL, INCIDENTAL, INDIRECT OR CONSEQUENTIAL DAMAGES OF ANY KIND, OR ANY DAMAGES WHATSOEVER RESULTING FROM LOSS OF USE, DATA OR PROFITS, WHETHER OR NOT ADVISED OF THE POSSIBILITY OF DAMAGE, AND ON ANY THEORY OF LIABILITY, ARISING OUT OF OR IN CONNECTION WITH THE USE OR PERFORMANCE OF THIS SOFTWARE.

- ❑ Microsoft®, Windows®, and Windows Vista® are registered trademarks of Microsoft Corporation.
- ❑ Apple, Macintosh, Mac OS, OS X, Bonjour, Safari, iPad, iPhone, iPod touch, and iTunes are trademarks of Apple Inc., registered in the U.S. and other countries.
- ❑ Chrome™, Chrome OS™, and Android™ are trademarks of Google Inc.
- ❑ Adobe and Adobe Reader are either registered trademarks or trademarks of Adobe Systems Incorporated in the United States and/or other countries.
- ❑ Intel® is a registered trademark of Intel Corporation.
- ❑ General Notice: Other product names used herein are for identification purposes only and may be trademarks of their respective owners. Epson disclaims any and all rights in those marks.

## Contents

### Copyright

### Trademarks

### About This Manual

Introduction of Manuals. . . . .	7
Marks and Symbols. . . . .	7
Descriptions Used in this Manual. . . . .	8
Operating System References. . . . .	8

### Important Instructions

Safety Instructions. . . . .	9
Printer Advisories and Warnings. . . . .	9
Advisories and Warnings for Setting Up/ Using the Printer. . . . .	10
Advisories and Warnings for Using the Printer with a Wireless Connection. . . . .	11

### Printer Basics

Part Names and Functions. . . . .	12
Control Panel. . . . .	14

### Network Settings

Wi-Fi Connection. . . . .	16
Connecting to a Computer. . . . .	16
Connecting to a Smart Device. . . . .	18
Making Wi-Fi Settings from the Control Panel. . . . .	18
Making Wi-Fi Settings by Push Button Setup. . . . .	18
Making Wi-Fi Settings by PIN Code Setup (WPS). . . . .	19
Checking the Network Connection Status. . . . .	20
Checking the Network Status Using Network Light. . . . .	20
Printing a Network Connection Report. . . . .	21
Printing a Network Status Sheet. . . . .	24
Replacing or Adding New Access Points. . . . .	25
Changing the Connection Method to a Computer. . . . .	25
Restoring the Network Settings from the Control Panel. . . . .	27

### Loading Paper

Paper Handling Precautions. . . . .	28
-------------------------------------	----

Available Paper and Capacities. . . . .	29
List of Paper Types. . . . .	30
Loading Paper in the Rear Paper Feed. . . . .	30

### Placing Originals on the Scanner Glass

Placing Multiple Photos for Scanning. . . . .	35
---	----

### Printing

Printing from a Computer. . . . .	36
Printing Basics - Windows. . . . .	36
Printing Basics - Mac OS X. . . . .	37
Printing on 2-Sides (for Windows only). . . . .	40
Printing Several Pages on One Sheet. . . . .	41
Printing to Fit the Paper Size. . . . .	42
Printing Multiple Files Together (for Windows Only). . . . .	43
Printing One Image on Multiple Sheets to Create a Poster (for Windows Only). . . . .	44
Printing Using Advanced Features. . . . .	50
Printing Photos Using Epson Easy Photo Print. . . . .	52
Printing from Smart Devices. . . . .	53
Using Epson iPrint. . . . .	53
Canceling Printing. . . . .	54
Canceling Printing - Printer Button. . . . .	55
Canceling Printing - Windows. . . . .	55
Canceling Printing - Mac OS X. . . . .	55

### Copying

Copying Basics. . . . .	56
Making Multiple Copies. . . . .	56

### Scanning

Scanning from the Control Panel. . . . .	57
Scanning from a Computer. . . . .	57
Scanning Using Epson Scan 2. . . . .	57
Scanning from Smart Devices. . . . .	63
Installing Epson iPrint. . . . .	63
Scanning Using Epson iPrint. . . . .	63

### Replacing Ink Cartridges

Checking the Ink Levels. . . . .	65
Checking the Ink Levels - Windows. . . . .	65

## Contents

Checking the Ink Levels - Mac OS X. . . . .	65
Ink Cartridge Codes. . . . .	65
Ink Cartridge Handling Precautions. . . . .	66
Replacing Ink Cartridges (When Ink Light is On or Flashing). . . . .	69
Replacing Ink Cartridges (When Ink Light is Off). . . . .	72
Temporarily Printing with Black Ink. . . . .	76
Temporarily Printing with Black Ink - Windows. . . . .	77
Temporarily Printing with Black Ink - Mac OS X. . . . .	78
Conserving Black Ink when the Black Ink Is Low (for Windows Only). . . . .	79

### **Maintaining the Printer**

Checking and Cleaning the Print Head. . . . .	80
Checking and Cleaning the Print Head - Printer Buttons. . . . .	80
Checking and Cleaning the Print Head - Windows. . . . .	81
Checking and Cleaning the Print Head - Mac OS X. . . . .	81
Aligning the Print Head. . . . .	81
Aligning the Print Head - Windows. . . . .	82
Aligning the Print Head - Mac OS X. . . . .	82
Cleaning the Paper Path. . . . .	82
Cleaning the Scanner Glass. . . . .	83
Saving Power. . . . .	83
Saving Power - Windows. . . . .	84
Saving Power - Mac OS X. . . . .	84

### **Network Service and Software Information**

Epson Connect Service. . . . .	85
Web Config. . . . .	85
Running Web Config on a Web Browser. . . . .	86
Running Web Config on Windows. . . . .	86
Running Web Config on Mac OS X. . . . .	86
Windows Printer Driver. . . . .	87
Guide to Windows Printer Driver. . . . .	88
Making Operation Settings for the Windows Printer Driver. . . . .	90
Mac OS X Printer Driver. . . . .	90
Guide to Mac OS X Printer Driver. . . . .	91
Making Operation Settings for the Mac OS X Printer Driver. . . . .	92
Epson Scan 2 (Scanner Driver). . . . .	93
Epson Event Manager. . . . .	93

Epson Easy Photo Print. . . . .	94
E-Web Print (for Windows Only). . . . .	94
Easy Photo Scan. . . . .	95
EPSON Software Updater. . . . .	95
Uninstalling Applications. . . . .	96
Uninstalling Applications - Windows. . . . .	96
Uninstalling Applications - Mac OS X. . . . .	97
Installing Applications. . . . .	97
Updating Applications and Firmware. . . . .	98

### **Solving Problems**

Checking the Printer Status. . . . .	99
Checking the Error Indicators on the Printer. . . . .	99
Checking the Printer Status - Windows. . . . .	100
Checking Printer Status - Mac OS X. . . . .	101
Removing Jammed Paper. . . . .	101
Removing Jammed Paper from the Rear Paper Feed. . . . .	102
Removing Jammed Paper from the Output Tray . . . . .	102
Removing Jammed Paper from Inside the Printer. . . . .	102
Paper Does Not Feed Correctly. . . . .	104
Paper Jams. . . . .	104
Paper Feeds at a Slant. . . . .	104
Several Sheets of Paper are Fed at a Time. . . . .	105
No Paper Feeds. . . . .	105
Power and Control Panel Problems. . . . .	105
Power Does Not Turn On. . . . .	105
Power Does Not Turn Off. . . . .	105
Cannot Print from a Computer. . . . .	105
When You Cannot Make Network Settings. . . . .	106
Cannot Connect from Devices Even Though Network Settings are No Problem. . . . .	106
Checking the SSID Connected to the Printer. . . . .	108
Checking the SSID for the Computer. . . . .	108
Suddenly the Printer Cannot Print over a Network Connection. . . . .	109
Suddenly the Printer Cannot Print Using a USB Connection. . . . .	110
Printout Problems. . . . .	110
Printout is Scuffed or Color is Missing. . . . .	110
Banding or Unexpected Colors Appear. . . . .	110
Colored Banding Appears at Intervals of Approximately 2.5 cm. . . . .	111
Blurry Prints, Vertical Banding, or Misalignment. . . . .	111
Print Quality is Poor. . . . .	112
Paper Is Smearred or Scuffed. . . . .	112

## Contents

Printed Photos are Sticky. . . . .	113
Images or Photos are Printed in Unexpected Colors. . . . .	113
Colors Differ from What You See on the Display. . . . .	113
Cannot Print Without Margins. . . . .	114
Edges of the Image are Cropped During Borderless Printing. . . . .	114
The Position, Size, or Margins of the Printout Are Incorrect. . . . .	114
Printed Characters Are Incorrect or Garbled. . . . .	114
The Printed Image Is Inverted. . . . .	115
Mosaic-Like Patterns in the Prints. . . . .	115
Uneven Colors, Smears, Dots, or Straight Lines Appear in the Copied Image. . . . .	115
Moiré (Cross-Hatch) Patterns Appear in the Copied Image. . . . .	115
Banding Appears on the Copied Image. . . . .	115
An Image of the Reverse Side of the Original Appears in the Copied Image. . . . .	115
The Printout Problem Could Not be Cleared. . . . .	116
Other Printing Problems. . . . .	116
Printing Is Too Slow. . . . .	116
Printing Slows Down Dramatically During Continuous Printing. . . . .	116
Cannot Start Scanning. . . . .	116
Cannot Start Scanning when Using the Control Panel. . . . .	117
Scanned Image Problems. . . . .	118
Uneven Colors, Dirt, Spots, and so on Appear when Scanning from the Scanner Glass. . . . .	118
The Image Quality Is Rough. . . . .	118
Offset Appears in the Background of Images. . . . .	118
Text is Blurred. . . . .	118
Moiré Patterns (Web-Like Shadows) Appear. . . . .	119
Cannot Scan the Correct Area on the Scanner Glass. . . . .	119
Cannot Preview in Thumbnail. . . . .	119
Text is Not Recognized Correctly when Saving as a Searchable PDF. . . . .	120
Cannot Solve Problems in the Scanned Image. . . . .	120
Other Scanning Problems. . . . .	121
Scanning Is Too Slow. . . . .	121
Scanning Stops when Scanning to PDF/Multi-TIFF. . . . .	121
Other Problems. . . . .	121
Slight Electric Shock when Touching the Printer. . . . .	121
Operation Sounds Are Loud. . . . .	121
Application Is Blocked by a Firewall (for Windows Only). . . . .	122

**Appendix**

Technical Specifications. . . . .	123
Printer Specifications. . . . .	123
Scanner Specifications. . . . .	124
Interface Specifications. . . . .	124
Network Function List. . . . .	124
Wi-Fi Specifications. . . . .	126
Security Protocol. . . . .	126
Dimensions. . . . .	126
Electrical Specifications. . . . .	126
Environmental Specifications. . . . .	127
System Requirements. . . . .	127
Regulatory Information. . . . .	128
Standards and Approvals. . . . .	128
Restrictions on Copying. . . . .	128
Transporting the Printer. . . . .	129
Where to Get Help. . . . .	131
Technical Support Web Site. . . . .	131
Contacting Epson Support. . . . .	131

# About This Manual

---

## Introduction of Manuals

The following manuals are supplied with your Epson printer. As well as the manuals, see the help included in the various Epson software applications.

Start Here (paper manual)

Provides you with information on setting up the printer, installing the software, using the printer, solving problems, and so on.

User's Guide (digital manual)

This manual. Provides overall information and instructions on using the printer, on network settings when using the printer on a network, and on solving problems.

You can obtain the latest versions of the above manuals with the following methods.

Paper manual

Visit the Epson Europe support website at <http://www.epson.eu/Support>, or the Epson worldwide support website at <http://support.epson.net/>.

Digital manual

Start EPSON Software Updater on your computer. EPSON Software Updater checks for available updates of Epson software applications and the digital manuals, and allows you to download the latest ones.

### Related Information

➔ [“EPSON Software Updater” on page 95](#)

---

## Marks and Symbols



**Caution:**

*Instructions that must be followed carefully to avoid bodily injury.*



**Important:**

*Instructions that must be observed to avoid damage to your equipment.*

**Note:**

*Provides complementary and reference information.*

➔ Related Information

Links to related sections.

---

## Descriptions Used in this Manual

- ❑ Screenshots of the printer driver and the Epson Scan 2 (scanner driver) screens are from Windows 10 or Mac OS X v10.11.x. The content displayed on the screens varies depending on the model and situation.
- ❑ Illustrations of the printer used in this manual are examples only. Although there may be slight differences depending on the model, the method of operation is the same.

---

## Operating System References

### Windows

In this manual, terms such as "Windows 10", "Windows 8.1", "Windows 8", "Windows 7", "Windows Vista", and "Windows XP" refer to the following operating systems. Additionally, "Windows" is used to refer to all versions.

- ❑ Microsoft® Windows® 10 operating system
- ❑ Microsoft® Windows® 8.1 operating system
- ❑ Microsoft® Windows® 8 operating system
- ❑ Microsoft® Windows® 7 operating system
- ❑ Microsoft® Windows Vista® operating system
- ❑ Microsoft® Windows® XP operating system
- ❑ Microsoft® Windows® XP Professional x64 Edition operating system

### Mac OS X

In this manual, "Mac OS X v10.11.x" refers to OS X El Capitan, "Mac OS X v10.10.x" refers to OS X Yosemite, "Mac OS X v10.9.x" refers to OS X Mavericks, and "Mac OS X v10.8.x" refers to OS X Mountain Lion. Additionally, "Mac OS X" is used to refer to "Mac OS X v10.11.x", "Mac OS X v10.10.x", "Mac OS X v10.9.x", "Mac OS X v10.8.x", "Mac OS X v10.7.x", and "Mac OS X v10.6.8".



# Important Instructions

---

## Safety Instructions

Read and follow these instructions to ensure safe use of this printer. Make sure you keep this manual for future reference. Also, be sure to follow all warnings and instructions marked on the printer.

- Some of the symbols used on your printer are to ensure safety and proper use of the printer. Visit the following Web site to learn the meaning of the symbols.  
<http://support.epson.net/symbols>
- Use only the power cord supplied with the printer and do not use the cord with any other equipment. Use of other cords with this printer or the use of the supplied power cord with other equipment may result in fire or electric shock.
- Be sure your AC power cord meets the relevant local safety standard.
- Never disassemble, modify, or attempt to repair the power cord, plug, printer unit, scanner unit, or options by yourself, except as specifically explained in the printer's manuals.
- Unplug the printer and refer servicing to qualified service personnel under the following conditions:  
The power cord or plug is damaged; liquid has entered the printer; the printer has been dropped or the casing damaged; the printer does not operate normally or exhibits a distinct change in performance. Do not adjust controls that are not covered by the operating instructions.
- Place the printer near a wall outlet where the plug can be easily unplugged.
- Do not place or store the printer outdoors, near excessive dirt or dust, water, heat sources, or in locations subject to shocks, vibrations, high temperature or humidity.
- Take care not to spill liquid on the printer and not to handle the printer with wet hands.
- Keep the printer at least 22 cm away from cardiac pacemakers. Radio waves from this printer may adversely affect the operation of cardiac pacemakers.
- Be careful when you handle used ink cartridges, as there may be some ink around the ink supply port.
  - If ink gets on your skin, wash the area thoroughly with soap and water.
  - If ink gets into your eyes, flush them immediately with water. If discomfort or vision problems continue after a thorough flushing, see a doctor immediately.
  - If ink gets into your mouth, see a doctor right away.
- Do not disassemble the ink cartridge; otherwise ink may get into your eyes or on your skin.
- Do not shake ink cartridges too vigorously and do not drop them. Also, be careful not to squeeze them or tear their labels. Doing so may cause ink leakage.
- Keep ink cartridges out of the reach of children.



---

## Printer Advisories and Warnings

Read and follow these instructions to avoid damaging the printer or your property. Make sure you keep this manual for future reference.

## Important Instructions

### Advisories and Warnings for Setting Up/Using the Printer

- Do not block or cover the vents and openings in the printer.
- Use only the type of power source indicated on the printer's label.
- Avoid using outlets on the same circuit as photocopiers or air control systems that regularly switch on and off.
- Avoid electrical outlets controlled by wall switches or automatic timers.
- Keep the entire computer system away from potential sources of electromagnetic interference, such as loudspeakers or the base units of cordless telephones.
- The power-supply cords should be placed to avoid abrasions, cuts, fraying, crimping, and kinking. Do not place objects on top of the power-supply cords and do not allow the power-supply cords to be stepped on or run over. Be particularly careful to keep all the power-supply cords straight at the ends and the points where they enter and leave the transformer.
- If you use an extension cord with the printer, make sure that the total ampere rating of the devices plugged into the extension cord does not exceed the cord's ampere rating. Also, make sure that the total ampere rating of all devices plugged into the wall outlet does not exceed the wall outlet's ampere rating.
- If you plan to use the printer in Germany, the building installation must be protected by a 10 or 16 amp circuit breaker to provide adequate short-circuit protection and over-current protection for the printer.
- When connecting the printer to a computer or other device with a cable, ensure the correct orientation of the connectors. Each connector has only one correct orientation. Inserting a connector in the wrong orientation may damage both devices connected by the cable.
- Place the printer on a flat, stable surface that extends beyond the base of the printer in all directions. The printer will not operate properly if it is tilted at an angle.
- When storing or transporting the printer, avoid tilting it, placing it vertically, or turning it upside down; otherwise ink may leak.
- Allow space above the printer so that you can fully raise the document cover.
- Leave enough space in front of the printer for the paper to be fully ejected.
- Avoid places subject to rapid changes in temperature and humidity. Also, keep the printer away from direct sunlight, strong light, or heat sources.
- Do not insert objects through the slots in the printer.
- Do not put your hand inside the printer during printing.
- Do not touch the white flat cable inside the printer.
- Do not use aerosol products that contain flammable gases inside or around the printer. Doing so may cause fire.
- Do not move the print head by hand; otherwise, you may damage the printer.
- Be careful not to trap your fingers when closing the scanner unit.
- Do not press too hard on the scanner glass when placing the originals.
- Always turn the printer off using the  button. Do not unplug the printer or turn off the power at the outlet until the  light stops flashing.
- Before transporting the printer, make sure that the print head is in the home (far right) position and the ink cartridges are in place.
- If you are not going to use the printer for a long period, be sure to unplug the power cord from the electrical outlet.

## Important Instructions

### **Advisories and Warnings for Using the Printer with a Wireless Connection**

- ❑ Radio waves from this printer may negatively affect the operation of medical electronic equipment, causing them to malfunction. When using this printer inside medical facilities or near medical equipment, follow directions from the authorized personnel representing the medical facilities, and follow all posted warnings and directions on the medical equipment.
- ❑ Radio waves from this printer may negatively affect the operation of automatically controlled devices such as automatic doors or fire alarms, and could lead to accidents due to malfunction. When using this printer near automatically controlled devices, follow all posted warnings and directions on these devices.

# Printer Basics

## Part Names and Functions

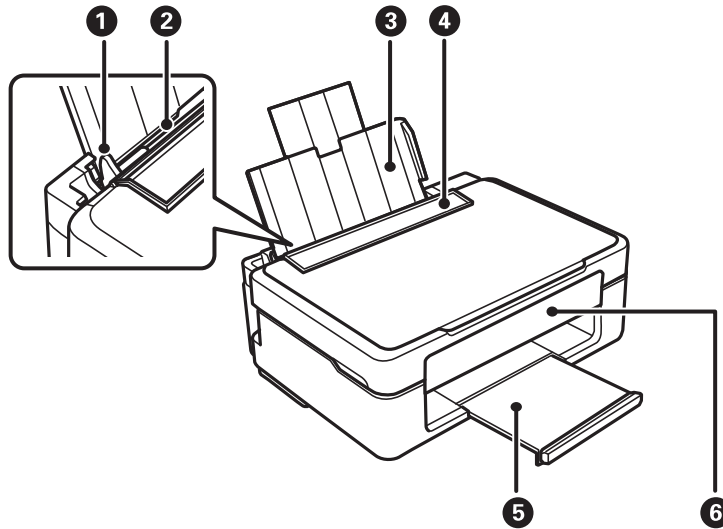

①	Edge guide	Feeds the paper straight into the printer. Slide to the edges of the paper.
②	Rear paper feed	Loads paper.
③	Paper support	Supports loaded paper.
④	Feeder guard	Prevents foreign substance from entering the printer. Usually keep this guard closed.
⑤	Output tray	Holds the ejected paper.
⑥	Control panel	Operates the printer.

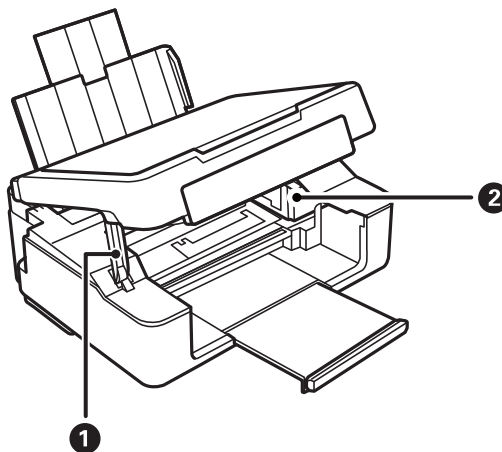

①	Scanner unit support	Supports the scanner unit.
---	----------------------	----------------------------

**Printer Basics**

<p>②</p>	<p>Ink cartridge holder</p>	<p>Install the ink cartridges. Ink is ejected from the print head nozzles underneath.</p>
----------	-----------------------------	---

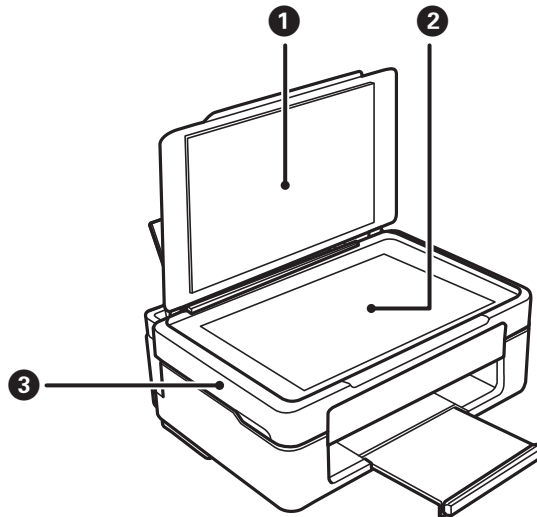

<p>①</p>	<p>Document cover</p>	<p>Blocks external light while scanning.</p>
<p>②</p>	<p>Scanner glass</p>	<p>Place the originals.</p>
<p>③</p>	<p>Scanner unit</p>	<p>Scans placed originals. Open when replacing ink cartridges or removing jammed paper inside the printer.</p>

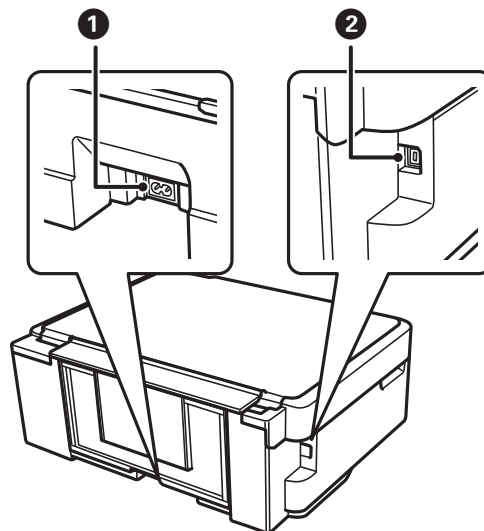







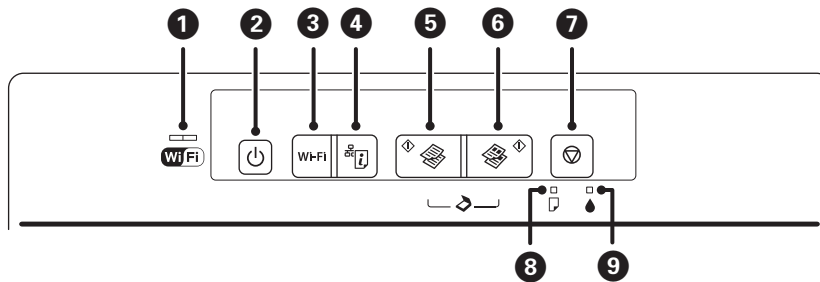



<p>①</p>	<p>AC inlet</p>	<p>Connects the power cord.</p>
<p>②</p>	<p>USB port</p>	<p>Connects a USB cable to connect with a computer.</p>

Printer Basics













# Control Panel



<p>1</p> 	<p>The left and right lights indicate the network status.</p> <ul style="list-style-type: none"> <li>❑ Green light - left: Turns on while the printer is connected to a wireless (Wi-Fi) network, or flashes while communicating.</li> <li>❑ Orange light - right: Flashes when a problem with the printer's wireless (Wi-Fi) network connection occurs.</li> </ul> <p>The lights flash alternately or simultaneously while initializing or making network settings.</p>
<p>2</p> 	<p>Turns the printer on or off.</p> <p>Do not turn off while the power light is flashing (while the printer is operating or processing data).</p> <p>Unplug the power cord when the power light is off.</p>
<p>3</p> <p>Wi-Fi</p>	<p>When a network error occurs, pressing this button cancels the error. Hold this button down for more than three seconds to perform Wi-Fi auto setup using the WPS push button.</p>
<p>4</p> 	<p>Prints a network connection report allowing you to determine the causes of any problems you may have using the printer on a network. If you need more detailed network settings and connection status, hold this button down for at least 10 seconds to print a network status sheet.</p>
<p>5</p> 	<p>Starts monochrome copying on A4 size plain paper. To increase the number of copies (by up to 20 copies), press this button within one second intervals.</p>
<p>6</p> 	<p>Starts color copying on A4 size plain paper. To increase the number of copies (by up to 20 copies), press this button within one second intervals.</p>
<p>7</p> 	<p>Stops the current operation.</p> <p>Hold this button down for three seconds until the  button flashes to run print head cleaning.</p> <p>When the  light turns on, press this button to replace the ink cartridges. When the  light flashes or turns off, hold this button down for six seconds to replace the cartridge.</p>
<p>8</p> 	<p>Turns on or flashes when paper is out or a paper jam occurs.</p>
<p>9</p> 	<p>Turns on when an ink cartridge error occurs, such as the ink cartridge needs to be replaced. Flashes when the ink is low.</p>

Additional functions are available with different combinations of buttons.

## Printer Basics

	<p>Press  and  buttons simultaneously to run software on a USB-connected computer and scan as a PDF file.</p>
	<p>Press the  and the  or  buttons simultaneously to copy in draft mode. For users in Western Europe, the draft mode is not available.</p>
<p>Wi-Fi + </p>	<p>Hold down the Wi-Fi and  buttons simultaneously for three seconds to start PIN Code Setup (WPS).</p>
	<p>Turn the printer on while holding down the  button to restore the default network settings. When the network settings are restored, the printer turns on and the network status lights flash orange and green.</p>
	<p>Turn the printer on while holding down the  button to print the nozzle check pattern.</p>

### Related Information

- ➔ [“Checking the Error Indicators on the Printer” on page 99](#)
- ➔ [“Making Wi-Fi Settings by PIN Code Setup \(WPS\)” on page 19](#)
- ➔ [“Restoring the Network Settings from the Control Panel” on page 27](#)

# Network Settings

---

## Wi-Fi Connection

Connect the printer and the computer or smart device to the access point. This is the typical connection method for home or office networks where computers are connected by Wi-Fi through the access point.

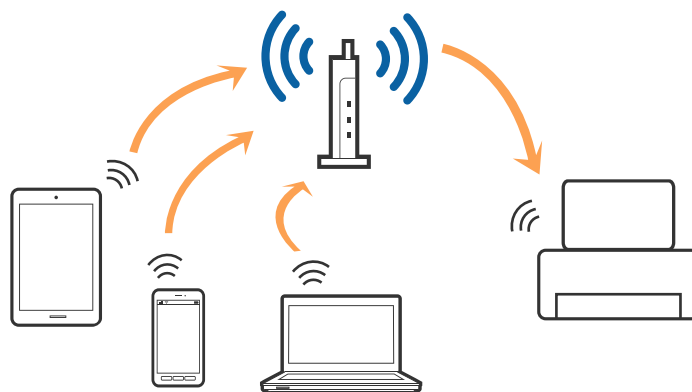

### Related Information

- ➔ “Connecting to a Computer” on page 16
- ➔ “Connecting to a Smart Device” on page 18
- ➔ “Making Wi-Fi Settings from the Control Panel” on page 18

---

## Connecting to a Computer

We recommend using the installer to connect the printer to a computer. You can run the installer using one of the following methods.

- Setting up from the website

Access the following website, and then enter the product name.

<http://epson.sn>

Go to **Setup**, and then click **Download** in the download and connect part. Click or double-click the downloaded file to run the installer. Follow the on-screen instructions.

- Setting up using the software disc (only for the models that come with a software disc and users with computers with disc drives.)

Insert the software disc into the computer, and then follow the on-screen instructions.

### Selecting the Connection Methods

Follow the on-screen instructions until the following screen is displayed, and then select the connection method of the printer to the computer.



## Network Settings

### Windows

Select the connection type and then click **Next**.

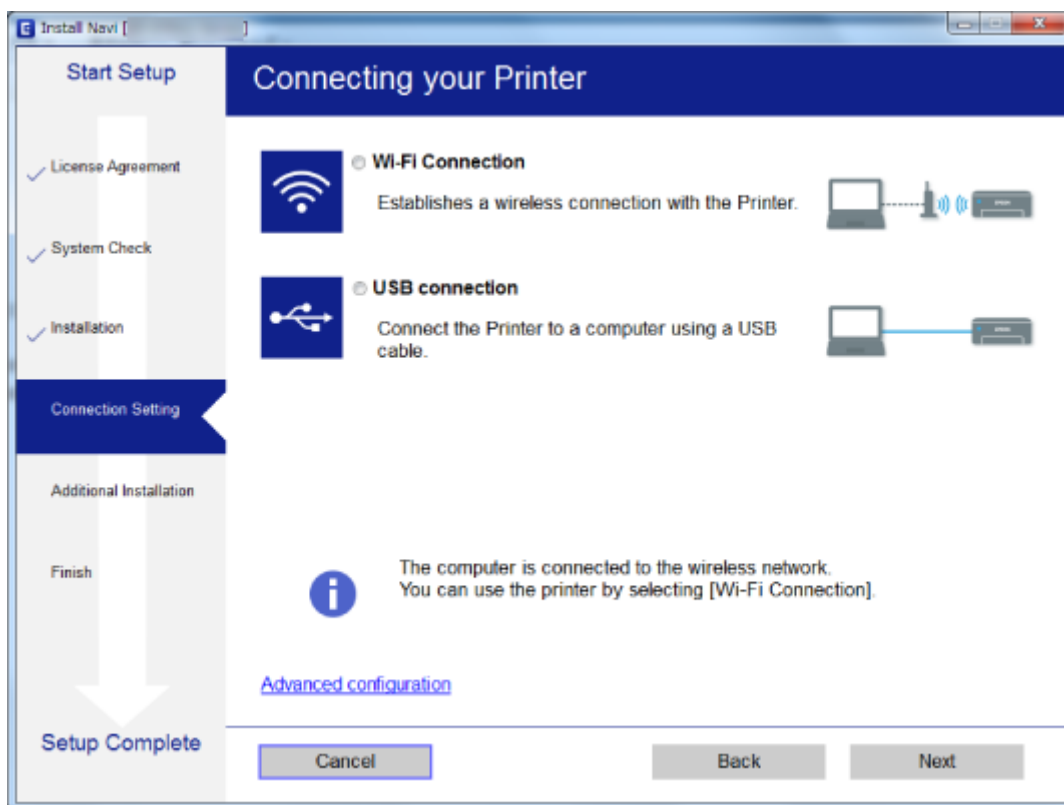

### Mac OS X

Select the connection type.



## Network Settings

Follow the on-screen instructions. The necessary software is installed.

---

## Connecting to a Smart Device

You can use the printer from a smart device when you connect the printer to the same Wi-Fi network (SSID) as the smart device. To use the printer from a smart device, set up from the following website. Access to the website from the smart device that you want to connect to the printer.

<http://epson.sn> > Setup

**Note:**

*If you want to connect a computer and a smart device to the printer at the same time, we recommend connecting the computer first.*

---

## Making Wi-Fi Settings from the Control Panel

You can make network settings from the printer's control panel. After connecting the printer to the network, connect to the printer from the device that you want to use (computer, smart phone, tablet, and so on.)

### Related Information

- ➔ [“Making Wi-Fi Settings by Push Button Setup” on page 18](#)
- ➔ [“Making Wi-Fi Settings by PIN Code Setup \(WPS\)” on page 19](#)

## Making Wi-Fi Settings by Push Button Setup

You can automatically set up a Wi-Fi network by pressing a button on the access point. If the following conditions are met, you can set up by using this method.

- The access point is compatible with WPS (Wi-Fi Protected Setup).
- The current Wi-Fi connection was established by pressing a button on the access point.

**Note:**

*If you cannot find the button or you are setting up using the software, see the documentation provided with the access point.*

1. Hold down the [WPS] button on the access point until the security light flashes.

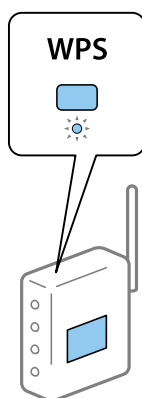

If you do not know where the [WPS] button is, or there are no buttons on the access point, see the documentation provided with your access point for details.

## Network Settings

2. Press Wi-Fi button on the printer's control panel until the green light on the left and the orange light on the right alternately blink (approximately 3 seconds).

The connection setting will start. Green light on the left and orange light on the right will simultaneously turn on when the connection is established. Orange light on the right will be automatically turned off within 5 minutes.



**Note:**

The printer is in a connection error status when green light on the left is off and orange light on the right is blinking. After clearing the printer error by pressing the Wi-Fi button on the control panel, reboot the access point, place it close to the printer and try again. If it still does not work, print a network connection report and check the solution.



### Related Information

- ➔ [“Checking the Network Connection Status”](#) on page 20
- ➔ [“When You Cannot Make Network Settings”](#) on page 106

## Making Wi-Fi Settings by PIN Code Setup (WPS)

You can connect to an access point by using a PIN code that is printed on the network status sheet. You can use this method to set up if an access point is capable of WPS (Wi-Fi Protected Setup). Use a computer to enter a PIN code into the access point.

1. Load papers.
2. Hold down the  button on the printer's control panel for at least 10 seconds.

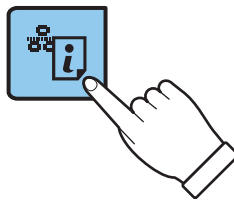

The network status sheet is printed.

**Note:**

If you release the  button within 10 seconds, a network connection report is printed. Note that PIN code information is not printed on this report.

## Network Settings

3. While holding down the Wi-Fi button, press the  button until green light on the left and orange light on the right flash simultaneously (approximately 3 seconds).

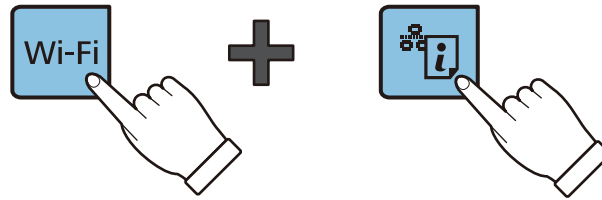

4. Use your computer to enter the PIN code (an eight digit number) printed on [WPS-PIN Code] column of the network status sheet into the access point within two minutes.

Green light on the left and orange light on the right will simultaneously turn on when the connection is established. Orange light on the right will be automatically turned off within 5 minutes.

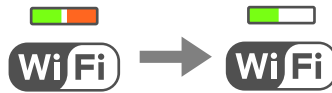

**Note:**

- ❑ See the documentation provided with your access point for details on entering a PIN code.
- ❑ The printer is in a connection error status when the green light on the left is off and the orange light on the right is blinking. After clearing the printer error by pressing the Wi-Fi button on the control panel, reboot the access point, place it close to the printer and try again. If it still does not work, print a network connection report and check the solution.



### Related Information

- ➔ [“Printing a Network Status Sheet” on page 24](#)
- ➔ [“Checking the Network Connection Status” on page 20](#)
- ➔ [“When You Cannot Make Network Settings” on page 106](#)

---

## Checking the Network Connection Status

### Checking the Network Status Using Network Light

You can check the network connection status using the network light on the printer's control panel.

### Related Information

- ➔ [“Control Panel” on page 14](#)

## Network Settings

### Printing a Network Connection Report

You can print a network connection report to check the status between the printer and the access point.

1. Load papers.
2. Press the  button.

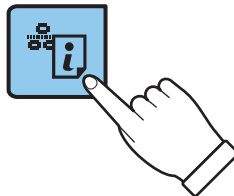

The network connection report is printed.

#### Related Information

➔ [“Messages and Solutions on the Network Connection Report” on page 21](#)

### Messages and Solutions on the Network Connection Report

Check the messages and error codes on the network connection report, and then follow the solutions.

The screenshot shows a printed network connection report. A blue box labeled 'a' highlights the 'Error code' field, which contains '(E-7)'. Another blue box labeled 'b' highlights the text below the error code: 'See the Network Status and check if the Network Name (SSID) is the SSID you want to connect. If the SSID is correct, make sure to enter the correct password and try again.'

```

Check Network Connection
-----
Check Result                               FAIL
Error code                                 (E-7)
See the Network Status and check if the Network Name (SSID) is
the SSID you want to connect.
If the SSID is correct, make sure to enter the correct password
and try again.
If your problems persist,
see your documentation for help and networking tips.
-----
Checked Items
-----
Wireless Network Name (SSID) Check        PASS
Communication Mode Check                  PASS
Security Mode Check                       PASS
MAC Address Filtering Check               PASS
Security Key/Password Check              FAIL
IP Address Check                          Unchecked
Detailed IP Setup Check                   Unchecked
-----
Network Status
-----
Printer Model                             XX-XXX XXX Series
IP Address                                0.0.0.0
Subnet Mask                                255.255.255.0
Default Gateway                            XXXXXXXXXXXX
Network Name (SSID)                       WPA2-PSK(AES)
Communication Mode                          Poor
Signal Strength                             44:D2:44:DA:C0:43
MAC Address
    
```

## Network Settings

- a. Error code
- b. Messages on the Network Environment

### a. Error code

Code	Solution
E-1	<ul style="list-style-type: none"> <li><input type="checkbox"/> Make sure that the Ethernet cable is connected to the printer, a hub, or other network devices.</li> <li><input type="checkbox"/> Make sure that the hub or other network devices are turned on.</li> </ul>
E-2	<ul style="list-style-type: none"> <li><input type="checkbox"/> Make sure that the access point is turned on.</li> </ul>
E-3	<ul style="list-style-type: none"> <li><input type="checkbox"/> Check that the computer or other devices are connected correctly to the access point.</li> </ul>
E-7	<ul style="list-style-type: none"> <li><input type="checkbox"/> Place the printer close to the access point. Remove any obstacles between them.</li> <li><input type="checkbox"/> If you have entered the SSID manually, check if it is correct. Check the SSID from the <b>Network Status</b> part on the network connection report.</li> <li><input type="checkbox"/> To establish a network using push button setup, check that the access point supports WPS. If it does not support WPS, you cannot establish a network using push button setup.</li> <li><input type="checkbox"/> Check that only ASCII characters (alphanumeric characters and symbols) are used for the SSID. The printer cannot display an SSID which contains any characters other than ASCII characters.</li> <li><input type="checkbox"/> Check the SSID and password before connecting to the access point. If you are using an access point with its default settings, the SSID and password are on the label. If you do not know the SSID and password, contact the person who set up the access point, or see the documentation provided with the access point.</li> <li><input type="checkbox"/> When you want to connect to an SSID generated using the tethering function on a smart device, check the SSID and password in the documentation provided with the smart device.</li> <li><input type="checkbox"/> If the Wi-Fi connection is suddenly disconnected, check the following. If any of these are applicable, reset the network settings using the installer. You can run it from the following website. <a href="http://epson.sn">http://epson.sn</a> &gt; <b>Setup</b> <ul style="list-style-type: none"> <li><input type="checkbox"/> Another smart device was added to the network using push button setup.</li> <li><input type="checkbox"/> The Wi-Fi network was set up using any method other than push button setup.</li> </ul> </li> </ul>
E-5	<p>Make sure the access point's security type is set to one of the following. If it is not, change the security type on the access point, and then reset the printer's network settings.</p> <ul style="list-style-type: none"> <li><input type="checkbox"/> WEP-64 bit (40 bit)</li> <li><input type="checkbox"/> WEP-128 bit (104 bit)</li> <li><input type="checkbox"/> WPA PSK (TKIP/AES)*</li> <li><input type="checkbox"/> WPA2 PSK (TKIP/AES)*</li> <li><input type="checkbox"/> WPA (TKIP/AES)</li> <li><input type="checkbox"/> WPA2 (TKIP/AES)</li> </ul> <p>* : WPA PSK is also known as WPA Personal. WPA2 PSK is also known as WPA2 Personal.</p>
E-6	<ul style="list-style-type: none"> <li><input type="checkbox"/> Check if the MAC address filtering is disabled. If it is enabled, register the printer's MAC address so that it is not filtered. See the documentation provided with the access point for details. You can check the printer's MAC address from the <b>Network Status</b> part on the network connection report.</li> <li><input type="checkbox"/> If the access point's shared authentication is enabled on the WEP security method, make sure the authentication key and index are correct.</li> </ul>
E-8	<ul style="list-style-type: none"> <li><input type="checkbox"/> Enable DHCP on the access point when the printer's Obtain IP Address is set to Auto.</li> <li><input type="checkbox"/> If the printer's Obtain IP Address is set to Manual, the IP address you manually set is out of range (for example: 0.0.0.0) and it is disabled. Set a valid IP address from printer's control panel or Web Config.</li> </ul>

## Network Settings

Code	Solution
E-9	<p>Check the following.</p> <ul style="list-style-type: none"> <li><input type="checkbox"/> Devices are turned on.</li> <li><input type="checkbox"/> You can access the Internet and other computers or network devices on the same network from the devices you want to connect to the printer.</li> </ul> <p>If it still does not work after checking the above, reset the network settings using the installer. You can run it from the following website.</p> <p><a href="http://epson.sn">http://epson.sn</a> &gt; <b>Setup</b></p>
E-10	<p>Check the following.</p> <ul style="list-style-type: none"> <li><input type="checkbox"/> Other devices on the network are turned on.</li> <li><input type="checkbox"/> Network addresses (IP address, subnet mask, and default gateway) are correct if you have set the printer's Obtain IP Address to Manual.</li> </ul> <p>Reset the network address if these are incorrect. You can check the IP address, subnet mask, and default gateway from the <b>Network Status</b> part on the network connection report.</p> <p>When DHCP is enabled, change the printer's Obtain IP Address to Auto. If you want to set the IP address manually, check the printer's IP address from the <b>Network Status</b> part on the network connection report, and then select Manual on the network settings screen. Set the subnet mask to [255.255.255.0].</p>
E-11	<p>Check the following.</p> <ul style="list-style-type: none"> <li><input type="checkbox"/> The default gateway address is correct when you set the printer's TCP/IP Setup to Manual.</li> <li><input type="checkbox"/> The device that is set as the default gateway is turned on.</li> </ul> <p>Set the correct default gateway address. You can check the default gateway address from the <b>Network Status</b> part on the network connection report.</p>
E-12	<p>Check the following.</p> <ul style="list-style-type: none"> <li><input type="checkbox"/> Other devices on the network are turned on.</li> <li><input type="checkbox"/> The network addresses (IP address, subnet mask, and default gateway) are correct if you are entering them manually.</li> <li><input type="checkbox"/> The network addresses for other devices (subnet mask and default gateway) are the same.</li> <li><input type="checkbox"/> The IP address does not conflict with other devices.</li> </ul> <p>If it still does not work after checking the above, try the following.</p> <ul style="list-style-type: none"> <li><input type="checkbox"/> Make network settings on the computer that is on the same network as the printer using the installer. You can run it from the following website. <ul style="list-style-type: none"> <li><a href="http://epson.sn">http://epson.sn</a> &gt; <b>Setup</b></li> </ul> </li> <li><input type="checkbox"/> You can register several passwords on an access point that uses the WEP security type. If several passwords are registered, check if the first registered password is set on the printer.</li> </ul>

## Network Settings

Code	Solution
E-13	<p>Check the following.</p> <ul style="list-style-type: none"> <li><input type="checkbox"/> Network devices such as an access point, hub, and router are turned on.</li> <li><input type="checkbox"/> The TCP/IP Setup for network devices has not been set up manually. (If the printer's TCP/IP Setup is set automatically while the TCP/IP Setup for other network devices is performed manually, the printer's network may differ from the network for other devices.)</li> </ul> <p>If it still does not work after checking the above, try the following.</p> <ul style="list-style-type: none"> <li><input type="checkbox"/> Make network settings on the computer that is on the same network as the printer using the installer. You can run it from the following website. <a href="http://epson.sn">http://epson.sn</a> &gt; <b>Setup</b></li> <li><input type="checkbox"/> You can register several passwords on an access point that uses the WEP security type. If several passwords are registered, check if the first registered password is set on the printer.</li> </ul>

### b. Messages on the Network Environment

Message	Solution
*Multiple network names (SSID) that match your entered network name (SSID) have been detected. Confirm network name (SSID).	The same SSID may be set on several access points. Check the settings on the access points, and change the SSID.
The Wi-Fi environment needs to be improved. Turn the wireless router off and then turn it on. If the connection does not improve, see the documentation for the wireless router.	After moving the printer closer to the access point and removing any obstacles between them, turn the access point on. If it still does not connect, see the documentation supplied with the access point.
*No more devices can be connected. Disconnect one of the connected devices if you want to add another one.	You can simultaneously connect up to four computers and smart devices in Wi-Fi Direct (Simple AP) connection. To add another computer or smart device, disconnect one of the connected devices first.

### Related Information

- ➔ [“Connecting to a Computer” on page 16](#)
- ➔ [“Web Config” on page 85](#)
- ➔ [“When You Cannot Make Network Settings” on page 106](#)

## Printing a Network Status Sheet

You can check the detailed network information by printing it.

1. Load papers.



## Network Settings

2. Hold down the  button on the printer's control panel for at least 10 seconds.

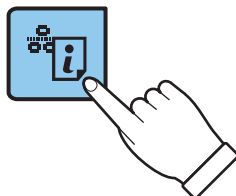

The network status sheet is printed.

**Note:**

If you release the  button within 10 seconds, a network connection report is printed.

## Replacing or Adding New Access Points

If the SSID changes due to the replacement of an access point, or an access point is added and a new network environment is established, re-set the Wi-Fi settings.

### Related Information

➔ [“Changing the Connection Method to a Computer” on page 25](#)

## Changing the Connection Method to a Computer

Using the installer and re-set up in a different connection method.

- Setting up from the website

Access the following website, and then enter the product name.

<http://epson.sn>

Go to **Setup**, and then click **Download** in the download and connect part. Click or double-click the downloaded file to run the installer. Follow the on-screen instructions.

- Setting up using the software disc (only for the models that come with a software disc and users with computers with disc drives.)

Insert the software disc into the computer, and then follow the on-screen instructions.

### Selecting Change the Connection Methods

Follow the on-screen instructions until the following screen is displayed.

## Network Settings

### Windows

Select **Change or re-set the connection method** on the Select Software Installation screen, and then click **Next**.

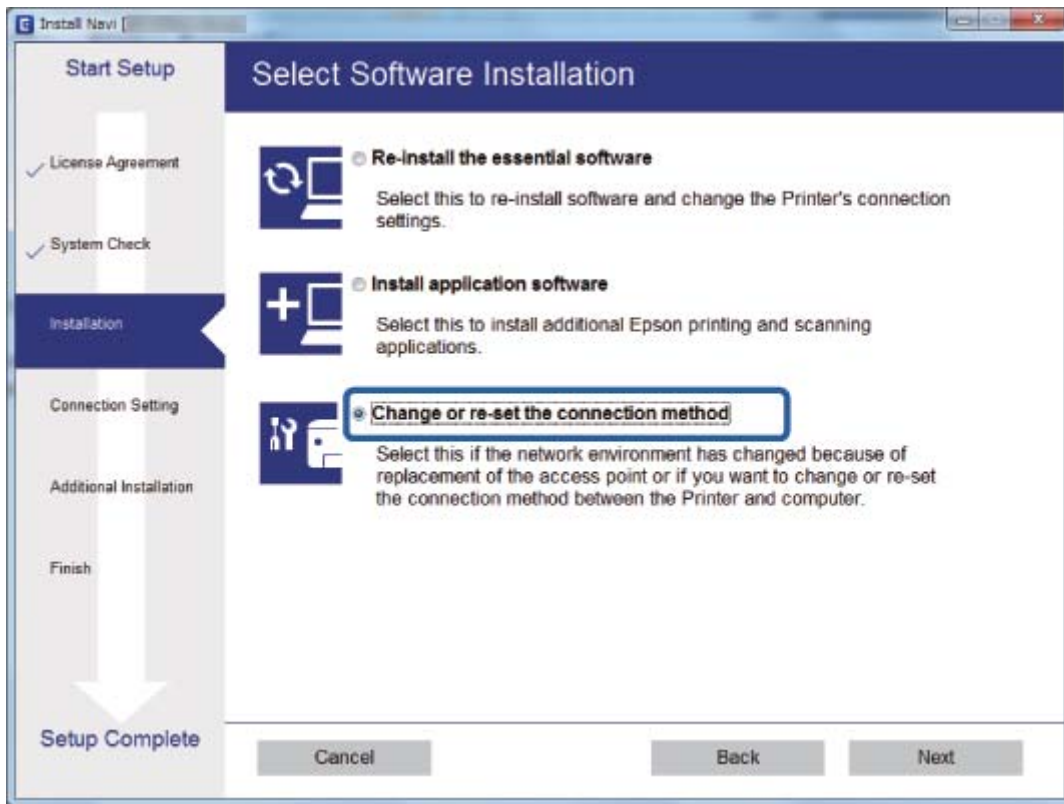

### Mac OS X



Select how you want to connect the printer to your computer.



---

## Restoring the Network Settings from the Control Panel

You can restore all network settings to their defaults.

1. Turn the printer off.
2. While holding down the  button, press the  button until the green light on the left and the orange light on the right flash alternately.

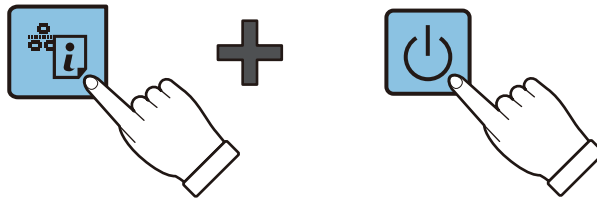

Restoration is complete when green light on the left and the orange light on the right are off.



# Loading Paper

## Paper Handling Precautions

- ❑ Read the instruction sheets supplied with the paper.
- ❑ Fan and align the edges of the paper before loading. Do not fan or curl photo paper. Doing so may damage the printable side.

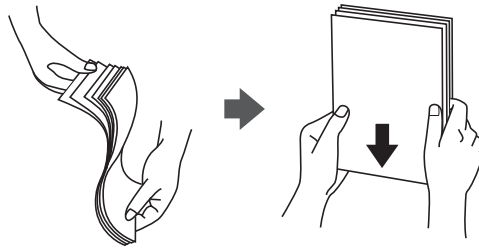

- ❑ If the paper is curled, flatten it or curl it slightly in the opposite direction before loading. Printing on curled paper may cause paper jams and smears on the printout.

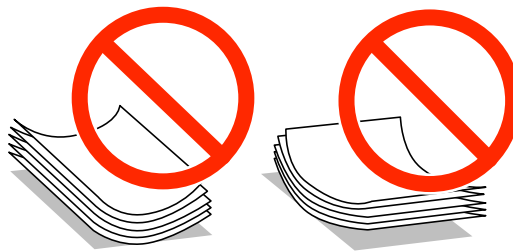

- ❑ Do not use paper that is wavy, torn, cut, folded, damp, too thick, too thin, or paper that has stickers stuck to it. Using these types of paper causes paper jams and smears on the printout.
- ❑ Fan and align the edges of the envelopes before loading. When the stacked envelopes are puffed up with air, press them down to flatten them before loading.

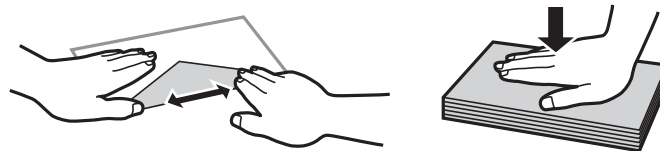

- ❑ Do not use envelopes that are curled or folded. Using these envelopes causes paper jams and smears on the printout.
- ❑ Do not use envelopes with adhesive surfaces on the flaps or window envelopes.
- ❑ Avoid using envelopes that are too thin, as they may curl during printing.

### Related Information

- ➔ [“Printer Specifications” on page 123](#)

## Loading Paper

## Available Paper and Capacities

Epson recommends using genuine Epson paper to ensure high-quality printouts. The only paper size and paper type available for printing from the control panel are A4 size and plain paper.

### Genuine Epson Paper

Media Name	Size	Loading Capacity (Sheets)	Manual 2-Sided Printing	Borderless Printing
Epson Bright White Ink Jet Paper	A4	40*	✓	–
Epson Ultra Glossy Photo Paper	A4, 13×18 cm (5×7 in.), 10×15 cm (4×6 in.)	10	–	✓
Epson Premium Glossy Photo Paper	A4, 13×18 cm (5×7 in.), 16:9 wide size (102 x 181 mm), 10×15 cm (4×6 in.)	10	–	✓
Epson Premium Semigloss Photo Paper	A4, 10×15 cm (4×6 in.)	10	–	✓
Epson Photo Paper Glossy	A4, 13×18 cm (5×7 in.), 10×15 cm (4×6 in.)	10	–	✓
Epson Matte Paper- Heavyweight	A4	20	–	✓
Epson Photo Quality Ink Jet Paper	A4	40	–	–

\* For manual 2-sided printing, you can load up to 15 sheets for paper with one side already printed.

**Note:**

The availability of paper varies by location. For the latest information on paper available in your area, contact Epson support.

### Commercially Available Paper

Media Name	Size	Loading Capacity (Number of sheets)	Manual 2-Sided Printing	Borderless Printing
Plain paper* <sup>1</sup>	Letter, A4, B5, A5, A6	Up to the line indicated by the triangle symbol on the edge guide.* <sup>2</sup>	✓	–
	Legal	1		
	User Defined			
Envelope	Envelope #10, Envelope DL, Envelope C6	5	–	–

## Loading Paper

\*1 The loading capacity for pre-punched paper is one sheet.

\*2 For manual 2-sided printing, you can load up to 15 sheets for paper with one side already printed.

### Related Information

➔ [“Technical Support Web Site”](#) on page 131

## List of Paper Types

To obtain optimum printing results, select the paper type that suits the paper.

Media Name	Media Type*2
Epson Bright White Ink Jet Paper*1	plain papers
Epson Ultra Glossy Photo Paper*1	Epson Ultra Glossy
Epson Premium Glossy Photo Paper*1	Epson Premium Glossy
Epson Premium Semigloss Photo Paper*1	Epson Premium Semigloss
Epson Photo Paper Glossy*1	Photo Paper Glossy
Epson Matte Paper-Heavyweight*1	Epson Matte
Epson Photo Quality Ink Jet Paper*1	Epson Matte
Plain paper*1	plain papers
Envelope	Envelope

\*1 These paper types are compatible with Exif Print and PRINT Image Matching when printed by the printer driver. For more information, see the documentation that came with the Exif Print or PRINT Image Matching compatible digital camera.

\*2 For smart devices, these media types can be selected when printing using Epson iPrint.

## Loading Paper in the Rear Paper Feed

1. Open the feeder guard, extend the paper support, and then tilt it backwards.

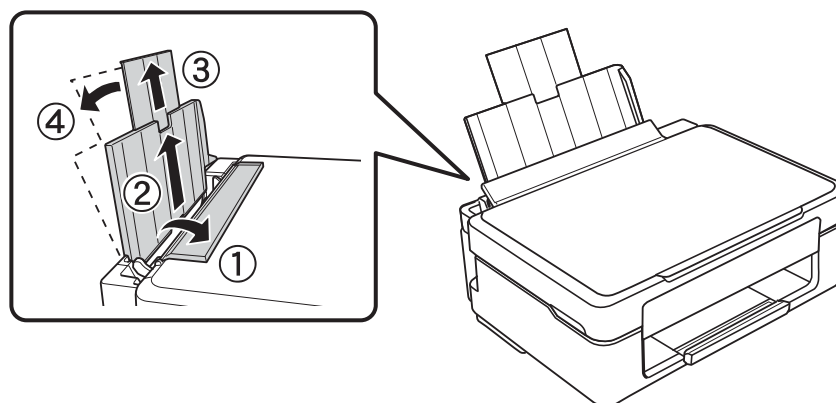

## Loading Paper

- Slide the edge guide to the left.

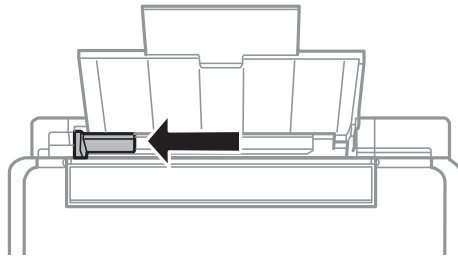

- Load paper vertically along the right side of the rear paper feed with the printable side facing up.

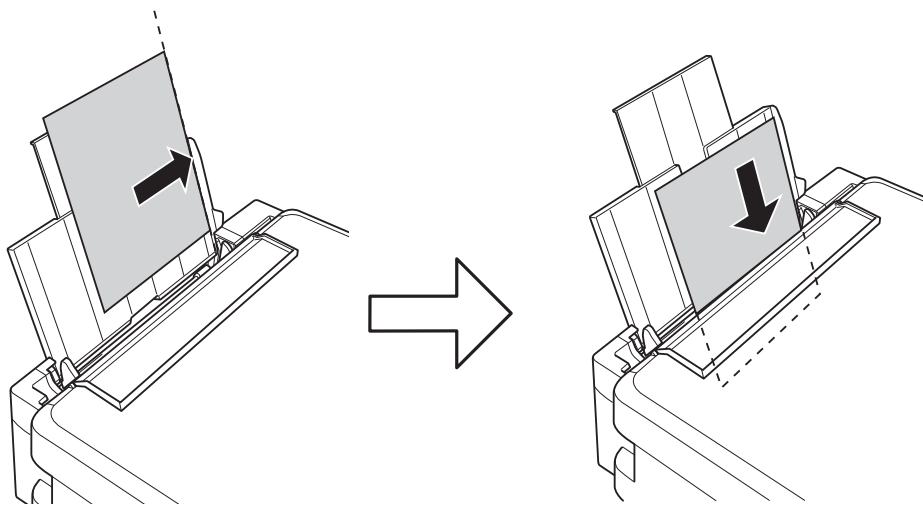

**!** **Important:**

*Do not load more than the maximum number of sheets specified for the paper. For plain paper, do not load above the line indicated by the triangle symbol on the edge guide.*

Envelopes

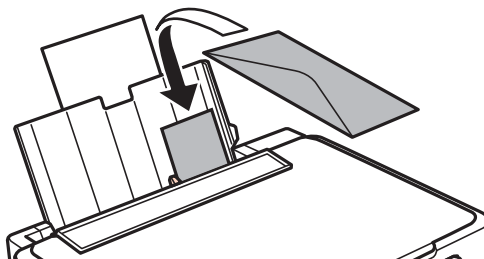

## Loading Paper

- ❑ Pre-punched paper

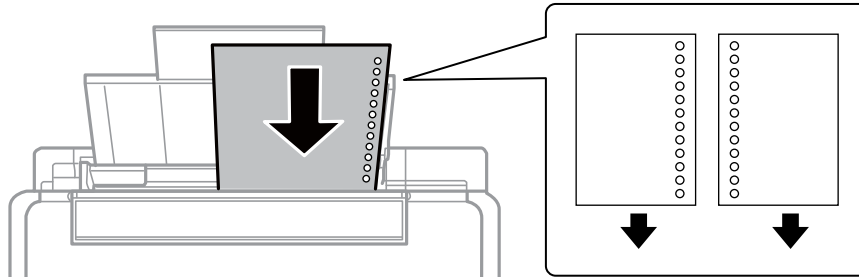

**Note:**

- ❑ Load a single sheet of paper without binding holes at the top or the bottom.
  - ❑ Adjust the print position of your file to avoid printing over the holes.
4. Slide the edge guide to the edge of the paper, and then close the feeder guard.

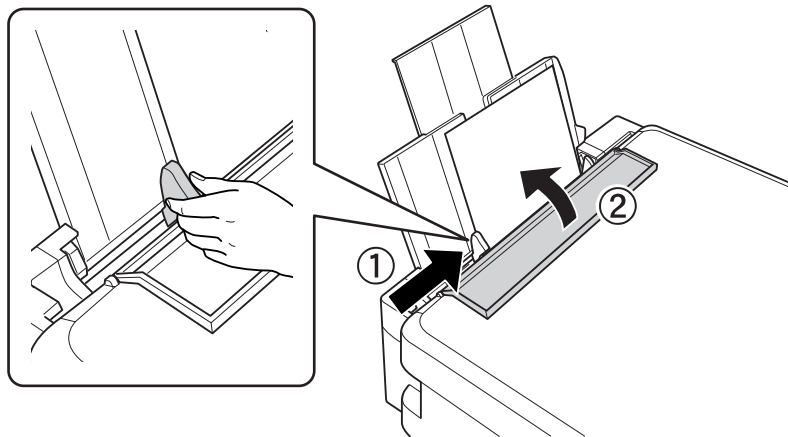

5. Slide out the output tray.

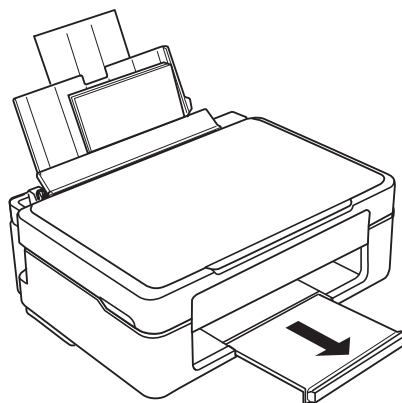

**Note:**

Return the remaining paper to its package. If you leave it in the printer, the paper may curl or the print quality may decline.

### Related Information

➔ [“Paper Handling Precautions” on page 28](#)



## Loading Paper

➔ [“Available Paper and Capacities” on page 29](#)

## Placing Originals on the Scanner Glass

# Placing Originals on the Scanner Glass



**Important:**

*When placing bulky originals such as books, prevent exterior light from shining directly onto the scanner glass.*

1. Open the document cover.

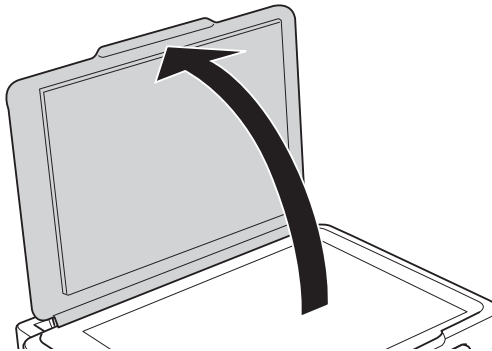

2. Remove any dust or stains on the scanner glass.
3. Place the original face-down and slide it to the corner mark.

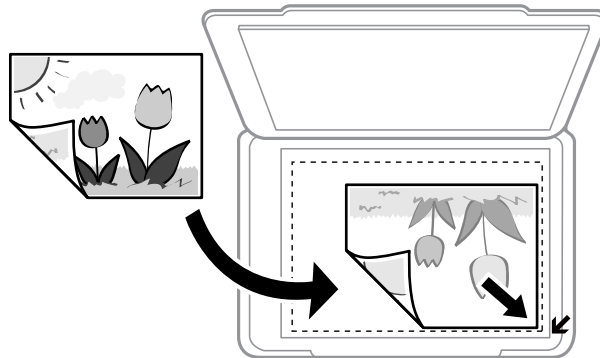

**Note:**

*A range of 1.5 mm from the edges of the scanner glass is not scanned.*

4. Close the cover gently.
5. Remove the originals after scanning.

**Note:**

*If you leave the originals on the scanner glass for a long time, they may stick to the surface of the glass.*

## Placing Multiple Photos for Scanning

You can scan multiple photos at once in **Photo Mode** in Epson Scan 2 when you select **Thumbnail** from the list at the top of the preview window.

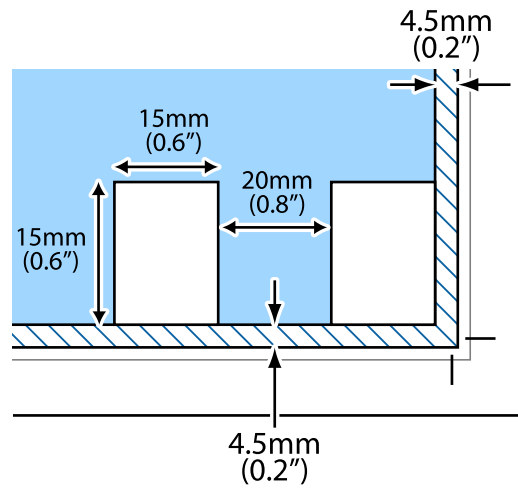

# Printing

## Printing from a Computer

### Printing Basics - Windows

**Note:**

- ❑ See the online help for explanations of the setting items. Right-click an item, and then click **Help**.
- ❑ Operations differ depending on the application. See the application's help for details.

1. Load paper in the printer.
2. Open the file you want to print.
3. Select **Print** or **Print Setup** from the **File** menu.
4. Select your printer.
5. Select **Preferences** or **Properties** to access the printer driver window.

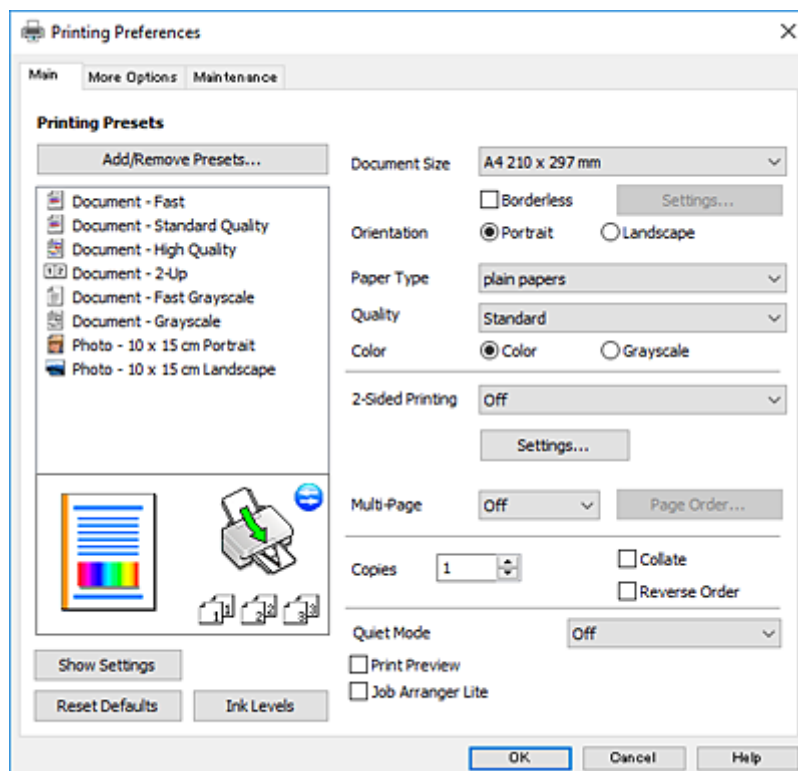

6. Make the following settings.
  - ❑ Document Size: Select the paper size you loaded in the printer.
  - ❑ Borderless: Select to print with no margins around the image.

In borderless printing, the print data is enlarged slightly more than the paper size so that no margins are printed around the edges of the paper. Click **Settings** to select the amount of enlargement.

## Printing

- Orientation: Select the orientation you set in the application.
- Paper Type: Select the type of paper you loaded.
- Quality: Select the print quality.  
Selecting **High** provides higher quality printing, but the printing speed may be slower.
- Color: Select **Grayscale** when you want to print in black or shades of gray.

**Note:**

*When printing on envelopes, select **Landscape** as the **Orientation** setting.*

7. Click **OK** to close the printer driver window.
8. Click **Print**.

### Related Information

- ➔ [“Available Paper and Capacities” on page 29](#)
- ➔ [“Loading Paper in the Rear Paper Feed” on page 30](#)
- ➔ [“Guide to Windows Printer Driver” on page 88](#)
- ➔ [“List of Paper Types” on page 30](#)

## Printing Basics - Mac OS X

**Note:**

*Explanations in the section use TextEdit as an example. Operations and screens differ depending on the application. See the application's help for details.*

1. Load paper in the printer.
2. Open the file you want to print.

## Printing

3. Select **Print** from the **File** menu or another command to access the print dialog.

If necessary, click **Show Details** or ▼ to expand the print window.

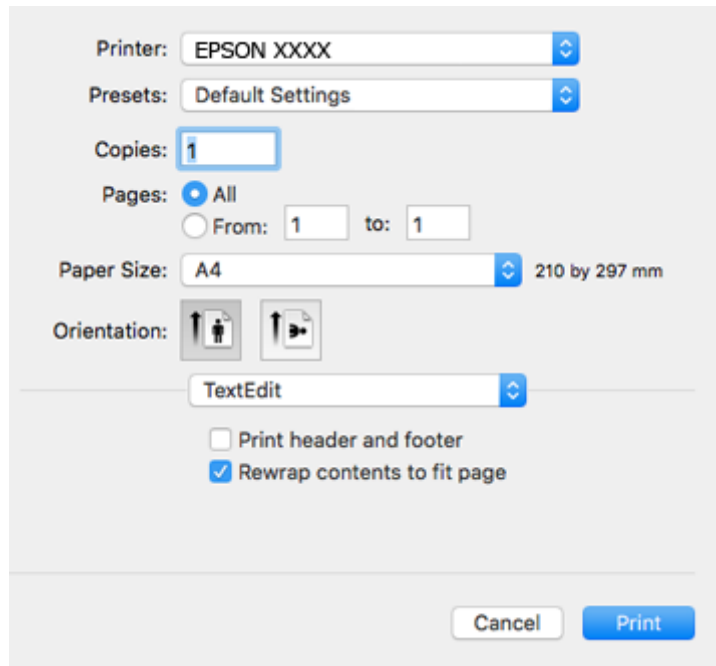

4. Make the following settings.

- Printer: Select your printer.
- Presets: Select when you want to use the registered settings.
- Paper Size: Select the paper size you loaded in the printer.  
When printing with no margins, select a "borderless" paper size.
- Orientation: Select the orientation you set in the application.

**Note:**

- If the above setting menus are not displayed, close the print window, select **Page Setup** from the **File** menu, and then make settings.
- When printing on envelopes, select landscape orientation.

## Printing

5. Select **Print Settings** from the pop-up menu.

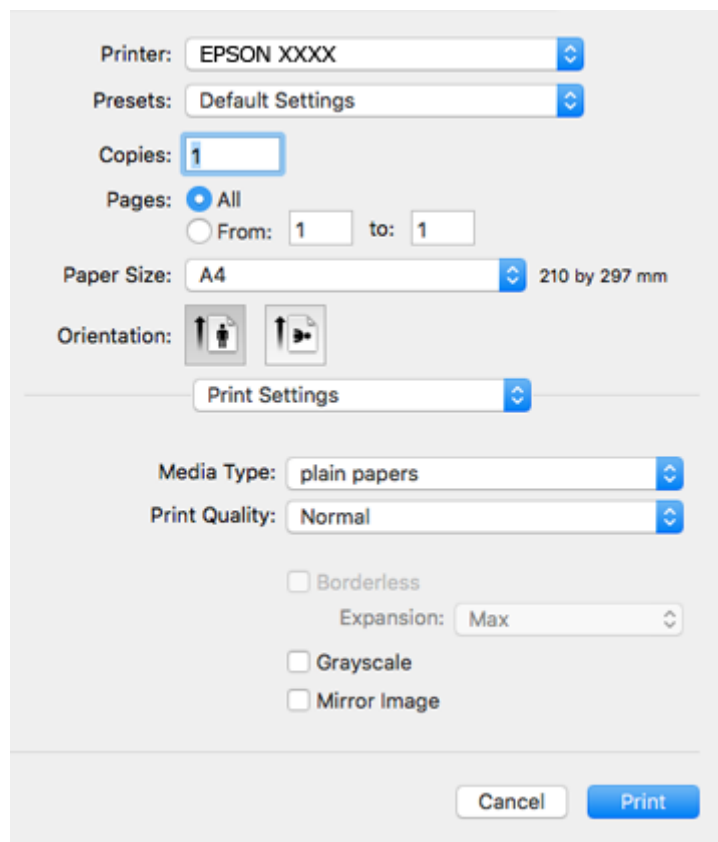

**Note:**

On Mac OS X v10.8.x or later, if the **Print Settings** menu is not displayed, the Epson printer driver has not been installed correctly.

Select **System Preferences** from the  menu > **Printers & Scanners** (or **Print & Scan**, **Print & Fax**), remove the printer, and then add the printer again. See the following to add a printer.

<http://epson.sn>

6. Make the following settings.
  - Media Type: Select the type of paper you loaded.
  - Print Quality: Select the print quality.  
Selecting **Fine** provides higher quality printing, but the printing speed may be slower.
  - Expansion: Available when selecting a borderless paper size.  
In borderless printing, the print data is enlarged slightly more than the paper size so that no margins are printed around the edges of the paper. Select the amount of enlargement.
  - Grayscale: Select to print in black or shades of gray.
7. Click **Print**.

### Related Information

- ➔ “Available Paper and Capacities” on page 29
- ➔ “Loading Paper in the Rear Paper Feed” on page 30
- ➔ “Guide to Mac OS X Printer Driver” on page 91

## Printing

➔ “List of Paper Types” on page 30

### Printing on 2-Sides (for Windows only)

The printer driver prints automatically separating even pages and odd pages. When the printer has finished printing the odd pages, flip the paper over following the instructions to print the even pages. You can also print a booklet that can be created by folding the printout.

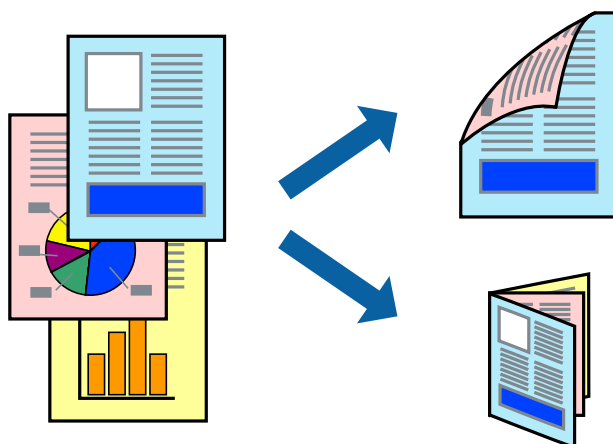

**Note:**

- This feature is not available for borderless printing.
- If you do not use paper that is suitable for 2-sided printing, the print quality may decline and paper jams may occur.
- Depending on the paper and the data, ink may bleed through to the other side of the paper.
- If **EPSON Status Monitor 3** is disabled, access the printer driver, click **Extended Settings** on the **Maintenance** tab, and then select **Enable EPSON Status Monitor 3**.
- 2-sided printing may not be available when the printer is accessed over a network or is used as a shared printer.

1. Load paper in the printer.
2. Open the file you want to print.
3. Access the printer driver window.
4. Select **Manual (Long-edge binding)** or **Manual (Short-edge binding)** from **2-Sided Printing** on the **Main** tab.
5. Click **Settings**, make the appropriate settings, and then click **OK**.

**Note:**

To print as a booklet, select **Booklet**.

6. Set the other items on the **Main** and **More Options** tabs as necessary, and then click **OK**.
7. Click **Print**.

When the first side has finished printing, a pop-up window is displayed on the computer. Follow the on-screen instructions.



## Printing

### Related Information

- ➔ “Available Paper and Capacities” on page 29
- ➔ “Loading Paper in the Rear Paper Feed” on page 30
- ➔ “Printing Basics - Windows” on page 36

## Printing Several Pages on One Sheet

You can print two or four pages of data on a single sheet of paper.

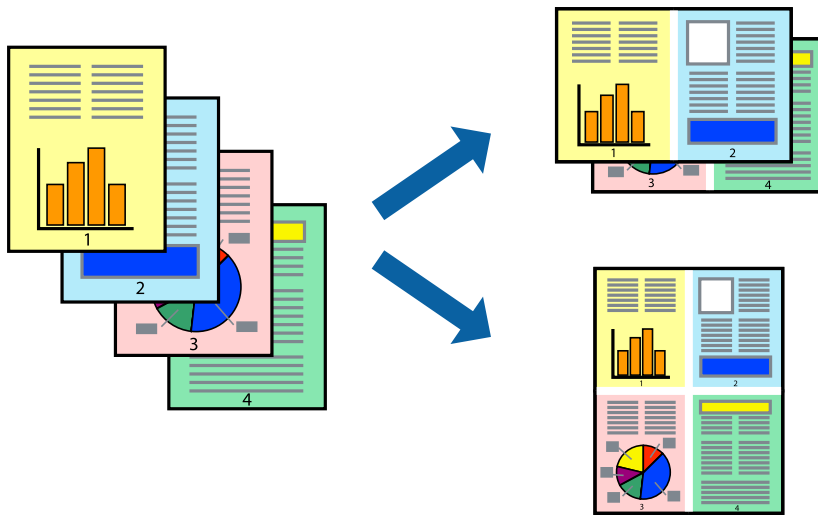

## Printing Several Pages on One Sheet - Windows

### Note:

*This feature is not available for borderless printing.*

1. Load paper in the printer.
2. Open the file you want to print.
3. Access the printer driver window.
4. Select **2-Up** or **4-Up** as the **Multi-Page** setting on the **Main** tab.
5. Click **Page Order**, make the appropriate settings, and then click **OK** to close the window.
6. Set the other items on the **Main** and **More Options** tabs as necessary, and then click **OK**.
7. Click **Print**.

### Related Information

- ➔ “Loading Paper in the Rear Paper Feed” on page 30
- ➔ “Printing Basics - Windows” on page 36

## Printing

### Printing Several Pages on One Sheet - Mac OS X

1. Load paper in the printer.
2. Open the file you want to print.
3. Access the print dialog.
4. Select **Layout** from the pop-up menu.
5. Set the number of pages in **Pages per Sheet**, the **Layout Direction** (page order), and **Border**.
6. Set the other items as necessary.
7. Click **Print**.

#### Related Information

- ➔ [“Loading Paper in the Rear Paper Feed”](#) on page 30
- ➔ [“Printing Basics - Mac OS X”](#) on page 37

### Printing to Fit the Paper Size

You can print to fit the paper size you loaded in the printer.



### Printing to Fit the Paper Size - Windows

#### Note:

*This feature is not available for borderless printing.*

1. Load paper in the printer.
2. Open the file you want to print.
3. Access the printer driver window.
4. Make the following settings on the **More Options** tab.
  - Document Size: Select the paper size you set in the application.
  - Output Paper: Select the paper size you loaded in the printer.

## Printing

**Fit to Page** is selected automatically.

**Note:**

If you want to print a reduced image at the center of the page, select **Center**.

5. Set the other items on the **Main** and **More Options** tabs as necessary, and then click **OK**.
6. Click **Print**.

### Related Information

- ➔ “Loading Paper in the Rear Paper Feed” on page 30
- ➔ “Printing Basics - Windows” on page 36

## Printing to Fit the Paper Size - Mac OS X

1. Load paper in the printer.
2. Open the file you want to print.
3. Access the print dialog.
4. Select the size of the paper you set in the application as the **Paper Size** setting.
5. Select **Paper Handling** from the pop-up menu.
6. Select **Scale to fit paper size**.
7. Select the paper size you loaded in the printer as the **Destination Paper Size** setting.
8. Set the other items as necessary.
9. Click **Print**.

### Related Information

- ➔ “Loading Paper in the Rear Paper Feed” on page 30
- ➔ “Printing Basics - Mac OS X” on page 37

## Printing Multiple Files Together (for Windows Only)

**Job Arranger Lite** allows you to combine several files created by different applications and print them as a single print job. You can specify the print settings for combined files, such as layout, print order, and orientation.

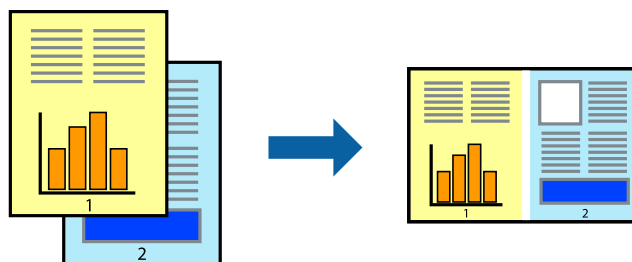

## Printing

1. Load paper in the printer.
2. Open the file you want to print.
3. Access the printer driver window.
4. Select **Job Arranger Lite** on the **Main** tab.
5. Click **OK** to close the printer driver window.
6. Click **Print**.

The **Job Arranger Lite** window is displayed and the print job is added to the **Print Project**.

7. With the **Job Arranger Lite** window opened, open the file that you want to combine with the current file, and then repeat steps 3 to 6.

**Note:**

- If you close the **Job Arranger Lite** window, the unsaved **Print Project** is deleted. To print later, select **Save** from the **File** menu.
- To open a **Print Project** saved in **Job Arranger Lite**, click **Job Arranger Lite** on the printer driver's **Maintenance** tab. Next, select **Open** from the **File** menu to select the file. The extension of the saved files is ".ecl".

8. Select the **Layout** and **Edit** menus in **Job Arranger Lite** to edit the **Print Project** as necessary. See the help of Job Arranger Lite for details.
9. Select **Print** from the **File** menu.

### Related Information

- ➔ [“Loading Paper in the Rear Paper Feed” on page 30](#)
- ➔ [“Printing Basics - Windows” on page 36](#)

## Printing One Image on Multiple Sheets to Create a Poster (for Windows Only)

This feature allows you to print one image on multiple sheets of paper. You can create a larger poster by taping them together.

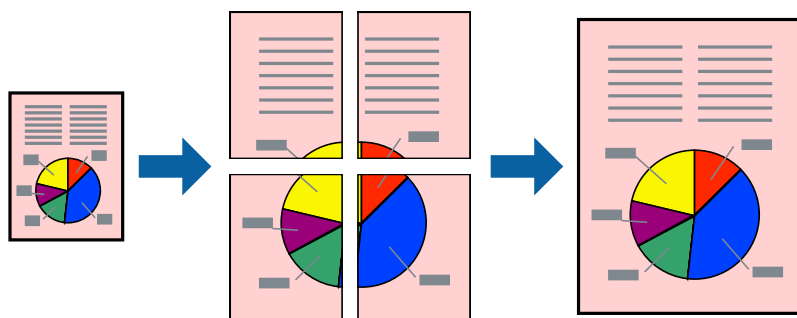

**Note:**

*This feature is not available for borderless printing.*

1. Load paper in the printer.

## Printing

2. Open the file you want to print.
3. Access the printer driver window.
4. Select **2x1 Poster**, **2x2 Poster**, **3x3 Poster**, or **4x4 Poster** from **Multi-Page** on the **Main** tab.
5. Click **Settings**, make the appropriate settings, and then click **OK**.

**Note:**

*Print Cutting Guides* allows you to print a cutting guide.

6. Set the other items on the **Main** and **More Options** tabs as necessary, and then click **OK**.
7. Click **Print**.

### Related Information

- ➔ [“Loading Paper in the Rear Paper Feed”](#) on page 30
- ➔ [“Printing Basics - Windows”](#) on page 36

## Making Posters Using Overlapping Alignment Marks

Here is an example of how to make a poster when **2x2 Poster** is selected, and **Overlapping Alignment Marks** is selected in **Print Cutting Guides**.

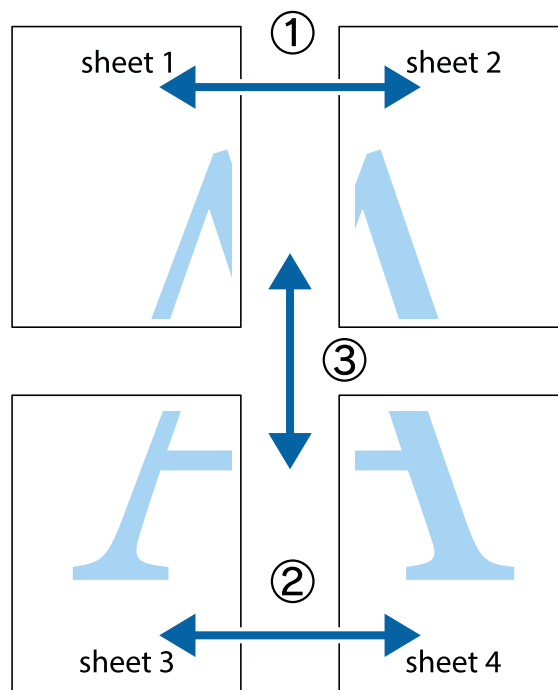

### Printing

1. Prepare Sheet 1 and Sheet 2. Cut off the margins of Sheet 1 along the vertical blue line through the center of the top and bottom cross marks.

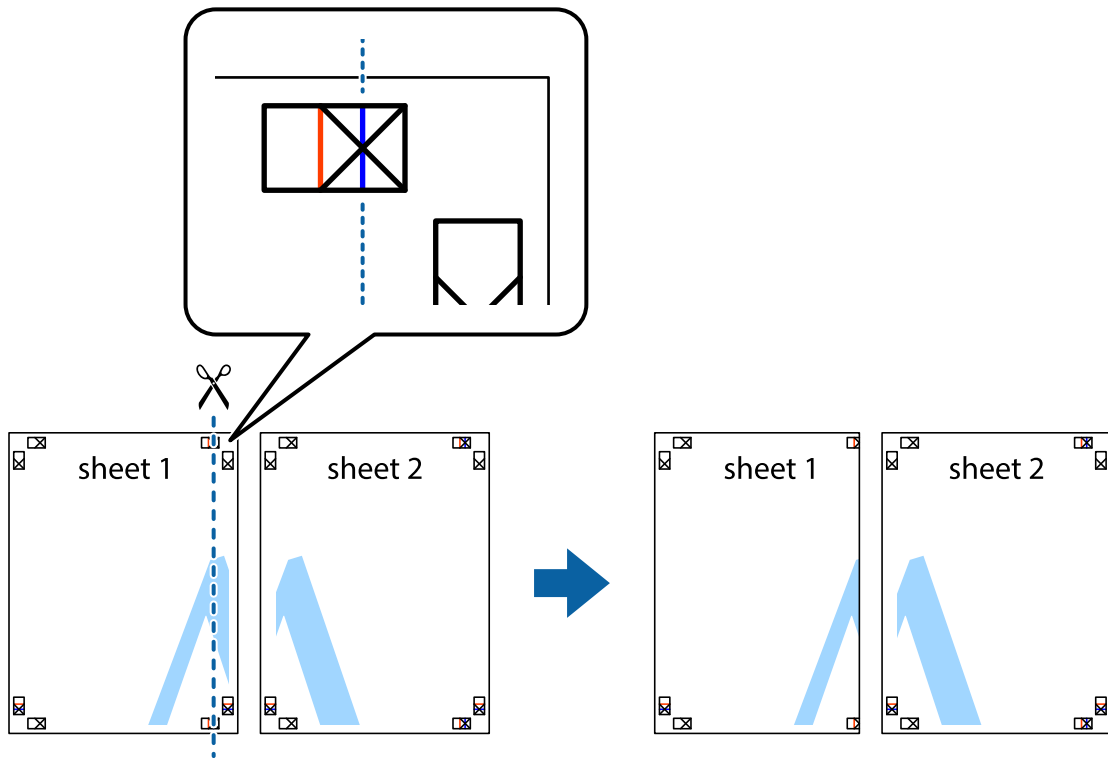

2. Place the edge of Sheet 1 on top of Sheet 2 and align the cross marks, then temporarily tape the two sheets together from the back.

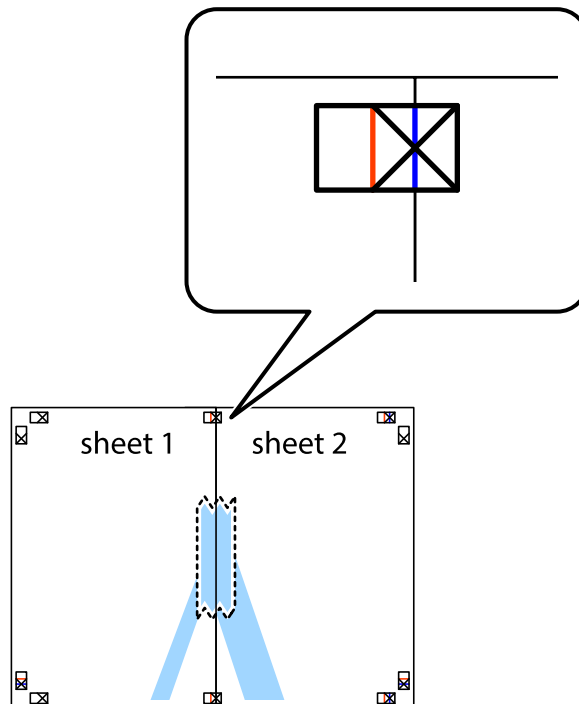

### Printing

- Cut the taped sheets in two along the vertical red line through the alignment markers (this time, the line to the left of the cross marks).

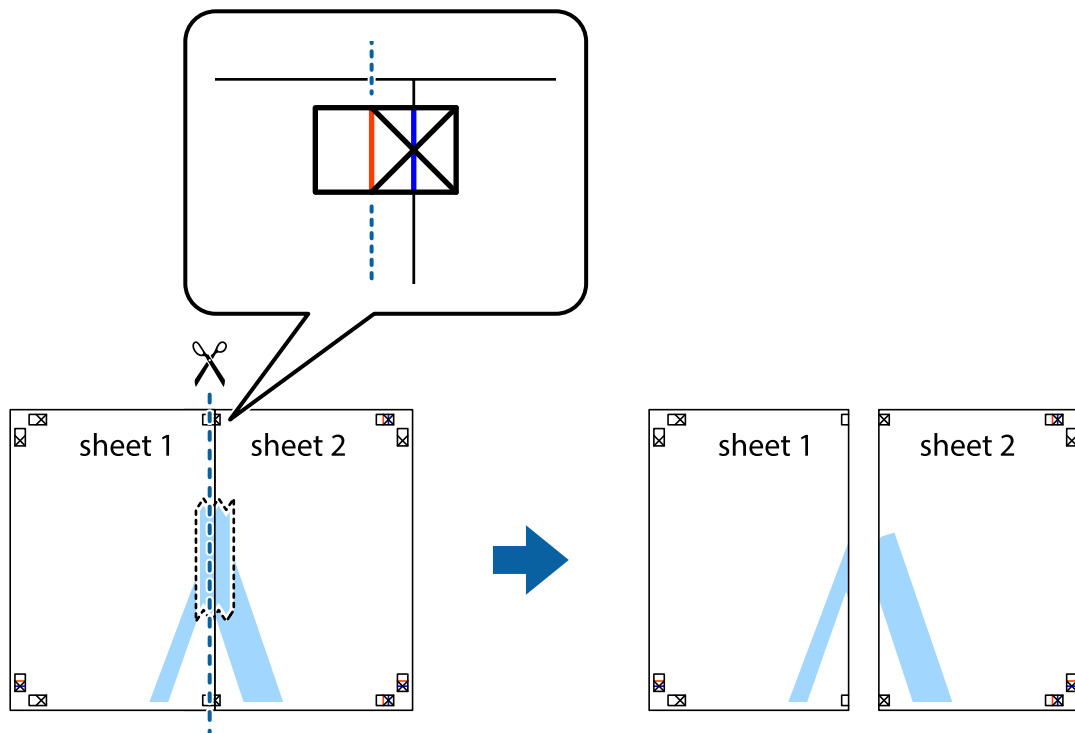

- Tape the sheets together from the back.

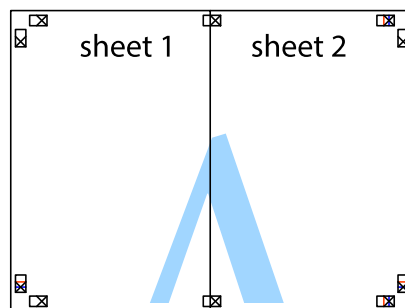

- Repeat steps 1 to 4 to tape Sheet 3 and Sheet 4 together.

### Printing

6. Cut off the margins of Sheet 1 and Sheet 2 along the horizontal blue line through the center of the left and right side cross marks.

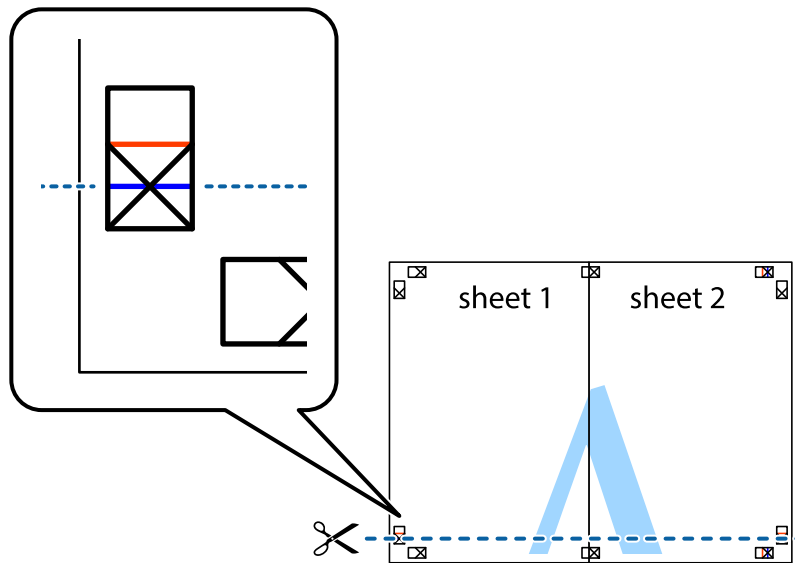

7. Place the edge of Sheet 1 and Sheet 2 on top of Sheet 3 and Sheet 4 and align the cross marks, and then temporarily tape them together from the back.

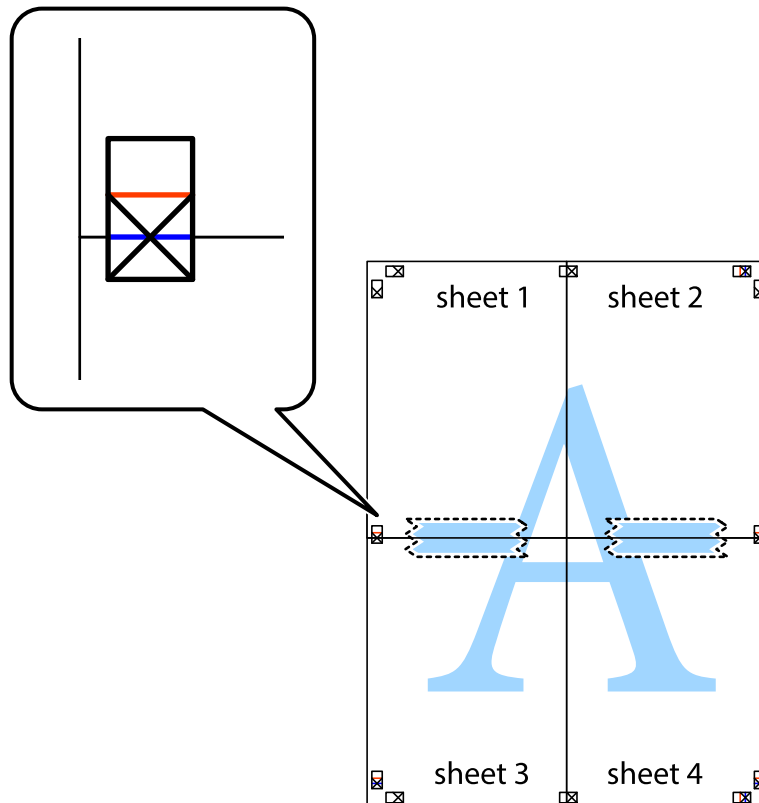



### Printing

- Cut the taped sheets in two along the horizontal red line through the alignment markers (this time, the line above the cross marks).

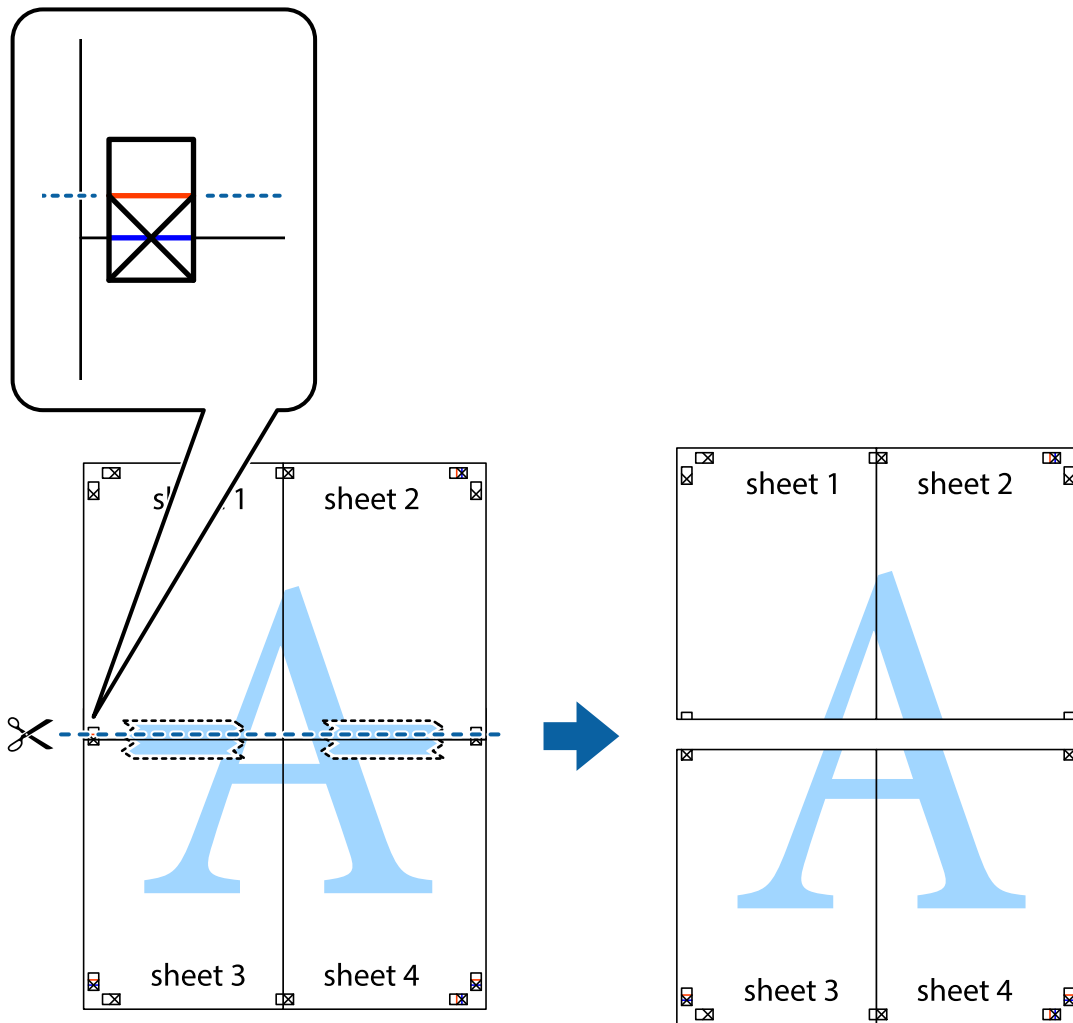

- Tape the sheets together from the back.



## Printing

10. Cut off the remaining margins along the outer guide.

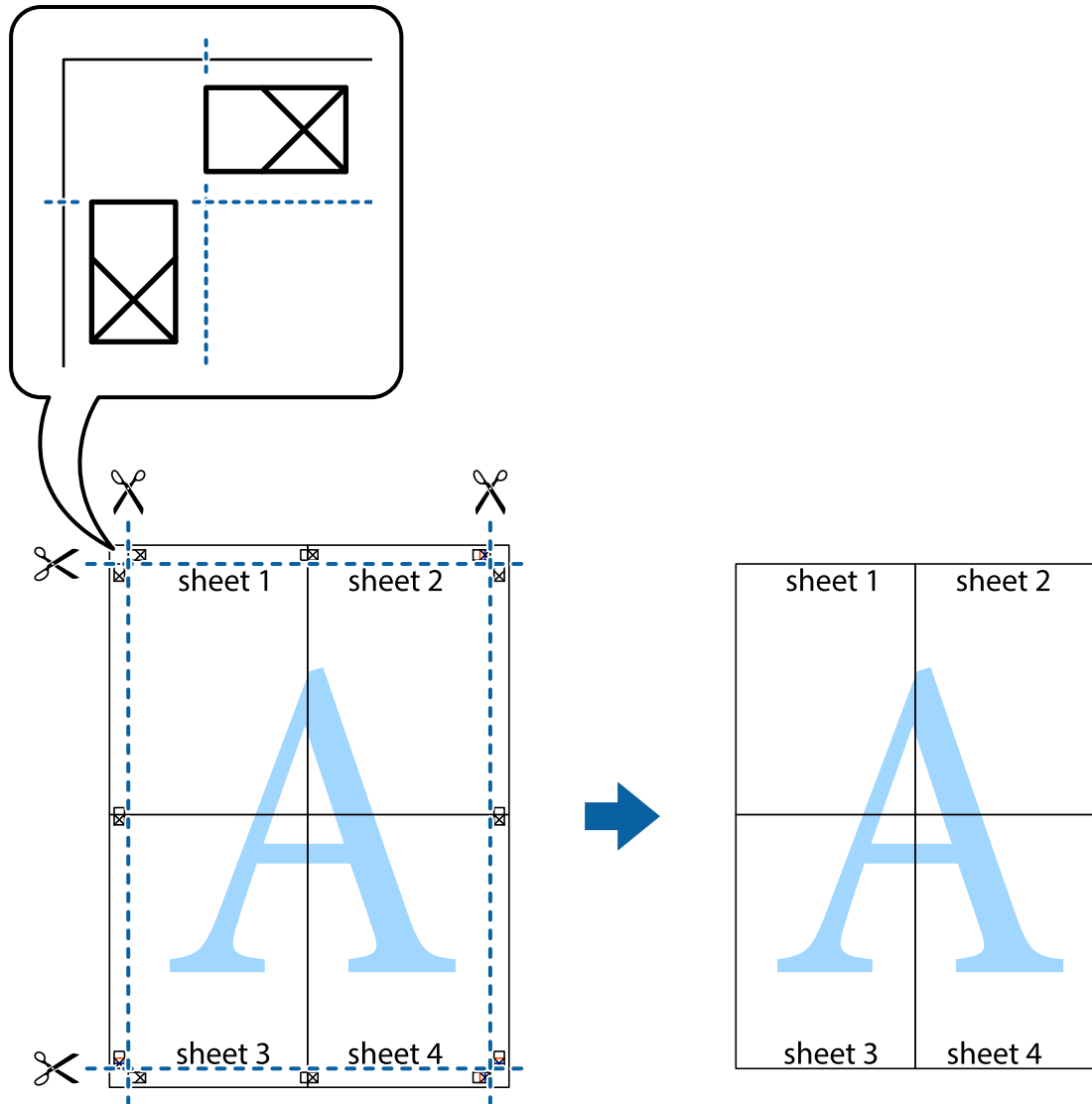

## Printing Using Advanced Features

This section introduces a variety of additional layout and printing features available on the printer driver.

### Related Information

- ➔ [“Windows Printer Driver” on page 87](#)
- ➔ [“Mac OS X Printer Driver” on page 90](#)

## Adding a Printing Preset to Print Easily

If you create your own preset of frequently used print settings on the printer driver, you can print easily by selecting the preset from the list.

## Printing

### Windows

To add your own preset, set items such as the **Document Size** and **Paper Type** on the **Main** or **More Options** tab, and then click **Add/Remove Presets** in **Printing Presets**.

**Note:**

To delete an added preset, click **Add/Remove Presets**, select the preset name you want to delete from the list, and then delete it.

### Mac OS X

Access the print dialog. To add your own preset, set items such as the **Paper Size** and **Media Type**, and then save the current settings as the preset in the **Presets** setting.

**Note:**

To delete an added preset, click **Presets > Show Presets**, select the preset name you want to delete from the list, and then delete it.

## Printing a Reduced or Enlarged Document

You can reduce or enlarge the size of a document by a specific percentage.

### Windows

**Note:**

This feature is not available for borderless printing.

Set the **Document Size** on the **More Options** tab. Select **Reduce/Enlarge Document**, **Zoom to**, and then enter a percentage.

### Mac OS X

**Note:**

Operations differ depending on the application. See the application's help for details.

Select **Page Setup** (or **Print**) from the **File** menu. Select the printer from **Format For**, select the paper size, and then enter a percentage in **Scale**. Close the window, and then print following the basic printing instructions.

## Adjusting the Print Color

You can adjust the colors used in the print job.

**PhotoEnhance** produces sharper images and more vivid colors by automatically adjusting the contrast, saturation, and brightness of the original image data.

**Note:**

These adjustments are not applied to the original data.

**PhotoEnhance** adjusts the color by analyzing the location of the subject. Therefore, if you have changed the location of the subject by reducing, enlarging, cropping, or rotating the image, the color may change unexpectedly. Selecting the borderless setting also changes the location of the subject resulting in changes in color. If the image is out of focus, the tone may be unnatural. If the color is changed or becomes unnatural, print in a mode other than **PhotoEnhance**.

### Windows

Select the method of color correction from **Color Correction** on the **More Options** tab.

If you select **Automatic**, the colors are automatically adjusted to match the paper type and print quality settings. If you select **Custom** and click **Advanced**, you can make your own settings.

## Printing

### Mac OS X

Access the print dialog. Select **Color Matching** from the pop-up menu, and then select **EPSON Color Controls**. Select **Color Options** from the pop-up menu, and then select one of the available options. Click the arrow next to **Advanced Settings** and make the appropriate settings.

### Printing a Watermark (for Windows Only)

You can print a watermark such as "Confidential" on your printouts. You can also add your own watermark.

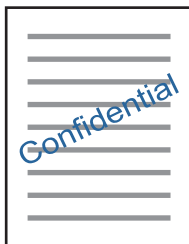

**Note:**

*This feature is not available with borderless printing.*

Click **Watermark Features** on the **More Options** tab, and then select a watermark. Click **Settings** to change details such as the density and position of the watermark.

### Printing a Header and Footer (for Windows Only)

You can print information such as a user name and printing date as headers or footers.

Click **Watermark Features** in the **More Options** tab, and then select **Header/Footer**. Click **Settings** and select necessary items from the drop-down list.

## Printing Photos Using Epson Easy Photo Print

Epson Easy Photo Print lets you lay out and print photos easily on various types of paper. See the application's help for details.

**Note:**

- By printing on genuine Epson photo paper, the ink quality is maximized and the printouts are vivid and clear.*
- To perform borderless printing using a commercially available application, make the following settings.*
  - Create the image data to fully fit the paper size and if a margin setting is available in the application you are using, set the margin to 0 mm.*
  - Enable the borderless printing setting in the printer driver.*

### Related Information

- ➔ ["Epson Easy Photo Print" on page 94](#)
- ➔ ["Installing Applications" on page 97](#)

---

## Printing from Smart Devices

### Using Epson iPrint

Epson iPrint is an application that allows you to print photos, documents, and web pages from a smart device such as a smartphone or tablet. You can use local print, printing from a smart device that is connected to the same wireless network as your printer, or remote print, printing from a remote location over the Internet. To use remote print, register your printer in the Epson Connect service.



#### Related Information

➔ [“Epson Connect Service” on page 85](#)

### Installing Epson iPrint

You can install Epson iPrint on your smart device from the following URL or QR code.

<http://ipr.to/a>



### Printing Using Epson iPrint

Start Epson iPrint from your smart device and select the item you want to use from the home screen.

## Printing

The following screens are subject to change without notice.

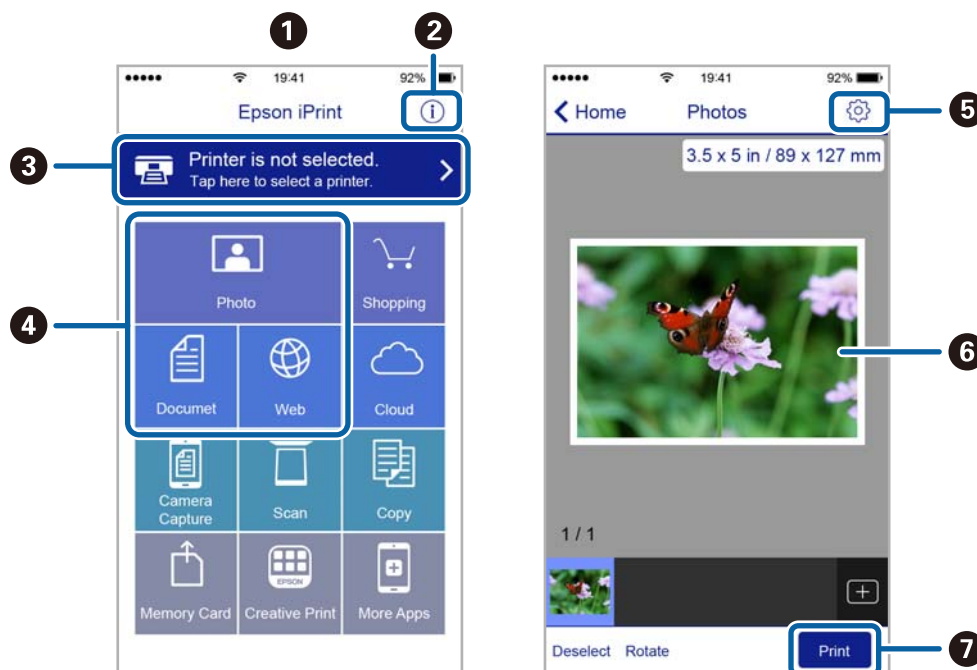

1	Home screen displayed when the application is started.
2	Displays information on how to setup the printer and a FAQ.
3	Displays the screen where you can select the printer and make printer settings. Once you have selected the printer, you do not need to select it again from the next time.
4	Select what you want to print such as photos, documents, and web pages.
5	Displays the screen to make print settings such as paper size and paper type.
6	Displays photos and documents you selected.
7	Starts printing.

### Note:

To print from the document menu using iPhone, iPad, and iPod touch running iOS, start Epson iPrint after transferring the document you want to print using the file sharing function in iTunes.

## Canceling Printing

### Note:

- ❑ In Windows, you cannot cancel a print job from the computer once it has been completely sent to the printer. In this case, cancel the print job by using the printer's control panel.
- ❑ When printing several pages from Mac OS X, you cannot cancel all of the jobs by using the control panel. In this case, cancel the print job from the computer.
- ❑ If you have sent a print job from Mac OS X v10.6.8 through the network, you may not be able to cancel printing from the computer. In this case, cancel the print job by using the printer's control panel.

## Canceling Printing - Printer Button

Press the  button to cancel the print job in progress.

## Canceling Printing - Windows

1. Access the printer driver window.
2. Select the **Maintenance** tab.
3. Click **Print Queue**.
4. Right-click on the job you want to cancel and then select **Cancel**.

### Related Information

➔ [“Windows Printer Driver” on page 87](#)

## Canceling Printing - Mac OS X

1. Click the printer icon in the **Dock**.
2. Select the job you want to cancel.
3. Cancel the job.
  - Mac OS X v10.8.x or later  
Click  next to the progress meter.
  - Mac OS X v10.6.8 to v10.7.x  
Click **Delete**.

# Copying



## Copying Basics

You can copy on A4-size paper at the same magnification. Margins with a width of 3 mm appear around the edges of the paper regardless of whether or not the original has margins around the edges of the paper. When copying originals smaller than A4-size, margins will be wider than 3 mm depending on the position where you place the original.

1. Load A4-size paper in the printer.
2. Place the originals.

3. Press the  or  button.

**Note:**

- Press the  and the  or  buttons simultaneously to copy in draft mode, where you can use less ink and print at a lower density.

*For users in Western Europe, the draft mode is not available.*



- The color, size, and border of the copied image are slightly different from the original.

### Related Information

- ➔ [“Loading Paper in the Rear Paper Feed” on page 30](#)
- ➔ [“Placing Originals on the Scanner Glass” on page 34](#)

## Making Multiple Copies

You can make multiple copies at a time. You can specify up to 20 copies. Margins with a width of 3 mm appear around the edges of the paper.

1. Load the same number of sheets of A4-size paper as the number of copies you want to copy.
2. Place the originals.
3. Press the  or  button the same number of times as the number of copies you want to make. For example, if you want to make 10 copies in color, press the  button 10 times.

**Note:**

*Press the button within one second to change the number of copies. If the button is pressed after one second, the number of copies is set and copying starts.*

### Related Information

- ➔ [“Loading Paper in the Rear Paper Feed” on page 30](#)
- ➔ [“Placing Originals on the Scanner Glass” on page 34](#)



# Scanning



---

## Scanning from the Control Panel

You can save the scanned image in PDF format to a computer which is connected to the printer with a USB cable.

**Important:**

*Make sure you have installed Epson Scan 2 and Epson Event Manager on your computer before using this feature.*

1. Place the originals.
2. Press the  button and the  button simultaneously.

**Note:**

- You can change the scan settings such as the scanning size, folder to save, or save format, by using Epson Event Manager.
- The color, size, and border of the scanned image will not be exactly the same as the original.

**Related Information**

- ➔ [“Placing Originals on the Scanner Glass” on page 34](#)
- ➔ [“Epson Event Manager” on page 93](#)

---

## Scanning from a Computer

### Scanning Using Epson Scan 2

You can scan by using the scanner driver "Epson Scan 2". See the Epson Scan 2 help for an explanation of each setting item.

**Related Information**

- ➔ [“Epson Scan 2 \(Scanner Driver\)” on page 93](#)

### Scanning Documents (Document Mode)

Using **Document Mode** in Epson Scan 2, you can scan originals using detailed settings that are suitable for text documents.

1. Place the originals.
2. Start Epson Scan 2.
3. Select **Document Mode** from the **Mode** list.

## Scanning

4. Make the following settings on the **Main Settings** tab.

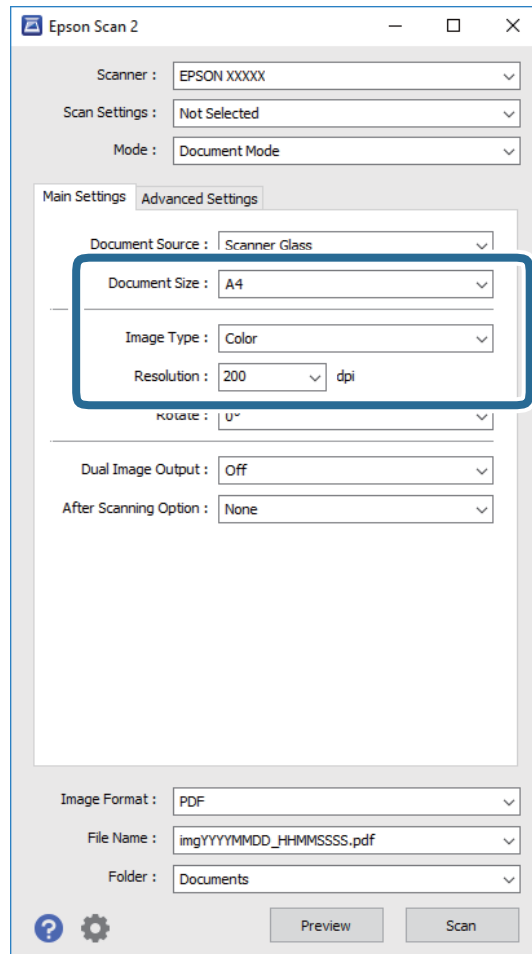

- ❑ **Document Size:** Select the size of the original you placed.
- ❑ **Image Type:** Select the color for saving the scanned image.
- ❑ **Resolution:** Select the resolution.

**Note:**

The **Document Source** setting is fixed as **Scanner Glass**. You cannot change this setting.

5. Make other scan settings if necessary.

- ❑ You can preview the scanned image by clicking the **Preview** button. The preview window opens, and the previewed image is displayed.
- ❑ On the **Advanced Settings** tab, you can make detailed image adjustment settings that are suitable for text documents, such as the following.
  - ❑ **Unsharp Mask:** You can enhance and sharpen the outlines of the image.
  - ❑ **Descreening:** You can remove moiré patterns (web-like shadows) that appear when scanning printed papers such as a magazine.
  - ❑ **Text Enhancement:** You can make blurred letters in the original clear and sharp.
  - ❑ **Auto Area Segmentation:** You can make letters clear and images smooth when performing black and white scanning for a document that contains images.

**Note:**

The items may not be available depending on other settings you made.

## Scanning

6. Set the file saving settings.

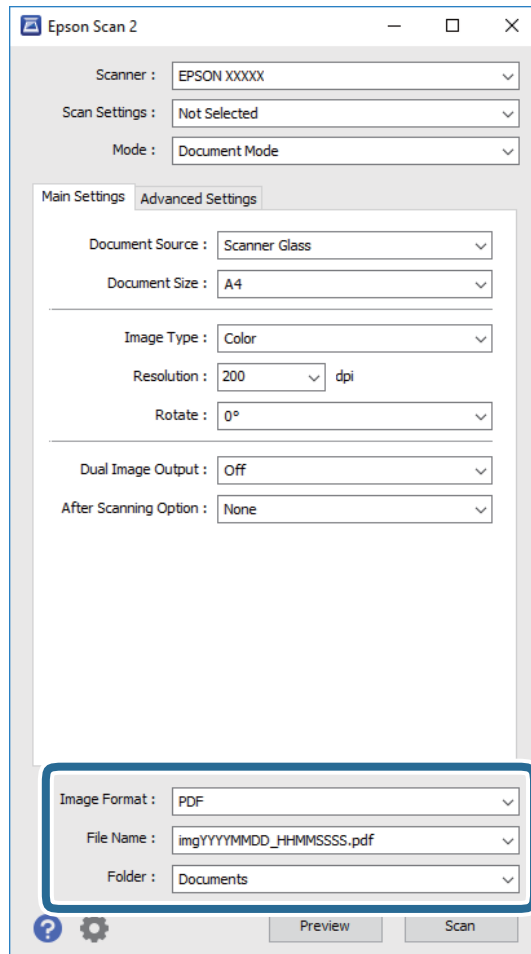

- ❑ **Image Format:** Select the save format from the list.

You can make detailed settings for each save format except BITMAP and PNG. Select **Options** from the list after selecting the save format.

- ❑ **File Name:** Confirm the save file name displayed.

You can change settings for the file name by selecting **Settings** from the list.

- ❑ **Folder:** Select the save folder for the scanned image from the list.

You can select another folder or create a new folder by selecting **Select** from the list.

7. Click **Scan**.

### Related Information

- ➔ [“Placing Originals on the Scanner Glass” on page 34](#)

## Scanning Photos or Pictures (Photo Mode)

Using **Photo Mode** in Epson Scan 2, you can scan originals with wide variety of image adjustment features that are suitable for photos or pictures.

## Scanning

1. Place the originals.

By placing multiple originals on the scanner glass, you can scan them all at the same time. Make sure there is a gap of at least 20 mm between the originals.

2. Start Epson Scan 2.
3. Select **Photo Mode** from the **Mode** list.
4. Make the following settings on the **Main Settings** tab.

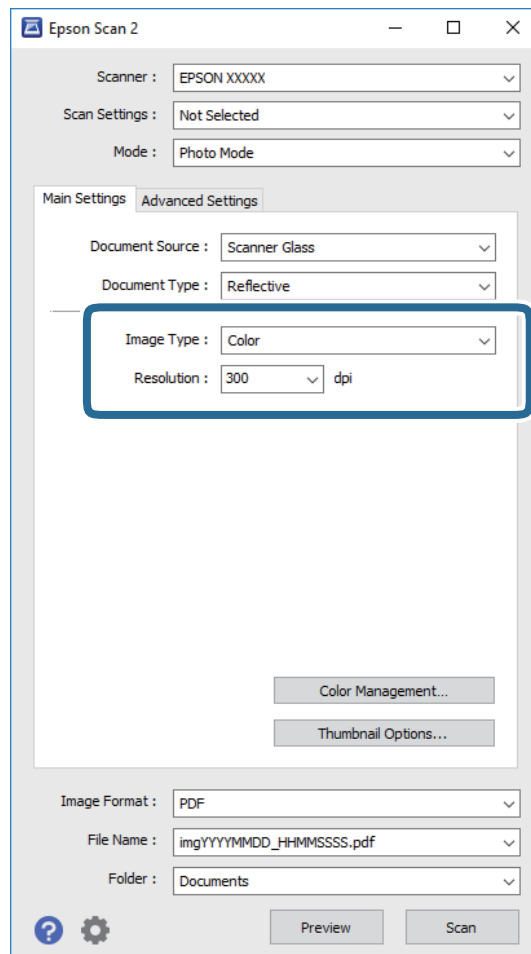

❑ **Image Type:** Select the color for saving the scanned image.

❑ **Resolution:** Select the resolution.

**Note:**

The **Document Source** setting is fixed as **Scanner Glass**, and the **Document Type** setting is fixed as **Reflective**. (**Reflective** means originals which are not transparent, for example ordinary papers or photos.) You cannot change these settings.

## Scanning

- Click **Preview**.

The preview window opens, and the previewed images are displayed as thumbnails.

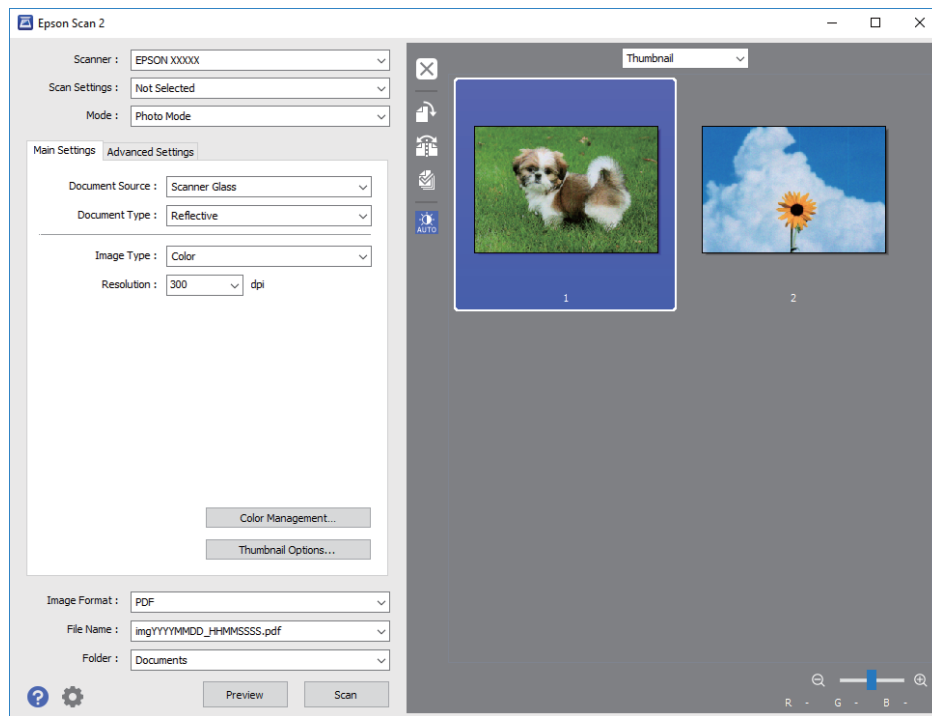

**Note:**

To preview the entire scanned area, select **Normal** from the list at the top of the preview widow.

- Confirm the preview, and make image adjustment settings on the **Advanced Settings** tab if necessary.

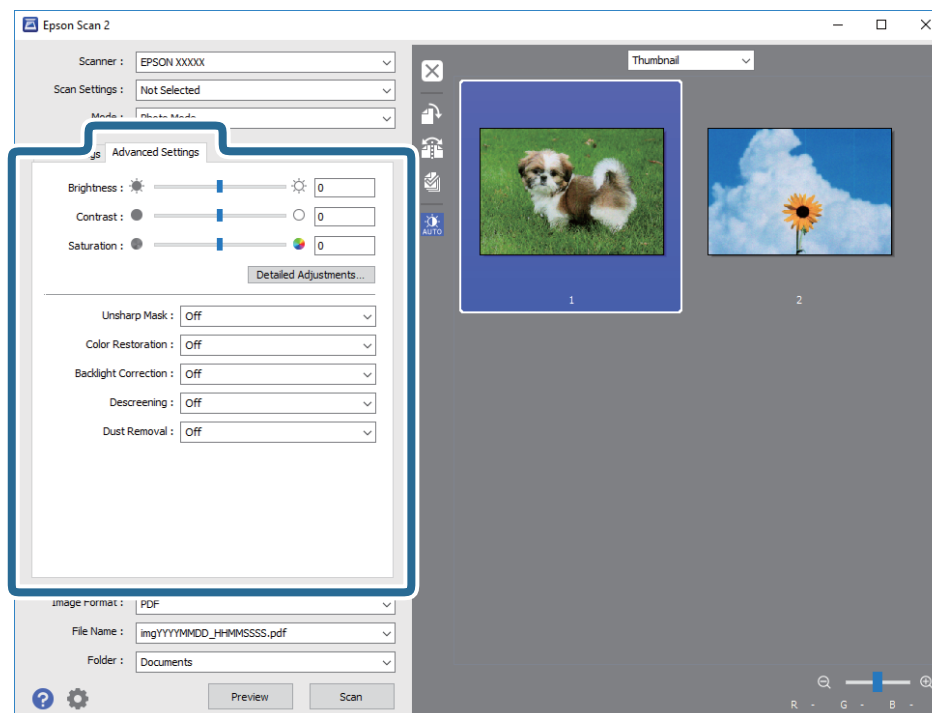

## Scanning

You can adjust the scanned image using detailed settings that are suitable for photos or pictures, such as the following.

- Brightness:** You can adjust the brightness for the scanned image.
- Contrast:** You can adjust the contrast for the scanned image.
- Saturation:** You can adjust the saturation (color vividness) for the scanned image.
- Unsharp Mask:** You can enhance and sharpen the outlines of the scanned image.
- Color Restoration:** You can correct images that have faded to return them to their original colors.
- Backlight Correction:** You can lighten scanned images that are dark due to backlight.
- Descreening:** You can remove moiré patterns (web-like shadows) that appear when scanning printed papers such as a magazine.
- Dust Removal:** You can remove dust on the scanned image.

**Note:**

- The items may not be available depending on other settings you made.*
- Depending on the original, the scanned image may not be adjusted correctly.*
- When multiple thumbnails are created, you can adjust the image quality for each thumbnail. Depending on the adjustment items, you can adjust the quality of scanned images all together by selecting multiple thumbnails.*

7. Set the file saving settings.

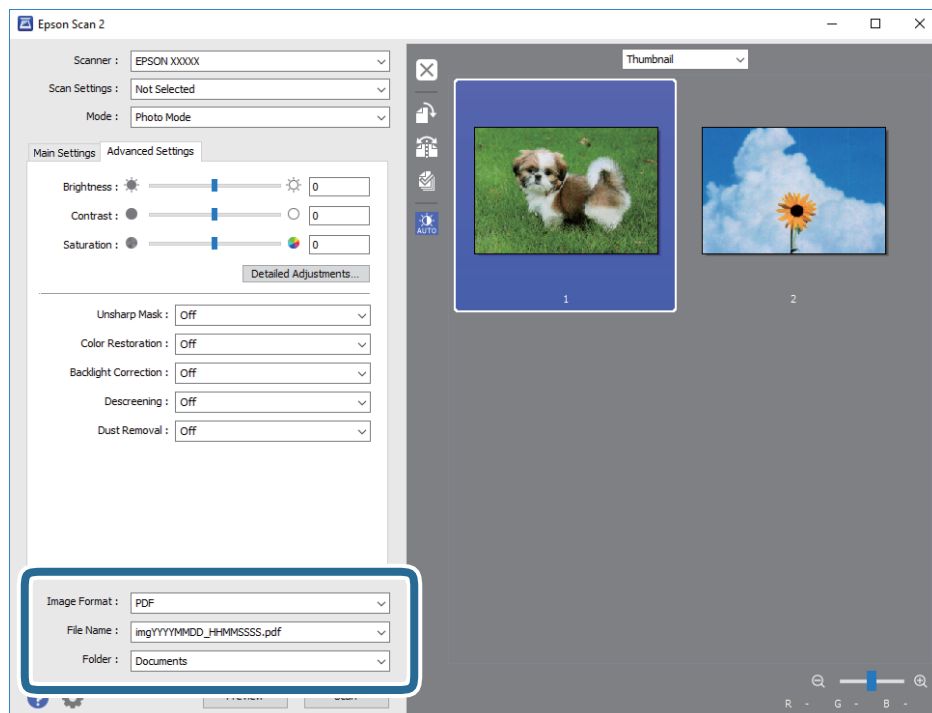

- Image Format:** Select the save format from the list.  
You can make detailed settings for each save format except BITMAP and PNG. Select **Options** from the list after selecting the save format.
- File Name:** Confirm the save file name displayed.  
You can change settings for the file name by selecting **Settings** from the list.
- Folder:** Select the save folder for the scanned image from the list.

## Scanning

You can select another folder or create a new folder by selecting **Select** from the list.

8. Click **Scan**.

### Related Information

- ➔ “Placing Originals on the Scanner Glass” on page 34
- ➔ “Placing Multiple Photos for Scanning” on page 35

---

## Scanning from Smart Devices

Epson iPrint is an application that allows you to scan photos and documents from a smart device, such as a smartphone or tablet, that is connected to the same wireless network as your printer. You can save the scanned data on a smart device or to Cloud services, send it by email, or print it.



### Installing Epson iPrint

You can install Epson iPrint on your smart device from the following URL or QR code.

<http://ipr.to/a>



### Scanning Using Epson iPrint

Start Epson iPrint from your smart device and select the item you want to use from the home screen.

## Scanning

The following screens are subject to change without notice.

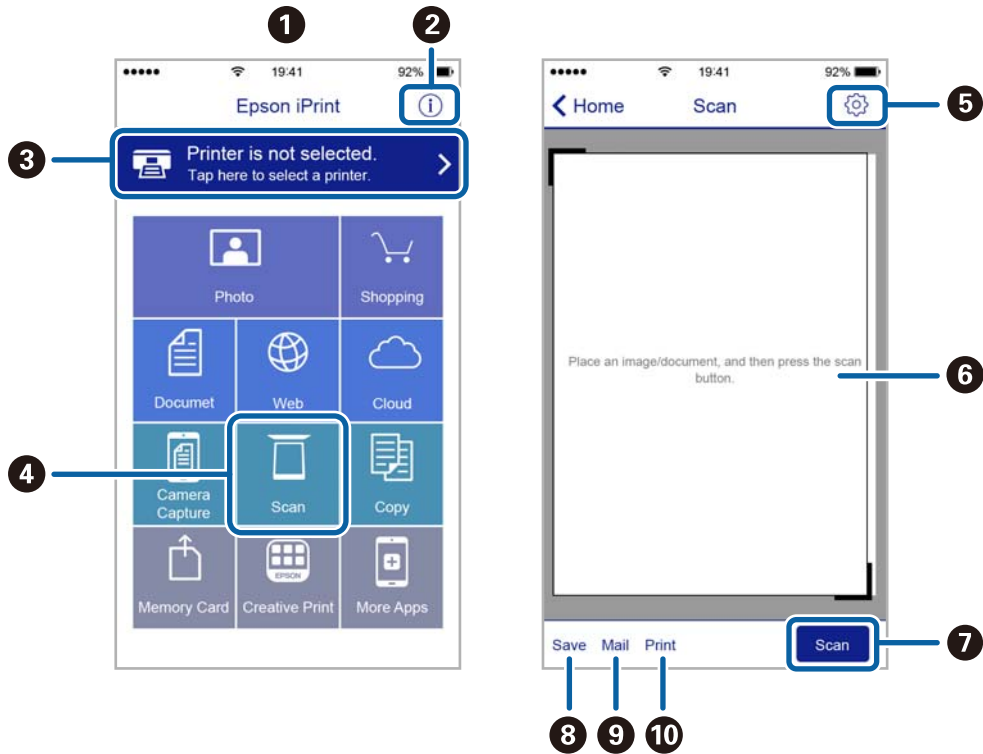

1	Home screen displayed when the application is started.
2	Displays information on how to setup the printer and a FAQ.
3	Displays the screen where you can select the printer and make printer settings. Once you have selected the printer, you do not need to select it again from the next time.
4	Displays the scanning screen.
5	Displays the screen where you can make scan settings such as resolution.
6	Displays scanned images.
7	Starts scanning.
8	Displays the screen where you can save scanned data to a smart device or Cloud services.
9	Displays the screen where you can send scanned data by email.
10	Displays the screen where you can print scanned data.



# Replacing Ink Cartridges

## Checking the Ink Levels

You can check the approximate ink levels from the computer.

### Checking the Ink Levels - Windows

1. Access the printer driver window.
2. Click **Ink Levels** on the **Main** tab.

**Note:**

If **EPSON Status Monitor 3** is disabled, the ink levels are not displayed. Click **Extended Settings** on the **Maintenance** tab, and then select **Enable EPSON Status Monitor 3**.

#### Related Information

➔ [“Windows Printer Driver” on page 87](#)

### Checking the Ink Levels - Mac OS X

1. Select **System Preferences** from the  menu > **Printers & Scanners** (or **Print & Scan, Print & Fax**), and then select the printer.
2. Click **Options & Supplies** > **Utility** > **Open Printer Utility**.
3. Click **EPSON Status Monitor**.

## Ink Cartridge Codes

Epson recommends the use of genuine Epson ink cartridges. Epson cannot guarantee the quality or reliability of non-genuine ink. The use of non-genuine ink may cause damage that is not covered by Epson's warranties, and under certain circumstances, may cause erratic printer behavior. Information about non-genuine ink levels may not be displayed.

The following are the codes for genuine Epson ink cartridges.

Product	Icon	BK: Black	C: Cyan	M: Magenta	Y: Yellow
XP-245, XP-247	Strawberry 	29 29XL*	29 29XL*	29 29XL*	29 29XL*

## Replacing Ink Cartridges

Product	Icon	BK: Black	C: Cyan	M: Magenta	Y: Yellow
XP-243	Cherries 	36 36XL*	36 36XL*	36 36XL*	36 36XL*

\* "XL" indicates a large cartridge.

For Australia

BK: Black	C: Cyan	M: Magenta	Y: Yellow
29 29XL*	29 29XL*	29 29XL*	29 29XL*

\* "XL" indicates a large cartridge.

For Singapore, Hong Kong, Taiwan, and Korea

BK: Black	C: Cyan	M: Magenta	Y: Yellow
364	364	364	364

### Note:

- Not all cartridges are available in all regions.
- Ink cartridge codes may vary by location. For the correct codes in your area, contact Epson support.
- For users in Europe, visit the following website for information on Epson's ink cartridge yields.  
<http://www.epson.eu/pageyield>

### Related Information

- ➔ ["Technical Support Web Site" on page 131](#)

---

## Ink Cartridge Handling Precautions

Read the following instructions before replacing ink cartridges.

### Handling precautions

- Store ink cartridges at normal room temperature and keep them away from direct sunlight.
- Epson recommends using the ink cartridge before the date printed on the package.
- For best results, use up ink cartridge within six months of opening the package.
- For best results, store ink cartridge packages with their bottom down.
- After bringing an ink cartridge inside from a cold storage site, allow it to warm up at room temperature for at least three hours before using it.

## Replacing Ink Cartridges

- ❑ Do not open the ink cartridge package until you are ready to install it in the printer. The cartridge is vacuum packed to maintain its reliability. If you leave a cartridge unpacked for a long time before using it, normal printing may not be possible.
- ❑ Be careful not to break the hooks on the side of the ink cartridge when you remove it from the package.
- ❑ You must remove the yellow tape from the cartridge before installing it; otherwise, print quality may decline or you may not be able to print. Do not remove or tear the label on the cartridge; this can cause leakage.



- ❑ Do not remove the transparent seal from the bottom of the cartridge; otherwise, the cartridge may become unusable.



- ❑ Do not touch the sections shown in the illustration. Doing so may prevent normal operation and printing.

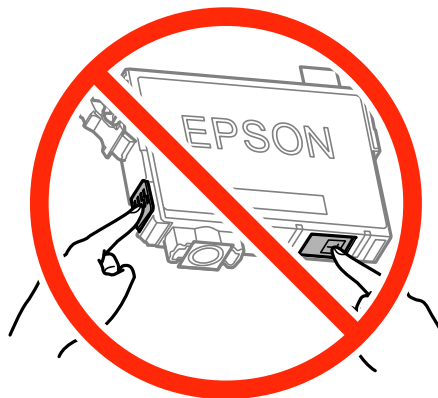

- ❑ Install all ink cartridges; otherwise you cannot print.

## Replacing Ink Cartridges

- ❑ Do not replace ink cartridges with the power off. Do not move the print head by hand; otherwise, you may damage the printer.
- ❑ After installing the ink cartridge, the power light continues to flash while the printer is charging ink. Do not turn off the printer during ink charging. If the ink charging is incomplete, you may not be able to print.
- ❑ Do not leave the printer with the ink cartridges removed or do not turn off the printer during cartridge replacement. Otherwise, ink remaining in the print head nozzles will dry out and you may not be able to print.
- ❑ If you need to remove an ink cartridge temporarily, make sure you protect the ink supply area from dirt and dust. Store the ink cartridge in the same environment as the printer, with the ink supply port facing down or sideways. Do not store ink cartridges with the ink supply port facing up. Because the ink supply port is equipped with a valve designed to contain the release of excess ink, there is no need to supply your own covers or plugs.
- ❑ Removed ink cartridges may have ink around the ink supply port, so be careful not to get any ink on the surrounding area when removing the cartridges.
- ❑ This printer uses ink cartridges equipped with a green chip that monitors information such as the amount of remaining ink for each cartridge. This means that even if the cartridge is removed from the printer before it is expended, you can still use the cartridge after reinserting it back into the printer. However, when reinserting a cartridge, some ink may be consumed to guarantee printer performance.
- ❑ For maximum ink efficiency, only remove an ink cartridge when you are ready to replace it. Ink cartridges with low ink status may not be used when reinserted.
- ❑ To ensure you receive premium print quality and to help protect your print head, a variable ink safety reserve remains in the cartridge when your printer indicates to replace the cartridge. The yields quoted for you do not include this reserve.
- ❑ Although the ink cartridges may contain recycled materials, this does not affect printer function or performance.
- ❑ Specifications and appearance of the ink cartridge are subject to change without prior notice for improvement.
- ❑ Do not disassemble or remodel the ink cartridge, otherwise you may not be able to print normally.
- ❑ You cannot use the cartridges that came with the printer for the replacement.
- ❑ Quoted yields may vary depending on the images that you are printing, the paper type that you are using, the frequency of your prints and environmental conditions such as temperature.

### Ink consumption

- ❑ To maintain optimum print head performance, some ink is consumed from all cartridges not only during printing but also during maintenance operations such as ink cartridge replacement and print head cleaning.
- ❑ When printing in monochrome or grayscale, color inks instead of black ink may be used depending on the paper type or print quality settings. This is because a mixture of color inks is used to create black.
- ❑ The ink in the ink cartridges supplied with your printer is partly used during initial setup. In order to produce high quality printouts, the print head in your printer will be fully charged with ink. This one-off process consumes a quantity of ink and therefore these cartridges may print fewer pages compared to subsequent ink cartridges.



## Replacing Ink Cartridges

## Replacing Ink Cartridges (When Ink Light is On or Flashing)

**Caution:**

Be careful not to trap your hand or fingers when opening or closing the scanner unit. Otherwise you may be injured.

**Note:**

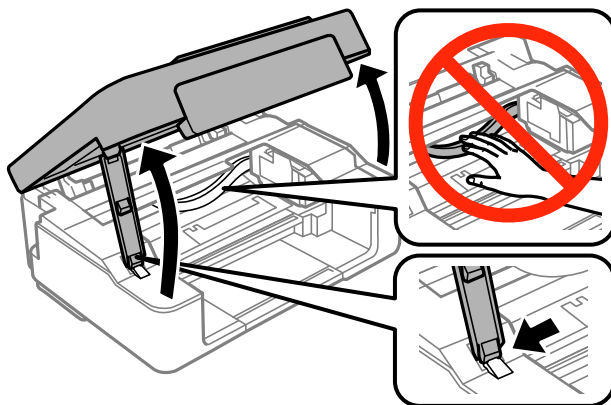

- ❑ You can continue printing while the  (ink) light is flashing. However, prepare new ink cartridges as soon as possible.
- ❑ If you replace the ink cartridges while copying, the originals may move out of place. Press the  button to cancel and replace the originals.

1. Open the scanner unit with the document cover closed.





2. Operate the printer's buttons to move the ink cartridge holder.

**Note:**

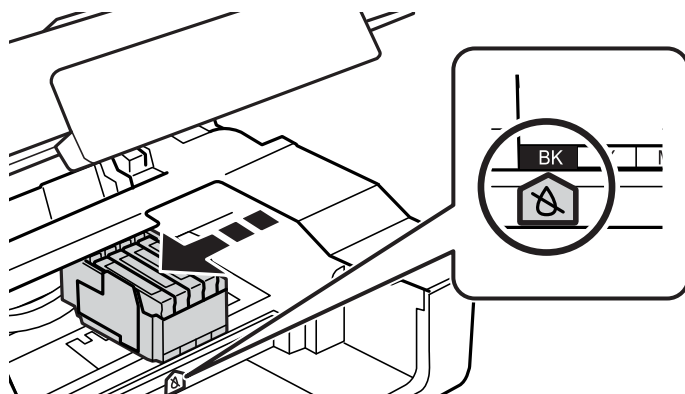
Replace the cartridge that stops at the  icon. If there are more expended ink cartridges, the cartridge moves to the  icon every time you press the  button.





- ❑ If the  light is on (one or more ink cartridges are expended)

Press the  button. The ink cartridge holder moves to the  icon. You cannot replace cartridges in this position. Go to the next step.

- ❑ If the  light flashes (one or more ink cartridges are running low)

## Replacing Ink Cartridges

Hold the  button down until the ink cartridge holder moves to the  icon. You cannot replace cartridges in this position. Go to the next step.

**Note:**

To cancel ink cartridge replacement, keep the ink cartridges installed and turn off the printer.

3. Press the  button again.

The ink cartridge holder moves to the replacement position.

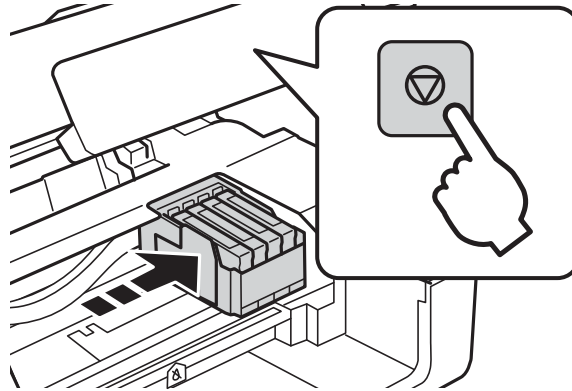

4. When replacing the black ink cartridge, gently shake the new black ink cartridge four or five times and then remove it from its package. When replacing other color cartridges, remove the new color cartridges from their package without shaking.

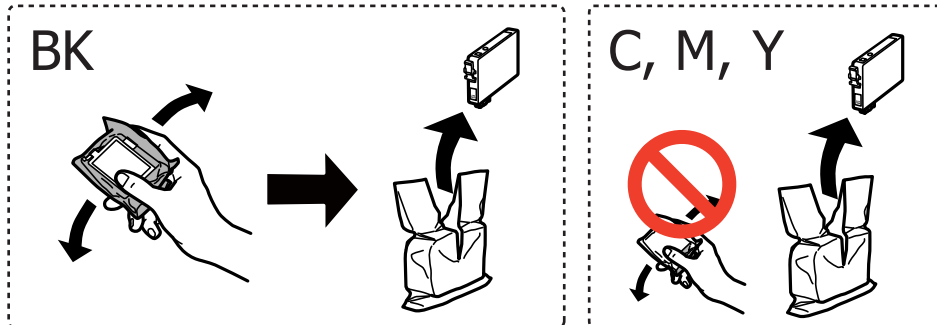

**Important:**

Do not shake cartridges after opening the package, as they may leak.

## Replacing Ink Cartridges

5. Remove only the yellow tape.

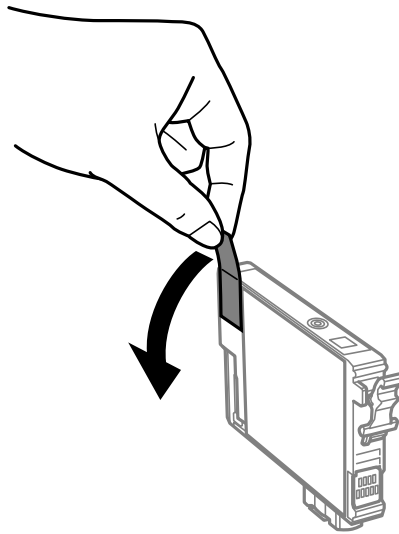

**!** *Important:*

*Do not touch the sections shown in the illustration. Doing so may prevent normal operation and printing.*

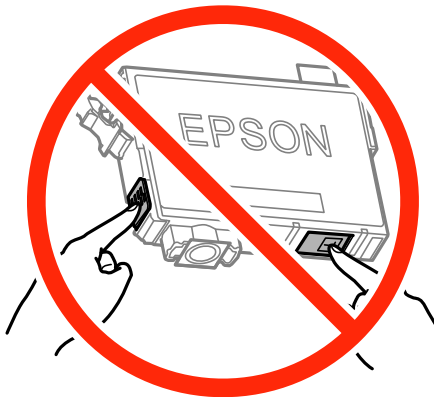

6. Squeeze the tab on the ink cartridge and pull it straight up. If you cannot remove the ink cartridge, pull it firmly.

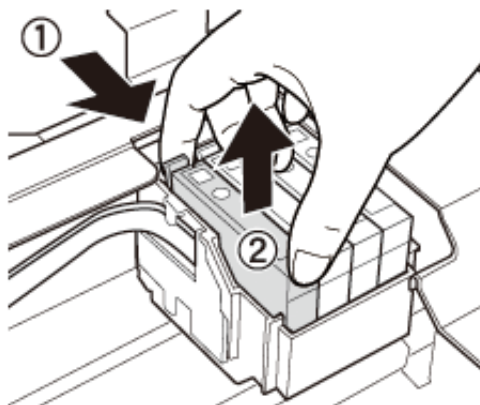

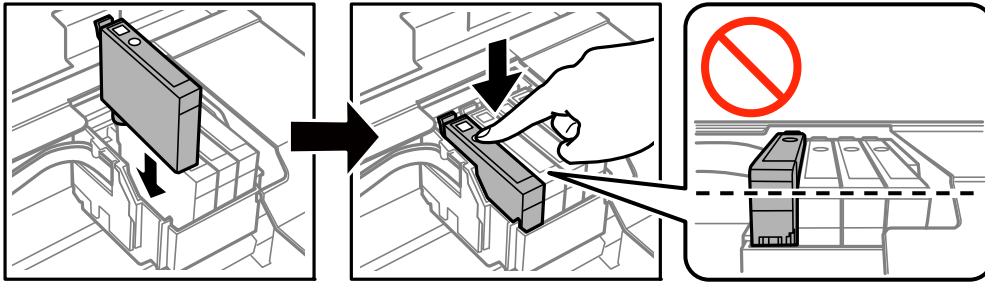

## Replacing Ink Cartridges

7. Insert the new ink cartridge, and then press it down firmly.

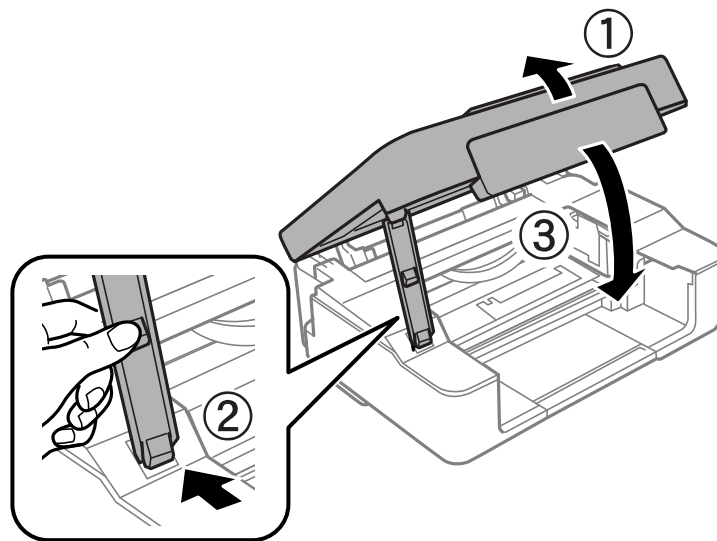

8. Close the scanner unit.



9. Press the  button.

Ink charging starts.



**Important:**

After installing the ink cartridge, the power light continues to flash while the printer is charging ink. Do not turn off the printer during ink charging. Charging takes approximately two minutes. If the ink charging is incomplete, you may not be able to print.

**Note:**

If the  light does not turn off, try removing and reinserting the ink cartridge.

### Related Information

- ➔ [“Ink Cartridge Codes” on page 65](#)
- ➔ [“Ink Cartridge Handling Precautions” on page 66](#)

---

## Replacing Ink Cartridges (When Ink Light is Off)

You can replace cartridges even if there is still ink in the cartridge.





## Replacing Ink Cartridges

 **Caution:**

*Be careful not to trap your hand or fingers when opening or closing the scanner unit. Otherwise you may be injured.*

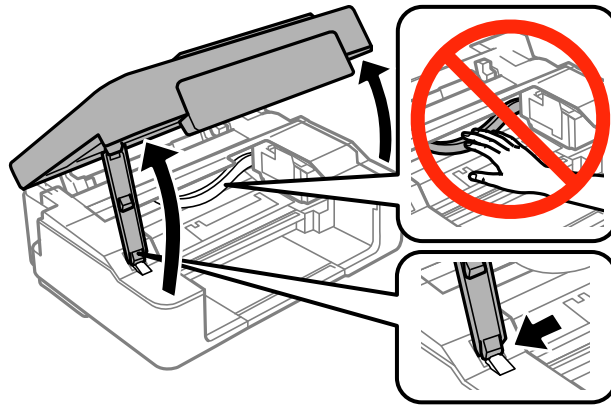
1. Open the scanner unit with the document cover closed.



2. Hold down the  button until the ink cartridge holder starts moving.

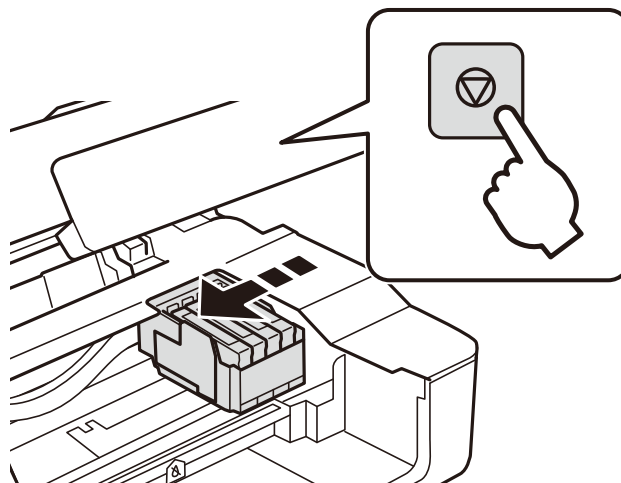

The ink cartridge holder moves to the replacement position.

**Note:**

*To cancel ink cartridge replacement, keep the ink cartridges installed and turn off the printer.*

## Replacing Ink Cartridges

- When replacing the black ink cartridge, gently shake the new black ink cartridge four or five times and then remove it from its package. When replacing other color cartridges, remove the new color cartridges from their package without shaking.

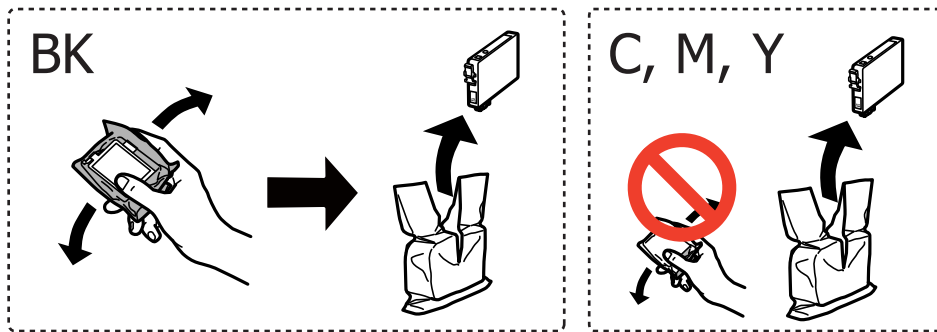

**!** **Important:**

*Do not shake cartridges after opening the package, as they may leak.*

- Remove only the yellow tape.

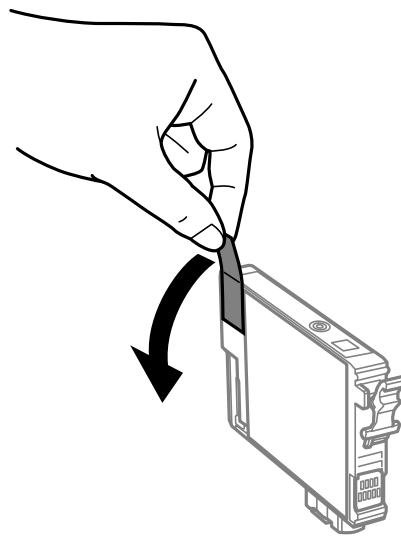

## Replacing Ink Cartridges

**!** *Important:*

*Do not touch the sections shown in the illustration. Doing so may prevent normal operation and printing.*

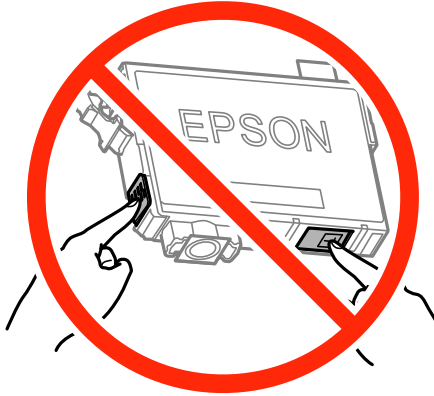

5. Squeeze the tab on the ink cartridge and pull it straight up. If you cannot remove the ink cartridge, pull it firmly

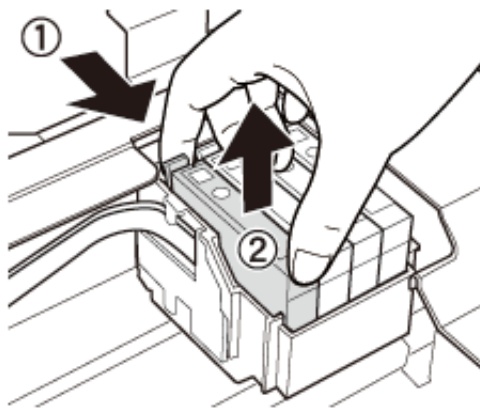

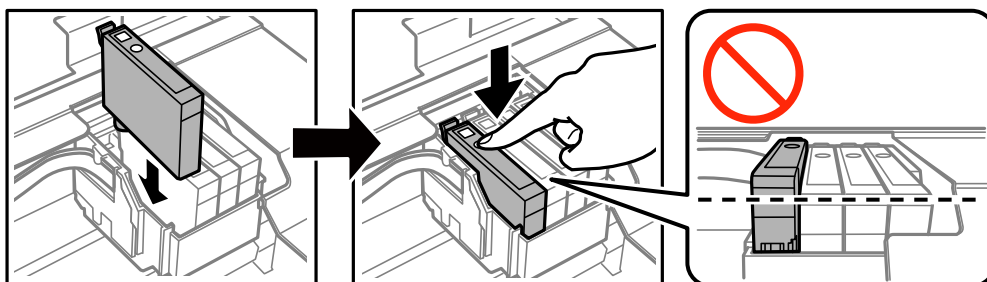

6. Insert the new ink cartridge, and then press it down firmly.

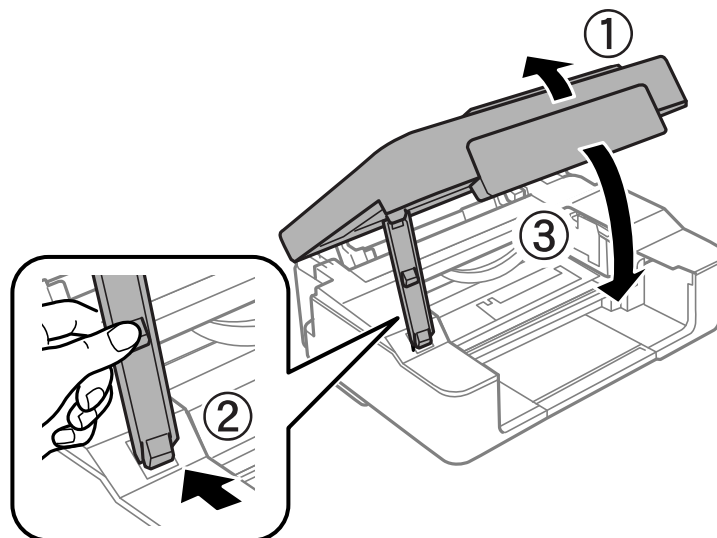

## Replacing Ink Cartridges

7. Close the scanner unit.



8. Press the  button.

Ink charging starts.



**Important:**

After installing the ink cartridge, the power light continues to flash while the printer is charging ink. Do not turn off the printer during ink charging. Charging takes approximately two minutes. If the ink charging is incomplete, you may not be able to print.

**Note:**

If the  light does not turn off, try removing and reinserting the ink cartridge.

### Related Information

- ➔ [“Ink Cartridge Codes” on page 65](#)
- ➔ [“Ink Cartridge Handling Precautions” on page 66](#)

---

## Temporarily Printing with Black Ink

When color ink is expended and black ink still remains when printing from a computer, you can use the following settings to continue printing for a short time using only black ink.

- Type of paper: plain papers, Envelope
- Color: **Grayscale**
- Borderless: Not selected
- EPSON Status Monitor 3: Enabled (for Windows only)

Because this feature is only available for approximately five days, replace the expended ink cartridge as soon as possible.

## Replacing Ink Cartridges

**Note:**

- ❑ If **EPSON Status Monitor 3** is disabled, access the printer driver, click **Extended Settings** on the **Maintenance** tab, and then select **Enable EPSON Status Monitor 3**.
- ❑ The available period varies depending on the usage conditions.

## Temporarily Printing with Black Ink - Windows

1. When the following window is displayed, cancel printing.

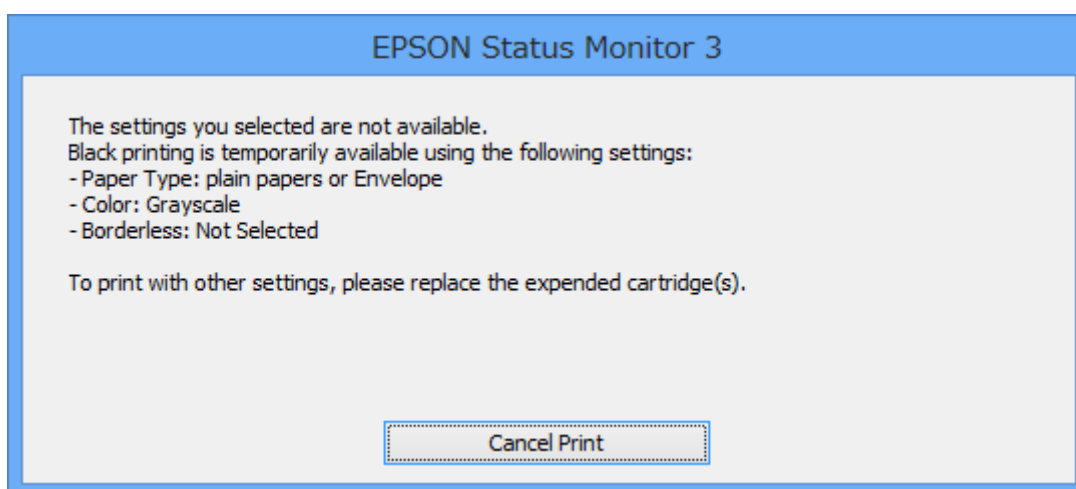
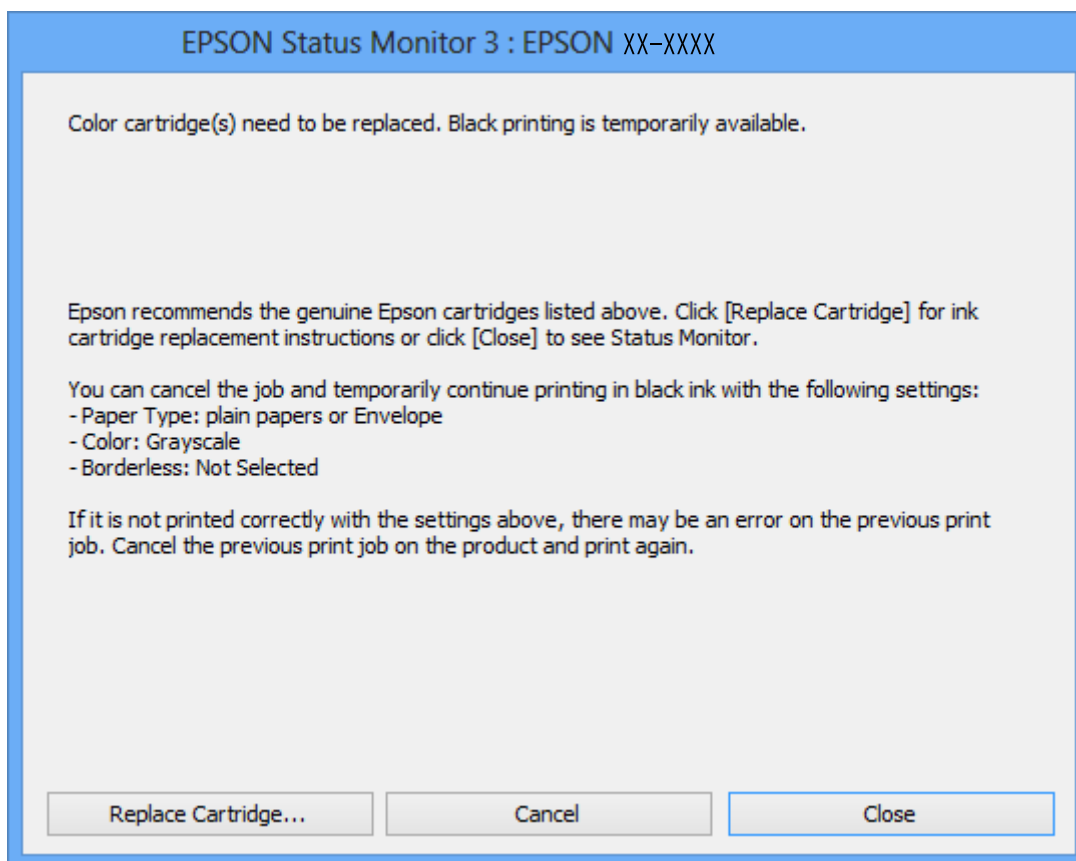
**Note:**

If you cannot cancel printing from the computer, cancel using the printer's control panel.

## Replacing Ink Cartridges

2. Access the printer driver window.
3. Clear **Borderless** on the **Main** tab.
4. Select **plain papers** or **Envelope** as the **Paper Type** setting on the **Main** tab.
5. Select **Grayscale**.
6. Set the other items on the **Main** and **More Options** tabs as necessary, and then click **OK**.
7. Click **Print**.
8. Click **Print in Black** in the window displayed.

### Related Information

- ➔ [“Loading Paper in the Rear Paper Feed” on page 30](#)
- ➔ [“Printing Basics - Windows” on page 36](#)

## Temporarily Printing with Black Ink - Mac OS X

### Note:

To use this feature through a network, connect with **Bonjour**.

1. Click the printer icon in the **Dock**.
2. Cancel the job.

### Note:

If you cannot cancel printing from the computer, cancel using the printer's control panel.

3. Select **System Preferences** from the  menu > **Printers & Scanners** (or **Print & Scan**, **Print & Fax**), and then select the printer. Click **Options & Supplies** > **Options** (or **Driver**).
4. Select **On** as the **Permit temporary black printing** setting.
5. Access the print dialog.
6. Select **Print Settings** from the pop-up menu.
7. Select any paper size except for a borderless size as the **Paper Size** setting.
8. Select **plain papers** or **Envelope** as the **Media Type** setting.
9. Select **Grayscale**.
10. Set the other items as necessary.
11. Click **Print**.

### Related Information

- ➔ [“Canceling Printing” on page 54](#)
- ➔ [“Loading Paper in the Rear Paper Feed” on page 30](#)

## Replacing Ink Cartridges

➔ “Printing Basics - Mac OS X” on page 37

# Conserving Black Ink when the Black Ink Is Low (for Windows Only)

When black ink is running low and there is enough color ink remaining, you can use a mixture of color inks to create black. You can continue printing while preparing a replacement black ink cartridge.

This feature is only available when you select the following settings in the printer driver.

- Paper Type: **plain papers**
- Quality: **Standard**
- EPSON Status Monitor 3: Enabled

**Note:**

- If **EPSON Status Monitor 3** is disabled, access the printer driver, click **Extended Settings** on the **Maintenance** tab, and then select **Enable EPSON Status Monitor 3**.
- Composite black looks slightly different from pure black. In addition, the print speed is reduced.
- To maintain the quality of the print head, black ink is also consumed.

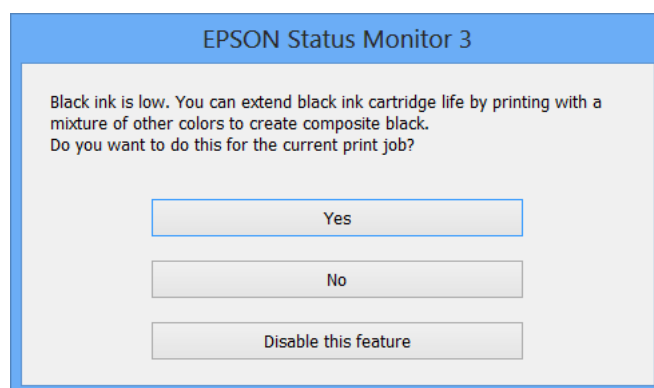

Options	Description
Yes	Select to use a mixture of color inks to create black. This window is displayed the next time you print a similar job.
No	Select to continue using the remaining black ink. This window is displayed the next time you print a similar job.
Disable this feature	Select to continue using the remaining black ink. This window is not displayed until you replace the black ink cartridge and it runs low again.

# Maintaining the Printer



## Checking and Cleaning the Print Head

If the nozzles are clogged, the printouts become faint, there is visible banding, or unexpected colors appear. When print quality has declined, use the nozzle check feature and check if the nozzles are clogged. If the nozzles are clogged, clean the print head.

### **!** Important:

- ❑ Do not open the scanner unit or turn off the printer during head cleaning. If the head cleaning is incomplete, you may not be able to print.
- ❑ Because print head cleaning uses some ink, clean the print head only if quality declines.
- ❑ When ink is low, you may not be able to clean the print head. Replace the ink cartridge first.
- ❑ If print quality has not improved after repeating nozzle check and head cleaning about four times, wait for at least six hours without printing, and then run the nozzle check again and repeat the head cleaning if necessary. We recommend to turn off the printer. If print quality has still not improved, contact Epson support.
- ❑ To prevent the print head from drying out, do not unplug the printer while the power is on.

## Checking and Cleaning the Print Head - Printer Buttons

1. Load A4-size plain paper in the printer.
2. Press the  button to turn off the printer.
3. Turn the printer on while holding the  button down, and then release the buttons when the power light flashes.

The nozzle check pattern is printed.

4. Examine the printed pattern. If there are broken lines or missing segments as shown in the "NG" pattern, the print head nozzles may be clogged. Go to the next step. If you cannot see any broken lines or missing segments as in the following "OK" pattern, the nozzles are not clogged. Print head cleaning is not necessary.

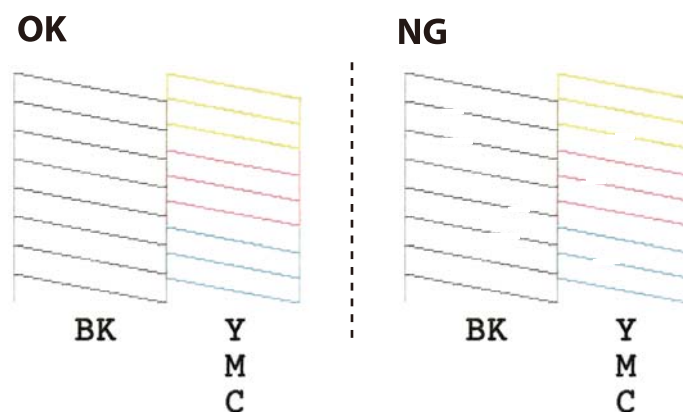



## Maintaining the Printer

5. Hold the  button down for three seconds until the power light starts flashing. Print head cleaning starts.
6. When the power light stops flashing, print a nozzle check pattern again. Repeat cleaning and printing the pattern until all lines are printed completely.

### Related Information

➔ [“Loading Paper in the Rear Paper Feed” on page 30](#)

## Checking and Cleaning the Print Head - Windows

1. Load A4-size plain paper in the printer.
2. Access the printer driver window.
3. Click **Nozzle Check** on the **Maintenance** tab.
4. Follow the on-screen instructions.

### Related Information

➔ [“Loading Paper in the Rear Paper Feed” on page 30](#)

➔ [“Windows Printer Driver” on page 87](#)

## Checking and Cleaning the Print Head - Mac OS X

1. Load A4-size plain paper in the printer.
2. Select **System Preferences** from the  menu > **Printers & Scanners** (or **Print & Scan**, **Print & Fax**), and then select the printer.
3. Click **Options & Supplies** > **Utility** > **Open Printer Utility**.
4. Click **Nozzle Check**.
5. Follow the on-screen instructions.

### Related Information

➔ [“Loading Paper in the Rear Paper Feed” on page 30](#)

---

## Aligning the Print Head

If you notice a misalignment of vertical lines or blurred images, align the print head.

## Aligning the Print Head - Windows

1. Load A4-size plain paper in the printer.
2. Access the printer driver window.
3. Click **Print Head Alignment** on the **Maintenance** tab.
4. Follow the on-screen instructions.

### Related Information

- ➔ [“Loading Paper in the Rear Paper Feed” on page 30](#)
- ➔ [“Windows Printer Driver” on page 87](#)

## Aligning the Print Head - Mac OS X

1. Load A4-size plain paper in the printer.
2. Select **System Preferences** from the  menu > **Printers & Scanners** (or **Print & Scan**, **Print & Fax**), and then select the printer.
3. Click **Options & Supplies** > **Utility** > **Open Printer Utility**.
4. Click **Print Head Alignment**.
5. Follow the on-screen instructions.

### Related Information

- ➔ [“Loading Paper in the Rear Paper Feed” on page 30](#)

---

## Cleaning the Paper Path

When the printouts are smeared or scuffed, clean the roller inside.

**Important:**

*Do not use tissue paper to clean the inside of the printer. The print head nozzles may be clogged with lint.*

1. Make sure there is no dust or stains on the scanner glass and the document cover.
2. Load A4-size plain paper in the printer.
3. Start copying without placing an original on the scanner glass.  
The paper is ejected from the printer.

## Maintaining the Printer

- Repeat this procedure until the paper is not smeared with ink.

**Note:**

If you have a paper feed problem and if you have a cleaning sheet that came with Epson genuine paper, you may be able to solve the paper feed problem by using the cleaning sheet instead of using A4-size plain paper. When using the cleaning sheet, load the sheet in the printer following the instructions that came with the sheet. Repeat the procedure several times using the cleaning sheet.

### Related Information

➔ [“Copying Basics” on page 56](#)

---

## Cleaning the Scanner Glass

When the copies or scanned images are smeared or scuffed, clean the scanner glass.



**Important:**

Never use alcohol or thinner to clean the printer. These chemicals can damage the printer.

- Open the document cover.

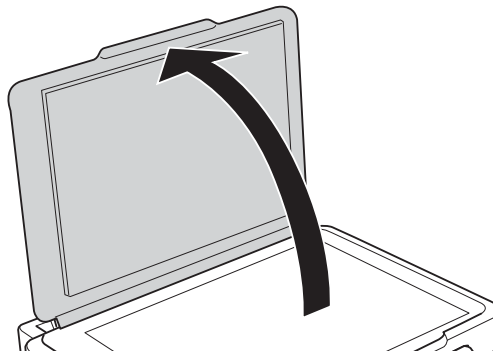

- Use a soft, dry, clean cloth to clean the surface of the scanner glass.

**Note:**

- If the glass surface is stained with grease or some other hard-to-remove material, use a small amount of glass cleaner and a soft cloth to remove it. Wipe off all remaining liquid.
- Do not press the glass surface too hard.
- Be careful not to scratch or damage the surface of the glass. A damaged glass surface can decrease the scan quality.

---

## Saving Power

The printer enters sleep mode or turns off automatically if no operations are performed for a set period. You can adjust the time before power management is applied. Any increase will affect the product's energy efficiency. Please consider the environment before making any change.

## Maintaining the Printer

### Saving Power - Windows

1. Access the printer driver window.
2. Click **Printer and Option Information** on the **Maintenance** tab.
3. Select the time period before the printer enters sleep mode as the **Sleep Timer** setting, and click **Send**. To make the printer turn off automatically, select the time period as the **Power Off Timer** setting, and click **Send**.
4. Click **OK**.

#### Related Information

➔ [“Windows Printer Driver” on page 87](#)

### Saving Power - Mac OS X

1. Select **System Preferences** from the  menu > **Printers & Scanners** (or **Print & Scan**, **Print & Fax**), and then select the printer.
2. Click **Options & Supplies** > **Utility** > **Open Printer Utility**.
3. Click **Printer Settings**.
4. Select the time period before the printer enters sleep mode as the **Sleep Timer** setting, and click **Apply**. To make the printer turn off automatically, select the time period as the **Power Off Timer** setting, and click **Apply**.

# Network Service and Software Information

This section introduces the network services and software products available for your printer from the Epson website or the supplied CD.

---

## Epson Connect Service

By using Epson Connect service available on the Internet, you can print from your smartphone, tablet PC, or laptop, anytime and practically anywhere.

The features available on the Internet are as follows.

Email Print	Epson iPrint remote print	Scan to Cloud	Remote Print Driver
✓	✓	-	✓

See the Epson Connect portal website for details.

<https://www.epsonconnect.com/>

<http://www.epsonconnect.eu> (Europe only)

---

## Web Config

Web Config is an application that runs in a web browser, such as Internet Explorer and Safari, on a computer or smart device. You can confirm the printer status or change the network service and printer settings. To use the Web Config, connect the printer and the computer or device to the same network.

**Note:**

*The following browsers are supported.*

OS	Browser
Windows XP or later	Internet Explorer 8 or later, Firefox <sup>*</sup> , Chrome <sup>*</sup>
Mac OS X v10.6.8 or later	Safari <sup>*</sup> , Firefox <sup>*</sup> , Chrome <sup>*</sup>
iOS <sup>*</sup>	Safari <sup>*</sup>
Android 2.3 or later	Default browser
Chrome OS <sup>*</sup>	Default browser

\* Use the latest version.

## Running Web Config on a Web Browser

1. Check the printer's IP address.

Hold down the  button for at least 10 seconds to print the network status sheet, and then check the printer's IP address.

2. Launch a Web browser from a computer or smart device, and then enter the printer's IP address.

Format:

IPv4: http://the printer's IP address/

IPv6: http://[the printer's IP address]/

Examples:

IPv4: http://192.168.100.201/

IPv6: http://[2001:db8::1000:1]/

**Note:**

Using the smart device, you can also run Web Config from the maintenance screen of Epson iPrint.

### Related Information

➔ [“Printing Using Epson iPrint” on page 53](#)

## Running Web Config on Windows

When connecting a computer to the printer using WSD, follow the steps below to run Web Config.

1. Access the devices and printers screen in Windows.

- Windows 10

Right-click the start button or press and hold it, and then select **Control Panel > View devices and printers in Hardware and Sound**.

- Windows 8.1/Windows 8

Select **Desktop > Settings > Control Panel > View devices and printers in Hardware and Sound (or Hardware)**.

- Windows 7

Click the start button, and select **Control Panel > View devices and printers in Hardware and Sound**.

- Windows Vista

Click the start button, and select **Control Panel > Printers in Hardware and Sound**.

2. Right-click on your printer and select **Properties**.

3. Select the **Web Service** tab and click the URL.

## Running Web Config on Mac OS X

1. Select **System Preferences** from the  menu > **Printers & Scanners** (or **Print & Scan, Print & Fax**), and then select the printer.

2. Click **Options & Supplies > Show Printer Webpage**.

---

## Windows Printer Driver

The printer driver controls the printer according to the commands from an application. Making settings on the printer driver provides the best printing results. You can also check the status of the printer or keep it in top operating condition using the printer driver utility.

**Note:**

You can change the language of the printer driver. Select the language you want to use from the **Language** setting on the **Maintenance** tab.

### Accessing the printer driver from applications

To make settings that apply only to the application you are using, access from that application.

Select **Print** or **Print Setup** from the **File** menu. Select your printer, and then click **Preferences** or **Properties**.

**Note:**

Operations differ depending on the application. See the application's help for details.

### Accessing the printer driver from the control panel

To make settings that apply to all of the applications, access from the control panel.

Windows 10

Right-click the start button or press and hold it, and then select **Control Panel > View devices and printers in Hardware and Sound**. Right-click on your printer, or press and hold it and then select **Printing preferences**.

Windows 8.1/Windows 8

Select **Desktop > Settings > Control Panel > View devices and printers in Hardware and Sound**. Right-click on your printer, or press and hold it and then select **Printing preferences**.

Windows 7

Click the start button, and select **Control Panel > View devices and printers in Hardware and Sound**. Right-click on your printer and select **Printing preferences**.

Windows Vista

Click the start button, and select **Control Panel > Printers in Hardware and Sound**. Right-click on your printer and select **Select printing preferences**.

Windows XP

Click the start button, and select **Control Panel > Printers and Other Hardware > Printers and Faxes**. Right-click on your printer and select **Printing preferences**.

### Accessing the printer driver from the printer icon on the task bar

The printer icon on the desktop task bar is a shortcut icon allowing you to quickly access the printer driver.

If you click the printer icon and select **Printer Settings**, you can access the same printer settings window as the one displayed from the control panel. If you double-click this icon, you can check the status of the printer.

**Note:**

If the printer icon is not displayed on the task bar, access the printer driver window, click **Monitoring Preferences** on the **Maintenance** tab, and then select **Register the shortcut icon to the taskbar**.

## Network Service and Software Information

### Starting the utility

Access the printer driver window. Click the **Maintenance** tab.

## Guide to Windows Printer Driver

Help is available in the printer driver for Windows. To view explanations of the setting items, right-click on each item, and then click **Help**.

### Main Tab

You can make basic settings for printing, such as paper type or paper size.

You can also make settings for printing both sides of the paper or printing multiple pages on one sheet.

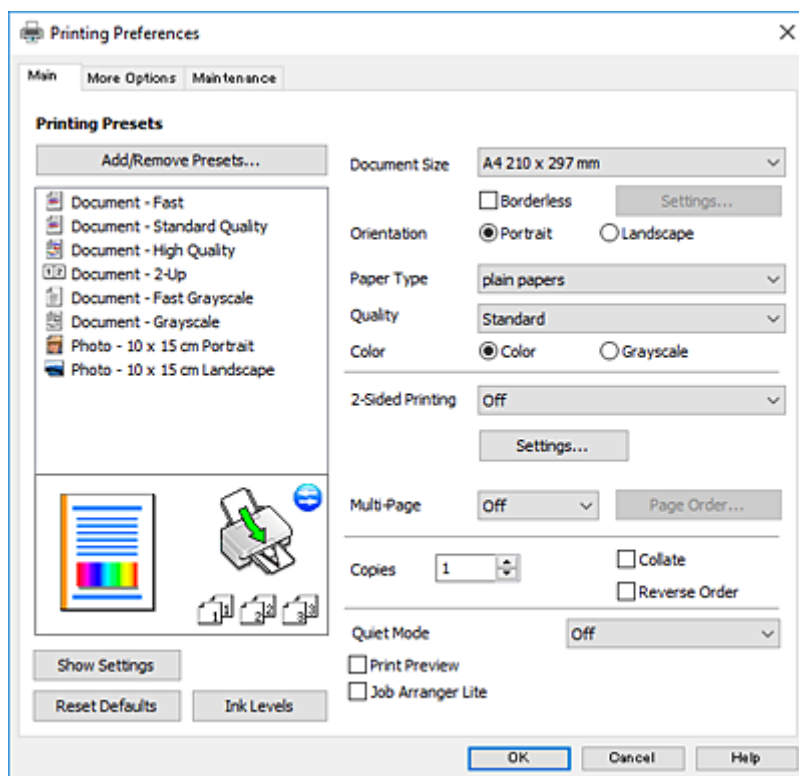



## Network Service and Software Information

### More Options Tab

You can select additional layout and printing options such as changing the size of a printout or making color corrections.

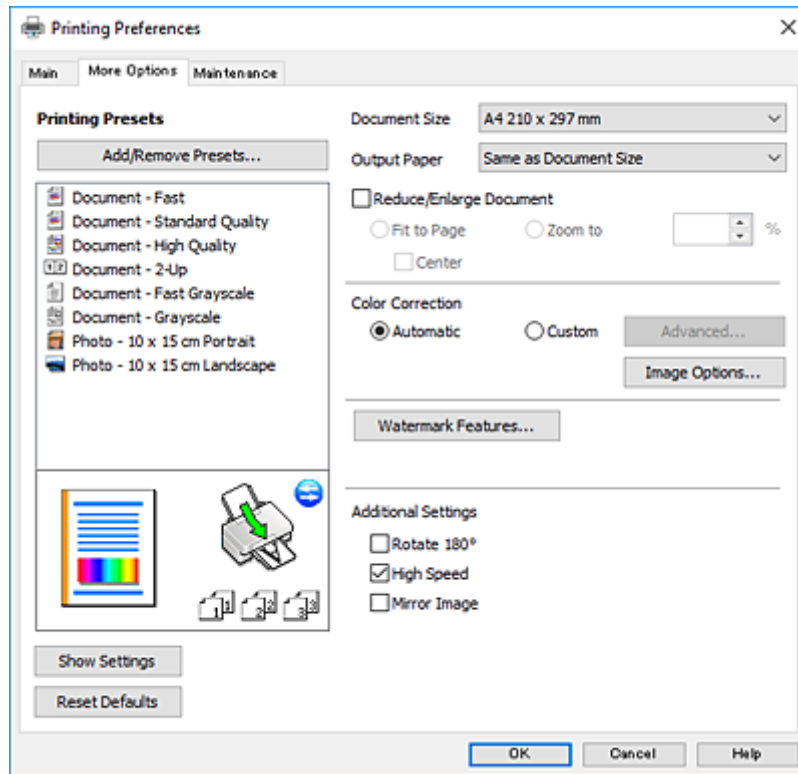

## Network Service and Software Information

### Maintenance Tab

You can run maintenance features such as nozzle check and print head cleaning, and by starting **EPSON Status Monitor 3**, you can check printer status and error information.

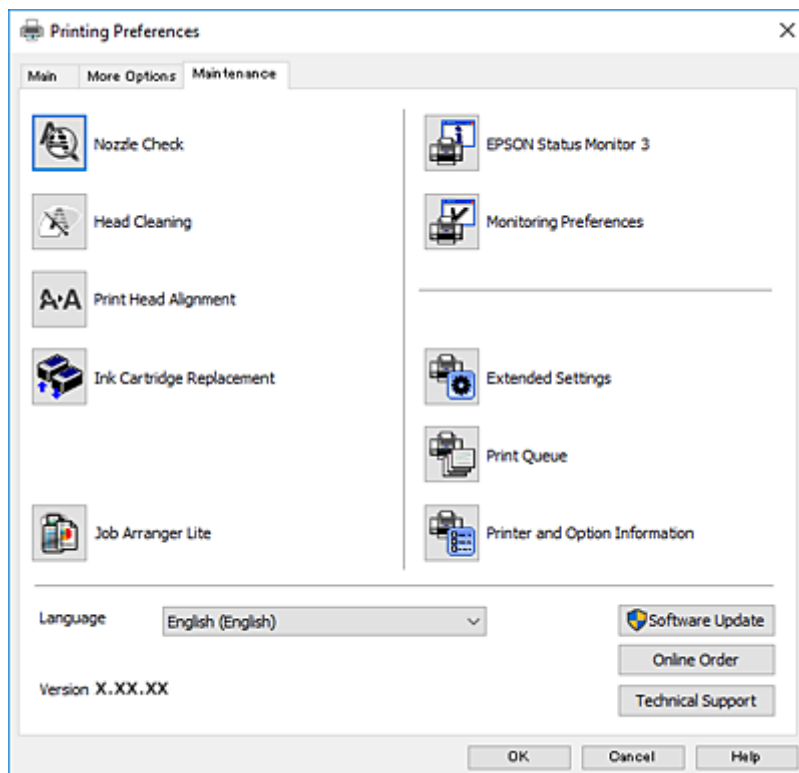

## Making Operation Settings for the Windows Printer Driver

You can make settings such as enabling **EPSON Status Monitor 3**.

1. Access the printer driver window.
2. Click **Extended Settings** on the **Maintenance** tab.
3. Make the appropriate settings, and then click **OK**.  
See the online help for explanations of the setting items.

### Related Information

➔ [“Windows Printer Driver” on page 87](#)

---

## Mac OS X Printer Driver

The printer driver controls the printer according to the commands from an application. Making settings on the printer driver provides the best printing results. You can also check the status of the printer or keep it in top operating condition using the printer driver utility.

## Network Service and Software Information

### Accessing the printer driver from applications

Click **Page Setup** or **Print** on the **File** menu of your application. If necessary, click **Show Details** (or ▼) to expand the print window.

**Note:**

Depending on the application being used, **Page Setup** may not be displayed in the **File** menu, and the operations for displaying the print screen may differ. See the application's help for details.

### Starting the utility

Select **System Preferences** from the  menu > **Printers & Scanners** (or **Print & Scan, Print & Fax**), and then select the printer. Click **Options & Supplies** > **Utility** > **Open Printer Utility**.

## Guide to Mac OS X Printer Driver

### Print dialog

Switch the pop-up menu on the center of the screen to show more items.

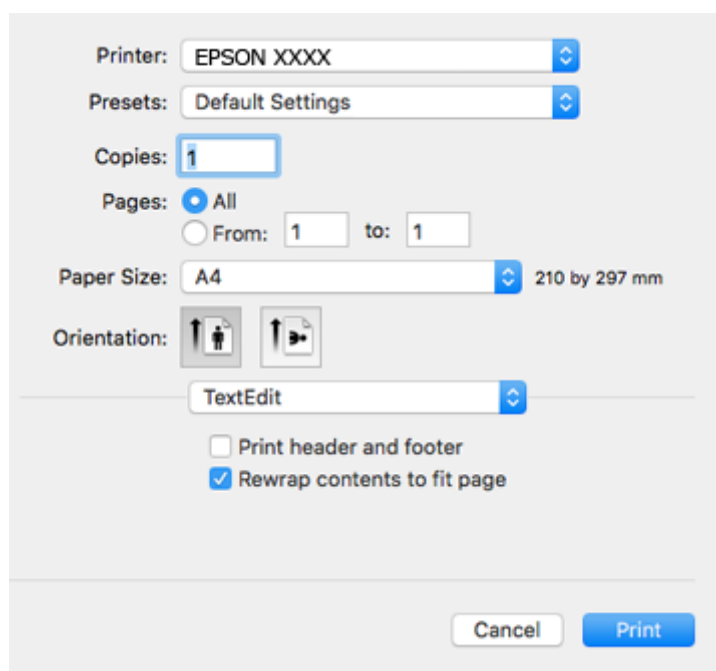

Pop-up Menu	Descriptions
Print Settings	You can make the basic print settings such as paper type and print quality.
Layout	You can select a layout for printing several pages on one sheet or select to print a border.
Paper Handling	You can reduce or enlarge the size of the print job to automatically fit the paper size you loaded.
Color Matching	You can adjust the colors.
Color Options	When you select <b>EPSON Color Controls</b> from the <b>Color Matching</b> menu, you can select a color correction method.

## Network Service and Software Information

### Note:

On Mac OS X v10.8.x or later, if **Print Settings** menu is not displayed, Epson printer driver has not been installed correctly.

Select **System Preferences** from the  menu > **Printers & Scanners** (or **Print & Scan**, **Print & Fax**), remove the printer, and then add the printer again. See the following to add a printer.

<http://epson.sn>

### Epson Printer Utility

You can run a maintenance feature such as nozzle check and print head cleaning, and by starting **EPSON Status Monitor**, you can check printer status and error information.

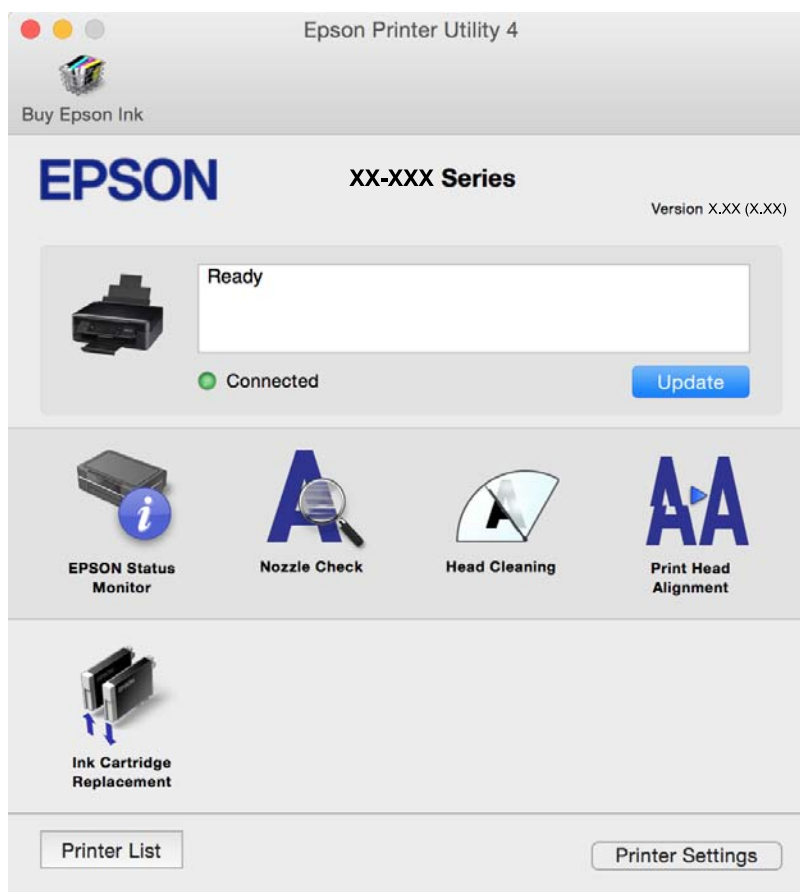

## Making Operation Settings for the Mac OS X Printer Driver

### Accessing the Operation Settings Window of the Mac OS X Printer Driver

Select **System Preferences** from the  menu > **Printers & Scanners** (or **Print & Scan**, **Print & Fax**), and then select the printer. Click **Options & Supplies** > **Options** (or **Driver**).

### Operation Settings of the Mac OS X Printer Driver

- Skip Blank Page: Avoids printing blank pages.
- Quiet Mode: Reduces the noise the printer makes, however, this may reduce print speed. Depending on the paper type and print quality settings you selected, there may be no difference in the printer's noise level.

## Network Service and Software Information

- Permit temporary black printing: Prints only with black ink temporarily.
- High Speed Printing: Prints when the print head moves in both directions. The print speed is faster, but the quality may decline.
- Warning Notifications: Allows the printer driver to display warning notifications.
- Establish bidirectional communication: Usually, this should be set to **On**. Select **Off** when acquiring the printer information is impossible because the printer is shared with Windows computers on a network or for any other reason.

### Related Information

➔ [“Temporarily Printing with Black Ink” on page 76](#)

---

## Epson Scan 2 (Scanner Driver)

Epson Scan 2 is an application for controlling scanning. You can adjust the size, resolution, brightness, contrast, and quality of the scanned image.

### Note:

*You can also start Epson Scan 2 from a TWAIN-compliant scanning application.*

### Starting on Windows

- Windows 10

Click the start button, and then select **All apps > EPSON > Epson Scan 2**.

- Windows 8.1/Windows 8

Enter the application name in the search charm, and then select the displayed icon.

- Windows 7/Windows Vista/Windows XP

Click the start button, and then select **All Programs** or **Programs > EPSON > Epson Scan 2 > Epson Scan 2**.

### Starting on Mac OS X

### Note:

*Epson Scan 2 does not support the Mac OS X fast user switching feature. Turn off fast user switching.*

Select **Go > Applications > Epson Software > Epson Scan 2**.

### Related Information

➔ [“Installing Applications” on page 97](#)

---

## Epson Event Manager

Epson Event Manager is an application that allows you to manage scanning from the control panel and save images to a computer. You can add your own settings as presets, such as the document type, the save folder location, and the image format. See the application's help for details.

## Network Service and Software Information

### Starting on Windows

Windows 10

Click the start button, and then select **All apps > Epson Software > Event Manager**.

Windows 8.1/Windows 8

Enter the application name in the search charm, and then select the displayed icon.

Windows 7/Windows Vista/Windows XP

Click the start button, and then select **All Programs** or **Programs > Epson Software > Event Manager**.

### Starting on Mac OS X

Select **Go > Applications > Epson Software > Event Manager**.

### Related Information

➔ [“Scanning from the Control Panel” on page 57](#)

➔ [“Installing Applications” on page 97](#)

---

## Epson Easy Photo Print

Epson Easy Photo Print is an application that allows you to easily print photos with various layouts. You can preview the photo image and adjust the images or position. You can also print photos with a frame. See the application's help for details.

**Note:**

*To use this application, the printer driver needs to be installed.*

### Starting on Windows

Windows 10

Click the start button, and then select **All apps > Epson Software > Epson Easy Photo Print**.

Windows 8.1/Windows 8

Enter the application name in the search charm, and then select the displayed icon.

Windows 7/Windows Vista/Windows XP

Click the start button, and then select **All Programs** or **Programs > Epson Software > Epson Easy Photo Print**.

### Starting on Mac OS X

Select **Go > Applications > Epson Software > Epson Easy Photo Print**.

### Related Information

➔ [“Installing Applications” on page 97](#)

---

## E-Web Print (for Windows Only)

E-Web Print is an application that allows you to easily print web pages with various layouts. See the application's help for details. You can access the help from the **E-Web Print** menu on the **E-Web Print** tool bar.

## Network Service and Software Information

**Note:**

Check for supported browsers and the latest version from the download site.

**Starting**

When you install E-Web Print, it is displayed in your browser. Click **Print** or **Clip**.

**Related Information**

➔ [“Installing Applications” on page 97](#)

---

## Easy Photo Scan

Easy Photo Scan is an application that allows you to scan photos and easily send the scanned image to a computer or cloud service. You can also easily adjust the scanned image. See the application's help for details.

**Note:**

To use this application, the scanner driver Epson Scan 2 needs to be installed.

**Starting on Windows** Windows 10

Click the start button, and then select **All apps > Epson Software > Easy Photo Scan**.

 Windows 8.1/Windows 8

Enter the application name in the search charm, and then select the displayed icon.

 Windows 7/Windows Vista/Windows XP

Click the start button, and then select **All Programs** or **Programs > Epson Software > Easy Photo Scan**.

**Starting on Mac OS X**

Select **Go > Applications > Epson Software > Easy Photo Scan**.

**Related Information**

➔ [“Installing Applications” on page 97](#)

---

## EPSON Software Updater

EPSON Software Updater is an application that checks for new or updated software on the internet and installs it. You can also update the printer's firmware and manual.

**Starting on Windows** Windows 10

Click the start button, and then select **All apps > Epson Software > EPSON Software Updater**.

 Windows 8.1/Windows 8

Enter the application name in the search charm, and then select the displayed icon.

## Network Service and Software Information

- ❑ Windows 7/Windows Vista/Windows XP

Click the start button, and then select **All Programs** (or **Programs**) > **Epson Software** > **EPSON Software Updater**.

**Note:**

You can also start EPSON Software Updater by clicking the printer icon on the task bar on the desktop, and then selecting **Software Update**.

### Starting on Mac OS X

Select **Go** > **Applications** > **Epson Software** > **EPSON Software Updater**.

### Related Information

➔ [“Installing Applications” on page 97](#)

---

## Uninstalling Applications

**Note:**

Log on to your computer as an administrator. Enter the administrator password if the computer prompts you.

### Uninstalling Applications - Windows

1. Press the  button to turn off the printer.
2. Quit all running applications.
3. Open **Control Panel**:
  - ❑ Windows 10  
Right-click the start button or press and hold it, and then select **Control Panel**.
  - ❑ Windows 8.1/Windows 8  
Select **Desktop** > **Settings** > **Control Panel**.
  - ❑ Windows 7/Windows Vista/Windows XP  
Click the start button and select **Control Panel**.
4. Open **Uninstall a program** (or **Add or Remove Programs**):
  - ❑ Windows 10/Windows 8.1/Windows 8/Windows 7/Windows Vista  
Select **Uninstall a program** in **Programs**.
  - ❑ Windows XP  
Click **Add or Remove Programs**.
5. Select the application you want to uninstall.
6. Uninstall the applications:
  - ❑ Windows 10/Windows 8.1/Windows 8/Windows 7/Windows Vista  
Click **Uninstall/Change** or **Uninstall**.
  - ❑ Windows XP



## Network Service and Software Information

Click **Change/Remove** or **Remove**.

**Note:**



If the **User Account Control** window is displayed, click **Continue**.

7. Follow the on-screen instructions.

## Uninstalling Applications - Mac OS X

1. Download the Uninstaller using EPSON Software Updater.

Once you have downloaded the Uninstaller, you do not need to download it again each time you uninstall the application.

2. Press the  button to turn off the printer.
3. To uninstall the printer driver, select **System Preferences** from the  menu > **Printers & Scanners** (or **Print & Scan, Print & Fax**), and then remove the printer from the enabled printers list.
4. Quit all running applications.
5. Select **Go > Applications > Epson Software > Uninstaller**.
6. Select the application you want to uninstall, and then click **Uninstall**.



**Important:**

The Uninstaller removes all drivers for Epson inkjet printers on the computer. If you use multiple Epson inkjet printers and you only want to delete some drivers, delete all of them first, and then install the necessary printer driver again.

**Note:**

If you cannot find the application you want to uninstall in the application list, you cannot uninstall using the Uninstaller. In this situation, select **Go > Applications > Epson Software**, select the application you want to uninstall, and then drag it to the trash icon.

### Related Information

- ➔ [“Installing Applications” on page 97](#)

---

## Installing Applications

Connect your computer to the network and install the latest version of applications from the website.

**Note:**

- Log on to your computer as an administrator. Enter the administrator password if the computer prompts you.
- When reinstalling an application, you need to uninstall it first.

1. Quit all running applications.
2. When installing the printer driver or Epson Scan 2, disconnect the printer and the computer temporarily.

**Note:**

Do not connect the printer and the computer until you are instructed to do so.

## Network Service and Software Information

3. Access to the following website, and then enter the product name.

<http://epson.sn>

4. Go to **Setup** and then click **Download**. Click or double-click the downloaded file to run the installer. Follow the on-screen instructions.

**Note:**

*If you are using a Windows computer and you cannot download applications from the website, install them from the software disc that came with the printer.*

### Related Information

➔ [“Uninstalling Applications” on page 96](#)

---

## Updating Applications and Firmware

You may be able to clear certain problems and improve or add functions by updating the applications and the firmware. Make sure you use the latest version of the applications and firmware.

1. Make sure that the printer and the computer are connected, and the computer is connected to the internet.
2. Start EPSON Software Updater, and update the applications or the firmware.



**Important:**

*Do not turn off the computer or the printer while updating.*

**Note:**

*If you cannot find the application you want to update in the list, you cannot update using the EPSON Software Updater. Check for the latest versions of the applications from your local Epson website.*

<http://www.epson.com>

### Related Information

➔ [“EPSON Software Updater” on page 95](#)

# Solving Problems

## Checking the Printer Status















### Checking the Error Indicators on the Printer

When an error occurs, the light turns on or flashes. Details of the error are displayed on the computer screen.



 : On

 : Flashing slowly

 : Flashing fast

Light	Situation	Solutions
	No paper is loaded or more than one sheet has been fed at a time.	Load paper and press the  or  button.
	A paper jam has occurred.	Remove the paper and press the  or  button.
	An ink cartridge is expended or there is insufficient ink in the cartridge to charge the ink.	To ensure you receive premium print quality and to help protect your print head, a variable ink safety reserve remains in the cartridge when your printer indicates it is time to replace the cartridge. Replace with a new ink cartridge.
	An ink cartridge is not installed.	Install the ink cartridge.
	An ink cartridge has not been recognized.	Press the ink cartridge down firmly.
	An unsupported ink cartridge has been installed.	Install an ink cartridge that is supported by this printer. You cannot use the cartridges that came with your printer for replacement.
	An ink cartridge is nearly expended. You can print until the  light turns on.	Prepare a new ink cartridge. You can check the ink levels from the computer.
	The  light and  light flash alternately. An ink pad is nearing or at the end of its service life.	The ink pads* need to be replaced. Contact Epson or an authorised Epson service provider to replace the ink pad*. It is not a user-serviceable part. When a message saying that you can continue printing is displayed on the computer, press the  or  button to continue printing. The lights stop flashing for the time being, however, they will continue to flash at regular intervals until the ink pad is replaced.

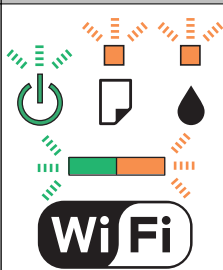
## Solving Problems

Light	Situation	Solutions
	A printer error has occurred.	<p>Open the scanner unit and remove any paper or protective material inside the printer. Turn the power off and on again.</p> <p>If the error continues to occur after turning the power off and on again, contact Epson support.</p>
	A Wi-Fi connection error has occurred.	Press the Wi-Fi button to clear the error and try again.
	The printer has started in recovery mode because the firmware update failed.	<p>Follow the steps below to try to update the firmware again.</p> <ol style="list-style-type: none"> <li>1. Connect the computer and the printer with a USB cable. (During recovery mode, you cannot update the firmware over a network connection.)</li> <li>2. Visit your local Epson website for further instructions.</li> </ol> <p>The printer notifies you of the firmware update status as shown below.</p> <p>Preparing: The network status lights flash.</p> <p>Updating: The power light flashes.</p> <p>Finished: The power light stays on.</p>

\* In some print cycles a very small amount of surplus ink may be collected in the ink pad. To prevent ink leakage from the pad, the printer is designed to stop printing when the pad has reached its limit. Whether and how often this is required will vary according to the number of pages you print, the type of material that you print and the number of cleaning cycles that the printer performs. The need for replacement of the pad does not mean that your printer has ceased to operate in accordance with its specifications. The printer will advise you when the pad requires replacing and this can only be performed by an authorised Epson Service provider. The Epson warranty does not cover the cost of this replacement.

### Related Information

- ➔ [“Removing Jammed Paper” on page 101](#)
- ➔ [“Contacting Epson Support” on page 131](#)
- ➔ [“Installing Applications” on page 97](#)
- ➔ [“Updating Applications and Firmware” on page 98](#)

## Checking the Printer Status - Windows

1. Access the printer driver window.

## Solving Problems

2. Click **EPSON Status Monitor 3** on the **Maintenance** tab.

**Note:**

- ❑ You can also check the printer status by double-clicking the printer icon on the taskbar. If the printer icon is not added to the taskbar, click **Monitoring Preferences** on the **Maintenance** tab, and then select **Register the shortcut icon to the taskbar**.
- ❑ If **EPSON Status Monitor 3** is disabled, click **Extended Settings** on the **Maintenance** tab, and then select **Enable EPSON Status Monitor 3**.

### Related Information

- ➔ [“Windows Printer Driver” on page 87](#)

## Checking Printer Status - Mac OS X

1. Select **System Preferences** from the  menu > **Printers & Scanners** (or **Print & Scan**, **Print & Fax**), and then select the printer.
2. Click **Options & Supplies** > **Utility** > **Open Printer Utility**.
3. Click **EPSON Status Monitor**.

---

## Removing Jammed Paper

Check the error displayed on the control panel and follow the instructions to remove the jammed paper including any torn pieces. Next, clear the error.



**Important:**

*Remove the jammed paper carefully. Removing the paper vigorously may cause damage to the printer.*

### Related Information

- ➔ [“Checking the Error Indicators on the Printer” on page 99](#)

## Removing Jammed Paper from the Rear Paper Feed

Remove the jammed paper.

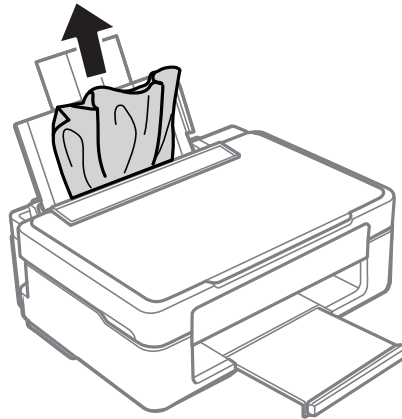

## Removing Jammed Paper from the Output Tray

Remove the jammed paper.

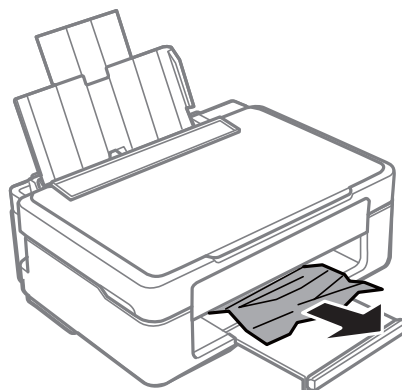

## Removing Jammed Paper from Inside the Printer



**Caution:**

- ❑ Be careful not to trap your hand or fingers when opening or closing the scanner unit. Otherwise you may be injured.
- ❑ Never touch the buttons on the control panel while your hand is inside the printer. If the printer starts operating, it could cause an injury. Be careful not to touch the protruding parts to avoid injury.

## Solving Problems

1. Open the scanner unit with the document cover closed.

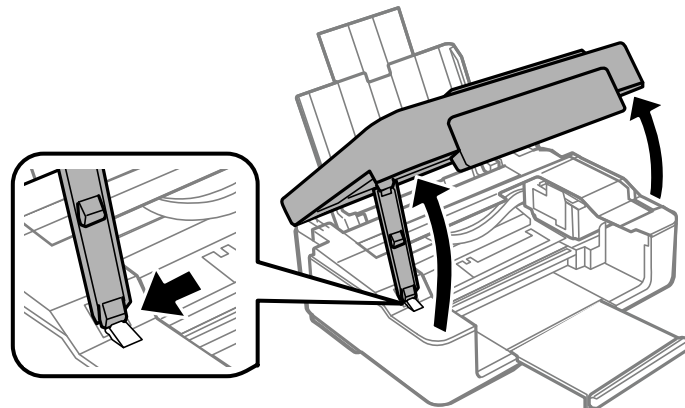

2. Remove the jammed paper.

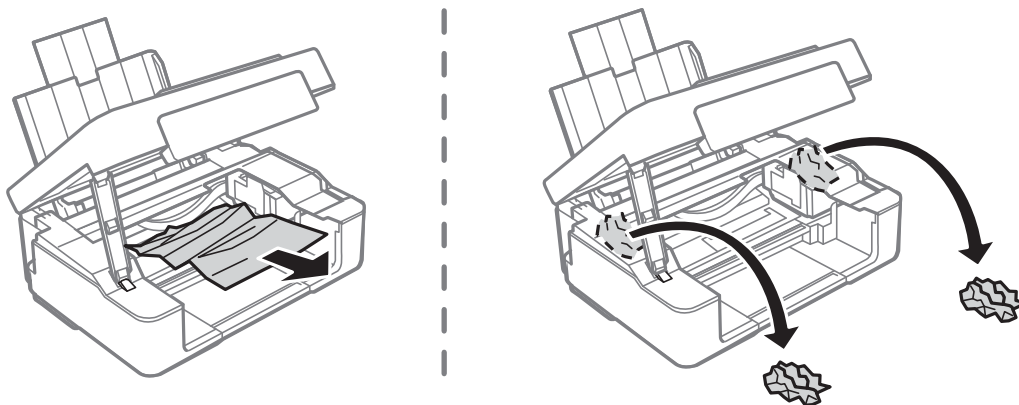

**!** *Important:*

*Do not touch the white flat cable or translucent part inside the printer. Doing so may cause a malfunction.*

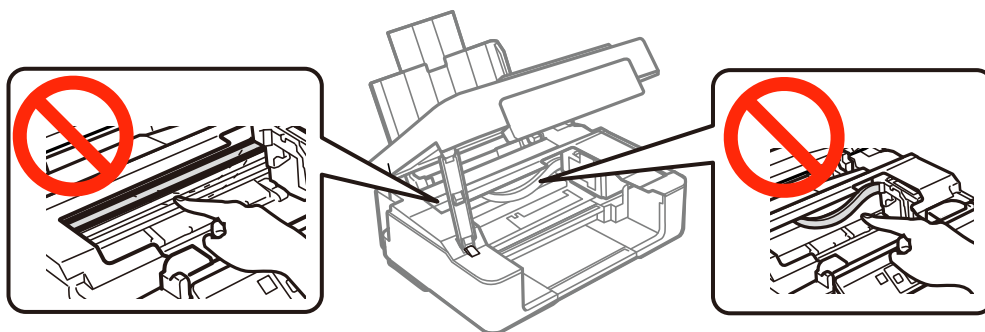

## Solving Problems

3. Close the scanner unit.

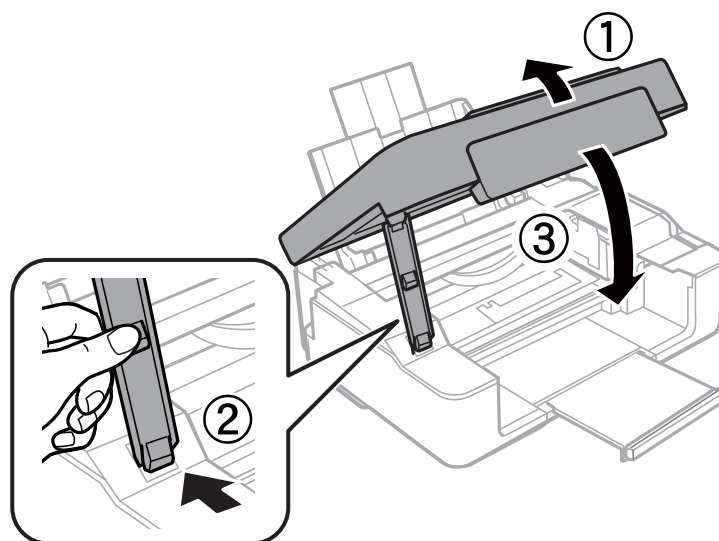

---

## Paper Does Not Feed Correctly

Check the following points, and then take the appropriate actions to solve the problem.

- Place the printer on a flat surface and operate in the recommended environmental conditions.
- Use paper supported by this printer.
- Follow the paper handling precautions.

### Related Information

- ➔ [“Environmental Specifications” on page 127](#)
- ➔ [“Paper Handling Precautions” on page 28](#)
- ➔ [“Available Paper and Capacities” on page 29](#)

## Paper Jams

- Load paper in the correct direction, and slide the edge guides against the edges of the paper.
- Load one sheet of paper at a time if you have loaded several sheets of paper.

### Related Information

- ➔ [“Removing Jammed Paper” on page 101](#)
- ➔ [“Loading Paper in the Rear Paper Feed” on page 30](#)

## Paper Feeds at a Slant

Load paper in the correct direction, and slide the edge guides against the edges of the paper.



## Solving Problems

### Related Information

- ➔ [“Loading Paper in the Rear Paper Feed” on page 30](#)

## Several Sheets of Paper are Fed at a Time

- Load one sheet of paper at a time.
- When several sheets of paper are fed at a time during manual 2-sided printing, remove any paper which is loaded in the printer before you reload the paper.

## No Paper Feeds

- Do not load more than the maximum number of sheets specified for the paper. For plain paper, do not load above the line indicated by the triangle symbol on the edge guide.
- If you have the cleaning sheet that came with Epson genuine paper, use it to clean the roller inside the printer.

### Related Information

- ➔ [“Available Paper and Capacities” on page 29](#)
- ➔ [“Cleaning the Paper Path” on page 82](#)



---

## Power and Control Panel Problems

### Power Does Not Turn On

- Make sure the power cord is securely plugged in.
- Hold down the  button for a little longer.

### Power Does Not Turn Off

Hold down the  button for a little longer. If you still cannot turn off the printer, unplug the power cord. To prevent the print head from drying out, turn the printer back on and turn it off by pressing the  button.

---

## Cannot Print from a Computer

- Install the printer driver.
- Connect the USB cable securely to the printer and the computer.
- If you are using a USB hub, try to connect the printer directly to the computer.
- If you cannot print over a network, see the page that describes the network connection method from the computer.
- If you are printing a large data size image, the computer may run out of memory. Print the image at a lower resolution or a smaller size.

## Solving Problems

- ❑ In Windows, click **Print Queue** on the printer driver's **Maintenance** tab, and then check the following.
  - ❑ Check if there are any paused print jobs.  
Cancel printing if necessary.
  - ❑ Make sure the printer is not offline or pending.  
If the printer is offline or pending, clear the offline or pending setting from the **Printer** menu.
  - ❑ Make sure the printer is selected as the default printer from the **Printer** menu (there should be a check mark on the menu item).  
If the printer is not selected as the default printer, set it as the default printer.
  - ❑ Make sure the printer port is selected correctly in **Property** > **Port** from the **Printer** menu as follows.  
Select "**USBXXX**" for a USB connection, or "**EpsonNet Print Port**" for a network connection.
- ❑ In Mac OS X, make sure the printer status is not **Pause**.  
Select **System Preferences** from the  menu > **Printers & Scanners** (or **Print & Scan**, **Print & Fax**), and then double-click the printer. If the printer is paused, click **Resume** (or **Resume Printer**).

### Related Information

- ➔ [“Installing Applications” on page 97](#)
- ➔ [“Connecting to a Computer” on page 16](#)
- ➔ [“Canceling Printing” on page 54](#)

---

## When You Cannot Make Network Settings

- ❑ Turn off the devices you want to connect to the network. Wait for about 10 seconds, and then turn on the devices in the following order; access point, computer or smart device, and then printer. Move the printer and computer or smart device closer to the access point to help with radio wave communication, and then try to make network settings again.
- ❑ Print the network connection report. Check it and then follow the printed solutions.

### Related Information

- ➔ [“Cannot Connect from Devices Even Though Network Settings are No Problem” on page 106](#)
- ➔ [“Printing a Network Connection Report” on page 21](#)

## Cannot Connect from Devices Even Though Network Settings are No Problem

If you cannot connect from the computer or smart device to the printer even though the network connection report does not show any problems, see the following.

### Solving Problems

- ❑ When you are using multiple access points at the same time, you may not be able to use the printer from the computer or smart device depending on the settings of the access points. Connect the computer or smart device to the same access point as the printer.

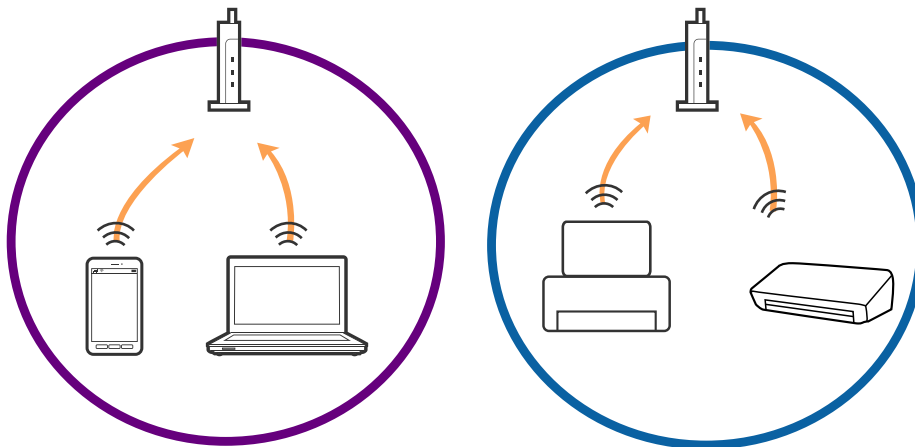

- ❑ You may not be able to connect to the access point when the access point has multiple SSIDs and devices are connected to different SSIDs on the same access point. Connect the computer or smart device to the same SSID as the printer.

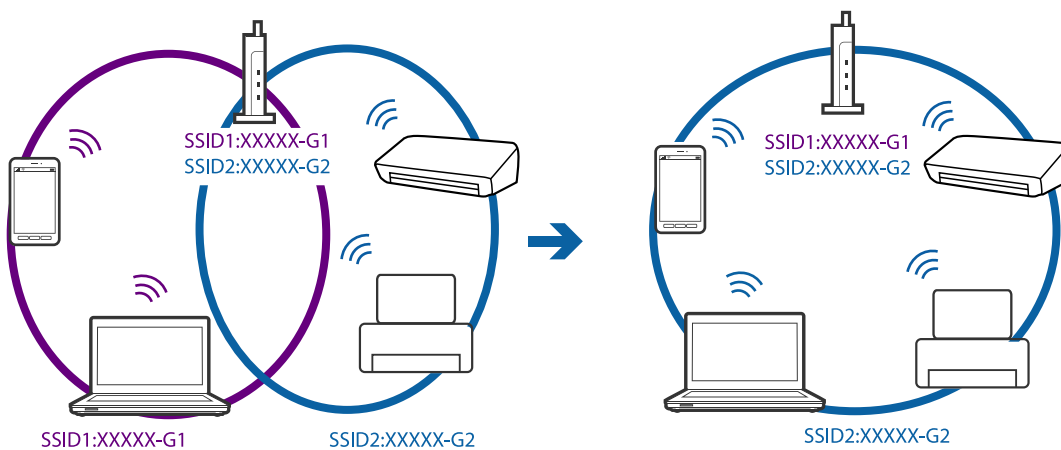

- ❑ An access point that is compliant with both IEEE802.11a and IEEE802.11g has SSIDs of 2.4 GHz and 5 GHz. If you connect the computer or smart device to a 5 GHz SSID, you cannot be able to connect to the printer because the printer only supports communication over 2.4 GHz. Connect the computer or smart device to the same SSID as the printer.

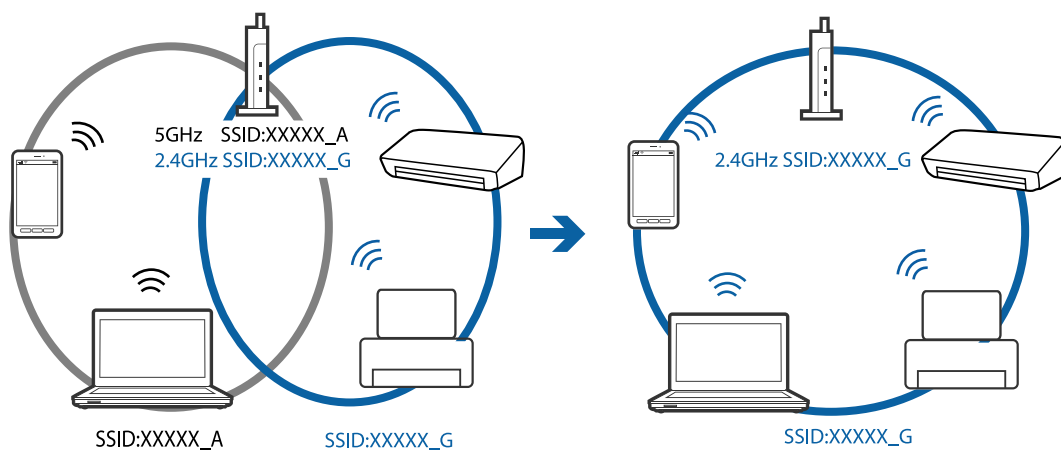

## Solving Problems

- ❑ Most access points have a privacy separator feature that blocks the communication from unauthorized devices. If you cannot connect to the network even if the devices and access point are connected to the same SSID, disable the privacy separator on the access point. See the manual provided with the access point for details.

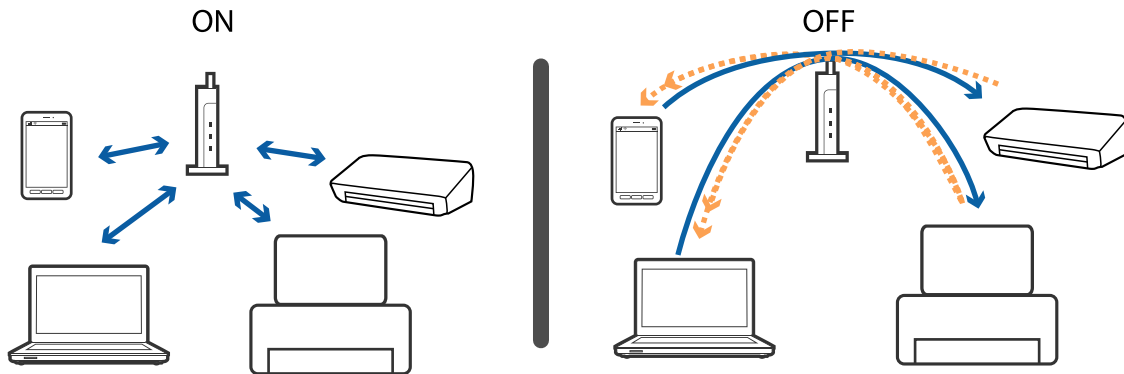

### Related Information

- ➔ [“Checking the SSID Connected to the Printer” on page 108](#)
- ➔ [“Checking the SSID for the Computer” on page 108](#)

## Checking the SSID Connected to the Printer

You can check the SSID by printing a network connection report, network status sheet, or on Web Config.

## Checking the SSID for the Computer

### Windows

Select **Control Panel > Network and Internet > Network and Sharing Center**.

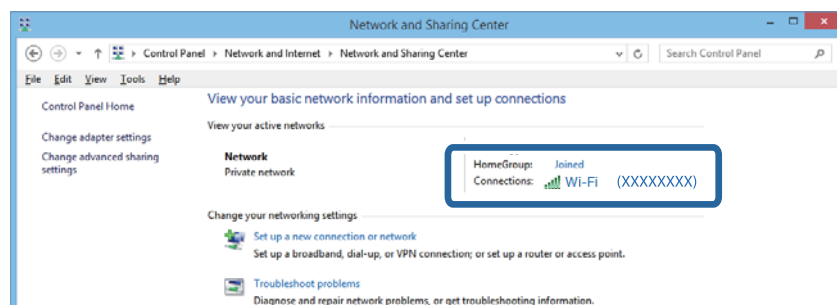

## Solving Problems

### Mac OS X

Click the Wi-Fi icon at the top of the computer screen. A list of SSIDs is displayed and the connected SSID is indicated with a check mark.



---

## Suddenly the Printer Cannot Print over a Network Connection

- When you have changed your access point or provider, try making network settings for the printer again. Connect the computer or smart device to the same SSID as the printer.
- Turn off the devices you want to connect to the network. Wait for about 10 seconds, and then turn on the devices in the following order; access point, computer or smart device, and then printer. Move the printer and computer or smart device closer to the access point to help with radio wave communication, and then try to make network settings again.
- In Windows, click **Print Queue** on the printer driver's **Maintenance** tab, and then check the following.
  - Check if there are any paused print jobs. Cancel printing if necessary.
  - Make sure the printer is not offline or pending. If the printer is offline or pending, clear the offline or pending setting from the **Printer** menu.
  - Make sure the printer is selected as the default printer from the **Printer** menu (there should be a check mark on the menu item).  
If the printer is not selected as the default printer, set it as the default printer.
  - Check if the selected port is correct in **Printer properties > Port**
- Print the network connection report. If the report shows that the network connection failed, check the network connection report and then follow the printed solutions.
- Try accessing any website from your computer to make sure that your computer's network settings are correct. If you cannot access any website, there is a problem on the computer. See the manual provided with your computer for more details.

### Related Information

- ➔ [“Checking the SSID Connected to the Printer” on page 108](#)
- ➔ [“Checking the SSID for the Computer” on page 108](#)
- ➔ [“Messages and Solutions on the Network Connection Report” on page 21](#)

## Solving Problems

➔ [“Cannot Connect from Devices Even Though Network Settings are No Problem”](#) on page 106

---

# Suddenly the Printer Cannot Print Using a USB Connection

- ❑ Disconnect the USB cable from the computer. Right-click on the printer icon displayed on the computer, and then select **Remove Device**. Next, connect the USB cable to the computer and try a test print. If printing is possible, the setup is complete.
- ❑ Re-set the USB connection following the steps in [Changing a Connection Method to a Computer] in this manual.

### Related Information

➔ [“Changing the Connection Method to a Computer”](#) on page 25

---

# Printout Problems

## Printout is Scuffed or Color is Missing

If you have not used the printer for a long time, the print head nozzles may be clogged and ink drops may not be discharged. Perform a nozzle check, and then clean the print head if any of the print head nozzles are clogged.

### Related Information

➔ [“Checking and Cleaning the Print Head”](#) on page 80

## Banding or Unexpected Colors Appear

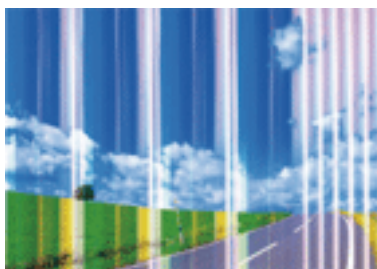

The print head nozzles may be clogged. Perform a nozzle check to check if the print head nozzles are clogged. Clean the print head if any of the print head nozzles are clogged.

### Related Information

➔ [“Checking and Cleaning the Print Head”](#) on page 80

## Solving Problems

**Colored Banding Appears at Intervals of Approximately 2.5 cm**

- Select the appropriate paper type setting for the type of paper loaded in the printer.
- Align the print head.
- When printing on plain paper, print using a higher quality setting.

**Related Information**

- ➔ [“List of Paper Types” on page 30](#)
- ➔ [“Aligning the Print Head” on page 81](#)

**Blurry Prints, Vertical Banding, or Misalignment**

enthalten alle  
 Aufdruck. W  
 ↓ 5008 "Regel

Align the print head.

**Related Information**

- ➔ [“Aligning the Print Head” on page 81](#)

**Print Quality Does Not Improve Even After Aligning the Print Head**

During bidirectional (or high speed) printing, the print head prints while moving in both directions, and vertical lines may be misaligned. If print quality does not improve, disable the bidirectional (or high speed) setting. Disabling this setting may slow down printing speed.

- Windows
  - Clear **High Speed** on the printer driver's **More Options** tab.

## Solving Problems

### Mac OS X

Select **System Preferences** from the  menu > **Printers & Scanners** (or **Print & Scan, Print & Fax**), and then select the printer. Click **Options & Supplies** > **Options** (or **Driver**). Select **Off** as the **High Speed Printing** setting.

## Print Quality is Poor

Check the following if the print quality is poor due to blurry prints, banding, missing colors, faded colors, and misalignment in the prints.

- Use paper supported by this printer.
- Select the appropriate paper type setting for the type of paper loaded in the printer.
- Do not print on paper that is damp, damaged, or too old.
- If the paper is curled or the envelope is puffed up, flatten it.
- Perform a nozzle check, and then clean the print head if any of the print head nozzles are clogged.
- Align the print head.
- Print using a higher quality setting.
- Do not stack the paper immediately after printing.
- Dry the printouts completely before filing or displaying them. When drying the printouts, avoid direct sun light, do not use a dryer, and do not touch the printed side of paper.
- When printing images or photos, Epson recommends using genuine Epson paper rather than plain paper. Print on the printable side of the genuine Epson paper.
- Try to use genuine Epson ink cartridges. This product is designed to adjust colors based on the use of genuine Epson ink cartridges. The use of non-genuine ink cartridges may cause print quality to decline.
- Epson recommends using the ink cartridge before the date printed on the package.
- For best results, use up ink cartridge within six months of opening the package.

### Related Information

- ➔ [“Available Paper and Capacities” on page 29](#)
- ➔ [“List of Paper Types” on page 30](#)
- ➔ [“Paper Handling Precautions” on page 28](#)
- ➔ [“Checking and Cleaning the Print Head” on page 80](#)
- ➔ [“Aligning the Print Head” on page 81](#)

## Paper Is Smearred or Scuffed

- When horizontal banding appears or the top or bottom of the paper is smearred, load paper in the correct direction and slide the edge guides to the edges of the paper.

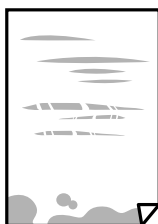



## Solving Problems

- ❑ When vertical banding appears or the paper is smeared, clean the paper path.

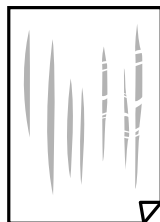

- ❑ Place the paper on a flat surface to check if it is curled. If it is, flatten it.
- ❑ When performing manual 2-sided printing, make sure that the ink is completely dry before reloading the paper.

### Related Information

- ➔ [“Loading Paper in the Rear Paper Feed” on page 30](#)
- ➔ [“Cleaning the Paper Path” on page 82](#)

## Printed Photos are Sticky

You may be printing on the wrong side of the photo paper. Make sure you are printing on the printable side.

When printing on the wrong side of the photo paper, you need to clean the paper path.

### Related Information

- ➔ [“Cleaning the Paper Path” on page 82](#)

## Images or Photos are Printed in Unexpected Colors

When printing from the Windows printer driver, the Epson auto photo adjustment setting is applied by default depending on the paper type. Try change the setting.

On the **More Options** tab, select **Custom** in **Color Correction**, and then click **Advanced**. Change the **Scene Correction** setting from **Auto Correct** to any other option. If changing the setting does not work, use any color correction method other than **PhotoEnhance** in **Color Management**.

### Related Information

- ➔ [“Adjusting the Print Color” on page 51](#)

## Colors Differ from What You See on the Display

- ❑ Display devices such as computer screens have their own display properties. If the display is unbalanced, the image are not displayed with proper brightness and colors. Adjust the properties of the device.
- ❑ Light shining into the display has an effect on how the image is seen on the display. Avoid direct sunlight and confirm the image where an appropriate illuminance is assured.
- ❑ Colors may differ from what you see on smart devices such as smart phones or tablets with high-resolution displays.
- ❑ Colors on a display are not quite identical to those on paper because the display device and the printer have a different process of producing colors.

## Cannot Print Without Margins

Make borderless setting in the print settings. If you select a paper type that does not support borderless printing, you cannot select **Borderless**. Select a paper type that supports borderless printing.

### Related Information

- ➔ [“Printing Basics - Windows” on page 36](#)
- ➔ [“Printing Basics - Mac OS X” on page 37](#)

## Edges of the Image are Cropped During Borderless Printing

During borderless printing, the image is slightly enlarged and the protruding area is cropped. Select a smaller enlargement setting.

### Windows

Click **Settings** next to the **Borderless** checkbox on the printer driver's **Main** tab, and then change the settings.

### Mac OS X

Change the **Expansion** setting from the print dialog's **Print Settings** menu.

## The Position, Size, or Margins of the Printout Are Incorrect

- Load paper in the correct direction, and slide the edge guides against the edges of the paper.
- When placing the originals on the scanner glass, align the corner of the original with the corner indicated by a symbol on the frame of the scanner glass. If the edges of the copy are cropped off, move the original slightly away from the corner.
- When placing the originals on the scanner glass, clean the scanner glass and the document cover. If there is dust or stains on the glass, the copy area may extend to include the dust or stains, resulting in the wrong copying position or small images.
- Select the appropriate paper size setting.
- Adjust the margin setting in the application so that it falls within the printable area.

### Related Information

- ➔ [“Loading Paper in the Rear Paper Feed” on page 30](#)
- ➔ [“Placing Originals on the Scanner Glass” on page 34](#)
- ➔ [“Cleaning the Scanner Glass” on page 83](#)
- ➔ [“Printable Area” on page 123](#)

## Printed Characters Are Incorrect or Garbled

- Connect the USB cable securely to the printer and the computer.
- Cancel any paused print jobs.
- Do not put the computer manually into the **Hibernate** mode or the **Sleep** mode while printing. Pages of garbled text may be printed next time you start the computer.

**Related Information**

➔ [“Canceling Printing” on page 54](#)

## The Printed Image Is Inverted

Clear any mirror image settings in the printer driver or the application.

Windows

Clear **Mirror Image** on the printer driver's **More Options** tab.

Mac OS X

Clear **Mirror Image** from the print dialog's **Print Settings** menu.

## Mosaic-Like Patterns in the Prints

When printing images or photos, print using high-resolution data. Images on websites are often low resolution although they look good enough on the display, and so print quality may decline.

## Uneven Colors, Smears, Dots, or Straight Lines Appear in the Copied Image

Clean the paper path.

Clean the scanner glass.

Do not press too hard on the original or the document cover when you are placing the originals on the scanner glass.

**Related Information**



➔ [“Cleaning the Paper Path” on page 82](#)

➔ [“Cleaning the Scanner Glass” on page 83](#)

## Moiré (Cross-Hatch) Patterns Appear in the Copied Image

Place the original at a slightly different angle.

## Banding Appears on the Copied Image

If you press the  and the  or  buttons simultaneously, the printer copies in draft mode and banding may appear on the printout.

## An Image of the Reverse Side of the Original Appears in the Copied Image

For a thin original, place the original on the scanner glass and then place a piece of black paper over it.

## The Printout Problem Could Not be Cleared

If you have tried all of the solutions and have not solved the problem, try uninstalling and then reinstalling the printer driver.



### Related Information

- ➔ [“Uninstalling Applications” on page 96](#)
- ➔ [“Installing Applications” on page 97](#)

---

## Other Printing Problems

### Printing Is Too Slow

- Close any unnecessary applications.
- Lower the quality setting. High quality printing slows down the printing speed.
- Enable the bidirectional (or high speed) setting. When this setting is enabled, the print head prints while moving in both directions, and the printing speed increases.
  - Windows  
Select **High Speed** on the printer driver's **More Options** tab.
  - Mac OS X  
Select **System Preferences** from the  menu > **Printers & Scanners** (or **Print & Scan**, **Print & Fax**), and then select the printer. Click **Options & Supplies** > **Options** (or **Driver**). Select **On** as the **High Speed Printing** setting.
- Disable **Quiet Mode**.
  - Windows  
Disable the **Quiet Mode** setting on the printer driver's **Main** tab.
  - Mac OS X  
Select **System Preferences** from the  menu > **Printers & Scanners** (or **Print & Scan**, **Print & Fax**), and then select the printer. Click **Options & Supplies** > **Options** (or **Driver**). Select **Off** as the **Quiet Mode** setting.

### Printing Slows Down Dramatically During Continuous Printing

Printing slows down to prevent the printer mechanism from overheating and being damaged. However, you can continue printing. To return to normal printing speed, leave the printer idle for at least 30 minutes. Printing speed does not return to normal if the power is off.

---

## Cannot Start Scanning

- Connect the USB cable securely to the printer and the computer.
- If you are using a USB hub, try to connect the printer directly to the computer.
- If you scan at a high resolution over a network, a communication error may occur. Lower the resolution.

## Solving Problems

- ❑ Make sure you select the correct printer (scanner) if a scanner list is displayed when you start Epson Scan 2.
- ❑ Make sure that the correct printer (scanner) is selected on Epson Scan 2.
- ❑ If you are using any TWAIN-compliant applications, select the printer (scanner) you are using.
- ❑ In Windows, make sure the printer (scanner) is displayed in **Scanner and Camera**. The printer (scanner) should be displayed as "EPSON XXXXX (printer name)". If the printer (scanner) is not displayed, uninstall and then re-install Epson Scan 2. See the following to access **Scanner and Camera**.
  - ❑ Windows 10  
Right-click the start button or press and hold it, select **Control Panel**, enter "Scanner and Camera" in the search charm, click **View scanners and cameras**, and then check if the printer is displayed.
  - ❑ Windows 8.1/Windows 8  
Select **Desktop > Settings > Control Panel**, enter "Scanner and Camera" in the search charm, click **Show Scanner and Camera**, and then check if the printer is displayed.
  - ❑ Windows 7  
Click the start button and select **Control Panel**, enter "Scanner and Camera" in the search charm, click **View scanners and cameras**, and then check if the printer is displayed.
  - ❑ Windows Vista  
Click the start button, select **Control Panel > Hardware and Sound > Scanners and Cameras**, and then check if the printer is displayed.
  - ❑ Windows XP  
Click the start button, select **Control Panel > Printers and Other Hardware > Scanner and Cameras**, and then check if the printer is displayed.
- ❑ If you cannot scan using any TWAIN-compliant applications, uninstall and then reinstall the TWAIN-compliant application.

### Related Information

- ➔ ["Uninstalling Applications" on page 96](#)
- ➔ ["Installing Applications" on page 97](#)

## Cannot Start Scanning when Using the Control Panel

- ❑ Make sure Epson Scan 2 and Epson Event Manager are installed correctly.
- ❑ Check the scanning setting assigned in Epson Event Manager.

### Related Information

- ➔ ["Epson Scan 2 \(Scanner Driver\)" on page 93](#)
- ➔ ["Epson Event Manager" on page 93](#)

---

## Scanned Image Problems

### Uneven Colors, Dirt, Spots, and so on Appear when Scanning from the Scanner Glass

- Clean the scanner glass.
- Remove any trash or dirt that adheres to the original.
- Do not press with too much force on the original or the document cover. If you press with too much force, blurring, smudges, and spots may occur.

#### Related Information

➔ [“Cleaning the Scanner Glass” on page 83](#)

### The Image Quality Is Rough

- Set the **Mode** in Epson Scan 2 according to the original you want to scan. Scan using the settings for documents in **Document Mode**, and the settings for photos in **Photo Mode**.
- In Epson Scan 2, adjust the image using items on the **Advanced Settings** tab, and then scan.
- If the resolution is low, try increasing the resolution and then scanning.

#### Related Information

➔ [“Scanning Using Epson Scan 2” on page 57](#)

### Offset Appears in the Background of Images

Images on the back of the original may appear in the scanned image.

- In Epson Scan 2, select the **Advanced Settings** tab, and then adjust the **Brightness**.  
This feature may not be available depending on the settings on the **Main Settings** tab > **Image Type** or other settings on the **Advanced Settings** tab.
- In **Document Mode** in Epson Scan 2, select the **Advanced Settings** tab, and then **Image Option** > **Text Enhancement**.
- When scanning from the scanner glass, place black paper or a desk pad over the original.

#### Related Information

➔ [“Placing Originals on the Scanner Glass” on page 34](#)

➔ [“Scanning Using Epson Scan 2” on page 57](#)

### Text is Blurred

- In **Document Mode** in Epson Scan 2, select the **Advanced Settings** tab, and then **Image Option** > **Text Enhancement**.

## Solving Problems

- ❑ Select **Document Mode** as the **Mode** in Epson Scan 2. Scan using the settings for documents in **Document Mode**.
- ❑ In **Document Mode** in Epson Scan 2, when **Image Type** on the **Main Settings** tab is set to **Black & White**, adjust **Threshold** on the **Advanced Settings** tab. When you increase the **Threshold**, the black color area becomes larger.
- ❑ If the resolution is low, try increasing the resolution and then scanning.

### Related Information

- ➔ [“Scanning Documents \(Document Mode\)” on page 57](#)

## Moiré Patterns (Web-Like Shadows) Appear

If the original is a printed document, moiré patterns (web-like shadows) may appear in the scanned image.

- ❑ On the **Advanced Settings** tab in Epson Scan 2, set **Descreening**.



- ❑ Change the resolution, and then scan again.

### Related Information

- ➔ [“Scanning Using Epson Scan 2” on page 57](#)

## Cannot Scan the Correct Area on the Scanner Glass

- ❑ Make sure the original is placed correctly against the alignment marks.
- ❑ If the edge of the scanned image is missing, move the original slightly away from the edge of the scanner glass.
- ❑ When placing multiple originals on the scanner glass, make sure there is a gap of at least 20 mm (0.79 in.) between the originals.

### Related Information

- ➔ [“Placing Originals on the Scanner Glass” on page 34](#)

## Cannot Preview in Thumbnail

- ❑ When placing multiple originals on the scanner glass, make sure there is a gap of at least 20 mm (0.79 in.) between the originals.
- ❑ Check that the original is placed straight.
- ❑ Depending on the original, previewing may not be performed in **Thumbnail**. In this situation, scan in **Normal** preview, and then create marquees manually.

## Solving Problems

### Related Information

➔ [“Scanning Photos or Pictures \(Photo Mode\)” on page 59](#)

## Text is Not Recognized Correctly when Saving as a Searchable PDF

- On the **Image Format Options** window in Epson Scan 2, check that **Text Language** is set correctly on the **Text** tab.
- Check that the original is placed straight.
- Use an original with clear text. Text recognition may decline for the following types of originals.
  - Originals that have been copied a number of times
  - Originals received by fax (at low resolutions)
  - Originals on which the letter spacing or line spacing is too small
  - Originals with ruled lines or underlining over the text
  - Originals with hand-written text
  - Originals with creases or wrinkles
- In **Document Mode** in Epson Scan 2, when **Image Type** on the **Main Settings** tab is set to **Black & White**, adjust **Threshold** on the **Advanced Settings** tab. When you increase the **Threshold**, black becomes stronger.
- In **Document Mode** in Epson Scan 2, select the **Advanced Settings** tab, and then **Image Option > Text Enhancement**.

### Related Information

➔ [“Scanning Documents \(Document Mode\)” on page 57](#)

## Cannot Solve Problems in the Scanned Image

If you have tried all of the solutions and have not solved the problem, initialize the Epson Scan 2 settings using Epson Scan 2 Utility.

### Note:

*Epson Scan 2 Utility is an application that comes with Epson Scan 2.*

1. Start Epson Scan 2 Utility.
  - Windows 10  
Click the start button, and then select **All apps > EPSON > Epson Scan 2 Utility**.
  - Windows 8.1/Windows 8  
Enter the application name in the search charm, and then select the displayed icon.
  - Windows 7/Windows Vista/Windows XP  
Click the start button, and then select **All Programs or Programs > EPSON > Epson Scan 2 > Epson Scan 2 Utility**.
  - Mac OS X  
Select **Go > Applications > Epson Software > Epson Scan 2 Utility**.
2. Select the **Other** tab.



3. Click **Reset**.

**Note:**

If initialization does not solve the problem, uninstall and re-install Epson Scan 2.

**Related Information**

- ➔ [“Uninstalling Applications” on page 96](#)
- ➔ [“Installing Applications” on page 97](#)

---

## Other Scanning Problems

### Scanning Is Too Slow

Lower the resolution.

**Related Information**

- ➔ [“Scanning Using Epson Scan 2” on page 57](#)

### Scanning Stops when Scanning to PDF/Multi-TIFF

- When scanning using Epson Scan 2, you can continuously scan up to 999 pages in PDF format and up to 200 pages in Multi-TIFF format.
- When scanning large volumes, we recommend scanning in grayscale.
- Increase the free space on the computer's hard disk. Scanning may stop if there is not enough free space.
- Try scanning at a lower resolution. Scanning stops if the total data size reaches the limit.

**Related Information**

- ➔ [“Scanning Using Epson Scan 2” on page 57](#)

---

## Other Problems

### Slight Electric Shock when Touching the Printer

If many peripherals are connected to the computer, you may feel a slight electric shock when touching the printer. Install a ground wire to the computer that is connected to the printer.

### Operation Sounds Are Loud

If operations sounds are too loud, enable **Quiet Mode**. Enabling this feature may reduce printing speed. Depending on the paper type and print quality settings you selected, there may be no difference in the printer's noise level.

- Windows  
Enable **Quiet Mode** on the **Main** tab in the printer driver.

## Solving Problems

### Mac OS X

Select **System Preferences** from the  menu > **Printers & Scanners** (or **Print & Scan, Print & Fax**), and then select the printer. Click **Options & Supplies** > **Options** (or **Driver**). Select **On** as the **Quiet Mode** setting.

## **Application Is Blocked by a Firewall (for Windows Only)**

Add the application to the Windows Firewall allowed program in security settings on the **Control Panel**.

# Appendix

## Technical Specifications

### Printer Specifications

Print Head Nozzle Placement		Black ink nozzles: 180 Color ink nozzles: 59 for each color
Weight of Paper	Plain Paper	64 to 90 g/m <sup>2</sup> (17 to 24lb)
	Envelopes	Envelope #10, DL, C6: 75 to 90 g/m <sup>2</sup> (20 to 24 lb)

### Printable Area

#### Printable Area for Single Sheets

Print quality may decline in the shaded areas due to the printer's mechanism.

#### Border printing

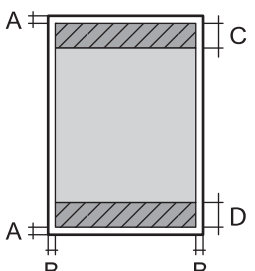
	A	3.0 mm (0.12 in.)
	B	3.0 mm (0.12 in.)
	C	40.0 mm (1.57 in.)
	D	32.0 mm (1.26 in.)

#### Borderless printing

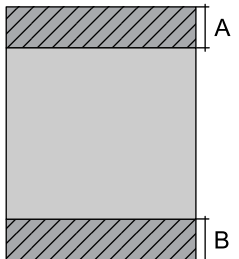
	A	43.0 mm (1.69 in.)
	B	35.0 mm (1.38 in.)

#### Printable Area for Envelopes

Print quality may decline in the shaded areas due to the printer's mechanism.

**Appendix**

	A	3.0 mm (0.12 in.)
	B	5.0 mm (0.20 in.)
	C	18.0 mm (0.71 in.)
	D	40.0 mm (1.57 in.)

**Scanner Specifications**

Scanner Type	Flatbed
Photoelectric Device	CIS
Maximum Document Size	216×297 mm (8.5×11.7 in.) A4, Letter
Resolution	1200 dpi (main scan) 2400 dpi (sub scan)
Color Depth	<p>Color</p> <ul style="list-style-type: none"> <li><input type="checkbox"/> 48 bits per pixel internal (16 bits per pixel per color internal)</li> <li><input type="checkbox"/> 24 bits per pixel external (8 bits per pixel per color external)</li> </ul> <p>Grayscale</p> <ul style="list-style-type: none"> <li><input type="checkbox"/> 16 bits per pixel internal</li> <li><input type="checkbox"/> 8 bits per pixel external</li> </ul> <p>Black and white</p> <ul style="list-style-type: none"> <li><input type="checkbox"/> 16 bits per pixel internal</li> <li><input type="checkbox"/> 1 bits per pixel external</li> </ul>
Light Source	LED

**Interface Specifications**

For Computer	Hi-Speed USB
--------------	--------------

**Network Function List**

Functions		Supported	Remarks	
Network Interfaces	Ethernet	-	-	
	Wi-Fi	Infrastructure	✓	-
		Ad hoc	-	-
		Wi-Fi Direct (Simple AP)	-	-

## Appendix

Functions		Supported	Remarks
Concurrent Connection	Ethernet and Wi-Fi Direct (Simple AP)		-
	Wi-Fi (Infrastructure) and Wi-Fi Direct (Simple AP)		-
Panel Operation	Wi-Fi Setup	Wi-Fi Setup Wizard	-
		Push Button Setup (WPS)	✓
		PIN Code Setup	✓
		Wi-Fi Auto Connect	✓
		Wi-Fi Direct Setup	-
	General Network Setup		-
	Network Connection Check		✓
	Network Status		-
	Network Status Sheet Printing		✓
	Disable Wi-Fi		-
	Restore the Factory Default Settings		✓
	File Sharing Setup		-
Network Printing	EpsonNet Print (Windows)	IPv4	✓
	Standard TCP/IP (Windows)	IPv4,IPv6	✓
	WSD Printing (Windows)	IPv4,IPv6	✓
	Bonjour Printing (Mac OS X)	IPv4,IPv6	✓
	IPP Printing (Windows,Mac OS X)	IPv4,IPv6	-
	UPnP Printing	IPv4	-
	PictBridge Printing (Wi-Fi)	IPv4	-
	Epson Connect (Email Print)	IPv4	✓
Network Scanning	Epson Scan 2	IPv4,IPv6	✓
	Event Manager	IPv4	-
	Epson Connect (Scan to Cloud)	IPv4	-
	ADF (AutoReversing)		-

## Appendix

Functions			Supported	Remarks
Fax	Send a fax	IPv4	-	-
	Receive a fax	IPv4	-	-

## Wi-Fi Specifications

Standards	IEEE802.11b/g/n* <sup>1</sup>
Frequency Range	2.4 GHz
Maximum Radio-Frequency Power Transmitted	17 dBm (EIRP)
Coordination Modes	Infrastructure
Wireless Securities	WEP (64/128bit), WPA2-PSK (AES)* <sup>2</sup>

\*1 Complies with either IEEE 802.11b/g/n or IEEE 802.11b/g depending on location of purchase.

\*2Complies with WPA2 standards with support for WPA/WPA2 Personal.

## Security Protocol

SSL/TLS	HTTPS Server/Client
---------	---------------------

## Dimensions

Dimensions	<p>Storage</p> <ul style="list-style-type: none"> <li><input type="checkbox"/> Width: 390 mm (15.4 in.)</li> <li><input type="checkbox"/> Depth: 300 mm (11.8 in.)</li> <li><input type="checkbox"/> Height: 145 mm (5.7 in.)</li> </ul> <p>Printing</p> <ul style="list-style-type: none"> <li><input type="checkbox"/> Width: 390 mm (15.4 in.)</li> <li><input type="checkbox"/> Depth: 504 mm (20.8 in.)</li> <li><input type="checkbox"/> Height: 279 mm (11.0 in.)</li> </ul>
Weight*	Approx. 3.9 kg (8.6 lb)

\* Without the ink cartridges and the power cord.

## Electrical Specifications

Model	100 to 240 V Model	220 to 240 V Model
Rated Frequency Range	50 to 60 Hz	50 to 60 Hz
Rated Current	0.5 to 0.3 A	0.3 A

## Appendix

Power Consumption (with USB Connection)	Standalone copying: Approx. 12.0 W (ISO/IEC24712) Ready mode: Approx. 4.0 W Sleep mode: Approx. 1.6 W Power off: Approx. 0.3 W	Standalone copying: Approx. 12.0 W (ISO/IEC24712) Ready mode: Approx. 4.0 W Sleep mode: Approx. 1.6 W Power off: Approx. 0.3 W
---	---	---

**Note:**

- Check the label on the printer for its voltage.
- For users in Belgium, power consumption when copying may vary.  
Check <http://www.epson.be> for the latest specifications.

## Environmental Specifications

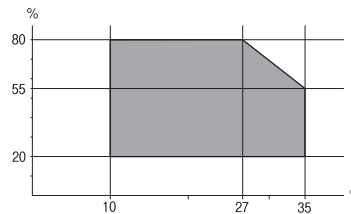
Operation	Use the printer within the range shown in the following graph.  Temperature: 10 to 35°C (50 to 95°F) Humidity: 20 to 80% RH (without condensation)
Storage	Temperature: -20 to 40°C (-4 to 104°F)* Humidity: 5 to 85% RH (without condensation)

\* You can store for one month at 40°C (104°F).

## Environmental Specifications for Ink Cartridges

Storage Temperature	-30 to 40 °C (-22 to 104 °F)*
Freezing Temperature	-16 °C (3.2 °F) Ink thaws and is usable after approximately 3 hours at 25 °C (77 °F).

\* You can store for one month at 40 °C (104 °F).

## System Requirements

- Windows 10 (32-bit, 64-bit)/Windows 8.1 (32-bit, 64-bit)/Windows 8 (32-bit, 64-bit)/Windows 7 (32-bit, 64-bit)/Windows Vista (32-bit, 64-bit)/Windows XP SP3 or later (32-bit)/Windows XP Professional x64 Edition SP2 or later  
Mac OS X v10.11.x/Mac OS X v10.10.x/Mac OS X v10.9.x/Mac OS X v10.8.x/Mac OS X v10.7.x/Mac OS X v10.6.8

**Note:**

- Mac OS X may not support some applications and features.
- The UNIX File System (UFS) for Mac OS X is not supported.

---

## Regulatory Information

### Standards and Approvals

#### Standards and Approvals for European Model

For European users

Hereby, Seiko Epson Corporation declares that the following radio equipment model is in compliance with Directive 2014/53/EU. The full text of the EU declaration of conformity is available at the following website.

<http://www.epson.eu/conformity>

C462Q

For use only in Ireland, UK, Austria, Germany, Liechtenstein, Switzerland, France, Belgium, Luxemburg, Netherlands, Italy, Portugal, Spain, Denmark, Finland, Norway, Sweden, Iceland, Croatia, Cyprus, Greece, Slovenia, Malta, Bulgaria, Czech, Estonia, Hungary, Latvia, Lithuania, Poland, Romania, and Slovakia.

Epson cannot accept responsibility for any failure to satisfy the protection requirements resulting from a non-recommended modification of the products.



#### Standards and Approvals for Australian Model

EMC	AS/NZS CISPR22 Class B
-----	------------------------

Epson hereby declares that the following equipment Models are in compliance with the essential requirements and other relevant provisions of AS/NZS4268:

C462Q

Epson cannot accept responsibility for any failure to satisfy the protection requirements resulting from a non-recommended modification of the products.

### Restrictions on Copying

Observe the following restrictions to ensure the responsible and legal use of the printer.

Copying of the following items is prohibited by law:

- Bank bills, coins, government-issued marketable securities, government bond securities, and municipal securities
- Unused postage stamps, pre-stamped postcards, and other official postal items bearing valid postage
- Government-issued revenue stamps, and securities issued according to legal procedure

Exercise caution when copying the following items:



## Appendix

- Private marketable securities (stock certificates, negotiable notes, checks, etc.), monthly passes, concession tickets, etc.
- Passports, driver's licenses, warrants of fitness, road passes, food stamps, tickets, etc.

**Note:**

*Copying these items may also be prohibited by law.*

Responsible use of copyrighted materials:

Printers can be misused by improperly copying copyrighted materials. Unless acting on the advice of a knowledgeable attorney, be responsible and respectful by obtaining the permission of the copyright holder before copying published material.

---

## Transporting the Printer

When you need to transport the printer to move or for repairs, follow the steps below to pack the printer.

**! Important:**

- When storing or transporting the printer, avoid tilting it, placing it vertically, or turning it upside down; otherwise ink may leak.
- Leave the ink cartridges installed. Removing the cartridges can dry out the print head and may prevent the printer from printing.

1. Turn off the printer by pressing the  button.
2. Make sure the power light turns off, and then unplug the power cord.

**! Important:**

*Unplug the power cord when the power light is off. Otherwise, the print head does not return to the home position causing the ink to dry, and printing may become impossible.*

3. Disconnect all cables such as the power cord and USB cable.
4. Remove all of the paper from the printer.
5. Make sure there are no originals on the printer.
6. Open the scanner unit with the document cover closed. Secure the ink cartridge holder to the case with tape.

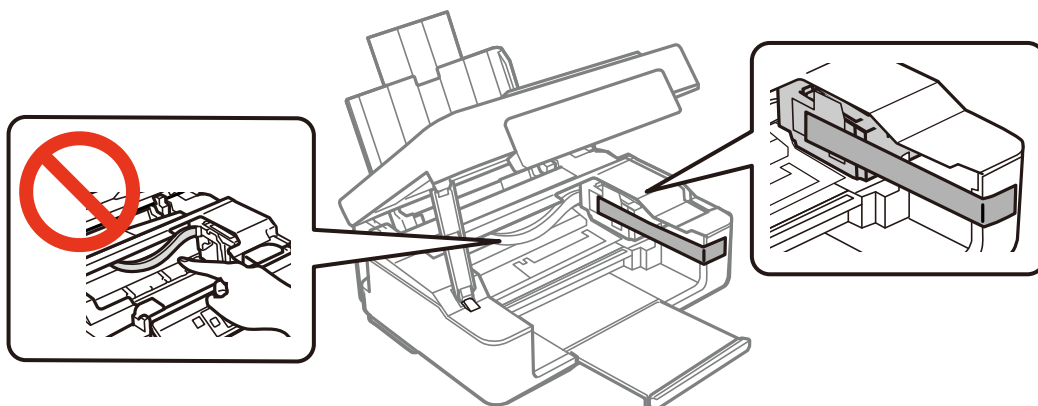

## Appendix

7. Close the scanner unit.

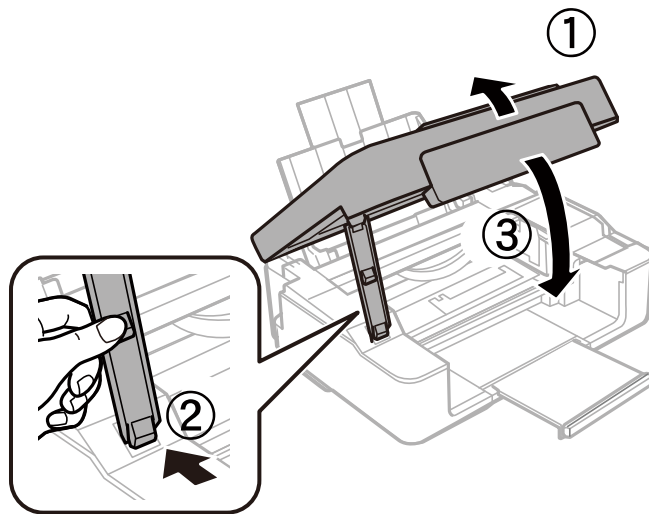

8. Prepare to pack the printer as shown below.

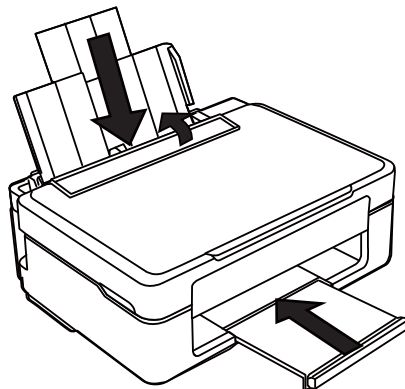

9. Pack the printer in its box, using the protective materials.

When you use the printer again, make sure you remove the tape securing the ink cartridge holder. If print quality has declined the next time you print, clean and align the print head.

### Related Information

- ➔ [“Part Names and Functions” on page 12](#)
- ➔ [“Checking and Cleaning the Print Head” on page 80](#)
- ➔ [“Aligning the Print Head” on page 81](#)

---

## Where to Get Help

### Technical Support Web Site

If you need further help, visit the Epson support website shown below. Select your country or region and go to the support section of your local Epson website. The latest drivers, FAQs, manuals, or other downloadables are also available from the site.

<http://support.epson.net/>

<http://www.epson.eu/Support> (Europe)

If your Epson product is not operating properly and you cannot solve the problem, contact Epson support services for assistance.

### Contacting Epson Support

#### Before Contacting Epson

If your Epson product is not operating properly and you cannot solve the problem using the troubleshooting information in your product manuals, contact Epson support services for assistance. If Epson support for your area is not listed below, contact the dealer where you purchased your product.

Epson support will be able to help you much more quickly if you give them the following information:

- Product serial number  
(The serial number label is usually on the back of the product.)
- Product model
- Product software version  
(Click **About**, **Version Info**, or a similar button in the product software.)
- Brand and model of your computer
- Your computer operating system name and version
- Names and versions of the software applications you normally use with your product

**Note:**

*Depending on the product, the dial list data for fax and/or network settings may be stored in the product's memory. Due to breakdown or repair of a product, data and/or settings may be lost. Epson shall not be responsible for the loss of any data, for backing up or recovering data and/or settings even during a warranty period. We recommend that you make your own backup data or take notes.*

#### Help for Users in Europe

Check your Pan-European Warranty Document for information on how to contact Epson support.

#### Help for Users in Taiwan

Contacts for information, support, and services are:

##### World Wide Web

<http://www.epson.com.tw>

## Appendix

Information on product specifications, drivers for download, and products enquiry are available.

### Epson HelpDesk

Phone: +886-2-80242008

Our HelpDesk team can help you with the following over the phone:

- Sales enquiries and product information
- Product usage questions or problems
- Enquiries on repair service and warranty

### Repair service center:

<http://www.tekcare.com.tw/branchMap.page>

TekCare corporation is an authorized service center for Epson Taiwan Technology & Trading Ltd.

## Help for Users in Australia

Epson Australia wishes to provide you with a high level of customer service. In addition to your product manuals, we provide the following sources for obtaining information:

### Internet URL

<http://www.epson.com.au>

Access the Epson Australia World Wide Web pages. Worth taking your modem here for the occasional surf! The site provides a download area for drivers, Epson contact points, new product information and technical support (e-mail).

### Epson Helpdesk

Phone: 1300-361-054

Epson Helpdesk is provided as a final backup to make sure our clients have access to advice. Operators on the Helpdesk can aid you in installing, configuring and operating your Epson product. Our Pre-sales Helpdesk staff can provide literature on new Epson products and advise where the nearest dealer or service agent is located. Many types of queries are answered here.

We encourage you to have all the relevant information on hand when you ring. The more information you prepare, the faster we can help solve the problem. This information includes your Epson product manuals, type of computer, operating system, application programs, and any information you feel is required.

### Transportation of Product

Epson recommends retaining product packaging for future transportation.

## Help for Users in Singapore

Sources of information, support, and services available from Epson Singapore are:

### World Wide Web

<http://www.epson.com.sg>

Information on product specifications, drivers for download, Frequently Asked Questions (FAQ), Sales Enquiries, and Technical Support via e-mail are available.

## Appendix

### Epson HelpDesk

Toll Free: 800-120-5564

Our HelpDesk team can help you with the following over the phone:

- Sales enquiries and product information
- Product usage questions or problem troubleshooting
- Enquiries on repair service and warranty

### Help for Users in Hong Kong

To obtain technical support as well as other after-sales services, users are welcome to contact Epson Hong Kong Limited.

### Internet Home Page

<http://www.epson.com.hk>

Epson Hong Kong has established a local home page in both Chinese and English on the Internet to provide users with the following information:

- Product information
- Answers to Frequently Asked Questions (FAQs)
- Latest versions of Epson product drivers

### Technical Support Hotline

You can also contact our technical staff at the following telephone and fax numbers:

Phone: 852-2827-8911

Fax: 852-2827-4383