

Amphenol SOCAPEX

254 Series HE701/HE901

Board to Board Interconnect Solutions

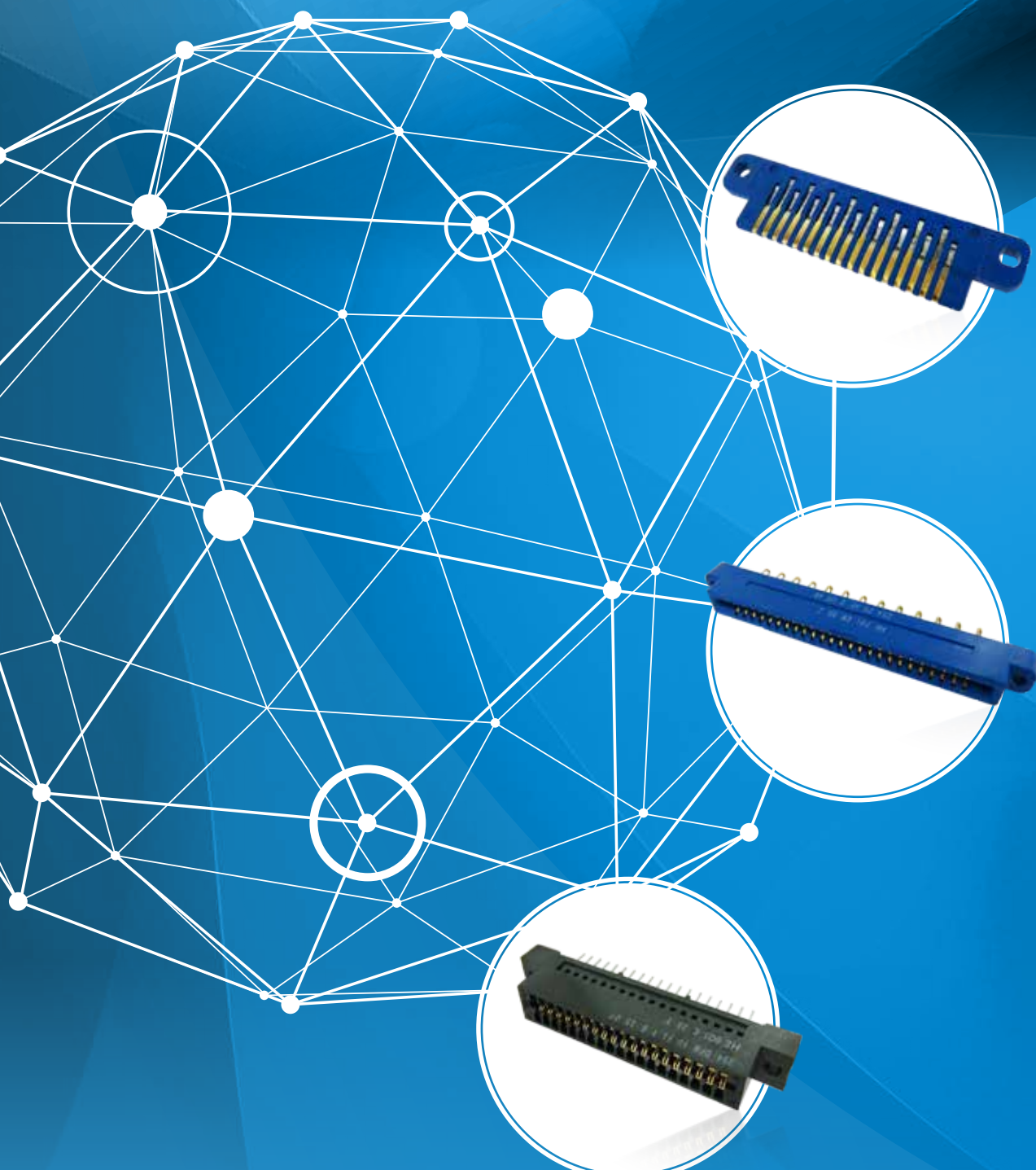

Amphenol in brief

Amphenol is one of the largest manufacturers of interconnect products in the world. The Company designs, manufactures and markets electrical, electronic and fiber optic connectors, coaxial and flat-ribbon cable, and interconnect systems.

The primary end markets for the Company's products are communications and information processing markets, including cable television, cellular telephone and data communication and information processing systems; aerospace and military electronics; and automotive, rail and other transportation and industrial applications.



Amphenol Socapex in brief

Amphenol Socapex is part of Amphenol Corporate. The company has subsidiaries in France, India, China, and in the United States. Amphenol Socapex is a market leader of MIL-DTL-38999 and derived products, high density board level connectors, field bus and rugged Ethernet solutions, harsh environment optical connectors, MIL-DTL-26482 Series I rugged industrial solutions and EN2997 connectors.

Amphenol Socapex is able to meet customer satisfaction through:

- Agile & Lean Organization
- Global Sourcing
- State-of-the-Art Manufacturing
- Custom design capability
- Competitive Independent Workshops

Amphenol Socapex is aware of environmental issues. Indeed, most of our product solutions are compliant with the European RoHS directive concerning electrical and electronic equipment.

Amphenol Socapex Markets

Military & Aerospace markets:

- Military and commercial avionics and airframe: engines, airframes, cockpit, landing gears...
- C4ISR Land: communication systems, radio...
- Ground vehicles
- Marine applications
- Weapons / Munitions
- Space: communications satellites



Industrial markets:

- Oil & Gas: geophysics, drilling, production
- Small Urban Electrical Vehicle
- Mining: surface and underground mining, ...
- Factory Automation: Machine tool, Networks, Field Buses,...
- Railway: Signaling, Ground and On Board Equipments,...
- Homeland security: CCTV (video), access control,...
- Entertainment



254 DF / HE901

Double-sided connectors for PCB

The 254 series is a double sided, 2,54 [.100] pitch, range of connectors for printed circuit boards.

Both direct or indirect connections could be made:

- For direct connection, the female receptacle mates with a $1,6 \pm 0,2$ [.063 \pm .008] printed circuit board
- For indirect connection, the female receptacle mates with the male plugs

A well-proven technology

- The 254 series uses a 2,54[.100] pitch, double sided.
- The arrangements available are from 2x13 contacts to 2 x 55 contacts.
- The contact technology is based on a turning fork concept.

A simple choice of solutions, adaptable to all type of configurations

- For motherboard: female receptacles with straight PC tails (Y).
- For extender boards: female extender with right angle PC tails (YC).
- For mounting on cables: female receptacle with solder cup contacts (Z).
- In case of direct connection: the female receptacle mates directly with a 1,6 [.063] printed circuit board.
- In case of indirect connection, the male plug with SMT contacts (U) is used.
- Various polarization system are available (for both direct or indirect connection).

The 254 series complies with here below standards:

NFC/UTE 93-423
HE901

QUICK SELECTION GUIDE

Connector 254 DFN / HE901			+	Polarization system
Signal contacts	Number of contacts			
Female Straight PC tails Y Solder cup Z Right angle PC tails (YC, for extender)	Male SMT (U)	2 x 13 2 x 19 2 x 25 2 x 31 2 x 37 2 x 43 2 x 49 2 x 50 2 x 55		For direct connection For indirect connection 254DFD
Page 8	Page 8	Page 10 to 12		Page 13

254 DF / HE901 Series

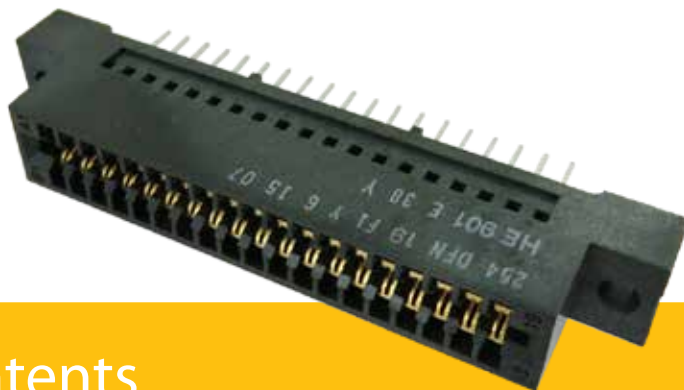

254 DF / HE901 Series

Table of contents

254DF/HE9 product range	4
Signal contacts	8
Polarization	9
Typical arrangements and layouts, female receptacle	10
Typical arrangements and layouts, female extender	11
Typical arrangements and layouts, male plug	12
Typical arrangements and layouts, polarization system for indirect connection	13
Tooling	14

The 254 DF/ HE9 series serves various **markets**, including :



Security & Defense

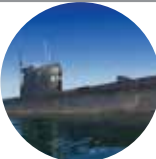

Navy



Industrial

254 DF / HE901 >>> GENERAL SPECIFICATIONS

MEDIUM
DENSITY

- 2,54[.100] pitch
- Proven and reliable double-sided PCB connectors
- Direct connection: female receptacle mates with $1,6 \pm 0,2$ [.063 \pm .008] printed circuit board
- Indirect connection: female receptacle mates with male plug

Main characteristics

- 2 x 13 to 2 x 55 signal contacts
- 3A per signal contact
- Fully compatible with all the standard connectors HE901 on the market

Markets



254 DF / HE901

Standard

NFC/UTE 93/423
HE901

How to order

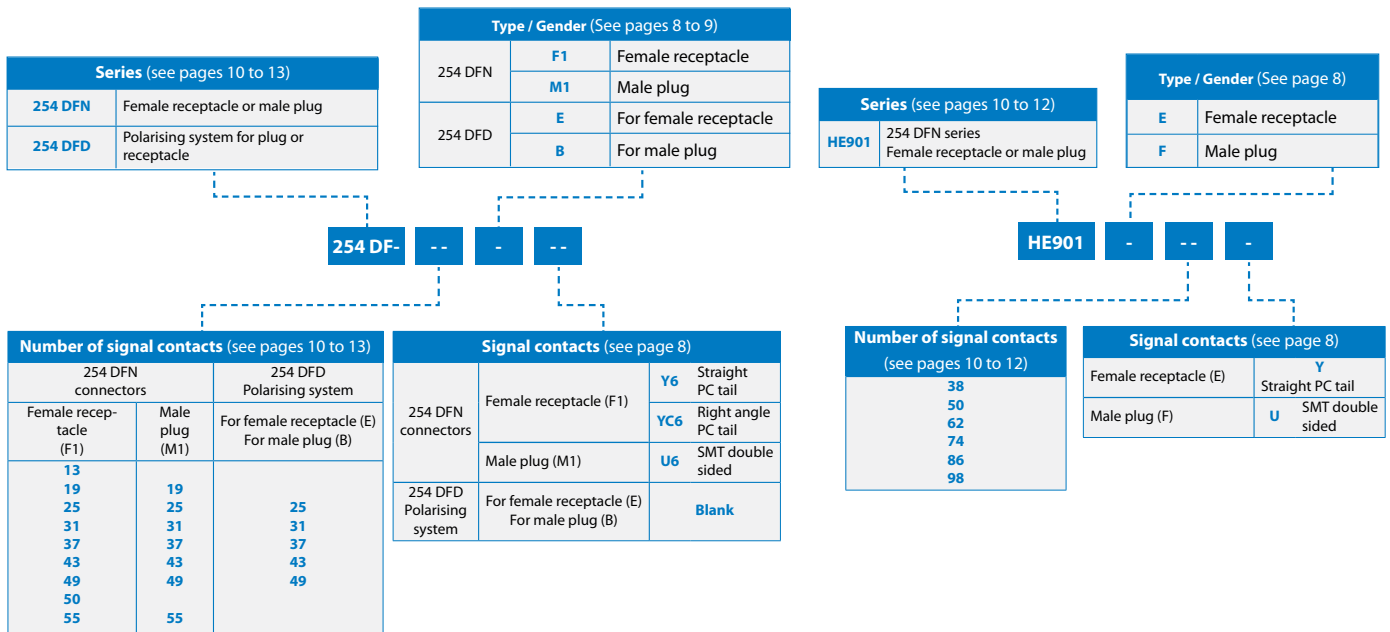

254 DF / HE901 >>> GENERAL SPECIFICATIONS

Dimensional characteristics

Receptacle

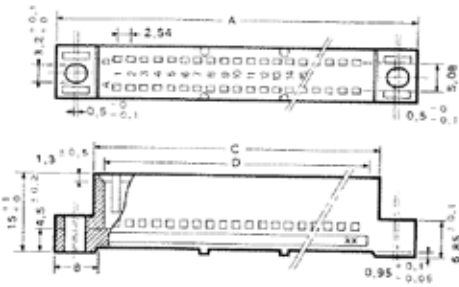

A = 53,8 [2.118] to 160,40 [6.315]
 B = 10 [.394]
 H = 15 [.591]

Plug

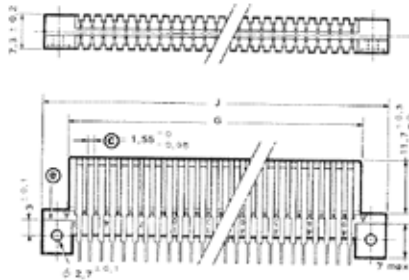

J = 62,58 [2.464] to 154,02 [6.064]
 B = 7,3 [.287]
 H = XXX[]

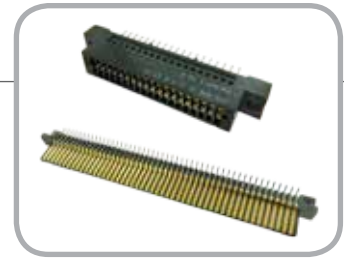

Female contact



Bifurcated top removable contact (Y & Z)

Material

- Copper alloy

Plating

- Terminations: tin lead
- Active contact area: gold over XXX

Male contact



Material

- Copper alloy

Plating

- Terminations: tin lead
- Active contact area: gold over XXX

Materials

- **Polarising key:** thermoplastic
- **Polarizing system for indirect connection:** PBT, glass loaded
- **Plastic insert:** self extinguishing thermoset

MECHANICAL CHARACTERISTICS	254 DF / HE901
Backoff ¹ (mm)	1.25 _{MAX}
Mating force per contact (N)	2.7 _{MAX}
Unmating force per contact (N)	
Contact retention in housing (N)	
Solder on wire	40 _{MIN}
Straight PC tail / SMT	20 _{MIN}
ENVIRONMENTAL CHARACTERISTICS	
Thermal shocks (°C)	-55 / +125
Salt Spray (hours)	96
ELECTRICAL CHARACTERISTICS	
Current rating per contacts (A)	3
Insulation resistance (GΩ)	5 _{MIN}
Contact resistance (mΩ)	10 _{MAX}
Dielectric Withstanding Voltage (Vrms)	1000
Capacitance between contacts (pF)	5 _{MAX}
Service voltage at 50Hz	250

¹: When both connectors are fully mated, the backoff is the maximum distance the connectors can be unmated while functioning properly

254 DF / HE901 >>> GENERAL SPECIFICATIONS (1)

Direct connection is made by a female receptacle directly mated with a $1,6 \pm 0,2$ [$.063 \pm .008$] printed circuit board

Indirect connection is made by a female receptacle mated with a male plug (two-part connectors)



FEMALE CONTACTS

Straight PC tail

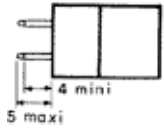

- Thru hole soldering
- Used for direct connection: mate with a $1,6 \pm 0,2$ [$.063 \pm .008$] printed circuit board
- Used for indirect connection: mate with male plug
- Mother board
- PCB thickness: $3,2_{MAX}$ [$.126$]
- To order the contact alone: 049508



Termination style

254 DF	Y6
HE901	Y

Right angle PC tail

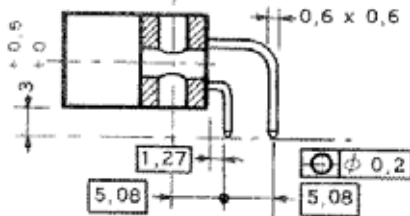

- Thru hole soldering
- Used for direct connection: mate with a $1,6 \pm 0,2$ [$.063 \pm .008$] printed circuit board
- Used for indirect connection: mate with male plug
- Extender board
- Termination section: $0,6 \times 0,6$ [$.024 \times .024$]



Termination style

254 DF	YC6
--------	-----

MALE CONTACTS

SMT double side

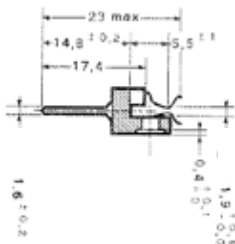

- SMT soldering
- Used for indirect connection: mate with female receptacle
- Double side daughter board
- PCB thickness: $1,6 \pm 0,2$ [$.063 \pm .008$]



Termination style

254 DF	U6
HE901	U

** Except for crimp contacts

* Consult us

All dimensions are given for information only and are in mm [inch], except as otherwise specified

254 DF / HE901 >>> POLARIZATION

FOR DIRECT CONNECTION

Direct connection is made by a female receptacle directly mated with a $1,6 \pm 0,2$ [.063 ± .008] printed circuit board

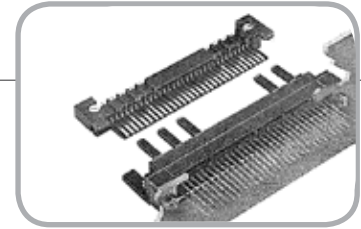

With a loss of contacts

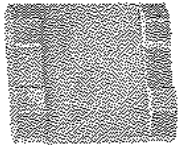

- A polarizing key is mounted in place of a contact pair, with a corresponding cut-out in the circuit board

Part number:

Width 1_{MAX} [.039]

Width 1,2_{MAX} [.047]

049534

021736

With a loss of contacts



- A polarizing key is mounted on the barrier between two contact cavities, with a corresponding cut-out in the circuit board
- **1:** Polarising key mounted in a receptacle

Width 0,7_{MAX} [.028]

020917

FOR INDIRECT CONNECTION

Indirect connection is made by a female receptacle mated with a male plug (two-part connectors)

The polarizing system is done by:

A polarization part, mounted on the plug

A polarization part mounted on the receptacle

Polarization is made without loss of contacts

For female receptacle

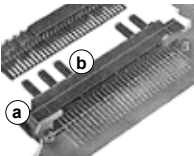

- 2 guides **(a)**
- 10 keying fingers **(b)**
- 5 identified by letters, from A to E on one side
- 5 identified by figures, from 1 to 5 on the other side
- To key the connection, break off 1 to 3 fingers on each side (no matter the position)
- It is preferable to keep at least 2 fingers on each side, corresponding to the opened cavities on the plug system

Part number

254 DFD**E

For male plug

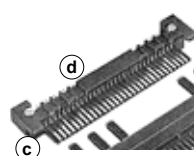

- 2 posts **(c)** for guiding
- 10 closed cavities **(d)**
- 5 identified by letters, from A to E on one side
- 5 identified by figures, from 1 to 5 on the other side
- To key the connection, open 1 to 4 cavities on each side (no matter the position) corresponding to the remaining fingers on the receptacle system

Part number

254 DFD**B

254 DF / HE901 >>> TYPICAL ARRANGEMENTS

FEMALE RECEPTACLES

Equipped with straight PC tails or solder cup contacts (Y or Z)



External dimensions

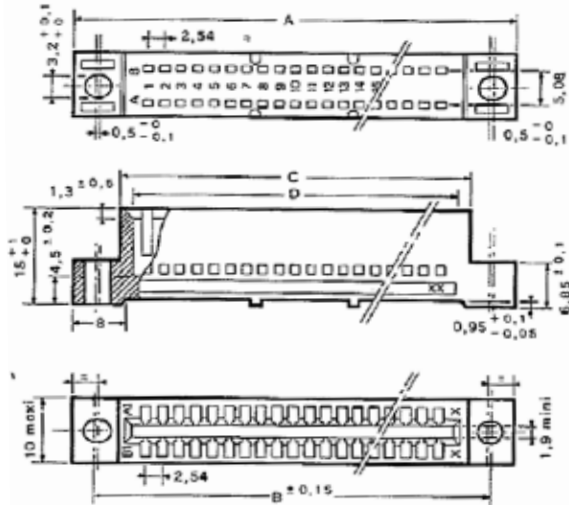

** : number of contacts
* : type of contacts (Z or Y)

Part number

254 DFN** F1 *6
HE901 E ** *

Mother board layout

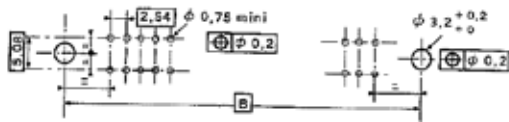

- Female receptacle equipped with straight PC tails (Y)
- The positional tolerance of the holes is 0,1 [.004] from the theoretical position

Part number

254 DFN** F1 Y6
HE901 E ** Y

Panel cut outs

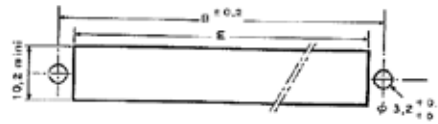

- Female receptacle equipped with solder cup contacts (Z)

Part number

254 DFN** F1 Z6
HE901 E ** Z

Daughterboard layout (for direct connection only)

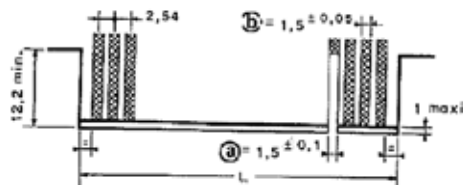

- Direct connection is made by a female receptacle directly mated with a $1,6 \pm 0,2$ [.063 \pm .008] printed circuit board
- Daughterboard cut outs
- (a) Slot for polarizing key 049534 or 021736
- (b) Track width

Number of contacts	A ⁻⁰ ₋₁	B	C ⁻⁰ _{-0,5}	D ^{+0,2} ₊₀	E _{MIN}	L ⁻⁰ _{-0,2}	Weight (g)
2 x 13	53,8 [2.118]	46,7 [1.839]	39,5 [1.555]	35,4 [1.394]	41,2 [1.622]	35,3 [1.390]	9
2 x 19	69,00 [2.716]	62,00 [2.441]	54,70 [2.154]	50,60 [1.992]	56,40 [2.220]	50,50 [1.988]	12
2 x 25	84,20 [3.315]	77,20 [3.039]	70,00 [2.756]	65,90 [2.594]	71,60 [2.819]	65,80 [2.591]	15
2 x 31	99,50 [3.917]	92,50 [3.642]	85,20 [3.354]	81,10 [3.193]	86,90 [3.421]	81,00 [3.189]	19
2 x 37	114,70 [4.516]	107,70 [4.240]	100,50 [3.957]	96,40 [3.795]	102,10 [4.020]	96,30 [3.791]	22
2 x 43	129,90 [5.114]	122,90 [4.839]	115,70 [4.555]	111,60 [4.394]	117,30 [4.618]	111,50 [4.390]	25
2 x 49	145,20 [5.717]	138,20 [5.441]	131,00 [5.157]	126,80 [4.992]	132,60 [5.220]	126,70 [4.988]	28
2 x 50	147,74 [5.817]	140,74 [5.541]	133,54 [5.257]	129,34 [5.092]	135,34 [5.328]	129,24 [5.088]	29
2 x 55	160,40 [6.315]	153,40 [6.039]	146,20 [5.756]	142,10 [5.594]	147,80 [5.819]	142,00 [5.591]	32

All dimensions are given for information only and are in mm [inch], except as otherwise specified

254 DF / HE901 >>> TYPICAL ARRANGEMENTS

FEMALE EXTENDER

Equipped with right angle PC tails (YC6)



External dimensions

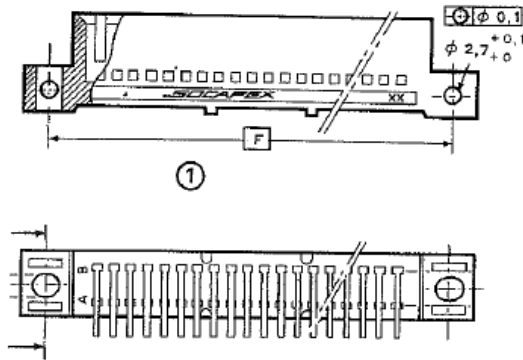

- **: number of contacts
- For other dimensions, see page 10, female receptacles
- The axis of the board soldered to the extender is offset with respect to the connecting board by $5 [1.772] + e/2$, where e is the thickness of the board soldered to the extender

Part number

254 DFN** F1/YC6

External board layout

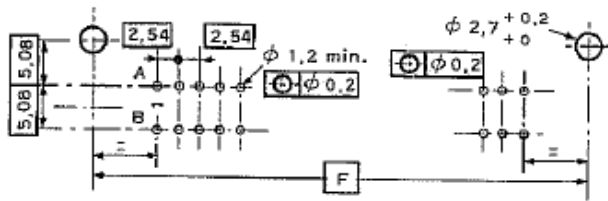

- Female receptacle equipped with right angle PC tails (YC)
- The marking of rows A and B and contact 1 are given by way of indication

Part number

254 DFN** F1/YC6

Number of contacts	F ± 0.15	Weight (g)
2 x 19	61,5 [2.421]	14
2 x 25	76,7 [3.020]	17
2 x 31	92 [3.622]	20
2 x 37	107,2 [4.220]	24
2 x 43	122,4 [4.819]	27
2 x 49	137,7 [5.421]	31
2 x 50	104,24 [4.104]	32

All dimensions are given for information only and are in mm [inch], except as otherwise specified

254 DF / HE901 >>> TYPICAL ARRANGEMENTS

MALE PLUG

Equipped with SMT contacts (U)

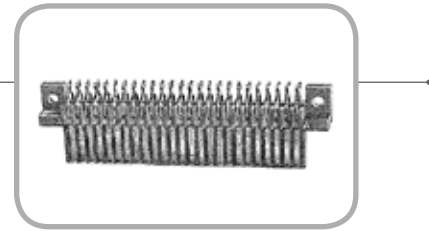

External dimensions

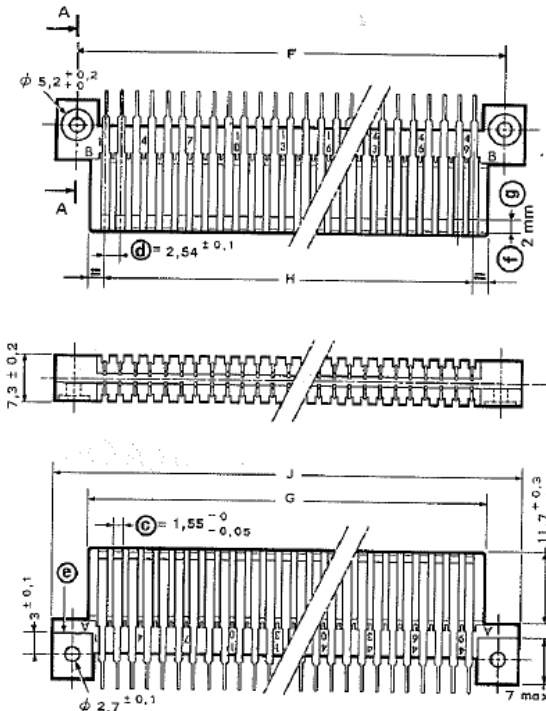

- **: number of contacts
- (a) moulding board slot
- (b) over contacts
- (c) over contacts
- (d) non cumulative tolerance
- (e) board edge
- (f) end of the standard contact
- (g) end of the short contact

Part number

254 DFN ** M1 U6
HE901 F** U

Daughterboard layout (for indirect connection only)

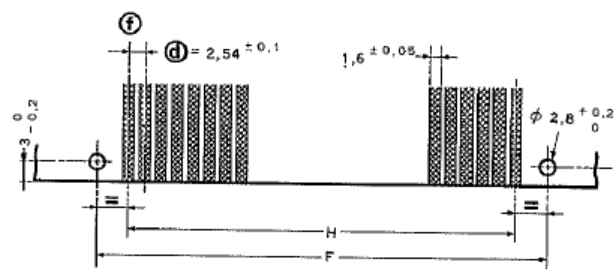

- Indirect connection is made by a female receptacle mated with a male plug (two-part connectors)
- Daughterboard cut out
- (d) non cumulative tolerance
- (f) reference axis

Part number

254 DFN ** M1 U6
HE901 F** U

Number of contacts	F ± 0,2 [.008]	H ± 0,1 [.004]	J ₋₁ ⁰	G _{-0,2} ⁰	Weight (g)
2 x 19	55,88 [2.200]	45,72 [1.800]	62,58 [2.464]	50,50 [1.988]	9
2 x 25	71,12 [2.800]	60,96 [2.400]	77,82 [3.064]	65,80 [2.591]	11
2 x 31	86,36 [3.400]	76,20 [3.000]	93,06 [3.664]	81,00 [3.189]	13
2 x 37	101,6 [4.000]	91,44 [3.600]	108,30 [4.264]	96,30 [3.791]	15
2 x 43	116,84 [4.600]	106,68 [4.200]	123,54 [4.864]	111,50 [4.390]	17
2 x 49	132,08 [5.200]	121,92 [4.800]	138,78 [4.464]	126,7 [4.988]	19
2 x 55	147,32 [5.800]	137,16 [5.400]	154,02 [6.064]	141,98 [5.590]	21

All dimensions are given for information only and are in mm [inch], except as otherwise specified

254 DF / HE901 >>> TYPICAL ARRANGEMENTS

POLARIZATION SYSTEM FOR INDIRECT CONNECTION

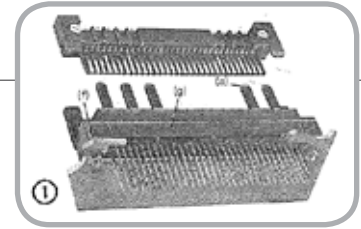

Indirect connection is made by a female receptacle mated with a male plug (two-part connectors)

External dimensions - receptacle polarization system

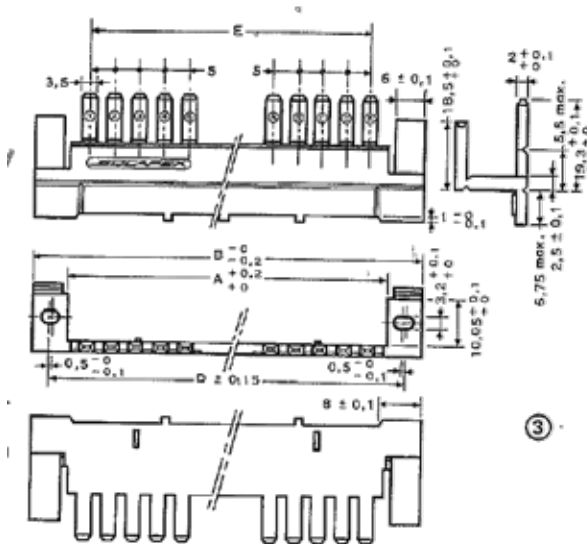

- **: number of contacts
- Indirect connection is made by a female receptacle mated with a male plug (two-part connectors)
- Polarization system for receptacle equipped with straight PC tails (Y) or solder cup contacts (Z)
- Receptacle mounting details:
 - 15,24 [.600] spacing, enabling both orientation and polarization
 - 12,7 [.500] spacing, with orientation only, all fingers (a) in figure (1) removed
 - Mounting from front of panel
 1. See standard panel cut out detail page 10
 2. The polarizing system is fitted directly on to the receptacle, as in figure (1), and secured simultaneously
 - Mounting from rear of panel
 1. Maximum panel thickness: 2,5 [.098]
 2. See standard panel cut out detail page 10
 3. Break the skirts (f) + (g) on the polarizing system. The finger support abuts on the panel.
 4. Cut out greater than 14,5 [.571]. Break off the corner (f) of the polarizing system skirt.
- The receptacle is mounted from the rear of the panel, the polarizing system from the front, as shown in (2). The assembly is fixed together at either end.

Part number **254 DFD ** E**

External dimensions - plug polarization system

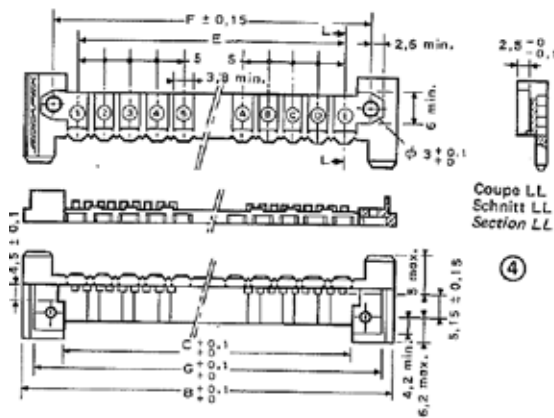

- **: number of contacts
- Indirect connection is made by a female receptacle mated with a male plug (two-part connectors)
- Polarization system for plug equipped with SMT contacts (U)
- Plug mounting details
 1. The polarizing system fits on the plug as shown in figure (1) using the nuts and bolts supplied with the plug

Part number **254 DFD ** B**

Number of contacts	A	B	C	D	E	F	G
2 x 19	55 [2.165]	68 [2.677]	50,40 [1.984]	62 [2.441]	46,60 [1.835]	55,88 [2.200]	63 [2.480]
2 x 25	70,24 [2.765]	83,24 [3.277]	65,64 [2.584]	77,24 [3.041]	61,84 [2.435]	71,12 [2.800]	78,24 [3.080]
2 x 31	85,48 [3.365]	98,48 [3.877]	80,88 [3.184]	92,48 [3.641]	77,08 [3.035]	86,36 [3.400]	93,48 [3.680]
2 x 37	100,72 [3.965]	113,72 [4.477]	96,12 [3.784]	107,72 [4.241]	92,32 [3.635]	101,60 [4.000]	108,72 [4.280]
2 x 43	115,96 [4.565]	128,96 [5.077]	111,36 [4.384]	122,96 [4.841]	107,56 [4.235]	116,84 [4.600]	123,96 [4.880]
2 x 49	131,20 [5.165]	144,20 [5.677]	126,60 [4.984]	138,20 [5.441]	122,80 [4.835]	132,08 [5.200]	139,20 [5.480]

254 DF / HE901 >>> TOOLING

REMOVAL TOOLS

WARNING: a contact extracted must not be used again

49532

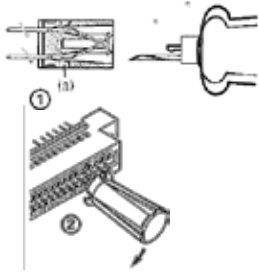

- Contact removal tool for receptacles mounted one against the other
- Straight PC tails (Y) or solder cup contacts (Z)
- Front release

1. Insert the tool in the cavity, between the contact and the edge of the moulding, perpendicular to the mating face (1). The tip of the tool should be visible through the window in the moulding (a)
2. Push the tool home, keeping it perpendicular until it contacts the moulding (2)
3. Push the tool right over towards the outer edge of the mounting (2)
4. Pull the tool out, the contact will come with it

Part number

049532

20300

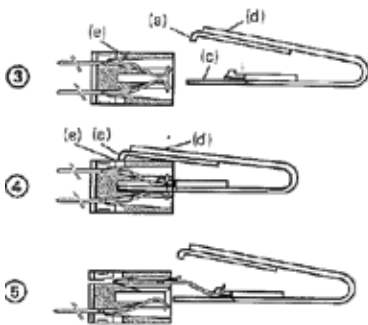

- Contact removal tool for receptacles mounted on 15,24 [.600] centres
- Straight PC tails (Y) or solder cup contacts (Z)
- Front release

- (3): Respective position of tool and receptacle
1. Push the tool as far as it will go (4)
 - The guide (c) abuts the bottom of the moulding
 - The spigot (a) is opposite the slot (e)
 2. Press on part (d) of the tool, the contact tongue is disengaged from its place
 3. Cease pressing on part (d)
 4. Withdraw tool and the imprisoned contact (5)

Part number

020300

20188

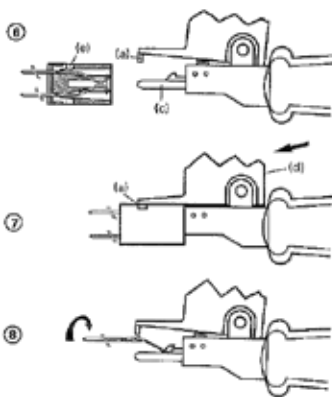

- Contact removal tool for receptacles mounted on 12,7 [.500] centres
- Straight PC tails (Y) or solder cup contacts (Z)
- Front release

- (6): Respective positions of tool and receptacle (guide (c) along the axis of the connector)
1. Push the tool home (7)
 - The guide (c) goes to the bottom of the moulding
 - The spigot (a) is opposite the hole (e)
 2. Press on part (d) of the tool, in the direction indicated by the arrow (7). The contact retention is released
 3. Release pressure (d)
 4. Pull back the tool with contact attached (8)
 5. Remove the contact by turning it through 90°

Part number

020188

INSERTION TOOLS

49533

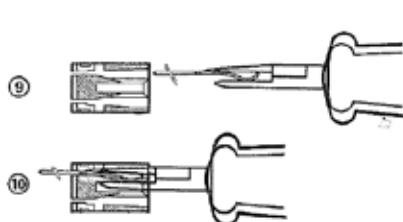

- Contact insertion tool for receptacles
- Straight PC tails (Y) or solder cup contacts (Z)

1. Insert the contact into the tool (9)
2. Insert the tool and contact together in the moulding cavity, from the board side, in the position shown on the figure (9)
3. Press the tool right home. The contact tongue positions itself in its slot (10)
4. Withdraw tool. The contact held by the tongue should remain in recess

Part number

049533

NOTES

A series of horizontal dotted lines for taking notes.

254 / HE701

Single-sided connectors for PCB

The 254 series is a single sided, 2,54 [.100] pitch, range of connectors for printed circuit boards.

Both direct or indirect connections could be made:

- For direct connection, the female receptacle mates with a $1,6 \pm 0,2$ [.063 \pm .008] printed circuit board
- For indirect connection, the female receptacle mates with the male plugs

A well-proven technology

- The 254 series uses a 2,54[.100] pitch, single sided
- The arrangements available are from 11 contacts to 47 contacts for 254 series and 6 contacts to 24 contacts for 508 series

A simple choice of solutions, adaptable to all type of configurations

- 2 receptacle versions are available:
 - Type A:
 - Floating contacts
 - Terminations in two rows, 2,54[.100] pitch
 - Type B:
 - Removable contacts
 - Terminations in two rows, 5,08[.200] pitch
- For motherboard: female receptacle with straight PC tails (Y)
- For mounting on cables: female receptacle with solder cup contacts (Z)
- For extender boards
 - Female extender with right angle PC tails (YC)
 - Type B only
 - Removable contacts
 - Terminations in two rows, 5,08[.200] pitch
- In case of direct connection: the female receptacle mates directly with a $1,6 \pm 0,2$ [.063 \pm .008] printed circuit board
- In case of indirect connection, the male plug with right angle PC tails is used. 3 versions are available
 - A: standard types as per norm
 - B: open ended mounting ears
 - C: without mounting ears
- Various polarization system are available (for both direct or indirect connection)
- The 508 series is a derivate version of the standardized range, with only odd-numbered contacts mounted

The 254 series complies with here below standards:

NFC/UTE 93-421
HE701

Series	Gender	Signal contacts	Number of contacts	Polarization system
245 series or 508 series	Female receptacle Type A Type B	Straight PC tails Y Solder cup Z Right angle PC tails (YC, for extender)	From 6 to 47	+
	Male plug Type A Type B Type C	Right angle PC tails		
Pages 18 & 27	Pages 23 to 25	Pages 20 & 21	Pages 23 to 25	Page 26

254 / HE701 Series



254 / HE701 series

Table of contents

254 / HE7 product range	16
Signal contacts, female.....	20
Signal contacts, male.....	21
Typical arrangements and layouts, female receptacles type A.....	22
Typical arrangements and layouts, female receptacles type B.....	23
Typical arrangements and layouts, female extender receptacles type B.....	24
Typical arrangements and layouts, male plug type A, B or C.....	25
Polarization	26
508 series	27
Tooling	27

The 254 / HE7 series serves various **markets**, including :



Security & Defense

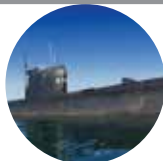

Navy



Industrial

254 / HE701 >>> GENERAL SPECIFICATIONS



- 2,54[.100] pitch
- Proven and reliable double-sided PCB connectors
- Direct connection: female receptacle mates with 1,6 ± 0,2 [.063 ± .008] printed circuit board
- Indirect connection: female receptacle mates with male plug

Main characteristics

- 2 x 13 to 2 x 55 signal contacts
- 3A per signal contact
- Fully compatible with all the standard connectors HE701 on the market

Markets



254 / HE701

Standard

NFC/UTE 93/421
HE701

How to order

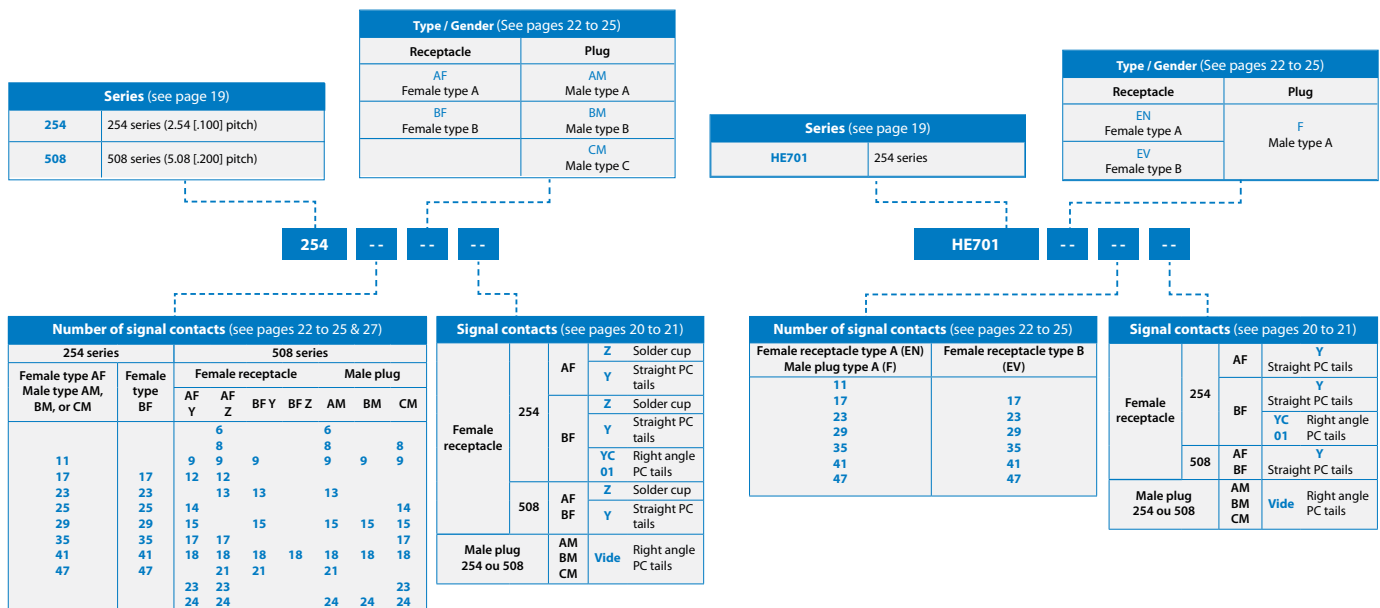

254 / HE701 >>> GENERAL SPECIFICATIONS

Dimensional characteristics

Receptacle

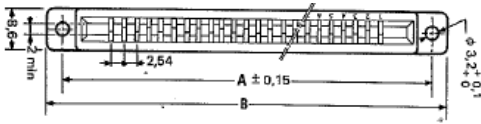

Plug

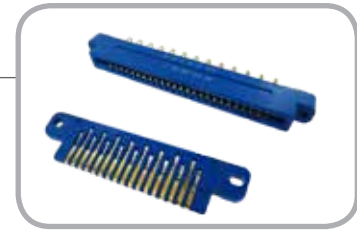
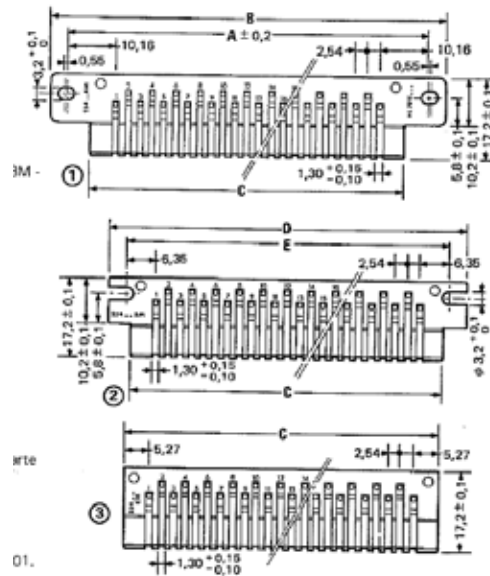

Receptacle:

- B = 53,1 [2.091] to 144,6 [5.693] (type A)
- B = 68,4 [2.693] to 144,6 [5.693] (type B)

Plug:

- B = 53,1 [2.091] to 144,6 [5.693] (Type A)
- D = 45,5 [1.791] to 136,9 [5.390] (Type B)
- C = 35,95 [1.415] to 127,40 [5.016] (Type C)

508 series:

Connectors are made from the same mouldings and contacts as 254 series. Only odd-numbered contacts are mounted

Female contact



Floating lyre contact (Y & Z) for type A
Patented double lyre contact (Z, Z & YC) for type B

Material

- Copper alloy

Plating

- Terminations: gold over nickel
- Active contact area: gold over nickel

Materials

- Polarising key: thermoplastic
- Plastic insert: thermoset

Male contact



Material

- Copper alloy

Plating

- Terminations: gold over nickel
- Active contact area: gold over nickel

MECHANICAL CHARACTERISTICS	254 / HE701
Backoff¹ (mm)	1.20 _{MAX}
Mating force per contact pair (N)	
Unmating force per contact pair (N)	2.7 _{MAX}
Contact retention in housing (N)	
Solder on wire	20 _{MIN}
Straight PC tail / SMT	20 _{MIN}
ENVIRONMENTAL CHARACTERISTICS	
Thermal shocks (°C)	-55 / +125
ELECTRICAL CHARACTERISTICS	
Current rating per contacts (A) direct connection	3
Current rating per contacts (A) indirect connection	5
Insulation resistance (GΩ)	5 _{MIN}
Contact resistance (mΩ)	10 _{MAX}
Capacitance between contacts (pF)	5 _{MAX}
Service voltage at 50Hz	200
Test voltage at sea level (Vrms)	900
Test voltage at 20 mbar (Vrms)	200

1: When both connectors are fully mated, the backoff is the maximum distance the connectors can be unmated while functioning properly

254 / HE701 >>> SIGNAL CONTACT

Direct connection is made by a female receptacle directly mated with a $1,6 \pm 0,2$ [.063 \pm .008] printed circuit board

Indirect connection is made by a female receptacle mated with a male plug (two-part connectors)

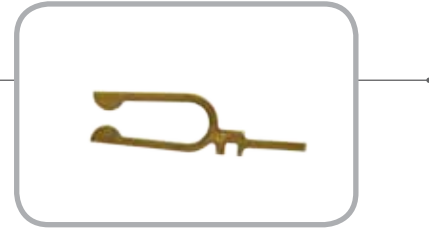

FEMALE CONTACTS TYPE A

Floating contacts, terminations in two row, 2,54 [.100] pitch

Straight PC tail

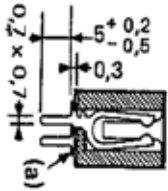

- Thru hole soldering
- Used for direct connection: mate with a $1,6 \pm 0,2$ [.063 \pm .008] printed circuit board
- Used for indirect connection: mate with male plug
- Mother board
- Termination section: $0,7 \times 0,7$ [.028 \times .028]
- PCB thickness: 3,2 MAX [.126]
- Weight: 0,15g

(a): insulated washer stuck on the underside of the end feet of connectors to enable board cleaning



Termination style

254 ** AF Y
HE701 EN ** Y

Solder cup

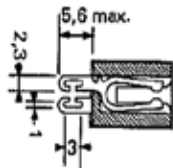

- Hard-soldering on wire
- O: 1 MAX [.039] on core section
- Used for direct connection: mate with a $1,6 \pm 0,2$ [.063 \pm .008] printed circuit board
- Used for indirect connection: mate with male plug
- Weight 0,16g



Termination style

254 ** AF Z
HE701 EN ** Z

FEMALE CONTACTS TYPE B

Removable contacts, terminations in two row, 5,08 [.200] pitch

The mention → or ← means the contact removal direction

Straight PC tail

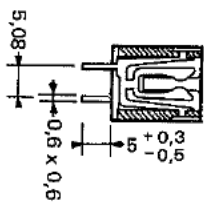

- Thru hole soldering
- Used for direct connection: mate with a $1,6 \pm 0,2$ [.063 \pm .008] printed circuit board
- Used for indirect connection: mate with male plug
- Mother board
- Termination section: $0,6 \times 0,6$ [.024 \times .024]
- PCB thickness: 3,2 MAX [.126]
- Weight: 0,27g
- To order the contact alone

043247



Termination style

254 ** BF Y
HE701 EV ** Y

Solder cup

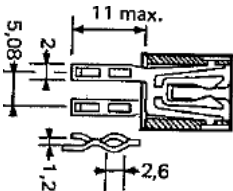

- Hard-soldering on wire
- For soldering two wires, one of which can be a busbar joining adjacent connectors (supply, ground)
- Used for direct connection: mate with a $1,6 \pm 0,2$ [.063 \pm .008] printed circuit board
- Used for indirect connection: mate with male plug
- Weight: 0,37g
- To order the contact alone

042635



Termination style

254 ** BF Z
HE701 EV ** Z

Right angle PC tail

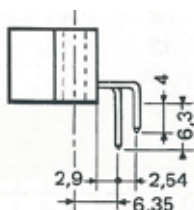

- Thru hole soldering
- Used for direct connection: mate with a $1,6 \pm 0,2$ [.063 \pm .008] printed circuit board
- Used for indirect connection: mate with male plug
- Extender board
- Weight: 0,31g

Termination style

254 ** BF YC01

254 / HE701 >>> SIGNAL CONTACT

Direct connection is made by a female receptacle directly mated with a $1,6 \pm 0,2$ [.063 \pm .008] printed circuit board

Indirect connection is made by a female receptacle mated with a male plug (two-part connectors)

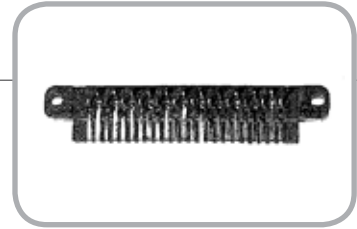
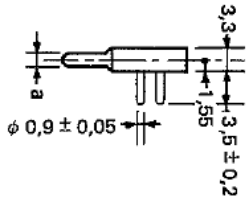
**MALE CONTACTS****Right angle PC tail**

- Thru hole soldering
- Used for indirect connection: mate with female receptacle
- Daughter board
- Termination diameter: $0,9 \pm 0,05$ [.035 \pm .002]
- PCB thickness: 2,6 MAX [.102]
- (a): 1,9 [.075] over the moulding, $1,6 \pm 0,15$ [.063 \pm .006] over the contacts



Termination style

254 ** AM
HE701 F ** Y
254 ** BM
254 ** CM

254 / HE701 >>> TYPICAL ARRANGEMENTS

FEMALE RECEPTACLES TYPE A

Equipped with straight PC tails or solder cup contacts (Y or Z)

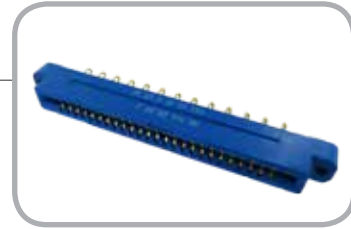

External dimensions

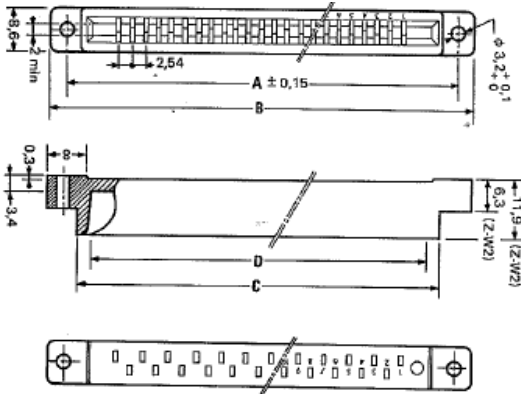

** : number of contacts
* : type of contacts (Z or Y)

Part number

254 ** AF *
HE701 EN **

Mother board layout

- Female receptacle equipped with straight PC tails (Y)
- The positional tolerance of the holes is 0,1 [0.04] from the theoretical position
- The board is shown from the connector side. Contact #1 is given for reference
- Having mounted the connector on the board, insert a male plug or a board to correctly position the contacts

Part number

254 ** AF Y
HE701 EN **Y

Panel cut outs

- Female receptacle equipped with solder cup contacts (Z)

Part number

254 ** AF Z
HE701 EN ** Z

Daughterboard layout (for direct connection only)

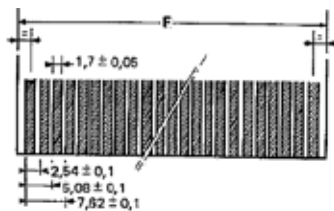

- Direct connection is made by a female receptacle directly mated with a $1,6 \pm 0,2$ [0.63 ± .008] printed circuit board
- Daughterboard cut outs

Number of contacts	A	B ± 0.3 [± .012]	C ± 0.3 [± .012]	D ^{+0.15} _{-0.1}	E _{MIN}	F ± 0.1 [± .004]	Housing weight (g)
11	46,7 [1.839]	53,1 [2.091]	40,8 [1.606]	36,05 [1.419]	41,40 [1.630]	35,85 [1.411]	5,8
17	62,0 [2.441]	68,4 [2.693]	56,1 [2.209]	51,30 [2.020]	56,60 [2.228]	51,10 [2.012]	7,6
23	77,2 [3.039]	83,6 [3.291]	71,3 [2.807]	66,55 [2.620]	71,90 [2.831]	66,35 [2.612]	9,3
25	82,3 [3.241]	88,7 [3.492]	76,4 [3.008]	71,62 [2.820]	77,00 [3.031]	71,42 [2.812]	9,9
29	92,5 [3.642]	98,9 [3.894]	86,6 [3.409]	81,80 [3.220]	87,10 [3.429]	81,60 [3.213]	11,1
35	107,7 [4.240]	114,1 [4.492]	101,8 [4.008]	97,00 [3.819]	102,40 [4.031]	96,80 [3.811]	12,8
41	122,9 [4.839]	129,3 [5.091]	117,0 [4.606]	112,25 [4.419]	117,60 [4.630]	112,05 [4.411]	14,6
47	138,2 [5.441]	144,6 [5.693]	132,3 [5.209]	127,50 [5.020]	132,90 [5.232]	127,30 [5.012]	16,4

All dimensions are given for information only and are in mm [inch], except as otherwise specified

254 / HE701 >>> TYPICAL ARRANGEMENTS

FEMALE RECEPTACLES TYPE B

Equipped with straight PC tails or solder cup contacts (Y or Z)

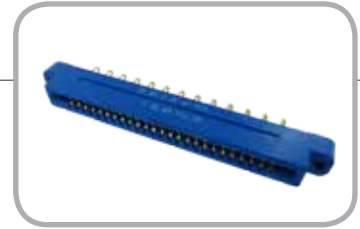

External dimensions

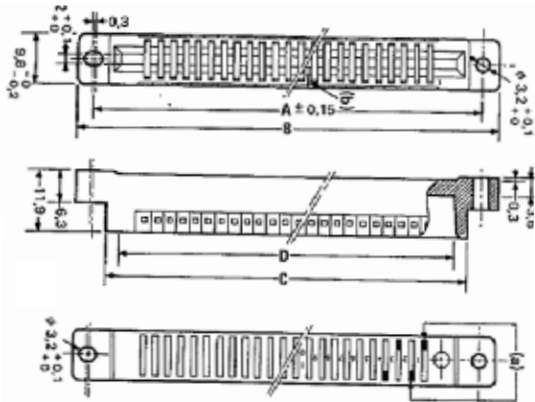

- **: number of contacts
- *: type of contacts (Z or Y)
- (a): position of contact termination
- (b): identification of every 10th contact on mating side

Part number **254 ** BF ***
HE701 EV **

Mother board layout

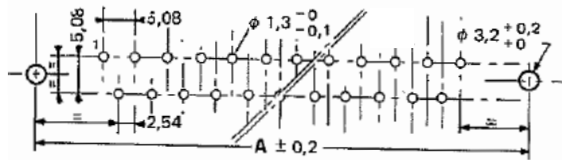

- Female receptacle equipped with straight PC tails (Y)
- The positional tolerance of the holes is 0,1 [.004] from the theoretical position
- The board is shown from the connector side. Contact #1 is given for reference

Part number **254 ** BF Y**
HE701 EV ** Y

Panel cut outs

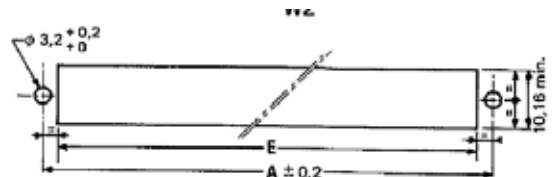

- Female receptacle equipped with solder cup contacts (Z)

Part number **254 ** BF Z**
HE701 EV ** Z

Daughterboard layout (for direct connection only)

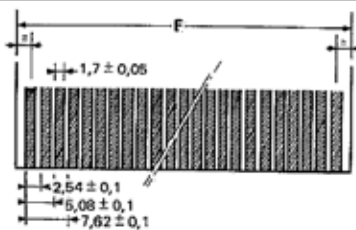

- Direct connection is made by a female receptacle directly mated with a 1,6 ± 0,2 [.063 ± .008] printed circuit board
- Daughterboard cut outs

Number of contacts	A	B ± 0.3 [± .012]	C ± 0.3 [± .012]	D ^{+0.15} / _{-0.1}	E _{MIN}	F ± 0.1 [± .004]	Housing weight (g)
17	62,0 [2.441]	68,4 [2.693]	56,1 [2.209]	51,30 [2.020]	56,60 [2.228]	51,10 [2.012]	8,7
23	77,2 [3.039]	83,6 [3.291]	71,3 [2.807]	66,55 [2.620]	71,90 [2.831]	66,35 [2.612]	10,5
25	82,3 [3.241]	88,7 [3.492]	76,4 [3.008]	71,62 [2.820]	77,00 [3.031]	71,42 [2.812]	11,2
29	92,5 [3.642]	98,9 [3.894]	86,6 [3.409]	81,80 [3.220]	87,10 [3.429]	81,60 [3.213]	12,3
35	107,7 [4.240]	114,1 [4.492]	101,8 [4.008]	97,00 [3.819]	102,40 [4.031]	96,80 [3.811]	14,2
41	122,9 [4.839]	129,3 [5.091]	117,0 [4.606]	112,25 [4.419]	117,60 [4.630]	112,05 [4.411]	16
47	138,2 [5.441]	144,6 [5.693]	132,3 [5.209]	127,50 [5.020]	132,90 [5.232]	127,30 [5.012]	17,8

254 / HE701 >>> TYPICAL ARRANGEMENTS

FEMALE EXTENDER RECEPTACLES TYPE B

Equipped with right angle PC tails (YC01)



External dimensions

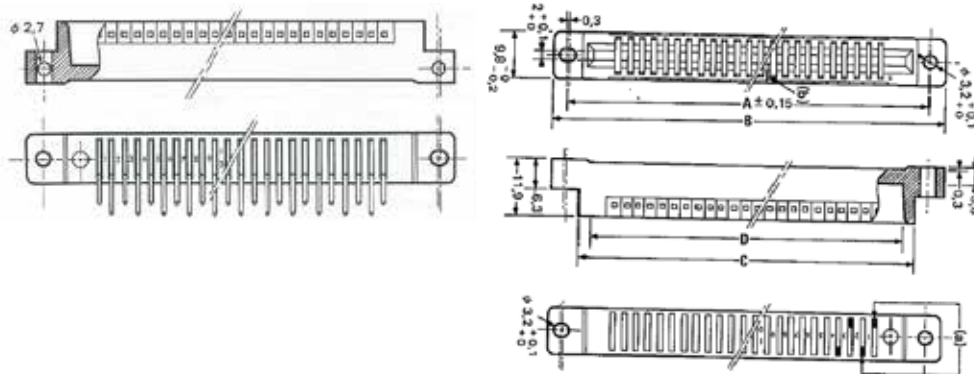

**: number of contacts

- (a): position of contact termination
- (b): identification of every 10th contact on mating side
- Housing identical to receptacles type B, with transverse drilling of end feet for board mounting

Part number 254 ** BF YC01

Extender board layout

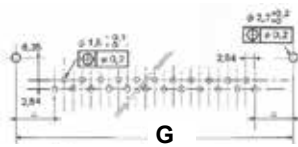

- Female receptacle equipped with right angle PC tails (YC01)
- Contact #1 is given for reference

Part number 254 ** BF YC01

Daughterboard layout (for direct connection only)

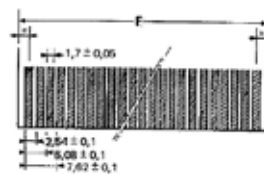

- Direct connection is made by a female receptacle directly mated with a $1,6 \pm 0,2$ [0.063 ± .008] printed circuit board
- Daughterboard cut outs

Extender board offset

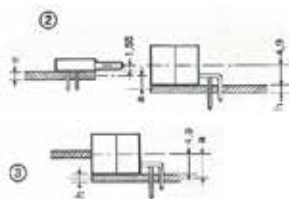

- The axis of the board soldered to the extender is offset with respect to the connecting board by a:
- Indirect insertion (2) $a = 3,35 + h/2 - e/2$
- Direct insertion (3) $a = 4,9 + h/2$
- h : thickness of the board soldered to the extender
- e : thickness of the board soldered to the plug

Number of contacts	A	B ± 0.3 [± .012]	C ± 0.3 [± .012]	D ^{+0.15} _{-0.1}	E _{MIN}	F ± 0.1 [± .004]	G	Housing weight (g)
17	62,0 [2.441]	68,4 [2.693]	56,1 [2.209]	51,30 [2.020]	56,60 [2.228]	51,10 [2.012]	62,0 [2.441]	8,7
23	77,2 [3.039]	83,6 [3.291]	71,3 [2.807]	66,55 [2.620]	71,90 [2.831]	66,35 [2.612]	77,2 [3.039]	10,5
25	82,3 [3.241]	88,7 [3.492]	76,4 [3.008]	71,62 [2.820]	77,00 [3.031]	71,42 [2.812]	82,3 [3.241]	11,2
29	92,5 [3.642]	98,9 [3.894]	86,6 [3.409]	81,80 [3.220]	87,10 [3.429]	81,60 [3.213]	92,5 [3.642]	12,3
35	107,7 [4.240]	114,1 [4.492]	101,8 [4.008]	97,00 [3.819]	102,40 [4.031]	96,80 [3.811]	107,7 [4.240]	14,2
41	122,9 [4.839]	129,3 [5.091]	117,0 [4.606]	112,25 [4.419]	117,60 [4.630]	112,05 [4.411]	122,9 [4.839]	16
47	138,2 [5.441]	144,6 [5.693]	132,3 [5.209]	127,50 [5.020]	132,90 [5.232]	127,30 [5.012]	138,2 [5.441]	17,8

All dimensions are given for information only and are in mm [inch], except as otherwise specified

254 / HE701 >>> TYPICAL ARRANGEMENTS

MALE PLUGS TYPE A, B OR C

Equipped with right angle PC tails



External dimensions

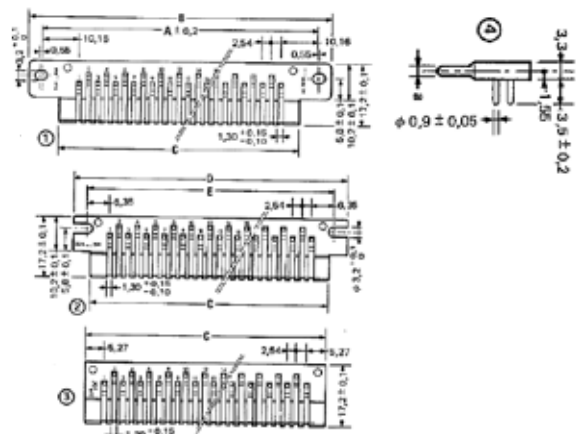

- **: number of contacts
- (1): Plug type A
- (2): Plug type B
- (3): Plug type C
- (4): Plug type A, B or C
 - (a): 1.9 [0.75] over the moulding
 - 1,6 ± 0,15 [0.63 ± .006] over the contacts

Part number	254 ** AM HE701 F ** Y 254 ** BM 254 ** CM
-------------	---

Daughter board layout

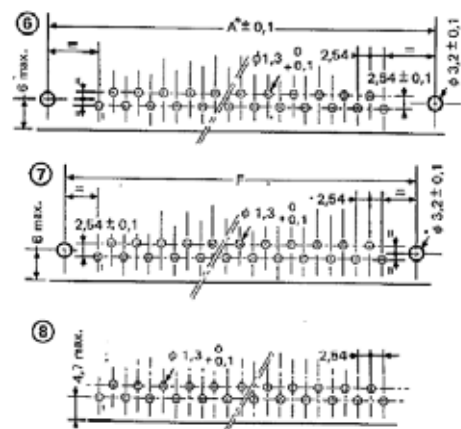

- **: number of contacts
- (6): Plug type A
 - (dimension A): fixing hole centres as per NF C/UTE 93-421
 - As connector has oblong mounting holes, the fixing centres can be increased to $A + 0,55 [0.22]$ to make the centres of the mounting holes and board holes coincide
- (7): Plug type B
- (8): Plug type C
- The positional tolerance of the holes is 0,1 [0.004] from the theoretical position
- The board is shown from the connector side. Contact #1 is given for reference

Part number	254 ** AM HE701 F ** Y 254 ** BM 254 ** CM
-------------	---

Daughter board offset

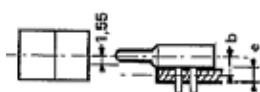

- Offset between the axis of the receptacle and the daughterboard
- $b = 1,55 + e/2$
- b : offset between axes
- e : board thickness

Number of contacts	A	B ± 0.3 [± .012]	C ⁰ _{-0.3}	D ± 0.3 [± .012]	E ± 0.2 [± .008]	F ± 0.1 [± .004]	Weight (g)	
							A or B	C
11	45,7 [1.799]	53,1 [2.091]	35,95 [1.415]	45,5 [1.791]	38,1 [1.500]	38,6 [1.520]	4	3
17	61 [2.402]	68,4 [2.693]	51,20 [2.016]	60,7 [2.390]	53,3 [2.098]	53,8 [2.118]	5	4
23	76,2 [3.000]	83,6 [3.291]	66,42 [2.615]	76 [2.992]	68,6 [2.701]	69,1 [2.720]	6	5
25	81,3 [3.201]	88,7 [3.492]	71,50 [2.815]	81,1 [3.193]	73,7 [2.902]	74,2 [2.921]	7	6
29	91,5 [3.602]	98,9 [3.894]	81,70 [3.216]	91,2 [3.591]	83,8 [3.299]	84,3 [3.319]	8	7
35	106,7 [4.201]	114,1 [4.492]	96,90 [3.815]	106,5 [4.193]	99,1 [3.902]	99,6 [3.921]	9	8
41	121,9 [4.799]	129,3 [5.091]	112,15 [4.415]	121,7 [4.791]	114,3 [4.500]	114,8 [4.520]	10	9
47	137,2 [5.402]	144,6 [5.693]	127,40 [5.016]	136,9 [5.390]	129,5 [5.098]	130 [5.118]	12	11

All dimensions are given for information only and are in mm [inch], except as otherwise specified

254 / HE701 >>> POLARIZATION

FOR DIRECT CONNECTION

Direct connection is made by a female receptacle directly mated with a $1,6 \pm 0,2$ [$.063 \pm .008$] printed circuit board

Polarizing key for female receptacle type A



- A contact is replaced by a metal key with a corresponding cut out of the printed board
- Width of key: $0,6 \pm 0,03$ [$.024 \pm .001$]

Part number

038366

Polarizing key for female receptacle type B

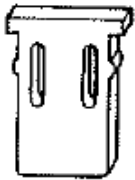

- A contact is replaced by a metal key with a corresponding cut out of the printed board
- Width of key: $0,7 \begin{smallmatrix} +0,15 \\ -0,1 \end{smallmatrix}$ [$.028 \begin{smallmatrix} +.002 \\ -.008 \end{smallmatrix}$]

Part number

042572

FOR INDIRECT CONNECTION

Indirect connection is made by a female receptacle mated with a male plug -two-part connectors)

Polarizing key for male plug / short contact*



- The polarizing keys are fitted to the male connector
 1. Remove a contact and replace it by the polarizing key
 2. Check that the polarizing key is correctly positioned and pinch it to retain it
 3. Remove the corresponding female contact from the receptacle
- Black colour

Part number

037742

Polarizing key for male plug / short contact*



- The polarizing keys are fitted to the male connector
 1. Remove a contact and replace it by the polarizing key
 2. Check that the polarizing key is correctly positioned and pinch it to retain it
 3. Remove the corresponding female contact from the receptacle
- White colour

Part number

041235

* Never mount a long polarizing key in place of a short contact and vice versa

254 / HE701 >>> 508 SERIES

508 SERIES

Connectors are made from the same mouldings and contacts as 254 series.
Only odd-numbered contacts are mounted



508 SERIES – 254 SERIES CORRESPONDING CONNECTOR

Number of contacts series 508 connector		Number of contacts in the corresponding connector of series 254
Odd contact mounted	Even contacts mounted	
6*	5*	11*
9	8	17
13	12	25
15	14	29
18	17	35
21	20	41
24	23	47

** : number of contacts
* : type of contacts (Z or Y)

Part number

508 ** AF*
508 ** BF*
508 ** AM
508 ** BM
508 ** CM

* These connectors cannot be supplied in BF version

254 / HE701 >>> TOOLING

REMOVAL TOOLS

Contact removal tool for receptacle type B



Part number

641

NOTES

254 / HE701

A series of horizontal dotted lines for taking notes, spanning most of the page width.

NOTES

A series of horizontal dotted lines for taking notes, spanning the width of the page.

254 / HE701

ABOUT AMPHENOL

Founded in 1932, **Amphenol** is one of the largest manufacturers of interconnect products in the world. The company designs, manufactures, and markets electrical, electronic, and fiber optic connectors, interconnect systems, and coaxial and specialty cables.

Amphenol has a diversified presence as a leader in high growth areas of the interconnect industry and provides solutions for customers in the automotive, broadband, industrial, information technology and data communications, military and aerospace, mobile devices, and mobile networks markets.

More info on www.amphenol.com

Amphenol
ENABLING THE ELECTRONICS REVOLUTION

Amphenol Military & Aerospace Operations (AMAO) has the largest and broadest selection of interconnect products in the military and aerospace markets.

More info on www.amphenolmao.com

Amphenol
MILITARY & AEROSPACE

Europe

FRANCE	Amphenol AIR LB	2 rue Clément Ader, ZAC de Wé - 08110 Carignan	+33 3 24 22 78 49
FRANCE	Amphenol SEFEE	Z.I. des Cazes – BP243 - 12402 Saint-Affrique Cedex	+33 5 65 98 11 00
GERMANY	Amphenol AIR LB GMBH	Am Kleinbahnhof 4 - 66740 Saarlouis	+49 6831 981 00
ITALY	Amphenol EUROPEAN SALES OPERATIONS	Via Barbaiana n.5 - 20020 Lainate - Milano	+39 293 254 214
UNITED KINGDOM	Amphenol INVOTEC	Unit 1-3, Hedging Lane Industrial Estate, Dosthill - Tamworth, B77 5HH	+44 1827 263 000
UNITED KINGDOM	Amphenol IONIX SYSTEMS	Prospect House, Taylor Business Park, Risley, Warrington, WA3 6HP	+44 1 942 685 200
UNITED KINGDOM	Amphenol LTD	Thanet Way, Whitstable - KENT, CT53JF	+44 1227 773 200
UNITED KINGDOM	Amphenol MARTEC	St Augustines Business Park, Swalecliffe Whitstable - Kent CT5 2QJ	+44 1227 793 733

North America

CANADA	Amphenol CANADA	605 Milner avenue - Toronto, Ontario	+1 416 291 0647
USA	Amphenol AEROSPACE OPERATIONS	40-60 Delaware street - Sidney, NY 13838	+1 800 678 0141
USA	Amphenol BORISH TECHNOLOGIES	4511 East Paris AVE - Grand Rapids, MI 49512	+1 616 554 9820
USA	Amphenol FSI	1300 Central Expwy N, Suite 100 - Allen, TX 75013	+1 214 547 2400
USA	Amphenol GRIFFITH ENTERPRISES	6000 East Coury Drive - Cottonwood, AZ 86326	+1 928 634 3685
USA	Amphenol NEXUS TECHNOLOGIES	50 Sunnyside Avenue - Stamford, CT 06902	+1 203 327 7300
USA	Amphenol PCD	72 Cherry Hill Drive - Beverly, MA. 01915	+1 978 624 3400
USA	Amphenol PRINTED CIRCUIT	Board Technology, 91 Northeastern Boulevard - Nashua, NH 03062	+1 603 324 4500
USA	Amphenol SV MICROWAVE	2400 Centrepark West Drive - West Palm Beach, FL	+1 561 840 1800
USA	Amphenol TIMES MICROWAVE	358 Hall Avenue - Wallingford, CT 06492	+1 800 867 2629

Asia

CHINA	Amphenol PCD CO.	Building 21, 1 st Liao Keng Industrial Zone, Shi Yan Street - Bao An District - Shenzhen 518108	+86 755 8173 8000/8286
INDIA	Amphenol INTERCONNECT INDIA	105 Bhosari Industrial Area - Pune 411 026	+91 20 27120363
JAPAN	Amphenol JAPAN	471-1, Deba, Ritto-City - Shiga 520 3041	+81 77 553 8501
KOREA	Amphenol DAESHIN	558 SongNae-Dong SoSa-Gu, Bucheon-city, Kyunggi-Do - 420-130	+81 32 610 3830/3845
SINGAPORE	Amphenol EAST ASIA	26/F, Railway Plaza, 39 Chatham Road South, Tsim Sha Tsui, Kowloon, Hong Kong	+65 6294 2128

Other Areas

AFRICA	Amphenol AFRICA	30 Impala Rd - Sandton 2146	+27 82 410 5179
ARGENTINA	Amphenol ARGENTINA	Av. Callao 930 2do piso Oficina B "Plaza" C1023 - AAP Buenos Aires	+54 11 4815 6886
AUSTRALIA	Amphenol AUSTRALIA PTY	2 Fiveways Blvd., Keysborough - Melbourne - Victoria 3173	+61 3 8796 8888
BRAZIL	Amphenol DO BRAZIL	Rua Diogo Moreira, 132, 20 andar, rooms 2001-2-3	+55 11 3815 1003
ISRAEL	Amphenol BAR-TEC	3 Hagavish Street, K fir-Barkan Bldg. East Industrial Zone - Kfar-Sava, 44102	+972 9 764 4100
MEXICO	Amphenol OPTIMIZE	Carretera Internacional Km 6.5, Col. Parque Industrial, Nogales, Sonora, C.P. 84094	+52 631 311 160
NEW ZEALAND	Amphenol PHITEK	Level 4, 2 Kingdon Street, Newmarket, Auckland 1023	+64 9 524 2984
RUSSIA	Amphenol RUSSIA	Yaroslavskaja Street 8 - 129164 Moscow	+7 495 937 6341
TURKEY	Amphenol TURKEY	Sun Plaza 15 Kat: 15 Maslak Hah. Bilim Sok. No.5 - Sisli/Istanbul, 34398	+90 212 367 92 19

All dimensions are given for information only and are in mm [inch], except as otherwise specified

Amphenol SOCAPEX



Amphenol Socapex

948, promenade de l'Arve BP29
74311 Thyez Cedex - France
Phone: +33 (0)4 50 89 28 00
contact@amphenol-socapex.fr
www.amphenol-socapex.com



For Technical Support

+33 (0)4 50 89 28 49
technicalsupport@amphenol-socapex.fr
www.amphenol-socapex.com/technical_support



To buy our products

+33 (0)4 50 90 28 00
contact@amphenol-socapex.fr
www.amphenol-socapex.com/amphenol/sales
Request a quote online at www.amphenol-socapex.com/quotation_request



Documentation

www.amphenol-socapex.com/documentation
To order a paper version of our catalogs, send an e-mail to communication@amphenol-socapex.fr



www.amphenol-socapex.com

Follow Amphenol Socapex on social media :



This catalog uses paper from managed forests, PEFC & FSC labels, and is printed by a printer certified "Imprim'Vert®"

We reserve the right to modify our products in any way we deem necessary.
Any duplication is prohibited, unless approved in writing.

Designed by Amphenol Socapex
September 2018 - DOC-000089-ANG