

Contents

English
Français
Deutsch
Italiano
Español
Português
Nederlands
Norsk
Dansk
Svenska
Suomi
Русский
Polski
Magyar
Čeština
Slovenčina

Slovenski
Hrvatski
Română
Български
Eesti
Latviski
Lietuviškai
Ελληνικά
Türkçe
日本語
한국어
繁體中文
简体中文
Bahasa Indonesia
ไทย

ASPIRE ONE *Series*

Quick Guide

Aspire One Series Notebook PC

Model number: _____

Serial number: _____

Date of purchase: _____

Place of purchase: _____

Federal Communications Commission

Declaration of Conformity

This device complies with Part 15 of the FCC Rules. Operation is subject to the following two conditions: (1) this device may not cause harmful interference, and (2) this device must accept any interference received, including interference that may cause undesired operation.

The following local Manufacturer / Importer is responsible for this declaration:

Product name:	Notebook PC
Brand:	Acer
Model number:	MS2296
Machine type:	AO 753 series
Name of Responsible Party:	Acer America Corporation
Address of responsible party:	333 West San Carlos St., San Jose CA 95110, U. S. A.
Contact person:	Acer Representative
Phone No.:	1-254-298-4000
Fax No.:	1-254-298-4147
April 30, 2010	

CE Declaration of Conformity

We,

Acer Incorporated

8F, 88, Sec. 1, Hsin Tai Wu Rd., Hsichih, Taipei Hsien 221, Taiwan

Contact Person: Mr. Easy Lai, e-mail:easy_lai@acer.com.tw



And,

Acer Europe SA

Via Cantonale, Centro Galleria 2 6928 Manno Switzerland

Hereby declare that:

Product: Notebook Computer

Trade Name: Acer

Model Number: MS2296

Machine Type: AO753 series

Is compliant with the essential requirements and other relevant provisions of the following EC directives, and that all the necessary steps have been taken and are in force to assure that production units of the same product will continue comply with the requirements.

EMC Directive 2004/108/EC as attested by conformity with the following harmonized standards:

- EN55022, AS/NZS CISPR22, Class B
- EN55024
- EN61000-3-2 Class D
- EN61000-3-3

Low Voltage Directive 2006/95/EC as attested by conformity with the following harmonized standard:

- EN60950-1

Council Decision 98/482/EC (CTR21):

(Applicable to product with pan- European single terminal connection to the Public Switched Telephone Network (PSTN).)

RoHS Directive 2002/95/EC on the Restriction of the Use of certain Hazardous Substances in Electrical and Electronic Equipment

- The maximum concentration values of the restricted substances by weight in homogenous material are:

Lead	0.1%	Polybrominated Biphenyls (PBB's)	0.1%
Mercury	0.1%	Polybrominated Diphenyl Ethers (PBDE's)	0.1%
Hexavalent Chromium	0.1%	Cadmium	0.01%

Directive 2009/125/EC with regard to establishing a framework for the setting of ecodesign requirements for energy-related product.

R&TTE Directive 1999/5/EC as attested by conformity with the following harmonized standard:

- Article 3.1(a) Health and Safety
 - EN60950-1
 - EN62311
- Article 3.1(b) EMC
 - EN301 489-1
 - EN301 489-3 (Applicable to non-bluetooth wireless keyboard mouse set).
 - EN301 489-7
 - EN301 489-17
 - EN301 489-24
- Article 3.2 Spectrum Usages
 - EN300 440-2 (Applicable to non-bluetooth wireless keyboard mouse set).
 - EN300 328
 - EN301 511
 - EN301 893 (Applicable to 5GHz high performance RLAN).
 - EN301 908-1
 - EN301 908-2

Year to begin affixing CE marking 2010.

Easy Lai

Easy Lai /Manager
Regulation Center, Acer Inc.

April 30, 2010

Date

Just for starters

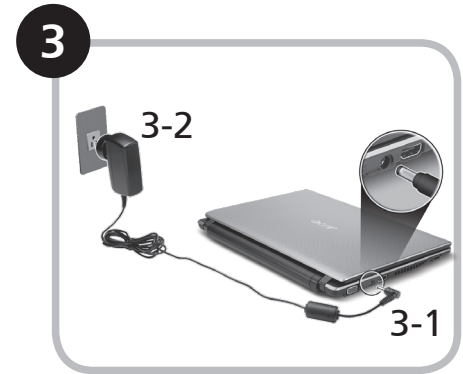
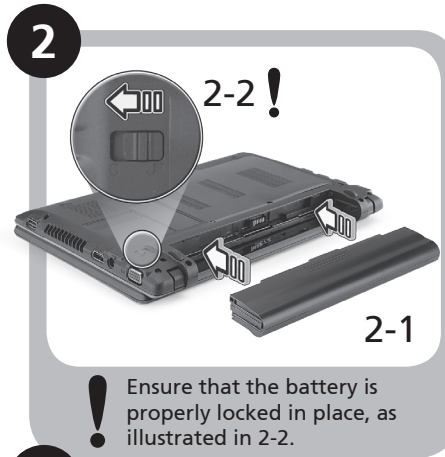
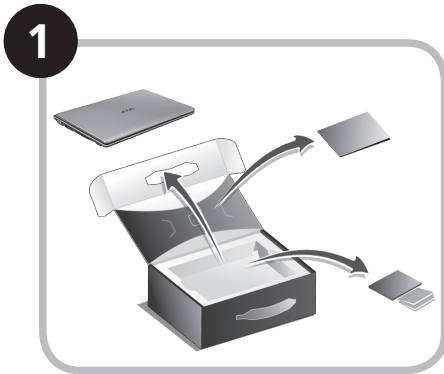

Illustrations are for reference only. Actual product specifications may vary.

First things first

We would like to thank you for making an Acer notebook your choice for meeting your mobile computing needs.

Your guides

To help you use your Acer notebook, we have designed a set of guides*:

First off, the Quick Guide helps you get started with setting up your computer.

For more on how your computer can help you to be more productive, please refer to the AcerSystem User Guide. This guide contains detailed information on such subjects as system utilities, data recovery, expansion options and troubleshooting. In addition it contains warranty information and the general regulations and safety notices for your notebook. It is available in Portable Document Format (PDF) and comes preloaded on your notebook.



Note: Viewing the file requires Adobe Reader. If Adobe Reader is not installed on your computer, clicking on AcerSystem User Guide will run the Adobe Reader setup program first. Follow the instructions on the screen to complete the installation. For instructions on how to use Adobe Reader, access the Help and Support menu.



*** IMPORTANT NOTICE:** Please note that the guides mentioned herein, whether in printed or electronic form, are for your reference only and except as provided in the specific warranty information contained in the AcerSystem User Guide nothing contained in these guides shall constitute a representation or warranty by Acer with regard to the product you purchased. Acer expressly disclaims any liability for errors contained in the guides.

Network configuration

This guide will help you configure your LAN and wireless network settings to enable you to connect to the Internet.

Setting up LAN connection

Simply plug in the LAN cable to the Ethernet (RJ-45) port. Please refer to **"Right view"** on page 6 for the location of the Ethernet port.

Setting up a wireless connection

1. Press <Fn> + <F3> to access the communication manager. Here you can turn on the Wi-Fi connection by clicking on the red button next to Wi-Fi.

Note: 3G and Bluetooth are also accessible through the communication manager. Communication devices vary by model.

2. Click the  icon on your system tray and choose the wireless access point you want to connect to.



Inserting a 3G SIM card (only for certain models)

Remove the battery and carefully insert a 3G SIM card into the 3G SIM card slot. Please refer to **"Rear & base views"** on page 6 for the location of the 3G SIM card slot.

Your Aspire One tour

After setting up your computer as illustrated in the Just for starters section, let us show you around your new Acer notebook.

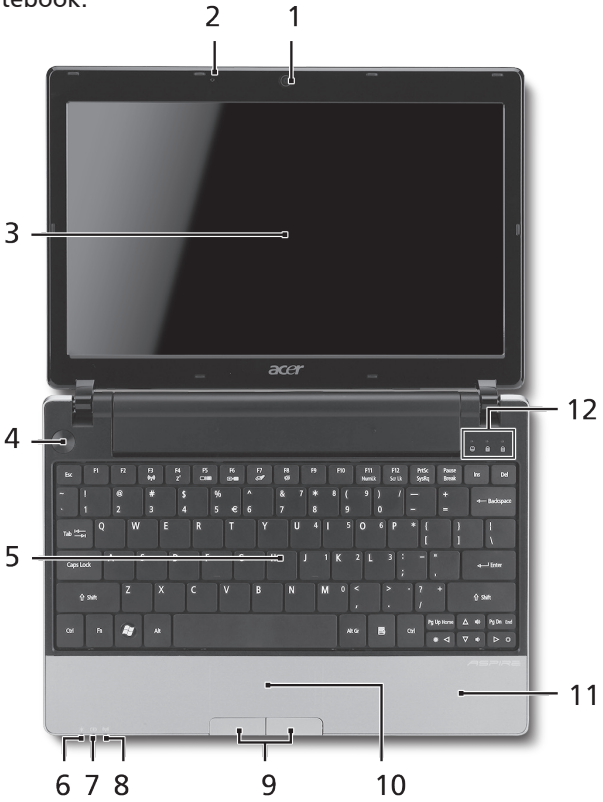

Top view



#	Icon	Item	Description									
1		Acer Crystal Eye webcam	Web camera for video communication (configuration may vary by model).									
2		Microphone	Internal microphone for sound recording.									
3		Display screen	Also called Liquid-Crystal Display (LCD), displays computer output (configuration may vary by model).									
4		Power button	Turns the computer on and off.									
5		Keyboard	For entering data into your computer.									
6		Power indicator ¹	Indicates the computer's power status.									
7		Battery indicator ¹	Indicates the computer's battery status. 1. Charging: The light shows amber when the battery is charging. 2. Fully charged: The light shows blue when in AC mode.									
8		Communication indicator ¹	Indicates the status of 3G/Wireless LAN communication. <table border="1" data-bbox="1069 644 1508 728"> <tr> <td>Blue light on</td> <td>Orange light on</td> <td>Not lit</td> </tr> <tr> <td>3G on / WiFi on</td> <td>3G off / WiFi on</td> <td>3G off / WiFi off</td> </tr> <tr> <td>3G on / WiFi off</td> <td></td> <td></td> </tr> </table>	Blue light on	Orange light on	Not lit	3G on / WiFi on	3G off / WiFi on	3G off / WiFi off	3G on / WiFi off		
Blue light on	Orange light on	Not lit										
3G on / WiFi on	3G off / WiFi on	3G off / WiFi off										
3G on / WiFi off												
9		Click buttons (left and right)	The left and right buttons function like the left and right mouse buttons.									
10		Touchpad	Touch-sensitive pointing device which functions like a computer mouse.									
11		Palmrest	Comfortable support area for your hands when you use the computer.									
12		HDD indicator	Indicates when the hard disk drive is active.									
		Num Lock	Lights up when Num Lock is activated.									
		Caps Lock	Lights up when Caps Lock is activated.									

1. The front panel indicators are visible even when the computer cover is closed.

Closed front view

#	Icon	Item	Description
1		Status indicators	Light-Emitting Diodes (LED) that light up to show the status of the computer's functions and components.

Left view

2		External display (VGA) port	Connects to a display device (e.g., external monitor, LCD projector).
3		DC-in jack	Connects to an AC adapter.
4	HDMI	HDMI port	Supports high definition digital video connections.
5		Ventilation slots	Enable the computer to stay cool, even after prolonged use.
6		USB 2.0 port	Connects to USB 2.0 devices (e.g., USB mouse, USB camera).

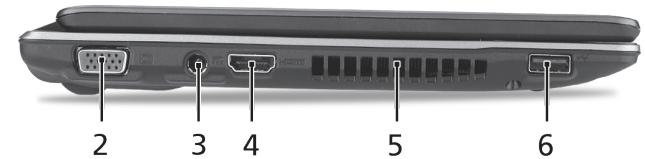

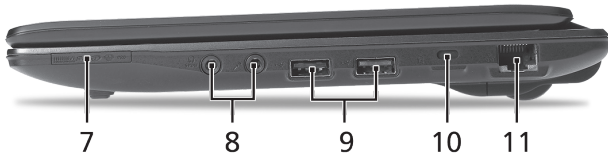

Right view

#	Icon	Item	Description
7		Multi-in-1 card reader	Accepts Secure Digital (SD), MultiMediaCard (MMC), Memory Stick (MS), Memory Stick PRO (MS PRO), xD-Picture Card (xD). Note: Push to remove/install the card. Only one card can operate at any given time.
8		Microphone-in jack	Accepts inputs from external microphones.
		Headphone/speaker/line-out jack with S/PDIF support	Connects to audio line-out devices (e.g., speakers, headphones).
9		USB 2.0 port	Connects to USB 2.0 devices (e.g., USB mouse).
10		Kensington lock slot	Connects to a Kensington-compatible computer security lock.
11		Ethernet (RJ-45) port	Connects to an Ethernet 10/100/1000-based network.

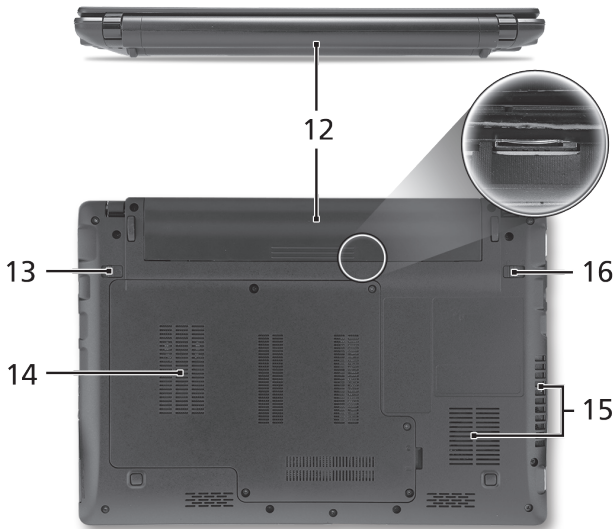

Rear & base views

12		Battery bay	Houses the computer's battery pack.
13		Battery release latch	Releases the battery for removal.
14		Hard disk bay	Houses the computer's hard disk (secured with screws).
		Memory compartment	Houses the computer's main memory.
15		Ventilation slots and cooling fan	Enable the computer to stay cool, even after prolonged use. Note: Do not cover or obstruct the opening of the fan.
16		Battery lock	Locks the battery in position.

Environment

Temperature:

Operating: 5 °C to 35 °C

Non-operating: -20 °C to 65 °C

Humidity (non-condensing):

Operating: 20% to 80%

Non-operating: 20% to 80%

Gamme **ASPIRE** ONE

Guide rapide

Ordinateur notebook de la gamme *Aspire One*

Modèle : _____

No. de série : _____

Date d'achat : _____

Lieu d'achat : _____

Federal Communications Commission

Declaration of Conformity

This device complies with Part 15 of the FCC Rules. Operation is subject to the following two conditions: (1) this device may not cause harmful interference, and (2) this device must accept any interference received, including interference that may cause undesired operation.

The following local Manufacturer / Importer is responsible for this declaration:

Product name:	Notebook PC
Brand:	Acer
Model number:	MS2296
Machine type:	<i>AO 753 series</i>
Name of Responsible Party:	Acer America Corporation
Address of responsible party:	333 West San Carlos St., San Jose CA 95110, U. S. A.
Contact person:	Acer Representative
Phone No.:	1-254-298-4000
Fax No.:	1-254-298-4147
April 30, 2010	

CE Declaration of Conformity

We,

Acer Incorporated

8F, 88, Sec. 1, Hsin Tai Wu Rd., Hsichih, Taipei Hsien 221, Taiwan

Contact Person: Mr. Easy Lai, e-mail:easy_lai@acer.com.tw

And,

Acer Europe SA

Via Cantonale, Centro Galleria 2 6928 Manno Switzerland

Hereby declare that:

Product: Notebook Computer

Trade Name: Acer

Model Number: MS2296

Machine Type: AO753 series

Is compliant with the essential requirements and other relevant provisions of the following EC directives, and that all the necessary steps have been taken and are in force to assure that production units of the same product will continue comply with the requirements.

EMC Directive 2004/108/EC as attested by conformity with the following harmonized standards:

- EN55022, AS/NZS CISPR22, Class B
- EN55024
- EN61000-3-2 Class D
- EN61000-3-3

Low Voltage Directive 2006/95/EC as attested by conformity with the following harmonized standard:

- EN60950-1

Council Decision 98/482/EC (CTR21):

(Applicable to product with pan- European single terminal connection to the Public Switched Telephone Network (PSTN).)

RoHS Directive 2002/95/EC on the Restriction of the Use of certain Hazardous Substances in Electrical and Electronic Equipment



- The maximum concentration values of the restricted substances by weight in homogenous material are:

Lead	0.1%	Polybrominated Biphenyls (PBB's)	0.1%
Mercury	0.1%	Polybrominated Diphenyl Ethers (PBDE's)	0.1%
Hexavalent Chromium	0.1%	Cadmium	0.01%

Directive 2009/125/EC with regard to establishing a framework for the setting of ecodesign requirements for energy-related product.

R&TTE Directive 1999/5/EC as attested by conformity with the following harmonized standard:

- Article 3.1(a) Health and Safety
 - EN60950-1
 - EN62311
- Article 3.1(b) EMC
 - EN301 489-1
 - EN301 489-3 (Applicable to non-bluetooth wireless keyboard mouse set).
 - EN301 489-7
 - EN301 489-17
 - EN301 489-24
- Article 3.2 Spectrum Usages
 - EN300 440-2 (Applicable to non-bluetooth wireless keyboard mouse set).
 - EN300 328
 - EN301 511
 - EN301 893 (Applicable to 5GHz high performance RLAN).
 - EN301 908-1
 - EN301 908-2

Year to begin affixing CE marking 2010.

Easy Lai

Easy Lai /Manager
Regulation Center, Acer Inc.

Apr. 30, 2010

Date

Pour partir du bon pied

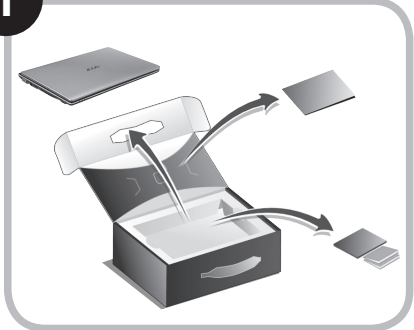
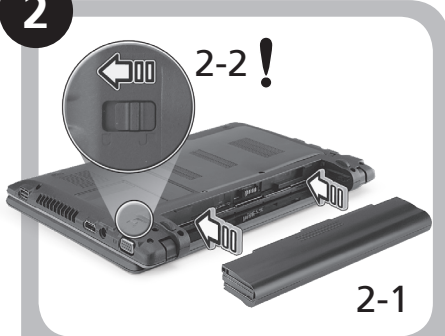

- 
- 

2-2 !

2-1

! Assurez que la batterie est correctement verrouillée en place, comme illustré à 2-2.
- 

3-2

3-1
- 
- 

Esc
- 



Les illustrations sont mises uniquement à titre de référence. Les caractéristiques réelles des produits peuvent changer.

Pour commencer

Nous désirons vous remercier d'avoir fait d'un notebook Acer votre choix pour répondre à vos besoins informatiques mobiles.

Vos guides

Pour vous aider à utiliser votre notebook Acer, nous avons conçu plusieurs guides* :

Tout d'abord, le Guide rapide vous aide à configurer votre ordinateur.

Pour plus d'information sur l'aide que peut vous apporter votre ordinateur pour être plus productif, veuillez vous reporter au Guide utilisateur AcerSystem. Ce guide contient des informations détaillées sur des sujets tels que les utilitaires systèmes, la récupération des données, les options d'extension et le dépannage. De plus, il contient des informations de garantie et les réglementations générales et les avis de sécurité pour votre notebook. Il est disponible au format PDF (Portable Document Format) et est préchargé sur votre notebook.



Remarque : L'affichage du fichier nécessite Adobe Reader. Si Adobe Reader n'est pas installé dans votre ordinateur, le clic sur Guide utilisateur AcerSystem va exécuter le programme d'installation d'Adobe Reader. Suivez les instructions à l'écran pour terminer l'installation. Pour des instructions sur l'utilisation de Adobe Reader, accédez au menu Aide et Support.



*** AVIS IMPORTANT : Veuillez noter que les guides mentionnés ici, que ce soit imprimés ou au format électronique, sont pour votre référence seulement et à l'exception de ce qui est indiqué dans les informations spécifiques à la garantie contenue dans AcerSystem User Guide, rien de ce qui est contenu dans ces guides ne constitue une déclaration ou garantie par Acer en ce qui concerne le produit que vous avez acheté. Acer rejette expressément toute responsabilité pour les erreurs contenues dans les guides.**

Configuration réseau

Ce guide vous aide à configurer les paramètres de votre réseau local et de votre réseau sans fil pour pouvoir vous connecter à Internet.

Configurer la connexion réseau

Branchez simplement le câble réseau dans le port Ethernet RJ-45. Veuillez vous reporter « **Vue droite** » à la page 6 pour l'emplacement du port Ethernet.

Configurer une connexion sans fil

1. Appuyez <Fn> + <F3> pour accéder au gestionnaire de communication. Ici vous pouvez activer la connexion Wi-Fi en cliquant sur le bouton rouge à côté de Wi-Fi.

Remarque : 3G et Bluetooth sont également accessibles via le gestionnaire de communication. Les périphériques de communication varient en fonction du modèle.

2. Cliquez sur l'icône  sur votre barre des tâches et choisissez le point d'accès sans fil auquel vous souhaitez vous connecter.



Insérer une carte SIM 3G (seulement pour certains modèles)

Retirez la batterie et insérez avec soin une carte SIM 3G dans le connecteur de carte SIM 3G. Veuillez consulter « **Vue arrière & Vue de la base** » à la page 6 pour l'emplacement du connecteur de carte SIM 3G.

Visite guidée de votre *Aspire One* Vue supérieure

Après avoir configuré votre ordinateur comme illustré la section Pour partir du bon pied, nous allons vous faire explorer votre nouveau notebook Acer.

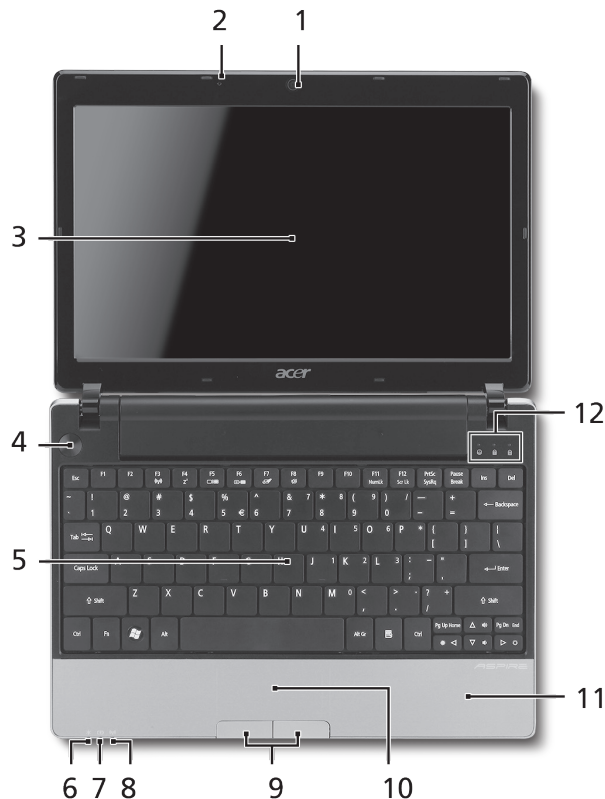

#	Icône	Élément	Description						
1		Webcam Acer Crystal Eye	Webcam pour communication vidéo (la configuration peut varier en fonction des modèles).						
2		Microphone	Microphone interne pour l'enregistrement sonore.						
3		Écran d'affichage	Également appelé écran LCD (Liquid Crystal Display), affiche les données de l'ordinateur (la configuration peut varier en fonction des modèles).						
4		Bouton Marche/ Arrêt	Met l'ordinateur sous tension et hors tension.						
5		Clavier	Pour l'entrée des informations dans votre ordinateur.						
6		Indicateur d'alimentation ¹	Indique l'état d'alimentation de l'ordinateur.						
7		Indicateur de batterie ¹	Indique l'état de la pile de l'ordinateur. 1. Charge : La lumière est orange lorsque la pile se recharge. 2. Pleine charge : La diode est bleue en mode secteur.						
8		Indicateur de communication ¹	Indique l'état de la communication réseau sans fil/3G. <table border="1" style="width: 100%; text-align: center;"> <tr> <td>Lumière bleue allumée</td> <td>Lumière orange allumée</td> <td>Pas allumé</td> </tr> <tr> <td>3G activé/ WiFi activé</td> <td>3G désactivé/ WiFi activé</td> <td>3G désactivé/ WiFi désactivé</td> </tr> </table>	Lumière bleue allumée	Lumière orange allumée	Pas allumé	3G activé/ WiFi activé	3G désactivé/ WiFi activé	3G désactivé/ WiFi désactivé
Lumière bleue allumée	Lumière orange allumée	Pas allumé							
3G activé/ WiFi activé	3G désactivé/ WiFi activé	3G désactivé/ WiFi désactivé							
9		Boutons (gauche et droit)	Le bouton gauche et le bouton droit fonctionnent comme le bouton gauche et le bouton droit d'une souris.						
10		Touchpad	Périphérique de pointage sensible au touché qui fonctionne comme une souris.						
11		Repose mains	Zone de support confortable pour vos mains lorsque vous utilisez l'ordinateur.						
12		Indicateur du disque dur	Indique l'activité du disque dur.						
		Verr Num	Est allumé lorsque Verr Num est activée.						
		Verr Maj	Est allumé lorsque Verr Maj est activée.						



1. Les indicateurs du panneau avant sont visibles même lorsque l'écran LCD est fermé.

Vue frontale fermée

#	Icône	Élément	Description
1		Indicateurs d'état	Diodes électroluminescentes (DEL) qui s'allume pour indiquer l'état des fonctions et composants de l'ordinateur.



Vue gauche

2		Port d'affichage (VGA) externe	Se connecte à un périphérique d'affichage (p.ex. un moniteur externe, un projecteur LCD).
3		Prise d'alimentation	Se connecte à l'adaptateur secteur.
4	HDMI	Port HDMI	Prend en charge les connexions vidéo numériques à haute définition.
5		Fentes de ventilation	Permettent à l'ordinateur de rester froid, même après une longue utilisation.
6		Port USB 2.0	Se connecte à des périphériques USB 2.0 (p.ex. une souris USB, une caméra USB).

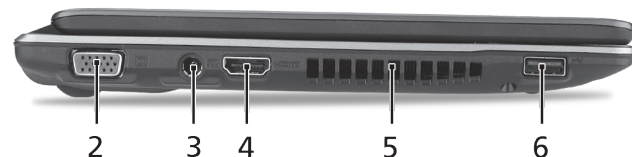

Vue droite

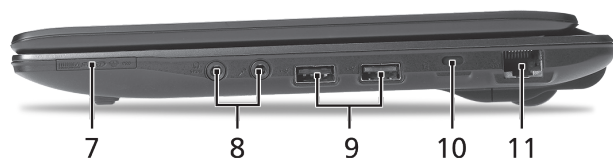

#	Icône	Élément	Description
7		Lecteur de cartes multiples en un	Accepte une carte mémoire Secure Digital (SD), MultiMediaCard (MMC), Memory Stick (MS), Memory Stick Pro (MS PRO), et xD-Picture (xD). Remarque : Poussez pour retirer/installer la carte. Seule une carte peut fonctionner à un moment donné.
8		Prise d'entrée microphone	Accepte les entrées de microphones externes.
		Prise de sortie audio/haut-parleur/casque avec prise en charge de S/PDIF	Se connecte à des périphériques audio en sortie (p.ex. haut-parleurs ou un casque stéréo).
9		Port USB 2.0	Se connecte à des périphériques USB 2.0 (p.ex. une souris USB).
10		Fente pour cadenas Kensington	Se connecte à un cadenas de sécurité pour ordinateur Kensington.
11		Port Ethernet RJ-45	Se connecte à un réseau Ethernet 10/100/1000 Base.

Vue arrière & Vue de la base

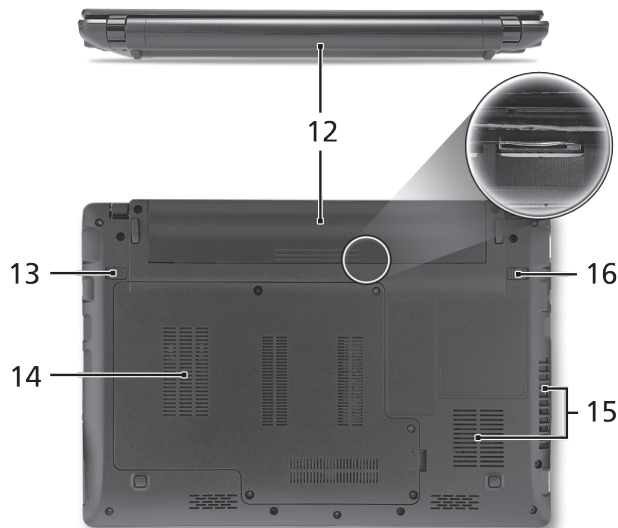

12		Baie de la batterie	Contient la batterie de l'ordinateur.
13		Loquet de libération de la batterie	Libère la batterie pour le retrait.
14		Baie du disque dur	Contient le disque dur de l'ordinateur (fixé avec des vis).
		Compartiment mémoire	Contient la mémoire principale de l'ordinateur.
15		Fentes de ventilation et ventilateur de refroidissement	Permettent à l'ordinateur de rester froid, même après une longue utilisation. Remarque : Ne couvrez pas et ne bloquez pas l'ouverture du ventilateur.
16		Verrou de la batterie	Verrouille la batterie en position.

Environnement

Température :

En marche : 5°C à 35°C

À l'arrêt : -20°C à 65°C

Humidité (sans condensation) :

En marche : 20% à 80%

À l'arrêt : 20% à 80%

ASPIRE ONE *Serie*

Kurzanleitung

Notebook-PC der *Aspire One* Serie

Modellnummer: _____

Seriennummer: _____

Kaufdatum: _____

Kaufort: _____

Federal Communications Commission

Declaration of Conformity

This device complies with Part 15 of the FCC Rules. Operation is subject to the following two conditions: (1) this device may not cause harmful interference, and (2) this device must accept any interference received, including interference that may cause undesired operation.

The following local Manufacturer / Importer is responsible for this declaration:

Product name:	Notebook PC
Brand:	Acer
Model number:	MS2296
Machine type:	<i>AO 753 series</i>
Name of Responsible Party:	Acer America Corporation
Address of responsible party:	333 West San Carlos St., San Jose CA 95110, U. S. A.
Contact person:	Acer Representative
Phone No.:	1-254-298-4000
Fax No.:	1-254-298-4147
April 30, 2010	

CE Declaration of Conformity

We,

Acer Incorporated

8F, 88, Sec. 1, Hsin Tai Wu Rd., Hsichih, Taipei Hsien 221, Taiwan

Contact Person: Mr. Easy Lai, e-mail:easy_lai@acer.com.tw

And,

Acer Europe SA

Via Cantonale, Centro Galleria 2 6928 Manno Switzerland

Hereby declare that:

Product: Notebook Computer

Trade Name: Acer

Model Number: MS2296

Machine Type: AO753 series

Is compliant with the essential requirements and other relevant provisions of the following EC directives, and that all the necessary steps have been taken and are in force to assure that production units of the same product will continue comply with the requirements.

EMC Directive 2004/108/EC as attested by conformity with the following harmonized standards:

- EN55022, AS/NZS CISPR22, Class B
- EN55024
- EN61000-3-2 Class D
- EN61000-3-3

Low Voltage Directive 2006/95/EC as attested by conformity with the following harmonized standard:

- EN60950-1

Council Decision 98/482/EC (CTR21):

(Applicable to product with pan- European single terminal connection to the Public Switched Telephone Network (PSTN).)

RoHS Directive 2002/95/EC on the Restriction of the Use of certain Hazardous Substances in Electrical and Electronic Equipment



- The maximum concentration values of the restricted substances by weight in homogenous material are:

Lead	0.1%	Polybrominated Biphenyls (PBB's)	0.1%
Mercury	0.1%	Polybrominated Diphenyl Ethers (PBDE's)	0.1%
Hexavalent Chromium	0.1%	Cadmium	0.01%

Directive 2009/125/EC with regard to establishing a framework for the setting of ecodesign requirements for energy-related product.

R&TTE Directive 1999/5/EC as attested by conformity with the following harmonized standard:

- Article 3.1(a) Health and Safety
 - EN60950-1
 - EN62311
- Article 3.1(b) EMC
 - EN301 489-1
 - EN301 489-3 (Applicable to non-bluetooth wireless keyboard mouse set).
 - EN301 489-7
 - EN301 489-17
 - EN301 489-24
- Article 3.2 Spectrum Usages
 - EN300 440-2 (Applicable to non-bluetooth wireless keyboard mouse set).
 - EN300 328
 - EN301 511
 - EN301 893 (Applicable to 5GHz high performance RLAN).
 - EN301 908-1
 - EN301 908-2

Year to begin affixing CE marking 2010.

Easy Lai

Easy Lai /Manager
Regulation Center, Acer Inc.

Apr. 30, 2010

Date

Für den Anfang

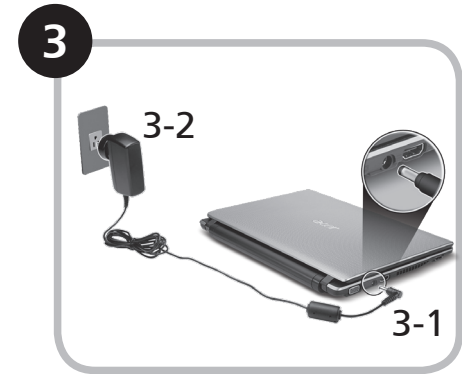
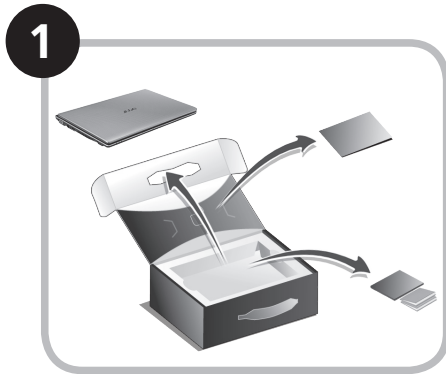

 Abbildung nur Referenz und kann zum Produkt variieren. Das tatsächliche Produkt kann sich von den Abbildungen unterscheiden.

Das Wichtigste zuerst

Wir möchten uns bei Ihnen dafür bedanken, dass Sie sich in Bezug auf mobilen Computerbedarf für ein Acer-Notebook entschieden haben.

Hilfen

Als Hilfe für Sie bei der Verwendung des Acer-Notebooks haben wir einen Satz von Richtlinien aufgestellt*:

Zuallererst hilft Ihnen die Kurzanleitung dabei, Ihren Computer das erste Mal in Betrieb zu nehmen.

Für weitere Informationen dazu, wie Ihnen Ihr Computer helfen kann, noch produktiver zu arbeiten, lesen Sie bitte die AcerSystem Benutzeranleitung. Dieses Benutzerhandbuch enthält detaillierte Informationen zu Themen wie z. B. Systemprogramme, Datenwiederherstellung, Erweiterungsoptionen und Problembehebung. Darüber hinaus enthält es Informationen zur Garantie und allgemeine Bestimmungen und Sicherheitshinweise zu Ihrem Notebook. Das Benutzerhandbuch steht in PDF (Portable Document Format) zur Verfügung und ist bereits in Ihrem Notebook installiert.



Hinweis: Zum Betrachten der Datei muß Adobe Reader installiert sein. Wenn Adobe Reader nicht auf Ihrem Computer installiert ist, wird durch Klicken auf AcerSystem Benutzerhandbuch zuerst das Setup-Programm von Adobe Reader ausgeführt. Folgen Sie zur Durchführung der Installation den Anweisungen auf dem Bildschirm. Hinweise über die Verwendung von Adobe Reader finden Sie im Menü Hilfe und Support.



*** WICHTIGER HINWEIS:** Denken Sie daran, dass die beschriebenen Anleitungen, ob in ausgedruckter oder elektronischer Form, nur zur Erläuterung dienen. Mit Ausnahme der Informationen zur Garantie, die in der AcerSystem Benutzeranleitung enthalten ist, gibt Acer mit diesen Anleitungen keine Versprechungen oder Garantien hinsichtlich des von Ihnen gekauften Produktes. Acer übernimmt ausdrücklich keine Haftung für Fehler, die in diesen Anleitungen enthalten sein können.

Netzkonfiguration

Diese Anleitung hilft Ihnen bei der Konfiguration Ihrer LAN- und Drahtlos-Netzeinstellungen, damit Sie eine Verbindung mit dem Internet herstellen können.

Herstellung einer LAN-Verbindung

Schließen Sie einfach das LAN-Kabel an den Ethernet (RJ-45)-Anschluss an. Siehe „Rechte Seite“ auf Seite 6, um den Ort der Ethernet-Schnittstelle zu erfahren.

Einrichten einer Drahtlosverbindung

1. Drücken Sie auf <Fn> + <F3>, um auf den Kommunikationsmanager zuzugreifen. Dort können Sie anschließend die WLAN-Verbindung durch Klicken auf die rote Schaltfläche neben WLAN aktivieren.

Hinweis: Über den Kommunikationsmanager gelangen Sie auch nach 3G und Bluetooth. Kommunikationsgeräte können sich je nach Modell unterscheiden.

2. Klicken Sie auf das Symbol  auf der Systemleiste und wählen Sie den Drahtlos-Zugriffspunkt aus, zu dem Sie eine Verbindung herstellen möchten.



Einsetzen einer 3G-SIM-Karte (Nur für bestimmte Modelle)

Entfernen Sie den Akku und setzen Sie eine 3G-SIM-Karte vorsichtig in den 3G-SIM-Karteneinschub hinein. Unter „Rückseite & Unterseite“ auf Seite 6 erfahren Sie den Ort des 3G SIM-Karteneinschubs.

Eine Tour durch das *Aspire One* Ansicht von oben

Nachdem Sie Ihren Computer wie im Abschnitt Für den Anfang gezeigt aufgestellt haben, lassen Sie uns nun Ihr neues Acer-Notebook vorstellen.

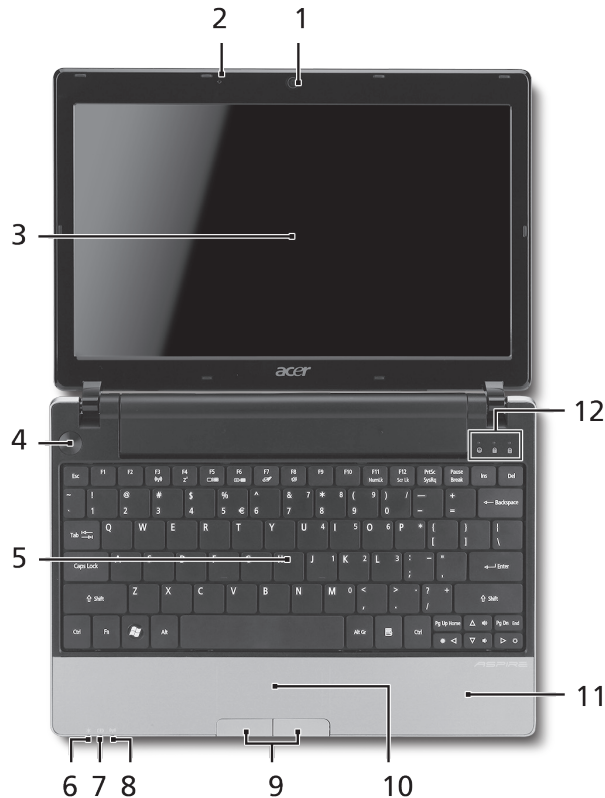

#	Symbol	Element	Beschreibung						
1		Acer Crystal Eye Webcam	Web-Kamera für Videokommunikation (konfiguration kann sich von Modell zu Modell unterscheiden).						
2		Mikrofon	Internes Mikrofon für die Tonaufnahme.						
3		Anzeigebildschirm	Wird auch als LCD (Liquid-Crystal-Display) bezeichnet. Zeigt die Ausgabe des Computers an (konfiguration kann sich von Modell zu Modell unterscheiden).						
4		Ein/Aus-Taste	Schaltet den Computer ein und aus.						
5		Tastatur	Dient der Eingabe von Daten in den Computer.						
6		Stromanzeige ¹	Zeigt den Ein/Aus-Status des Computers an.						
7		Akkuanzeige ¹	Zeigt den Akkustatus des Computers an. 1. Aufladung: Die Leuchte erscheint gelb, wenn der Akku aufgeladen wird. 2. Voll aufgeladen: Die Leuchte erscheint blau, wenn Netzstrom verwendet wird.						
8		Anzeige für Kommunikation ¹	Leuchtet auf, um den Status der WLAN-Kommunikation anzuzeigen. <table border="1" data-bbox="1082 621 1551 716"> <thead> <tr> <th>Blaue Leuchte ein</th> <th>Orangefarbene Leuchte ein</th> <th>Leuchtet nicht</th> </tr> </thead> <tbody> <tr> <td>3G ein/WiFi ein 3G ein/WiFi aus</td> <td>3G aus/WiFi ein</td> <td>3G aus/WiFi aus</td> </tr> </tbody> </table>	Blaue Leuchte ein	Orangefarbene Leuchte ein	Leuchtet nicht	3G ein/WiFi ein 3G ein/WiFi aus	3G aus/WiFi ein	3G aus/WiFi aus
Blaue Leuchte ein	Orangefarbene Leuchte ein	Leuchtet nicht							
3G ein/WiFi ein 3G ein/WiFi aus	3G aus/WiFi ein	3G aus/WiFi aus							
9		Anklicktasten (links und rechts)	Die linken und rechten Tasten funktionieren wie die linken und rechten Tasten einer Maus.						
10		Touchpad	Berührungssensibles Zeigegerät, das die gleichen Funktionen besitzt wie eine Computer-Maus.						
11		Handablage	Bequemer Ablagebereich für Ihre Hände während der Bedienung des Computers.						
12		HDD-Anzeige	Leuchtet auf, wenn die Festplatte aktiv ist.						
		Num Lock	Leuchtet auf, wenn die Num Lock-Funktion aktiviert ist.						
		Caps Lock	Leuchtet auf, wenn die Caps Lock-Funktion aktiviert ist.						



1. Die Statusanzeigen auf der Vorderseite sind selbst dann zu sehen, wenn die Computerklappe geschlossen ist.

Geschlossene Vorderseite

#	Symbol	Element	Beschreibung
1		Statusanzeigen	Diese LEDs (Light-Emitting Diodes) leuchten auf, um Ihnen den Status der Funktionen und Komponenten des Computers anzuzeigen.



Linke Seite

2		Anschluss für externe Anzeige (VGA)	Dient dem Anschluss eines Anzeigegerätes (z. B. einem externen Monitor oder LCD-Projektor).
3		DC-Eingangsbuchse	Hier schließen Sie das Netzteil an.
4	HDMI	HDMI-Anschluss	Unterstützt digitale High-Definition-Video-Verbindungen.
5		Belüftungsschlitze	Schützt den Computer vor Überhitzung, selbst bei längerem Einsatz.
6		USB 2.0-Anschluss	Hier schließen Sie USB 2.0-Geräte (z. B. USB-Maus oder USB-Kamera) an.

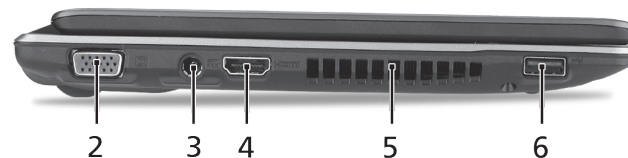

Rechte Seite

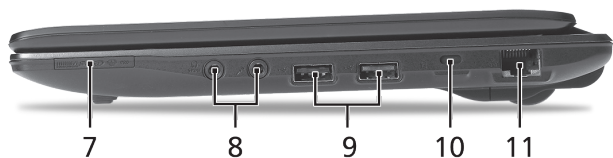

#	Symbol	Element	Beschreibung
7		Mehrere-in-1-Kartenleser	Eignet sich für Secure Digital (SD), MultiMediaCard (MMC), Memory Stick (MS), Memory Stick PRO (MS PRO) und xD-Picture Card (xD). Hinweis: Drücken Sie hier, um die Karte zu entfernen/einzusetzen. Es kann nicht mehr als eine Karte gleichzeitig verwendet werden.
8		Mikrofon-Eingangs-Buchse	Eignet sich für Eingaben aus externen Mikrofonen.
		Buchse für Kopfhörer/Lautsprecher/Ausgang mit S/PDIF-Unterstützung	Zum Anschluss von Audioausgabe-Geräten (z.B. Lautsprechern, Kopfhörern).
9		USB 2.0-Anschluss	Hier schließen Sie USB 2.0-Geräte (z. B. USB-Maus) an.
10		Steckplatz für Kensington-Schloss	Hier können Sie ein Kensington-kompatibles Sicherheitsschloss für den Computer anbringen.
11		Ethernet (RJ-45)-Anschluss	Zum Anschluss eines Ethernet 10/100/1000-basierten Netzwerks.

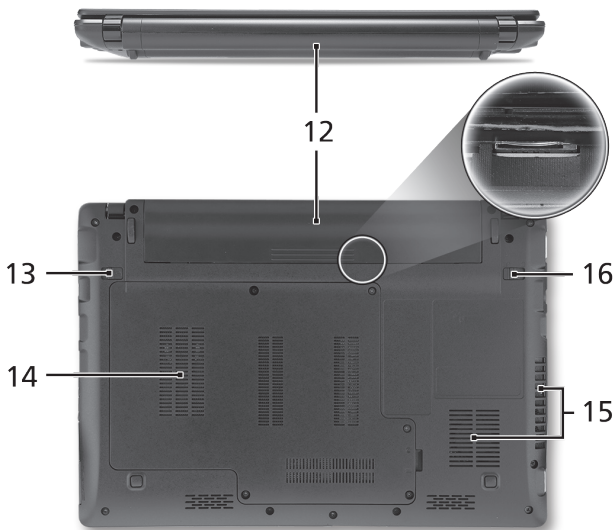

Rückseite & Unterseite

12		Akkufach	Enthält den Akku des Computers.
13		Verriegelung des Akkus	Entsperrt den Akku für die Herausnahme.
14		Festplattenfach	Enthält die Computer-Festplatte (durch Schrauben gesichert).
		Speicherfach	Enthält den Hauptspeicher des Computers.
15		Belüftungsschlitze und Ventilator	Schützt den Computer vor Überhitzung, selbst bei längerem Einsatz. Hinweis: Verdecken oder schließen Sie nicht die Öffnungen des Ventilators.
16		Akkuverschluss	Sichert den Akku an seiner Position.

Umgebung

Temperatur:

Betrieb: 5°C bis 35°C

Nichtbetrieb: -20°C bis 65°C

Luftfeuchtigkeit (nicht kondensierend):

Betrieb: 20% bis 80%

Nichtbetrieb: 20% bis 80%

Serie **ASPIRE** ONE

Guida rapida

PC Notebook Serie *Aspire One*

Numero di modello: _____

Numero di serie: _____

Data di acquisto: _____

Luogo d'acquisto: _____

Federal Communications Commission

Declaration of Conformity

This device complies with Part 15 of the FCC Rules. Operation is subject to the following two conditions: (1) this device may not cause harmful interference, and (2) this device must accept any interference received, including interference that may cause undesired operation.

The following local Manufacturer / Importer is responsible for this declaration:

Product name:	Notebook PC
Brand:	Acer
Model number:	MS2296
Machine type:	<i>AO 753 series</i>
Name of Responsible Party:	Acer America Corporation
Address of responsible party:	333 West San Carlos St., San Jose CA 95110, U. S. A.
Contact person:	Acer Representative
Phone No.:	1-254-298-4000
Fax No.:	1-254-298-4147
April 30, 2010	

CE Declaration of Conformity

We,

Acer Incorporated

8F, 88, Sec. 1, Hsin Tai Wu Rd., Hsichih, Taipei Hsien 221, Taiwan

Contact Person: Mr. Easy Lai, e-mail:easy_lai@acer.com.tw



And,

Acer Europe SA

Via Cantonale, Centro Galleria 2 6928 Manno Switzerland

Hereby declare that:

Product: Notebook Computer

Trade Name: Acer

Model Number: MS2296

Machine Type: AO753 series

Is compliant with the essential requirements and other relevant provisions of the following EC directives, and that all the necessary steps have been taken and are in force to assure that production units of the same product will continue comply with the requirements.

EMC Directive 2004/108/EC as attested by conformity with the following harmonized standards:

- EN55022, AS/NZS CISPR22, Class B
- EN55024
- EN61000-3-2 Class D
- EN61000-3-3

Low Voltage Directive 2006/95/EC as attested by conformity with the following harmonized standard:

- EN60950-1

Council Decision 98/482/EC (CTR21):

(Applicable to product with pan- European single terminal connection to the Public Switched Telephone Network (PSTN).)

RoHS Directive 2002/95/EC on the Restriction of the Use of certain Hazardous Substances in Electrical and Electronic Equipment

- The maximum concentration values of the restricted substances by weight in homogenous material are:

Lead	0.1%	Polybrominated Biphenyls (PBB's)	0.1%
Mercury	0.1%	Polybrominated Diphenyl Ethers (PBDE's)	0.1%
Hexavalent Chromium	0.1%	Cadmium	0.01%

Directive 2009/125/EC with regard to establishing a framework for the setting of ecodesign requirements for energy-related product.

R&TTE Directive 1999/5/EC as attested by conformity with the following harmonized standard:

- Article 3.1(a) Health and Safety
 - EN60950-1
 - EN62311
- Article 3.1(b) EMC
 - EN301 489-1
 - EN301 489-3 (Applicable to non-bluetooth wireless keyboard mouse set).
 - EN301 489-7
 - EN301 489-17
 - EN301 489-24
- Article 3.2 Spectrum Usages
 - EN300 440-2 (Applicable to non-bluetooth wireless keyboard mouse set).
 - EN300 328
 - EN301 511
 - EN301 893 (Applicable to 5GHz high performance RLAN).
 - EN301 908-1
 - EN301 908-2

Year to begin affixing CE marking 2010.

Easy Lai

Easy Lai /Manager
Regulation Center, Acer Inc.

Apr. 30, 2010

Date

Per i principianti

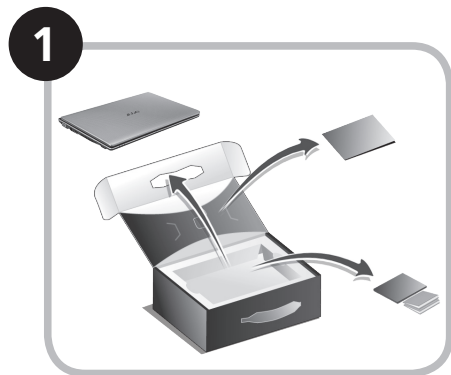

Le illustrazioni sono di solo riferimento. Le specifiche dei prodotti possono differire.

Avvertenze preliminari

Grazie per aver scelto il notebook Acer, la scelta ideale per poter lavorare in piena libertà anche in movimento.

Le guide disponibili

Sono state realizzate delle guide per assistere l'utente nell'uso del notebook Acer*:

Innanzitutto, la Guida rapida aiuta a semplificare la configurazione del computer.

Per altre nozioni su come il vostro computer può aiutarvi a diventare ancora più produttivi, consultate la AcerSystem User Guide. Questa guida contiene informazioni dettagliate su argomenti come utilità del sistema, ripristino dei dati, opzioni di espansione e ricerca guasti. Contiene inoltre informazioni sulla garanzia, le norme e gli standard di riferimento e le avvertenze per la sicurezza del vostro notebook. È disponibile nel formato PDF e viene fornita già caricata nel notebook.



Nota: Per visualizzare il file, è necessario che sul computer sia installato Adobe Reader. Se Adobe Reader non è installato sul computer, fare clic su AcerSystem User Guide per eseguire il programma di installazione di Adobe Reader. Per completare l'installazione, attenersi alle istruzioni visualizzate sullo schermo. Per istruzioni sull'uso di Adobe Reader, consultare il menu Guida in linea e supporto tecnico.



*** AVVISO IMPORTANTE:** Notare che le guide menzionate in precedenza, sia informa stampata che elettronica, sono solo per riferimento e a eccezione delle informazioni specifiche sulla garanzie contenute nella AcerSystem User Guide, nulla di ciò che è contenuto nelle presenti guide costituisce una rappresentazione o una garanzia da parte di Acer con riferimento al prodotto acquistato. Acer declina espressamente qualsiasi responsabilità per errori contenuti nelle presenti guide.

Configurazione rete

Questa guida aiuta ad eseguire la configurazione delle impostazioni di rete LAN e wireless per poter eseguire l'accesso a Internet.

Configurazione della connessione LAN

Semplicemente collegare il cavo LAN alla porta Ethernet (RJ-45). Fare riferimento a "**Vista da destra**" a pagina 6 per la posizione della porta Ethernet.

Configurare una connessione wireless

1. Premere <Fn> + <F3> per accedere a Manager Comm. Da qui è possibile attivare la connessione Wi-Fi facendo clic sul pulsante rosso accanto a Wi-Fi.

Nota: È possibile effettuare l'accesso a 3G e a Bluetooth anche da Manager Comm. I dispositivi di comunicazione possono variare da un modello all'altro.

2. Fare clic sull'icona  nella barra delle applicazioni e scegliere l'access point wireless a cui connettersi.



Inserire una carta 3G SIM (solo per alcuni modelli)

Rimuovere la batteria e inserire con attenzione la carta 3G SIM nello slot carta 3G SIM. Per la posizione dello slot carta 3G SIM, fare riferimento a "**Vista posteriore & base**" a pagina 6.

Presentazione di *Aspire One*

Dopo aver configurato il computer come illustrato nella sezione Per i principianti, far riferimento alla presente documentazione per la presentazione del nuovo notebook Acer.

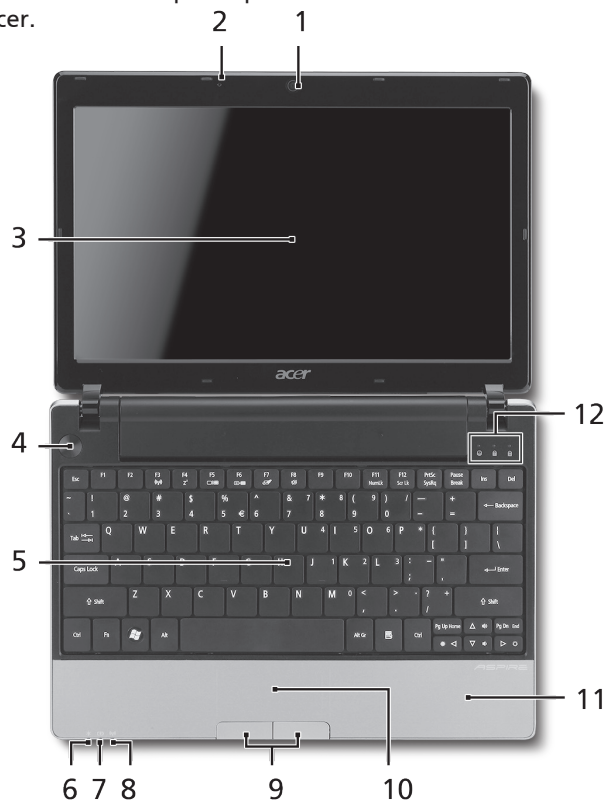

Vista dall'alto



#	Icona	Elemento	Descrizione						
1		Webcam Acer Crystal Eye	Webcam per comunicazioni video (la configurazione può variare in relazione al modello).						
2		Microfono	Microfono interno per la registrazione di audio.						
3		Display	Grande display a cristalli liquidi (Liquid-Crystal Display; LCD), per una visualizzazione confortevole (la configurazione può variare in relazione al modello).						
4		Tasto di accensione	Accende/spegne il computer.						
5		Tastiera	Per l'immissione di dati sul computer.						
6		Indicatore di alimentazione ¹	Indicano lo stato di accensione/alimentazione del computer.						
7		Indicatore batteria ¹	Indicano lo stato della batteria del computer. 1. In carica: Luce di colore giallo quando la batteria è in ricarica. 2. Completamente carica: Luce di colore blu quando è nella modalità AC.						
8		Indicatore comunicazione ¹	Indica lo stato della trasmissione wireless LAN/3G. <table border="1" data-bbox="1077 658 1556 736"> <thead> <tr> <th>Luce blu</th> <th>Luce arancione</th> <th>Spento</th> </tr> </thead> <tbody> <tr> <td>3G attivo/WiFi attivo</td> <td>3G disattivo/WiFi attivo</td> <td>3G disattivo/WiFi disattivo</td> </tr> </tbody> </table>	Luce blu	Luce arancione	Spento	3G attivo/WiFi attivo	3G disattivo/WiFi attivo	3G disattivo/WiFi disattivo
Luce blu	Luce arancione	Spento							
3G attivo/WiFi attivo	3G disattivo/WiFi attivo	3G disattivo/WiFi disattivo							
9		Tasti clic (sinistra e destra)	I tasti destra e sinistra hanno le stesse funzioni dei tasti destra e sinistra del mouse.						
10		Touchpad	Dispositivo di puntamento sensibile al tocco con funzioni simili a quelle di un comune mouse.						
11		Poggiapolsi	Comoda area su cui poggiare i polsi durante l'utilizzo del computer.						
12		Indicatore disco rigido	Si accende quando l'hard disk è attivo.						
		Bloc Num	Si illumina quando Bloc Num è attivato.						
		Bloc Maiusc	Si illumina quando Bloc Maiusc è attivato.						

1. Gli indicatori del pannello frontale sono visibili anche quando il coperchio del computer è chiuso.

Vista frontale in dettaglio

#	Icona	Elemento	Descrizione
1		Indicatori di stato	LED (Light-Emitting Diodes) che si illuminano per mostrare lo stato di funzioni e componenti del computer.

Vista da sinistra

2		Porta display esterno (VGA)	Effettua il collegamento a un dispositivo di visualizzazione (ad es., monitor esterno, proiettore LCD).
3		Jack CC-in	Per il collegamento all'adattatore CA.
4		HDMI Porta HDMI	Supporta collegamento per video digitali ad alta definizione.
5		Aperture per la ventilazione	Permettono il raffreddamento del computer, anche dopo un uso prolungato.
6		Porta USB 2.0	Effettua il collegamento ai dispositivi USB 2.0 (ad es., mouse USB, fotocamera USB).

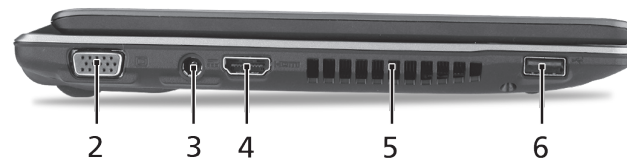

Vista da destra

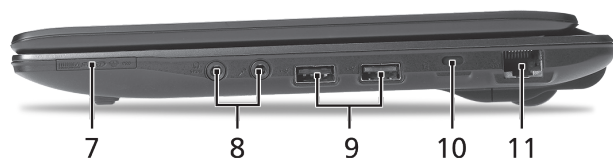

#	Icona	Elemento	Descrizione
7		Letttore di schede multiplo	Supporta Secure Digital (SD), MultiMediaCard (MMC), Memory Stick (MS), Memory Stick Pro (MS PRO), e xD-Picture Card (xD). Nota: Premere per rimuovere/installare la scheda. è possibile utilizzare una sola scheda di memoria alla volta.
8		Jack ingresso microfono	Accetta ingressi proveniente da microfoni esterni.
		Jack auricolari/altoparlante/line-out con supporto S/PDIF	Effettua il collegamento ai dispositivi audio line-out (ad es., altoparlanti, auricolari).
9		Porta USB 2.0	Connette a dispositivi USB 2.0 (p.e., mouse USB).
10		Slot blocco Kensington	Per il collegamento al blocco di sicurezza dei computer Kensington-compatibili.
11		Porta Ethernet (RJ-45)	Effettua il collegamento a una rete con Ethernet 10/100/1000.

Vista posteriore & base

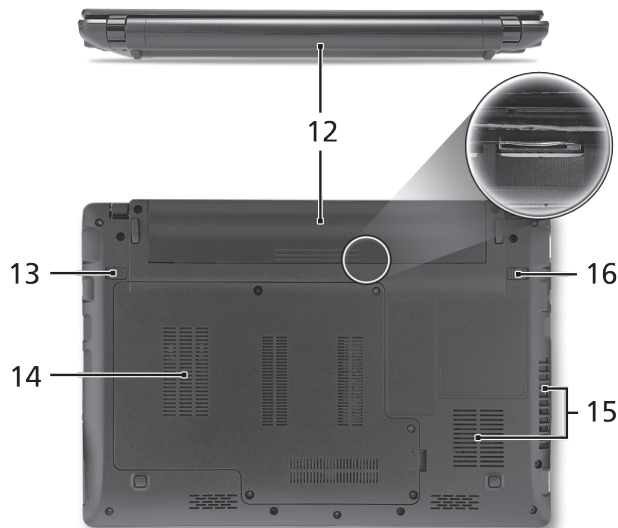

12		Alloggiamento della batteria	Contiene il pacco batteria del computer.
13		Gancio di rilascio della batteria	Per togliere la batteria.
14		Alloggiamento per il disco rigido	Alloggia il disco rigido del computer (fissato con viti).
		Vano per la memoria	Contiene la memoria principale del computer.
15		Aperture per la ventilazione e ventola di raffreddamento	Permettono il raffreddamento del computer, anche dopo un uso prolungato. Nota: Non coprire e non ostruire l'apertura della ventola.
16		Blocco batteria	Blocca la batteria al suo posto.

Condizioni operative

Temperatura:

Di esercizio: 5°C e 35°C

Non di esercizio: -20°C e 65°C

Umidità (senza condensa):

Di esercizio: 20% e 80%

Non di esercizio: 20% e 80%

Serie **ASPIRE** ONE

Guía rápida

Ordenador portátil Serie *Aspire One*

Número de modelo: _____

Número de serie: _____

Fecha de compra: _____

Lugar de compra: _____

Federal Communications Commission

Declaration of Conformity

This device complies with Part 15 of the FCC Rules. Operation is subject to the following two conditions: (1) this device may not cause harmful interference, and (2) this device must accept any interference received, including interference that may cause undesired operation.

The following local Manufacturer / Importer is responsible for this declaration:

Product name:	Notebook PC
Brand:	Acer
Model number:	MS2296
Machine type:	<i>AO 753 series</i>
Name of Responsible Party:	Acer America Corporation
Address of responsible party:	333 West San Carlos St., San Jose CA 95110, U. S. A.
Contact person:	Acer Representative
Phone No.:	1-254-298-4000
Fax No.:	1-254-298-4147
April 30, 2010	

CE Declaration of Conformity

We,

Acer Incorporated

8F, 88, Sec. 1, Hsin Tai Wu Rd., Hsichih, Taipei Hsien 221, Taiwan

Contact Person: Mr. Easy Lai, e-mail:easy_lai@acer.com.tw



And,

Acer Europe SA

Via Cantonale, Centro Galleria 2 6928 Manno Switzerland

Hereby declare that:

Product: Notebook Computer

Trade Name: Acer

Model Number: MS2296

Machine Type: AO753 series

Is compliant with the essential requirements and other relevant provisions of the following EC directives, and that all the necessary steps have been taken and are in force to assure that production units of the same product will continue comply with the requirements.

EMC Directive 2004/108/EC as attested by conformity with the following harmonized standards:

- EN55022, AS/NZS CISPR22, Class B
- EN55024
- EN61000-3-2 Class D
- EN61000-3-3

Low Voltage Directive 2006/95/EC as attested by conformity with the following harmonized standard:

- EN60950-1

Council Decision 98/482/EC (CTR21):

(Applicable to product with pan- European single terminal connection to the Public Switched Telephone Network (PSTN).)

RoHS Directive 2002/95/EC on the Restriction of the Use of certain Hazardous Substances in Electrical and Electronic Equipment

- The maximum concentration values of the restricted substances by weight in homogenous material are:

Lead	0.1%	Polybrominated Biphenyls (PBB's)	0.1%
Mercury	0.1%	Polybrominated Diphenyl Ethers (PBDE's)	0.1%
Hexavalent Chromium	0.1%	Cadmium	0.01%

Directive 2009/125/EC with regard to establishing a framework for the setting of ecodesign requirements for energy-related product.

R&TTE Directive 1999/5/EC as attested by conformity with the following harmonized standard:

- Article 3.1(a) Health and Safety
 - EN60950-1
 - EN62311
- Article 3.1(b) EMC
 - EN301 489-1
 - EN301 489-3 (Applicable to non-bluetooth wireless keyboard mouse set).
 - EN301 489-7
 - EN301 489-17
 - EN301 489-24
- Article 3.2 Spectrum Usages
 - EN300 440-2 (Applicable to non-bluetooth wireless keyboard mouse set).
 - EN300 328
 - EN301 511
 - EN301 893 (Applicable to 5GHz high performance RLAN).
 - EN301 908-1
 - EN301 908-2

Year to begin affixing CE marking 2010.

Easy Lai

Easy Lai /Manager
Regulation Center, Acer Inc.

Apr. 30, 2010

Date

Sólo para principiantes

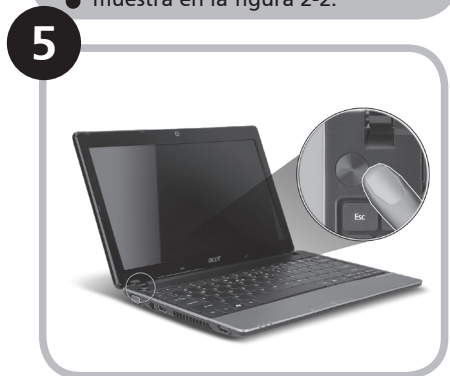
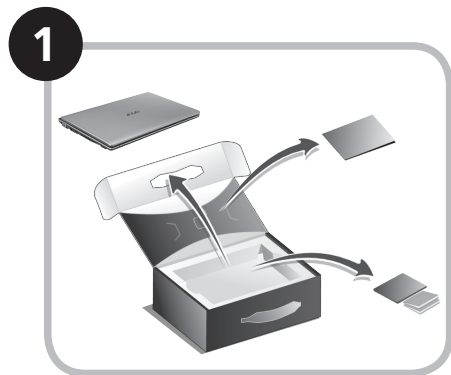

Las ilustraciones son sólo una referencia. Las especificaciones reales del producto pueden ser diferentes.

Primero lo más importante

Le agradecemos que haya elegido el ordenador portátil de Acer para satisfacer sus necesidades de informática móvil.

Sus guías

Para ayudarle a utilizar su ordenador portátil de Acer, hemos diseñado un conjunto de guías*:

En primer lugar, la Guía Rápida le ayuda a empezar a configurar su ordenador.

Si desea más información sobre cómo puede su ordenador ayudarle a ser más productivo, consulte AcerSystem User Guide. Esta guía contiene información detallada sobre temas como utilidades del sistema, recuperación de datos, opciones de ampliación y solución de problemas. Además, contiene información sobre garantías y las normativas generales y advertencias de seguridad para su ordenador portátil. Está disponible en PDF (Formato de Documento Portátil) y viene precargada en su ordenador portátil.



Nota: Para ver los archivos debe tener Adobe Reader instalado en su ordenador. Si no tiene instalado Adobe Reader en su ordenador, haga clic en AcerSystem User Guide para ejecutar en primer lugar el programa de instalación de Adobe Reader. Siga las instrucciones en pantalla para completar la instalación. Para obtener instrucciones sobre cómo utilizar Adobe Reader, acceda al menú de Soporte y Ayuda.



*** AVISO IMPORTANTE:** Tenga en cuenta que las guías mencionadas, en forma electrónica o impresa, sirven únicamente de referencia y salvo que se especifique en la información de garantía específica que se incluye en AcerSystem User Guide, nada de lo contenido en estas guías constituirá una representación o garantía de Acer en relación con el producto adquirido. Acer rechaza expresamente cualquier responsabilidad por errores contenidos en las guías.

Configuración de red

Esta guía le ayudará a configurar los ajustes de red inalámbrica y LAN para que pueda conectarse a Internet.

Configurar una conexión LAN

Basta con conectar el cable LAN al puerto de Ethernet (RJ-45). Consulte "**Vista derecha**" en la **página 6** para la ubicación del puerto Ethernet.

Configurar una conexión inalámbrica

1. Pulse <Fn> + <F3> para acceder al administrador de comunicación. Aquí puede activar la conexión Wi-Fi haciendo clic en el botón rojo que hay junto a Wi-Fi.

Nota: También se puede acceder a 3G y Bluetooth a través del administrador de comunicación. Los dispositivos de comunicación varían según el modelo.

2. Haga clic en el icono  en la bandeja del sistema y seleccione el punto de acceso inalámbrico que desee conectar.



Insertar una tarjeta SIM 3G (sólo en determinados modelos)

Extraiga la batería e inserte con cuidado una tarjeta SIM 3G en la ranura para tarjeta SIM 3G. Consulte "**Vista trasera & Vista de la base**" en la **página 6** para ver dónde se encuentra la ranura para tarjeta SIM 3G.

Presentación de su *Aspire One*

Después de configurar su ordenador tal y como se indica en la sección Sólo para principiantes, permítanos enseñarle su nuevo ordenador portátil de Acer.

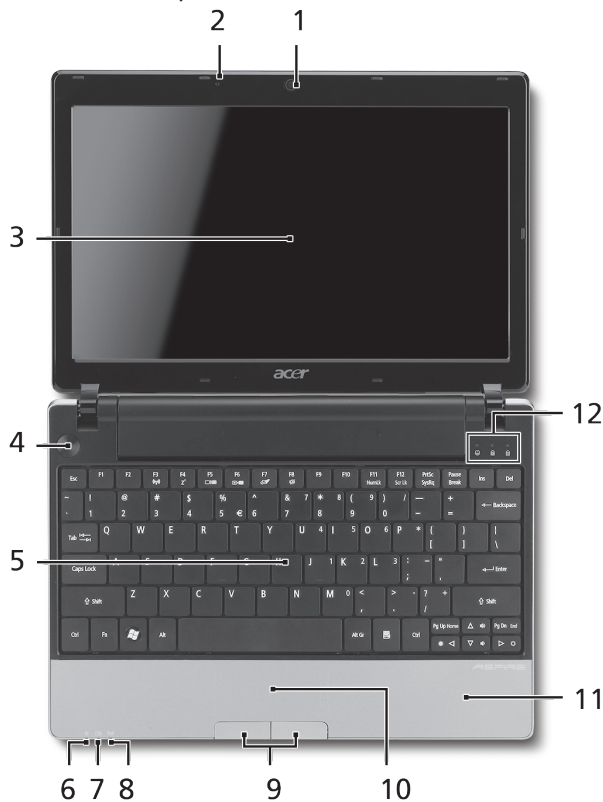

Vista superior

#	Icono	Elemento	Descripción						
1		Webcam Acer Crystal Eye	Cámara para comunicación de vídeo (la configuración puede variar según el modelo).						
2		Micrófono	Micrófono interno para la grabación del sonido.						
3		Visualización en pantalla	También denominada pantalla de cristal líquido (LCD) es el dispositivo de salida visual del ordenador (la configuración puede variar según el modelo).						
4		Botón de encendido	Enciende o apaga el ordenador.						
5		Teclado	Para introducir datos en su ordenador.						
6		Indicador de encendido ¹	Proporciona información sobre el estado de energía del ordenador.						
7		Indicador de batería ¹	Proporciona información sobre el estado de la batería. 1. Carga: La luz se vuelve ámbar cuando se carga la batería. 2. Carga completa: La luz se vuelve azul en modo de CA.						
8		Indicador de comunicación ¹	Indica el estado de la comunicación LAN inalámbrica/3G. <table border="1" data-bbox="1109 607 1565 740"> <thead> <tr> <th>Luz azul encendida</th> <th>Luz naranja encendida</th> <th>Apagado</th> </tr> </thead> <tbody> <tr> <td>Función 3G activada/ WiFi activada</td> <td>Función 3G desactivada/ WiFi activada</td> <td>Función 3G desactivada/ WiFi desactivada</td> </tr> </tbody> </table>	Luz azul encendida	Luz naranja encendida	Apagado	Función 3G activada/ WiFi activada	Función 3G desactivada/ WiFi activada	Función 3G desactivada/ WiFi desactivada
Luz azul encendida	Luz naranja encendida	Apagado							
Función 3G activada/ WiFi activada	Función 3G desactivada/ WiFi activada	Función 3G desactivada/ WiFi desactivada							
9		Botones de clic (izquierdo y derecho)	Los botones izquierdo y derecho funcionan como los botones izquierdo y derecho del ratón.						
10		Teclado táctil	Dispositivo apuntador táctil que funciona como un ratón de ordenador.						
11		Soporte para las palmas	Área de soporte que permite reposar cómodamente las palmas de las manos cuando se utiliza el ordenador.						
12		Indicador de disco duro	Indica si la unidad de disco duro está activa.						
		Bloq Núm	Se enciende al activar el bloqueo del teclado numérico.						
		Bloq mayús	Se enciende al activar el bloqueo de mayúsculas.						



1. Los indicadores del panel frontal son visibles aunque se cierre la tapa del ordenador.

Vista frontal cerrada

#	Icono	Elemento	Descripción
1		Indicadores de estado	Diodos luminosos (LED) que se encienden para mostrar el estado de las funciones y componentes del ordenador.



Vista izquierda

2		Puerto de visualización externo (VGA)	Permite conectar a un dispositivo de visualización (p.ej., monitor externo, proyector de LCD).
3		Conector de entrada de DC	Permite conectar a un adaptador de CA.
4	HDMI	Puerto HDMI	Compatible con conexiones de vídeo digital de alta definición.
5		Ranuras de ventilación	Permite que el ordenador esté frío, incluso tras un uso prolongado.
6		Puerto USB 2.0	Permite conectar a dispositivos USB 2.0 (p.ej., ratón USB, cámara USB).

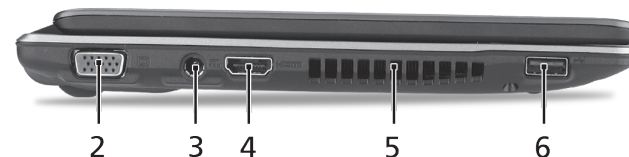

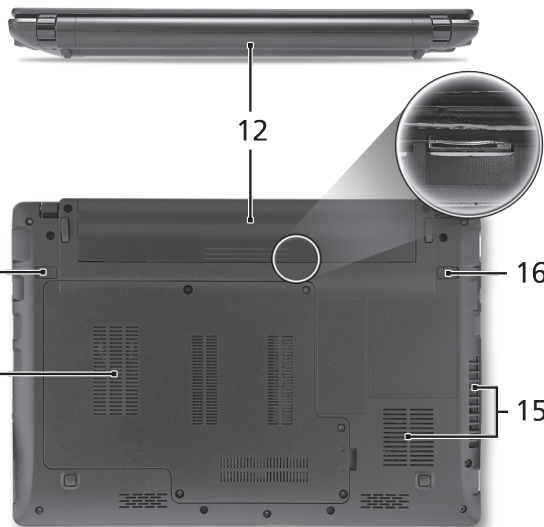
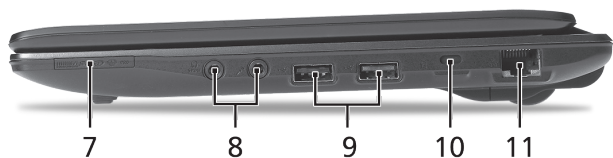

Vista derecha

#	Icono	Elemento	Descripción
7		Lector de tarjetas multifunción	Admite la tarjeta Secure Digital (SD), MultiMedia (MMC), Memory Stick (MS), Memory Stick PRO (MS PRO), xD-Picture (xD). Nota: Presionar para extraer/installar la tarjeta. Sólo puede funcionar una tarjeta en un momento dado.
8		Conector de entrada para micrófono	Permite la entrada de audio de micrófonos externos.
		Conector de salida/auriculares/altavoz compatible con S/PDIF	Conexión para dispositivos de salida de audio (p.ej., altavoces, auriculares, etc.).
9		Puerto USB 2.0	Permite conectar a dispositivos USB 2.0 (p.ej., ratón USB).
10		Ranura de bloqueo Kensington	Permite conectar a un candado de seguridad para ordenador compatible con Kensington.
11		Puerto Ethernet (RJ-45)	Permite conectar a una red basada en Ethernet 10/100/1000.

Vista trasera & Vista de la base

12		Compartimento de la batería	Aloja la batería del ordenador.
13		Pestillo de liberación de la batería	Libera la batería para poder sacarla.
14		Compartimento del disco duro	Contiene el disco duro del ordenador (fijado con tornillos).
		Compartimento de memoria	Contiene la memoria principal de ordenador.
15		Ranuras de ventilación y ventilador de refrigeración	Permite que el ordenador esté frío, incluso tras un uso prolongado. Nota: No tape ni obstruya la apertura del ventilador.
16		Bloqueo de la batería	Permite que la batería quede trabada.

Medio ambiente

Temperatura:

Encendido: entre 5°C y 35°C

Apagado: entre -20°C y 65°C

Humedad (sin condensación):

Encendido: entre 20% y 80%

Apagado: entre 20% y 80%

Série **ASPIRE** ONE

Guia rápido

Computador Portátil Série *Aspire One*

Número de modelo: _____

Número de série: _____

Data da aquisição: _____

Local de aquisição: _____

Federal Communications Commission

Declaration of Conformity

This device complies with Part 15 of the FCC Rules. Operation is subject to the following two conditions: (1) this device may not cause harmful interference, and (2) this device must accept any interference received, including interference that may cause undesired operation.

The following local Manufacturer / Importer is responsible for this declaration:

Product name:	Notebook PC
Brand:	Acer
Model number:	MS2296
Machine type:	<i>AO 753 series</i>
Name of Responsible Party:	Acer America Corporation
Address of responsible party:	333 West San Carlos St., San Jose CA 95110, U. S. A.
Contact person:	Acer Representative
Phone No.:	1-254-298-4000
Fax No.:	1-254-298-4147
April 30, 2010	

CE Declaration of Conformity

We,

Acer Incorporated

8F, 88, Sec. 1, Hsin Tai Wu Rd., Hsichih, Taipei Hsien 221, Taiwan

Contact Person: Mr. Easy Lai, e-mail:easy_lai@acer.com.tw



And,

Acer Europe SA

Via Cantonale, Centro Galleria 2 6928 Manno Switzerland

Hereby declare that:

Product: Notebook Computer

Trade Name: Acer

Model Number: MS2296

Machine Type: AO753 series

Is compliant with the essential requirements and other relevant provisions of the following EC directives, and that all the necessary steps have been taken and are in force to assure that production units of the same product will continue comply with the requirements.

EMC Directive 2004/108/EC as attested by conformity with the following harmonized standards:

- EN55022, AS/NZS CISPR22, Class B
- EN55024
- EN61000-3-2 Class D
- EN61000-3-3

Low Voltage Directive 2006/95/EC as attested by conformity with the following harmonized standard:

- EN60950-1

Council Decision 98/482/EC (CTR21):

(Applicable to product with pan- European single terminal connection to the Public Switched Telephone Network (PSTN).)

RoHS Directive 2002/95/EC on the Restriction of the Use of certain Hazardous Substances in Electrical and Electronic Equipment

- The maximum concentration values of the restricted substances by weight in homogenous material are:

Lead	0.1%	Polybrominated Biphenyls (PBB's)	0.1%
Mercury	0.1%	Polybrominated Diphenyl Ethers (PBDE's)	0.1%
Hexavalent Chromium	0.1%	Cadmium	0.01%

Directive 2009/125/EC with regard to establishing a framework for the setting of ecodesign requirements for energy-related product.

R&TTE Directive 1999/5/EC as attested by conformity with the following harmonized standard:

- Article 3.1(a) Health and Safety
 - EN60950-1
 - EN62311
- Article 3.1(b) EMC
 - EN301 489-1
 - EN301 489-3 (Applicable to non-bluetooth wireless keyboard mouse set).
 - EN301 489-7
 - EN301 489-17
 - EN301 489-24
- Article 3.2 Spectrum Usages
 - EN300 440-2 (Applicable to non-bluetooth wireless keyboard mouse set).
 - EN300 328
 - EN301 511
 - EN301 893 (Applicable to 5GHz high performance RLAN).
 - EN301 908-1
 - EN301 908-2

Year to begin affixing CE marking 2010.

Easy Lai

Easy Lai /Manager
Regulation Center, Acer Inc.

Apr. 30, 2010

Date

Para começar

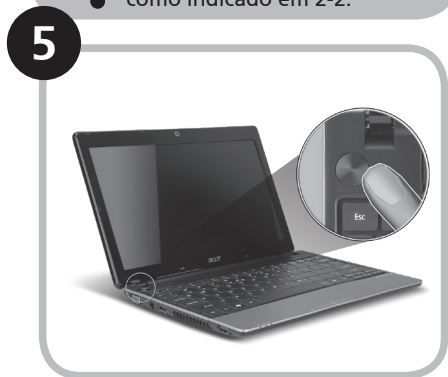
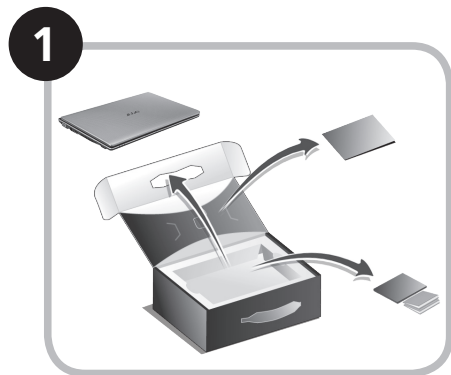

As ilustrações são apenas uma referência. As especificações reais do produto podem variar.

Primeiro que tudo

Gostaríamos de lhe agradecer por ter escolhido um computador portátil Acer para preencher as suas necessidades de computador móvel.

Os seus manuais

Para o ajudar a usar o seu computador portátil Acer, preparámos uma série de manuais*:

Antes de mais, o Guia Rápido ajuda-o a ligar e configurar o seu computador.

Para mais detalhes sobre como o seu computador o pode ajudar a ser mais produtivo, consulte o AcerSystem User Guide (Manual do Utilizador AcerSystem). Esse manual contém informações pormenorizadas sobre temas como utilitários do sistema, recuperação de dados, opções de expansão e solução de problemas. Além disso, contém a informação da garantia e as regulamentações gerais e notas de segurança para o seu computador portátil. Está disponível no formato PDF (Portable Document Format) e vem já instalado no seu computador.



Nota: É necessário o Adobe Reader para visualizar o ficheiro. Se o Adobe Reader não estiver instalado no seu computador, ao clicar em AcerSystem User Guide é executado o programa de instalação do Acrobat Reader. Siga as instruções do ecrã para finalizar a instalação. Para obter instruções sobre como utilizar o Adobe Reader, vá ao menu Ajuda e Suporte.



*** AVISO IMPORTANTE:** Os guias aqui mencionados, seja em formato impresso ou electrónico, são apenas de natureza informativa e, exceptuando quando referido nas informações de garantia específicas, incluídas no AcerSystem User Guide, nada do que consta destes guias constitui uma representação ou garantia da Acer relativamente ao produto que adquiriu. A Acer declina expressamente qualquer responsabilidade por erros contidos nos guias.

Configuração de rede

Este guia ajudá-lo(a)-á a configurar as definições da sua LAN e rede sem fios para que possa ligar-se à Internet.

Configurar uma ligação LAN

Basta ligar o cabo LAN ao porto Ethernet (RJ-45). Consulte "**Vista direita**" na **página 6** para saber a localização do porto Ethernet.

Configurar uma ligação sem fios

1. Prima <Fn> + <F3> para aceder ao gestor de comunicação. Aqui poderá activar a ligação WI-Fi clicando no botão vermelho junto de Wi-Fi.

Nota: Também pode aceder a 3G e Bluetooth através do gestor de comunicação. Os dispositivos de comunicação variam consoante o modelo.

2. Clique no  ícone no seu tabuleiro de sistema e escolha o ponto de acesso sem fios ao qual se deseja ligar.

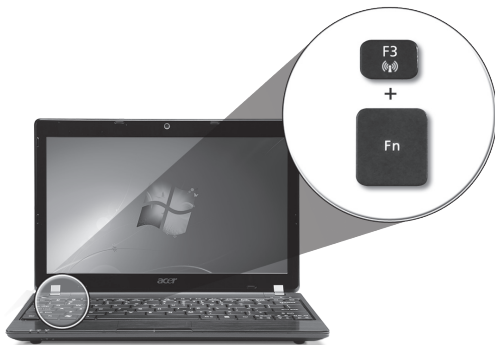

Inserir um cartão SIM 3G (apenas em certos modelos)

Retire a bateria e insira com cuidado o cartão SIM 3G na respectiva ranhura. Consulte "**Vista traseira & Vista da base**" na **página 6** quanto à localização da ranhura para o cartão SIM 3G.

Visita guiada ao seu *Aspire One*

Depois de configurar o seu computador como ilustrado na secção Para começar, deixe-nos dar-lhe a conhecer o seu novo portátil Acer.

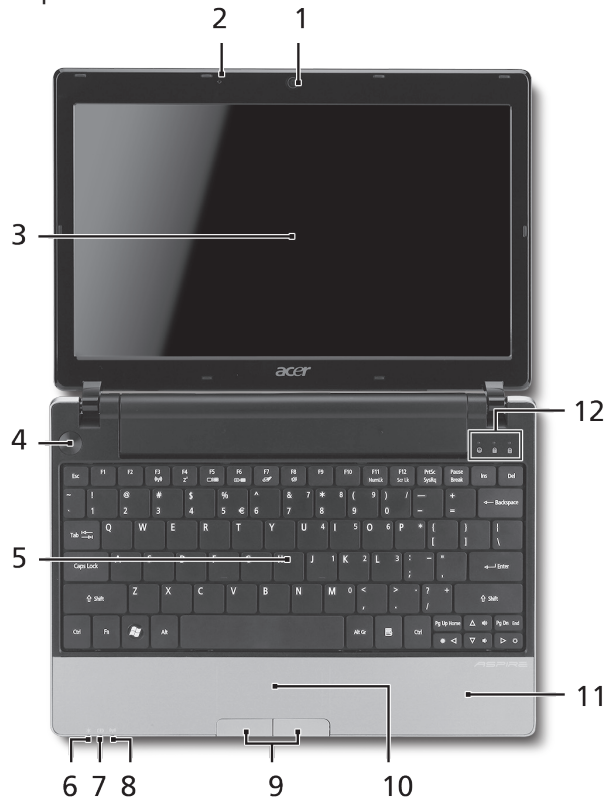

Vista de cima



#	Ícone	Item	Descrição						
1		Webcam Acer Crystal Eye	Webcam para comunicação por vídeo (a configuração pode variar consoante o modelo).						
2		Microfone	Microfone interno para gravação de som.						
3		Ecrã	Também chamado ecrã de cristais líquidos (LCD), permite visualizar a informação do computador (a configuração pode variar consoante o modelo).						
4		Botão de alimentação	Liga e desliga o computador.						
5		Teclado	Para introduzir informações no seu computador.						
6		Indicador de alimentação ¹	Indica o estado da alimentação do computador.						
7		Indicador da bateria ¹	Indica o estado da bateria do computador. 1. A carregar: A luz é âmbar quando a bateria está a carregar. 2. Carga completa: A luz é azul no modo CA.						
8		Indicador de comunicação ¹	Indica o estado de comunicação Sem Fios LAN/3G. <table border="1" data-bbox="1114 632 1544 739"> <thead> <tr> <th>Luz azul ligada</th> <th>Luz laranja ligada</th> <th>Sem luz</th> </tr> </thead> <tbody> <tr> <td>3G ligado/ WiFi ligado</td> <td>3G desligado/ WiFi ligado</td> <td>3G desligado/ WiFi desligado</td> </tr> </tbody> </table>	Luz azul ligada	Luz laranja ligada	Sem luz	3G ligado/ WiFi ligado	3G desligado/ WiFi ligado	3G desligado/ WiFi desligado
Luz azul ligada	Luz laranja ligada	Sem luz							
3G ligado/ WiFi ligado	3G desligado/ WiFi ligado	3G desligado/ WiFi desligado							
9		Botões de clique (esquerdo e direito)	Os botões esquerdo e direito funcionam como os botões esquerdo e direito de um rato.						
10		Teclado tátil	Dispositivo apontador sensível ao toque, que funciona como um rato de computador.						
11		Descanso de mãos	Área confortável de apoio para as suas mãos enquanto utiliza o computador.						
12		Indicador HDD	Indica quando o disco rígido está activo.						
		Num Lock	Acende-se quando a função Num Lock é activada.						
		Caps Lock	Acende-se quando a função Caps Lock é activada.						

1. Os indicadores no painel dianteiro são visíveis mesmo com a tampa do monitor fechada.

Vista frontal, fechado

#	Ícone	Item	Descrição
1		Indicadores de estado	Díodos Emissores de Luz (LED) que se acendem para mostrar o estado das funções e componentes do computador.

Vista esquerda

2		Ligação a ecrã externo (VGA)	Liga a um dispositivo de visualização (por exemplo, monitor externo, projector LCD).
3		Tomada de entrada CC	Liga a um adaptador CA.
4	HDMI	Porta HDMI	Suporta ligações de vídeo digital de alta definição.
5		Ranhas de ventilação	Permite ao computador manter-se fresco, mesmo após uso prolongado.
6		Entrada USB 2.0	Liga a dispositivos USB 2.0 (por ex. rato USB, câmara USB).

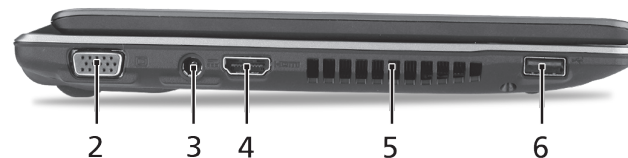

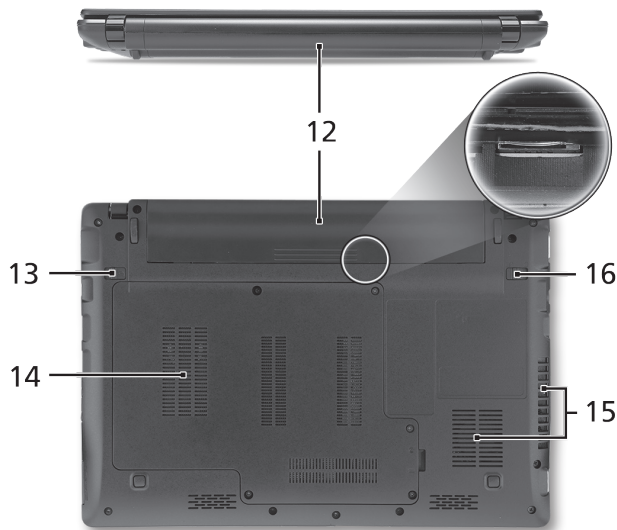
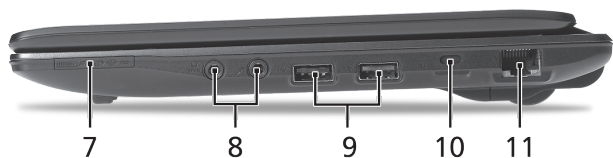

Vista direita

#	Ícone	Item	Descrição
7		Leitor de cartões vários-em-um	Aceita cartões Secure Digital (SD), MultiMediaCard (MMC), Memory Stick (MS), Memory Stick PRO (MS PRO), xD-Picture Card (xD). Nota: Empurre para remover/installar o cartão. Apenas pode ser utilizado um cartão de cada vez.
8		Conector de entrada do microfone	Aceita entradas de microfones externos.
		Tomada de auscultador/altifalante/saída compatível com S/PDIF	Liga a dispositivos de saída de áudio (por exemplo, altifalantes, auscultadores).
9		Entrada USB 2.0	Liga a dispositivos USB 2.0 (por ex. rato USB).
10		Ranhuira de bloqueio Kensington	Liga a um cadeado de segurança Kensington (ou compatível).
11		Entrada Ethernet (RJ-45)	Liga a uma rede Ethernet de base 10/100/1000.

Vista traseira & Vista da base

12		Baía da bateria	Contém a bateria do computador.
13		Patilha de liberação da bateria	Liberta a bateria para remoção.
14		Compartimento do disco rígido	Aloja o disco rígido do computador (seguro por parafusos).
		Compartimento da memória	Aloja a memória principal do computador.
15		Ranhuira de ventilação e ventoinha de arrefecimento	Permite ao computador manter-se fresco, mesmo após uso prolongado. Nota: Não tape nem obstrua a abertura da ventoinha.
16		Bloqueio da bateria	Bloqueia a bateria, mantendo-a no sítio.

Ambiente

Temperatura:

Funcionamento: 5°C a 35°C

Não em funcionamento: -20°C a 65°C

Humidade (não condensação):

Funcionamento: 20% a 80%

Não em funcionamento: 20% a 80%

ASPIRE ONE *Serie*

Snelgids

ASPIRE One Serie

© 2010 Alle rechten voorbehouden

Snelgids voor de *Aspire One Serie*
Oorspronkelijke uitgave: 04/2010

Aspire One Serie Notebook PC

Modelnummer: _____

Serienummer: _____

Aankoopdatum: _____

Plaats van aankoop: _____

Federal Communications Commission

Declaration of Conformity

This device complies with Part 15 of the FCC Rules. Operation is subject to the following two conditions: (1) this device may not cause harmful interference, and (2) this device must accept any interference received, including interference that may cause undesired operation.

The following local Manufacturer / Importer is responsible for this declaration:

Product name:	Notebook PC
Brand:	Acer
Model number:	MS2296
Machine type:	<i>AO 753 series</i>
Name of Responsible Party:	Acer America Corporation
Address of responsible party:	333 West San Carlos St., San Jose CA 95110, U. S. A.
Contact person:	Acer Representative
Phone No.:	1-254-298-4000
Fax No.:	1-254-298-4147
April 30, 2010	

CE Declaration of Conformity

We,

Acer Incorporated

8F, 88, Sec. 1, Hsin Tai Wu Rd., Hsichih, Taipei Hsien 221, Taiwan

Contact Person: Mr. Easy Lai, e-mail:easy_lai@acer.com.tw

And,

Acer Europe SA

Via Cantonale, Centro Galleria 2 6928 Manno Switzerland

Hereby declare that:

Product: Notebook Computer

Trade Name: Acer

Model Number: MS2296

Machine Type: AO753 series

Is compliant with the essential requirements and other relevant provisions of the following EC directives, and that all the necessary steps have been taken and are in force to assure that production units of the same product will continue comply with the requirements.

EMC Directive 2004/108/EC as attested by conformity with the following harmonized standards:

- EN55022, AS/NZS CISPR22, Class B
- EN55024
- EN61000-3-2 Class D
- EN61000-3-3

Low Voltage Directive 2006/95/EC as attested by conformity with the following harmonized standard:

- EN60950-1

Council Decision 98/482/EC (CTR21):

(Applicable to product with pan- European single terminal connection to the Public Switched Telephone Network (PSTN).)

RoHS Directive 2002/95/EC on the Restriction of the Use of certain Hazardous Substances in Electrical and Electronic Equipment



- The maximum concentration values of the restricted substances by weight in homogenous material are:

Lead	0.1%	Polybrominated Biphenyls (PBB's)	0.1%
Mercury	0.1%	Polybrominated Diphenyl Ethers (PBDE's)	0.1%
Hexavalent Chromium	0.1%	Cadmium	0.01%

Directive 2009/125/EC with regard to establishing a framework for the setting of ecodesign requirements for energy-related product.

R&TTE Directive 1999/5/EC as attested by conformity with the following harmonized standard:

- Article 3.1(a) Health and Safety
 - EN60950-1
 - EN62311
- Article 3.1(b) EMC
 - EN301 489-1
 - EN301 489-3 (Applicable to non-bluetooth wireless keyboard mouse set).
 - EN301 489-7
 - EN301 489-17
 - EN301 489-24
- Article 3.2 Spectrum Usages
 - EN300 440-2 (Applicable to non-bluetooth wireless keyboard mouse set).
 - EN300 328
 - EN301 511
 - EN301 893 (Applicable to 5GHz high performance RLAN).
 - EN301 908-1
 - EN301 908-2

Year to begin affixing CE marking 2010.

Easy Lai

Easy Lai /Manager
Regulation Center, Acer Inc.

Apr. 30, 2010

Date

Aan de slag

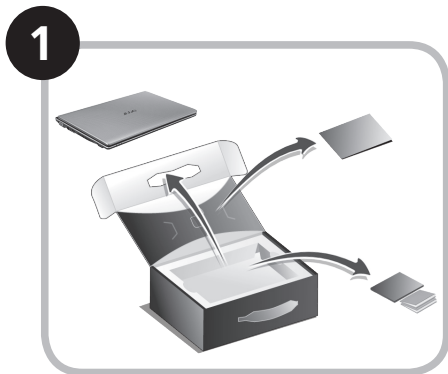

Illustraties zijn alleen ter verwijzing. Daadwerkelijke productspecificaties kunnen afwijken.

Om te beginnen

Bedankt dat u hebt gekozen voor een notebook van Acer als oplossing voor uw mobiele computereisen.

Uw gidsen

Om u te helpen met het werken op het Acer notebook hebben we een aantal gidsen ontworpen*:

Allereerst helpt de Snelgids u bij het instellen van uw computer.

Als u meer wilt weten over hoe uw computer u kan helpen productiever te werken, raadpleeg dan de AcerSystem User Guide. Deze Gebruikershandleiding bevat gedetailleerde informatie over onderwerpen zoals systeemfuncties, gegevensherstel, uitbreidingsopties en probleem oplossen. Daarnaast bevat het informatie over garantie en de algemene voorwaarden en veiligheid voor uw notebook. Het is als Portable Document Format (PDF) beschikbaar en is al van te voren op uw notebook gezet.



Opmerking: Als u het bestand wilt inzien, dient Adobe Reader te zijn geïnstalleerd. Als Adobe Reader nog niet op uw computer is geïnstalleerd, wordt, als u op AcerSystem User Guide klikt, eerst het installatieprogramma van Adobe Reader gestart. Volg de instructies op het scherm om het programma te installeren. Gebruiksaanwijzingen bij Adobe Reader vindt u in het menu Help en Ondersteuning.



*** BELANGRIJKE MEDEDELING:** Neem voor kennisgeving aan dat de hier genoemde gidsen, hetzij gedrukt of in elektronische vorm, slechts ter naslag dienen en dat niets in deze gidsen een vertegenwoordiging of garantie van de kant van Acer impliceert met betrekking tot het door u gekochte product, met uitzondering van de specifieke garantie-informatie in de AcerSystem User Guide. Acer wijst uitdrukkelijke elke aansprakelijkheid af voor fouten in de gidsen.

Netwerkconfiguratie

Deze handleiding helpt u bij het configureren van de instellingen voor LAN en draadloos netwerk zodat u verbinding met internet kunt maken.

Lan-verbinding instellen

Steek gewoon de lan-kabel in de ethernetpoort (RJ-45). Zie "Rechterkant" op pagina 6 voor de plek van de ethernet-poort.

Een draadloze verbinding instellen

1. Druk op <Fn> + <F3> om communicatiebeheer te openen. Hier kunt u de Wi-Fi-verbinding inschakelen door op de rode knop naast Wi-Fi te drukken.

Opmerking: Via communicatiebeheer zijn ook 3g en Bluetooth toegankelijk. Communicatieapparaten kunnen verschillen per model.

2. Klik op het pictogram  in het systeemvak en kies het draadloos toegangspunt waarmee u verbinding wilt maken.

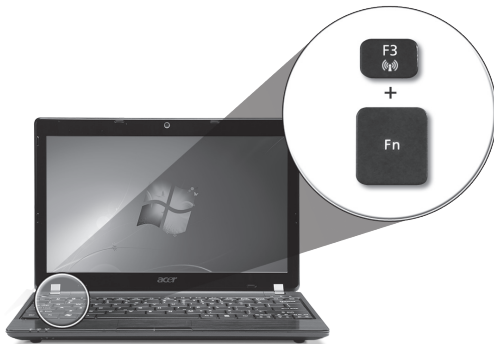

Een 3G-simkaart plaatsen (alleen voor bepaalde modellen)

Verwijder de batterij en plaats voorzichtig een 3g-sim-kaart in de 3g-sim-kaartsleuf. Zie "Achterkant & Onderkant" op pagina 6 voor de plek van de 3g-sim-kaartsleuf.

Rondleiding door de *Aspire One* Bovenkant

Na het instellen van de computer zoals aangegeven in het onderdeel Aan de slag, bent u nu klaar voor een rondleiding door het nieuwe Acer notebook.

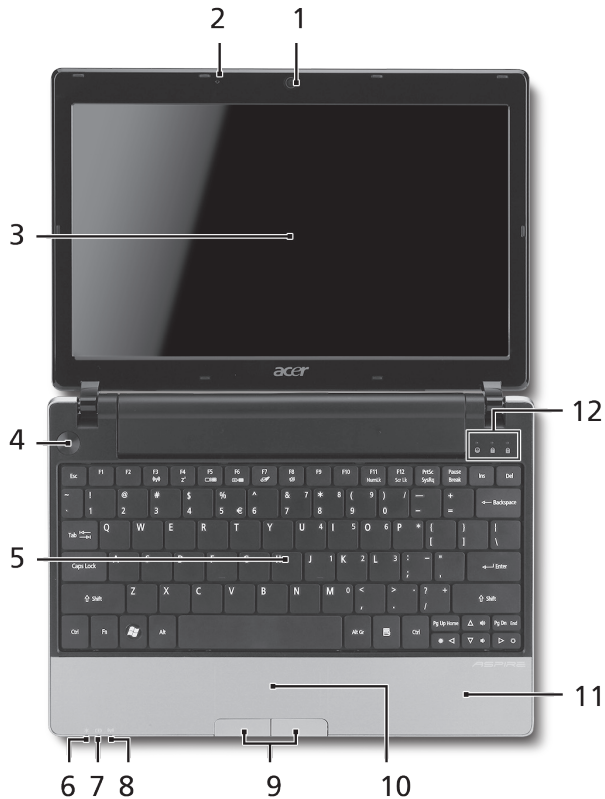

#	Pictogram	Item	Beschrijving						
1		Acer Crystal Eye webcam	Webcam voor videocommunicatie (configuratie kan per model verschillen).						
2		Microfoon	Interne microfoon voor geluidsoptname.						
3		Beeldscherm	Ook wel Liquid-Crystal Display (LCD) genoemd, geeft de output van de computer weer (configuratie kan per model verschillen).						
4		Aan/uit knop	Schakelt de computer aan en uit.						
5		Toetsenbord	Om gegevens in te voeren in de computer.						
6		Stroomindicator ¹	Geeft de vermogenstatus van de computer aan.						
7		Accu-indicator ¹	Geeft de batterijstatus van de computer aan. 1. Opladen: Het licht is oranje wanneer de accu wordt opgeladen. 2. Volledig opgeladen: Het licht is blauw in de AC-modus.						
8		Communicatie-indicator ¹	Geeft de status van draadloze lan/3g-communicatie aan.						
			<table border="1"> <thead> <tr> <th>Blauw lampje aan</th> <th>Oranje lampje aan</th> <th>Brandt niet</th> </tr> </thead> <tbody> <tr> <td>3G aan/WiFi aan</td> <td>3G uit/WiFi aan</td> <td>3G uit/WiFi uit</td> </tr> </tbody> </table>	Blauw lampje aan	Oranje lampje aan	Brandt niet	3G aan/WiFi aan	3G uit/WiFi aan	3G uit/WiFi uit
Blauw lampje aan	Oranje lampje aan	Brandt niet							
3G aan/WiFi aan	3G uit/WiFi aan	3G uit/WiFi uit							
9		Kliktoetsen (links en rechts)	De toetsen links en rechts functioneren als de linker en rechter muistoetsen.						
10		Touchpad	Tastgevoelig aanwijsapparaat dat functioneert als een computermuis.						
11		Polssteun	Comfortabele ondersteuning voor uw handen wanneer u de computer gebruikt.						
12		HDD-indicator	Licht op wanneer de harde schijf actief is.						
		Num Lock	Brandt wanneer het Num Lock is ingeschakeld.						
		Caps Lock	Brandt wanneer het Caps Lock is ingeschakeld.						



1. De statusindicatoren aan de voorkant zijn zelfs zichtbaar als het scherm gesloten is.

Voorkant gesloten

#	Pictogram	Item	Beschrijving
1		Statusindicatoren	Light-Emitting Diodes (leds) die oplichten om de status van functies en componenten van de computer aan te geven.



Linkerkant

2		Externe weergavepoort (VGA)	Aansluiting voor een beeldscherm (bijv. een externe monitor, LCD-projector).
3		Gelijkstroomaansluiting	Aansluiting voor een adapter.
4	Hdmi	Hdmi-poort	Ondersteunt high-definition digitale videosignalen.
5		Ventilatie-sleuven	Zorgen dat de computer koel blijft, zelfs na langdurig gebruik.
6		Usb 2.0-poort	Aansluiting voor usb 2.0-apparaten (bijv. usb-muis, usb-camera).

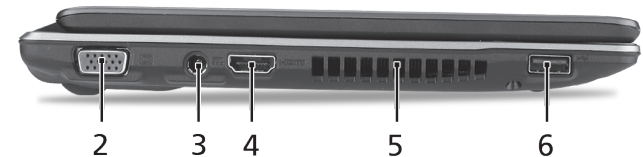

Rechterkant

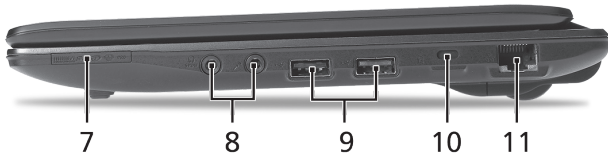

#	Pictogram	Item	Beschrijving
7		Meer-in-één-kaartlezer	Accepteert Secure Digital (SD), MultiMediaCard (MMC), Memory Stick (MS), Memory Stick PRO (MS PRO) en xD-Picture Card (xD). Opmerking: Duwen om de kaart te verwijderen/plaatsen. Er kan één kaart tegelijk worden gebruikt.
8		Aansluiting voor Microfoon-in	Aansluitingen voor externe microfoon.
		S/PDIF-ondersteuning voor hoofdtelefoon/ luidspreker/lijn-uit	Aansluiting voor lijn-uit audioapparaten (bijv. luidsprekers, hoofdtelefoon).
9		Usb 2.0-poort	Aansluiting voor usb 2.0-apparaten (bijv. usb-muis).
10		Sleuf voor Kensington-slot	Aansluiting voor een Kensington-compatibel computerbeveiligingsslot.
11		Ethernetpoort (RJ-45)	Aansluiting voor een op Ethernet 10/100/1000-gebaseerd netwerk.

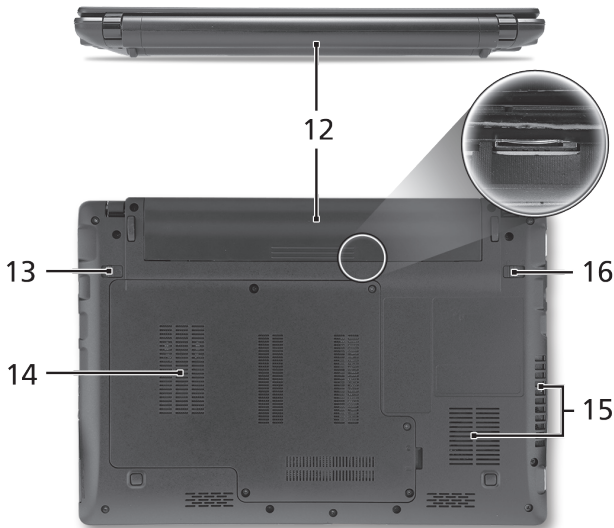

Achterkant & Onderkant

12		Batterijnis	Bevat de batterij van de computer.
13		Batterijvergrendeling	Maakt de batterij los.
14		Harde schijf nis	Bevat de harde schijf van de computer (vastgeschroefd).
		Geheugenvak	Bevat het hoofdgeheugen van de computer.
15		Ventilatiesleuven en koelventilator	Zorgen dat de computer koel blijft, zelfs na langdurig gebruik. Opmerking: Dek de opening van de ventilator nooit af.
16		Batterijgrendel	Vergrendelt de accu op z'n plaats.

Omgeving

Temperatuur:

In gebruik: 5°C tot 35°C

Niet in gebruik: -20°C tot 65°C

Vochtigheidsgraad (geen condensvorming):

In gebruik: 20% tot 80%

Niet in gebruik: 20% tot 80%

ASPIRE ONE -serien

Hurtigguide

Notebook-PC i *Aspire One*-serien

Modellnummer: _____

Serienummer: _____

Innkjøpsdato: _____

Innkjøpssted: _____

Federal Communications Commission

Declaration of Conformity

This device complies with Part 15 of the FCC Rules. Operation is subject to the following two conditions: (1) this device may not cause harmful interference, and (2) this device must accept any interference received, including interference that may cause undesired operation.

The following local Manufacturer / Importer is responsible for this declaration:

Product name:	Notebook PC
Brand:	Acer
Model number:	MS2296
Machine type:	<i>AO 753 series</i>
Name of Responsible Party:	Acer America Corporation
Address of responsible party:	333 West San Carlos St., San Jose CA 95110, U. S. A.
Contact person:	Acer Representative
Phone No.:	1-254-298-4000
Fax No.:	1-254-298-4147
April 30, 2010	

CE Declaration of Conformity

We,

Acer Incorporated

8F, 88, Sec. 1, Hsin Tai Wu Rd., Hsichih, Taipei Hsien 221, Taiwan

Contact Person: Mr. Easy Lai, e-mail:easy_lai@acer.com.tw



And,

Acer Europe SA

Via Cantonale, Centro Galleria 2 6928 Manno Switzerland

Hereby declare that:

Product: Notebook Computer

Trade Name: Acer

Model Number: MS2296

Machine Type: AO753 series

Is compliant with the essential requirements and other relevant provisions of the following EC directives, and that all the necessary steps have been taken and are in force to assure that production units of the same product will continue comply with the requirements.

EMC Directive 2004/108/EC as attested by conformity with the following harmonized standards:

- EN55022, AS/NZS CISPR22, Class B
- EN55024
- EN61000-3-2 Class D
- EN61000-3-3

Low Voltage Directive 2006/95/EC as attested by conformity with the following harmonized standard:

- EN60950-1

Council Decision 98/482/EC (CTR21):

(Applicable to product with pan- European single terminal connection to the Public Switched Telephone Network (PSTN).)

RoHS Directive 2002/95/EC on the Restriction of the Use of certain Hazardous Substances in Electrical and Electronic Equipment

- The maximum concentration values of the restricted substances by weight in homogenous material are:

Lead	0.1%	Polybrominated Biphenyls (PBB's)	0.1%
Mercury	0.1%	Polybrominated Diphenyl Ethers (PBDE's)	0.1%
Hexavalent Chromium	0.1%	Cadmium	0.01%

Directive 2009/125/EC with regard to establishing a framework for the setting of ecodesign requirements for energy-related product.

R&TTE Directive 1999/5/EC as attested by conformity with the following harmonized standard:

- Article 3.1(a) Health and Safety
 - EN60950-1
 - EN62311
- Article 3.1(b) EMC
 - EN301 489-1
 - EN301 489-3 (Applicable to non-bluetooth wireless keyboard mouse set).
 - EN301 489-7
 - EN301 489-17
 - EN301 489-24
- Article 3.2 Spectrum Usages
 - EN300 440-2 (Applicable to non-bluetooth wireless keyboard mouse set).
 - EN300 328
 - EN301 511
 - EN301 893 (Applicable to 5GHz high performance RLAN).
 - EN301 908-1
 - EN301 908-2

Year to begin affixing CE marking 2010.

Easy Lai

Easy Lai /Manager
Regulation Center, Acer Inc.

Apr. 30, 2010

Date

Før vi begynner

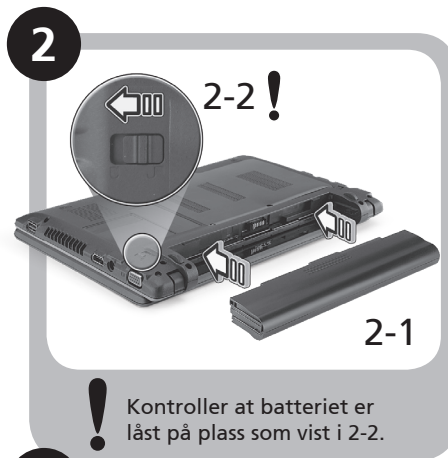
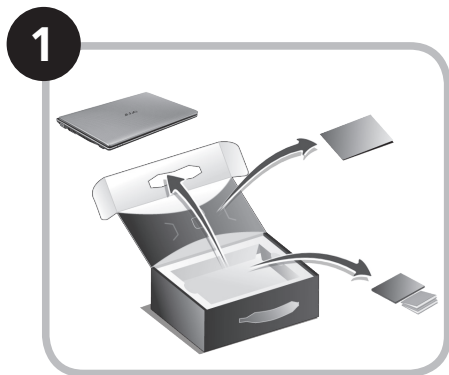

Bildene er kun til illustrasjon. De faktiske produkt spesifikasjonene kan variere.

Begynne med begynnelsen

Vi vil gjerne takke deg for at du har valgt en Acer-notebook til dine mobile databehandlingsbehov.

Dine veiledere

Som hjelp til bruk av Acer-notebooken har vi utarbeidet et sett av guider*:

Den første er hurtigguiden, som hjelper deg i gang med oppsettet av datamaskinen.

Hvis du vil vite mer om hvordan datamaskinen kan hjelpe deg med å bli mer produktiv, vennligst slå opp i AcerSystem User Guide. Denne guiden inneholder detaljert informasjon om emner som systemverktøy, datagjenvinning, utbyggingsalternativer og feilsøking/problemløsning. I tillegg finner du garantiopplysninger, generell informasjon og sikkerhetsmerknader for notisbokmaskinen din. Boken er tilgjengelig som PDF-fil (Portable Document Format) og leveres forhåndslastet på maskinen.



Merk: Visning av filen krever Adobe Reader. Hvis Adobe Reader ikke er installert på datamaskinen, vil klikking på AcerSystem User Guide føre til at installeringsprogrammet for Adobe Reader kjøres først. Følg instruksjonene på skjermen for å fullføre installeringen. Hvis du vil ha instruksjoner i bruk av Adobe Reader, se menyen Hjelp og støtte.



*** VIKTIG MERKNAD:** Vennligst merk at guidene som nevnes her, enten de er i trykt eller elektronisk form, er beregnet på dine referanseformål. Med unntak av det som er nevnt i den bestemte garantiinformasjonen i AcerSystem User Guide, er det ingenting i disse guidene som utgjør en påstand eller en garanti fra Acer om produktet du har kjøpt. Acer fraskriver seg uttrykkelig ethvert ansvar for feil som måtte forekomme i disse guidene og håndbøkene.

Nettverkskonfigurasjon

Denne guiden vil hjelpe deg med å konfigurere innstillinger for LAN og trådløst nettverk slik at du kan koble deg til Internett.

Sette opp en LAN-tilkobling

Plugg inn LAN-kabelen i Ethernet-porten (RJ-45). Se "**Høyre visning**" på side 6 hvis du vil finne Ethernet-portens plassering.

Sette opp en trådløs tilkobling

1. Trykk på <Fn> + <F3> for å få tilgang til kommunikasjonsstyring. Her kan du slå på Wi-Fi-tilkoblingen ved å klikke på den røde knappen ved siden av Wi-Fi.

Merk: 3G og Bluetooth er også tilgjengelige gjennom kommunikasjonsstyring. Kommunikasjonsenheter kan variere avhengig av modell.

2. Klikk på ikonet  i systemskuffen, og velg det trådløse tilgangspunktet du vil koble deg til.

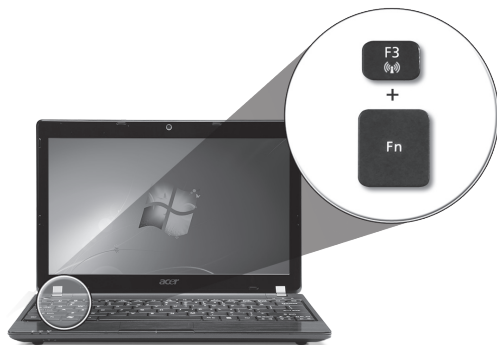

Sette inn et 3G SIM-kort (bare for visse modeller)

Fjern batteriet og sett forsiktig inn et 3G SIM-kort i 3G SIM-kortsporet. Under "**Bakre visning & Bunnvisning**" på side 6 kan du se 3G SIM-kortsporets plassering.

Din Aspire One-omvisning

Etter at du har satt opp datamaskinen som illustrert i avsnittet Før vi begynner, vil vi nå gjerne vise deg den nye Acer-notebooken.

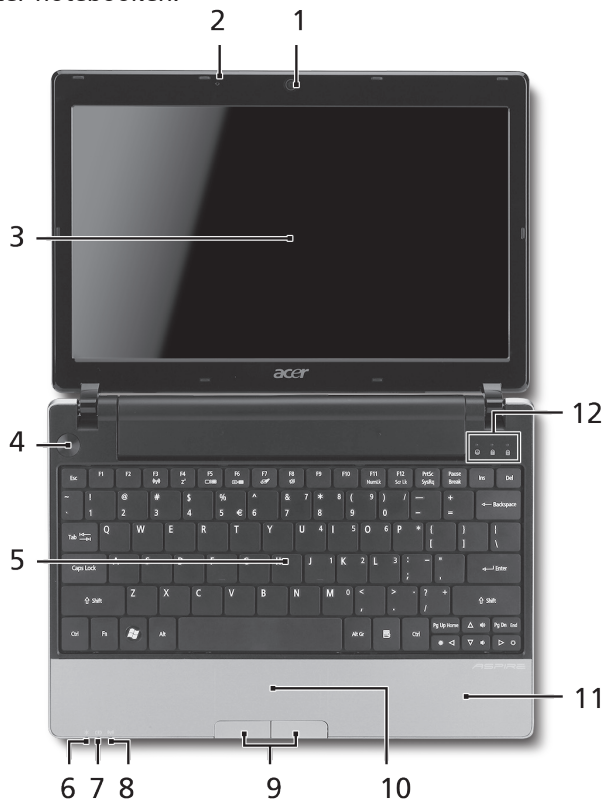

Visning ovenfra



#	Ikonelement	Beskrivelse						
1	Acer Crystal Eye-webkamera	Webkamera til videokommunikasjon (konfigurasjonen kan variere mellom modellene).						
2	Mikrofon	Intern mikrofon for lydinnspilling.						
3	Skjerm	Kalles også LCD-skjerm (Liquid-Crystal Display; LCD), viser utdata fra datamaskinen (konfigurasjonen kan variere mellom modellene).						
4	Av/på-knapp	Slår datamaskinen av og på.						
5	Tastatur	Legger inn data i datamaskinen.						
6	Strømindikator ¹	Angir datamaskinens strømstatus.						
7	Batteriindikator ¹	Angir datamaskinens batteristatus. 1. Lading: Lampen lyser gult når batteriet lades. 2. Helt oppladet: Lampen lyser blått i nettstrømmodus.						
8	Kommunikasjonsindikator ¹	Angir statusen for trådløs LAN/3G-kommunikasjon.						
		<table border="1"> <thead> <tr> <th>Blått lys på</th> <th>Oransjelys på</th> <th>Ikke tent</th> </tr> </thead> <tbody> <tr> <td>3G på/WiFi på</td> <td>3G av/WiFi på</td> <td>3G av/WiFi av</td> </tr> </tbody> </table>	Blått lys på	Oransjelys på	Ikke tent	3G på/WiFi på	3G av/WiFi på	3G av/WiFi av
Blått lys på	Oransjelys på	Ikke tent						
3G på/WiFi på	3G av/WiFi på	3G av/WiFi av						
9	Klikkeknapper (venstre og høyre)	Venstre og høyre knapp fungerer på samme måte som venstre og høyre museknapp.						
10	Pekeplate	Pekeenhet som reagerer på berøring og fungerer som en mus.						
11	Håndleddshviler	Komfortabelt støtteområde for hendene når du bruker datamaskinen.						
12	Harddiskindikator	Lyser når harddisken er aktiv.						
	Num Lock	Lyser når Num Lock er aktivert.						
	Caps Lock	Lyser når Caps Lock er aktivert.						

1. Frontpanelindikatorerne er synlige selv når datamaskindekselet er lukket.

Lukket frontvisning

#	Ikonelement	Beskrivelse
1	Statusindikatorer	Lamper (LED) som tennes for å vise statusen for datamaskinens funksjoner og komponenter.

Venstre visning

2	 Port for ekstern skjerm (VGA)	Kobler til en skjermenhet (f.eks. ekstern skjerm, LCD-projektor).
3	 Strømtilkobling	Kobler til en batterieliminator.
4	HDMI HDMI-port	Støtter høydefinisjons digitale videoforbindelser.
5	Ventilasjonsåpninger	Gir datamaskinen mulighet til å holde seg kjølig, selv etter lang tids bruk.
6	 USB 2.0-port	Kobler til USB 2.0-enheter (f.eks. USB-mus, USB-kamera).

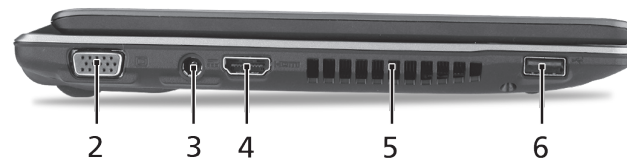

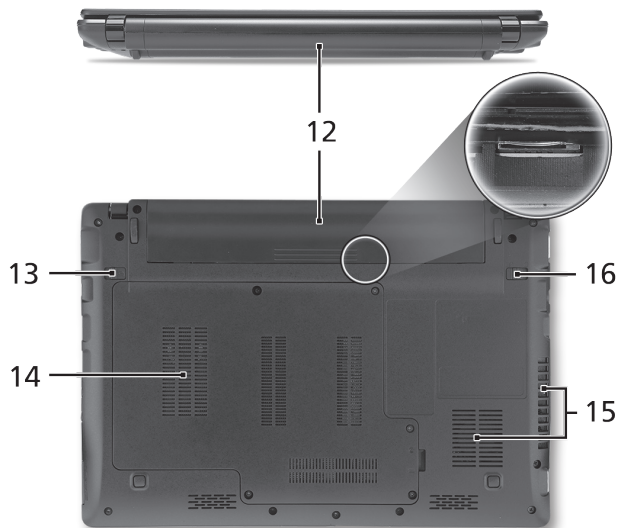
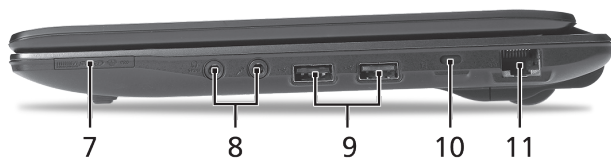

Høyre visning

#	Ikoner	Element	Beskrivelse
7		Multi-i-1-kortleser	Godtar Secure Digital (SD), MultiMediaCard (MMC), Memory Stick (MS), Memory Stick Pro (MS PRO), og xD-Picture Card (xD). Merk: Skyv inn for å fjerne/installere kortet. Bare ett kort kan være i bruk til enhver tid.
8		Mikrofonplugg Hodetelefon/ høyttaler/line-out-port med S/PDIF-støtte	Mottar inndata fra eksterne mikrofoner. Kobler til utdataenheter for lyd (f.eks. høyttalere, hodetelefon).
9		USB 2.0-port	Kobler til USB 2.0-enheter (f.eks. USB-mus).
10		Spor for Kensington-lås	Kobler til en Kensington-kompatibel sikkerhetslås for datamaskinen.
11		Ethernet-port (RJ-45)	Kobler til et Ethernet 10/100/1000-basert nettverk.

Bakre visning & Bunnvisning

12		Batterirom	Huser datamaskinens batterier.
13		Batterifrigivelsesbolt	Frigir batteriet for fjerning.
14		Harddiskplass	Huser datamaskinens harddisk (sikret med skruer).
		Minnerom	Huser datamaskinens hovedminne.
15		Ventilasjonsåpninger og kjølevifte	Gir datamaskinen mulighet til å holde seg kjølig, selv etter lang tids bruk. Merk: Ikke dekk til eller blokker viftens åpning.
16		Batterilås	Låser batteriet på plass.

Miljø

Temperatur:

Drift: 5°C til 35°C

Ikke i bruk: -20°C til 65°C

Luftfuktighet (ikke-kondenserende):

Drift: 20% til 80%

Ikke i bruk: 20% til 80%

ASPIRE ONE *Seriens*

Hurtig-guide

Aspire One seriens notebook-pc

Modelnummer: _____

Serienummer: _____

Købsdato: _____

Købt hos: _____

Federal Communications Commission

Declaration of Conformity

This device complies with Part 15 of the FCC Rules. Operation is subject to the following two conditions: (1) this device may not cause harmful interference, and (2) this device must accept any interference received, including interference that may cause undesired operation.

The following local Manufacturer / Importer is responsible for this declaration:

Product name:	Notebook PC
Brand:	Acer
Model number:	MS2296
Machine type:	<i>AO 753 series</i>
Name of Responsible Party:	Acer America Corporation
Address of responsible party:	333 West San Carlos St., San Jose CA 95110, U. S. A.
Contact person:	Acer Representative
Phone No.:	1-254-298-4000
Fax No.:	1-254-298-4147
April 30, 2010	

CE Declaration of Conformity

We,

Acer Incorporated
8F, 88, Sec. 1, Hsin Tai Wu Rd., Hsichih, Taipei Hsien 221, Taiwan
Contact Person: Mr. Easy Lai, e-mail:easy_lai@acer.com.tw



And,

Acer Europe SA
Via Cantonale, Centro Galleria 2 6928 Manno Switzerland

Hereby declare that:

Product: Notebook Computer
Trade Name: Acer
Model Number: MS2296
Machine Type: AO753 series

Is compliant with the essential requirements and other relevant provisions of the following EC directives, and that all the necessary steps have been taken and are in force to assure that production units of the same product will continue comply with the requirements.

EMC Directive 2004/108/EC as attested by conformity with the following harmonized standards:

- EN55022, AS/NZS CISPR22, Class B
- EN55024
- EN61000-3-2 Class D
- EN61000-3-3

Low Voltage Directive 2006/95/EC as attested by conformity with the following harmonized standard:

- EN60950-1

Council Decision 98/482/EC (CTR21):

(Applicable to product with pan- European single terminal connection to the Public Switched Telephone Network (PSTN).)

RoHS Directive 2002/95/EC on the Restriction of the Use of certain Hazardous Substances in Electrical and Electronic Equipment

- The maximum concentration values of the restricted substances by weight in homogenous material are:

Lead	0.1%	Polybrominated Biphenyls (PBB's)	0.1%
Mercury	0.1%	Polybrominated Diphenyl Ethers (PBDE's)	0.1%
Hexavalent Chromium	0.1%	Cadmium	0.01%

Directive 2009/125/EC with regard to establishing a framework for the setting of ecodesign requirements for energy-related product.

R&TTE Directive 1999/5/EC as attested by conformity with the following harmonized standard:

- Article 3.1(a) Health and Safety
 - EN60950-1
 - EN62311
- Article 3.1(b) EMC
 - EN301 489-1
 - EN301 489-3 (Applicable to non-bluetooth wireless keyboard mouse set).
 - EN301 489-7
 - EN301 489-17
 - EN301 489-24
- Article 3.2 Spectrum Usages
 - EN300 440-2 (Applicable to non-bluetooth wireless keyboard mouse set).
 - EN300 328
 - EN301 511
 - EN301 893 (Applicable to 5GHz high performance RLAN).
 - EN301 908-1
 - EN301 908-2

Year to begin affixing CE marking 2010.

Easy Lai

Easy Lai /Manager
Regulation Center, Acer Inc.

Apr. 30, 2010

Date

Kun for begyndere

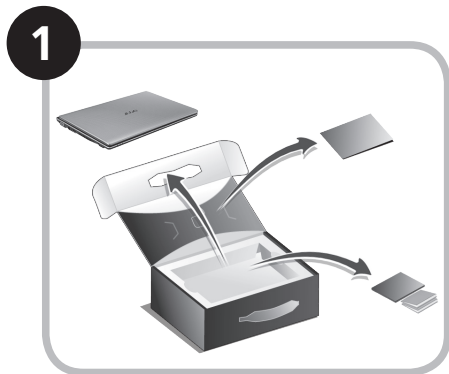

Billederne er kun til illustration. De faktiske produktspecifikationer kan variere.

For det første

Vi vil gerne takke for, at du har valgt en Acer bærbar til at opfylde dine mobile computerbehov.

Dine vejledninger

Vi har designet et sæt vejledninger, som hjælper dig med at bruge din Acer bærbare*:

For det første hjælper hurtigvejledningen dig med at komme i gang med at konfigurere din computer.

Der henvises til AcerSystem-brugervejledningen, hvor du kan få flere oplysninger om, hvordan din computer kan hjælpe dig med at blive mere produktiv. Denne vejledning indeholder detaljerede oplysninger om emner som systemhjælpeprogrammer, datagenoprettelse, udvidelsesvalg og fejlfinding. Derudover indeholder den garantioplysninger og generelle regulativer og sikkerhedsmeddelelser til din bærbare. Den findes i Portable Document Format (PDF) og leveres forudindstalleret på din bærbare.



Bemærk: Visning af filen kræver Adobe Reader. Hvis Adobe Reader ikke er installeret på din computer, vil klik på AcerSystem-brugervejledningen først køre installationsprogrammet til Adobe Reader. Følg instruktionerne på skærmen for at fuldføre installationen. Instruktioner om, hvordan du bruger Adobe Reader, fås i menuen Hjælp og support.



*** VIGTIGT:** Bemærk, at de vejledninger, der nævnes heri, hvad enten de er trykt eller i elektronisk format, kun er til referenceformål, og med undtagelse af det, som er angivet i bestemte garantioplysninger i AcerSystem-brugervejledningen, vil intet i disse vejledninger udgøre en indsigelse eller garanti fra Acer med hensyn til det produkt, du købte. Acer fraskriver sig udtrykkeligt ethvert ansvar for fejl i disse vejledninger.

Netværkskonfiguration

Denne vejledning hjælper dig med at konfigurere dine indstillinger for LAN og trådløst netværk, så du sættes i stand til at oprette forbindelse til internettet.

Opsætning af LAN-forbindelse

Indsæt LAN-kablet i Ethernet'ets (RJ-45)-port. Der henvises til "**Fra højre**" på side 6 for at se placerinen af Ethernet-porten.

Opsætning af en trådløs forbindelse

1. Tryk på <Fn> + <F3> for at få adgang til Kommunikationsadministrator. Her kan du tænde for Wi-Fi-forbindelsen ved at klikke på den røde kan ved siden af Wi-Fi.

Bemærk: Der er også adgang til 3G og Bluetooth via kommunikationsadministratoren. Kommunikationsenheder kan variere efter model.

2. Klik på ikonet  i din systembakke, og vælg det trådløse adgangspunkt, som du vil oprette forbindelse til.

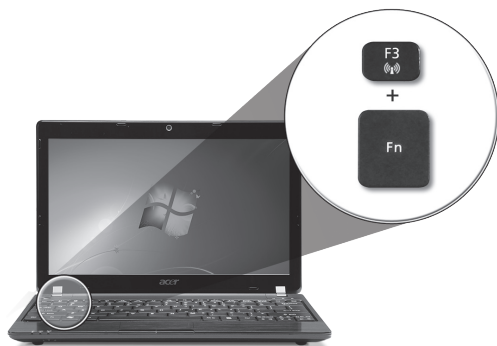

Indsættelse af et 3G-SIM-kort (kun på visse modeller)

Fjern batteriet, og indsæt et 3G-SIM-kort forsigtigt i 3G-SIM-kortstikket. Der henvises til "**Bagfra & Nedefra**" på side 6, hvor du kan se, hvor 3G-SIM-kortstikket sidder.

Din Aspire One-tur

Når du har konfigureret din computer som vist i afsnittet Kun for begyndere, vil vi vise dig rundt på din nye Acer Notebook.

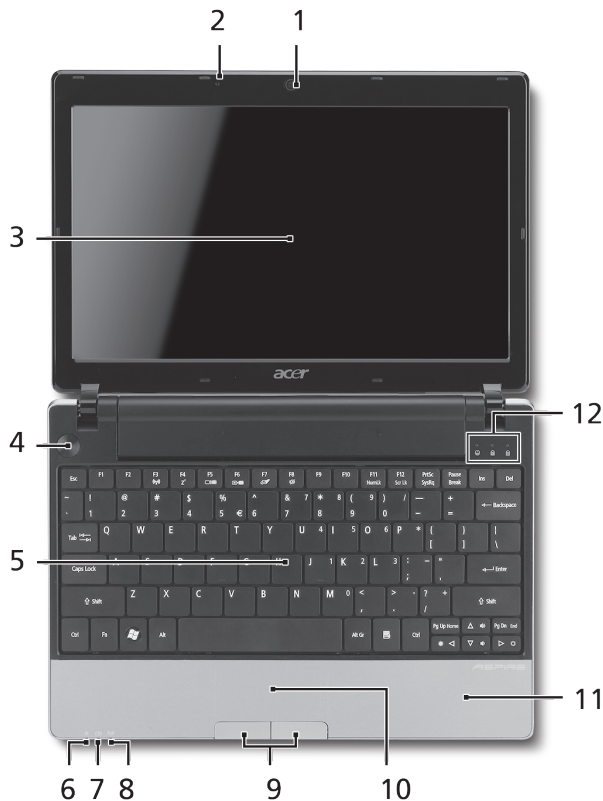

Fra oven



#	Ikone	Emne	Beskrivelse						
1		Acer Crystal Eye webcam	Webkamera til videokommunikation (konfiguration kan variere fra model til model).						
2		Mikrofon	Intern mikrofon til optagelse af lyd.						
3		Skærm	Det kaldes også for et LCD (Liquid-Crystal Display - flydende krystaldisplay), og det viser computerens output (konfiguration kan variere fra model til model).						
4		Afbryderknop	Tænder/slukker for computeren.						
5		Tastatur	Til indtastning af data på computeren.						
6		Strømindikator ¹	Angiver computerens strømstatus.						
7		Batteriindikator ¹	Angiver computerens batteristatus. 1. Oplader: Lampen lyser gult, når batteriet oplader. 2. Fuldt opladet: Lampen lyser blå i AC-tilstand.						
8		Kommunikationsindikator ¹	Angiver status for den trådløse LAN/3G-kommunikation.						
			<table border="1"> <thead> <tr> <th>Blåt lys tændt</th> <th>Orange lys tændt</th> <th>Ikke tændt</th> </tr> </thead> <tbody> <tr> <td>3G aktiveret/ WiFi aktiveret</td> <td>3G deaktiveret/WiFi aktiveret</td> <td>3G deaktiveret/ WiFi deaktiveret</td> </tr> </tbody> </table>	Blåt lys tændt	Orange lys tændt	Ikke tændt	3G aktiveret/ WiFi aktiveret	3G deaktiveret/WiFi aktiveret	3G deaktiveret/ WiFi deaktiveret
Blåt lys tændt	Orange lys tændt	Ikke tændt							
3G aktiveret/ WiFi aktiveret	3G deaktiveret/WiFi aktiveret	3G deaktiveret/ WiFi deaktiveret							
9		Klik-knapper (til venstre og til højre)	Knapperne til højre og venstre fungerer på samme måde som musens højre og venstre knapper.						
10		Touchpad (pegefelt)	Et berøringsfølsomt pegeredskab, der fungerer ligesom en computermus.						
11		Håndfladestøtte	Et komfortabelt støtteområde for dine hænder, når du bruger computeren.						
12		Harddiskindikator	Lyser, når harddisken er aktiv.						
		Num lock	Lyser, når Num Lock er aktiveret.						
		Caps Lock	Lyser, når Caps Lock er aktiveret.						

1. Frontpanelets indikatorer er synlige, selvom computerens låg er lukket.

Forfra - Lukket

#	Ikon	Emne	Beskrivelse
1		Statusindikatorer	LED'er (Light-Emitting Diodes), der lyser for at vise status for computerens funktioner og komponenter.

Fra venstre

2		Stik til ekstern skærm (VGA)	Tilslutter til en skærmenhed (f.eks. ekstern skræm, LCD-projektor).
3		Jævnstrøm ind-stik	Tilslutter til en AC-adapter.
4	HDMI	HDMI-port	Understøtter high-definition digitale netværksforbindelser.
5		Ventilationsåbninger	Lader computeren være kølig selv efter lang tids brug.
6		USB 2.0-port	Tilslutter til USB 2.0-enheder (f.eks. USB-mus, USB-kamera).

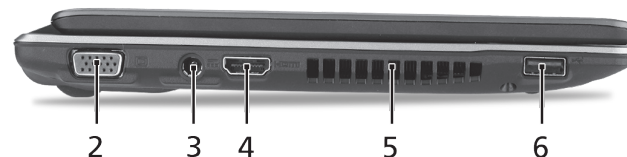

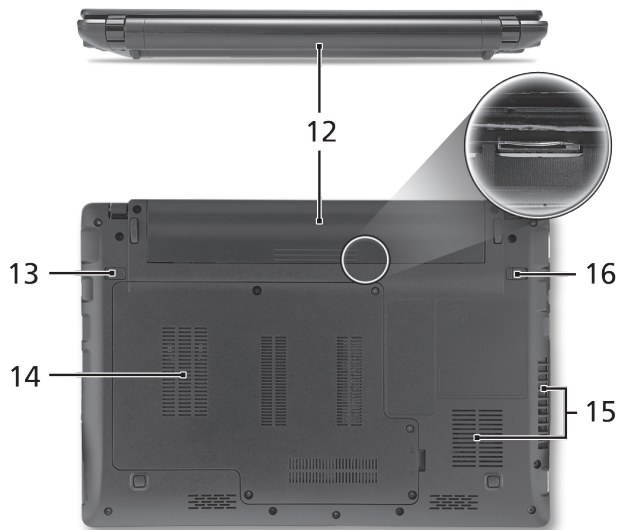
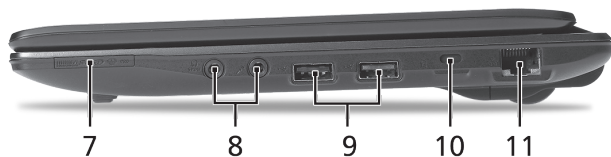

Fra højre

#	Ikon	Emne	Beskrivelse
7		Flere-i-en-kortlæser	Accepterer Secure Digital (SD), MultiMediaCard (MMC), Memory Stick (MS), Memory Stick PRO (MS PRO), xD-Picture Card (xD). Bemærk: Skub for at fjerne/installere kortet. Der kan kun være et kort aktivt ad gangen.
8		Mikrofonstik	Accepterer input fra eksterne mikrofoner.
		Hovedtelefon/højtaler/udgangsstik med S/PDIF understøttelse	Der kan tilsluttes ekstraudstyr (f. eks. højtalere, hovedtelefoner).
9		USB 2.0-port	Tilslutter til USB 2.0-enheder (f.eks. USB-mus).
10		Åbning til en Kensington-lås	Tilslutter til en Kensington-kompatibel computers sikkerhedslås.
11		Netværksport (RJ-45)	Tilslutter til et Ethernet 10/100/1000-baseret netværk.

Bagfra & Nedefra

12		Batterirum	Indeholder computerens batteri.
13		Frigørelsesarm til batteri	Frigør batteriet til udtagning.
14		Harddiskbås	Indeholder computerens harddisk (fastsat med skruer).
		Hukommelsesrum	Her sidder computerens centrale hukommelse.
15		Ventilationshuller og køleblæser	Lader computeren være kølig selv efter lang tids brug. Bemærk: Du må aldrig tildække eller spærre åbningen til køleren.
16		Batterilås	Låser batteriet på plads.

Omgivelser

Temperatur:

Under brug: 5°C til 35°C

Ikke i brug: -20°C til 65°C

Fugtighed (ikke-kondenserende):

Under brug: 20% til 80%

Ikke i brug: 20% til 80%

ASPIRE ONE-serien

Snabbguide

Aspire One-serien – bärbar PC-dator

Modellnummer: _____

Serienummer: _____

Inköpsdatum: _____

Inköpsställe: _____

Federal Communications Commission

Declaration of Conformity

This device complies with Part 15 of the FCC Rules. Operation is subject to the following two conditions: (1) this device may not cause harmful interference, and (2) this device must accept any interference received, including interference that may cause undesired operation.

The following local Manufacturer / Importer is responsible for this declaration:

Product name:	Notebook PC
Brand:	Acer
Model number:	MS2296
Machine type:	<i>AO 753 series</i>
Name of Responsible Party:	Acer America Corporation
Address of responsible party:	333 West San Carlos St., San Jose CA 95110, U. S. A.
Contact person:	Acer Representative
Phone No.:	1-254-298-4000
Fax No.:	1-254-298-4147
April 30, 2010	

CE Declaration of Conformity

We,

Acer Incorporated

8F, 88, Sec. 1, Hsin Tai Wu Rd., Hsichih, Taipei Hsien 221, Taiwan

Contact Person: Mr. Easy Lai, e-mail:easy_lai@acer.com.tw

And,

Acer Europe SA

Via Cantonale, Centro Galleria 2 6928 Manno Switzerland

Hereby declare that:

Product: Notebook Computer

Trade Name: Acer

Model Number: MS2296

Machine Type: AO753 series

Is compliant with the essential requirements and other relevant provisions of the following EC directives, and that all the necessary steps have been taken and are in force to assure that production units of the same product will continue comply with the requirements.

EMC Directive 2004/108/EC as attested by conformity with the following harmonized standards:

- EN55022, AS/NZS CISPR22, Class B
- EN55024
- EN61000-3-2 Class D
- EN61000-3-3

Low Voltage Directive 2006/95/EC as attested by conformity with the following harmonized standard:

- EN60950-1

Council Decision 98/482/EC (CTR21):

(Applicable to product with pan- European single terminal connection to the Public Switched Telephone Network (PSTN).)

RoHS Directive 2002/95/EC on the Restriction of the Use of certain Hazardous Substances in Electrical and Electronic Equipment



- The maximum concentration values of the restricted substances by weight in homogenous material are:

Lead	0.1%	Polybrominated Biphenyls (PBB's)	0.1%
Mercury	0.1%	Polybrominated Diphenyl Ethers (PBDE's)	0.1%
Hexavalent Chromium	0.1%	Cadmium	0.01%

Directive 2009/125/EC with regard to establishing a framework for the setting of ecodesign requirements for energy-related product.

R&TTE Directive 1999/5/EC as attested by conformity with the following harmonized standard:

- Article 3.1(a) Health and Safety
 - EN60950-1
 - EN62311
- Article 3.1(b) EMC
 - EN301 489-1
 - EN301 489-3 (Applicable to non-bluetooth wireless keyboard mouse set).
 - EN301 489-7
 - EN301 489-17
 - EN301 489-24
- Article 3.2 Spectrum Usages
 - EN300 440-2 (Applicable to non-bluetooth wireless keyboard mouse set).
 - EN300 328
 - EN301 511
 - EN301 893 (Applicable to 5GHz high performance RLAN).
 - EN301 908-1
 - EN301 908-2

Year to begin affixing CE marking 2010.

Easy Lai

Easy Lai /Manager
Regulation Center, Acer Inc.

Apr. 30, 2010

Date

Komma igång

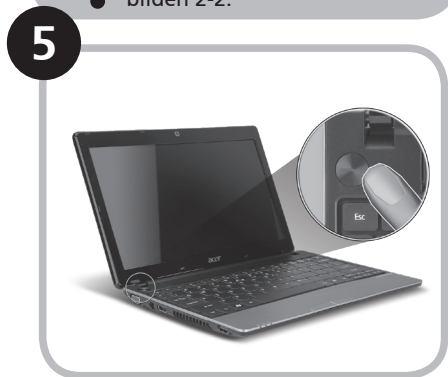
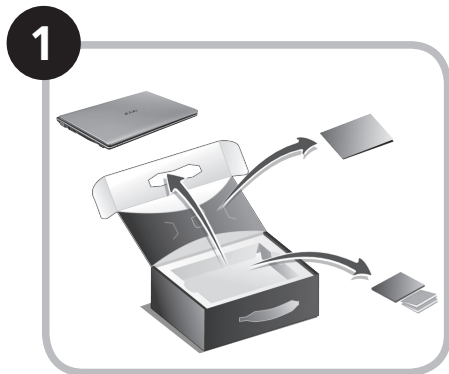

Illustrationerna är endast avsedda för referensändamål. De faktiska produktspecifikationerna kan variera.

Först och främst

Vi vill tacka för att du valde en bärbar Acer-dator för att uppfylla dina behov av mobil databehandling.

Dina guider

Vi har framställt en rad guider som hjälper dig att använda den bärbara Acer-datorn*:

Snabbguiden hjälper dig att komma igång med installation av datorn.

Om du vill veta mer om hur datorn kan hjälpa dig att bli mer produktiv studerar du AcerSystem User Guide. I den här guiden finns detaljerad information om ämnen som systemfunktioner, återställning av data, utbyggnadsalternativ och felsökning. Dessutom innehåller den garantiinformation samt allmänna föreskrifter och säkerhetsmeddelanden angående den bärbara datorn. Den finns i Portable Document Format (PDF) och har förladdats i den bärbara datorn.



Obs! Adobe Reader krävs för visning av filen. Om du inte har Adobe Reader i datorn klickar du på AcerSystem User Guide för att köra installationsprogrammet för Adobe Reader. Följ anvisningarna på skärmen för att genomföra installationen. Instruktioner om användning av Adobe Reader finns under menyn Hjälp och support.



*** VIKTIGT MEDDELANDE:** Observera att guiderna som nämns häri, oavsett om de är i tryckt eller elektroniskt format, endast är avsedda för referensändamål och förutom vad som anges i den särskilda garantiinformationen i AcerSystem User Guide ska inget i de här guiderna utgöra en uppgift eller garanti från Acer avseende den produkt du har köpt. Acer friskriver sig uttryckligen ansvaret för fel i de här guiderna.

Nätverkskonfiguration

Den här guiden hjälper dig att konfigurera inställningar för LAN och trådlöst nätverk så att du kan ansluta till Internet.

Upprätta LAN-anslutning

Anslut bara LAN-kabeln till Ethernet-porten (RJ-45). I "Vy från höger" på sidan 6 finns uppgifter om Ethernet-portens placering.

Upprätta en trådlös anslutning

1. Tryck på <Fn> + <F3> för att komma åt kommunikationshanteraren. Här kan du slå på Wi-Fi-anslutningen genom att klicka på den röda knappen bredvid Wi-Fi.

Obs! 3G och Bluetooth är också tillgängliga via kommunikationshanteraren. Kommunikationsenheterna kan variera mellan olika modeller.

2. Klicka på ikonen  i systemfältet och välj den trådlösa åtkomstpunkt som du vill ansluta till.



Sätta i ett 3G-SIM-kort (bara för vissa modeller)

Ta bort batteriet och för försiktigt in ett 3G-SIM-kort på kortplatsen för 3G-SIM-kort. 3G-SIM-kortplatsens placering visas i "Vy över baksidan & Vy över basen" på sidan 6.

Visning av Aspire One

När du har ställt in datorn enligt beskrivning i avsnittet Komma igång vill vi gärna visa dig din nya bärbara dator från Acer.

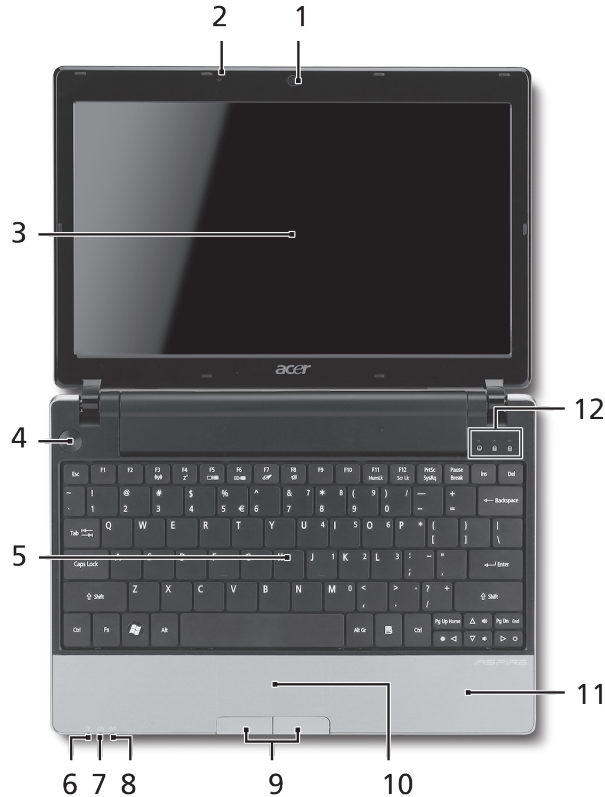

Vy över ovansidan



#	Ikön	Objekt	Beskrivning						
1		Acer Crystal Eye webbkamera	Webbkamera för videokommunikation (konfigurationen kan variera med olika modeller).						
2		Mikrofon	Inbyggd mikrofon för ljudinspelning.						
3		Bildskärm	Kallas även Liquid-Crystal Display (LCD), visar utdata från datorn (konfigurationen kan variera med olika modeller).						
4		Av/på-knapp	Slår på och stänger av datorn.						
5		Tangentbord	För inmatning av data i datorn.						
6		På-indikator ¹	Anger om datorn är av eller på.						
7		Batteriindikator ¹	Anger status för datorns batteri. 1. Laddar: Lyser orange när batteriet laddas. 2. Fulladdad: Lyser blått då datorn är ansluten till nätström.						
8		Kommunikationsindikator ¹	Visar status för trådlös LAN-/3G-kommunikation.						
			<table border="1"> <thead> <tr> <th>Lyser blått</th> <th>Lyser orange</th> <th>Inte tänd</th> </tr> </thead> <tbody> <tr> <td>3G på/WiFi på</td> <td>3G av/WiFi på</td> <td>3G av/WiFi av</td> </tr> </tbody> </table>	Lyser blått	Lyser orange	Inte tänd	3G på/WiFi på	3G av/WiFi på	3G av/WiFi av
Lyser blått	Lyser orange	Inte tänd							
3G på/WiFi på	3G av/WiFi på	3G av/WiFi av							
9		Klickknappar (vänster och höger)	Vänster och höger knapp fungerar som vänster och höger musknapp.						
10		Pekplatta	Beröringskänslig pekenhet som fungerar som en dattormus.						
11		Handlovsstöd	Handlovsstödet ger bekvämt stöd för händerna när du använder datorn.						
12		Hårddiskindikator	Tänds när hårddisken arbetar.						
		Num Lock	Lyser när det Num Lock aktiveras.						
		Caps Lock	Lyser när skiftlåset (Caps Lock) aktiveras.						

1. Indikatorerna på frontpanelen syns även när datorhöljet är stängt.

Vy över stängd framsida

#	Ikön	Objekt	Beskrivning
1		Statusindikatorer	Lysdioder (LED) som tänds för att visa statusen för datorns funktioner och komponenter.

Vy från vänster

2		Port för extern bildskärm (VGA)	Anslutning till en visningsenhet (t.ex. extern bildskärm, LCD-projektor).
3		DC in-anlutning	Ansluts till en växelströmsadapter.
4	HDMI	HDMI-port	Har stöd för digitala videoanslutningar av högdefinitionstyp.
5		Ventilationsöppningar	Möjliggör att datorn håller sig sval, även efter långvarig användning.
6		USB 2.0-port	Ansluts till USB 2.0-enheter (t.ex. USB-mus, USB-kamera).

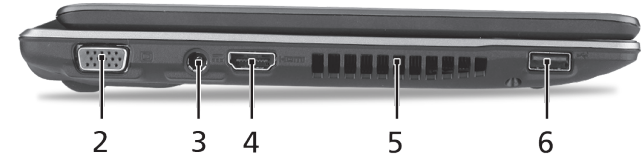

Vy från höger

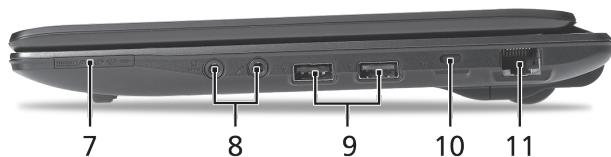

#	Ikon	Objekt	Beskrivning
7		Flera-i-1-kortläsare	Avsedd för Secure Digital (SD), MultiMediaCard (MMC), Memory Stick (MS), Memory Stick PRO (MS PRO), xD-Picture Card (xD). Obs! Tryck för att ta bort/sätta i kortet. Det går bara att använda ett kort i taget.
8		Ingång för mikrofon	Anslutning för externa mikrofoner.
		Utgång för hörlurar/högtalar/linje ut med S/PDIF-stöd	Anslutning för externa ljudenheter (t.ex. högtalare, hörlurar).
9		USB 2.0-port	Ansluts till USB 2.0-enheter (t.ex. USB-mus).
10		Skåra för Kensingtonlås	Ansluts till ett Kensington-kompatibelt datorskyddslås.
11		Ethernet-port (RJ-45)	Ansluts till ett Ethernet 10/100/1000-baserat nätverk.

Vy över baksidan & Vy över basen

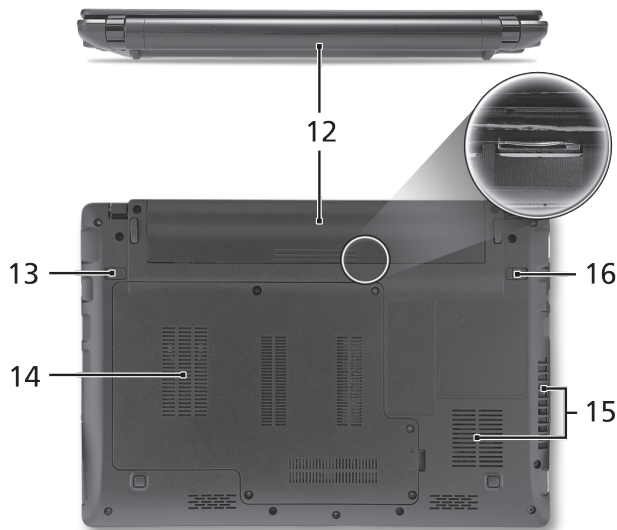

12		Batterifack	Avsett för datorns batteripack.
13		Hake för frigöring av batteriet	Frigör batteriet före borttagning.
14		Hårddiskfack	Utrymme för datorns hårddisk (fastskruvad).
		Minnesfack	Här finns datorns huvudminne.
15		Ventilationsöppningar och kylfläkt	Möjliggör att datorn håller sig sval, även efter långvarig användning. Obs! Täck inte över eller ställ något för fläktöppningen.
16		Batterilås	Låser batteriet på plats.

Miljö

Temperatur:

Vid drift: 5°C till 35°C

Utom drift: -20°C till 65°C

Luftfuktighet (icke-kondenserande):

Vid drift: 20% till 80%

Utom drift: 20% till 80%

ASPIRE ONE -sarja

Pikaohje

ASPIRE ONE -sarja

© 2010 Kaikki oikeudet pidätetään

Aspire One-sarjan Pikaohje
Alkuperäinen painos: 04/2010

Aspire One –sarjan Kannettava tietokone

Mallinumero: _____

Sarjanumero: _____

Ostopäivämäärä: _____

Ostopaikka: _____

Federal Communications Commission

Declaration of Conformity

This device complies with Part 15 of the FCC Rules. Operation is subject to the following two conditions: (1) this device may not cause harmful interference, and (2) this device must accept any interference received, including interference that may cause undesired operation.

The following local Manufacturer / Importer is responsible for this declaration:

Product name:	Notebook PC
Brand:	Acer
Model number:	MS2296
Machine type:	<i>AO 753 series</i>
Name of Responsible Party:	Acer America Corporation
Address of responsible party:	333 West San Carlos St., San Jose CA 95110, U. S. A.
Contact person:	Acer Representative
Phone No.:	1-254-298-4000
Fax No.:	1-254-298-4147
April 30, 2010	

CE Declaration of Conformity

We,

Acer Incorporated

8F, 88, Sec. 1, Hsin Tai Wu Rd., Hsichih, Taipei Hsien 221, Taiwan

Contact Person: Mr. Easy Lai, e-mail:easy_lai@acer.com.tw

And,

Acer Europe SA

Via Cantonale, Centro Galleria 2 6928 Manno Switzerland

Hereby declare that:

Product: Notebook Computer

Trade Name: Acer

Model Number: MS2296

Machine Type: AO753 series

Is compliant with the essential requirements and other relevant provisions of the following EC directives, and that all the necessary steps have been taken and are in force to assure that production units of the same product will continue comply with the requirements.

EMC Directive 2004/108/EC as attested by conformity with the following harmonized standards:

- EN55022, AS/NZS CISPR22, Class B
- EN55024
- EN61000-3-2 Class D
- EN61000-3-3

Low Voltage Directive 2006/95/EC as attested by conformity with the following harmonized standard:

- EN60950-1

Council Decision 98/482/EC (CTR21):

(Applicable to product with pan- European single terminal connection to the Public Switched Telephone Network (PSTN).)

RoHS Directive 2002/95/EC on the Restriction of the Use of certain Hazardous Substances in Electrical and Electronic Equipment



- The maximum concentration values of the restricted substances by weight in homogenous material are:

Lead	0.1%	Polybrominated Biphenyls (PBB's)	0.1%
Mercury	0.1%	Polybrominated Diphenyl Ethers (PBDE's)	0.1%
Hexavalent Chromium	0.1%	Cadmium	0.01%

Directive 2009/125/EC with regard to establishing a framework for the setting of ecodesign requirements for energy-related product.

R&TTE Directive 1999/5/EC as attested by conformity with the following harmonized standard:

- Article 3.1(a) Health and Safety
 - EN60950-1
 - EN62311
- Article 3.1(b) EMC
 - EN301 489-1
 - EN301 489-3 (Applicable to non-bluetooth wireless keyboard mouse set).
 - EN301 489-7
 - EN301 489-17
 - EN301 489-24
- Article 3.2 Spectrum Usages
 - EN300 440-2 (Applicable to non-bluetooth wireless keyboard mouse set).
 - EN300 328
 - EN301 511
 - EN301 893 (Applicable to 5GHz high performance RLAN).
 - EN301 908-1
 - EN301 908-2

Year to begin affixing CE marking 2010.

Easy Lai

Easy Lai /Manager
Regulation Center, Acer Inc.

Apr. 30, 2010

Date

Aloittelijoille

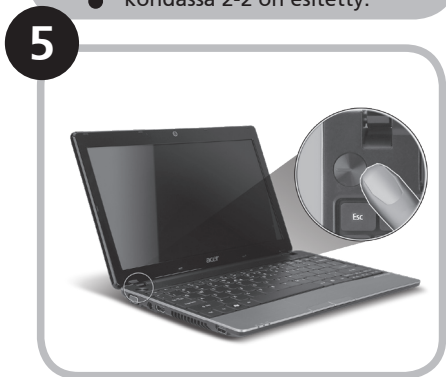
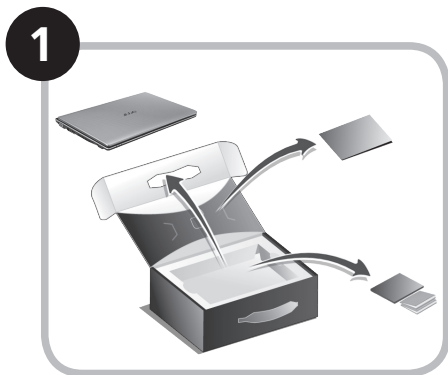

Kuvat ovat viitteellisiä. Varsinainen tuote saattaa poiketa lehtisen kuvista.

Aloitetaan perusasioista

Haluamme kiittää sinua Acerin kannettavan tietokoneen valitsemisesta liikkuvien tietokonetarpeittesi täyttämässä.

Ohjeet

Helpottaaksesi sinua Acer-tietokoneen käyttämisessä olemme suunnitelleet sarjan ohjekirjoja*:

Ihan aluksi Pikaohje auttaa sinua tietokoneen käyttöönotossa.

Lisätietoja siitä, miten tietokoneesi auttaa sinua lisäämään tuottavuutta, on annettu ohjeessa AcerSystem Käyttäjän opas. Tässä oppaassa on yksityiskohtaiset ohjeet järjestelmätoiminnoista, tietojen palauttamisesta, tietokoneen laajentamisesta ja ongelmanratkaisusta. Siinä on myös annettu yleisiä ohjeita, tietoja takuusta sekä turvallisuusohjeita. Se on saatavana Portable Document Format (PDF) –muodossa, ja ja tulee esiasennettuna tietokoneellesi.



Ohje: Jotta voit katsella käyttöohjekirjan tiedostoa, Adobe Readerin on oltava asennettu. Jos Adobe Reader ei ole asennettu tietokoneeseesi, sen asennus käynnistyy ennen AcerSystem User Guide avaamista. Noudata näytölle tulevia ohjeita, kunnes asennus on valmis. Saat lisätietoja Adobe Readerin asennuksesta ja käytöstä valikosta Ohje ja Tuki.



* **TÄRKEÄ HUOMAUTUS:** Huomaa, että tässä mainitut, joko painetussa tai sähköisessä muodossa olevat oppaat, ovat vain tulevaa käyttöä varten, ja AcerSystem Käyttäjän oppaaseen sisältyvää erityistä takuutiedotetta ja niitä lukuunottamatta, jotka eivät sisälly näihin oppaisiin, vastaavat Acerin ostamallesi tuotteelle antamaa kuvausta ja takuuta. Acer sanoutuu selvästi irti kaikesta vastuusta, joka koskee oppaisiin sisältyviä virheitä.

Verkkokonfigurointi

Tämä opas auttaa konfiguroimaan LANin ja langattomat verkoasetukset, jotta pääset Internet-yhteyteen.

LAN-yhteyden määrittäminen

Kytke LAN-kaapeli Ethernet (RJ-45) -porttiin. Katso Ethernet-portin sijaintia koskien "Oikea näkymä" sivulta 6.

Langattoman yhteyden määrittäminen

1. Paina <Fn> + <F3> päästäksesi tietoliikenteen hallintaan. Tässä voit käynnistää Wi-Fi-yhteyden napsauttamalla punaista painiketta Wi-Fi:n vieressä.

Huomautus: 3G ja Bluetooth ovat saavutettavissa myös tietoliikenteen hallinnalla. Tietoliikennelaitteet voivat vaihdella mallista riippuen.

2. Napsauta järjestelmätarjottimen  -kuvaketta ja valitse langaton liitäntäpiste, johon haluat yhteyden.



Laita 3G SIM -kortti sisään (vain valituille malleille)

Poista paristo ja laita 3G SIM -kortti varovasti sisään 3G SIM -kortin aukkoon. Katso "Taustanäkymä & Pohjanäkymä" sivulta 6 3G SIM -kortin aukon sijaintipaikan osalta.

Aspire One -laitteen esittely

Kun olet määrittänyt tietokoneen, kuten Aloittelijoille -osiossa on kuvattu, anna meidän esitellä uusi kannettava Acer-tietokoneesi.

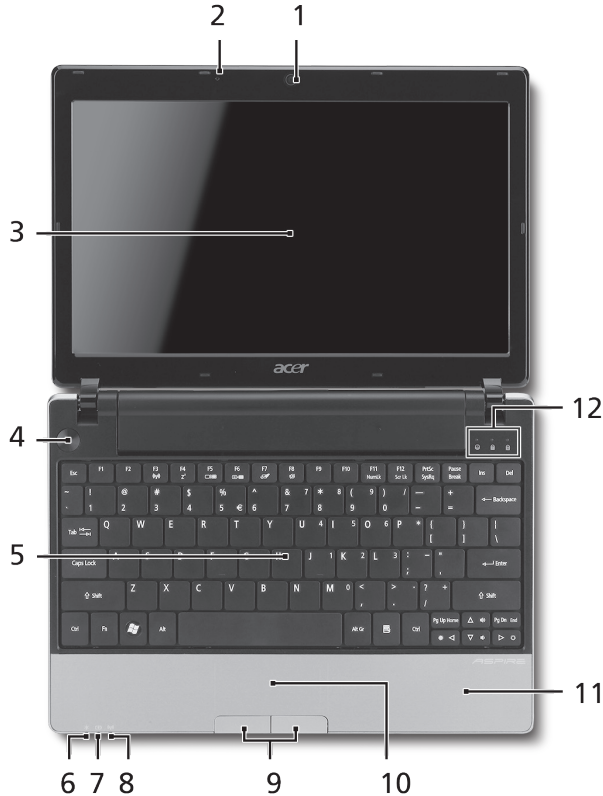

Näkymä ylhäältä



#	Kuvake	Osio	Kuvaus						
1		Acer Crystal Eye -webkamera	Webkamera videotietoliikenteeseen (konfiguraatio voi vaihdella malleista riippuen).						
2		Mikrofoni	Sisäinen mikrofoni äänen tallentamista varten.						
3		Näyttöruutu	Nimeltään myös nestekidenäyttö (Liquid-Crystal Display ; LCD), näyttää tietokoneen ulostulon (konfiguraatio voi vaihdella malleista riippuen).						
4		Virtapainike	Käynnistää ja sulkee koneen.						
5		Näppäimistö	Tiedon syöttämiseen tietokoneelle.						
6		Virranilmais ¹	Osoittaa tietokoneen virran tilan.						
7		Akkutilan ilmais ¹	Osoittaa tietokoneen akun tilan. 1. Lataus meneillään: Valo palaa oranssina, kun akku latautuu. 2. Täyteen ladattu: Valo palaa sinisenä, kun tietokone toimii verkkovirralla.						
8		Tietoliikenteen ilmais ¹	Osoittaa langattoman LAN/3G-tietoliikenteen. <table border="1" data-bbox="1066 636 1541 714"> <tr> <td>Sininen valo päällä</td> <td>Oranssi valo päällä</td> <td>Ei syttynyt</td> </tr> <tr> <td>3G päällä/WiFi päällä</td> <td>3G pois/WiFi päällä</td> <td>3G pois/WiFi pois</td> </tr> </table>	Sininen valo päällä	Oranssi valo päällä	Ei syttynyt	3G päällä/WiFi päällä	3G pois/WiFi päällä	3G pois/WiFi pois
Sininen valo päällä	Oranssi valo päällä	Ei syttynyt							
3G päällä/WiFi päällä	3G pois/WiFi päällä	3G pois/WiFi pois							
9		Napsauta painikkeita (vasen ja oikea)	Vasen ja oikea painike toimivat kuten hiiren vasen ja oikea painike.						
10		Kosketusalusta	Kosketusherkkä osoitinlaite, joka toimii kuten tietokoneen hiiri.						
11		Rannetuki	Mukava tuki käsillesi konetta käyttäessäsi.						
12		HDD-ilmais	Palaa, kun kiintolevy on aktiivinen.						
		Num Lock	Syttyy, kun Num Lock on aktivoituneena.						
		Caps Lock	Syttyy, kun Caps Lock on aktivoituneena.						

1. Etupaneelin tilailmaisimet näkyvät, vaikka tietokoneen kansi olisi suljettu.

Etunäkymä suljettuna

#	Kuvake	Osio	Kuvaus
1		Tilanosoitteet	Loistediodit (LEDs), jotka ilmoittavat tietokoneen toimintojen ja osien tilan.

Vasen näkymä

2		Ulkoinen näyttöportti (VGA)	Yhdistä näyttölaitteeseen (esim. ulkoinen monitori, LCD-projektori).
3		DC-tulolinja	Yhdistää AC-sovittimeen.
4	HDMI	HDMI-portti	Tukee korkealaatuisia digitaalisia videoliitäntöjä.
5		Tuuletuspaikat	Mahdollistaa tietokoneen pysymisen viileänä jopa pitkitetyn käytön jälkeen.
6		USB 2.0 -portti	Yhdistää USB 2.0 -laitteisiin (esim. USB-hiiri, USB-kamera).

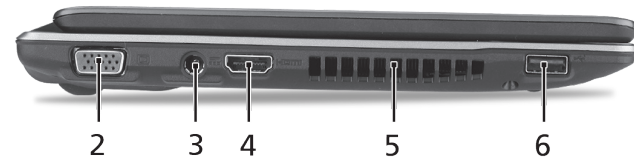

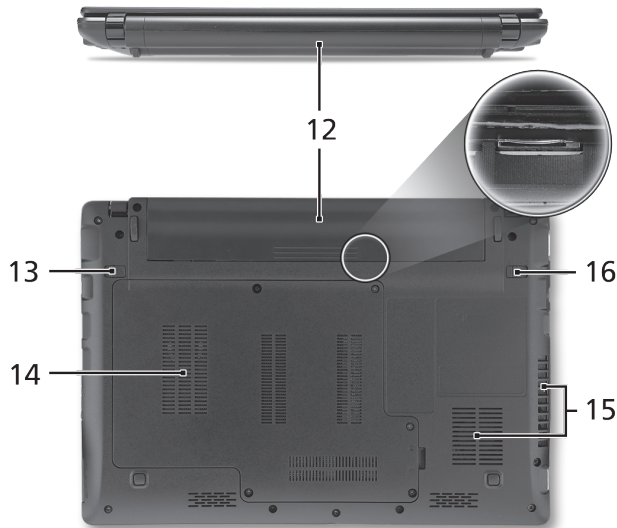
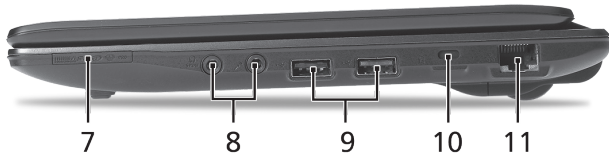

Oikea näkymä

#	Kuvake	Osio	Kuvaus
7		Monta yhdessä -kortinlukija	Hyväksyy seuraavat muistikortit: Secure Digital (SD), MultiMediaCard (MMC), Memory Stick (MS), Memory Stick PRO (MS PRO) ja xD-Picture Card (xD). Ohje: Poista/Asenna kortti työntämällä. Vain yksi kortti voi toimia kerrallaan.
8		Mikrofonin tulolinja	Hyväksyy syötteet ulkoisilta mikrofoneilta.
		Kuuloke/kaiutin/line-out -jakkiliitin S/PDIF-tuella	Yhdistää audioliitännälaitteisiin (esim. kaiuttimet, kuulokkeet).
9		USB 2.0 -portti	Yhdistää USB 2.0 -laitteisiin (esim. USB-hiiri).
10		Kensington-lukon paikka	Yhdistää Kensington-yhteensopivaan tietokoneen turvalukkoon.
11		Ethernet (RJ-45)-portti	Yhdistää Ethernet 10/100/1000-pohjaiseen verkkoon.

Taustanäkymä & Pohjanäkymä

12		Akkutila	Sisältää tietokoneen akkuyksikön.
13		Akun vapautussalpa	Vapauttaa akun poistamista varten.
14		Kovalevytila	Sisältää koneen kovalevyn (varmistettu ruuveilla).
		Muistilokero	Sisältää tietokoneen päämuisti.
15		Tuuletusaukot ja jäähdytystuuletin	Mahdollistaa tietokoneen pysymisen viileänä jopa pitkitetyn käytön jälkeen. Ohje: Älä peitä tai tuki tuulettimen aukkoa.
16		Akun lukko	Lukitsee akun paikoilleen.

Ympäristö

Lämpötila:

Käyttö: 5°C:sta 35°C:een

Ei käytössä: -20°C:sta 65°C:een

Kosteus (ei kondensoitunut):

Käyttö: 20%:sta 80%:een

Ei käytössä: 20%:sta 80%:een

Серия **ASPIRE** ONE

Краткое руководство

Портативный компьютер серии *Aspire One*

Номер модели: _____

Серийный номер: _____

Дата покупки: _____

Место покупки: _____

Federal Communications Commission

Declaration of Conformity

This device complies with Part 15 of the FCC Rules. Operation is subject to the following two conditions: (1) this device may not cause harmful interference, and (2) this device must accept any interference received, including interference that may cause undesired operation.

The following local Manufacturer / Importer is responsible for this declaration:

Product name:	Notebook PC
Brand:	Acer
Model number:	MS2296
Machine type:	<i>AO 753 series</i>
Name of Responsible Party:	Acer America Corporation
Address of responsible party:	333 West San Carlos St., San Jose CA 95110, U. S. A.
Contact person:	Acer Representative
Phone No.:	1-254-298-4000
Fax No.:	1-254-298-4147
April 30, 2010	

CE Declaration of Conformity

We,

Acer Incorporated
8F, 88, Sec. 1, Hsin Tai Wu Rd., Hsichih, Taipei Hsien 221, Taiwan
Contact Person: Mr. Easy Lai, e-mail:easy_lai@acer.com.tw



And,

Acer Europe SA
Via Cantonale, Centro Galleria 2 6928 Manno Switzerland

Hereby declare that:

Product: Notebook Computer
Trade Name: Acer
Model Number: MS2296
Machine Type: AO753 series

Is compliant with the essential requirements and other relevant provisions of the following EC directives, and that all the necessary steps have been taken and are in force to assure that production units of the same product will continue comply with the requirements.

EMC Directive 2004/108/EC as attested by conformity with the following harmonized standards:

- EN55022, AS/NZS CISPR22, Class B
- EN55024
- EN61000-3-2 Class D
- EN61000-3-3

Low Voltage Directive 2006/95/EC as attested by conformity with the following harmonized standard:

- EN60950-1

Council Decision 98/482/EC (CTR21):

(Applicable to product with pan- European single terminal connection to the Public Switched Telephone Network (PSTN).)

RoHS Directive 2002/95/EC on the Restriction of the Use of certain Hazardous Substances in Electrical and Electronic Equipment

- The maximum concentration values of the restricted substances by weight in homogenous material are:

Lead	0.1%	Polybrominated Biphenyls (PBB's)	0.1%
Mercury	0.1%	Polybrominated Diphenyl Ethers (PBDE's)	0.1%
Hexavalent Chromium	0.1%	Cadmium	0.01%

Directive 2009/125/EC with regard to establishing a framework for the setting of ecodesign requirements for energy-related product.

R&TTE Directive 1999/5/EC as attested by conformity with the following harmonized standard:

- Article 3.1(a) Health and Safety
 - EN60950-1
 - EN62311
- Article 3.1(b) EMC
 - EN301 489-1
 - EN301 489-3 (Applicable to non-bluetooth wireless keyboard mouse set).
 - EN301 489-7
 - EN301 489-17
 - EN301 489-24
- Article 3.2 Spectrum Usages
 - EN300 440-2 (Applicable to non-bluetooth wireless keyboard mouse set).
 - EN300 328
 - EN301 511
 - EN301 893 (Applicable to 5GHz high performance RLAN).
 - EN301 908-1
 - EN301 908-2

Year to begin affixing CE marking 2010.

Easy Lai

Easy Lai /Manager
Regulation Center, Acer Inc.

Apr. 30, 2010

Date

Для пользователей-новичков

1

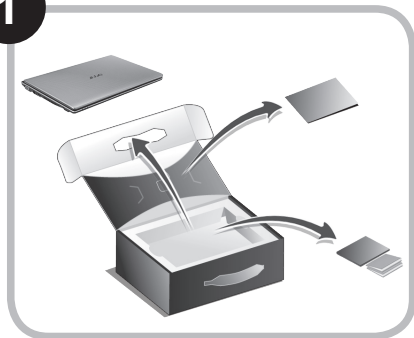

2

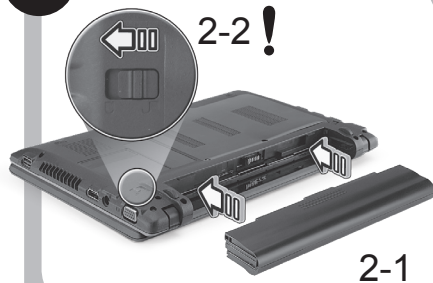

! Убедитесь, что аккумулятор правильно зафиксирован в отсеке, как показано на рис. 2-2.

3

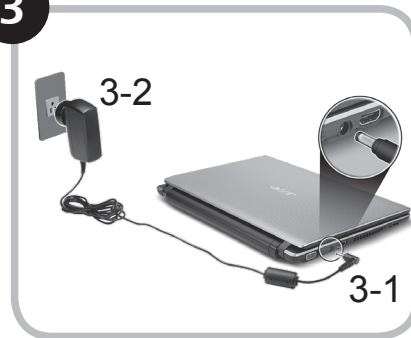

4



5



6



Иллюстрации носят ориентировочный характер. Реальные характеристики могут отличаться от указанных.

Вначале о главном

Благодарим вас за то, что для решения своих мобильных вычислительных задач вы выбрали ноутбук Acer.

Ваши руководства

Мы разработали ряд руководств, которые помогут вам в использовании ноутбука Acer*:

Прежде всего, Краткое руководство поможет вам настроить основные параметры компьютера.

Дополнительные сведения о том, как этот компьютер помогает повысить производительность работы, см. в Руководстве пользователя AcerSystem. Это руководство содержит подробные сведения о системных функциях, восстановлении данных, возможностях расширения и устранении неисправностей. В нем также приведена информация о гарантийном обслуживании, а также общие предписания и правила безопасности при работе с ноутбуком. Это руководство в виде файла PDF изначально загружено в компьютер.



Примечание: для просмотра этого файла требуется программа Adobe Reader. Если программа Adobe Reader не установлена в вашем компьютере, то по щелчку по пункту "AcerSystem User Guide" сначала запустится утилита установки программы Adobe Reader. Для завершения установки выполните отображаемые на экране инструкции. Указания по работе с программой Adobe Reader см. в Справке и в меню Поддержка.



*** ВАЖНОЕ ПРИМЕЧАНИЕ:** Следует иметь в виду, что упоминаемые здесь руководства в печатной или в электронной форме служат только для справки, и за исключением положений, изложенных в разделе гарантийной информации в Руководстве пользователя AcerSystem, в этих руководствах никакие другие положения не являются заявлением компании Acer или ее гарантией в отношении купленного вами продукта. Компания Acer в прямой форме отказывается от всякой ответственности за возможные ошибки в этих руководствах.

Конфигурация сети

Это руководство поможет вам настроить параметры локальной и беспроводной сети для подключения к Интернету.

Настройка подключения по локальной сети

Достаточно подключить кабель локальной сети к разъему Ethernet (RJ-45). Расположение разъема Ethernet см. на рис. "Вид справа" на стр. 6.

Настройка подключения к беспроводной сети

1. Чтобы открыть диспетчер связи, нажмите <Fn> + <F3> Здесь можно включить модуль Wi-Fi, нажав красную кнопку рядом с Wi-Fi.

Примечание: Диспетчер связи также позволяет включать модули 3G и Bluetooth. Типы модулей связи зависят от конфигурации системы.

2. В системной области панели задач щелкните по значку  и выберите точку беспроводного доступа, к которой хотите подключиться.

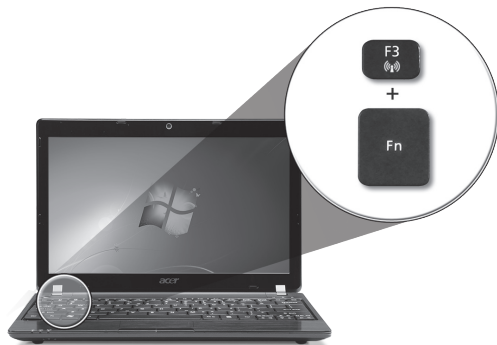

Установка SIM-карты сети 3G (только для определенных моделей)

Извлеките аккумулятор и осторожно вставьте SIM-карту 3G в гнездо для SIM-карты 3G. Местоположение гнезда для SIM-карты 3G см. на рисунке "Вид сзади & Вид снизу" на стр. 6.

Знакомство с *Aspire One*

Теперь, когда вы выполнили настройки, как показано в разделе Для пользователей-новичков, давайте поближе познакомимся с вашим новым ноутбуком Acer.

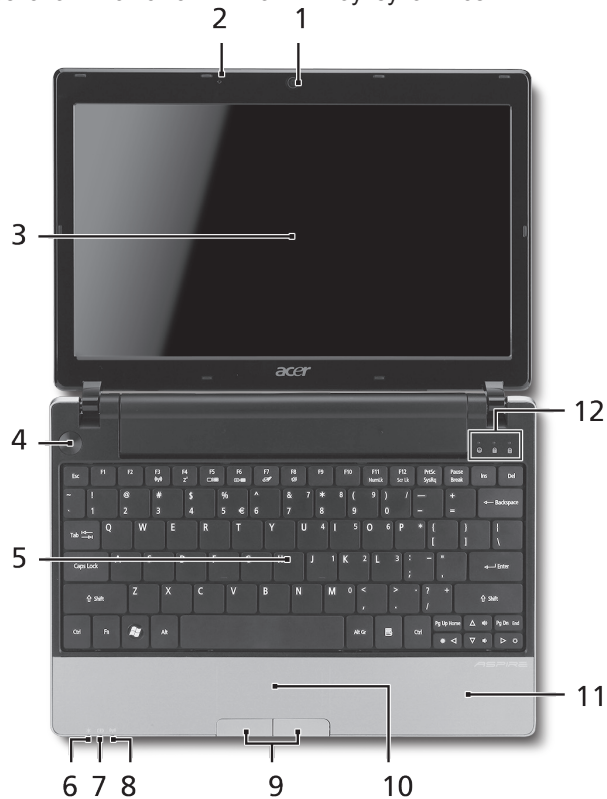

Вид сверху



#	Значок	Элемент	Описание									
1		Веб-камера Acer Crystal Eye	Веб-камера для видеосвязи (конфигурация может отличаться в зависимости от модели).									
2		Микрофон	Внутренний микрофон для записи звука.									
3		Экран дисплея	Другое название - жидкокристаллический дисплей (ЖК-дисплей); служит для вывода изображения, формируемого компьютером (конфигурация может отличаться в зависимости от модели).									
4		Кнопка питания	Служит для включения/выключения компьютера.									
5		Клавиатура	Служит для ввода данных в компьютер.									
6		Индикатор питания ¹	Отображает состояние питания компьютера.									
7		Индикатор аккумулятора ¹	Отображает состояние аккумулятора компьютера. 1. Зарядка: этот индикатор горит желтым во время зарядки аккумулятора. 2. Полностью заряжен: Этот индикатор горит синим при питании от электросети.									
8		Индикатор связи ¹	Указывает на состояние связи в беспроводной сети / сети 3G. <table border="1" data-bbox="1086 610 1538 714"> <thead> <tr> <th>Горит синим</th> <th>Горит оранжевым</th> <th>Не горит</th> </tr> </thead> <tbody> <tr> <td>Подключение 3G/WiFi вкл.</td> <td>Подключение 3G/WiFi вкл.</td> <td>Подключение 3G/WiFi выкл.</td> </tr> <tr> <td>Подключение 3G/WiFi выкл.</td> <td></td> <td></td> </tr> </tbody> </table>	Горит синим	Горит оранжевым	Не горит	Подключение 3G/WiFi вкл.	Подключение 3G/WiFi вкл.	Подключение 3G/WiFi выкл.	Подключение 3G/WiFi выкл.		
Горит синим	Горит оранжевым	Не горит										
Подключение 3G/WiFi вкл.	Подключение 3G/WiFi вкл.	Подключение 3G/WiFi выкл.										
Подключение 3G/WiFi выкл.												
9		Кнопки управления (левая и правая)	Эти левая и правая кнопки действуют так же, как левая и правая кнопки мыши.									
10		Сенсорная панель	Чувствительное к прикосновениям указательное устройство, позволяющее управлять курсором на экране так же, как и мышью.									
11		Подставка для запястий	Упорная площадка, на которую удобно положить руки при работе на компьютере.									
12		Индикатор работы жесткого диска	Горит при обращении к жесткому диску.									
		Num Lock	Зажигается при включенной фиксации числового регистра (Num Lock).									
		Caps Lock	Зажигается при включенной фиксации верхнего регистра (Caps Lock).									

1. Индикаторы на передней панели видны даже при закрытой крышке компьютера.

Вид спереди с закрытой крышкой

#	Значок	Элемент	Описание
1		Индикаторы состояния	Поджигание светоизлучающих диодов (СД) отображает состояние функций и компонентов компьютера.

**Вид слева**

2		Разъем внешнего дисплея (VGA)	Служит для подключения устройства отображения (например, внешнего монитора, ЖК-проектора).
3		Разъем для подключения питания постоянного тока	Служит для подключения адаптера переменного тока.
4	HDMI	Разъем HDMI	Служит для подключения к источникам цифрового видео высокой четкости.
5		Вентиляционные отверстия	Позволяют компьютеру не перегреваться даже при длительной работе.
6		Разъем USB 2.0	Служит для подключения устройств с интерфейсом USB 2.0 (например, мыши или камеры).

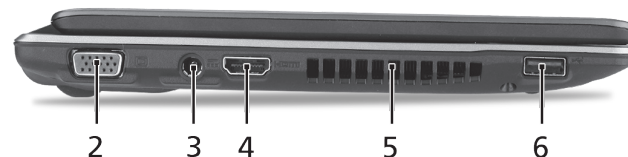

Вид справа

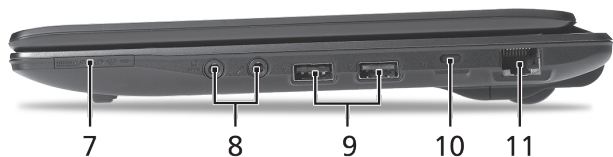

#	Значок	Элемент	Описание
7		Комбинированное устройство считывания карт памяти различных форматов	Поддерживает форматы Secure Digital (SD), MultiMediaCard (MMC), Memory Stick (MS), Memory Stick PRO (MS PRO), xD-Picture Card (xD). Примечание: надавите, чтобы извлечь/вставить карту. Одновременно можно использовать только одну карту памяти.
8		Гнездо микрофонного входа	Служит для подключения внешнего микрофона.
		Гнездо наушников/динамика/линейного выхода с поддержкой цифрового интерфейса S/PDIF	Служит для подключения звуковых устройств к линейному выходу (например, динамиков, наушников).
9		Разъем USB 2.0	Служит для подключения устройств с интерфейсом USB 2.0 (например, мыши).
10		Замок типа Kensington	Служит для подсоединения защитного тросика с замком типа Kensington для предотвращения кражи компьютера.
11		Разъем Ethernet (RJ-45)	Служит для подключения к сети Ethernet 10/100/1000 Мбит/с.

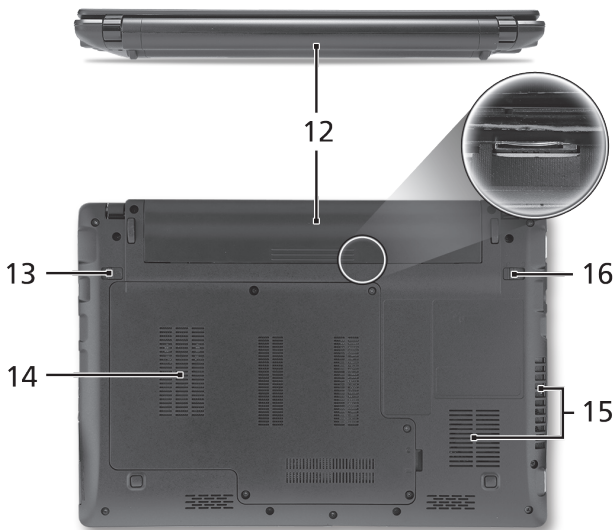

Вид сзади & Вид снизу

12		Отсек аккумулятора	В этот отсек устанавливается аккумулятор компьютера.
13		Защелка извлечения аккумулятора	Разблокирует аккумулятор для его извлечения.
14		Отсек жесткого диска	Здесь размещается жесткий диск компьютера (крепится винтами).
		Отсек модулей оперативной памяти	В этот отсек устанавливаются модули оперативной памяти компьютера.
15		Вентиляционные отверстия и вентилятор охлаждения	Позволяют компьютеру не перегреваться даже при длительной работе. Примечание: не заслоняйте и не загораживайте входное отверстие вентилятора.
16		Защелка аккумулятора	Служит для фиксации аккумулятора в отсеке.

Условия эксплуатации

Температура:

Рабочая: от 5°C до 35°C

Нерабочая: от -20°C до 65°C

Влажность (без конденсации):

Рабочая: от 20% до 80%

Нерабочая: от 20% до 80%

Komputer Serii **ASPIRE** ONE

Skrócony poradnik

Komputer serii *ASPIRE* one

© 2010 Wszelkie prawa zastrzeżone

Skrócony poradnik komputera serii *Aspire One*

Wydanie oryginalne: 04/2010

Notebook PC serii *Aspire One*

Oznaczenie modelu: _____

Numer seryjny: _____

Data zakupu: _____

Miejsce zakupu: _____

Federal Communications Commission

Declaration of Conformity

This device complies with Part 15 of the FCC Rules. Operation is subject to the following two conditions: (1) this device may not cause harmful interference, and (2) this device must accept any interference received, including interference that may cause undesired operation.

The following local Manufacturer / Importer is responsible for this declaration:

Product name:	Notebook PC
Brand:	Acer
Model number:	MS2296
Machine type:	<i>AO 753 series</i>
Name of Responsible Party:	Acer America Corporation
Address of responsible party:	333 West San Carlos St., San Jose CA 95110, U. S. A.
Contact person:	Acer Representative
Phone No.:	1-254-298-4000
Fax No.:	1-254-298-4147
April 30, 2010	

CE Declaration of Conformity

We,

Acer Incorporated

8F, 88, Sec. 1, Hsin Tai Wu Rd., Hsichih, Taipei Hsien 221, Taiwan

Contact Person: Mr. Easy Lai, e-mail:easy_lai@acer.com.tw



And,

Acer Europe SA

Via Cantonale, Centro Galleria 2 6928 Manno Switzerland

Hereby declare that:

Product: Notebook Computer

Trade Name: Acer

Model Number: MS2296

Machine Type: AO753 series

Is compliant with the essential requirements and other relevant provisions of the following EC directives, and that all the necessary steps have been taken and are in force to assure that production units of the same product will continue comply with the requirements.

EMC Directive 2004/108/EC as attested by conformity with the following harmonized standards:

- EN55022, AS/NZS CISPR22, Class B
- EN55024
- EN61000-3-2 Class D
- EN61000-3-3

Low Voltage Directive 2006/95/EC as attested by conformity with the following harmonized standard:

- EN60950-1

Council Decision 98/482/EC (CTR21):

(Applicable to product with pan- European single terminal connection to the Public Switched Telephone Network (PSTN).)

RoHS Directive 2002/95/EC on the Restriction of the Use of certain Hazardous Substances in Electrical and Electronic Equipment

- The maximum concentration values of the restricted substances by weight in homogenous material are:

Lead	0.1%	Polybrominated Biphenyls (PBB's)	0.1%
Mercury	0.1%	Polybrominated Diphenyl Ethers (PBDE's)	0.1%
Hexavalent Chromium	0.1%	Cadmium	0.01%

Directive 2009/125/EC with regard to establishing a framework for the setting of ecodesign requirements for energy-related product.

R&TTE Directive 1999/5/EC as attested by conformity with the following harmonized standard:

- Article 3.1(a) Health and Safety
 - EN60950-1
 - EN62311
- Article 3.1(b) EMC
 - EN301 489-1
 - EN301 489-3 (Applicable to non-bluetooth wireless keyboard mouse set).
 - EN301 489-7
 - EN301 489-17
 - EN301 489-24
- Article 3.2 Spectrum Usages
 - EN300 440-2 (Applicable to non-bluetooth wireless keyboard mouse set).
 - EN300 328
 - EN301 511
 - EN301 893 (Applicable to 5GHz high performance RLAN).
 - EN301 908-1
 - EN301 908-2

Year to begin affixing CE marking 2010.

Easy Lai

Easy Lai /Manager
Regulation Center, Acer Inc.

Apr. 30, 2010

Date

Na początek

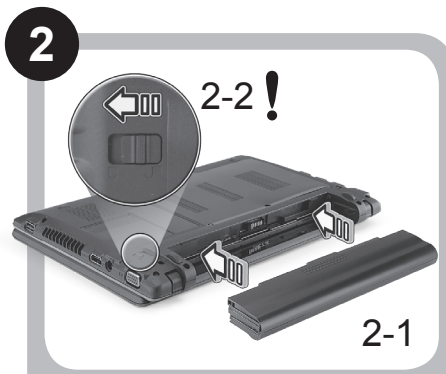
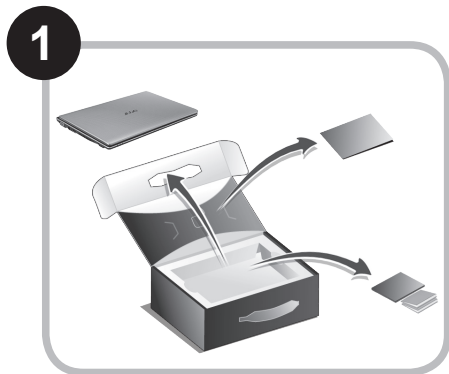

! Upewnij się, że bateria jest prawidłowo zamocowana na swoim miejscu tak, jak to przedstawiono na ilustracji 2-2.

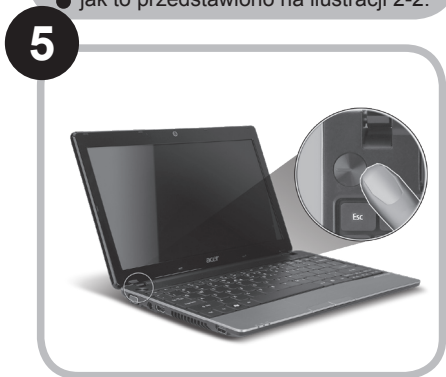

Ilustracje są przykładowe. Faktyczne specyfikacje produktów mogą różnić się od przedstawionej.

Po kolei

Dziękujemy za wybranie komputera firmy Acer do spełnienia potrzeb w zakresie mobilnego przetwarzania.

Instrukcje

Aby pomóc w korzystaniu z komputera Acer, opracowaliśmy zestaw instrukcji*:

Jako pierwszy wymienić można Skrócony poradnik, który pomoże użytkownikom rozpocząć ustawianie komputera.

Aby uzyskać więcej informacji o tym, w jaki sposób nowy komputer może pomóc Ci być bardziej produktywnym, zapoznaj się z AcerSystem User Guide. Przewodnik ten zawiera szczegółowe informacje dotyczące takich tematów, jak narzędzia systemowe, odzyskiwanie danych, opcje rozszerzeń oraz rozwiązywanie problemów. Oprócz nich zawiera także informacje na temat gwarancji oraz informacje dotyczące bezpieczeństwa pracy z Twoim komputerem przenośnym. Jest on dostępny w formie elektronicznej jako plik PDF zapisany fabrycznie na dysku komputera.



Uwaga: Podgląd pliku wymaga zainstalowania programu Adobe Acrobat Reader. Jeżeli na komputerze nie ma zainstalowanego programu Adobe Acrobat Reader, kliknięcie AcerSystem User Guide spowoduje uruchomienie instalatora programu Adobe Acrobat Reader. Aby zakończyć instalację, należy postępować zgodnie z instrukcjami wyświetlanymi na ekranie. Instrukcje dotyczące użytkowania programu Adobe Acrobat Reader znaleźć można w menu Pomoc i obsługa techniczna.



*** WAŻNA UWAGA: Należy pamiętać, że wszelkie instrukcje opisane w niniejszej publikacji, zarówno w formie pisemnej, jak i elektronicznej, mają charakter wyłącznie referencyjny, oraz że żadne informacje w niej zawarte nie stanowią gwarancji na zakupiony produkt firmy Acer z wyjątkiem warunków gwarancyjnych określonych w podręczniku użytkownika AcerSystem User Guide. Firma Acer zrzeka się odpowiedzialności za wszelkie błędy, jakie zawierają mogą niniejsze instrukcje.**

Konfiguracja sieci

Niniejszy przewodnik pomoże Ci skonfigurować ustawienia sieci LAN oraz bezprzewodowej tak, aby możliwe było nawiązanie połączenia z Internetem.

Konfiguracja połączenia z siecią LAN

Po prostu podłącz kabel sieciowy LAN do gniazda Ethernet (RJ-45). Zjrzyj do sekcji "**Widok z prawej**" na **stronie 6** aby dowiedzieć się gdzie znajduje się gniazdo Ethernet.

Konfiguracja połączenia z siecią bezprzewodową

1. Naciśnij klawisze <Fn> + <F3>, aby uzyskać dostęp do menedżera komunikacji. Można w nim włączyć połączenie Wi-Fi klikając czerwony przycisk obok napisu Wi-Fi.

Uwaga: Menedżer komunikacji umożliwi również połączenia za pomocą 3G i Bluetooth. Urządzenia komunikacyjne różnią się w zależności od modelu.

2. Kliknij ikonę  w zasobniku systemowym i wybierz bezprzewodowy punkt dostępowy, z którym chcesz się połączyć.

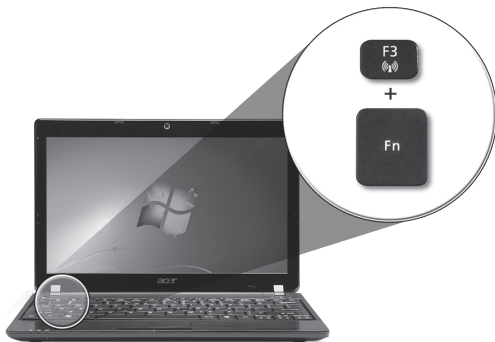

Wkładanie karty SIM 3G (w wybranych modelach)

Wyciągnij baterię i ostrożnie włoż kartę SIM 3G do gniazda karty SIM 3G. Patrz "**Widok z tyłu & Widok od spodu**" na **stronie 6**, aby uzyskać informacje o lokalizacji gniazda karty SIM 3G.

Opis komputera *Aspire One*

Po przygotowaniu komputera do pracy według instrukcji zawartych w sekcji Na początek zapoznaj się bliżej z notebookiem Acer.

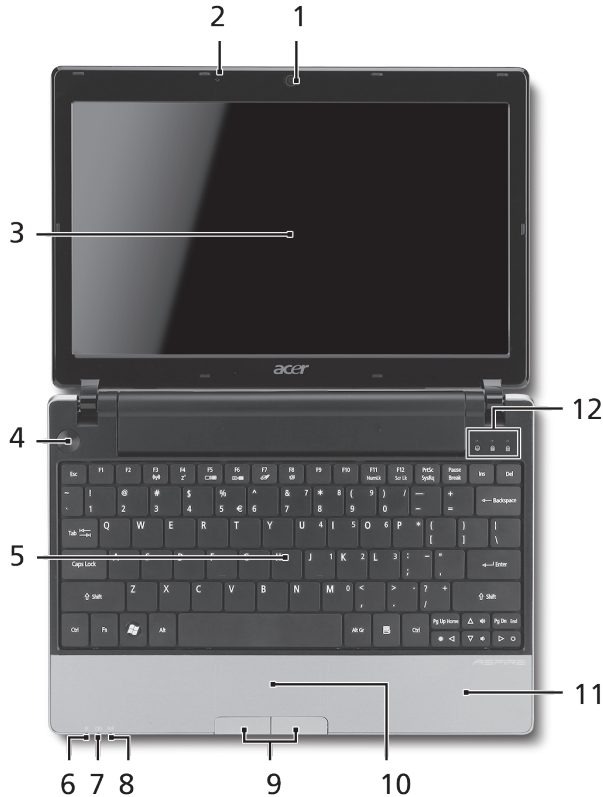

Widok z góry





#	Ikona	Element	Opis									
1		Kamera Acer Crystal Eye	Kamera internetowa do komunikacji wideo (konfiguracja może być różna w zależności od modelu).									
2		Mikrofon	Wewnętrzny mikrofon do rejestrowania dźwięku.									
3		Ekran wyświetlacza	Nazywany jest także wyświetlaczem ciekłokrystalicznym (Liquid-Crystal Display; LCD), wyświetla informacje wyjściowe komputera (konfiguracja może być różna w zależności od modelu).									
4		Przycisk zasilania	Służy do włączania i wyłączania komputera.									
5		Klawiatura	Umożliwia wprowadzanie danych do komputera.									
6		Wskaźnik zasilania ¹	Wskazuje stan zasilania komputera.									
7		Wskaźnik akumulatora ¹	Wskazuje stan akumulatora komputera. 1. Ładowanie: Świeci żółtym światłem, gdy akumulator jest ładowany. 2. Pełne naładowanie: Świeci niebieskim światłem podczas pracy w trybie zasilania prądem przemiennym.									
8		Wskaźnik komunikacji ¹	Wskazuje stan komunikacji bezprzewodowej sieci LAN/3G.									
			<table border="1"> <thead> <tr> <th>Świeci na niebiesko</th> <th>Świeci na pomarańczowo</th> <th>Nie świeci</th> </tr> </thead> <tbody> <tr> <td>Wł. 3G/wł. Wi-Fi</td> <td>Wył. 3G/wł. Wi-Fi</td> <td>Wył. 3G/wył. Wi-Fi</td> </tr> <tr> <td>Wł. 3G/wył. Wi-Fi</td> <td></td> <td></td> </tr> </tbody> </table>	Świeci na niebiesko	Świeci na pomarańczowo	Nie świeci	Wł. 3G/wł. Wi-Fi	Wył. 3G/wł. Wi-Fi	Wył. 3G/wył. Wi-Fi	Wł. 3G/wył. Wi-Fi		
Świeci na niebiesko	Świeci na pomarańczowo	Nie świeci										
Wł. 3G/wł. Wi-Fi	Wył. 3G/wł. Wi-Fi	Wył. 3G/wył. Wi-Fi										
Wł. 3G/wył. Wi-Fi												
9		Przyciski kliknięć (lewy i prawy)	Działanie lewego i prawego przycisku jest podobne do działania lewego i prawego przycisku myszki.									
10		Touchpad	Dotykowe urządzenie wskazujące, które działa jak myszka komputerowa.									
11		Podparcie nadgarstków	Wygodne podparcie dłoni podczas używania komputera.									
12		Wskaźnik dysku twardego	Świeci, gdy działa dysk twardy.									
		NumLk	Świeci po uaktywnieniu klawisza NumLk.									
		Caps Lock	Świeci po uaktywnieniu klawisza Caps Lock.									

1. Wskaźniki panelu czołowego są widoczne nawet po zamknięciu pokrywy komputera.

Widok z przodu (pokrywa zamknięta)





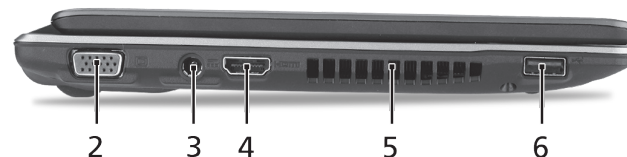

#	Ikona	Element	Opis
1		Wskaźniki stanu	Diody LED (ang. Light-Emitting Diodes), które zapalają się i gasną, pokazując stan funkcji i podzespołów komputera.

Widok z lewej

2		Port zewnętrznego wyświetlacza (VGA)	Służy do przyłączenia urządzenia wyświetlającego (np. zewnętrzny monitor, projektor LCD).
3		Gniazdo zasilania	Gniazdo zasilacza.
4		Port HDMI	Obsługuje połączenia cyfrowego video o wysokiej rozdzielczości.
5		Szczeliny wentylacyjne	Umożliwiają chłodzenie komputera nawet podczas długotrwałego użytkowania.
6		Port USB 2.0	Służy do podłączania urządzeń USB (np. mysz USB lub kamera USB).





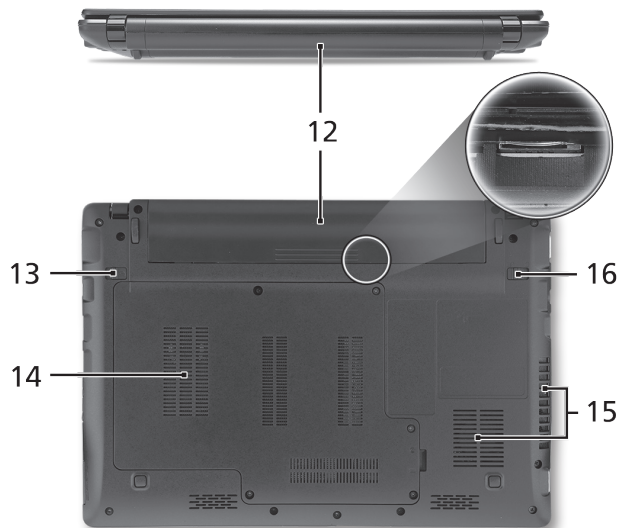
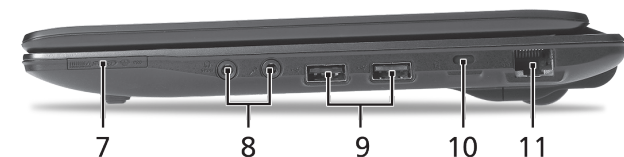

Widok z prawej

#	Ikona	Element	Opis
7		Wielofunkcyjny czytnik kart pamięci	Obsługuje następujące typy kart: Secure Digital (SD), MultiMediaCard (MMC), Memory Stick (MS), Memory Stick PRO (MS PRO) oraz xD-Picture Card (xD). Uwaga: Aby wyjąć/zainstalować kartę, wciśnij ją delikatnie. Jednorazowo można używać tylko jednego rodzaju karty.
8		Gniazdo mikrofonowe	Służy do przyłączania sygnału z zewnętrznych mikrofonów.
		Gniazdo słuchawkowe/ głośnikowe/wyjścia liniowego z obsługą S/PDIF	Służy do przyłączania urządzeń liniowego wyjścia audio (np. głośniki, słuchawki).
9		Port USB 2.0	Służy do podłączania urządzeń USB 2.0 (np. mysz USB lub kamera USB).
10		Gniazdo blokady Kensington	Służy do podłączania blokady zgodnej ze standardem firmy Kensington.
11		Port Ethernet (RJ-45)	Służy do łączenia z siecią Ethernet 10/100/1000.



Widok z tyłu & Widok od spodu

12		Wnęka na baterię	Przechowuje baterię komputera.
13		Blokada baterii	Umożliwia zwolnienie i wyjęcie baterii.
14		Wnęka na dysk twardy	Mieści dysk twardy komputera (zabezpieczona śrubami).
		Przegroda na pamięć	Mieści główną pamięć komputera.
15		Otwory wentylacyjne oraz wentylator	Umożliwiają chłodzenie komputera nawet podczas długotrwałego użytkowania. Uwaga: Nie wolno przykrywać lub blokować wlotów powietrza.
16		Zatrzask baterii	Pozwala zabezpieczyć baterię w prawidłowej pozycji.

Warunki środowiska

Temperatura:

Podczas pracy: 5°C do 35°C

Podczas przechowywania: -20°C do 65°C

Wilgotność (bez kondensacji pary):

Podczas pracy: 20% do 80%

Podczas przechowywania: 20% do 80%

ASPIRE ONE **sorozat**

Rövid útmutató

Aspire One sorozatú hordozható számítógép

Modellszám: _____

Sorozatszám: _____

A vásárlás időpontja: _____

A vásárlás helye: _____

Federal Communications Commission

Declaration of Conformity

This device complies with Part 15 of the FCC Rules. Operation is subject to the following two conditions: (1) this device may not cause harmful interference, and (2) this device must accept any interference received, including interference that may cause undesired operation.

The following local Manufacturer / Importer is responsible for this declaration:

Product name:	Notebook PC
Brand:	Acer
Model number:	MS2296
Machine type:	<i>AO 753 series</i>
Name of Responsible Party:	Acer America Corporation
Address of responsible party:	333 West San Carlos St., San Jose CA 95110, U. S. A.
Contact person:	Acer Representative
Phone No.:	1-254-298-4000
Fax No.:	1-254-298-4147
April 30, 2010	

CE Declaration of Conformity

We,

Acer Incorporated

8F, 88, Sec. 1, Hsin Tai Wu Rd., Hsichih, Taipei Hsien 221, Taiwan

Contact Person: Mr. Easy Lai, e-mail:easy_lai@acer.com.tw

And,

Acer Europe SA

Via Cantonale, Centro Galleria 2 6928 Manno Switzerland

Hereby declare that:

Product: Notebook Computer

Trade Name: Acer

Model Number: MS2296

Machine Type: AO753 series

Is compliant with the essential requirements and other relevant provisions of the following EC directives, and that all the necessary steps have been taken and are in force to assure that production units of the same product will continue comply with the requirements.

EMC Directive 2004/108/EC as attested by conformity with the following harmonized standards:

- EN55022, AS/NZS CISPR22, Class B
- EN55024
- EN61000-3-2 Class D
- EN61000-3-3

Low Voltage Directive 2006/95/EC as attested by conformity with the following harmonized standard:

- EN60950-1

Council Decision 98/482/EC (CTR21):

(Applicable to product with pan- European single terminal connection to the Public Switched Telephone Network (PSTN).)

RoHS Directive 2002/95/EC on the Restriction of the Use of certain Hazardous Substances in Electrical and Electronic Equipment



- The maximum concentration values of the restricted substances by weight in homogenous material are:

Lead	0.1%	Polybrominated Biphenyls (PBB's)	0.1%
Mercury	0.1%	Polybrominated Diphenyl Ethers (PBDE's)	0.1%
Hexavalent Chromium	0.1%	Cadmium	0.01%

Directive 2009/125/EC with regard to establishing a framework for the setting of ecodesign requirements for energy-related product.

R&TTE Directive 1999/5/EC as attested by conformity with the following harmonized standard:

- Article 3.1(a) Health and Safety
 - EN60950-1
 - EN62311
- Article 3.1(b) EMC
 - EN301 489-1
 - EN301 489-3 (Applicable to non-bluetooth wireless keyboard mouse set).
 - EN301 489-7
 - EN301 489-17
 - EN301 489-24
- Article 3.2 Spectrum Usages
 - EN300 440-2 (Applicable to non-bluetooth wireless keyboard mouse set).
 - EN300 328
 - EN301 511
 - EN301 893 (Applicable to 5GHz high performance RLAN).
 - EN301 908-1
 - EN301 908-2

Year to begin affixing CE marking 2010.

Easy Lai

Easy Lai /Manager
Regulation Center, Acer Inc.

Apr. 30, 2010

Date

Miután a Kezdők számára...

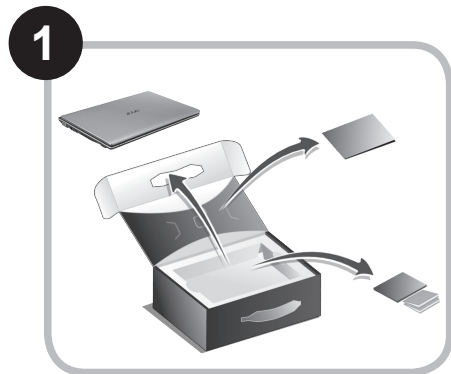

A képek csak illusztrációk. A termék műszaki leírásában eltérések lehetnek.

Az első lépések

Köszönjük, hogy mobil számítástechnikai feladatai elvégzéséhez egy Acer hordozható számítógépet választott.

Útmutatók

Minden segítséget szeretnénk megadni Önnek új Acer gépének használatához, ezért a következő útmutatókat dolgoztuk ki*:

Az első a Rövid útmutató, amely segítségére lesz a számítógép üzembe helyezésénél.

A számítógép hatékonyabb használatához az AcerSystem User Guide ad segítséget. Ez a kézikönyv részletes információkat tartalmaz például az előre telepített segédprogramokról, az adat-helyreállításról, a bővítési lehetőségekről és a hibaelhárításról. Emellett ismerteti a garanciával kapcsolatos tudnivalókat, valamint a számítógépre vonatkozó általános szabályokat és biztonsági előírásokat is. A kézikönyv Portable Document Format (PDF) formátumú, és gyárilag telepítve van a számítógépre.



Megjegyzés: A fájl megtekintéséhez szükség van az Adobe Reader alkalmazásra. Ha az Adobe Reader nincs telepítve a számítógépre, akkor az AcerSystem User Guide elemre kattintva először az Adobe Reader telepítőprogramja jelenik meg. A telepítés elvégzéséhez kövesse a képernyőn megjelenő utasításokat. Az Adobe Reader használatához a Súgó és támogatás menüben talál útmutatást.



*** FONTOS MEGJEGYZÉS:** Felhívjuk figyelmét arra, hogy az itt említett útmutatók, legyen szó akár elektronikus, akár nyomtatott formátumú kiadványról, kizárólag tájékoztató célt szolgálnak, és hacsak az AcerSystem User Guide másként nem rendelkezik, ezeknek az útmutatóknak a tartalma semmilyen kijelentést vagy garanciavállalást nem jelent az Acer részéről az Ön által megvásárolt terméket illetően. Az Acer kifejezetten elhárít az útmutatókban található hibákkal kapcsolatos minden felelősséget.

Hálózati konfiguráció

Ezen útmutató segítségével megadhatja a vezetékes és a vezeték nélküli hálózat beállításait; ezt követően csatlakozhat az Internetre.

LAN-kapcsolat beállítása

Egyszerűen csatlakoztassa a hálózati kábelt az Ethernet (RJ-45) portba. Az Ethernet port helyét illetően lásd „**Jobb oldali nézet**” a **6. oldalon**.

Vezeték nélküli hálózati kapcsolat beállítása

1. Az <Fn> + <F3> billentyűkombinációval nyissa meg a Kommunikációkezelőt. Itt kapcsolható be a Wi-Fi-adapter; a bekapcsoláshoz kattintson a Wi-Fi melletti vörös gombra.

Megjegyzés: A 3G és a Bluetooth ugyancsak a Kommunikációkezelővel érhető el. A kommunikációs modulok konfigurációtól függően eltérők lehetnek.

2. Kattintson a rendszer tálcáján található  ikonra, majd válassza ki, hogy melyik vezeték nélküli hozzáférési ponthoz kíván csatlakozni.



3G SIM-kártya behelyezése (csak bizonyos típusok esetében).

Távolítsa el az akkumulátort, majd óvatosan tegye be a 3G SIM-kártyát a 3G SIM-kártyafoglatba. A 3G SIM-kártyafoglat helyét illetően lásd: „**Hátulnézet & Alulnézet**” a **6. oldalon**.

Ismerkedés az Aspire One készülékkel

Miután a Kezdők számára... szakasz alapján üzembe helyezte a számítógépet, ismerkedjen meg új Acer notebookjával!

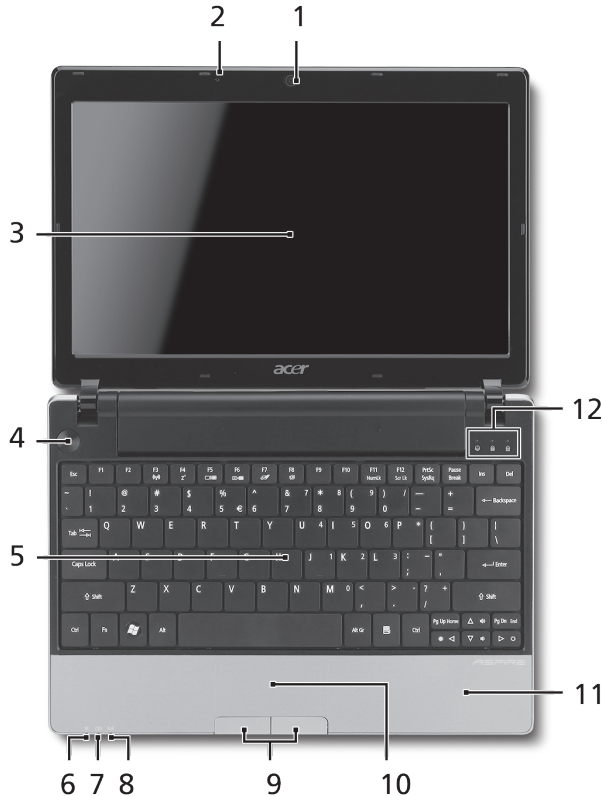

Felülnézet



#	Ikön	Elem	Leírás						
1		Acer Crystal Eye webkamera	Webkamera videokommunikációs célokra (a konfiguráció típusától függően változhat).						
2		Mikrofon	Belső mikrofon hangfelvételek készítéséhez.						
3		Kijelző	Más néven folyadékkristályos kijelző (Liquid-Crystal Display, LCD), a számítógép kimenetét jeleníti meg (a konfiguráció típusától függően változhat).						
4		Bekapcsoló gomb	A számítógép be- és kikapcsolására szolgál.						
5		Billentyűzet	Az adatbevitel eszköze.						
6		Üzemállapot jelzőfénye	A számítógép üzemállapotát jelzi.						
7		Akkumulátor állapotjelzője ¹	Az akkumulátor üzemállapotát jelzi. 1. Töltés: Sárgán világít, ha az akkumulátor töltése folyamatban van. 2. Teljesen feltöltve: Hálózati tápellátás használatakor kéken világít.						
8		Kommunikációs állapotjelző ¹	A vezeték nélküli LAN/3G kommunikáció állapotát jelzi.						
			<table border="1"> <tbody> <tr> <td>Kék jelzőfény bekapcsolva</td> <td>Narancssárga jelzőfény bekapcsolva</td> <td>Kikapcsolva</td> </tr> <tr> <td>3G bekapcsolva/ Wi-Fi bekapcsolva</td> <td>3G kikapcsolva/ Wi-Fi bekapcsolva</td> <td>3G kikapcsolva/ WiFi kikapcsolva</td> </tr> </tbody> </table>	Kék jelzőfény bekapcsolva	Narancssárga jelzőfény bekapcsolva	Kikapcsolva	3G bekapcsolva/ Wi-Fi bekapcsolva	3G kikapcsolva/ Wi-Fi bekapcsolva	3G kikapcsolva/ WiFi kikapcsolva
Kék jelzőfény bekapcsolva	Narancssárga jelzőfény bekapcsolva	Kikapcsolva							
3G bekapcsolva/ Wi-Fi bekapcsolva	3G kikapcsolva/ Wi-Fi bekapcsolva	3G kikapcsolva/ WiFi kikapcsolva							
9		Kattintógombok (bal és jobb)	A bal és a jobb gomb az egér bal és jobb gombjához hasonlóan működik.						
10		Érintőpad	Érintésérzékeny mutatóeszköz, a számítógépek egeréhez hasonlóan működik.						
11		Csuklótámasz	Kényelmes támaszkodási felület a számítógép használatának idejére.						
12		Merevlemez jelzőfénye	Jelzi, ha a merevlemez használatban van.						
		Num Lock	Akkor világít, ha a Num Lock be van kapcsolva.						
		Caps Lock	Akkor világít, ha a Caps Lock be van kapcsolva.						

1. Az előlap jelzői akkor is láthatók, ha a számítógép fedele le van hajtva.

Előnézet lehajtott kijelzővel

#	Ikon	Elem	Leírás
1		Állapotjelző fények	Fénykibocsátó diódák (Light-Emitting Diode, LED), fényükkel a számítógép funkcióinak és összetevőinek állapotát jelzik.

Bal oldali nézet

2		Külső kijelző (VGA) port	Megjelenítő eszköz (pl. külső monitor vagy LCD kivetítő) csatlakoztatását teszi lehetővé.
3		Egyenáramú bemeneti aljzat	A váltakozó áramú hálózati adapter csatlakoztatását teszi lehetővé.
4	HDMI	HDMI port	A nagy felbontású, digitális videokapcsolatokat támogatja.
5		Szellőzőnyílások	Segítségükkel még hosszabb használat esetén is fenntartható a számítógép megfelelő üzemi hőmérséklete.
6		USB 2.0 port	USB 2.0 eszközök (pl. USB-s egér vagy kamera) csatlakoztatását teszi lehetővé.

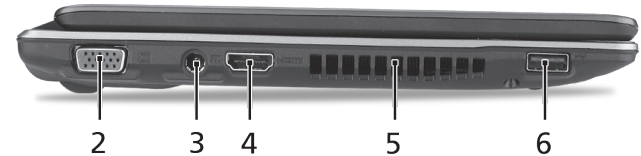

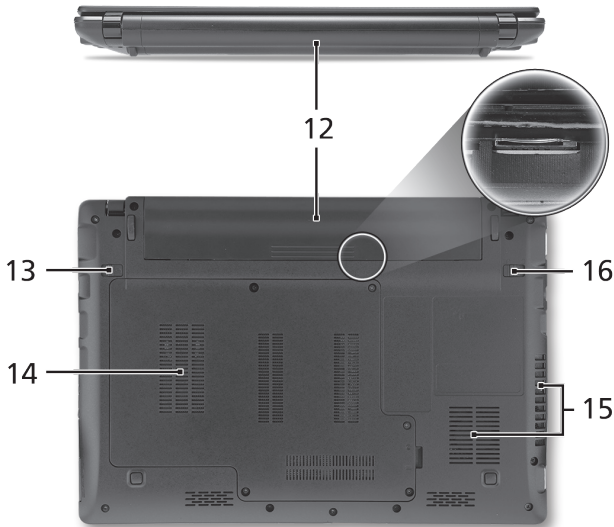
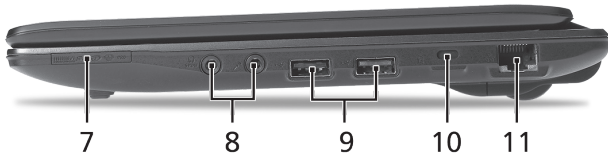

Jobb oldali nézet

#	Ikön Elem	Leírás
7	Multifunkciós kártyaolvasó PRO	Secure Digital (SD), MultiMediaCard (MMC), Memory Stick (MS), Memory Stick PRO (MS PRO) és xD-Picture Card (xD) kártyák fogadására képes. Megjegyzés: A kártyák finoman benyomva helyezhetők be és vehetők ki. Egyszerre csak egy kártya használatára van lehetőség.
8	Mikrofonbemeneti aljzat Fejhallgató/hangszóró/vonali kimenet, S/PDIF-támogatással	Külső mikrofon csatlakoztatását teszi lehetővé. Hangkimeneti eszközök (pl. hangszórók, fejhallgató) csatlakoztatását teszi lehetővé.
9	USB 2.0 port	USB 2.0 eszközök (pl. USB-s egér) csatlakoztatását teszi lehetővé.
10	Kensington záraljzat	Kensington számítógépes biztonsági zár alkalmazását teszi lehetővé.
11	Ethernet (RJ-45) port	Ethernet 10/100/1000 típusú hálózattal képes biztosítani a kapcsolatot.

Hátulnézet & Alulnézet

12	Akkumulátorfoglat	A számítógép akkumulátorát fogadja be.
13	Akkumulátor kioldógombja	Az akkumulátor eltávolítását teszi lehetővé.
14	Merevlemez-foglat	A számítógép merevlemezét fogadja be (csavaros rögzítésű).
	Memóriarekesz	A számítógép memóriáját fogadja be.
15	Szellőzőnyílások és hűtőventilátor	Segítségükkel még hosszabb használat esetén is fenntartható a számítógép megfelelő üzemi hőmérséklete. Megjegyzés: A ventilátor nyílását nem szabad elfedni, illetve a levegő áramlását egyéb módon sem szabad akadályozni.
16	Akkumulátor retesze	Az akkumulátor rögzítését biztosítja.

Környezet

Hőmérséklet:

Üzemeltetés: 5°C – 35°C

Kikapcsolt állapotban: -20°C – 65°C

Páratartalom (kicsapódás nélkül):

Üzemeltetés: 20% – 80%

Kikapcsolt állapotban: 20% – 80%

Řada **ASPIRE** ONE

Stručné pokyny

Notebook řady *Aspire One*

Číslo modelu: _____

Sériové číslo: _____

Datum zakoupení: _____

Místo zakoupení: _____

Federal Communications Commission Declaration of Conformity

This device complies with Part 15 of the FCC Rules. Operation is subject to the following two conditions: (1) this device may not cause harmful interference, and (2) this device must accept any interference received, including interference that may cause undesired operation.

The following local Manufacturer / Importer is responsible for this declaration:

Product name:	Notebook PC
Brand:	Acer
Model number:	MS2296
Machine type:	AO 753 series
Name of Responsible Party:	Acer America Corporation
Address of responsible party:	333 West San Carlos St., San Jose CA 95110, U. S. A.
Contact person:	Acer Representative
Phone No.:	1-254-298-4000
Fax No.:	1-254-298-4147
April 30, 2010	

CE Declaration of Conformity

We,

Acer Incorporated

8F, 88, Sec. 1, Hsin Tai Wu Rd., Hsichih, Taipei Hsien 221, Taiwan

Contact Person: Mr. Easy Lai, e-mail:easy_lai@acer.com.tw

And,

Acer Europe SA

Via Cantonale, Centro Galleria 2 6928 Manno Switzerland

Hereby declare that:

Product: Notebook Computer

Trade Name: Acer

Model Number: MS2296

Machine Type: AO753 series

Is compliant with the essential requirements and other relevant provisions of the following EC directives, and that all the necessary steps have been taken and are in force to assure that production units of the same product will continue comply with the requirements.

EMC Directive 2004/108/EC as attested by conformity with the following harmonized standards:

- EN55022, AS/NZS CISPR22, Class B
- EN55024
- EN61000-3-2 Class D
- EN61000-3-3

Low Voltage Directive 2006/95/EC as attested by conformity with the following harmonized standard:

- EN60950-1

Council Decision 98/482/EC (CTR21):

(Applicable to product with pan- European single terminal connection to the Public Switched Telephone Network (PSTN).)

RoHS Directive 2002/95/EC on the Restriction of the Use of certain Hazardous Substances in Electrical and Electronic Equipment



- The maximum concentration values of the restricted substances by weight in homogenous material are:

Lead	0.1%	Polybrominated Biphenyls (PBB's)	0.1%
Mercury	0.1%	Polybrominated Diphenyl Ethers (PBDE's)	0.1%
Hexavalent Chromium	0.1%	Cadmium	0.01%

Directive 2009/125/EC with regard to establishing a framework for the setting of ecodesign requirements for energy-related product.

R&TTE Directive 1999/5/EC as attested by conformity with the following harmonized standard:

- Article 3.1(a) Health and Safety
 - EN60950-1
 - EN62311
- Article 3.1(b) EMC
 - EN301 489-1
 - EN301 489-3 (Applicable to non-bluetooth wireless keyboard mouse set).
 - EN301 489-7
 - EN301 489-17
 - EN301 489-24
- Article 3.2 Spectrum Usages
 - EN300 440-2 (Applicable to non-bluetooth wireless keyboard mouse set).
 - EN300 328
 - EN301 511
 - EN301 893 (Applicable to 5GHz high performance RLAN).
 - EN301 908-1
 - EN301 908-2

Year to begin affixing CE marking 2010.

Easy Lai

Easy Lai /Manager
Regulation Center, Acer Inc.

Apr. 30, 2010

Date

První kroky...

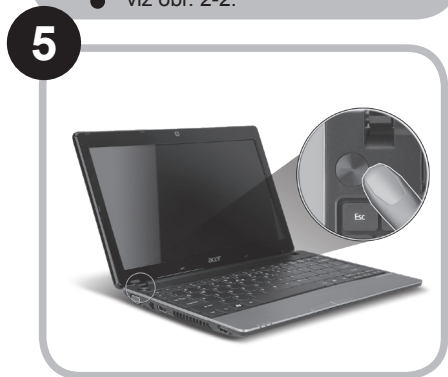
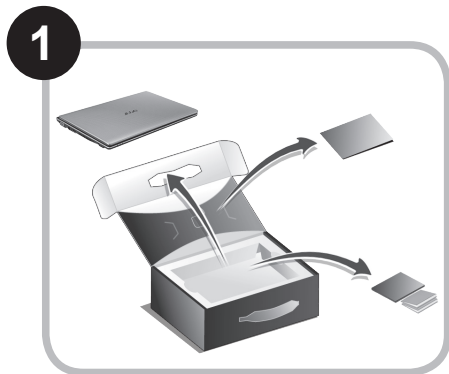

Ilustrace jsou pouze orientační. Skutečná specifikace produktu se může lišit.

Stručné pokyny

Děkujeme vám, že jste si k uspokojení svých potřeb v oblasti přenosných počítačů vybrali notebook Acer.

Uživatelské příručky

Abychom vám při používání notebooku Acer pomohli, vytvořili jsme pro vás sadu příruček*:

Stručná příručka vám pomůže při úvodním nastavení počítače.

Další informace o tom, jak můžete pomocí počítače zvýšit svou produktivitu, naleznete v příručce AcerSystem User Guide. Tato příručka obsahuje podrobné informace týkající se například systémových nástrojů, obnovování dat, možností rozšíření a odstraňování potíží. Dále obsahuje záruční informace, informace týkající se všeobecných předpisů a bezpečnostní upozornění k notebooku. Příručka je k dispozici ve formátu PDF (Portable Document Format) a je již uložena do notebooku.



Poznámka: K zobrazení tohoto souboru je vyžadován program Adobe Reader. Pokud v počítači není program Adobe Reader nainstalován, klepnutím na položku AcerSystem User Guide nejprve spustíte instalační program. Dokončete instalaci podle pokynů na obrazovce. Pokyny týkající se používání programu Adobe Reader jsou k dispozici v nabídce Nápověda a odborná pomoc.



*** DŮLEŽITÉ UPOZORNĚNÍ:** Upozorňujeme, že uvedené příručky, ať tištěné nebo elektronické, slouží pouze pro referenci a s výjimkou informací uvedených ve zvláštních informacích o záruce v AcerSystem User Guide nepředstavují žádná ujištění nebo záruky společnosti Acer v souvislosti s vámi zakoupeným produktem. Společnost Acer výslovně odmítá jakoukoli odpovědnost za chyby uvedené v těchto příručkách.

Konfigurace sítě

Tento průvodce vám pomůže konfigurovat nastavení sítě LAN nebo bezdrátové sítě, aby bylo možné se připojit k Internetu.

Nastavení připojení k síti LAN

Stačí připojit síťový kabel LAN do portu Ethernet (RJ-45). Umístění portu Ethernet naleznete na obrázku „**Pohled zprava**“ na straně 6.

Nastavení bezdrátového připojení

1. Stisknutím kláves <Fn> + <F3> otevřete správce komunikace. Zde můžete zapnout připojení Wi-Fi klepnutím na červené tlačítko vedle Wi-Fi.

Poznámka: Prostřednictvím správce komunikace jsou dostupné také možnosti 3G a Bluetooth. Komunikační zařízení se liší podle modelu.

2. Klepněte na ikonu  na hlavním panelu a vyberte přístupový bod bezdrátové sítě, k němuž se chcete připojit.



Vložení karty 3G SIM (pouze u vybraných modelů)

Vyjměte baterii a opatrně vložte kartu 3G SIM do patice pro kartu 3G SIM. Umístění patice pro kartu 3G SIM najdete na „**Pohled zezadu & Pohledu zespodu**“ na straně 6.

Seznámení s počítačem Aspire One

Po nastavení počítače podle pokynů znázorněných v části První kroky... vás seznámíme s vaším novým notebookem Acer.

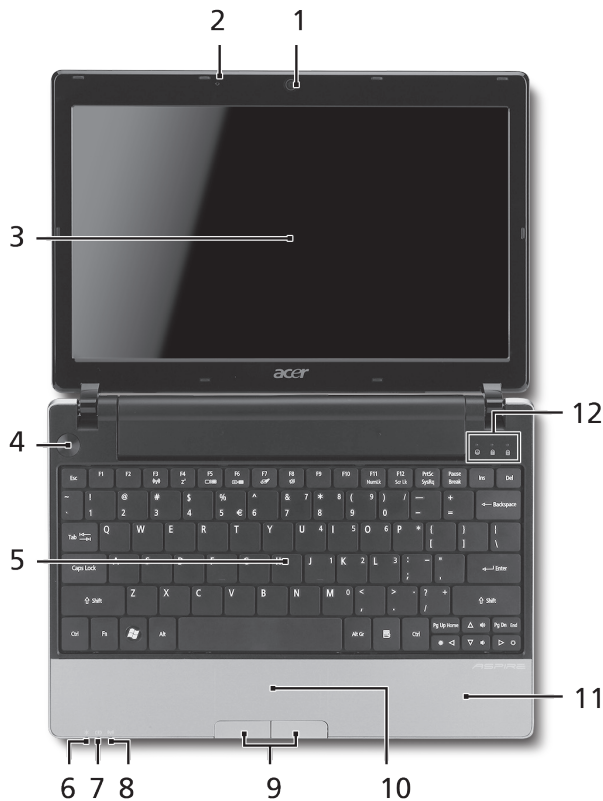

Pohled shora



#	Ikona	Položka	Popis						
1		Webová kamera Acer Crystal Eye	Webová kamera pro obrazovou komunikaci (Konfigurace se může lišit podle modelů).						
2		Mikrofon	Interní mikrofon pro nahrávání zvuku.						
3		Displej	Na displeji, označovaném také displej z tekutých krystalů (Liquid-Crystal Display; LCD), se zobrazuje grafický výstup počítače (Konfigurace se může lišit podle modelů).						
4		Tlačítko napájení	Slouží k zapnutí a vypnutí počítače.						
5		Klávesnice	Slouží k zadávání údajů do počítače.						
6		Indikátor napájení ¹	Indikuje stav napájení počítače.						
7		Indikátor baterie ¹	Indikuje stav baterie počítače. 1. Nabíjení: Při nabíjení baterie svítí indikátor jantarově. 2. Plně nabití: V režimu napájení ze sítě svítí indikátor modře.						
8		Indikátor komunikace ¹	Indikuje stav komunikace v bezdrátové síti LAN/3G. <table border="1" data-bbox="1070 628 1505 751"> <tbody> <tr> <td>Svítí modrá kontrolka</td> <td>Svítí oranžová kontrolka</td> <td>Nesvítí</td> </tr> <tr> <td>3G zapnuto/ Wi-Fi zapnuto</td> <td>3G vypnuto/ Wi-Fi zapnuto</td> <td>3G vypnuto/ Wi-Fi vypnuto</td> </tr> </tbody> </table>	Svítí modrá kontrolka	Svítí oranžová kontrolka	Nesvítí	3G zapnuto/ Wi-Fi zapnuto	3G vypnuto/ Wi-Fi zapnuto	3G vypnuto/ Wi-Fi vypnuto
Svítí modrá kontrolka	Svítí oranžová kontrolka	Nesvítí							
3G zapnuto/ Wi-Fi zapnuto	3G vypnuto/ Wi-Fi zapnuto	3G vypnuto/ Wi-Fi vypnuto							
9		Tlačítka (levé a pravé)	Levé a pravé tlačítko funguje jako levé a pravé tlačítko myši.						
10		Touchpad	Polohovací zařízení citlivé na dotek, které má podobnou funkci jako počítačová myš.						
11		Podložka ruky	Oblast k pohodlnému opření rukou při používání počítače.						
12		Indikátor HDD	Svítí, pokud je aktivní pevný disk.						
		NumLk	Svítí při aktivaci funkce NumLk.						
		Caps Lock	Svítí při aktivaci funkce Caps Lock.						

1. Stavové indikátory na předním panelu jsou viditelné i po zavření víka počítače.

Pohled na zavřenou přední stranu





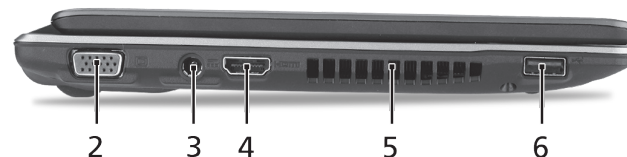

#	Ikona	Položka	Popis
1		Stavové indikátory	Diody LED (Light-Emitting Diodes; LED), které se rozsvěčují a informují o stavu funkcí a součástí počítače.

Pohled zleva





2		Port externího zobrazovacího zařízení (VGA)	Umožňuje připojení zobrazovacího zařízení (například externího monitoru nebo projektoru LCD).
3		Napájecí konektor	Zajišťuje připojení k síťovému adaptéru.
4	HDMI	Port HDMI	Podporuje připojení digitálního videa ve vysokém rozlišení.
5		Ventilační otvory	Umožňují chlazení počítače i při dlouhodobém používání.
6		Port USB 2.0	Umožňuje připojení zařízení s rozhraním USB 2.0 (například myš nebo fotoaparát USB).



Pohled zprava

#	Ikona	Položka	Popis
7		Čtečka karet Více v 1	Podporuje karty Secure Digital (SD), MultiMediaCard (MMC), Memory Stick (MS), Memory Stick PRO (MS PRO) a xD-Picture Card (xD). Poznámka: Stisknutím vyjměte nebo vložte kartu. V jednom okamžiku lze použít jen jednu kartu.
8		Konektor pro vstup mikrofonu	Slouží k připojení vstupů z externího mikrofonu.
		Konektor pro připojení sluchátek, reproduktorů nebo zvukového výstupu s podporou rozhraní S/PDIF	Slouží k připojení vnějších výstupních zvukových zařízení (například reproduktorů nebo sluchátek).
9		Port USB 2.0	Umožňuje připojení zařízení s rozhraním USB 2.0 (například myš USB).
10		Patice pro zámek Kensington	Umožňuje připojení počítačového bezpečnostního zámku kompatibilního s typem Kensington.
11		Port Ethernet (RJ-45)	Umožňuje připojení k síti Ethernet 10/100/1000.

Pohled zezadu & Pohled zespodu

12		Pozice pro baterii	Zde je uložena baterie počítače.
13		Uvolňovací západka baterie	Uvolňuje baterii k vyjmutí.
14		Pozice pro pevný disk	Zde je uložen pevný disk počítače (zajištěný šroubem).
		Pozice pro paměť	Zde je uložena hlavní paměť počítače.
15		Ventilační otvory a ventilátor	Umožňují chlazení počítače i při dlouhodobém používání. Poznámka: Nezakrývejte ani neblokujejte otvor ventilátoru.
16		Zámek baterie	Zamkne baterii na místě.

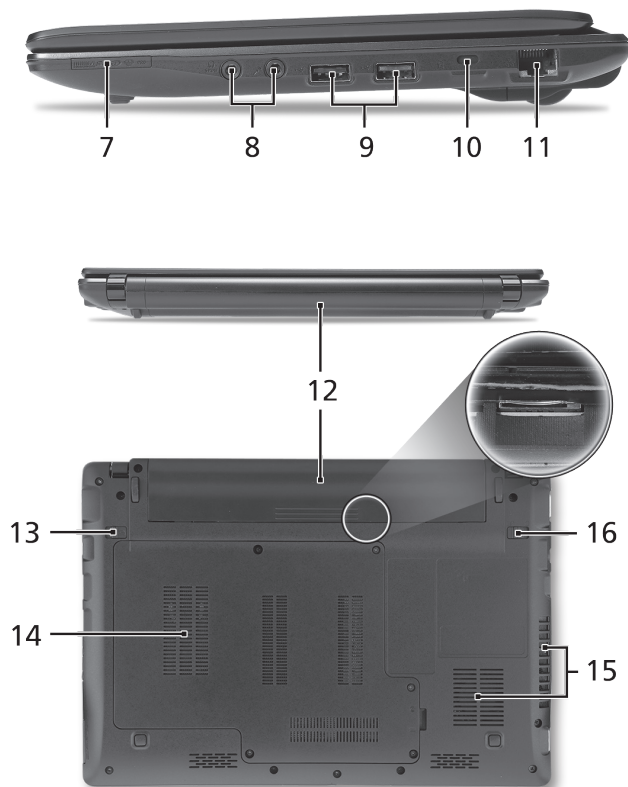

Prostředí

Teplota:

Provozní: 5°C až 35°C

Neprovozní: -20°C až 65°C

Vlhkost (nekondenzující):

Provozní: 20% až 80%

Neprovozní: 20% až 80%

Séria *ASPIRE* one

Stručná príručka

Prenosný počítač séria *Aspire One*

Číslo modelu: _____

Sériové číslo: _____

Dátum zakúpenia: _____

Miesto zakúpenia: _____

Federal Communications Commission

Declaration of Conformity

This device complies with Part 15 of the FCC Rules. Operation is subject to the following two conditions: (1) this device may not cause harmful interference, and (2) this device must accept any interference received, including interference that may cause undesired operation.

The following local Manufacturer / Importer is responsible for this declaration:

Product name:	Notebook PC
Brand:	Acer
Model number:	MS2296
Machine type:	<i>AO 753 series</i>
Name of Responsible Party:	Acer America Corporation
Address of responsible party:	333 West San Carlos St., San Jose CA 95110, U. S. A.
Contact person:	Acer Representative
Phone No.:	1-254-298-4000
Fax No.:	1-254-298-4147
April 30, 2010	

CE Declaration of Conformity

We,

Acer Incorporated

8F, 88, Sec. 1, Hsin Tai Wu Rd., Hsichih, Taipei Hsien 221, Taiwan

Contact Person: Mr. Easy Lai, e-mail:easy_lai@acer.com.tw



And,

Acer Europe SA

Via Cantonale, Centro Galleria 2 6928 Manno Switzerland

Hereby declare that:

Product: Notebook Computer

Trade Name: Acer

Model Number: MS2296

Machine Type: AO753 series

Is compliant with the essential requirements and other relevant provisions of the following EC directives, and that all the necessary steps have been taken and are in force to assure that production units of the same product will continue comply with the requirements.

EMC Directive 2004/108/EC as attested by conformity with the following harmonized standards:

- EN55022, AS/NZS CISPR22, Class B
- EN55024
- EN61000-3-2 Class D
- EN61000-3-3

Low Voltage Directive 2006/95/EC as attested by conformity with the following harmonized standard:

- EN60950-1

Council Decision 98/482/EC (CTR21):

(Applicable to product with pan- European single terminal connection to the Public Switched Telephone Network (PSTN).)

RoHS Directive 2002/95/EC on the Restriction of the Use of certain Hazardous Substances in Electrical and Electronic Equipment

- The maximum concentration values of the restricted substances by weight in homogenous material are:

Lead	0.1%	Polybrominated Biphenyls (PBB's)	0.1%
Mercury	0.1%	Polybrominated Diphenyl Ethers (PBDE's)	0.1%
Hexavalent Chromium	0.1%	Cadmium	0.01%

Directive 2009/125/EC with regard to establishing a framework for the setting of ecodesign requirements for energy-related product.

R&TTE Directive 1999/5/EC as attested by conformity with the following harmonized standard:

- Article 3.1(a) Health and Safety
 - EN60950-1
 - EN62311
- Article 3.1(b) EMC
 - EN301 489-1
 - EN301 489-3 (Applicable to non-bluetooth wireless keyboard mouse set).
 - EN301 489-7
 - EN301 489-17
 - EN301 489-24
- Article 3.2 Spectrum Usages
 - EN300 440-2 (Applicable to non-bluetooth wireless keyboard mouse set).
 - EN300 328
 - EN301 511
 - EN301 893 (Applicable to 5GHz high performance RLAN).
 - EN301 908-1
 - EN301 908-2

Year to begin affixing CE marking 2010.

Easy Lai

Easy Lai /Manager
Regulation Center, Acer Inc.

Apr. 30, 2010

Date

Práve začíname

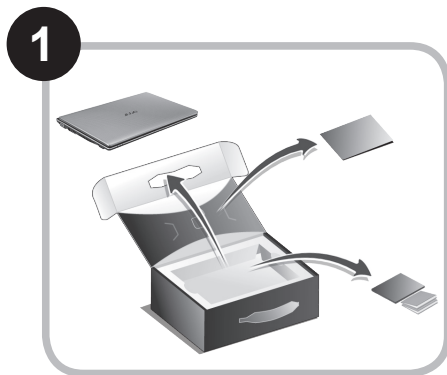

Ilustrácie sú len orientačné. Parametre aktuálneho výrobku môžu byť odlišné.

Hneď na úvod

Radi by sme vám poďakovali za rozvoj prenosných počítačov Acer – vašej voľby pre svoje mobilné počítačové potreby.

Vaše príručky

Pomôžeme vám s používaním prenosného počítača Acer – vytvorili sme kvôli tomu niekoľko príručiek*:

Najprv vám Stručná príručka pomôže začať s nastavením počítača.

Informácie o tom, ako vám počítač pomôže byť produktívnejší, nájdete v AcerSystem User Guide. Táto príručka obsahuje podrobné informácie o systémových programoch, obnove údajov, možnostiach rozšírenia a riešenie problémov. Okrem toho obsahuje informácie o záruke a všeobecné vyhlásenia k predpisom a bezpečnosti. Je dostupná vo formáte PDF a je umiestnená vo vašom prenosnom počítači.



Poznámka: Prezeranie súboru vyžaduje Adobe Reader. Ak na vašom počítači nie je Adobe Reader nainštalovaný, kliknutím na AcerSystem User Guide sa najprv spustí inštalácia programu Adobe Reader. Inštaláciu dokončíte podľa pokynov, ktoré uvidíte na obrazovke. Inštrukcie ako používať Adobe Reader nájdete v ponuke Pomocník a Podpora.



*** DÔLEŽITÁ POZNÁMKA:** Majte na pamäti, že všetky tu uvedené príručky, či už v tlačenej alebo elektronickej podobe, sú len orientačné a žiadne informácie, ktoré sú v nich uvedené, nenahrádzajú ani nereprezentujú záruku spoločnosti Acer týkajúcu sa zakúpeného výrobku, okrem výslovne uvedených informácií o záruke nachádzajúcich sa v dokumente AcerSystem User Guide. Spoločnosť Acer vyhlasuje, že nenesie žiadnu zodpovednosť za prípadné chyby v týchto príručkách.

Konfigurácia siete

Tento návod vám pomôže nakonfigurovať nastavenia siete LAN a bezdrôtovej siete, aby bolo možné pripojiť sa k internetu.

Nastavenie pripojenia k sieti LAN

Stačí zapojiť kábel siete LAN do portu Ethernet (RJ-45). Informácie o umiestnení portu siete Ethernet nájdete v časti „**Pohľad sprava**“ na strane 6.

Nastavenie bezdrôtového pripojenia

1. Stlačením klávesov <Fn> + <F3> otvoríte správcu komunikácie. Kliknutím na červené tlačidlo vedľa Wi-Fi môžete zapnúť pripojenie Wi-Fi.

Poznámka: Pripojenie k sieti 3G a Bluetooth je k dispozícii aj prostredníctvom správcu komunikácie. Komunikačné zariadenia sa môžu líšiť v závislosti od modelu.

2. Kliknite na ikonu v oznamovacej oblasti  a vyberte prístupový bod bezdrôtovej siete, ku ktorej sa chcete pripojiť.



Vloženie karty 3G SIM (len určité modely)

Vyberte batériu a opatrne vložte 3G SIM kartu do zásuvky pre 3G SIM kartu. Umiestnenie zásuvky pre 3G SIM kartu nájdete na obrázku „**Pohľad zozadu & Pohľad zdola**“ na strane 6.

Spoznajte *Aspire One*

Po nastavení počítača podľa časti Práve začíname, nám dovolíte, aby sme vás zoznámili s novým prenosným počítačom Acer.

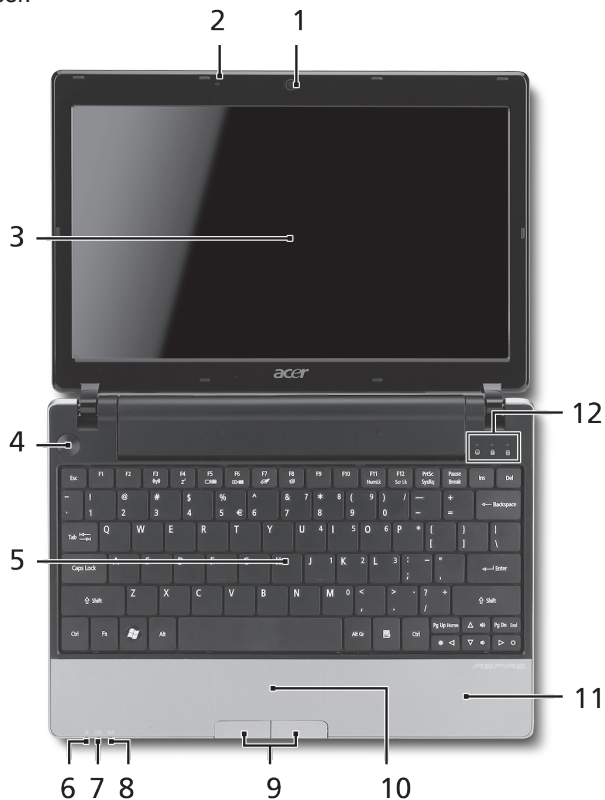

Pohľad zhora



#	Ikona	Položka	Popis						
1		Webkamera Acer Crystal Eye	Webová kamera na video komunikáciu (konfigurácia sa môže v závislosti od modelu líšiť).						
2		Mikrofón	Interný mikrofón na nahrávanie zvuku.						
3		Obrazovka	Nazýva sa tiež Liquid-Crystal Display (LCD), zobrazuje výstup z počítača (konfigurácia sa môže v závislosti od modelu líšiť).						
4		Tlačidlo Power (Zapnúť)	Zapína a vypína počítač.						
5		Klávesnica	Služi na zadávanie údajov do počítača.						
6		Kontrolka napájania ¹	Signalizuje stav napájania počítača.						
7		Kontrolka batérie ¹	Signalizuje stav batérie počítača. 1. Nabíjanie: Pri nabíjaní batérie svieti žltá. 2. Nabitie: V režime AC svieti modrá.						
8		Kontrolka komunikácie ¹	Signalizuje stav komunikácie siete 3G/ bezdrôtovej siete LAN.						
			<table border="1"> <thead> <tr> <th>Svieti modrá</th> <th>Svieti oranžová</th> <th>Nesvieti</th> </tr> </thead> <tbody> <tr> <td>3G zapnuté/WiFi zapnuté</td> <td>3G vypnuté/WiFi zapnuté</td> <td>3G vypnuté/WiFi vypnuté</td> </tr> </tbody> </table>	Svieti modrá	Svieti oranžová	Nesvieti	3G zapnuté/WiFi zapnuté	3G vypnuté/WiFi zapnuté	3G vypnuté/WiFi vypnuté
Svieti modrá	Svieti oranžová	Nesvieti							
3G zapnuté/WiFi zapnuté	3G vypnuté/WiFi zapnuté	3G vypnuté/WiFi vypnuté							
9		Tlačidlá na klikanie (ľavé a pravé)	Funkcia ľavého a pravého tlačidla je podobná ako funkcia ľavého a pravého tlačidla myši.						
10		Dotyková plocha	Zariadenie s citlivosťou na dotyk, ktoré funguje ako počítačová myš.						
11		Podložka rúk	Pohodlná opora rúk pri práci s počítačom.						
12		Kontrolka pevného disku	Svieti, keď je jednotka pevného disku aktívna.						
		Num Lock	Svieti, keď je Num Lock aktivovaný.						
		Caps Lock	Svieti, keď je Caps Lock aktivovaný.						

1. Kontrolky na prednom paneli sú viditeľné, aj keď je veko počítača zatvorené.

Pohľad spredu (zatvorený)

#	Ikona	Položka	Popis
1		Indikátory stavu	Diódy LED (Light-Emitting Diodes), ktoré svetlom indikujú stav funkcií počítača a jeho súčastí.

Pohľad zľava

2		Port externej obrazovky (VGA)	Pripojenie zobrazovacieho zariadenia (napr. externého monitora, LCD projektora).
3		Konektor vstupu jednosmerného napätia	Pripojenie adaptéra striedavého napätia.
4	HDMI	Port HDMI	Podporuje pripojenie digitálneho videa s vysokým rozlíšením.
5		Otvory na ventiláciu	Pomáha udržať pri dlhom používaní počítač chladný.
6		Port USB 2.0	Pripojenie zariadení cez rozhranie USB 2.0 (napr. USB myš, USB fotoaparát).

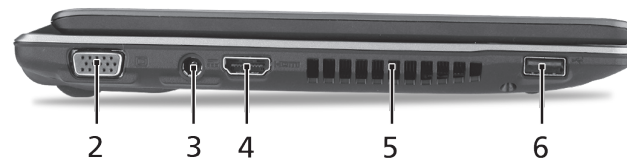

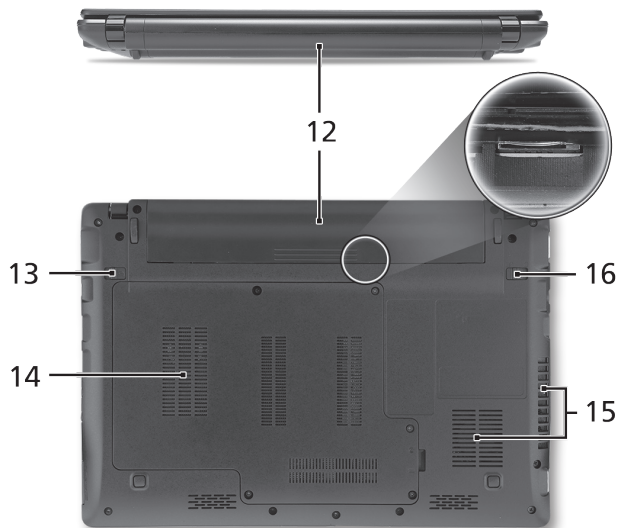
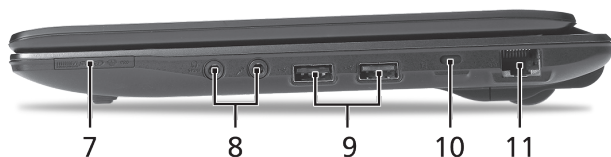

Pohľad sprava

#	Ikona	Položka	Popis
7		Čítačka kariet Multi-in-1	Podporuje karty Secure Digital (SD), MultiMediaCard (MMC), Memory Stick (MS), Memory Stick PRO (MS PRO) a xD-Picture Card (xD). Poznámka: Stlačením vyťahujete/vložíte kartu. Nie je možné pracovať s viacerými kartami naraz.
8		Konektor vstupu mikrofónu	Služi na vstup zvuku z externých mikrofónov.
		Výstup s podporou S/PDIF na slúchadlá/ reproduktor/externé zvukové zariadenie	Výstup zvuku do zvukových zariadení (napr. reproduktorov, slúchadiel).
9		Port USB 2.0	Pripojenie zariadení cez rozhranie USB 2.0 (napr. USB myš).
10		Zásuvka na zámok Kensington	Pripojenie počítačového bezpečnostného kľúča Kensington.
11		Port siete Ethernet (RJ-45)	Pripojenie k sieti Ethernet 10/100/1000.

Pohľad zozadu & Pohľad zdola

12		Jednotka batérie	Služi na uloženie batérie počítača.
13		Západka uvoľnenia batérie	Služi na uvoľnenie batérie pri jej vyberaní.
14		Jednotka pevného disku	Služi na uchytenie pevného disku počítača (zaistené skrutkou).
		Pozícia pre pamäť	Tu je uložená hlavná pamäť počítača.
15		Otvory na ventiláciu a ventilátor chladenia	Pomáha udržať pri dlhom používaní počítač chladný. Poznámka: Neuzatvárajte ani neupchávajújte otvor vetráka.
16		Zámok batérie	Uzamyká batériu na jej mieste.

Prostredie

Teplota:

Prevádzková: od 5°C do 35°C

Mimoprevádzková: od -20°C do 65°C

Vlhkosť (nekondenzačná):

Prevádzková: od 20% do 80%

Mimoprevádzková: od 20% do 80%

Seriya **ASPIRE** ONE

Hitri vodič

Prenosni računalnike serije *Aspire One*

Številka modela: _____

Serijska številka: _____

Datum nakupa: _____

Kraj nakupa: _____

Federal Communications Commission

Declaration of Conformity

This device complies with Part 15 of the FCC Rules. Operation is subject to the following two conditions: (1) this device may not cause harmful interference, and (2) this device must accept any interference received, including interference that may cause undesired operation.

The following local Manufacturer / Importer is responsible for this declaration:

Product name:	Notebook PC
Brand:	Acer
Model number:	MS2296
Machine type:	<i>AO 753 series</i>
Name of Responsible Party:	Acer America Corporation
Address of responsible party:	333 West San Carlos St., San Jose CA 95110, U. S. A.
Contact person:	Acer Representative
Phone No.:	1-254-298-4000
Fax No.:	1-254-298-4147
April 30, 2010	

CE Declaration of Conformity

We,

Acer Incorporated

8F, 88, Sec. 1, Hsin Tai Wu Rd., Hsichih, Taipei Hsien 221, Taiwan

Contact Person: Mr. Easy Lai, e-mail:easy_lai@acer.com.tw



And,

Acer Europe SA

Via Cantonale, Centro Galleria 2 6928 Manno Switzerland

Hereby declare that:

Product: Notebook Computer

Trade Name: Acer

Model Number: MS2296

Machine Type: AO753 series

Is compliant with the essential requirements and other relevant provisions of the following EC directives, and that all the necessary steps have been taken and are in force to assure that production units of the same product will continue comply with the requirements.

EMC Directive 2004/108/EC as attested by conformity with the following harmonized standards:

- EN55022, AS/NZS CISPR22, Class B
- EN55024
- EN61000-3-2 Class D
- EN61000-3-3

Low Voltage Directive 2006/95/EC as attested by conformity with the following harmonized standard:

- EN60950-1

Council Decision 98/482/EC (CTR21):

(Applicable to product with pan- European single terminal connection to the Public Switched Telephone Network (PSTN).)

RoHS Directive 2002/95/EC on the Restriction of the Use of certain Hazardous Substances in Electrical and Electronic Equipment

- The maximum concentration values of the restricted substances by weight in homogenous material are:

Lead	0.1%	Polybrominated Biphenyls (PBB's)	0.1%
Mercury	0.1%	Polybrominated Diphenyl Ethers (PBDE's)	0.1%
Hexavalent Chromium	0.1%	Cadmium	0.01%

Directive 2009/125/EC with regard to establishing a framework for the setting of ecodesign requirements for energy-related product.

R&TTE Directive 1999/5/EC as attested by conformity with the following harmonized standard:

- Article 3.1(a) Health and Safety
 - EN60950-1
 - EN62311
- Article 3.1(b) EMC
 - EN301 489-1
 - EN301 489-3 (Applicable to non-bluetooth wireless keyboard mouse set).
 - EN301 489-7
 - EN301 489-17
 - EN301 489-24
- Article 3.2 Spectrum Usages
 - EN300 440-2 (Applicable to non-bluetooth wireless keyboard mouse set).
 - EN300 328
 - EN301 511
 - EN301 893 (Applicable to 5GHz high performance RLAN).
 - EN301 908-1
 - EN301 908-2

Year to begin affixing CE marking 2010.

Easy Lai

Easy Lai /Manager
Regulation Center, Acer Inc.

Apr. 30, 2010

Date

Za začetek

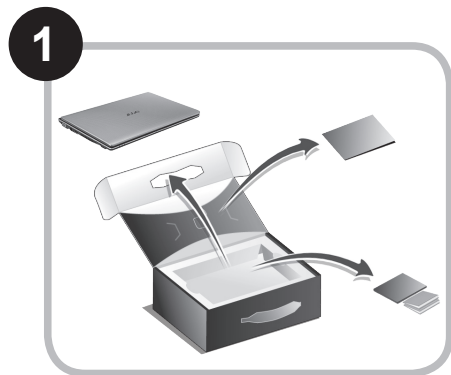

Ilustracije so le del splošnih napotkov. Dejanski tehnični podatki izdelka so lahko drugačni.

Začnimo pri začetku

Želimo se vam zahvaliti, ker ste za zadovoljevanje prenosnih računalniških potreb izbrali prenosnik Acer.

Vaša navodila

Za pomoč pri uporabi vašega prenosnika Acer smo izdelali paket navodil*:

Hitri vodič vam pomaga pri nastavljanju vašega računalnika.

Za več informacije o tem kako vam lahko računalnik pomaga postati bolj produktive, prosimo glejte na AcerSystem User Guide. Ta navodila vsebujejo podrobne informacije o sistemskih pripomočkih, obnovi podatkov, možnostih razširitve in odpravljanju težav. Poleg tega vsebuje garancijske informacije in splošne uredbe in varnostna obvestila za vaš prenosnik. Navodila so na voljo v obliki prenosnega dokumenta (PDF) in so naložena na vaš prenosnik.



Opomba: Za pregledovanje datoteke potrebujete Adobe Reader. Če Adobe Reader ni nameščen na računalnik se bo zagnal namestitveni program Adobe Reader, ko kliknete na AcerSystem User Guide. Za zaključek postopka sledite navodilom na zaslonu. Za navodila o uporabi Adobe Reader, odprite meni Pomoč in podpora.



*** POMEMBNA OPOMBA:** Prosimo pomnite, da so smernice, ki so omenjene tukaj bodisi v tiskani ali v elektronski obliki, le v informacijo in da njihova vsebina, razen če je to navedeno v posebnih informacijah o garanciji, vključenih v AcerSystem User Guide, v nobenem primeru ne predstavlja garancija ali jamstev s strani podjetja Acer glede izdelka, ki ste ga kupili. Acer izrecno zavrača vsakršno odgovornost za napake iz priročnikov.

Konfiguracija omrežja

Ta vodič vam bo pomagal konfigurirati nastavitve vašega LAN in brezžičnega omrežja, da bi se lahko povezali z internetom.

Vzpostavitev povezave preko LAN

Kabel LAN vključite v vrata za ethernet (RJ-45). Glejte naslov „**Pogled iz desne strani**“ na strani 6 za lokacijo vrat ethernet.

Nastavitev brezžične povezave

1. Za dostop do upravitelja komunikacijskih nastavitvev pritisnite <Fn> + <F3>. V tem upravitelju lahko povezavo WLAN vključite s klikom na rdeči gumb ob zadevni povezavi.

Opomba: V upravitelju komunikacijskih storitev lahko dostopate tudi do nastavitvev za povezave 3G in Bluetooth. Komunikacijske naprave se lahko razlikujejo glede na model vašega računalnika.

2. Kliknite na ikono  v sistemski vrstici in izberite brezžično točko dostopa, s katero se želite povezati.

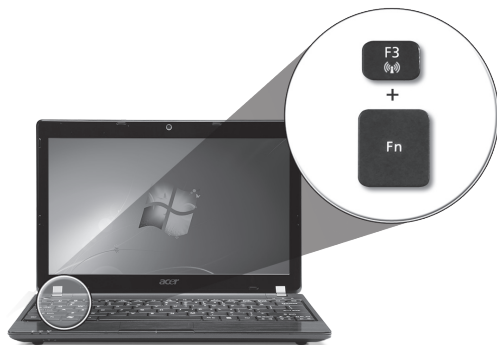

Vstavljanje kartice 3G SIM (le za določene modele)

Odstranite baterijo in v režo za kartice 3G SIM previdno vstavite kartico 3G SIM. Glejte naslov to „**Pogled od zadaj in spodaj**“ na strani 6, da bi našli režo za kartice 3G SIM.

Izlet po *Aspire One*

Ko ste nastavili računalnik, kot je prikazano v oddelku Za začetek, naj vam predstavimo vaš prenosnik Acer.

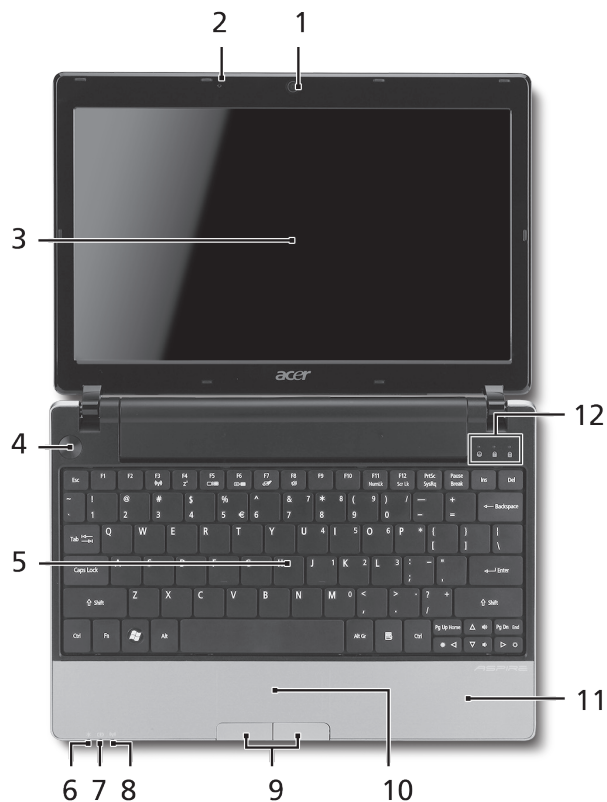

Pogled od zgoraj



#	Ikona	Predmet	Opis						
1		Integrirana spletna kamera Acer Crystal Eye	Spletna kamera za video komunikacijo (konfiguracija je za različne modele različna).						
2		Mikrofon	Notranji mikrofon za snemanje zvoka.						
3		Zaslon	Takoimenovani zaslon s tekočimi kristali (LCD), prikazuje izhod vašega računalnika (konfiguracija je za različne modele različna).						
4		Tipka za vklop/izklop	Vklop in izklop računalnika.						
5		Tipkovnica	Za vnos podatkov v računalnik.						
6		Indikator stanja napajanja ¹	Označuje stanje napajanja računalnika.						
7		Indikator stanja baterije ¹	Označuje stanje baterije računalnika. 1. Polnjenje: Lučka sveti rumenkasto rjavo, ko se baterija polni. 2. V celoti napolnjena: V načinu AC lučka sveti modro.						
8		Indikator komunikacije ¹	Označuje stanje brezžične komunikacije LAN/3G.						
			<table border="1"> <thead> <tr> <th>Sveti modra luč</th> <th>Sveti oranžna luč</th> <th>Ne sveti</th> </tr> </thead> <tbody> <tr> <td>Vključen 3G/vključen WiFi</td> <td>Izključen 3G/vključen WiFi</td> <td>Izključen 3G/izključen WiFi</td> </tr> </tbody> </table>	Sveti modra luč	Sveti oranžna luč	Ne sveti	Vključen 3G/vključen WiFi	Izključen 3G/vključen WiFi	Izključen 3G/izključen WiFi
Sveti modra luč	Sveti oranžna luč	Ne sveti							
Vključen 3G/vključen WiFi	Izključen 3G/vključen WiFi	Izključen 3G/izključen WiFi							
9		Tipke (levo in desno)	Leva in desna tipka delujeta kot leva in desna tipka na miški.						
10		Sledilna plošča	Na dotik občutljiva naprava, ki deluje kot računalniška miška.						
11		Podpora za dlan	Udobna podpora za vaše roke, ko uporabljate računalnik.						
12		Indikator trdega diska	Označuje, ko je trdi disk aktiven.						
		Num Lock	Zasveti, ko je tipka Num Lock aktivirana.						
		Caps Lock	Zasveti, ko je tipka Caps Lock aktivirana.						

1. Indikatorji na sprednji plošči so vidni tudi, ko je pokrov računalnika zaprt.

Zaprt pogled od spredaj

#	Ikona	Predmet	Opis
1		Indikatorji stanja	Diode (LED), ki zasvetijo, da prikažejo stanje funkcij in komponent računalnika.

Pogled iz leve strani

2		Priključek za zunanji zaslon (VGA)	Priključitev na prikazovalno napravo (npr. zunanji monitor, projektor LCD).
3		Priključek napajalnika	Priključek na AC napajalnik.
4	HDMI	Vhod HDMI	Podpira priključke za visokoločljivostni digitalni video.
5		Reže za prezračevanje	Omogočajo, da računalnik ostane hladen tudi po dolgotrajni uporabi.
6		Vrata USB 2.0	Priključek za naprave USB 2.0 (npr., USB miška, USB fotoaparati).

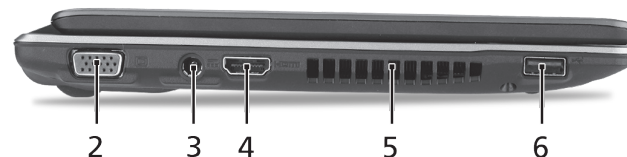

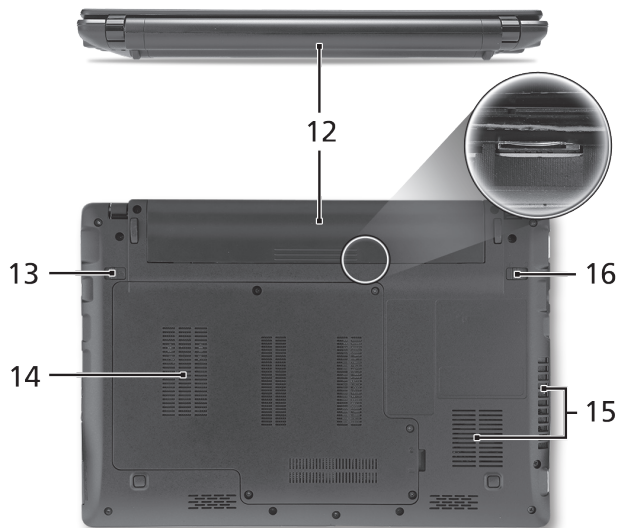
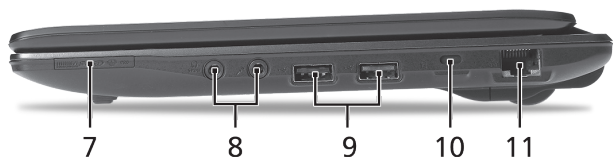

Pogled iz desne strani

#	Ikona	Predmet	Opis
7		Čitalec kartic več-v-1	Za kratice Secure Digital (SD), MultiMediaCard (MMC), Memory Stick (MS), Memory Stick Pro (MS PRO), in xD Picture Card (xD). Opomba: Pritisnite, da bi odstranili/vstavili kartico. Naenkrat lahko uporabljate le eno kartico.
8		Vtičnica za mikrofonski Vhod za slušalke/ zvočnike/naprave s podporo S/PDIF	Sprejema vhode iz zunanjih mikrofonov. Priključek za avdio naprave (npr. zvočniki, slušalke).
9		Vrata USB 2.0	Priključek za naprave USB 2.0 (npr. USB miška).
10		Reža za zaklep Kensington	Priključek za Kensington združljivo računalniško ključavnico.
11		Priključek Ethernet (RJ-45)	Priključek na omrežja Ethernet 10/100/1000.

Pogled od zadaj in spodaj

12		Nosilec za baterijo	Hrani baterijo računalnika.
13		Zapah za sprostitev baterije	Sprostitev baterije za odstranjevanje.
14		Nosilec trdega diska	Hrani trdi disk računalnika (pričvrščeno z vijaki).
		Razdelek za pomnilnik	Hrani glavni spomin računalnika.
15		Reže za prezračevanje in hladilni ventilator	Omogočajo, da računalnik ostane hladen tudi po dolgotrajni uporabi. Opomba: Odprtine ventilatorja ne prekrivajte ali zapirajte.
16		Zaklep za baterijo	Zaklene baterijo na mesto.

Okolje

Temperatura:

Delovanje: 5°C do 35°C

Mirovanje: -20°C do 65°C

Vlažnost (brez kondenza):

Delovanje: 20% do 80%

Mirovanje: 20% do 80%

ASPIRE ONE serija

Kratki vodič

Aspire One serije prijenosno osobno računalo

Broj modela: _____

Serijski broj: _____

Datum kupovine: _____

Mjesto kupnje: _____

Federal Communications Commission

Declaration of Conformity

This device complies with Part 15 of the FCC Rules. Operation is subject to the following two conditions: (1) this device may not cause harmful interference, and (2) this device must accept any interference received, including interference that may cause undesired operation.

The following local Manufacturer / Importer is responsible for this declaration:

Product name:	Notebook PC
Brand:	Acer
Model number:	MS2296
Machine type:	<i>AO 753 series</i>
Name of Responsible Party:	Acer America Corporation
Address of responsible party:	333 West San Carlos St., San Jose CA 95110, U. S. A.
Contact person:	Acer Representative
Phone No.:	1-254-298-4000
Fax No.:	1-254-298-4147
April 30, 2010	

CE Declaration of Conformity

We,

Acer Incorporated

8F, 88, Sec. 1, Hsin Tai Wu Rd., Hsichih, Taipei Hsien 221, Taiwan

Contact Person: Mr. Easy Lai, e-mail:easy_lai@acer.com.tw

And,

Acer Europe SA

Via Cantonale, Centro Galleria 2 6928 Manno Switzerland

Hereby declare that:

Product: Notebook Computer

Trade Name: Acer

Model Number: MS2296

Machine Type: AO753 series

Is compliant with the essential requirements and other relevant provisions of the following EC directives, and that all the necessary steps have been taken and are in force to assure that production units of the same product will continue comply with the requirements.

EMC Directive 2004/108/EC as attested by conformity with the following harmonized standards:

- EN55022, AS/NZS CISPR22, Class B
- EN55024
- EN61000-3-2 Class D
- EN61000-3-3

Low Voltage Directive 2006/95/EC as attested by conformity with the following harmonized standard:

- EN60950-1

Council Decision 98/482/EC (CTR21):

(Applicable to product with pan- European single terminal connection to the Public Switched Telephone Network (PSTN).)

RoHS Directive 2002/95/EC on the Restriction of the Use of certain Hazardous Substances in Electrical and Electronic Equipment



- The maximum concentration values of the restricted substances by weight in homogenous material are:

Lead	0.1%	Polybrominated Biphenyls (PBB's)	0.1%
Mercury	0.1%	Polybrominated Diphenyl Ethers (PBDE's)	0.1%
Hexavalent Chromium	0.1%	Cadmium	0.01%

Directive 2009/125/EC with regard to establishing a framework for the setting of ecodesign requirements for energy-related product.

R&TTE Directive 1999/5/EC as attested by conformity with the following harmonized standard:

- Article 3.1(a) Health and Safety
 - EN60950-1
 - EN62311
- Article 3.1(b) EMC
 - EN301 489-1
 - EN301 489-3 (Applicable to non-bluetooth wireless keyboard mouse set).
 - EN301 489-7
 - EN301 489-17
 - EN301 489-24
- Article 3.2 Spectrum Usages
 - EN300 440-2 (Applicable to non-bluetooth wireless keyboard mouse set).
 - EN300 328
 - EN301 511
 - EN301 893 (Applicable to 5GHz high performance RLAN).
 - EN301 908-1
 - EN301 908-2

Year to begin affixing CE marking 2010.

Easy Lai

Easy Lai /Manager
Regulation Center, Acer Inc.

Apr. 30, 2010

Date

Tek za početak

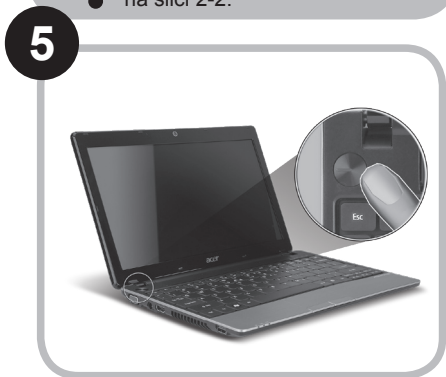
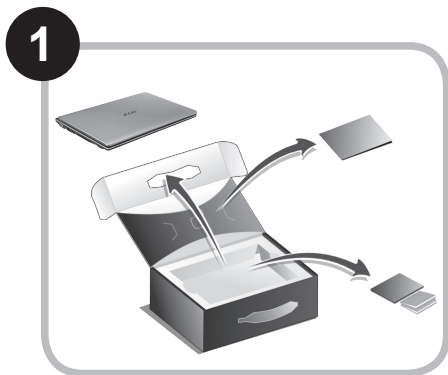

Slikovni prikazi služe samo za ilustraciju. Stvarne specifikacije proizvoda mogu varirati.

Prvo osnovne stvari

Željeli bismo vam zahvaliti na izboru Acer prijenosnog računala koje će vam poslužiti kamo god krenuli.

Vaši vodiči

Kako bismo vam pomogli pri uporabi vašeg Acer prijenosnog računala, pripremili smo skupinu vodiča*:

Na prvom mjestu, poster Kratki vodič pomaže pri početnim postupcima i postavljanju vašeg računala.

Za više informacija o tome kako vam vaše računalo može pomoći da budete produktivniji, molimo, pogledajte AcerSystem User Guide. Priručnik sadrži detaljne informacije o temama kao što su uslužni programi sustava, vraćanje podataka, opcije za proširivanje i rješavanje problema. Nadalje, sadrži informacije o jamstvima i osnovne obavijesti o propisima i sigurnosti za vaš prijenosnik. Priručnik je dostupan u Portable Document Formatu (PDF), a dolazi i snimljen na prijenosnik.



Napomena: Pregled dokumenta zahtijeva Adobe Reader. Ako Adobe Reader nije instaliran na vaše računalo, klik na AcerSystem User Guide najprije će pokrenuti program za instalaciju Adobe Readera. Slijedite upute na zaslonu da biste završili instalaciju. Za upute kako koristiti Adobe Reader, pristupite izborniku Pomoć i podrška.



*** VAŽNA NAPOMENA:** Molimo primite na znanje da su spomenuti priručnici, bilo u ispisanom ili elektronskom obliku, ovdje samo za vašu obavijest te da, osim spomenutog u izričitim jamstvenim informacijama sadržanim u AcerSystem User Guide, ništa sadržano u njima ne predstavlja Acer-ova jamstva ili uvjete vezane uz proizvod koji se kupili. Acer se izričito odriče bilo kakve odgovornosti za greške sadržane u priručnicima.

Konfiguracija mreže

Ovaj vodič pomoći će vam podesiti postavke vaše LAN i bežične mreže kako bi bilo moguće spajanje na internet.

Podešavanje LAN veze

Jednostavno uključite LAN kabel na ulaz Ethernet (RJ-45). Pogledajte "**Pogled s desne strane**" na stranici 6 kako bi uočili položaj Ethernet ulaza.

Podešavanje bežične veze

1. Pritisnite <Fn> + <F3> kako biste pristupili upravitelju komunikacija. Wi-Fi vezu moguće je uključiti klikom na crvenu tipku kraj oznake Wi-Fi.

Napomena: 3G i Bluetooth dostupni su preko upravitelja komunikacija. Konfiguracijski uređaji razlikuju se ovisno o modelu.

2. Kliknite na sličicu  u dijelu sustava i odaberite bežičnu pristupnu točku na koju se želite spojiti.

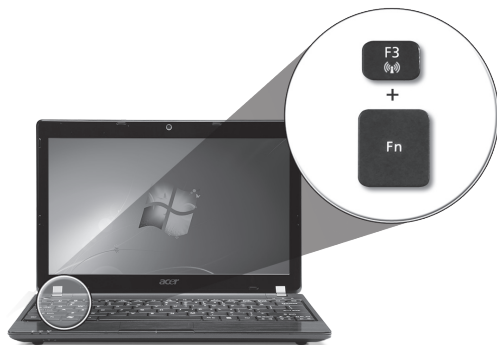

Umetanje 3G SIM kartice (samo za određene modele)

Uklonite bateriju i pažljivo umetnite 3G SIM karticu u utor za 3G SIM karticu. Pogledajte "**Pogled straga i odozdo**" na stranici 6 za lokaciju utora za 3G SIM karticu.

Upoznajte vaš *Aspire One*

Nakon podešavanja računala kako je prikazano u dijelu Na samom početku, dopustite nam kratki prikaz vašeg novog Acer prijenosnog računala.

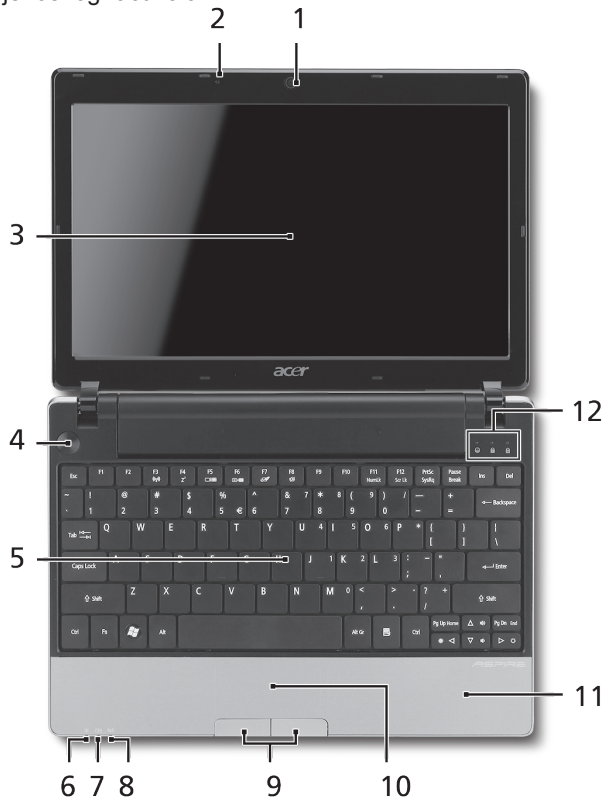

Pogled odozgo



#	Ikona	Stavka	Opis						
1		Acer Crystal Eye web kamera	Web kamera za video komunikaciju (Konfiguracija se može razlikovati ovisno o modelu).						
2		Mikrofon	Unutarnji mikrofon za snimanje zvuka.						
3		Zaslon prikaza	Također nazivan i Liquid-Crystal Display (LCD), prikazuje izlaz računala (Konfiguracija se može razlikovati ovisno o modelu).						
4		Tipka napajanja	Uključuje i isključuje računalo.						
5		Tipkovnica	Za unos podataka u vaše računalo.						
6		Indikator napajanja ¹	Pokazuje stanje napajanja računala.						
7		Indikator baterije ¹	Pokazuje stanje baterije računala. 1. Punjenje: Svijetli žuto kada se baterija puni. 2. Sasvim napunjeno: Svijetli plavo kada radi na izmjeničnom napajanju.						
8		Indikator komunikacije ¹	Pokazuje stanje 3G/bežične LAN komunikacije <table border="1" data-bbox="1070 585 1505 708"> <thead> <tr> <th>Plavo svjetlo uključeno</th> <th>Narančasto svjetlo uključeno</th> <th>Ne svijetli</th> </tr> </thead> <tbody> <tr> <td>3G uključeno/ WiFi uključeno</td> <td>3G isključeno/ Wi-Fi uključeno</td> <td>3G isključeno/ WiFi isključeno</td> </tr> </tbody> </table>	Plavo svjetlo uključeno	Narančasto svjetlo uključeno	Ne svijetli	3G uključeno/ WiFi uključeno	3G isključeno/ Wi-Fi uključeno	3G isključeno/ WiFi isključeno
Plavo svjetlo uključeno	Narančasto svjetlo uključeno	Ne svijetli							
3G uključeno/ WiFi uključeno	3G isključeno/ Wi-Fi uključeno	3G isključeno/ WiFi isključeno							
9		Tipke za klikanje (lijeva i desna)	Lijeva i desna tipka funkcionira kao lijeva i desna tipka miša.						
10		Dodirna ploča	Pokazivački uređaj osjetljiv na dodir koji funkcionira kao računalni miš.						
11		Oslonac za dlanove	Udobno područje koje pruža potporu rukama dok koristite računalo.						
12		HDD indikator	Pokazuje kada je pogon tvrdog diska aktivan.						
		Num Lock	Svijetli kada je Num Lock aktiviran.						
		Caps Lock	Svijetli kada je Caps Lock aktiviran.						

1. Indikatori na prednjoj ploči su vidljivi čak i kada je poklopac računala zatvoren.

Pogled srijeda izbliza

#	Ikona	Stavka	Opis
1		Indikatori stanja	Diode koje emitiraju svjetlo (LED) koje se uključuju kako bi pokazale stanje funkcija i komponenti računala.

Pogled s lijeve strane

2		Priključak vanjskog ekrana (VGA)	Povezuje se s uređajem za prikaz (primjerice vanjskim monitorom, LCD projektorom).
3		DC-in utičnica	Povezuje se s AC adapterom.
4	HDMI	HDMI ulaz	Podržava veze digitalnog videa visoke definicije.
5		Utori za prozračivanje	Omogućavaju rashlađivanje računala i prilikom dugotrajne uporabe.
6		USB 2.0 priključak	Povezuju se s USB 2.0 uređajima (npr. USB miš, USB kamera).

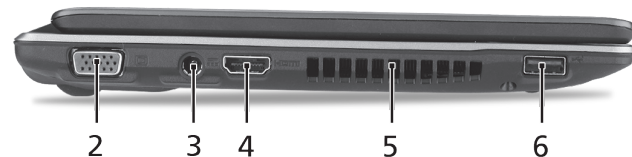

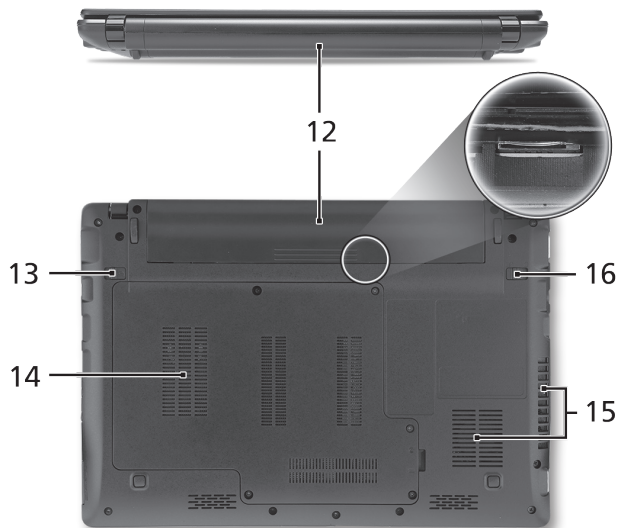
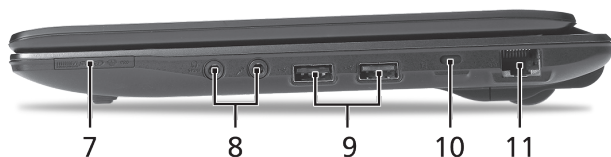

Pogled s desne strane

#	Ikona	Stavka	Opis
7		Više-u-1 čitač kartica	Prihvaća Secure Digital (SD), MultiMediaCard (MMC), Memory Stick (MS), Memory Stick PRO (MS PRO), xD-Picture Card (xD) kartice. Napomena: Gurnite za uklanjanje/postavljanje kartice. U bilo koje vrijeme samo jedna kartica može biti stavljena u pogon.
8		Utičnica ulaza za mikrofon	Prihvaća ulaze iz vanjskih mikrofona.
		Priključak za slušalice/zvučnike/line-out sa S/PDIF podrškom	Povezuje se sa line-out audio uređajima (npr. zvučnicima, slušalicama).
9		USB 2.0 priključak	Povezuje se s USB 2.0 uređajima (npr. USB miš).
10		Utor za Kensington bravu	Povezuje se s Kensington - kompatibilnom računalnom sigurnosnom bravom.
11		Ethernet (RJ-45) priključak	Povezuje se na Ethernet 10/100/1000-baziranu mrežu.

Pogled straga i odozdo

12		Prostor za bateriju	Sadrži baterijski komplet računala.
13		Bravica za oslobađanje baterije	Oslobađa bateriju radi uklanjanja.
14		Prostor za tvrdi disk	Sadrži tvrdi disk računala (učvršćen vijcima).
		Odjeljak za memoriju	Sadrži glavnu memoriju računala.
15		Utori za provjetravanje i ventilator za hlađenje	Omogućavaju rashlađivanje računala i prilikom dugotrajne uporabe. Napomena: Nemojte prekriti ili prepriječiti otvor ventilatora.
16		Brava baterije	Zaključava bateriju u njen položaj.

Okruženje

Temperatura:

Radna: 5°C do 35°C

Neradna: - 20°C do 65°C

Vlažnost (nekondenzirajuća):

Radna: 20% do 80%

Neradna: 20% do 80%

Seria **ASPIRE** one

Ghid rapid

Notebook seria *Aspire One*

Număr model: _____

Numărul seriei: _____

Data achiziției: _____

Locul achiziției: _____

Federal Communications Commission

Declaration of Conformity

This device complies with Part 15 of the FCC Rules. Operation is subject to the following two conditions: (1) this device may not cause harmful interference, and (2) this device must accept any interference received, including interference that may cause undesired operation.

The following local Manufacturer / Importer is responsible for this declaration:

Product name:	Notebook PC
Brand:	Acer
Model number:	MS2296
Machine type:	<i>AO 753 series</i>
Name of Responsible Party:	Acer America Corporation
Address of responsible party:	333 West San Carlos St., San Jose CA 95110, U. S. A.
Contact person:	Acer Representative
Phone No.:	1-254-298-4000
Fax No.:	1-254-298-4147
April 30, 2010	

CE Declaration of Conformity

We,

Acer Incorporated

8F, 88, Sec. 1, Hsin Tai Wu Rd., Hsichih, Taipei Hsien 221, Taiwan

Contact Person: Mr. Easy Lai, e-mail:easy_lai@acer.com.tw

And,

Acer Europe SA

Via Cantonale, Centro Galleria 2 6928 Manno Switzerland

Hereby declare that:

Product: Notebook Computer

Trade Name: Acer

Model Number: MS2296

Machine Type: AO753 series

Is compliant with the essential requirements and other relevant provisions of the following EC directives, and that all the necessary steps have been taken and are in force to assure that production units of the same product will continue comply with the requirements.

EMC Directive 2004/108/EC as attested by conformity with the following harmonized standards:

- EN55022, AS/NZS CISPR22, Class B
- EN55024
- EN61000-3-2 Class D
- EN61000-3-3

Low Voltage Directive 2006/95/EC as attested by conformity with the following harmonized standard:

- EN60950-1

Council Decision 98/482/EC (CTR21):

(Applicable to product with pan- European single terminal connection to the Public Switched Telephone Network (PSTN).)

RoHS Directive 2002/95/EC on the Restriction of the Use of certain Hazardous Substances in Electrical and Electronic Equipment



- The maximum concentration values of the restricted substances by weight in homogenous material are:

Lead	0.1%	Polybrominated Biphenyls (PBB's)	0.1%
Mercury	0.1%	Polybrominated Diphenyl Ethers (PBDE's)	0.1%
Hexavalent Chromium	0.1%	Cadmium	0.01%

Directive 2009/125/EC with regard to establishing a framework for the setting of ecodesign requirements for energy-related product.

R&TTE Directive 1999/5/EC as attested by conformity with the following harmonized standard:

- Article 3.1(a) Health and Safety
 - EN60950-1
 - EN62311
- Article 3.1(b) EMC
 - EN301 489-1
 - EN301 489-3 (Applicable to non-bluetooth wireless keyboard mouse set).
 - EN301 489-7
 - EN301 489-17
 - EN301 489-24
- Article 3.2 Spectrum Usages
 - EN300 440-2 (Applicable to non-bluetooth wireless keyboard mouse set).
 - EN300 328
 - EN301 511
 - EN301 893 (Applicable to 5GHz high performance RLAN).
 - EN301 908-1
 - EN301 908-2

Year to begin affixing CE marking 2010.

Easy Lai

Easy Lai /Manager
Regulation Center, Acer Inc.

Apr. 30, 2010

Date

Doar pentru prima utilizare

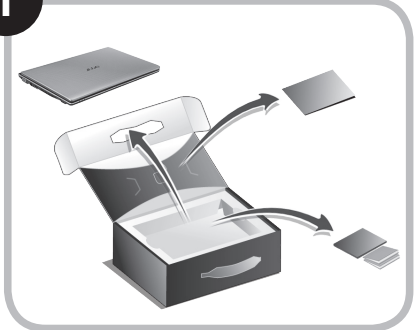
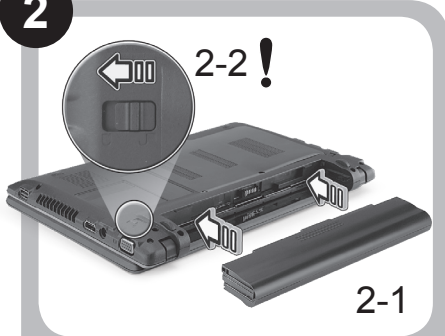

- 
- 

2-2!

2-1

! Asigurați-vă că bateria este bine fixată în locașul ei, conform imaginii 2-2.
- 

3-2

3-1
- 
- 

Esc
- 



Imaginile sunt doar orientative. Specificațiile reale ale produsului pot varia.

Înainte de toate

Dorim să vă mulțumim că ați ales un computer portabil Acer pentru a răspunde nevoilor dvs de procesare mobilă.

Ghidurile dumneavoastră

Pentru a vă ajuta să folosiți computerul portabil Acer, am conceput un set de ghiduri*:

Primul dintre acestea, Ghidul rapid vă ajută să începeți configurarea computerului.

Pentru mai multe informații privind modul în care computerul vă poate ajuta să fiți mai productiv, consultați AcerSystem User Guide. Acest ghid conține informații detaliate despre astfel de subiecte, precum utilitarele de sistem, recuperarea datelor, opțiunile de extensie și depanarea. În plus, acesta conține informații despre garanție, reglementări generale și note de siguranță pentru computerul dvs portabil. Este disponibil în Format de document portabil (PDF) și vine preîncărcat pe computerul dvs. portabil.



Notă: Vizualizarea fișierului necesită Adobe Reader. Dacă Adobe Reader nu este instalat pe computerul dvs., faceți clic pe AcerSystem User Guide și se va executa mai întâi programul de configurare Adobe Reader. Pentru a încheia instalarea, urmați instrucțiunile de pe ecran. Pentru instrucțiuni privind modul de utilizare a Adobe Reader, accesați meniul Ajutor și asistență.



*** NOTĂ IMPORTANTĂ:** Ghidurile menționate în acest document, în formă electronică sau pe suport hârtie, sunt doar pentru referința dvs. și, cu excepția celor furnizate în informațiile specifice de garanție din AcerSystem User Guide, niciunul dintre aceste ghiduri nu va constitui o reprezentare sau o garanție din partea Acer cu privire la produsul pe care l-ați achiziționat. Acer își declină în mod expres orice răspundere pentru greșelile conținute în ghiduri.

Configurație rețea

Acest ghid vă va ajuta să configurați rețeaua locală LAN și pe cea wireless, pentru a vă permite conectarea la Internet.

Configurarea conexiunii LAN

Conectați cablul de rețea LAN la priza Ethernet (RJ-45). Consultați "**Vedere din partea dreaptă**", la **pagina 6**, pentru a afla locația portului Ethernet.

Configurarea conexiunii wireless

1. Apăsați <Fn> + <F3> pentru a accesa managerul de comunicații. Aici puteți activa conexiunea Wi-Fi dând clic pe butonul roșu de lângă Wi-Fi.

Notă: Sunt, de asemenea, accesibile conexiunile 3G și Bluetooth prin intermediul managerului de comunicații. Dispozitivele de comunicație diferă în funcție de model.

2. Dați clic pe pictograma  din bara de sistem și selectați punctul de acces wireless la care doriți conectarea.

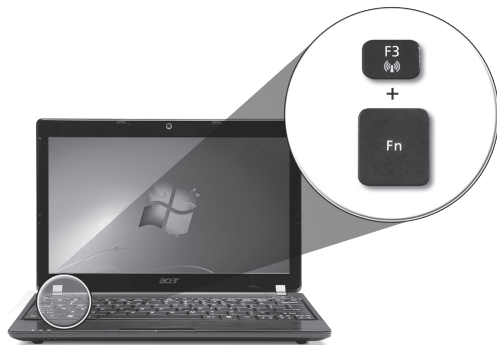

Introducerea unei cartele SIM 3G (doar pentru anumite modele)

Scoateți bateria și introduceți cu grijă o cartelă SIM 3G în slotul pentru cartele SIM 3G. Consultați "**Vedere din spate și din partea de jos**", la **pagina 6**, pentru a afla locația slotului pentru cartela SIM 3G.

Turul computerului dumneavoastră *Aspire One*

După configurarea computerului, așa cum se arată în secțiunea Doar pentru prima utilizare, permiteți-ne să vă prezentăm noul dumneavoastră computer portabil Acer.

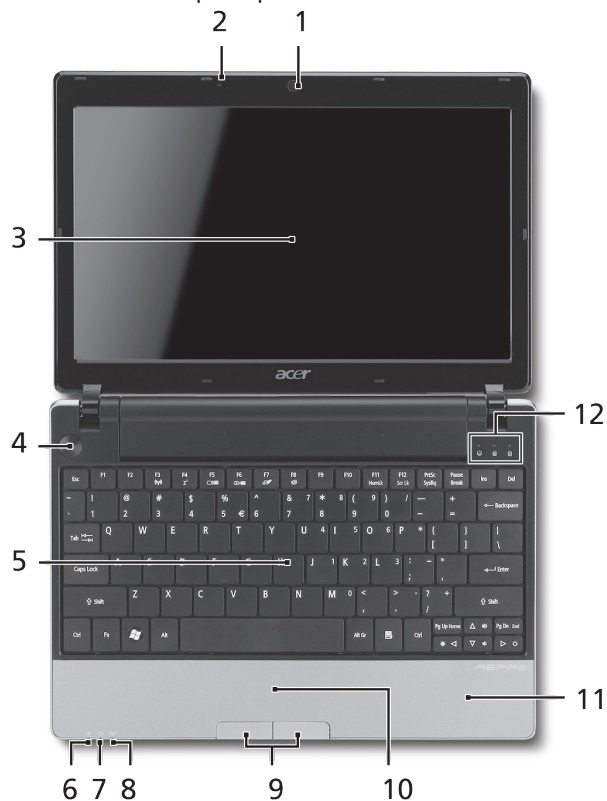

Vedere de sus



#	Pictogramă	Element	Descriere						
1		Cameră web Acer Crystal Eye	Cameră Web pentru comunicare video (configurația poate diferi în funcție de model).						
2		Microfon	Microfon intern pentru înregistrarea sunetului.						
3		Ecran de afișaj	Mai este numit și Afișaj cu cristale lichide (LCD) și afișează activitatea computerului (configurația poate diferi în funcție de model).						
4		Buton Pornire	Pornește și oprește computerul.						
5		Tastatură	Pentru introducerea datelor în computer.						
6		Indicator de alimentare ¹	Indică nivelul de alimentare al computerului.						
7		Indicator baterie ¹	Indică starea bateriei computerului. 1. Încărcare: Lumina este galbenă când acumulatorul se încarcă. 2. Complet încărcat: Lumina este albastră în modul c.a.						
8		Indicator comunicare ¹	Indică starea comunicării LAN wireless/3G. <table border="1" data-bbox="1133 560 1524 683"> <thead> <tr> <th>Indicator luminos albastru</th> <th>Indicator luminos portocaliu</th> <th>Stins</th> </tr> </thead> <tbody> <tr> <td>3G aprins/ WiFi aprins/ 3G aprins/ WiFi stins</td> <td>3G stins/ WiFi aprins</td> <td>3G stins/ WiFi stins</td> </tr> </tbody> </table>	Indicator luminos albastru	Indicator luminos portocaliu	Stins	3G aprins/ WiFi aprins/ 3G aprins/ WiFi stins	3G stins/ WiFi aprins	3G stins/ WiFi stins
Indicator luminos albastru	Indicator luminos portocaliu	Stins							
3G aprins/ WiFi aprins/ 3G aprins/ WiFi stins	3G stins/ WiFi aprins	3G stins/ WiFi stins							
9		Butoane clic (stânga și dreapta)	Butoanele stânga și dreapta funcționează ca butoanele stânga și dreapta ale mousei.						
10		Zona de atingere	Dispozitiv de indicare sensibil la atingere care funcționează ca un mouse de computer.						
11		Placă pentru sprijinirea palmei	Zonă confortabilă de sprijin pentru mână atunci când folosiți computerul.						
12		Indicator HDD	Indică atunci când unitatea de harddisc este activă.						
		Num Lock	Se aprinde când tasta Num Lock este activată.						
		Caps Lock	Se aprinde când tasta Caps Lock este activată.						

1. Indicatoarele de pe panoul frontal sunt vizibile chiar și atunci când capacul computerului este închis.

Vedere din față de aproape

#	Pictogramă	Element	Descriere
1		Indicatoare de stare	Diode electroluminiscente (LED-uri), care se aprind pentru a indica starea funcțiilor și componentelor computerului.

Vedere din stânga

2		Port pentru afișaj extern (VGA)	Conectează la un dispozitiv de afișare (de ex. monitor extern sau proiector LCD).
3		Mufă c.c. intrare	Conectează la un adaptor de c.a.
4	HDMI	Port HDMI	Acceptă conexiuni video digitale de înaltă definiție.
5		Orificii de aerisire	Permit computerului să rămână rece, chiar și după utilizarea prelungită.
6		Port USB 2.0	Conectează la dispozitivele USB 2.0 (de ex. maus USB, cameră USB).

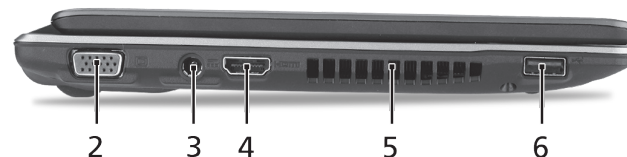

Vedere din dreapta

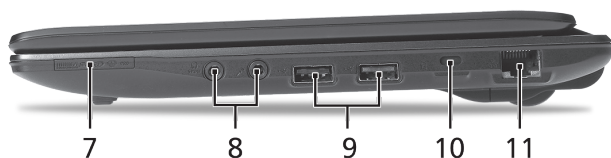

#	Pictogramă	Element	Descriere
7		Cititor de cartele multi-in-1	Acceptă cartele Secure Digital (SD), MultiMediaCard (MMC), Memory Stick (MS), Memory Stick PRO (MS PRO) și xD-Picture Card (xD). Notă: Apăsati pentru a extrage/a instala cartela. Nu poate fi citit decât o singură cartelă la un moment dat.
8		Mufă intrare microfon	Acceptă intrări de la microfoane externe.
		Port de căști/difuzor/ mufă de ieșire cu suport S/PDIF	Conectează la dispozitivele audio de ieșire (de ex. difuzoare, căști).
9		Port USB 2.0	Conectează la dispozitivele USB 2.0 (de ex. mouse USB).
10		Slot de blocare Kensington	Conectează la un dispozitiv de securitate pentru computer compatibil Kensington.
11		Port Ethernet (RJ-45)	Conectează la o rețea Ethernet 10/100/1000.

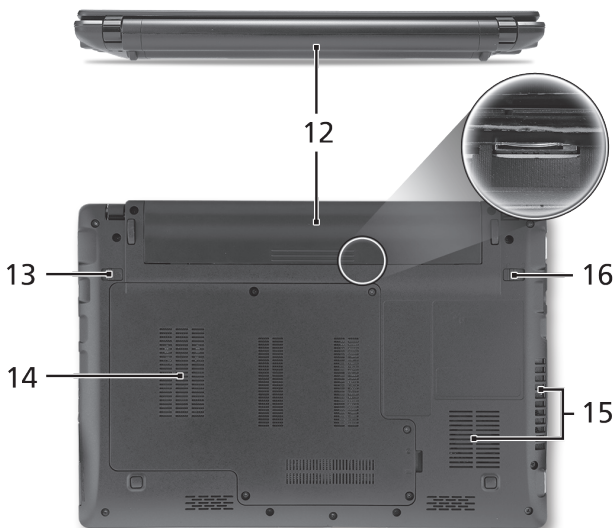

Vedere din spate și din partea de jos

12		Nișă pentru acumulator	Adăpostește setul de acumulatori ai computerului.
13		Zăvor de eliberare a acumulatorului.	Eliberează acumulatorul pentru a fi scos.
14		Nișă unitate de harddisc	Adăpostește unitatea harddisc a computerului (fixată cu șuruburi).
		Compartiment de memorie	Adăpostește memoria principală a computerului.
15		Orificii de ventilație și ventilator de răcire	Permit computerului să rămână rece, chiar și după utilizarea prelungită. Notă: Nu acoperiți și nu obstrucționați deschiderea ventilatorului.
16		Blocaj acumulator	Blochează acumulatorul în poziție.

Mediu

Temperatură:

Funcționare: 5°C - 35°C

Nefuncționare: -20°C - 65°C

Umiditate (fără condensare):

Funcționare: 20% - 80%

Nefuncționare: 20% - 80%

Серия **ASPIRE** ONE

Кратко ръководство

Серия *ASPIRE* one

© 2010 Всички права запазени

Кратко ръководство за Серия *Aspire One*
Първоначално издание: 04/2010

Серия *Aspire One* Персонален ноутбук

Номер на модела: _____

Сериен номер: _____

Дата на закупуване: _____

Място на покупка: _____

Federal Communications Commission

Declaration of Conformity

This device complies with Part 15 of the FCC Rules. Operation is subject to the following two conditions: (1) this device may not cause harmful interference, and (2) this device must accept any interference received, including interference that may cause undesired operation.

The following local Manufacturer / Importer is responsible for this declaration:

Product name:	Notebook PC
Brand:	Acer
Model number:	MS2296
Machine type:	<i>AO 753 series</i>
Name of Responsible Party:	Acer America Corporation
Address of responsible party:	333 West San Carlos St., San Jose CA 95110, U. S. A.
Contact person:	Acer Representative
Phone No.:	1-254-298-4000
Fax No.:	1-254-298-4147
April 30, 2010	

CE Declaration of Conformity

We,

Acer Incorporated
8F, 88, Sec. 1, Hsin Tai Wu Rd., Hsichih, Taipei Hsien 221, Taiwan
Contact Person: Mr. Easy Lai, e-mail:easy_lai@acer.com.tw



And,

Acer Europe SA
Via Cantonale, Centro Galleria 2 6928 Manno Switzerland

Hereby declare that:

Product: Notebook Computer
Trade Name: Acer
Model Number: MS2296
Machine Type: AO753 series

Is compliant with the essential requirements and other relevant provisions of the following EC directives, and that all the necessary steps have been taken and are in force to assure that production units of the same product will continue comply with the requirements.

EMC Directive 2004/108/EC as attested by conformity with the following harmonized standards:

- EN55022, AS/NZS CISPR22, Class B
- EN55024
- EN61000-3-2 Class D
- EN61000-3-3

Low Voltage Directive 2006/95/EC as attested by conformity with the following harmonized standard:

- EN60950-1

Council Decision 98/482/EC (CTR21):

(Applicable to product with pan- European single terminal connection to the Public Switched Telephone Network (PSTN).)

RoHS Directive 2002/95/EC on the Restriction of the Use of certain Hazardous Substances in Electrical and Electronic Equipment

- The maximum concentration values of the restricted substances by weight in homogenous material are:

Lead	0.1%	Polybrominated Biphenyls (PBB's)	0.1%
Mercury	0.1%	Polybrominated Diphenyl Ethers (PBDE's)	0.1%
Hexavalent Chromium	0.1%	Cadmium	0.01%

Directive 2009/125/EC with regard to establishing a framework for the setting of ecodesign requirements for energy-related product.

R&TTE Directive 1999/5/EC as attested by conformity with the following harmonized standard:

- Article 3.1(a) Health and Safety
 - EN60950-1
 - EN62311
- Article 3.1(b) EMC
 - EN301 489-1
 - EN301 489-3 (Applicable to non-bluetooth wireless keyboard mouse set).
 - EN301 489-7
 - EN301 489-17
 - EN301 489-24
- Article 3.2 Spectrum Usages
 - EN300 440-2 (Applicable to non-bluetooth wireless keyboard mouse set).
 - EN300 328
 - EN301 511
 - EN301 893 (Applicable to 5GHz high performance RLAN).
 - EN301 908-1
 - EN301 908-2

Year to begin affixing CE marking 2010.

Easy Lai

Easy Lai /Manager
Regulation Center, Acer Inc.

Apr. 30, 2010

Date

Като за начало

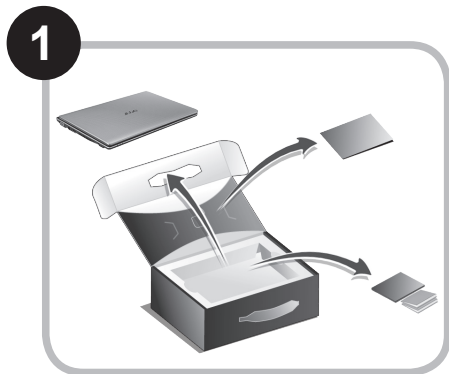

Илюстрации само за справка. Реалните технически характеристики на продукта може да се различават.

Преди всичко

Бихме желали да Ви благодарим, че сте избрали ноутбук на Acer за Вашите нужди в областта на мобилните компютри.

Вашите ръководства

За да Ви помогнем при употребата на Вашия ноутбук Acer, ние изготвихме следните ръководства*:

Първо, ръководството за бърз старт Ви помага с началните настройки на компютъра.

За повече информация за това как Вашият компютър може да Ви помогне да бъдете по-продуктивни, моля вижте ръководството на потребителя на AcerSystem (AcerSystem User Guide). То съдържа подробна информация за теми като системни инструменти, възстановяване на данни, опции за ъпгрейд и решаване на проблеми. В допълнение, то съдържа и гаранционна информация, както и основните наредби и бележки за безопасност, свързани с Вашия ноутбук. То е в PDF формат (Portable Document Format) и е предварително заредено на ноутбука Ви.



Бележка: За да отворите файла, Ви е нужен Adobe Reader. Ако Adobe Reader не е инсталиран на компютъра Ви, натиснете ръководството на потребителя AcerSystem (AcerSystem User Guide), първо ще се стартира инсталационната програма на Adobe Reader. Следвайте инструкциите на екрана, за да извършите инсталацията. За инструкции относно това как се използва Adobe Reader, отворете менюто "Помощ и поддръжка".



*** ВАЖНО СЪОБЩЕНИЕ:** Моля имайте предвид, че ръководствата отбелязани в този документ, независимо дали са напечатани или в електронна форма, са само за Ваша справка и с изключение на съдържанието, предоставено в специфичната гаранция на ръководството на потребителя на AcerSystem (AcerSystem User Guide), нищо друго от тези ръководства не представлява заверка или гаранция от Acer по отношение на продукта, който сте закупили. Acer изрично отказва да поеме отговорност за грешките, съдържащи се в тези ръководства.

Мрежова настройка

Тези указания ще ви помогнат да зададете настройките за вашата локална (LAN) или безжична мрежа, за да получите достъп до интернет.

Настройка на свързването към локална мрежа (LAN)

Просто пхнете LAN кабела в мрежовия (RJ-45) порт. Моля, вижте **"Изглед отдясно"** на **страница 6** за местоположението на Ethernet порта.

Конфигуриране на безжична връзка

1. Натиснете <Fn> + <F3>, за да влезете в диспечера за комуникации. Тук можете да включите Wi-Fi връзката като натиснете червения бутон до Wi-Fi.

Забележка: 3G и Bluetooth са също достъпни от диспечера за комуникации. Комуникационните устройства варират според модела.

2. Натиснете иконата  в системната област и изберете безжичната точка за достъп, към която желаете да се свържете.

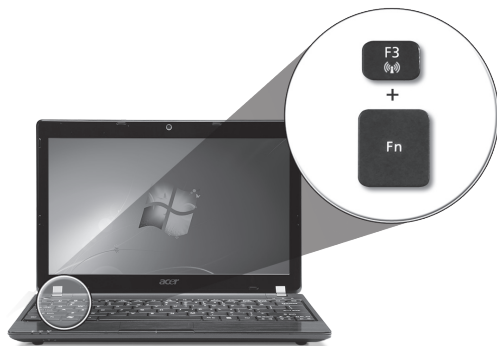

Поставете 3G SIM карта (само за някои модели)

Отстранете батерията и внимателно поставете 3G SIM карта в гнездото за 3G SIM карта. Моля, вижте **"Изглед отзад и отдолу"** на **страница 6** за местоположението на гнездото на 3G SIM картата.

Преглед на вашия *Aspire One* Изглед отгоре

След като настроите компютъра си, както е показано в раздела "Като за начало...", ще Ви покажем какво прави и какво има Вашият нов ноутбук Асер.

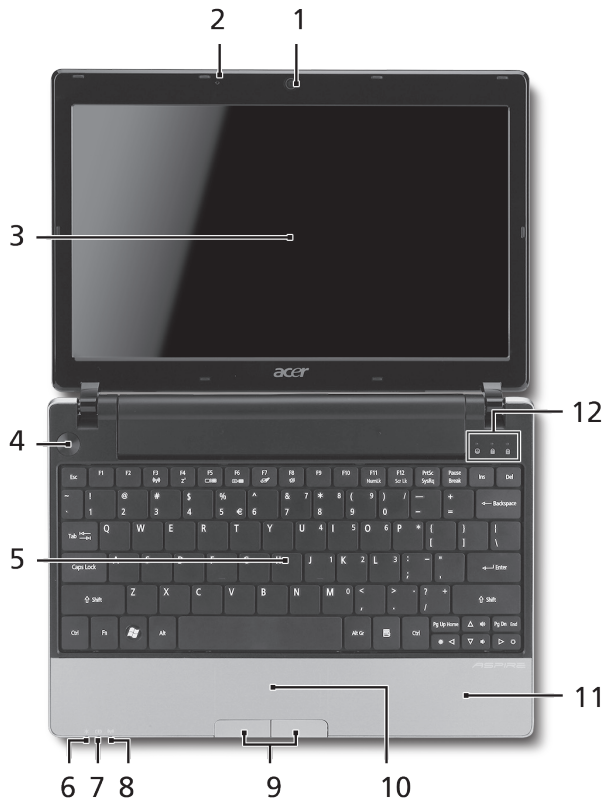



#	Икона	Обект	Описание						
1		Уеб камера Acer Crystal Eye	Уеб камера за видео комуникация (конфигурацията може да се различава в зависимост от моделите).						
2		Микрофон	Вътрешен микрофон за запис на звук.						
3		Дисплей	Нарича се още "Течнокристален дисплей" (LCD) и е екранът на компютъра (конфигурацията може да се различава в зависимост от моделите).						
4		Бутон за вкл./изкл.	С него компютърът се включва и изключва.						
5		Клавиатура	Служи за въвеждане на данни в компютъра Ви.						
6		Индикатор на захранването ¹	Показва статуса на захранване на компютъра.						
7		Индикатор за нивото на батерията ¹	Посочва статуса на батерията на компютъра. 1. Зареждане: Индикаторът свети в жълто, докато батерията се зарежда. 2. Напълно заредена: Индикаторът свети в синьо, когато сте в режим AC.						
8		Индикатор за комуникации ¹	Посочва статуса на 3G/безжичните LAN комуникации. <table border="1" data-bbox="1077 632 1508 722"> <tr> <td>Синя светлина вкл.</td> <td>Оранжева светлина вкл.</td> <td>Не свети</td> </tr> <tr> <td>3G вкл./WiFi вкл.</td> <td>3G изкл./WiFi вкл.</td> <td>3G изкл. / WiFi изкл.</td> </tr> </table>	Синя светлина вкл.	Оранжева светлина вкл.	Не свети	3G вкл./WiFi вкл.	3G изкл./WiFi вкл.	3G изкл. / WiFi изкл.
Синя светлина вкл.	Оранжева светлина вкл.	Не свети							
3G вкл./WiFi вкл.	3G изкл./WiFi вкл.	3G изкл. / WiFi изкл.							
9		Бутони за шракане (ляв и десен)	Левият и десният бутони функционират като ляв и десен бутон на мишка.						
10		Тъчпад	Чувствително на допир посочващо устройство, което функционира като компютърна мишка.						
11		Подложка за длани	Удобно място, на което да поставите ръцете си, когато използвате компютъра.						
12		Индикатор на твърдия диск	Посочва дали твърдият диск е активен.						
		Num Lock	Светва, когато активирате Num Lock.						
		Caps Lock	Светва, когато активирате Caps Lock.						

1. Индикаторите на предния панел остават видими дори, когато капакът на компютъра е затворен.

Преден изглед при затворен лаптоп

#	Икона	Обект	Описание
1		Статусни индикатори	Светодиоди (LED), които светят, за да показват статуса на функциите и компонентите на компютъра.

Изглед отляво

2		Порт за външен дисплей (VGA)	За връзка с дисплейно устройство (напр. външен монитор, LCD проектор).
3		Жак за DC вход	За връзка с AC адаптер.
4	HDMI	HDMI порт	Поддържа цифрови видео връзки с висока разделителна способност.
5		Вентилационни отвори	Позволява на компютъра да се охлажда дори и при продължителна употреба.
6		USB 2.0 порт	За връзка с USB 2.0 устройства (напр. USB мишки, USB камери).

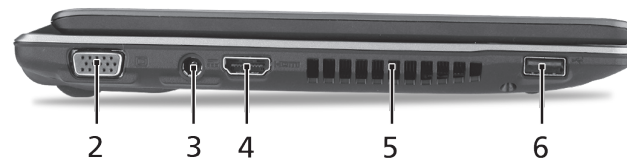

Изглед отдясно

#	Икона	Обект	Описание
7		Четец на карти Много-в-1	Чете Secure Digital (SD), MultiMediaCard (MMC), Memory Stick (MS), Memory Stick PRO (MS PRO) и xD-Picture Card (xD). Бележка: Натиснете, за да извадите/деинсталирате картата. Едновременно може да работи само една карта.
8		Жак за вход за микрофон	Приема входящ сигнал от външни микрофони.
		Жак за слушалки/ колони/изход с поддръжка на S/PDIF	За връзка с изходни аудио устройства (напр. високоговорители, слушалки).
9		USB 2.0 порт	За връзка с USB 2.0 устройства (напр. USB мишки).
10		Слот за заключващ механизъм Kensington	За връзка с Kensington-съвместим компютърен заключващ механизъм.
11		Порт за Ethernet (RJ-45)	За връзка с мрежа, базирана на Ethernet 10/100/1000.

Изглед отзад и отдолу

12		Отделение за батерии	Тук се поставя батерийният модул на компютъра.
13		Езиче за освобождаване на батерията	Освобождава батерията, за да можете да я извадите.
14		Отделение за твърдия диск	Тук се намира твърдият диск на компютъра (прикрепен с винтове).
		Отделение за памет	Тук се поставя главната памет на компютъра.
15		Вентилационни слотове и охлаждащ вентилатор	Позволява на компютъра да се охлажда дори и при продължителна употреба. Бележка: Не покривайте и не препречвайте отвора на вентилатора.
16		Придържач механизъм на батерията	Държи батерията на мястото ѝ.

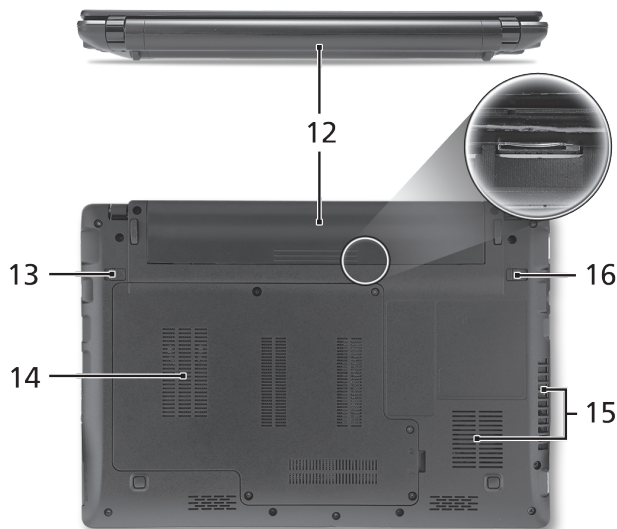
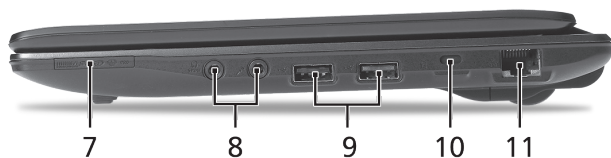

Работна среда

Температура:

За работа: 5°C до 35°C

За съхранение: -20°C до 65°C

Влажност (без кондензация):

За работа: 20% до 80%

За съхранение: 20% до 80%

ASPIRE ONE **seeria**

Lühijuhend

ASPIRE *one* seeria

© 2010 Kõik õigused kaitstud

Aspire One'i seeria lühijuhend
Originaalväljaanne: 04/2010

Aspire One 'i seeria sülearvuti

Mudeli number: _____

Seerianumber: _____

Ostukuupäev: _____

Ostukoht: _____

Federal Communications Commission

Declaration of Conformity

This device complies with Part 15 of the FCC Rules. Operation is subject to the following two conditions: (1) this device may not cause harmful interference, and (2) this device must accept any interference received, including interference that may cause undesired operation.

The following local Manufacturer / Importer is responsible for this declaration:

Product name:	Notebook PC
Brand:	Acer
Model number:	MS2296
Machine type:	<i>AO 753 series</i>
Name of Responsible Party:	Acer America Corporation
Address of responsible party:	333 West San Carlos St., San Jose CA 95110, U. S. A.
Contact person:	Acer Representative
Phone No.:	1-254-298-4000
Fax No.:	1-254-298-4147
April 30, 2010	

CE Declaration of Conformity

We,

Acer Incorporated

8F, 88, Sec. 1, Hsin Tai Wu Rd., Hsichih, Taipei Hsien 221, Taiwan

Contact Person: Mr. Easy Lai, e-mail:easy_lai@acer.com.tw

And,

Acer Europe SA

Via Cantonale, Centro Galleria 2 6928 Manno Switzerland

Hereby declare that:

Product: Notebook Computer

Trade Name: Acer

Model Number: MS2296

Machine Type: AO753 series

Is compliant with the essential requirements and other relevant provisions of the following EC directives, and that all the necessary steps have been taken and are in force to assure that production units of the same product will continue comply with the requirements.

EMC Directive 2004/108/EC as attested by conformity with the following harmonized standards:

- EN55022, AS/NZS CISPR22, Class B
- EN55024
- EN61000-3-2 Class D
- EN61000-3-3

Low Voltage Directive 2006/95/EC as attested by conformity with the following harmonized standard:

- EN60950-1

Council Decision 98/482/EC (CTR21):

(Applicable to product with pan- European single terminal connection to the Public Switched Telephone Network (PSTN).)

RoHS Directive 2002/95/EC on the Restriction of the Use of certain Hazardous Substances in Electrical and Electronic Equipment



- The maximum concentration values of the restricted substances by weight in homogenous material are:

Lead	0.1%	Polybrominated Biphenyls (PBB's)	0.1%
Mercury	0.1%	Polybrominated Diphenyl Ethers (PBDE's)	0.1%
Hexavalent Chromium	0.1%	Cadmium	0.01%

Directive 2009/125/EC with regard to establishing a framework for the setting of ecodesign requirements for energy-related product.

R&TTE Directive 1999/5/EC as attested by conformity with the following harmonized standard:

- Article 3.1(a) Health and Safety
 - EN60950-1
 - EN62311
- Article 3.1(b) EMC
 - EN301 489-1
 - EN301 489-3 (Applicable to non-bluetooth wireless keyboard mouse set).
 - EN301 489-7
 - EN301 489-17
 - EN301 489-24
- Article 3.2 Spectrum Usages
 - EN300 440-2 (Applicable to non-bluetooth wireless keyboard mouse set).
 - EN300 328
 - EN301 511
 - EN301 893 (Applicable to 5GHz high performance RLAN).
 - EN301 908-1
 - EN301 908-2

Year to begin affixing CE marking 2010.

Easy Lai

Easy Lai /Manager
Regulation Center, Acer Inc.

Apr. 30, 2010

Date

Alustuseks

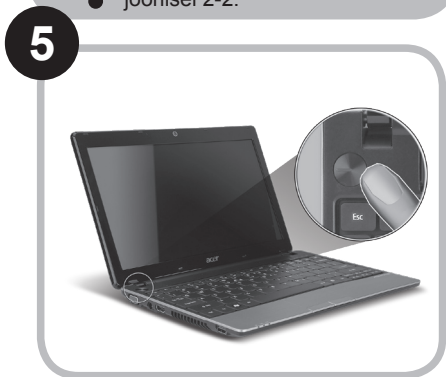
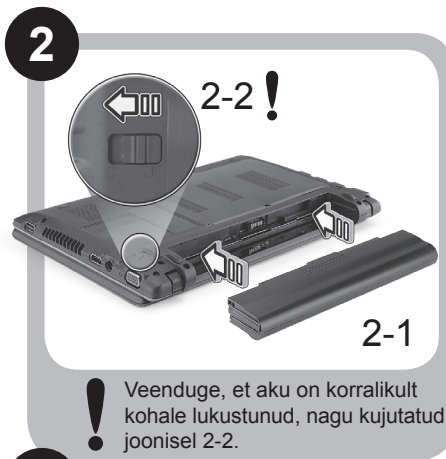
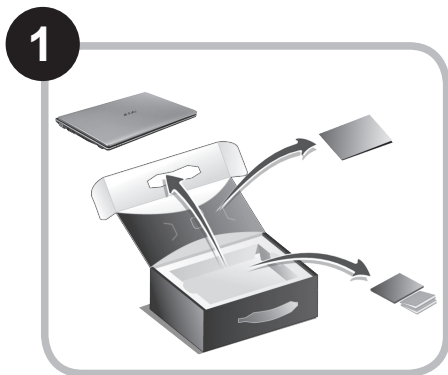

Illustratsioonid on ainult üldiseks võrdlusaluseks. Toodete tegelikud tehnilised andmed võivad erineda.

Kõigepealt tähtsamad asjad

Täname Teid selle eest, et valisite oma kaasaskantavaks arvutiks Acer'i sülearvuti.

Teie teejuhid

Et aidata teil kasutada Aceri sülearvutit, oleme loonud komplekti juhiseid*:

Kõigepealt aitab Lühijuhend teil alustada arvuti häälestamist.

Kui soovite rohkem teada saada, kuidas arvuti aitab teil produktiivsem olla, vaadake AcerSystem User Guide'i. Teatmik sisaldab täpsemat informatsiooni sellistel teemadel, nagu süsteemiutilidid, andmete taastamine, laiendusvõimalused ja probleemide lahendamine. Sellele lisaks sisaldab see garantiiteavet ning sülearvuti kohta kehtivaid üldiseid regulatsioone ja ohutuseeskirju. See on saadaval PDF-formaadis (Portable Document Format) ning on laaditud teie sülearvutisse.



Märkus: Faili vaatamiseks on vajate programmi Adobe Reader. Kui Adobe Reader pole arvutisse installitud, käivitab AcerSystem User Guide'i klõpsamine kõigepealt Adobe Readeri installimisprogrammi. Installeerimise lõpetamiseks järgige ekraanil olevaid juhiseid. Juhiseid Adobe Readeri kasutamiseks leiata menüüst Spikker ja Tugi.



*** TÄHTIS MÄRKUS:** Palun pidage silmas, et ülalmainitud juhised, nii trükitud kui elektroonilisel kujul, on ainult teavitava iseloomuga ning välja arvatud juhtudel, kui AcerSystem User Guide'is sisalduvas spetsiifilises garantiiteabes pole näidatud teisiti, ei kujuta miski neis juhistes toodud teabes endast Aceri esindatust või garantiid teie poolt ostetud tootele. Acer vabastab end selgesõnaliselt mis tahes kohustustest seoses juhistes esineda võivate vigadega.

Võrgukonfiguratsioon

See juhend aitab teil LAN- ja traadita võrgu sätteid konfigureerida, et saaksite luua Interneti-ühenduse.

LAN-ühenduse seadistamine

Lihtsalt ühendage LAN-kaabel Etherneti (RJ-45) porti. Vt Etherneti pordi asukohta osast „**Vaade paremalt**” lk 6.

Traadita ühenduse seadistamine

1. Pääsemaks juurde rakendusele Communication Manager vajutage <Fn> + <F3>. Nüüd saate lülitada sisse Wi-Fi-ühenduse, klõpsates selle kõrval olevale punasel nupul.

Märkus: 3G-le ja Bluetoothile pääseb ligi ka rakenduse Communication Manager kaudu. Sideseadmed võivad vastavalt mudelile erineda.

2. Klõpsake süsteemisalves ikoonil  ja valige traadita pääsupunkt, millega soovite ühendust luua.

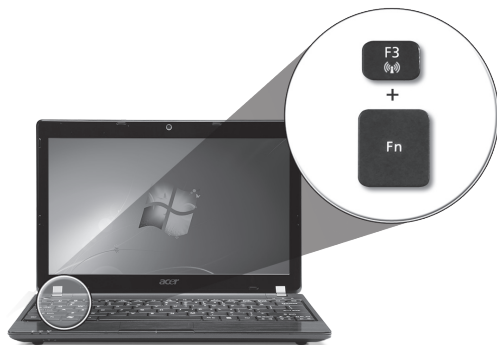

3G SIM-kaardi sisestamine (ainult teatud mudelitel)

Eemaldage aku ja sisestage ettevaatlikult 3G SIM-kaart 3G SIM-kaardi pilusse. Vt 3G SIM-kaardi pilu asukohta osast „**Tagant- ja põhjavaade**” lk 6.

Teie Aspire One ülevaade

Kui olete oma arvuti häälestanud jaotises Alustuseks kirjeldatud viisil, lubage meil tutvustada teie uut sülearvutit Acer.

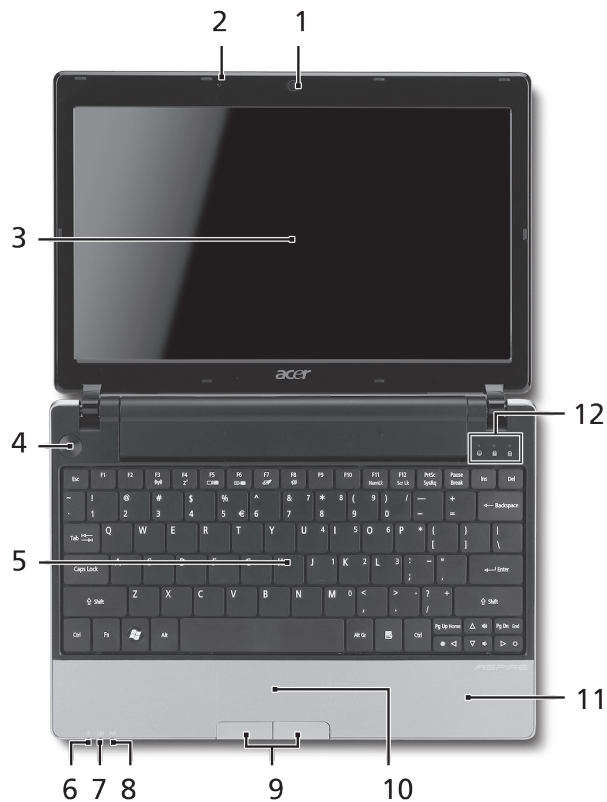

Pealtvaade



#	Ikoon	Objekt	Kirjeldus						
1		Veebikaamera Acer Crystal Eye	Veebikaamera videosuhtluseks (mudelite konfiguratsioon võib olla erinev).						
2		Mikrofon	Sisseehitatud mikrofon heli salvestamiseks.						
3		Kuvariekraan	Seda nimetatakse ka vedelkristallekraaniks (LCD) ning see kuvab arvuti pilti (mudelite konfiguratsioon võib olla erinev).						
4		Voolunupp	Arvuti sisse- ja väljalülitamiseks.						
5		Klaviatuur	Andmete sisestamiseks arvutisse.						
6		Vooluindikaator ¹	Näitab arvuti olekut.						
7		Aku indikaator ¹	Näitab arvuti aku olekut. 1. Laadimine: kui akut laetakse, on tuli kollakat värvi. 2. Täielikult laetud: kui arvuti on vooluvõrgus, on tuli sinist värvi.						
8		indikaator ¹	Näitab 3G või traadita võrguühenduse olekut.						
			<table border="1"> <thead> <tr> <th>Sinine tuli põleb</th> <th>Põleb oranž tuli</th> <th>Tuli ei põle</th> </tr> </thead> <tbody> <tr> <td>3G sees/WiFi sees</td> <td>3G väljas/WiFi sees</td> <td>3G väljas/WiFi väljas</td> </tr> </tbody> </table>	Sinine tuli põleb	Põleb oranž tuli	Tuli ei põle	3G sees/WiFi sees	3G väljas/WiFi sees	3G väljas/WiFi väljas
Sinine tuli põleb	Põleb oranž tuli	Tuli ei põle							
3G sees/WiFi sees	3G väljas/WiFi sees	3G väljas/WiFi väljas							
9		Klõpsunupud (vasak ja parem)	Vasak ja parem nupp funktsioneerivad vasaku ja parema hiirenupuna.						
10		Puuteplaat	Puutetundlik osutusseadis, mis töötab arvutihiirena.						
11		Randmetugi	Mugav toetusala, kuhu saate arvutit kasutades toetada oma käsi.						
12		Kõvakettaindikaator	Näitab kõvaketta aktiivsust.						
		Numbrilukk Num Lock	Sütib siis, kui numbrilukk aktiveeritakse.						
		Suurtähelukk Caps Lock	Sütib siis, kui suurtähelukk aktiveeritakse.						

1. Esipaneelil asuvad indikaatorid on nähtavad ka siis, kui arvuti kaas on suletud.

Suletud eestvaade

#	Ikoon	Objekt	Kirjeldus
1		Olekuindikaatorid	Valgusdiodid (LED-id), mille süttimine näitab arvuti funktsioonide ja komponentide olekut.

Vaade vasakult

2		Välise kuvari (VGA) port	Kuvaseadme (nt välise kuvari või LCD-projektori) ühendamiseks.
3		Alalisvoolusisendi pistik	Vahelduvvooluadapteri (toiteploki) ühendamiseks.
4	HDMI	HDMI-port	Toetab kõrglahutusega digitaalvideoühendusi.
5		Ventilatsiooniavad	Võimaldavad arvutil püsida jahedana ka pärast pikaajalist kasutamist.
6		USB 2.0 port	USB 2.0 seadmete ühendamiseks (nt USB-hiir või USB-kaamera).

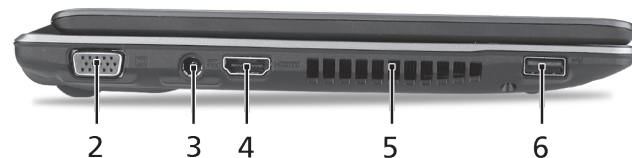

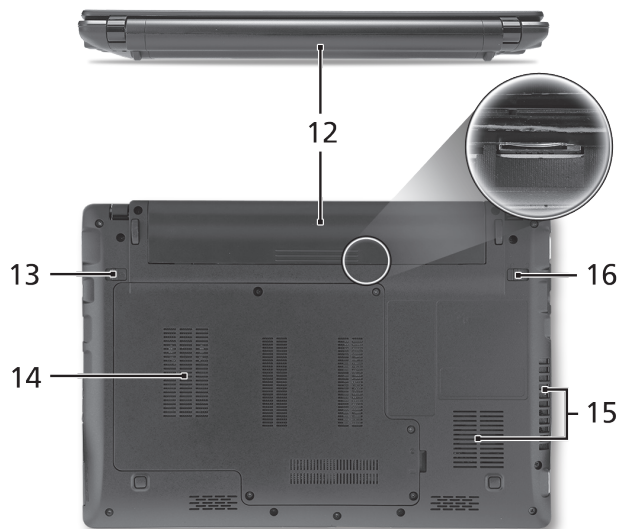
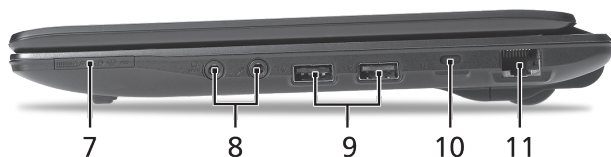

Vaade paremalt

#	Icoon	Objekt	Kirjeldus
7		Mitu-ühes kaardilugeja	Võtab vastu järgmisi kaarte: Secure Digital (SD), MultiMediaCard (MMC), Memory Stick (MS), Memory Stick PRO (MS PRO) ja xD-Picture (xD). Märkus: Kaardi eemaldamiseks/ paigaldamiseks vajutage sellele. Korraga saab töötada ainult üks kaart.
8		Mikrofonipesa	Võtab vastu sisendheli välisest mikrofonist.
		Kõrvaklappide/kõlarite/ heliväljundi pistiks S/PDIF toega	Heliväljundseadmete ühendamiseks (nt kõlarid, kõrvaklapid).
9		USB 2.0 port	USB 2.0 seadmete ühendamiseks (nt USB-hiir).
10		Kensington-luku pesa	Kensington-tüüpi arvuti turvaluku ühendamiseks.
11		Etherneti (RJ-45) port	Ethernet 10/100/1000-põhise võrguga ühendamiseks.
Tagant- ja põhjavaade			
12		Akuseksioon	Siin asuvad arvuti akud.
13		Aku vabastamise riiv	Vabastab aku, et seda saaks välja võtta.
14		Kõvakettaseksioon	Siin asub arvuti kõvaketas (kinnitatud kruvidega).
		Mälusahtel	Siin asub arvuti põhimälu.
15		Ventilatsioonivad ning jahutusventilaator	Võimaldavad arvutil püsida jahedana ka pärast pikaajalist kasutamist. Märkus: Ärge katke ega blokeerige ventilatsiooniavasid.
16		Akulukk	Lukustab aku kohale.

Keskkond

Temperatuur:

Töötamiseks sobiv: 5 °C kuni 35 °C

Sobimatu: -20 °C kuni 65 °C

Niiskus (mittekondenseeruv):

Töötamiseks sobiv: 20% kuni 80%

Sobimatu: 20% kuni 80%

ASPIRE ONE sērija

Ātrais ceļvedis

ASPIRE ^①one sērija

© 2010 Visas tiesības aizsargātas

Aspire One sērijas ātrais ceļvedis
Oriģinālizdevums: 04/2010

Aspire One sērijas piezīmjdators

Modeļa numurs: _____

Sērijas numurs: _____

Pirkuma datums: _____

Pirkuma vieta: _____

Federal Communications Commission

Declaration of Conformity

This device complies with Part 15 of the FCC Rules. Operation is subject to the following two conditions: (1) this device may not cause harmful interference, and (2) this device must accept any interference received, including interference that may cause undesired operation.

The following local Manufacturer/Importer is responsible for this declaration:

Product name:	Notebook PC
Brand:	Acer
Model number:	MS2296
Machine type:	AO 753 series
Name of Responsible Party:	Acer America Corporation
Address of responsible party:	333 West San Carlos St., San Jose CA 95110, U. S. A.
Contact person:	Acer Representative
Phone No.:	1-254-298-4000
Fax No.:	1-254-298-4147
April 30, 2010	

CE Declaration of Conformity

We,

Acer Incorporated

8F, 88, Sec. 1, Hsin Tai Wu Rd., Hsichih, Taipei Hsien 221, Taiwan

Contact Person: Mr. Easy Lai, e-mail:easy_lai@acer.com.tw

And,

Acer Europe SA

Via Cantonale, Centro Galleria 2 6928 Manno Switzerland

Hereby declare that:

Product: Notebook Computer

Trade Name: Acer

Model Number: MS2296

Machine Type: AO753 series

Is compliant with the essential requirements and other relevant provisions of the following EC directives, and that all the necessary steps have been taken and are in force to assure that production units of the same product will continue comply with the requirements.

EMC Directive 2004/108/EC as attested by conformity with the following harmonized standards:

- EN55022, AS/NZS CISPR22, Class B
- EN55024
- EN61000-3-2 Class D
- EN61000-3-3

Low Voltage Directive 2006/95/EC as attested by conformity with the following harmonized standard:

- EN60950-1

Council Decision 98/482/EC (CTR21):

(Applicable to product with pan- European single terminal connection to the Public Switched Telephone Network (PSTN).)

RoHS Directive 2002/95/EC on the Restriction of the Use of certain Hazardous Substances in Electrical and Electronic Equipment



- The maximum concentration values of the restricted substances by weight in homogenous material are:

Lead	0.1%	Polybrominated Biphenyls (PBB's)	0.1%
Mercury	0.1%	Polybrominated Diphenyl Ethers (PBDE's)	0.1%
Hexavalent Chromium	0.1%	Cadmium	0.01%

Directive 2009/125/EC with regard to establishing a framework for the setting of ecodesign requirements for energy-related product.

R&TTE Directive 1999/5/EC as attested by conformity with the following harmonized standard:

- Article 3.1(a) Health and Safety
 - EN60950-1
 - EN62311
- Article 3.1(b) EMC
 - EN301 489-1
 - EN301 489-3 (Applicable to non-bluetooth wireless keyboard mouse set).
 - EN301 489-7
 - EN301 489-17
 - EN301 489-24
- Article 3.2 Spectrum Usages
 - EN300 440-2 (Applicable to non-bluetooth wireless keyboard mouse set).
 - EN300 328
 - EN301 511
 - EN301 893 (Applicable to 5GHz high performance RLAN).
 - EN301 908-1
 - EN301 908-2

Year to begin affixing CE marking 2010.

Easy Lai

Easy Lai /Manager
Regulation Center, Acer Inc.

Apr. 30, 2010

Date

Tikai iesācējiem

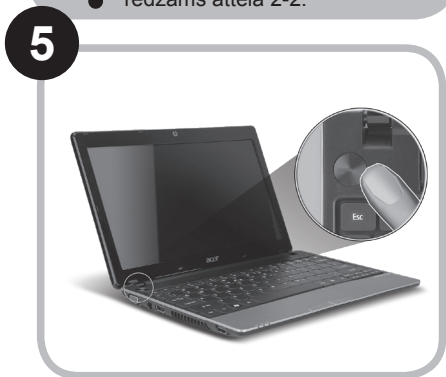
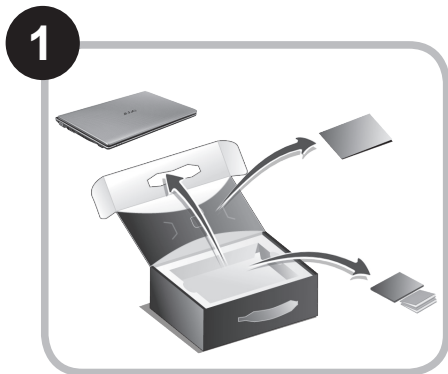

Attēli ir tikai norādēm. Preces faktiskās tehniskās normas var atšķirties.

Galvenais vispirms

Mēs vēlamies jums pateikties, ka esat izvēlējies Acer piezīmjdatoru, lai nodrošinātu savas mobilās skaitļošanas vajadzības.

Jūsu rokasgrāmatas

Lai palīdzētu jums lietot Acer piezīmjdatoru, esam sagatavojuši rokasgrāmatu komplektu*:

Pirmkārt, Ātrais ceļvedis jums palīdz uzsākt datora iestatīšanu.

Lai uzzinātu vairāk, kā jūsu dators jums var palīdzēt būt vēl produktīvākam, lūdzu, skatiet AcerSystem lietotāja ceļvedi. Šajā ceļvedī ir detalizēta informācija par tādām tēmām kā sistēmas utilitātes, datu atkopšana, paplašināšanas opcijas un problēmu novēršana. Bez tam tajā ir iekļauta informācija par garantijām un piezīmjdatora lietošanas vispārīgas regulas un drošības paziņojumi. Tas ir pieejams PDF (Portable Document Format - portatīvā dokumenta formāts) formātā un ir iepriekš ielādēts jūsu piezīmjdatorā.



Piezīme: lai skatītu failu, nepieciešama programma Adobe Reader. Ja jūsu datorā nav instalēta programma Adobe Reader, pirmo reizi noklikšķinot uz AcerSystem User Guide (AcerSystem lietotāja ceļvedis), automātiski tiks palaista programmas Adobe Reader instalēšana. Lai pabeigtu instalāciju, izpildiet ekrānā redzamos norādījumus. Lai iegūtu norādījumus, kā lietot programmu Adobe Reader, piekļūstiet izvēlnei Help and Support (Palīdzība un atbalsts).



*** SVARĪGS PAZIŅOJUMS:** Lūdzam ņemt vērā, ka šeit minētie ceļveži, kas ir gan izdrukātā, gan elektroniskā formātā, ir paredzēti tikai atsaucei, un nekas no šajos ceļvežos minētā nedod tiesības uz Acer garantiju attiecībā uz iegādāto produktu izņemot to, kas norādīts attiecīgajā garantijas informācijā, kas ietverta AcerSystem lietotāja ceļvedī. Acer neuzņemas nekādu atbildību par kļūdām, kuras satur ceļveži.

Tīkla konfigurācija

Šis ceļvedis jums palīdzēs konfigurēt jūsu LAN un bezvadu tīkla iestatījumus, lai ļautu jums izveidot interneta savienojumu.

LAN savienojuma iestatīšana

Vienkārši iespraudiet LAN kabeli Ethernet (RJ-45) portā. Lūdzu, skatiet "**Skats no labās puses**" 6. lappusē, lai noteiktu Ethernet porta atrašanās vietu.

Bezvadu savienojuma iestatīšana

1. Nospiediet <Fn> + <F3>, lai piekļūtu sakaru pārvaldniekam. Šeit jūs varat iespējot Wi-Fi savienojumu, noklikšķinot sarkano pogu, kas atrodas blakus Wi-Fi.

Piezīme: Izmantojot sakaru pārvaldnieku, var piekļūt arī 3G un Bluetooth. Sakaru ierīces var atšķirties atkarībā no modeļa.

2. Noklikšķiniet uz  ikonas sistēmas tehnē un izvēlieties bezvadu piekļuves punktu, ar kuru vēlaties izveidot savienojumu.



3G SIM kartes ievietošana (tikai noteiktiem modeļiem)

Izņemiet akumulatoru un uzmanīgi ievietojiet 3G SIM karti 3G SIM kartes slotā. Lūdzu, skatiet "**Aizmugure un apakšpuse**" 6. lappusē, lai noteiktu 3G SIM kartes slotā atrašanās vietu.

Jūsu *Aspire One* pārskats

Pēc tam, kad esat sagatavojis savu datoru, kā parādīts sadaļā Tikai iesācējiem, atļaujiet jūs iepazīstināt ar jūsu jauno Acer piezīmdatoru.

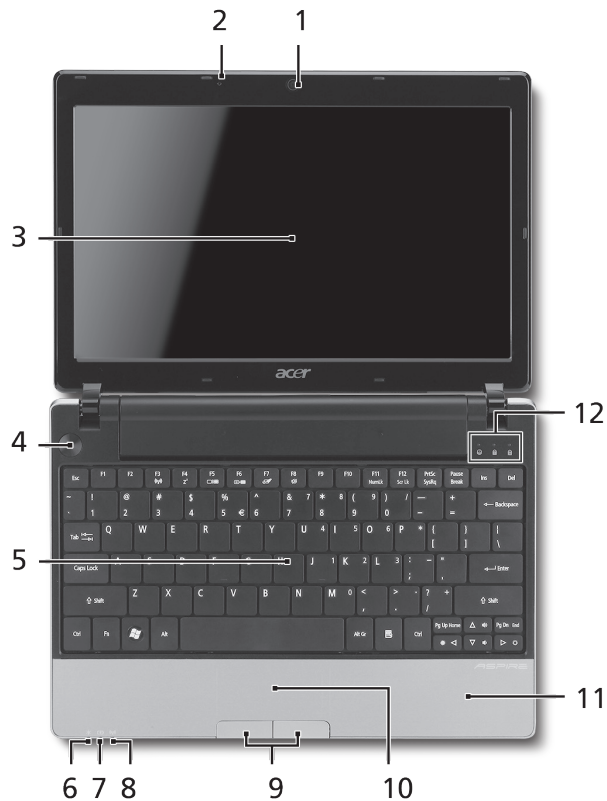

Skats no augšpuses



#	Ikona	Elements	Apraksts						
1		Acer Crystal Eye tīmekļa kamera	Tīmekļa kamera videosakariem (modeļu konfigurācija var atšķirties).						
2		Mikrofons	Iekšējais mikrofons skaņas ierakstīšanai.						
3		Displeja ekrāns	Saukts arī par šķidro kristālu displeju (LCD); rāda datora izvadi (modeļu konfigurācija var atšķirties).						
4		Barošanas poga	Ieslēdz un izslēdz datoru.						
5		Tastatūra	Datu ievadīšanai datorā.						
6		Barošanas indikators ¹	Norāda datora barošanas statusu.						
7		Akumulatora indikators ¹	Norāda datora akumulatora statusu. 1. Uzlāde: Indikators ir oranžā krāsā, akumulatoram lādējoties. 2. Pilnīgi uzlādēts: Datoram darbojoties no maiņstrāvas, indikators ir zils.						
8		Sakarū indikators ¹	Norāda 3G/bezvadu lokālā tīkla sakaru statusu.						
			<table border="1"> <thead> <tr> <th>Zilā gaisma iedegta</th> <th>Oranžā gaisma iedegta</th> <th>Gaisma nedeg</th> </tr> </thead> <tbody> <tr> <td>3G ieslēgts/ WiFi ieslēgts</td> <td>3G izslēgts/ WiFi ieslēgts</td> <td>3G izslēgts/ WiFi izslēgts</td> </tr> </tbody> </table>	Zilā gaisma iedegta	Oranžā gaisma iedegta	Gaisma nedeg	3G ieslēgts/ WiFi ieslēgts	3G izslēgts/ WiFi ieslēgts	3G izslēgts/ WiFi izslēgts
Zilā gaisma iedegta	Oranžā gaisma iedegta	Gaisma nedeg							
3G ieslēgts/ WiFi ieslēgts	3G izslēgts/ WiFi ieslēgts	3G izslēgts/ WiFi izslēgts							
9		Klikšķināmas pogas (kreisā un labā)	Kreisā un labā poga darbojas tāpat kā peles kreisā un labā poga.						
10		Skārienpanelis	Skārienjutīga rādītājierīce, kas darbojas kā datora pele.						
11		Plaukstu atbalsta zona	Ērta atbalsta zona jūsu rokām, kad lietojat datoru.						
12		Cietā diska indikators	Norāda, ka cietais disks ir aktīvs.						
		Num Lock (Ciparslēgs)	Deg, ja ir aktivizēts ciparslēgs.						
		Caps Lock (Burtslēgs)	Deg, ja ir aktivizēts burtslēgs.						

1. Priekšējā paneļa indikatori ir redzami pat tad, kad datora vāks ir cieši aizvērts.

Skats no priekšpuses aizvērtā veidā

#	Ikona	Elements	Apraksts
1		Statusa indikatori	Gaismas diodes (LED), kas iedegas, lai norādītu datora funkciju un komponentu statusu.

Skats no kreisās puses

2		Ārējā displeja (VGA) ports	Šeit pieslēdz displeja ierīci (piemēram, ārēju monitoru, LCD projektoru).
3		Līdzstrāvas ieejas ligzda	Šeit pieslēdz maiņstrāvas adapteru.
4	HDMI	HDMI ports	Atbalsta augstas kvalitātes ciparu video savienojumus.
5		Ventilācijas atveres	Neļauj datoram sakarst pat pēc ilgstošas lietošanas.
6		USB 2.0 ports	Šeit pieslēdz USB 2.0 ierīces (piemēram, USB peli, USB kameru).

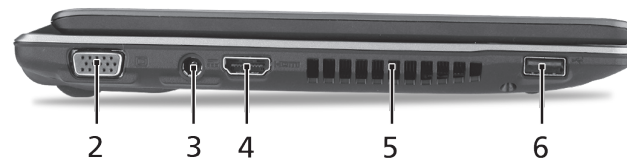

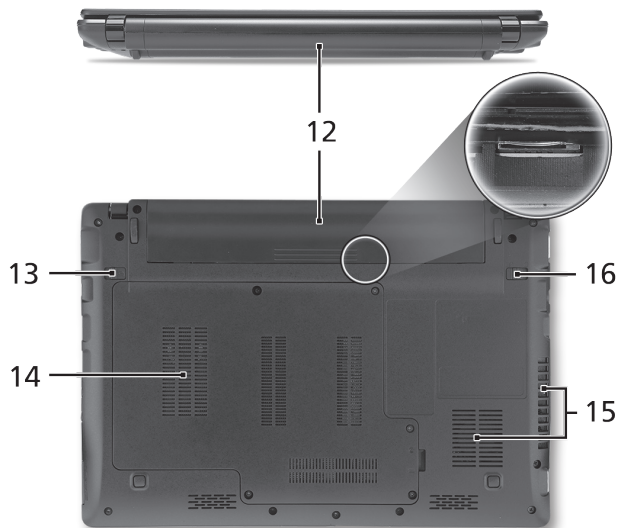
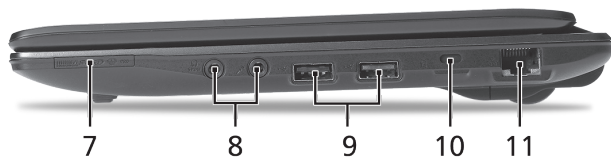

Skats no labās puses

#	Ikona	Elements	Apraksts
7		Karšu lasītājs "Vairāki vienā"	Pieņem datu nesējus Secure Digital (SD), MultiMediaCard (MMC), Memory Stick (MS), Memory Stick PRO (MS PRO) un xD-Picture Card (xD). Piezīme: Nospiediet, lai izņemtu/ieliktu karti. Vienlaikus var lietot tikai vienu karti.
8		Mikrofona ieejas ligzda	Pieņem ievadi no ārējiem mikrofoniem.
		Austiņas/skaļruņu/ līnijas izejas ports ar S/PDIF atbalstu	Pievieno audio līnijas izejas ierīces (piem., skaļruņus, austiņas).
9		USB 2.0 ports	Šeit pieslēdz USB 2.0 ierīces (piemēram, USB peli).
10		Kensingtona atslēgas slots	Šeit pieslēdz Kensingtona atslēgu datora drošībai.
11		Ethernet (RJ-45) ports	Šeit pieslēdz Ethernet 10/100/1000 tīkla vadu.

Aizmugure un apakšpuse

12		Akumulatora nodalījums	Šeit ievieto datora akumulatoru.
13		Akumulatora atbrīvošanas slēdzis	Atbrīvo akumulatoru, lai to varētu izņemt.
14		Cietā diska nodalījums	Šeit atrodas datora cietais disks (nostiprināts ar skrūvēm).
		Atmiņas nodalījums	Šeit atrodas datora pamatmatīņa.
15		Ventilācijas atveres un ventilators	Neļauj datoram sakarst pat pēc ilgstošas lietošanas. Piezīme: neaizsedziet un nenosprostojiet ventilatora atveri.
16		Akumulatora fiksators	Nofiksē akumulatoru.

Vide

Temperatūra:

Ieslēgtā stāvoklī: 5°C - 35°C

Izslēgtā stāvoklī: -20°C - 65°C

Mitrums (bez kondensācijas):

Ieslēgtā stāvoklī: 20% - 80%

Izslēgtā stāvoklī: 20% - 80%

ASPIRE ONE *serija*

Trumpa instrukcija

ASPIRE ^①one serijų

© 2010 Visos teisės saugomos

Aspire One serijų Trumpa instrukcija
Originalus leidimas: 04/2010

Aspire One serijų nešiojamasis kompiuteris

Modelio numeris: _____

Serijos numeris: _____

Pirkimo data: _____

Pirkimo vieta: _____

Federal Communications Commission

Declaration of Conformity

This device complies with Part 15 of the FCC Rules. Operation is subject to the following two conditions: (1) this device may not cause harmful interference, and (2) this device must accept any interference received, including interference that may cause undesired operation.

The following local Manufacturer/Importer is responsible for this declaration:

Product name:	Notebook PC
Brand:	Acer
Model number:	MS2296
Machine type:	AO 753 series
Name of Responsible Party:	Acer America Corporation
Address of responsible party:	333 West San Carlos St., San Jose CA 95110, U. S. A.
Contact person:	Acer Representative
Phone No.:	1-254-298-4000
Fax No.:	1-254-298-4147
April 30, 2010	

CE Declaration of Conformity

We,

Acer Incorporated

8F, 88, Sec. 1, Hsin Tai Wu Rd., Hsichih, Taipei Hsien 221, Taiwan

Contact Person: Mr. Easy Lai, e-mail:easy_lai@acer.com.tw



And,

Acer Europe SA

Via Cantonale, Centro Galleria 2 6928 Manno Switzerland

Hereby declare that:

Product: Notebook Computer

Trade Name: Acer

Model Number: MS2296

Machine Type: AO753 series

Is compliant with the essential requirements and other relevant provisions of the following EC directives, and that all the necessary steps have been taken and are in force to assure that production units of the same product will continue comply with the requirements.

EMC Directive 2004/108/EC as attested by conformity with the following harmonized standards:

- EN55022, AS/NZS CISPR22, Class B
- EN55024
- EN61000-3-2 Class D
- EN61000-3-3

Low Voltage Directive 2006/95/EC as attested by conformity with the following harmonized standard:

- EN60950-1

Council Decision 98/482/EC (CTR21):

(Applicable to product with pan- European single terminal connection to the Public Switched Telephone Network (PSTN).)

RoHS Directive 2002/95/EC on the Restriction of the Use of certain Hazardous Substances in Electrical and Electronic Equipment

- The maximum concentration values of the restricted substances by weight in homogenous material are:

Lead	0.1%	Polybrominated Biphenyls (PBB's)	0.1%
Mercury	0.1%	Polybrominated Diphenyl Ethers (PBDE's)	0.1%
Hexavalent Chromium	0.1%	Cadmium	0.01%

Directive 2009/125/EC with regard to establishing a framework for the setting of ecodesign requirements for energy-related product.

R&TTE Directive 1999/5/EC as attested by conformity with the following harmonized standard:

- Article 3.1(a) Health and Safety
 - EN60950-1
 - EN62311
- Article 3.1(b) EMC
 - EN301 489-1
 - EN301 489-3 (Applicable to non-bluetooth wireless keyboard mouse set).
 - EN301 489-7
 - EN301 489-17
 - EN301 489-24
- Article 3.2 Spectrum Usages
 - EN300 440-2 (Applicable to non-bluetooth wireless keyboard mouse set).
 - EN300 328
 - EN301 511
 - EN301 893 (Applicable to 5GHz high performance RLAN).
 - EN301 908-1
 - EN301 908-2

Year to begin affixing CE marking 2010.

Easy Lai

Easy Lai /Manager
Regulation Center, Acer Inc.

Apr. 30, 2010

Date

Tik pradedantiesiems

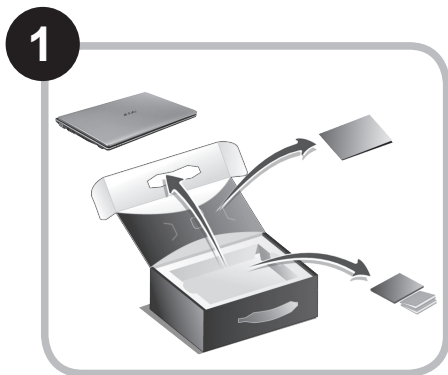

Paveikslėlius naudoti tik informacijai. Konkrečios produkto specifikacijos gali skirtis.

Dalykai, kuriuos reikia atlikti pirmiausia

Leiskite padėkoti, kad pasirinkote „Acer“ nešiojamąjį kompiuterį – tikimės Jūsų nenuvilti ir užtikrinti visus nešiojamojo kompiuterio teikiamus privalumus.

Instrukcijos Jums

Tam, kad palengvintume Jums naudojimąsi „Acer“ kompiuteriu, parengėme kelias instrukcijas*:

Pirmoji vadinasi Trumpa instrukcija - ši informacija padės pirmosiomis kompiuterio naudojimo minutėmis.

Išsamesnės informacijos apie tai, kaip padaryti kompiuterį produktyvesniu, rasite AcerSystem User Guide. Šioje instrukcijoje išsamiai aprašoma tokia informacija, kaip sisteminiai failai, duomenų atstatymas, kompiuterio galimybių praplėtimas ir gedimų diagnostika. Be to, šioje instrukcijoje yra ir garantinė informacija, bendrieji reikalavimai ir su sauga susiję įspėjimai. Ši instrukcija yra „Portable Document Format (PDF)“ formate ir ji jau bus kompiuteryje.



 Pastaba: Failo peržiūrai reikės „Adobe Reader“. Jei kompiuteryje nėra „Adobe Reader“, paspaudus ant AcerSystem User Guide bus pirmiausiai paleistas „Adobe Reader“ [diegimas. Vadovaukitės ekrane esančiomis instrukcijomis [diegimo užbaigimui. Instrukcijų dėl „Adobe Reader“ naudojimosi ieškokite „Help and Support“ [Žinynas ir pagalba] meniu.



*** SVARBI PASTABA:** Įsidėmėkite, kad čia paminėtos instrukcijos, tiek spausdintine, tiek elektronine forma yra tik jūsų informacijai ir išskyrus kaip numatyta specifinėje garantijos informacijoje, kuri yra išdėstyta AcerSystem User Guide, joks šių instrukcijų turinys nebus laikomas jūsų įsigyto Acer gaminio pateikimu ar garantija. Acer pabrėžia, kas nepriima jokios atsakomybės už instrukcijose esančias klaidas.

Tinklo konfigūracija

Ši instrukcija padės jums sukonfigūruoti savo LAN ir belaidžio tinklo nustatymus, kad galėtumėte prisijungti prie interneto.

LAN ryšio nustatymas

Tiesiog įkiškite LAN kabelį į eterneto (RJ-45) prievadą. Žr. „**Vaizdas iš dešinės**“ 6 p., kad nustatytumėte eterneto prievado vietą.

Belaidžio ryšio nustatymas

1. Paspauskite <Fn> + <F3>, kad atidarytumėte ryšių valdymo priemonę. Čia galite įjungti belaidį ryšį spustelėdami raudoną mygtuką prie belaidžio ryšio ženklo.

Pastaba: 3G ir „Bluetooth“ taip pat galima pasiekti per ryšių valdymo priemonę. Ryšių įrenginiai skiriasi priklausomai nuo modelio.

2. Spustelėkite  piktogramą ant sistemos užduočių juostos ir pasirinkite belaidės prieigos tašką, prie kurio norite jungtis.



3G SIM kortelės įdėjimas (tik tam tikriems modeliams)

Išimkite bateriją ir atidžiai įdėkite 3G SIM kortelę į 3G SIM kortelės lizdą. Žr. „**Vaizdai iš galo ir apačios**“ 6 p., kad nustatytumėte 3G SIM kortelės lizdo vietą.

Ekskursija po jūsų Aspire One

Atlikus kompiuterio sąranką kaip parodyta dalyje Pradedantiesiems, leiskite jus supažindinti su jūsų naujuoju Acer nešiojamuoju kompiuteriu.

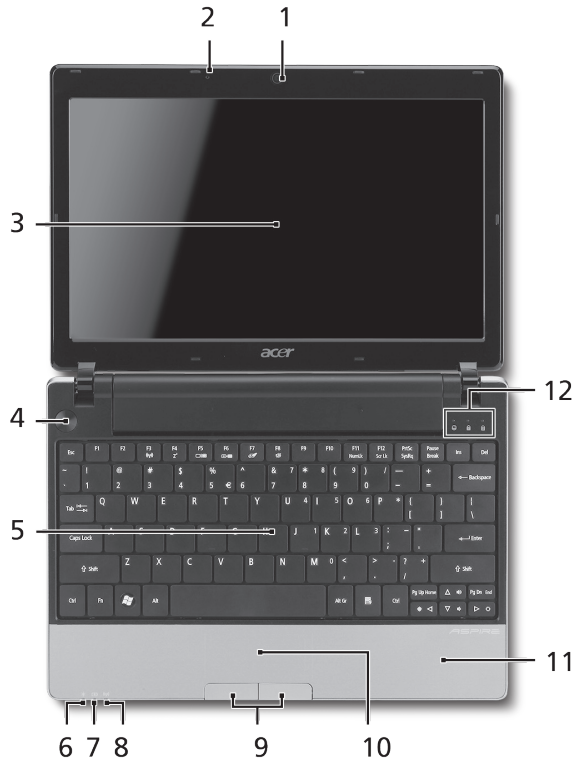

Vaizdas iš viršaus



#	Piktograma	Objektas	Aprašymas						
1		Acer Crystal Eye interneto kamera	Interneto kamera vaizdinei komunikacija (konfigūravimo tvarka gali kisti priklausomai nuo modelio).						
2		Mikrofonas	Vidinis mikrofonas garso įrašymui.						
3		Ekranas	Taip pat vadinamas skystųjų kristalų ekranu (angl. Liquid-Crystal Display (LCD)), jame pateikiamas kompiuterio rodomas vaizdas (konfigūravimo tvarka gali kisti priklausomai nuo modelio).						
4		Energijos mygtukas	Įjungia ir išjungia kompiuterį.						
5		Klaviatūra	Skirta duomenų įvedimui į kompiuterį.						
6		Maitinimo indikatorius ¹	Nurodo kompiuterio energijos sistemos būklę.						
7		Baterijos indikatorius ¹	Nurodo kompiuterio baterijos būklę. 1. Įkraunama: Kraunantis baterijai lemputė dega gintaro spalva. 2. Pilnai pakrauta: Dirbant iš kintamos srovės (AC) tinklo lemputė dega mėlynai.						
8		Komunikacijos indikatorius ¹	Rodo 3G / belaidžio LAN ryšio būseną. <table border="1" data-bbox="1098 610 1519 736"> <thead> <tr> <th>Dega mėlyna lemputė</th> <th>Dega oranžinė lemputė</th> <th>Nedega</th> </tr> </thead> <tbody> <tr> <td>3G įjungtas/ WiFi įjungtas 3G išjungtas/ WiFi išjungtas</td> <td>3G išjungtas/ WiFi įjungtas</td> <td>3G išjungtas/ WiFi išjungtas</td> </tr> </tbody> </table>	Dega mėlyna lemputė	Dega oranžinė lemputė	Nedega	3G įjungtas/ WiFi įjungtas 3G išjungtas/ WiFi išjungtas	3G išjungtas/ WiFi įjungtas	3G išjungtas/ WiFi išjungtas
Dega mėlyna lemputė	Dega oranžinė lemputė	Nedega							
3G įjungtas/ WiFi įjungtas 3G išjungtas/ WiFi išjungtas	3G išjungtas/ WiFi įjungtas	3G išjungtas/ WiFi išjungtas							
9		Peleš klavišai (kairysis ir dešinysis)	Kairysis ir dešinysis klavišai veikia kaip kairysis ir dešinysis peleš mygtukai.						
10		Liečiamasis laukelis	Lietimui jautrus įrenginys, veikiantis kaip kompiuterio peleš.						
11		Atrama delnui	Patogi atramos vieta jūsų rankoms naudojimosi kompiuteriu metu.						
12		HDD indikatorius	Nurodo ar kietasis diskas yra naudojamas (į jį rašoma ar skaitoma).						
		„Num Lock“	Dega kai yra aktyvuotas „Num Lock“ klavišas.						
		„Caps Lock“	Dega kai yra aktyvuotas „Caps Lock“ klavišas.						

1. Priekinio pulto indikatoriai matomi ne tada, kai kompiuterio viršus yra uždarytas.

Uždaryto kompiuterio vaizdas iš priekio

#	Piktograma	Objektas	Aprašymas
1		Būsenos indikatoriai	Šviesos diodai (LED), užsidegantys, kad parodytų kompiuterio funkcijų ir komponentų būseną.

Vaizdas iš kairės

2		Išorinio ekrano (VGA) lizdas	Skirtas prijungti papildomą monitorių (pvz. išorinį monitorių, LCD projektorių).
3		Nuolatinės srovės (DC) kištuko lizdas	Skirtas prijungti kintamos srovės (AC) adapteriui.
4	HDMI	HDMI lizdas	Skirtas pajungti didelės raiškos skaitmeniniams vaizdo prietaisams.
5		Ventiliacijos angos	Neleidžia kompiuteriui perkaisti net ir po ilgo naudojimo.
6		USB 2.0 lizdas	Skirtas USB 2.0 įrenginiams (pvz., USB pelė, USB kamera) prijungti.

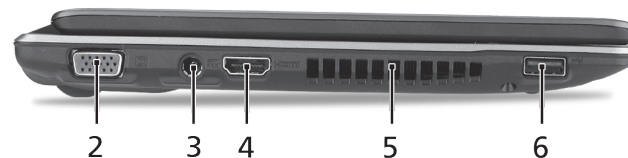

Vaizdas iš dešinės

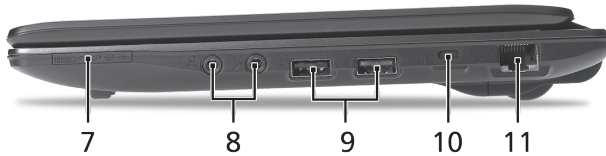

#	Piktograma	Objektas	Aprašymas
7		„Multi-in-1“ atminties kortelių skaitytuvas	Skaito Secure Digital (SD), MultiMediaCard (MMC), Memory Stick (MS), Memory Stick PRO (MS PRO), xD-Picture Card (xD) tipų atminties korteles. Pastaba: Spauskite norėdami įdėti/išimti kortelę. Vienu metu galima naudotis tik viena kortele.
8		Mikrofono kištuko lizdas	Skirtas prijungti išorinį mikrofoną.
		Ausinių/garsiakalbio/linijinio išėjimo kištukas, palaikantis S/PDIF	Skirtas išoriniams linijiniams audio prietaisams prijungti (pvz. garsiakalbiams, ausinėms).
9		USB 2.0 lizdas	Skirtas USB 2.0 įrenginiams (pvz., USB pelė) prijungti.
10		Kensington spynos lizdas	Skirtas užfiksuoti Kensington tipo kompiuterio užraktui.
11		Ethernet (RJ-45) lizdas	Skirtas prisijungti prie Ethernet 10/100/1000 tipo tinklo.

Vaizdai iš galo ir apačios

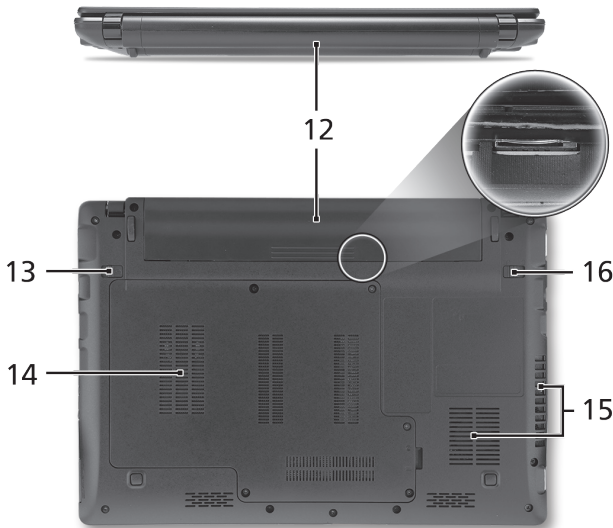

12		Baterijos lizdas	Skirtas montuoti kompiuterio baterijai.
13		Baterijos fiksatorius	Atpalaiduoja baterijos fiksavimą, leidžia ją išimti.
14		Kietųjų diskų lizdas	Montuojamas kietasis diskas (įtvirtintas varžtais).
		Operatyviosios atminties lizdas	Montuojama pagrindinė kompiuterio atmintis.
15		Ventiliacijos angos ir aušintuvas	Neleidžia kompiuteriui perkaisti net ir po ilgo naudojimo. Pastaba: Neuždenkite ir neužblokuokite ventiliatoriaus ertmės.
16		Baterijos užraktas	Fiksuoja įdėtą bateriją darbinėje padėtyje.

Aplinka

Temperatūra:

Darbinē: nuo 5°C iki 35°C

Saugojimo: nuo -20°C iki 65°C

Drėgmė (be kondensacijos):

Darbinē: nuo 20% iki 80%

Saugojimo: nuo 20% iki 80%

Σειρά **ASPIRE** ONE

Γρήγορος οδηγός

Σειρά *ASPIRE* One

© 2010 Με επιφύλαξη κάθε νόμιμου δικαιώματος

Γρήγορος οδηγός σειράς *Aspire One*
Αρχική Έκδοση: 04/2010

Φορητό PC Σειρά *Aspire One*

Αριθμός Μοντέλου: _____

Σειριακός Αριθμός: _____

Ημερομηνία αγοράς: _____

Τόπος Αγοράς: _____

Federal Communications Commission

Declaration of Conformity

This device complies with Part 15 of the FCC Rules. Operation is subject to the following two conditions: (1) this device may not cause harmful interference, and (2) this device must accept any interference received, including interference that may cause undesired operation.

The following local Manufacturer / Importer is responsible for this declaration:

Product name:	Notebook PC
Brand:	Acer
Model number:	MS2296
Machine type:	<i>AO 753 series</i>
Name of Responsible Party:	Acer America Corporation
Address of responsible party:	333 West San Carlos St., San Jose CA 95110, U. S. A.
Contact person:	Acer Representative
Phone No.:	1-254-298-4000
Fax No.:	1-254-298-4147
April 30, 2010	

CE Declaration of Conformity

We,

Acer Incorporated

8F, 88, Sec. 1, Hsin Tai Wu Rd., Hsichih, Taipei Hsien 221, Taiwan

Contact Person: Mr. Easy Lai, e-mail:easy_lai@acer.com.tw



And,

Acer Europe SA

Via Cantonale, Centro Galleria 2 6928 Manno Switzerland

Hereby declare that:

Product: Notebook Computer

Trade Name: Acer

Model Number: MS2296

Machine Type: AO753 series

Is compliant with the essential requirements and other relevant provisions of the following EC directives, and that all the necessary steps have been taken and are in force to assure that production units of the same product will continue comply with the requirements.

EMC Directive 2004/108/EC as attested by conformity with the following harmonized standards:

- EN55022, AS/NZS CISPR22, Class B
- EN55024
- EN61000-3-2 Class D
- EN61000-3-3

Low Voltage Directive 2006/95/EC as attested by conformity with the following harmonized standard:

- EN60950-1

Council Decision 98/482/EC (CTR21):

(Applicable to product with pan- European single terminal connection to the Public Switched Telephone Network (PSTN).)

RoHS Directive 2002/95/EC on the Restriction of the Use of certain Hazardous Substances in Electrical and Electronic Equipment

- The maximum concentration values of the restricted substances by weight in homogenous material are:

Lead	0.1%	Polybrominated Biphenyls (PBB's)	0.1%
Mercury	0.1%	Polybrominated Diphenyl Ethers (PBDE's)	0.1%
Hexavalent Chromium	0.1%	Cadmium	0.01%

Directive 2009/125/EC with regard to establishing a framework for the setting of ecodesign requirements for energy-related product.

R&TTE Directive 1999/5/EC as attested by conformity with the following harmonized standard:

- Article 3.1(a) Health and Safety
 - EN60950-1
 - EN62311
- Article 3.1(b) EMC
 - EN301 489-1
 - EN301 489-3 (Applicable to non-bluetooth wireless keyboard mouse set).
 - EN301 489-7
 - EN301 489-17
 - EN301 489-24
- Article 3.2 Spectrum Usages
 - EN300 440-2 (Applicable to non-bluetooth wireless keyboard mouse set).
 - EN300 328
 - EN301 511
 - EN301 893 (Applicable to 5GHz high performance RLAN).
 - EN301 908-1
 - EN301 908-2

Year to begin affixing CE marking 2010.

Easy Lai

Easy Lai /Manager
Regulation Center, Acer Inc.

Apr. 30, 2010

Date

Μόνο για αρχάριους

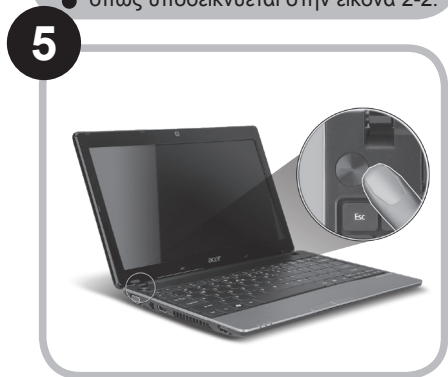
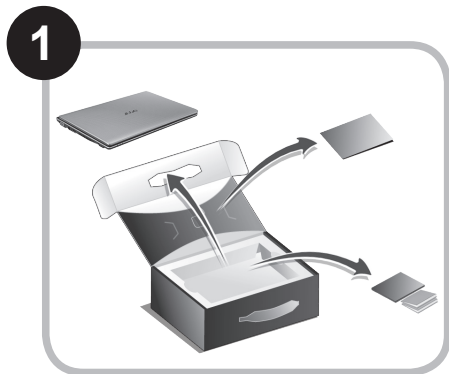

Οι απεικονίσεις είναι μόνο για αναφορά. Οι πραγματικές προδιαγραφές των προϊόντων μπορεί να διαφοροποιηθούν.

Πρώτα από όλα

Θα επιθυμούσαμε να σας ευχαριστήσουμε που επιλέξατε το φορητό υπολογιστή της Acer με σκοπό την αντιμετώπιση των αναγκών σας για φορητό υπολογιστή.

Οι οδηγοί σας

Για να σας διευκολύνουμε στη χρήση του φορητού υπολογιστή της Acer, έχουμε σχεδιάσει ένα σετ εγχειριδίων χρήσης*:

Πρώτα απ' όλα, ο Γρήγορος Οδηγός Χρήσης σας διευκολύνει να ξεκινήσετε τη ρύθμιση του υπολογιστή σας.

Για περισσότερες πληροφορίες όσον αφορά τον τρόπο με τον οποίο ο υπολογιστής μπορεί να σας βοηθήσει να αυξήσετε την παραγωγικότητά σας, ανατρέξτε στον AcerSystem User Guide. Ο οδηγός αυτός περιλαμβάνει λεπτομερείς πληροφορίες σχετικά με θέματα όπως τα βοηθητικά προγράμματα του συστήματος, την επαναφορά δεδομένων, τις επιλογές επέκτασης και την αντιμετώπιση προβλημάτων. Επιπλέον, περιλαμβάνει πληροφορίες σχετικά με την εγγύηση καλής λειτουργίας και τους γενικούς κανονισμούς όπως και τις προειδοποιήσεις ασφαλείας για το φορητό υπολογιστή. Διατίθεται σε μορφή Portable Document Format (PDF) και έχει προεγκατασταθεί στο φορητό υπολογιστή σας.



Σημείωση: Για την προβολή του αρχείου απαιτείται το πρόγραμμα Adobe Reader. Εάν το Adobe Reader δεν είναι εγκατεστημένο στον υπολογιστή σας, κάνοντας κλικ στο AcerSystem User Guide, θα πραγματοποιηθεί εκτέλεση του προγράμματος εγκατάστασης του Adobe Reader πρώτα. Ακολουθήστε τις οδηγίες στην οθόνη για να ολοκληρώσετε την εγκατάσταση. Για οδηγίες σχετικά με το πώς θα χρησιμοποιήσετε το πρόγραμμα Adobe Reader, ανατρέξτε στο μενού Βοήθεια και Υποστήριξη.



*** ΣΗΜΑΝΤΙΚΗ ΑΝΑΚΟΙΝΩΣΗ:** Παρακαλούμε σημειώστε ότι οι οδηγοί που αναφέρονται στο παρόν, σε έντυπη ή ηλεκτρονική μορφή, παρατίθενται για λόγους παραπομπής και μόνο και, εκτός αν ορίζεται διαφορετικά στις ειδικές πληροφορίες εγγύησης που περιλαμβάνονται στο Οδηγός Χρήστη AcerSystem, τίποτα που περιλαμβάνεται σε αυτούς τους οδηγούς δεν θα αποτελεί δήλωση ή εγγύηση της Acer σχετικά με το προϊόν που αγοράσατε. Η Acer αποποιείται ρητά τυχόν ευθύνης σχετικά με σφάλματα που περιλαμβάνονται στους οδηγούς.

Ρύθμιση παραμέτρων δικτύου

Ο οδηγός αυτός θα σας βοηθήσει στον καθορισμό των παραμέτρων LAN και των ρυθμίσεων ασύρματου δικτύου, ώστε να διευκολυνθείτε στη σύνδεσή σας στο Internet.

Εγκατάσταση σύνδεσης LAN

Απλά συνδέστε το καλώδιο LAN στη θύρα Ethernet (RJ-45). Παρακαλούμε ανατρέξτε στο "**Δεξιά όψη**" στη **σελίδα 6** για τη θέση της θύρας Ethernet.

Εγκατάσταση ασύρματης σύνδεσης

1. Πατήστε <Fn> + <F3> για πρόσβαση στη διαχείριση επικοινωνίας. Εδώ μπορείτε να ενεργοποιήσετε τη σύνδεση Wi-Fi κάνοντας κλικ στο κόκκινο κουμπί δίπλα στο Wi-Fi.

Σημείωση: Η πρόσβαση στις λειτουργίες 3G και Bluetooth είναι εφικτή και από τη διαχείριση επικοινωνίας. Οι συσκευές επικοινωνίας διαφέρουν ανάλογα με το μοντέλο.

2. Κάντε κλικ στο εικονίδιο  στο συρτάρι του συστήματος και επιλέξτε το σημείο ασύρματης πρόσβασης στο οποίο επιθυμείτε να συνδεθείτε.

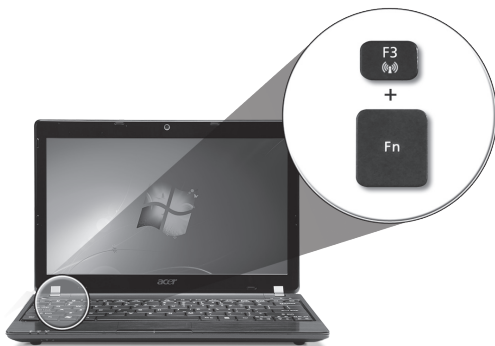

Εισαγωγή κάρτας SIM 3G (ορισμένα μοντέλα μόνο)

Αφαιρέστε τη μπαταρία και τοποθετήστε με προσοχή μια κάρτα SIM 3G στην υποδοχή κάρτας SIM 3G. Παρακαλούμε ανατρέξτε στην ενότητα "**Πίσω όψη & Αποψη βάσης**" στη **σελίδα 6** για τη θέση της υποδοχής κάρτας SIM 3G.

Ξενάγηση στο *Aspire One*

Μετά από την εγκατάσταση του υπολογιστή όπως απεικονίζεται στην ενότητα Μόνο για αρχάριους, θα σας περιγράψουμε τα διάφορα μέρη του νέου σας φορητού υπολογιστή Acer.

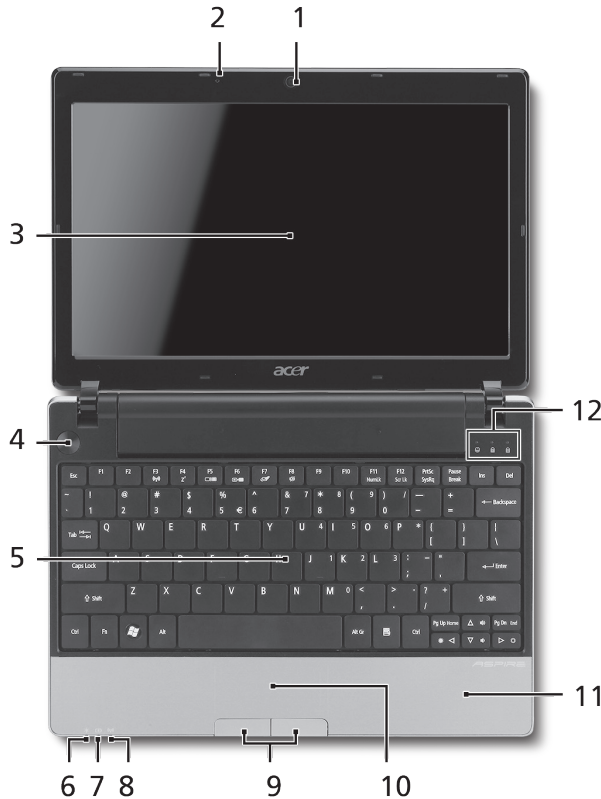

Κάτοψη



#	Εικονίδιο	Στοιχείο	Περιγραφή						
1		Κάμερα διαδικτύου Acer Crystal Eye	Κάμερα διαδικτύου για επικοινωνία βίντεο (Η σύνθεση ενδέχεται να ποικίλλει ανάλογα με το μοντέλο).						
2		Μικρόφωνο	Εσωτερικό μικρόφωνο για στερεοφωνικές ηχογραφήσεις.						
3		Οθόνη απεικόνισης	Αποκαλούμενη επίσης Οθόνη Υγρών Κρυστάλλων (Liquid-Crystal Display: LCD), απεικονίζει την έξοδο του υπολογιστή (Η σύνθεση ενδέχεται να ποικίλλει ανάλογα με το μοντέλο).						
4		Κουμπί τροφοδοσίας	Ενεργοποιεί και απενεργοποιεί τον υπολογιστή.						
5		Πληκτρολόγιο	Χρησιμοποιείται για την καταχώρηση δεδομένων στον υπολογιστή.						
6		Ενδείκτης τροφοδοσίας ¹	Δηλώνει την κατάσταση τροφοδοσίας του υπολογιστή.						
7		Ενδείκτης μπαταρίας ¹	Δηλώνει την κατάσταση της μπαταρίας του υπολογιστή. 1. Φόρτιση: Η ενδεικτική λυχνία κατά τη φόρτιση της μπαταρίας μετατρέπεται σε πορτοκαλί. 2. Πλήρως φορτισμένη: Η ενδεικτική λυχνία μετατρέπεται σε μπλε όταν βρίσκεται σε λειτουργία εναλλασσόμενου ρεύματος (AC).						
8		Ενδεικτική λυχνία επικοινωνίας ¹	Δηλώνει την κατάσταση της επικοινωνίας ασύρματου LAN/3G. <table border="1" data-bbox="1098 613 1544 736"> <thead> <tr> <th>Μπλε λυχνία αναμμένη</th> <th>Πορτοκαλί λυχνία αναμμένη</th> <th>Όχι αναμμένη</th> </tr> </thead> <tbody> <tr> <td>3G ενεργό/ WiFi ενεργό 3G ενεργό/ WiFi ενεργό</td> <td>3G ανενεργό/ WiFi ενεργό</td> <td>3G ανενεργό/ WiFi ανενεργό</td> </tr> </tbody> </table>	Μπλε λυχνία αναμμένη	Πορτοκαλί λυχνία αναμμένη	Όχι αναμμένη	3G ενεργό/ WiFi ενεργό 3G ενεργό/ WiFi ενεργό	3G ανενεργό/ WiFi ενεργό	3G ανενεργό/ WiFi ανενεργό
Μπλε λυχνία αναμμένη	Πορτοκαλί λυχνία αναμμένη	Όχι αναμμένη							
3G ενεργό/ WiFi ενεργό 3G ενεργό/ WiFi ενεργό	3G ανενεργό/ WiFi ενεργό	3G ανενεργό/ WiFi ανενεργό							
9		Κουμπιά κλικ (αριστερό και δεξιό)	Το κουμπιά, αριστερό και δεξιό, λειτουργούν σαν τα κουμπιά, αριστερό και δεξιό, του ποντικιού.						
10		Ταμπλέτα αφής	Συσκευή κατάδειξης ευαίσθητη στην αφή που λειτουργεί ως ποντίκι υπολογιστή.						
11		Στήριγμα παλάμης	Άνετος χώρος στήριξης των χεριών κατά τη χρήση του υπολογιστή.						
12		Ενδείκτης HDD	Δηλώνει πότε είναι ενεργοποιημένη η μονάδα του σκληρού δίσκου.						
		Αριθμητικό πληκτρολόγιο	Ανάβει όταν ενεργοποιηθεί το Num Lock.						
		Κεφαλαία	Ανάβει όταν ενεργοποιηθεί το Caps Lock.						

1. Οι ενδεικτικές λυχνίες της πρόσφυσης είναι ορατές ακόμη και όταν το καπάκι του υπολογιστή είναι κλειστό.

Πρόσωση με το καπάκι κλειστό

#	Εικονίδιο	Στοιχείο	Περιγραφή
1		Ενδεικτικές λυχνίες κατάστασης	Δίοδοι φωτοεκπομπής (LED) οι οποίες ανάβουν για να δηλώσουν την κατάσταση των λειτουργιών του υπολογιστή και των διαφόρων εξαρτημάτων.





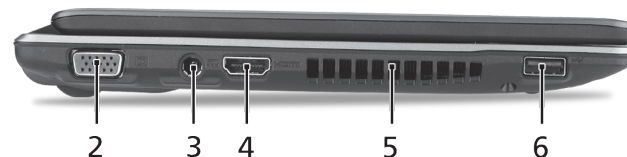

Αριστερή πλευρά

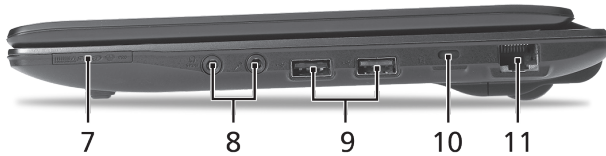
2		Θύρα εξωτερικής οθόνης απεικόνισης (VGA)	Συνδέεται σε συσκευή απεικόνισης (π.χ. εξωτερικό μόνιτορ, προβολέα LCD).
3		Τζακ εισόδου συνεχούς ρεύματος (DC)	Συνδέεται σε προσαρμογέα εναλλασσόμενου ρεύματος (AC).
4	HDMI	Θύρα HDMI	Υποστηρίζει συνδέσεις ψηφιακού βίντεο υψηλής ανάλυσης.
5		Θυρίδες εξαερισμού	Διατηρούν τον υπολογιστή σε χαμηλή θερμοκρασία, ακόμη και ύστερα από παρατεταμένη χρήση.
6		Θύρα USB 2.0	Συνδέεται σε συσκευές USB 2.0 (π.χ. ποντίκι USB, κάμερα USB).









Δεξιά πλευρά

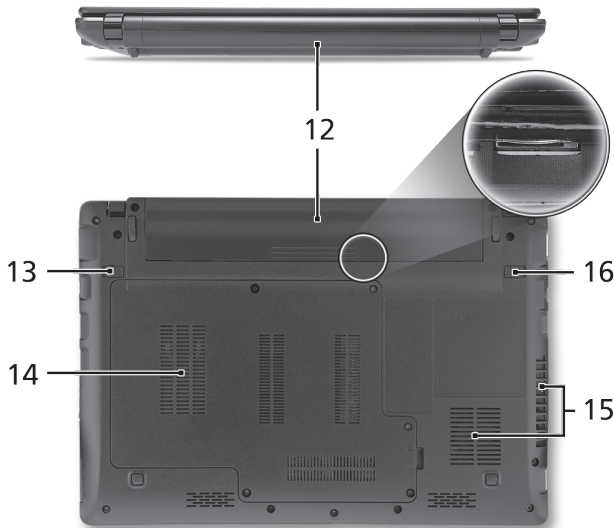

#	Εικονίδιο	Στοιχείο	Περιγραφή
7		Αναγνώστης καρτών πολλών-σε-1	Δέχεται Secure Digital (SD), MultiMediaCard (MMC), Memory Stick (MS), Memory Stick PRO (MS PRO)), και xD-Picture Card (xD). Σημείωση: Πιέστε για αφαίρεση/τοποθέτηση της κάρτας. Δυνατότητα λειτουργίας μόνο μίας κάρτας κάθε φορά.
8		Τζακ εισόδου μικροφώνου	Δέχεται εισόδους από εξωτερικά μικρόφωνα.
		Τζακ ακουστικών/ηχείων/γραμμής εξόδου με υποστήριξη S/PDIF	Συνδέεται σε συσκευές με γραμμή εξόδου ακουστικού σήματος (π.χ. ηχεία, ακουστικά).
9		Θύρα USB 2.0	Συνδέεται σε συσκευές USB 2.0 (π.χ. ποντίκι USB).
10		Υποδοχή λουκέτου τύπου Kensington	Συνδέεται σε λουκέτο ασφαλείας υπολογιστή συμβατό με Kensington.
11		Θύρα Ethernet (RJ-45)	Συνδέεται σε δίκτυο Ethernet 10/100/1000.

Πίσω όψη & Αποψη βάσης



12		Φατνίο μπαταρίας	Περιέχει το πακέτο μπαταρίας του υπολογιστή.
13		Μάνδαλο απασφάλισης μπαταρίας	Απασφαλίζει τη μπαταρία για αφαίρεση.
14		Φατνίο σκληρού δίσκου	Περιέχει το σκληρό δίσκο του υπολογιστή (ασφαλιζεται με βίδες).
		Διαμέρισμα μνήμης	Περιέχει την κύρια μνήμη του υπολογιστή.
15		Θυρίδες εξαερισμού και ανεμιστήρας ψύξης	Διατηρούν τον υπολογιστή σε χαμηλή θερμοκρασία, ακόμη και ύστερα από παρατεταμένη χρήση. Σημείωση: Μην καλύπτετε ή παρεμποδίζετε το άνοιγμα του ανεμιστήρα.
16		Λουκέτο μπαταρίας	Ασφαλίζει τη μπαταρία στη θέση της.

Περιβάλλον

Θερμοκρασία:

Λειτουργίας: 5°C έως 35°C

Μη λειτουργίας: -20°C έως 65°C

Υγρασία (μη συμπυκνούμενη):

Λειτουργίας: 20% έως 80%

Μη λειτουργίας: 20% έως 80%

ASPIRE ONE Serisi

Hızlı Başlama Kılavuzu

ASPIRE One Serisi

© 2010 Tüm Hakları Saklıdır

Aspire One Serisi Hızlı Başlama Kılavuzu
Orijinal İhraç: 04/2010

Aspire One Serisi Dizüstü Bilgisayarı

Model numarası: _____

Seri Numarası: _____

Satın alma tarihi: _____

Satın alma yeri: _____

Federal Communications Commission Declaration of Conformity

This device complies with Part 15 of the FCC Rules. Operation is subject to the following two conditions: (1) this device may not cause harmful interference, and (2) this device must accept any interference received, including interference that may cause undesired operation.

The following local Manufacturer / Importer is responsible for this declaration:

Product name:	Notebook PC
Brand:	Acer
Model number:	MS2296
Machine type:	<i>AO 753 series</i>
Name of Responsible Party:	Acer America Corporation
Address of responsible party:	333 West San Carlos St., San Jose CA 95110, U. S. A.
Contact person:	Acer Representative
Phone No.:	1-254-298-4000
Fax No.:	1-254-298-4147
April 30, 2010	

CE Declaration of Conformity

We,

Acer Incorporated

8F, 88, Sec. 1, Hsin Tai Wu Rd., Hsichih, Taipei Hsien 221, Taiwan

Contact Person: Mr. Easy Lai, e-mail:easy_lai@acer.com.tw



And,

Acer Europe SA

Via Cantonale, Centro Galleria 2 6928 Manno Switzerland

Hereby declare that:

Product: Notebook Computer

Trade Name: Acer

Model Number: MS2296

Machine Type: AO753 series

Is compliant with the essential requirements and other relevant provisions of the following EC directives, and that all the necessary steps have been taken and are in force to assure that production units of the same product will continue comply with the requirements.

EMC Directive 2004/108/EC as attested by conformity with the following harmonized standards:

- EN55022, AS/NZS CISPR22, Class B
- EN55024
- EN61000-3-2 Class D
- EN61000-3-3

Low Voltage Directive 2006/95/EC as attested by conformity with the following harmonized standard:

- EN60950-1

Council Decision 98/482/EC (CTR21):

(Applicable to product with pan- European single terminal connection to the Public Switched Telephone Network (PSTN).)

RoHS Directive 2002/95/EC on the Restriction of the Use of certain Hazardous Substances in Electrical and Electronic Equipment

- The maximum concentration values of the restricted substances by weight in homogenous material are:

Lead	0.1%	Polybrominated Biphenyls (PBB's)	0.1%
Mercury	0.1%	Polybrominated Diphenyl Ethers (PBDE's)	0.1%
Hexavalent Chromium	0.1%	Cadmium	0.01%

Directive 2009/125/EC with regard to establishing a framework for the setting of ecodesign requirements for energy-related product.

R&TTE Directive 1999/5/EC as attested by conformity with the following harmonized standard:

- Article 3.1(a) Health and Safety
 - EN60950-1
 - EN62311
- Article 3.1(b) EMC
 - EN301 489-1
 - EN301 489-3 (Applicable to non-bluetooth wireless keyboard mouse set).
 - EN301 489-7
 - EN301 489-17
 - EN301 489-24
- Article 3.2 Spectrum Usages
 - EN300 440-2 (Applicable to non-bluetooth wireless keyboard mouse set).
 - EN300 328
 - EN301 511
 - EN301 893 (Applicable to 5GHz high performance RLAN).
 - EN301 908-1
 - EN301 908-2

Year to begin affixing CE marking 2010.

Easy Lai

Easy Lai /Manager
Regulation Center, Acer Inc.

Apr. 30, 2010

Date

Başlayanlar için

1



2

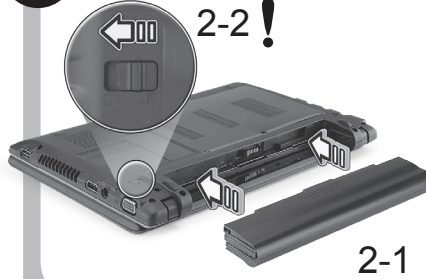

! 2-2'de gösterildiği gibi pilin yerine oturmuş olduğundan emin olun.

3



4



5



6



Resimler yalnızca referans içindir. Gerçek ürün spesifikasyonları çeşitlilik gösterebilir.

İlk Yapılacaklar

Taşınabilir bilgisayar ihtiyacınızı karşılamak için Acer dizüstü bilgisayarı tercih ettiğiniz için teşekkür ederiz.

Kılavuzlarınız

Acer dizüstü bilgisayarınızı kullanırken kolaylık sağlaması amacıyla bir kaç kılavuz tasarladık*:

Hızlı Başvuru Kılavuzu, bilgisayarınızın kurulumuna başlarken size yardımcı olur.

Bilgisayarınızın üretkenliğiniz üzerindeki etkisini arttırmak için lütfen AcerSystem User Guide göz gezdirin. Bu kılavuz sistem hizmet programları, veri düzeltme, genişletme seçenekleri ve arıza giderme üzerine detaylı bilgiler içermektedir. Buna ek olarak bilgisayarınızla ilgili garanti bilgileri, genel kuralları ve güvenlik uyarılarını içerir. Bu, bilgisayarınıza önceden yüklenmiş şekilde PDF dosya formatında gelmektedir.



Not: Dosyayı açabilmeniz için Adobe Reader gerekmektedir. Bilgisayarınızda Adobe Reader yüklü değilse AcerSystem User Guide tıklayarak Adobe Reader kurulum programını çalıştırabilirsiniz. Yüklemeyi tamamlamak için ekrandaki talimatları izleyin. Adobe Reader programını kullanma üzerinde talimatlar için Yardım ve Destek menüsüne erişin.



*** ÖNEMLİ NOT:** Gerek basılı gerek elektronik formatta olsun, burada adı geçen kılavuzlar sadece yol gösterme amaçlı olup AcerSystem User Guide özel garanti bilgileri dışında Acer, satın aldığınız ürün ile ilgili kılavuz bilgileri üzerine açıklama yapmak ya da güvence vermek sorumluluğunda değildir. Acer, bu kılavuzlarda bulunan hatalardan kaynaklı hiçbir mesuliyeti kabul etmez.

Şebeke yapılandırması

Bu kılavuz İnternete bağlanabilmeniz için LAN ve kablosuz ağ ayarlarınızı yapılandırmanıza yardımcı olur.

LAN bağlantısı kurulumu

LAN kablosunu Ethernet (RJ-45) portuna takın. Ethernet portunun yeri için lütfen **sayfa 6'deki "Sağ görünüm"** bölümüne bakın.

Kablosuz bağlantı kurulumu

1. <Fn> + <F3> tuşlarına basarak iletişim yöneticisine giriş yapın Buradan Wi-Fi'nin aynındaki kırmızı düğmeye tıklayarak Wi-Fi bağlantısını açabilirsiniz.

Not: 3G ve Bluetooth'a iletişim yöneticisinden de ulaşılabilir. İletişim aygıtları modele göre farklılık gösterir.

2. Sistem tepsisindeki  simgesini tıklayın ve bağlantı yapmak istediğiniz kablosuz erişim noktasını seçin.



Bir 3G SIM kartı takma (sadece belli modellerde)

Pili çıkartın ve 3G SIM kartını dikkatli bir şekilde 3G SIM kartı yuvasına takın. 3G SIM kartı yuvasının yeri için lütfen **sayfa 6'deki "Arka görünüm & Taban görünümü"** başlığına bakın.

Aspire One turunuz

Başlayanlar için bölümünde gösterildiği gibi bilgisayarınızı ayarladıktan sonra, yeni Acer dizüstü bilgisayarınızı daha yakından tanıtalım.

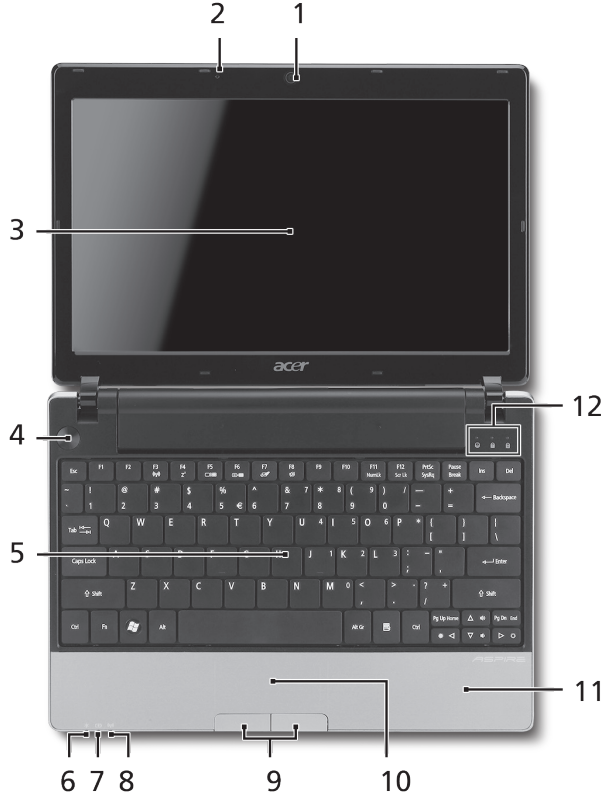

Üstten görünüş



#	Simge	Öge	Açıklama						
1		Acer Crystal Eye video kamera	Video iletişimi için Web kamerası (yapılandırma modellere göre farklı olabilir).						
2		Mikrofon	Ses kaydı için dahili mikrofon.						
3		Görüntü ekranı	Sıvı Kristalli Görüntü (LCD) olarak da bilinir ve bilgisayar çıktılarını gösterir (yapılandırma modellere göre farklı olabilir).						
4		Açma/kapama düğmesi	Bilgisayarı açar ve kapatır.						
5		Klavye	Bilgisayarınıza veri girebilmek için.						
6		Güç göstergesi ¹	Bilgisayarın güç durumunu gösterir.						
7		Batarya göstergesi ¹	Bilgisayarın pil durumunu gösterir. 1. Şarj oluyor: Pil şarj olurken ışık kehribar renginde yanar. 2. Tamamen şarj oldu: AC modundayken ışık mavi yanar.						
8		İletişim göstergesi ¹	Kablosuz LAN/3G iletişiminin durumunu gösterir.						
			<table border="1"> <thead> <tr> <th>Mavi ışık açık</th> <th>Turuncu ışık açık</th> <th>Yanmıyor</th> </tr> </thead> <tbody> <tr> <td>3G açık/WiFi açık</td> <td>3G kapalı/WiFi açık</td> <td>3G kapalı/WiFi kapalı</td> </tr> </tbody> </table>	Mavi ışık açık	Turuncu ışık açık	Yanmıyor	3G açık/WiFi açık	3G kapalı/WiFi açık	3G kapalı/WiFi kapalı
Mavi ışık açık	Turuncu ışık açık	Yanmıyor							
3G açık/WiFi açık	3G kapalı/WiFi açık	3G kapalı/WiFi kapalı							
9		Tuşlar (sol ve sağ)	Sol ve sağ tuşlar, bilgisayar faresinin sağ ve sol tuşları ile aynı fonksiyondadır.						
10		Dokunmatik yüzey	Bilgisayar faresi gibi fonksiyonu olan, dokunmaya duyarlı işaret aygıtı.						
11		Palmrest	Bilgisayarı kullanırken ellerinizi destekleyen rahat bir alan.						
12		HDD göstergesi	Sabit disk etkin olduğunu gösterir.						
		Num Lock	Num Lock etkin olduğunda yanar.						
		Caps Lock	Caps Lock etkin olduğunda yanar.						

1. Ön panel göstergeleri bilgisayar kapağı kapalı olsa bile görülebilir.

Kapalı ön görünüm

#	Simge	Öğe	Açıklama
1		Durum göstergeleri	Bilgisayar fonksiyonu ve parçalarının durumunu göstermek için yanan Elektro Işıklı Diod (LED).

Sol görünüm

2		Harici görüntü (VGA) portu	Bir görüntü aygıtına bağlar (örneğin, harici monitör, LCD projektör).
3		DC-in jakı	AC adaptöre bağlanır.
4	HDMI	HDMI portu	Yüksek çözünürlüklü dijital video bağlantılarını destekler.
5		Havalandırma yuvaları	Bilgisayarınızın uzun kullanımlar sonrası bile ısınmamasını sağlarlar.
6		USB 2.0 portu	USB 2.0 cihazlara bağlar (örneğin, USB mouse, USB kamera).

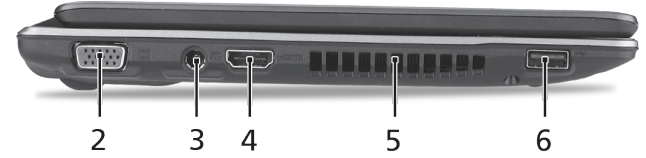

Sağ görünüm

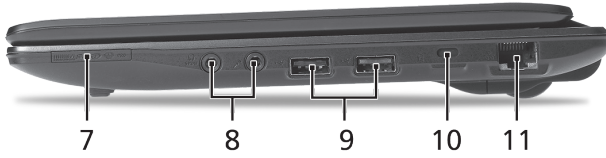

#	Simge	Öğe	Açıklama
7		Çoklu kart okuyucu	Güvenli Dijital (SD), Çoklu Ortam Kartı(MMC), Bellek Çubuğu (MS), Bellek Çubuğu PRO (MS PRO), xD-Görüntü Kartı (xD)'ni kabul eder. Not: Kartı çıkartmak/takmak için itin. Her hangi bir zamanda sadece bir kart çalışabilir.
8		Mikrofon-in jakı	Harici mikrofon girişlerini kabul eder.
		S/PDIF desteği ile kulaklık/hoparlör/hat çıkışı jakı	Sesli line-out cihazlarına bağlantıyı sağlar (örneğin hoparlör, kulaklık).
9		USB 2.0 portu	USB 2.0 cihazlara bağlar (örneğin, USB mouse).
10		Kensington kilit yuvası	Kensington-uyumlu bilgisayar güvenlik kilidine bağlar.
11		Ethernet (RJ-45) portu	Ethernet10/100/1000-temelli ağa bağlar.

Arka görünüm & Taban görünümü

12		Pil bölümü	Bilgisayar pil takımının yeridir.
13		Pil çıkarma mandalı	Eskiyen pilleri çıkarmanız içindir.
14		Sabit disk bölümü	Bilgisayarın sabit diskini barındırır (vidalarla sabitlenmiştir).
		Bellek bölümü	Bilgisayarın ana hafızasını barındırır.
15		Havalandırma delikleri ve soğutma fanı	Bilgisayarınızın uzun kullanımlar sonrası bile ısınmamasını sağlarlar. Not: Fanın girişini tıkamayın.
16		Pil kilidi	Pil yerine oturduğunda kilitlet.

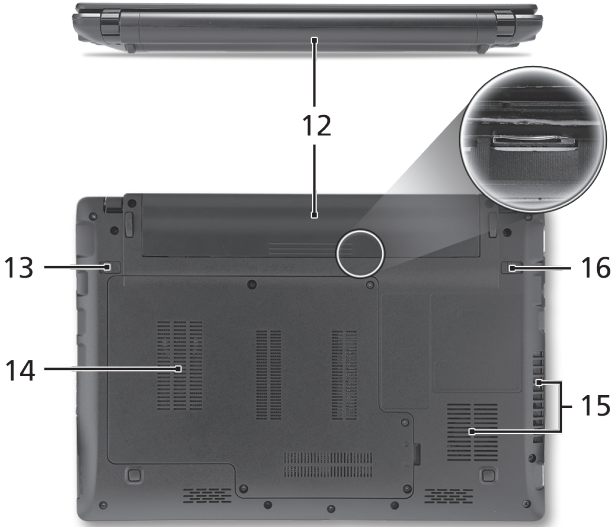

Ortam

Sıcaklık:

Çalışma: 5°C ila 35°C arasında

Çalışmadığı durumda: -20°C ila 65°C arasında

Nem (yoğunlaşmayan):

Çalışma: 20% ila 80% arasında

Çalışmadığı durumda: 20% ila 80% arasında

ASPIRE ONE シリーズ
クイックガイド

ASPIRE One シリーズ

© 2010 All Rights Reserved

Aspire One シリーズ クイックガイド

初版：04/2010

Aspire One シリーズノートブックコンピューター

モデル番号： _____

シリアル番号： _____

購入日： _____

購入場所： _____

Federal Communications Commission

Declaration of Conformity

This device complies with Part 15 of the FCC Rules. Operation is subject to the following two conditions: (1) this device may not cause harmful interference, and (2) this device must accept any interference received, including interference that may cause undesired operation.

The following local Manufacturer / Importer is responsible for this declaration:

Product name:	Notebook PC
Brand:	Acer
Model number:	MS2296
Machine type:	AO 753 series
Name of Responsible Party:	Acer America Corporation
Address of responsible party:	333 West San Carlos St., San Jose CA 95110, U. S. A.
Contact person:	Acer Representative
Phone No.:	1-254-298-4000
Fax No.:	1-254-298-4147
April 30, 2010	

CE Declaration of Conformity

We,

Acer Incorporated

8F, 88, Sec. 1, Hsin Tai Wu Rd., Hsichih, Taipei Hsien 221, Taiwan

Contact Person: Mr. Easy Lai, e-mail:easy_lai@acer.com.tw



And,

Acer Europe SA

Via Cantonale, Centro Galleria 2 6928 Manno Switzerland

Hereby declare that:

Product: Notebook Computer

Trade Name: Acer

Model Number: MS2296

Machine Type: AO753 series

Is compliant with the essential requirements and other relevant provisions of the following EC directives, and that all the necessary steps have been taken and are in force to assure that production units of the same product will continue comply with the requirements.

EMC Directive 2004/108/EC as attested by conformity with the following harmonized standards:

- EN55022, AS/NZS CISPR22, Class B
- EN55024
- EN61000-3-2 Class D
- EN61000-3-3

Low Voltage Directive 2006/95/EC as attested by conformity with the following harmonized standard:

- EN60950-1

Council Decision 98/482/EC (CTR21):

(Applicable to product with pan- European single terminal connection to the Public Switched Telephone Network (PSTN).)

RoHS Directive 2002/95/EC on the Restriction of the Use of certain Hazardous Substances in Electrical and Electronic Equipment

- The maximum concentration values of the restricted substances by weight in homogenous material are:

Lead	0.1%	Polybrominated Biphenyls (PBB's)	0.1%
Mercury	0.1%	Polybrominated Diphenyl Ethers (PBDE's)	0.1%
Hexavalent Chromium	0.1%	Cadmium	0.01%

Directive 2009/125/EC with regard to establishing a framework for the setting of ecodesign requirements for energy-related product.

R&TTE Directive 1999/5/EC as attested by conformity with the following harmonized standard:

- Article 3.1(a) Health and Safety
 - EN60950-1
 - EN62311
- Article 3.1(b) EMC
 - EN301 489-1
 - EN301 489-3 (Applicable to non-bluetooth wireless keyboard mouse set).
 - EN301 489-7
 - EN301 489-17
 - EN301 489-24
- Article 3.2 Spectrum Usages
 - EN300 440-2 (Applicable to non-bluetooth wireless keyboard mouse set).
 - EN300 328
 - EN301 511
 - EN301 893 (Applicable to 5GHz high performance RLAN).
 - EN301 908-1
 - EN301 908-2

Year to begin affixing CE marking 2010.

Easy Lai

Easy Lai /Manager
Regulation Center, Acer Inc.

Apr. 30, 2010

Date

最初のセットアップ

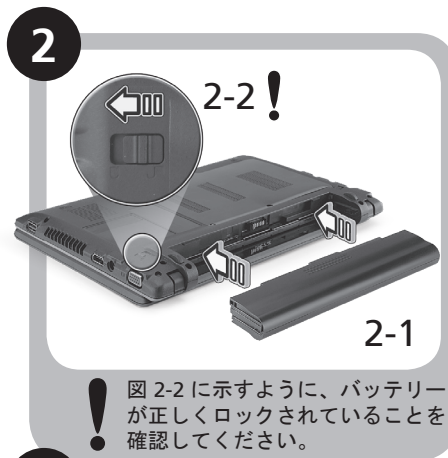
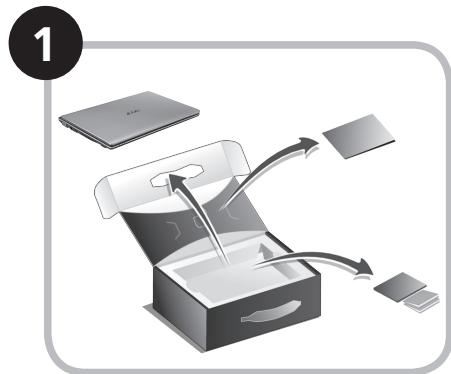

ここに掲載する図は参照用です。実際の仕様は製品によって異なります。

はじめに

Acer ノートブックをお買い上げいただきありがとうございます。

各種ガイドについて

Acer ノートブックを快適にお使いいただけるよう、数種類のガイド*をご用意いたしました*。

まず、コンピュータの設定手順を説明したガイドがクイックガイドです。

生産性を高めるためにノートブックを活用する方法については、AcerSystem User Guide をご参照ください。このガイドにはシステムユーティリティ、データリカバリー、拡張オプション、トラブルシューティングなどの詳細情報が記載されています。その他、保証情報および一般的な規制、安全のためのご注意なども記載されています。これは PDF (Portable Document Format) フォーマットでもお読みいただけるよう、ノートブックにあらかじめプリロードされています。



注意：このファイルをご覧になるには、Adobe Reader が必要です。ノートブックに Adobe Reader がインストールされていない場合は、[AcerSystem User Guide] をクリックすると Adobe Reader セットアッププログラムが起動されます。画面の指示にしたがってインストールを完了してください。Adobe Reader の使い方については、ヘルプとサポートメニューを参照してください。



* 重要：本書（印刷版およびデジタル版）の説明は参照を目的として記載されており、AcerSystem User Guide に特別に保証情報が記載されている場合を除き、Acer はお客様が購入された製品についていかなる責任も保証も行いません。Acer はガイドに含まれる誤りについて一切責任を負いません。

ネットワークの設定

本書には、インターネットに接続できるように LAN およびワイヤレスネットワークの設定を行うための手順が記載されています。

LAN 接続の設定

LAN ケーブルを Ethernet (RJ-45) ポートに接続するだけです。Ethernet ポートの位置については、6 ページの「右面」を参照してください。

ワイヤレス接続の設定

1. <Fn> + <F3> を押して、通信マネージャにアクセスします。Wi-Fi の隣にある赤いボタンをクリックして、Wi-Fi 接続をオンにできます。

注意：通信マネージャを通して、3G と Bluetooth も利用できます。通信機器は、モデルによって異なります。

2. システムトレイの  アイコンをクリックし、接続先となるワイヤレス アクセスポイントを選択します。



3G SIM カードの挿入 (特定モデルのみ)

バッテリーを外し、3G SIM カードスロットに慎重に 3G SIM カードを挿入します。3G SIM カードスロットの位置については、6 ページの「背面 & 底面」を参照してください。

Aspire One ツアー

初心者の方へ セクションの図にしたがってコンピュータを設定したら、これから新しい Acer ノートブックについて紹介します。

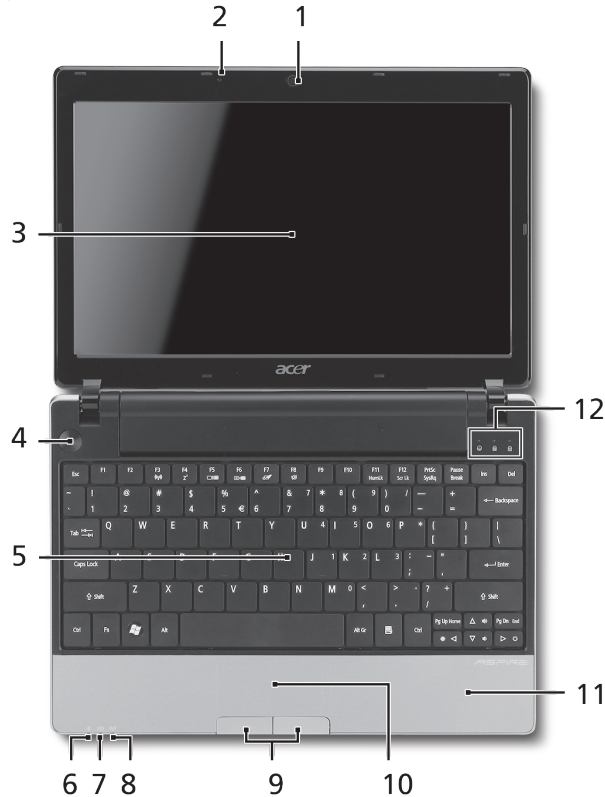

上面



#	アイコン	アイテム	説明						
1		Acer Crystal Eye ウェブカメラ	ビデオ通信用のウェブカメラです (構成はモデルによって異なります)。						
2		マイクロフォン	録音用の内部マイクロフォンです。						
3		ディスプレイスクリーン	液晶ディスプレイ (LCD) とも呼びます。コンピュータ出力を表示します (構成はモデルによって異なります)。						
4		電源ボタン	コンピュータの電源をオン/オフにします。						
5		キーボード	コンピュータにデータを入力します。						
6		電源インジケータ ¹	PC の電源がオンのときに点灯します。						
7		バッテリーインジケータ ¹	バッテリーパックが充電されているときに点灯します。 1. 充電中: バッテリーを充電している間、ランプは琥珀色に点灯します。 2. 完全に充電: AC モードでは、ライトが青くなります。						
8		通信インジケータ ¹	3G/ワイヤレス LAN 通信の状態を表示します。 <table border="1" style="width: 100%; border-collapse: collapse;"> <tr> <td style="width: 33%;">青く点灯</td> <td style="width: 33%;">オレンジ色に点灯</td> <td style="width: 33%;">点灯しない</td> </tr> <tr> <td>3G オン/WiFi オン</td> <td>3G オフ/WiFi オン</td> <td>3G オフ/WiFi オフ</td> </tr> </table>	青く点灯	オレンジ色に点灯	点灯しない	3G オン/WiFi オン	3G オフ/WiFi オン	3G オフ/WiFi オフ
青く点灯	オレンジ色に点灯	点灯しない							
3G オン/WiFi オン	3G オフ/WiFi オン	3G オフ/WiFi オフ							
9		クリックボタン (左、右)	左右のボタンはマウスの左右のボタンと同じように機能します。						
10		タッチパッド	コンピュータマウスと同じように機能し、指を触れることで反応するポインティングデバイスです。						
11		パームレスト	コンピュータ操作時に手を置く場所です。						
12		HDD インジケータ	ハードディスクドライブがアクティブになると点灯します。						
		Num Lock	Num Lock 機能を使っているときに点灯します。						
		Caps Lock	Caps Lock 機能を使っているときに点灯します。						

1. フロントパネルのインジケータは、コンピュータカバーが閉じた状態でも見えるようになっています。

正面 (閉じた場合)

#	アイコン	アイテム	説明
1		状態インジケータ	点灯や点滅によりコンピュータの機能やコンポーネントの状態を知らせる LED です。

左面

2		外部ディスプレイ (VGA) ポート	ディスプレイデバイスに接続します (外付けモニター、LCD プロジェクタなど)。
3		DC 入カジャック	AC アダプタに接続します。
4	HDMI	HDMI ポート	高性能デジタルビデオ接続対応します。
5		通気孔	長時間使用してもコンピュータが過熱しないよう冷却します。
6		USB 2.0 ポート	USB 2.0 デバイスに接続します (USB マウス、USB カメラなど)。

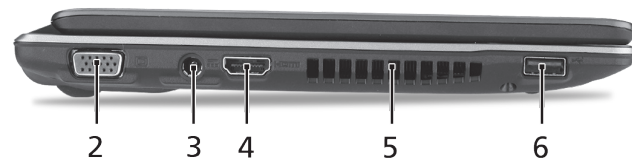

右面

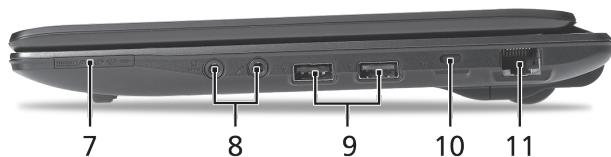

#	アイコン	アイテム	説明
7		1 台多機能のカードリーダー	Secure Digital (SD)、MultiMediaCard (MMC)、メモリスティック (MS)、メモリスティック PRO (MS PRO)、xD-Picture Card (xD) に対応しています。 注意: カード押すとカードを取り出し/装着することができます。一度に 1 個のカードしか操作できません。
8		マイクロフォン入力ジャック	外部マイクロフォンを接続します。
		ヘッドフォン/スピーカー/S/PDIF 対応出力ジャック	オーディオ出力デバイスを接続します (スピーカー、ヘッドフォンなど)。
9		USB 2.0 ポート	USB 2.0 デバイスに接続します (USB マウスなど)。
10		Kensington ロックスロット	Kensington 対応コンピュータセキュリティロックに接続します。
11		Ethernet (RJ-45) ポート	Ethernet 10/100/1000 ベースのネットワークに接続します。

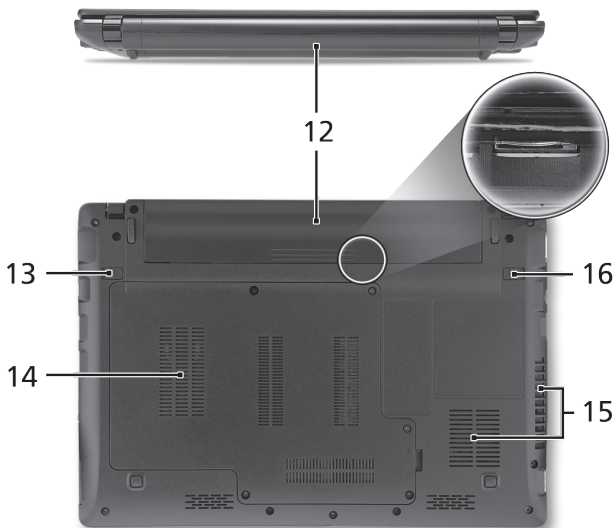

背面 & 底面

12		バッテリーベイ	コンピュータのバッテリーパックを装着します。
13		バッテリー取り外しつまみ	バッテリーを取り出します。
14		ハードディスクベイ	コンピュータのハードディスクを装着します (ネジで固定)。
		メモリコンパートメント	コンピュータのメインメモリを装着します。
15		通気孔スロットと冷却ファン	長時間使用してもコンピュータが過熱しないよう冷却します。 注意: ファンの通気穴を塞いだり、異物を詰め込んだりしないでください。
16		バッテリーロック	バッテリーを定位置にロックします。

環境

温度：

操作時：5°C ~ 35°C

非操作時：-20°C ~ 65°C

湿度 (結露しないこと)：

操作時：20% ~ 80%

非操作時：20% ~ 80%

ASPIRE ONE 시리즈

빠른 시작 설명서

ASPIRE one 시리즈

© 2010 All Rights Reserved

Aspire One 시리즈 빠른 시작 설명서
최초 발행일: 04/2010

Aspire One 시리즈 노트북 PC

모델 번호: _____

일련 번호: _____

구입 날짜: _____

구입 장소: _____

Federal Communications Commission

Declaration of Conformity

This device complies with Part 15 of the FCC Rules. Operation is subject to the following two conditions: (1) this device may not cause harmful interference, and (2) this device must accept any interference received, including interference that may cause undesired operation.

The following local Manufacturer / Importer is responsible for this declaration:

Product name:	Notebook PC
Brand:	Acer
Model number:	MS2296
Machine type:	AO 753 series
Name of Responsible Party:	Acer America Corporation
Address of responsible party:	333 West San Carlos St., San Jose CA 95110, U. S. A.
Contact person:	Acer Representative
Phone No.:	1-254-298-4000
Fax No.:	1-254-298-4147
April 30, 2010	

CE Declaration of Conformity

We,

Acer Incorporated

8F, 88, Sec. 1, Hsin Tai Wu Rd., Hsichih, Taipei Hsien 221, Taiwan

Contact Person: Mr. Easy Lai, e-mail:easy_lai@acer.com.tw

And,

Acer Europe SA

Via Cantonale, Centro Galleria 2 6928 Manno Switzerland

Hereby declare that:

Product: Notebook Computer

Trade Name: Acer

Model Number: MS2296

Machine Type: AO753 series

Is compliant with the essential requirements and other relevant provisions of the following EC directives, and that all the necessary steps have been taken and are in force to assure that production units of the same product will continue comply with the requirements.

EMC Directive 2004/108/EC as attested by conformity with the following harmonized standards:

- EN55022, AS/NZS CISPR22, Class B
- EN55024
- EN61000-3-2 Class D
- EN61000-3-3

Low Voltage Directive 2006/95/EC as attested by conformity with the following harmonized standard:

- EN60950-1

Council Decision 98/482/EC (CTR21):

(Applicable to product with pan- European single terminal connection to the Public Switched Telephone Network (PSTN).)

RoHS Directive 2002/95/EC on the Restriction of the Use of certain Hazardous Substances in Electrical and Electronic Equipment



- The maximum concentration values of the restricted substances by weight in homogenous material are:

Lead	0.1%	Polybrominated Biphenyls (PBB's)	0.1%
Mercury	0.1%	Polybrominated Diphenyl Ethers (PBDE's)	0.1%
Hexavalent Chromium	0.1%	Cadmium	0.01%

Directive 2009/125/EC with regard to establishing a framework for the setting of ecodesign requirements for energy-related product.

R&TTE Directive 1999/5/EC as attested by conformity with the following harmonized standard:

- Article 3.1(a) Health and Safety
 - EN60950-1
 - EN62311
- Article 3.1(b) EMC
 - EN301 489-1
 - EN301 489-3 (Applicable to non-bluetooth wireless keyboard mouse set).
 - EN301 489-7
 - EN301 489-17
 - EN301 489-24
- Article 3.2 Spectrum Usages
 - EN300 440-2 (Applicable to non-bluetooth wireless keyboard mouse set).
 - EN300 328
 - EN301 511
 - EN301 893 (Applicable to 5GHz high performance RLAN).
 - EN301 908-1
 - EN301 908-2

Year to begin affixing CE marking 2010.

Easy Lai

Easy Lai /Manager
Regulation Center, Acer Inc.

Apr. 30, 2010

Date

사용을 위한 준비

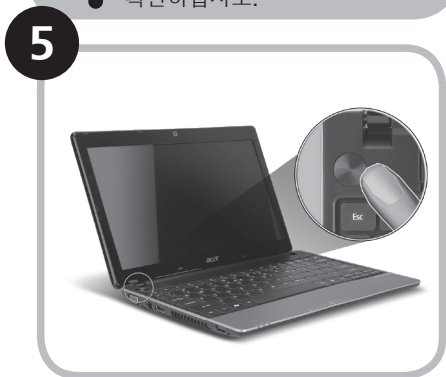
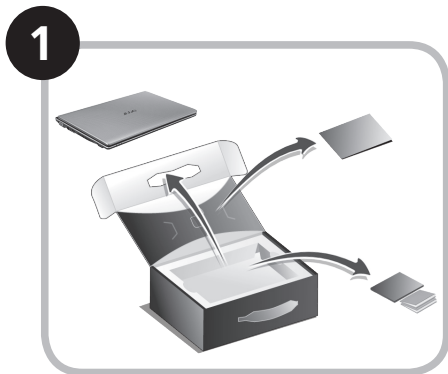

이 그림들은 참고 목적으로만 제공되며, 실제 제품 사양은 이와 다를 수 있습니다.

사용 전 유의 사항

Acer 노트북을 선택해주셔서 감사합니다. 이 노트북이 귀하의 모바일 컴퓨팅 요구를 충족시켜 드릴 것입니다.

제공되는 설명서

Acer 노트북을 사용하는 데 도움을 줄 수 있는 여러 설명서가 제공됩니다*.

우선 빠른 시작 설명서는 컴퓨터 설정을 시작하는 데 유용합니다.

컴퓨터를 좀더 생산적으로 활용하는 방법에 대한 자세한 내용은 **AcerSystem User Guide**를 참조하십시오. 이 설명서에서는 시스템 유틸리티, 데이터 복구, 확장 옵션 및 문제 해결과 같은 주제를 자세하게 설명합니다. 또한 노트북에 대한 일반 규정과 안전 주의 사항 및 보증 정보가 포함되어 있습니다. 이 설명서는 **PDF (Portable Document Format)** 파일로 제공되며 노트북에 이미 설치되어 있습니다.



참고: 이 파일을 보려면 **Adobe Reader**가 필요합니다. 컴퓨터에 **Adobe Reader**가 설치되어 있지 않은 경우 **AcerSystem User Guide**를 클릭하면 자동으로 **Adobe Reader** 설치 프로그램이 실행됩니다. 화면의 지시에 따라 나머지 설치 과정을 완료합니다. **Adobe Reader** 사용 방법에 대한 지침을 보려면 **Help and Support (도움말 및 지원)** 메뉴에 액세스하십시오.



* 알림: 여기에 언급된 인쇄물 형태 또는 전자적 형태의 모든 설명서는 참고용으로만 제공됩니다. **AcerSystem User Guide**에 포함된 특정 보증 정보에 제공된 사항을 제외하고, 이러한 설명서의 어떠한 부분도 귀하가 구매한 제품과 관련한 **Acer**의 책임이나 보증을 나타내지 않습니다. **Acer**는 이들 설명서에 포함된 오류에 대해 어떠한 책임도 지지 않습니다.

네트워크 구성

여기에서는 인터넷에 연결할 수 있도록 LAN 및 무선 네트워크 설정을 구성하는 방법을 설명합니다.

LAN 연결 설정

LAN 케이블을 이더넷 (RJ-45) 포트에 연결하기만 하면 됩니다. 이더넷 포트의 위치를 알려면 6페이지의 "오른쪽 모습"을 참조하십시오.

무선 연결 설정

1. 통신 관리자에 액세스하려면 <Fn>+<F3>을 누르십시오. 여기에서 Wi-Fi 옆에 있는 빨간색 단추를 클릭하여 Wi-Fi 연결을 켤 수 있습니다.

참고: 3G 및 Bluetooth는 통신 관리자를 통해 액세스할 수도 있습니다. 통신 장치는 모델에 따라 다를 수 있습니다.

2. 시스템 트레이에서  아이콘을 클릭하고 연결할 무선 액세스 지점을 선택하십시오.



3G SIM 카드 삽입 (특정 모델에만 해당)

배터리를 제거하고 3G SIM 카드 슬롯에 3G SIM 카드를 주의해서 삽입하십시오. 3G SIM 슬롯의 위치를 알려면 6페이지의 "뒤쪽 및 바닥 모습"을 참조하십시오.

Aspire One 둘러보기

사용을 위한 준비 단원에 설명된 대로 컴퓨터를 설정했으면 이제 새 Acer 노트북을 살펴볼 차례입니다.

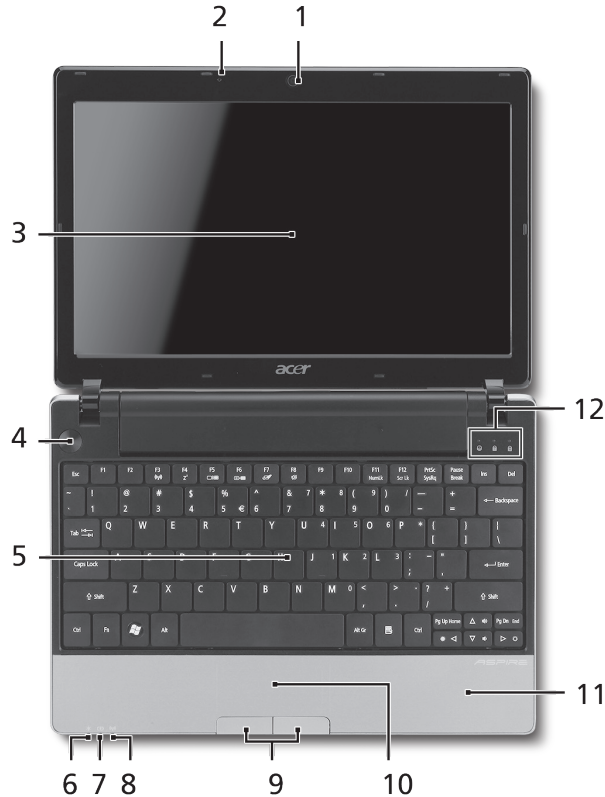

위에서 본 모습





#	아이콘	항목	설명									
1		Acer Crystal Eye 웹캠	비디오 통신용 웹 카메라입니다(구성은 모델에 따라 다를 수 있습니다).									
2		마이크	소리를 녹음할 수 있는 내부 마이크입니다.									
3		디스플레이 화면	LCD (액정 디스플레이) 라고도 하며, 컴퓨터 출력을 표시합니다 (구성은 모델에 따라 다를 수 있습니다).									
4		전원 단추	컴퓨터를 켜고 끕니다.									
5		키보드	컴퓨터에 데이터를 입력하는 데 사용됩니다.									
6		전원 표시등 ¹	컴퓨터의 전원 상태를 표시합니다.									
7		배터리 표시등 ¹	컴퓨터의 배터리 상태를 표시합니다. 1. 충전 중: 배터리가 충전 중이면 황색 불이 켜집니다. 2. 충전 완료: AC 모드일 때 파란 불이 켜집니다.									
8		통신 표시등 ¹	3G/무선 LAN 통신 상태를 표시합니다.									
			<table border="1"> <thead> <tr> <th>파란색 표시등 켜짐</th> <th>주황색 표시등 켜짐</th> <th>불 켜지지 않음</th> </tr> </thead> <tbody> <tr> <td>3G 켜짐 / WiFi 켜짐</td> <td>3G 꺼짐 / WiFi 켜짐</td> <td>3G 꺼짐 / WiFi 꺼짐</td> </tr> <tr> <td>3G 켜짐 / WiFi 꺼짐</td> <td></td> <td></td> </tr> </tbody> </table>	파란색 표시등 켜짐	주황색 표시등 켜짐	불 켜지지 않음	3G 켜짐 / WiFi 켜짐	3G 꺼짐 / WiFi 켜짐	3G 꺼짐 / WiFi 꺼짐	3G 켜짐 / WiFi 꺼짐		
파란색 표시등 켜짐	주황색 표시등 켜짐	불 켜지지 않음										
3G 켜짐 / WiFi 켜짐	3G 꺼짐 / WiFi 켜짐	3G 꺼짐 / WiFi 꺼짐										
3G 켜짐 / WiFi 꺼짐												
9		누름 단추들 (왼쪽 및 오른쪽)	왼쪽과 오른쪽의 단추는 마우스의 왼쪽 및 오른쪽 단추와 같은 역할을 합니다.									
10		터치패드	컴퓨터 마우스와 같은 역할을 하는 접촉식 포인팅 장치입니다.									
11		손목 받침대	컴퓨터를 사용할 때 편안하게 손을 올려 놓는 영역입니다.									
12		HDD 표시등	하드 디스크 드라이브가 동작 중이면 불이 켜집니다.									
		Num Lock	Num Lock이 활성화되어 있으면 불이 켜집니다.									
		Caps Lock	Caps Lock이 활성화되어 있으면 불이 켜집니다.									

1. 전면 패널 표시등은 컴퓨터 덮개를 닫은 상태에서도 볼 수 있습니다.

닫힌 상태의 앞 모습

#	아이콘	항목	설명
1		상태 표시등	컴퓨터의 기능과 구성 요소의 상태를 알려주는 LED (발광 다이오드)입니다.

왼쪽 모습

2		외부 디스플레이 (VGA) 포트	디스플레이 장치 (예: 외부 모니터, LCD 프로젝터)를 연결합니다.
3		DC 입력 잭	AC 어댑터에 연결합니다.
4		HDMI 포트	고선명 디지털 비디오 연결을 지원합니다.
5		통풍용 슬롯	장시간 사용한 후에도 컴퓨터를 차갑게 유지할 수 있습니다.
6		USB 2.0 포트	USB 2.0 장치 (예: USB 마우스, USB 카메라)에 연결합니다.

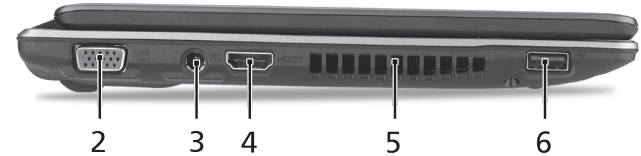

오른쪽 모습

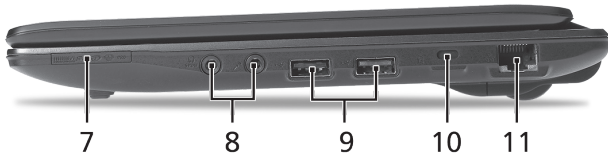

#	아이콘	항목	설명
7		멀티 카드 판독기	Secure Digital (SD), MultiMediaCard (MMC), Memory Stick (MS), Memory Stick PRO (MS PRO) 및 xD-Picture Card (xD)를 사용할 수 있습니다. 참고: 카드를 눌러 제거 또는 설치합니다. 카드를 한 번에 하나만 사용할 수 있습니다.
8		마이크 입력 잭	외부 마이크로 소리를 입력할 때 사용합니다.
		헤드폰/스피커/S/PDIF를 지원하는 출력 잭	오디오 출력 장치에 연결합니다(예: 스피커, 헤드폰).
9		USB 2.0 포트	USB 2.0 장치 (예: USB 마우스)에 연결합니다.
10		Kensington 잠금 장치 슬롯	Kensington 호환 컴퓨터 보호용 잠금 장치를 연결합니다.
11		이더넷 (RJ-45) 포트	10/100/1000 이더넷 네트워크에 연결합니다.

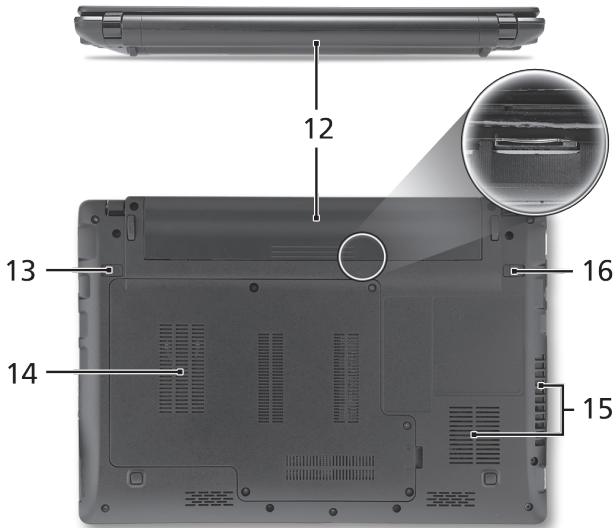

뒤쪽 및 바닥 모습

12		배터리 장착부	컴퓨터의 배터리 팩을 넣습니다.
13		배터리 제거용 래치	제거를 위해 배터리를 뺄 때 사용합니다.
14		하드 디스크 장착부	컴퓨터의 하드 디스크를 넣습니다 (나사로 고정).
		메모리 장착부	컴퓨터의 주 메모리를 넣습니다.
15		통풍용 슬롯 및 냉각 팬	장시간 사용한 후에 도 컴퓨터를 차갑게 유지할 수 있습니다. 참고: 팬의 입구를 막거나 차단하지 마십시오.
16		배터리 잠금	장착된 배터리를 빠지지 않도록 잠급니다.

환경

온도:

작동: 5°C ~ 35°C

비작동: -20°C ~ 65°C

습도 (비응축):

작동: 20% ~ 80%

비작동: 20% ~ 80%

ASPIRE ONE 系列

快速使用指南

ASPIRE One 系列

© 2010 版權所有

Aspire One 系列快速使用指南
初版：04/2010

Aspire One 系列筆記型電腦

產品型號： _____

產品序號： _____

購買日期： _____

購買地點： _____

Federal Communications Commission

Declaration of Conformity

This device complies with Part 15 of the FCC Rules. Operation is subject to the following two conditions: (1) this device may not cause harmful interference, and (2) this device must accept any interference received, including interference that may cause undesired operation.

The following local Manufacturer / Importer is responsible for this declaration:

Product name:	Notebook PC
Brand:	Acer
Model number:	MS2296
Machine type:	AO 753 series
Name of Responsible Party:	Acer America Corporation
Address of responsible party:	333 West San Carlos St., San Jose CA 95110, U. S. A.
Contact person:	Acer Representative
Phone No.:	1-254-298-4000
Fax No.:	1-254-298-4147
April 30, 2010	

CE Declaration of Conformity

We,

Acer Incorporated

8F, 88, Sec. 1, Hsin Tai Wu Rd., Hsichih, Taipei Hsien 221, Taiwan

Contact Person: Mr. Easy Lai, e-mail:easy_lai@acer.com.tw

And,

Acer Europe SA

Via Cantonale, Centro Galleria 2 6928 Manno Switzerland

Hereby declare that:

Product: Notebook Computer

Trade Name: Acer

Model Number: MS2296

Machine Type: AO753 series

Is compliant with the essential requirements and other relevant provisions of the following EC directives, and that all the necessary steps have been taken and are in force to assure that production units of the same product will continue comply with the requirements.

EMC Directive 2004/108/EC as attested by conformity with the following harmonized standards:

- EN55022, AS/NZS CISPR22, Class B
- EN55024
- EN61000-3-2 Class D
- EN61000-3-3

Low Voltage Directive 2006/95/EC as attested by conformity with the following harmonized standard:

- EN60950-1

Council Decision 98/482/EC (CTR21):

(Applicable to product with pan- European single terminal connection to the Public Switched Telephone Network (PSTN).)

RoHS Directive 2002/95/EC on the Restriction of the Use of certain Hazardous Substances in Electrical and Electronic Equipment



- The maximum concentration values of the restricted substances by weight in homogenous material are:

Lead	0.1%	Polybrominated Biphenyls (PBB's)	0.1%
Mercury	0.1%	Polybrominated Diphenyl Ethers (PBDE's)	0.1%
Hexavalent Chromium	0.1%	Cadmium	0.01%

Directive 2009/125/EC with regard to establishing a framework for the setting of ecodesign requirements for energy-related product.

R&TTE Directive 1999/5/EC as attested by conformity with the following harmonized standard:

- Article 3.1(a) Health and Safety
 - EN60950-1
 - EN62311
- Article 3.1(b) EMC
 - EN301 489-1
 - EN301 489-3 (Applicable to non-bluetooth wireless keyboard mouse set).
 - EN301 489-7
 - EN301 489-17
 - EN301 489-24
- Article 3.2 Spectrum Usages
 - EN300 440-2 (Applicable to non-bluetooth wireless keyboard mouse set).
 - EN300 328
 - EN301 511
 - EN301 893 (Applicable to 5GHz high performance RLAN).
 - EN301 908-1
 - EN301 908-2

Year to begin affixing CE marking 2010.

Easy Lai

Easy Lai /Manager
Regulation Center, Acer Inc.

Apr. 30, 2010

Date

新手入門

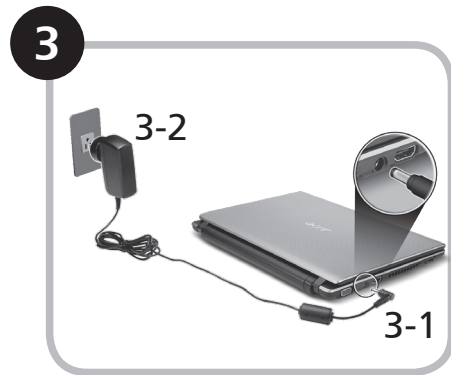
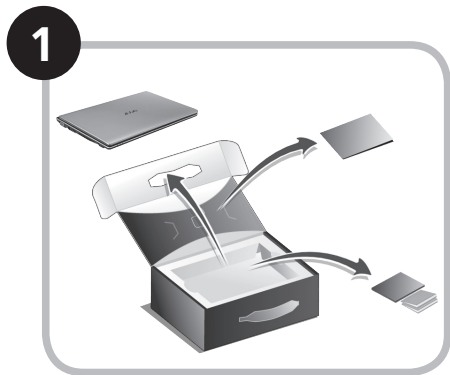

所有插圖僅供參考。實際產品規格可能有所不同。

初步設定

首先，感謝您選擇 Acer 筆記型電腦，其會是滿足您行動運算需求的最佳首選。

使用指南

為了協助您了解使用 Acer 筆記型電腦的方式，我們設計了一系列的指南*：

首先，快速使用指南可協助您開始設定您的電腦。

如需更多關於讓電腦協助您提升生產力的資訊，請參閱 **AcerSystem User Guide**。本指南包含系統公用程式、資料復原、擴充選項及疑難排解等主題的詳細資訊。此外，本指南也包含筆記型電腦的保固資訊、一般規範及安全注意事項。該文件以「可攜式文件格式」(PDF) 提供，並已預載在您的筆記型電腦上。



注意：您需要安裝 Adobe Reader 才可檢視此檔案。如果電腦尚未安裝 Adobe Reader，請先按一下 **AcerSystem User Guide**，便會開始執行 Adobe Reader 設定程式。請遵循畫面上的指示完成安裝程序。如需了解使用 Adobe Reader 的方式，請存取說明及支援功能表。



* **重要聲明**：請注意，此處所提及之指南 (無論是以印刷或電子版形式呈現) 僅供參考之用；除了 **AcerSystem User Guide** 中所包含的特定保固資訊以外，Acer 不會因為這些指南中的任何內容而針對您所購買的產品提供任何聲明或保固。明確來說，Acer 對於指南中所包含的任何錯誤均不負相關責任。

網路設定

本指南將會協助您配置區域網路及無線網路設定，讓您可連線到網際網路。

設定區域網路連線

只要將區域網路纜線插入乙太網路 (RJ-45) 連接埠即可。如需了解乙太網路連接埠之位置的資訊，請參閱第 6 頁的「右視圖」。

設定無線網路連線

1. 按下 <Fn> + <F3> 可存取通訊管理員。您可以在此處按一下 Wi-Fi 旁的紅色按鈕，開啓 Wi-Fi 連線功能。

注意：也可以透過通訊管理員存取 3G 和藍牙功能。通訊裝置將依機型而有所不同。

2. 按一下系統匣上的  圖示，然後選擇想要連線的無線網路存取點。

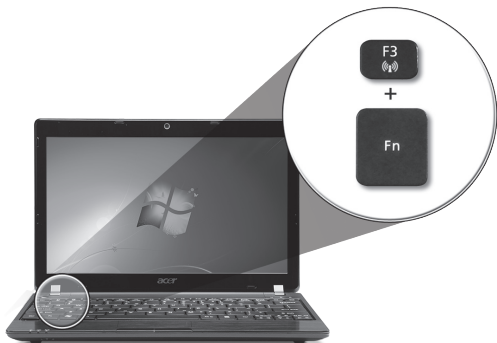

插入 3G SIM 卡 (僅適用於特定機型)

將電池卸下，並將 3G SIM 卡小心地插入 3G SIM 卡插槽中。如需了解 3G SIM 卡插槽之位置的資訊，請參閱第 6 頁的「後視圖及底視圖」。

Aspire One 導覽

在依照新手入門一節中所提及的說明完成電腦的設定之後，就讓我們為您展示一下全新 Acer 筆記型電腦的各項功能吧！

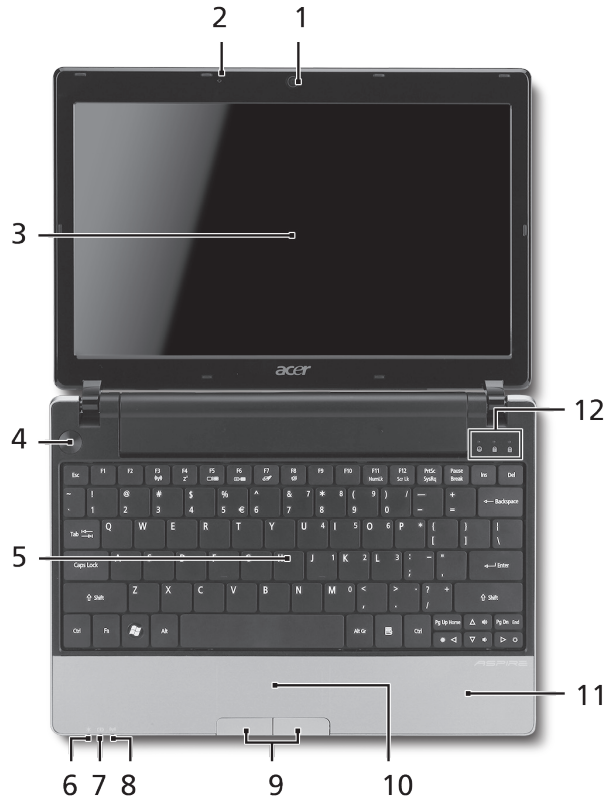

上視圖



#	圖示	項目	說明									
1		Acer Crystal Eye 網路攝影機	網路相機，可用於視訊通訊 (設定將依機型而有所不同)。									
2		麥克風	內建的麥克風，用於錄音。									
3		顯示螢幕	亦稱為液晶顯示器 (Liquid-Crystal Display ; LCD)，用於顯示電腦資料的輸出 (設定將依機型而有所不同)。									
4		電源鍵	開啓和關閉電腦。									
5		鍵盤	可用來將資料輸入電腦。									
6		電源指示燈 ¹	表示電腦的電源狀態。									
7		電池指示燈 ¹	表示電腦的電池狀態。 1. 充電中：當電池充電時，指示燈會亮琥珀色。 2. 充電完畢：當使用 AC 電源模式時，指示燈會亮藍色。									
8		通訊指示燈 ¹	指示 3G/無線區域網路通訊的狀態。 <table border="1" data-bbox="1114 613 1522 700"> <thead> <tr> <th>亮藍色</th> <th>亮橘色</th> <th>未亮起</th> </tr> </thead> <tbody> <tr> <td>3G 開啓 / WiFi 開啓</td> <td>3G 關閉 / WiFi 開啓</td> <td>3G 關閉 / WiFi 關閉</td> </tr> <tr> <td>3G 開啓 / WiFi 關閉</td> <td>WiFi 開啓</td> <td>WiFi 關閉</td> </tr> </tbody> </table>	亮藍色	亮橘色	未亮起	3G 開啓 / WiFi 開啓	3G 關閉 / WiFi 開啓	3G 關閉 / WiFi 關閉	3G 開啓 / WiFi 關閉	WiFi 開啓	WiFi 關閉
亮藍色	亮橘色	未亮起										
3G 開啓 / WiFi 開啓	3G 關閉 / WiFi 開啓	3G 關閉 / WiFi 關閉										
3G 開啓 / WiFi 關閉	WiFi 開啓	WiFi 關閉										
9		點選鍵 (左和右)	左鍵和右鍵的功能等同於滑鼠的左鍵和右鍵。									
10		觸控板	觸控感應式移動游標裝置，功能等同於電腦的滑鼠。									
11		腕靠	讓您在使用的電腦時，可舒適擺放手腕的位置。									
12		硬碟指示燈	當存取硬碟時，指示燈會亮起。									
		Num Lock	Num Lock 功能啓用時，指示燈會亮起。									
		Caps Lock	Caps Lock 功能啓用時，指示燈會亮起。									

1. 即使在電腦螢幕關上時，您依然可看見位於前面板的狀態指示燈。

上蓋闔起的前視圖

#	圖示	項目	說明
1		狀態指示燈	以 LED (Light-Emitting Diodes : 發光二極體) 亮燈的方式來顯示電腦功能及元件的狀態。

左視圖

2		外接顯示螢幕 (VGA) 連接埠	連接到顯示器裝置 (例如外接式顯示器、LCD 投影機)。
3		DC 輸入插孔	連接到 AC 變壓器。
4	HDMI	HDMI 埠	支援高清晰度數位視訊連線。
5		通風槽	可讓電腦在長時間使用後仍然能夠保持冷卻狀態。
6		USB 2.0 埠	連接至 USB 2.0 裝置 (例如, USB 滑鼠、USB 攝影機)。

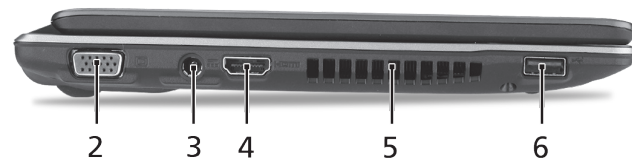

右視圖

#	圖示	項目	說明
7		多合一讀卡機	可支援 Secure Digital (SD)、MultiMediaCard (MMC)、Memory Stick (MS)、Memory Stick PRO (MS PRO)、xD-Picture Card (xD)。注意：推一下即可取出/安裝記憶卡。任何時候皆僅能夠使用一張記憶卡。
8		麥克風輸入插孔	接受從外接麥克風所輸入的聲音。
		耳機/喇叭/音訊輸出插孔 (支援 S/PDIF)	連接外接音訊輸出裝置的插孔 (例如：喇叭、耳機)。
9		USB 2.0 埠	連接到 USB 2.0 裝置 (例如 USB 滑鼠)。
10		Kensington 安全鎖插槽	連接到與 Kensington 相容的電腦安全鎖。
11		乙太網路 (RJ-45) 連接埠	連線到 10/100/1000 基礎的乙太網路。

後視圖及底視圖

12		電池槽	用於安裝電腦的電池組。
13		電池卸除卡榫	用於卸下電池組。
14		硬碟槽	用於安裝電腦的硬碟 (以螺絲固定)。
		記憶體槽	用於安裝電腦的主記憶體。
15		散熱孔和冷卻風扇	可讓電腦在長時間使用後仍然能夠保持冷卻狀態。注意：請勿阻塞或擋住風扇開口。
16		電池組固定鎖	可將電池鎖到定位。

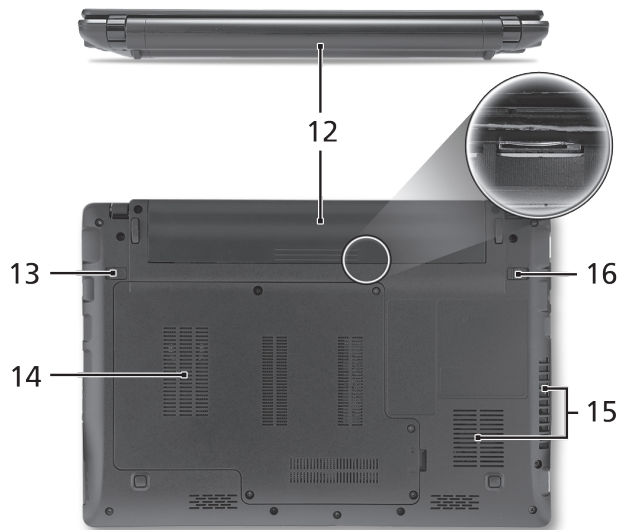
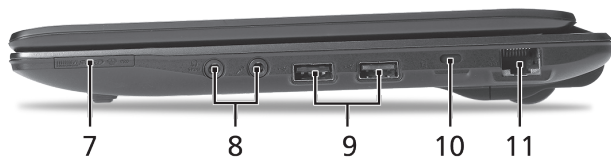

環境

溫度：

操作中：5°C 到 35°C

非操作中：-20°C 到 65°C

溼度 (非冷凝狀態)：

操作中：20% 到 80%

非操作中：20% 到 80%

ASPIRE ONE 系列
快速指南

ASPIRE One 系列

© 2010 保留所有权利

Aspire One 系列快速指南
初版发行日期：04/2010

Aspire One 系列笔记本电脑

产品型号： _____

产品序号： _____

购买日期： _____

购买地点： _____

Federal Communications Commission

Declaration of Conformity

This device complies with Part 15 of the FCC Rules. Operation is subject to the following two conditions: (1) this device may not cause harmful interference, and (2) this device must accept any interference received, including interference that may cause undesired operation.

The following local Manufacturer / Importer is responsible for this declaration:

Product name:	Notebook PC
Brand:	Acer
Model number:	MS2296
Machine type:	AO 753 series
Name of Responsible Party:	Acer America Corporation
Address of responsible party:	333 West San Carlos St., San Jose CA 95110, U. S. A.
Contact person:	Acer Representative
Phone No.:	1-254-298-4000
Fax No.:	1-254-298-4147
April 30, 2010	

CE Declaration of Conformity

We,

Acer Incorporated

8F, 88, Sec. 1, Hsin Tai Wu Rd., Hsichih, Taipei Hsien 221, Taiwan

Contact Person: Mr. Easy Lai, e-mail:easy_lai@acer.com.tw

And,

Acer Europe SA

Via Cantonale, Centro Galleria 2 6928 Manno Switzerland

Hereby declare that:

Product: Notebook Computer

Trade Name: Acer

Model Number: MS2296

Machine Type: AO753 series

Is compliant with the essential requirements and other relevant provisions of the following EC directives, and that all the necessary steps have been taken and are in force to assure that production units of the same product will continue comply with the requirements.

EMC Directive 2004/108/EC as attested by conformity with the following harmonized standards:

- EN55022, AS/NZS CISPR22, Class B
- EN55024
- EN61000-3-2 Class D
- EN61000-3-3

Low Voltage Directive 2006/95/EC as attested by conformity with the following harmonized standard:

- EN60950-1

Council Decision 98/482/EC (CTR21):

(Applicable to product with pan- European single terminal connection to the Public Switched Telephone Network (PSTN).)

RoHS Directive 2002/95/EC on the Restriction of the Use of certain Hazardous Substances in Electrical and Electronic Equipment



- The maximum concentration values of the restricted substances by weight in homogenous material are:

Lead	0.1%	Polybrominated Biphenyls (PBB's)	0.1%
Mercury	0.1%	Polybrominated Diphenyl Ethers (PBDE's)	0.1%
Hexavalent Chromium	0.1%	Cadmium	0.01%

Directive 2009/125/EC with regard to establishing a framework for the setting of ecodesign requirements for energy-related product.

R&TTE Directive 1999/5/EC as attested by conformity with the following harmonized standard:

- Article 3.1(a) Health and Safety
 - EN60950-1
 - EN62311
- Article 3.1(b) EMC
 - EN301 489-1
 - EN301 489-3 (Applicable to non-bluetooth wireless keyboard mouse set).
 - EN301 489-7
 - EN301 489-17
 - EN301 489-24
- Article 3.2 Spectrum Usages
 - EN300 440-2 (Applicable to non-bluetooth wireless keyboard mouse set).
 - EN300 328
 - EN301 511
 - EN301 893 (Applicable to 5GHz high performance RLAN).
 - EN301 908-1
 - EN301 908-2

Year to begin affixing CE marking 2010.

Easy Lai

Easy Lai /Manager
Regulation Center, Acer Inc.

Apr. 30, 2010

Date

初学者入门

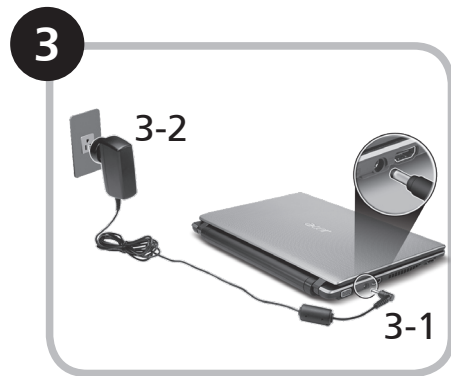
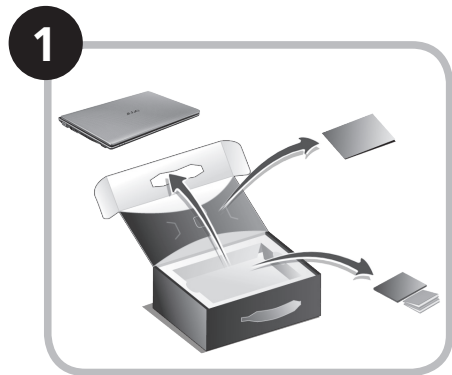

图例仅供参考。产品实际规格将以用户实际购买为准。

使用入门

感谢您选购 Acer 笔记本电脑，让它满足您随时随地使用计算机的需要。

用户指南

为帮助您使用 Acer 笔记本电脑，我们专门设计了一套指南*：

首先，“快速指南”将指导您对电脑进行设置。

要了解关于您的电脑如何能够帮助您提高工作效率的详细信息，请参见“AcerSystem User Guide”。本指南包含了诸如系统实用程序、数据恢复、扩展选项和疑难解答等详细信息。此外，它还包含了保修信息和笔记本电脑的一般规则和安全注意事项。我们也提供了 PDF 格式的用户指南并已预先安装在本电脑中供用户参考。



注意：查看 PDF 文件需要安装 Adobe Reader。如果您的电脑上没有安装 Adobe Reader，单击“AcerSystem User Guide”将会先启动 Adobe Reader 安装程序。依屏幕上指导完成安装程序。有关如何使用 Adobe Reader 的说明，请参见“帮助和支持”菜单。



*重要须知：请注意，本手册中所提及的指南，无论是印刷或电子版本，均仅供参考，“AcerSystem User Guide”中包含的特定保证信息除外。指南中包含的任何信息均不构成 Acer 对您所购产品的陈述或保证。Acer 对指南中包含的错误不承担任何责任。

网络配置

本指南将帮助您配置 LAN 和无线网络设置，以便连接至 Internet。

设置 LAN 连接

只需将 LAN 线缆插入以太网 (RJ-45) 端口即可。以太网端口位置请参见第 6 页的“右视图”。

设置无线连接

1. 按 <Fn> + <F3> 可进入通信管理器。在此处单击 Wi-Fi 旁的红色按钮可开启 Wi-Fi 连接。

注：通过通信管理器还可以使用 3G 和蓝牙。通信设备根据型号有所不同。

2. 单击系统托盘上的  图标，选择要连接的无线接入点。

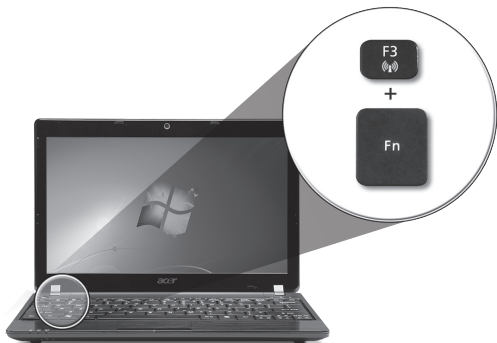

插入 3G SIM 卡 (仅限部分型号)

取出电池并将 3G SIM 卡小心地插入 3G SIM 卡槽。请参见第 6 页的“后视图 & 底视图”以了解 3G SIM 卡槽的位置。

了解 Aspire One

按照初学者入门章节中的图示完成计算机安装后，让我们带您认识一下您新购的 Acer 笔记本电脑。

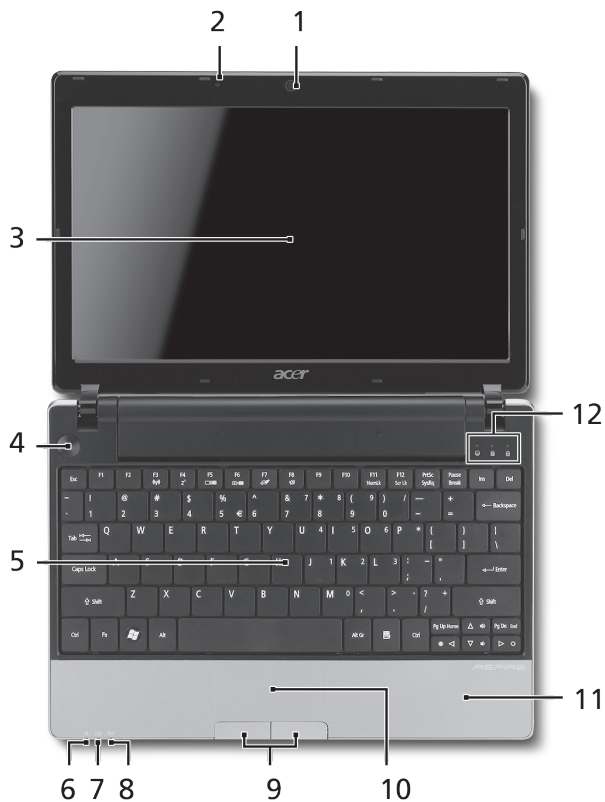

俯视图



#	图标	项目	描述									
1		Acer Crystal Eye 摄像头	网络相机，用于视频通信 (不同型号配置可能有所不同)。									
2		麦克风	用于录音的内置麦克风。									
3		显示屏	也称液晶显示屏 (Liquid-Crystal Display; LCD)，用于显示电脑的输出内容 (不同型号配置可能有所不同)。									
4		电源键	用于打开和关闭计算机电源。									
5		键盘	将数据输入到电脑中。									
6		电源指示灯 ¹	表示计算机的电源状态。									
7		电池指示灯 ¹	表示计算机的电池状态。 1. 正在充电: 当电池在充电时，指示灯显示琥珀色。 2. 完全充电: 当处在 AC 模式时，指示灯显示蓝色。									
8		通信指示灯 ¹	根据亮灯情况可检视目前无线 LAN/3G 通信的状态。 <table border="1" data-bbox="1070 636 1501 721"> <thead> <tr> <th>蓝灯亮</th> <th>橙灯亮</th> <th>不亮</th> </tr> </thead> <tbody> <tr> <td>3G 开/WiFi 开</td> <td>3G 关/WiFi 开</td> <td>3G 关/WiFi 关</td> </tr> <tr> <td>3G 开/WiFi 关</td> <td></td> <td></td> </tr> </tbody> </table>	蓝灯亮	橙灯亮	不亮	3G 开/WiFi 开	3G 关/WiFi 开	3G 关/WiFi 关	3G 开/WiFi 关		
蓝灯亮	橙灯亮	不亮										
3G 开/WiFi 开	3G 关/WiFi 开	3G 关/WiFi 关										
3G 开/WiFi 关												
9		单击按钮 (左和右)	左右按钮的功能与鼠标的左右键相同。									
10		触控板	触摸式定位设备，功能和电脑鼠标相同。									
11		掌垫板	当您使用电脑时，可舒适支撑手部的区域。									
12		硬盘指示灯	硬盘活动时，该指示灯亮。									
		Num Lock	当 Num Lock 键启用时，该指示灯亮。									
		Caps Lock	当 Caps Lock 键启用时，该指示灯亮。									

1. 即使计算机外盖合上，也能看到前面板的状态指示灯。

前视图

#	图标	项目	描述
1		状态指示灯	通过亮灭显示计算机功能及组件状态的发光二极管 (LED)。

左视图

2		外部显示器 (VGA) 端口	连接显示设备 (例如外接显示器、LCD 投影机)。
3		直流电源输入插孔	连接交流适配器。
4	HDMI	HDMI 端口	支持高清晰数字视频连接。
5		通风槽	可使电脑在长时间使用后仍保持低温。
6		USB 2.0 端口	连接 USB 2.0 设备 (例如, USB 鼠标、USB 相机)。

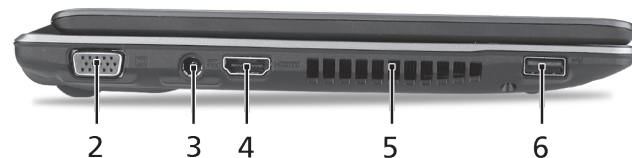

右视图

#	图标	项目	描述
7		多合 1 读卡器	可支持安全数码卡 (SD)、多媒体卡 (MMC)、记忆棒 (MS)、PRO 记忆棒 (MS PRO) 及 xD-Picture 卡 (xD)。注意：轻推取下/安装存储卡。一次只能使用一张卡。
8		麦克风输入插孔	连接外接麦克风。
		支持 S/PDIF 的耳机/扬声器/音频输出插孔	连接音频输出设备 (例如：扬声器、耳机)。
9		USB 2.0 端口	连接 USB 2.0 设备 (例如 USB 鼠标)。
10		Kensington 安全锁插槽	连接 Kensington 兼容电脑安全锁。
11		以太网 (RJ-45) 端口	连接 10/100/1000 以太网。

后视图 & 底视图

12		电池槽	安装电池组。
13		电池释放门锁	释放电池门锁可取下电池组。
14		硬盘槽	安装电脑硬盘的位置 (用螺丝紧固)。
		内存槽	安装电脑主内存的位置。
15		通风槽和冷却风扇	可使电脑在长时间使用后仍保持低温。 注意：请勿遮挡风扇口。
16		电池锁	可固定锁紧电池组。

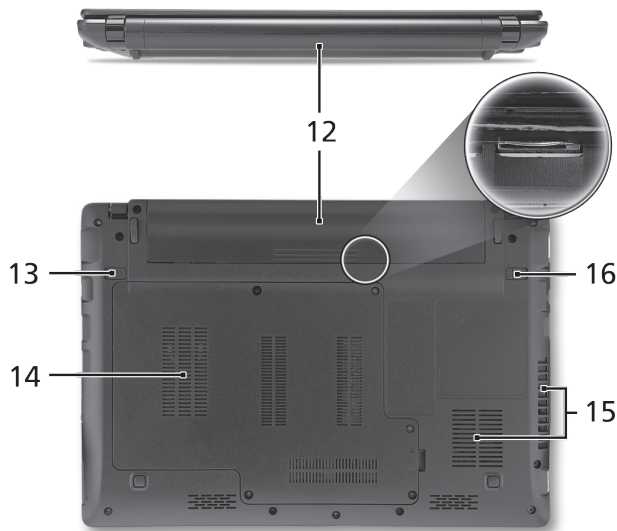
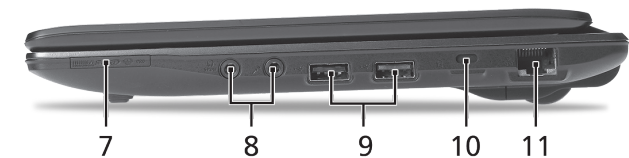

环境

温度:

操作时: 5°C - 35°C

不操作时: -20°C - 65°C

湿度 (非冷凝):

操作时: 20% - 80%

不操作时: 20% - 80%

Seri **ASPIRE** ONE

Panduan cepat

Seri **ASPIRE** *one*

© 2010 Hak Cipta Dilindungi Undang-Undang

Panduan Cepat Seri *Aspire One*
Edisi Pertama: 04/2010

PC Notebook Seri *Aspire One*

Nomor model: _____

Nomor seri: _____

Tanggal pembelian: _____

Alamat pembelian: _____

Federal Communications Commission

Declaration of Conformity

This device complies with Part 15 of the FCC Rules. Operation is subject to the following two conditions: (1) this device may not cause harmful interference, and (2) this device must accept any interference received, including interference that may cause undesired operation.

The following local Manufacturer / Importer is responsible for this declaration:

Product name:	Notebook PC
Brand:	Acer
Model number:	MS2296
Machine type:	<i>AO 753 series</i>
Name of Responsible Party:	Acer America Corporation
Address of responsible party:	333 West San Carlos St., San Jose CA 95110, U. S. A.
Contact person:	Acer Representative
Phone No.:	1-254-298-4000
Fax No.:	1-254-298-4147
April 30, 2010	

CE Declaration of Conformity

We,

Acer Incorporated

8F, 88, Sec. 1, Hsin Tai Wu Rd., Hsichih, Taipei Hsien 221, Taiwan

Contact Person: Mr. Easy Lai, e-mail:easy_lai@acer.com.tw



And,

Acer Europe SA

Via Cantonale, Centro Galleria 2 6928 Manno Switzerland

Hereby declare that:

Product: Notebook Computer

Trade Name: Acer

Model Number: MS2296

Machine Type: AO753 series

Is compliant with the essential requirements and other relevant provisions of the following EC directives, and that all the necessary steps have been taken and are in force to assure that production units of the same product will continue comply with the requirements.

EMC Directive 2004/108/EC as attested by conformity with the following harmonized standards:

- EN55022, AS/NZS CISPR22, Class B
- EN55024
- EN61000-3-2 Class D
- EN61000-3-3

Low Voltage Directive 2006/95/EC as attested by conformity with the following harmonized standard:

- EN60950-1

Council Decision 98/482/EC (CTR21):

(Applicable to product with pan- European single terminal connection to the Public Switched Telephone Network (PSTN).)

RoHS Directive 2002/95/EC on the Restriction of the Use of certain Hazardous Substances in Electrical and Electronic Equipment

- The maximum concentration values of the restricted substances by weight in homogenous material are:

Lead	0.1%	Polybrominated Biphenyls (PBB's)	0.1%
Mercury	0.1%	Polybrominated Diphenyl Ethers (PBDE's)	0.1%
Hexavalent Chromium	0.1%	Cadmium	0.01%

Directive 2009/125/EC with regard to establishing a framework for the setting of ecodesign requirements for energy-related product.

R&TTE Directive 1999/5/EC as attested by conformity with the following harmonized standard:

- Article 3.1(a) Health and Safety
 - EN60950-1
 - EN62311
- Article 3.1(b) EMC
 - EN301 489-1
 - EN301 489-3 (Applicable to non-bluetooth wireless keyboard mouse set).
 - EN301 489-7
 - EN301 489-17
 - EN301 489-24
- Article 3.2 Spectrum Usages
 - EN300 440-2 (Applicable to non-bluetooth wireless keyboard mouse set).
 - EN300 328
 - EN301 511
 - EN301 893 (Applicable to 5GHz high performance RLAN).
 - EN301 908-1
 - EN301 908-2

Year to begin affixing CE marking 2010.

Easy Lai

Easy Lai /Manager
Regulation Center, Acer Inc.

Apr. 30, 2010

Date

Persiapan

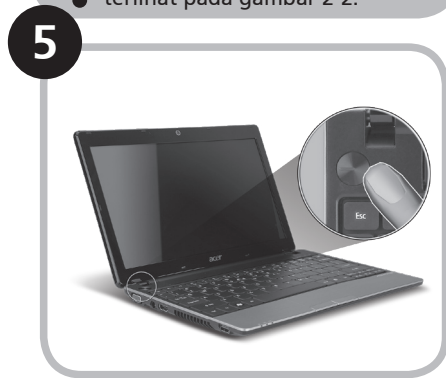
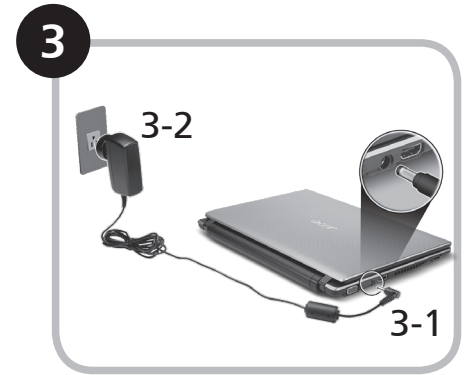
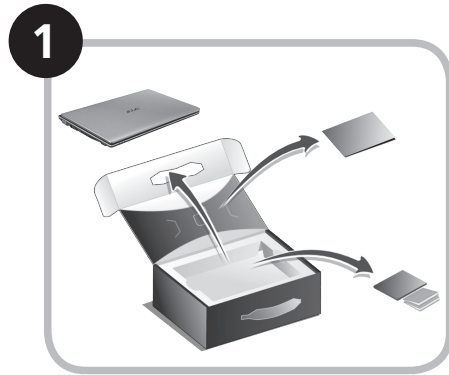

Gambar ilustrasi hanya sebagai referensi. Spesifikasi produk sebenarnya mungkin berbeda.

Informasi penting

Kami mengucapkan terima kasih kepada Anda yang telah memilih notebook Acer untuk memenuhi kebutuhan Anda akan komputer.

Panduan Anda

Kami telah mendesain serangkaian panduan guna membantu Anda menggunakan notebook Acer Anda*:

Pertama-tama, Panduan Cepat akan membantu Anda mulai melakukan pengaturan pada komputer Anda.

Untuk informasi lebih lanjut tentang cara komputer ini membantu Anda agar lebih produktif, lihat AcerSystem User Guide. Panduan ini berisi informasi terinci mengenai hal-hal seperti utilitas sistem, pemulihan data, opsi-opsi ekspansi dan pemecahan masalah. Di samping itu, panduan ini berisi informasi jaminan dan peraturan umum serta peringatan keselamatan untuk notebook Anda. Panduan tersebut tersedia dalam format PDF dan sudah tersedia dalam notebook Anda.



Catatan: Diperlukan Adobe Reader untuk melihat file tersebut. Jika Adobe Reader belum diinstal dalam komputer Anda, klik AcerSystem User Guide untuk terlebih dulu menjalankan program konfigurasi Adobe Reader. Ikuti petunjuk pada layar untuk melakukan instalasi tersebut. Anda bisa mengakses menu Bantuan dan Dukungan untuk mendapatkan petunjuk mengenai bagaimana menggunakan Adobe Reader.



*** PEMBERITAHUAN PENTING:** Harap diperhatikan bahwa panduan yang disebutkan dalam dokumen ini, apakah dalam bentuk cetak atau elektronik, hanya untuk referensi dan kecuali sebagaimana diberikan dalam informasi jaminan spesifik yang terdapat dalam AcerSystem User Guide, maka tidak satu hal pun dalam panduan ini yang merupakan pernyataan atau jaminan oleh Acer berkenaan dengan produk yang Anda beli. Acer secara tersurat menyangkal segala pertanggungjawaban atas kesalahan yang terdapat dalam panduan ini.

Konfigurasi jaringan

Panduan ini akan membantu Anda mengonfigurasi pengaturan jaringan LAN dan nirkabel sehingga Anda bisa terhubung ke Internet.

Mengatur koneksi LAN

Anda cukup mencolokkan kabel LAN ke port Ethernet (RJ-45). Harap lihat "**Pandangan kanan**" pada halaman 6 untuk mengetahui lokasi port Ethernet.

Mengatur koneksi nirkabel

1. Tekan <Fn> + <F3> untuk mengakses manajer komunikasi. Di sini Anda dapat mengaktifkan koneksi W-Fi dengan mengklik pada tombol merah di sebelah Wi-Fi.

Catatan: 3G dan Bluetooth juga dapat diakses melalui manajer komunikasi. Perangkat komunikasi berbeda-beda berdasarkan model.

2. Klik ikon  pada sistem tray dan pilih titik akses nirkabel yang ingin Anda hubungkan.



Masukkan kartu SIM 3G (hanya untuk model-model tertentu)

Lepas baterai dan masukkan kartu SIM 3G dengan hati-hati ke dalam slot kartu SIM 3G. Lihat "**Pandangan belakang & Pandangan bawah**" pada halaman 6 untuk melihat lokasi slot kartu SIM 3G.

Tur Aspire One Anda

Setelah Anda melakukan pengaturan pada komputer Anda seperti terlihat pada gambar di bagian Persiapan, kami akan menunjukkan bagian-bagian notebook Acer.

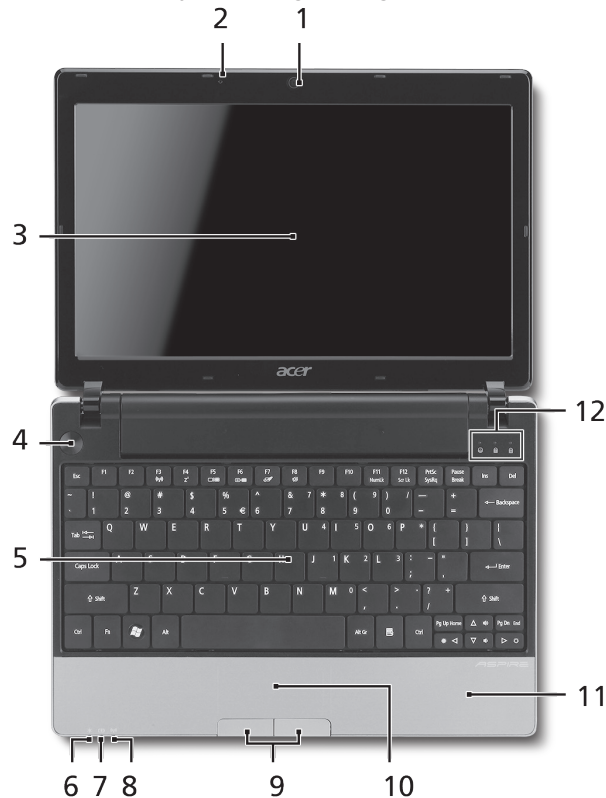

Pandangan atas



#	Ikun	Item	Keterangan						
1		Webcam Acer Crystal Eye	Kamera web untuk komunikasi video (konfigurasi mungkin berbeda tergantung model).						
2		Mikrofon	Mikrofon internal untuk perekaman suara.						
3		Layar tampilan	Disebut juga sebagai LCD (Liquid-Crystal Display), akan menampilkan output komputer (konfigurasi mungkin berbeda tergantung model).						
4		Tombol daya	Menghidupkan/mematikan komputer.						
5		Keyboard	Untuk memasukkan data ke komputer.						
6		Indikator daya ¹	Menunjukkan status daya komputer.						
7		Indikator baterai ¹	Menunjukkan status baterai komputer. 1. Mengisi daya: Lampu akan menyala kuning kecokelatan bila daya baterai sedang diisi. 2. Daya terisi penuh: Lampu menyala biru dalam mode AC.						
8		Indikator komunikasi ¹	Menunjukkan status komunikasi LAN Nirkabel/3G. <table border="1" data-bbox="1050 617 1551 731"> <thead> <tr> <th>Lampu biru menyala</th> <th>Lampu oranye menyala</th> <th>Tidak menyala</th> </tr> </thead> <tbody> <tr> <td>3G aktif/WiFi aktif</td> <td>3G tidak aktif/WiFi aktif</td> <td>3G tidak aktif/WiFi tidak aktif</td> </tr> </tbody> </table>	Lampu biru menyala	Lampu oranye menyala	Tidak menyala	3G aktif/WiFi aktif	3G tidak aktif/WiFi aktif	3G tidak aktif/WiFi tidak aktif
Lampu biru menyala	Lampu oranye menyala	Tidak menyala							
3G aktif/WiFi aktif	3G tidak aktif/WiFi aktif	3G tidak aktif/WiFi tidak aktif							
9		Tombol klik (kiri dan kanan)	Tombol kiri dan kanan berfungsi seperti tombol mouse kiri dan kanan.						
10		Panel sentuh	Perangkat penunjuk sensitif sentuhan yang berfungsi seperti mouse komputer.						
11		Tempat tangan	Tempat nyaman untuk meletakkan tangan Anda sewaktu menggunakan komputer.						
12		Indikator HDD	Menunjukkan bila drive hard disk aktif.						
		Num Lock	Menyala bila Num Lock diaktifkan.						
		Caps Lock	Menyala bila Caps Lock diaktifkan.						

1. Indikator panel depan akan terlihat meskipun penutup komputer dalam keadaan tertutup.

Pandangan depan tertutup

#	Ikona	Item	Keterangan
1		Indikator status	Light-Emitting Diodes (LED) yang menyala menunjukkan status fungsi dan komponen komputer.





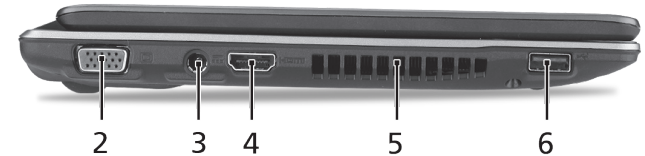

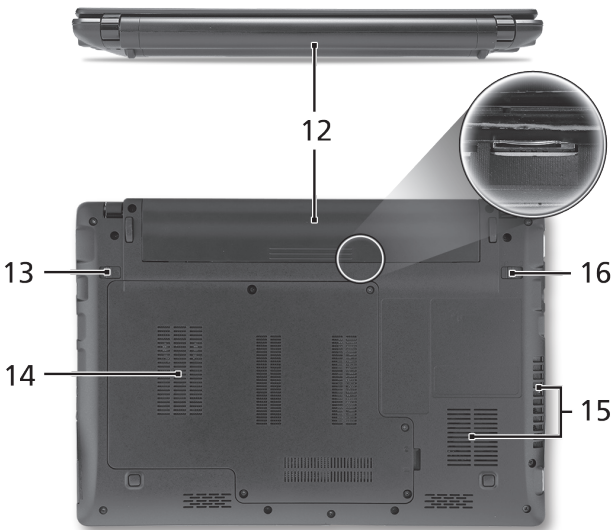
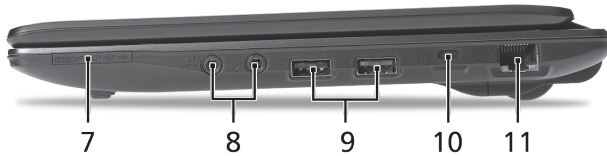
Pandangan kiri

2		Port tampilan (VGA) eksternal	Menghubungkan perangkat tampilan (mis., monitor eksternal, proyektor LCD).
3		Jack DC-in	Menghubungkan ke Adaptor AC.
4		HDMI Port HDMI	Mendukung koneksi video digital definisi tinggi.
5		Slot ventilasi	Membuat komputer tetap dingin, bahkan setelah pemakaian yang lama.
6		Port USB 2.0	Menghubungkan ke perangkat USB 2.0 (mis., mouse USB, kamera USB).









Pandangan kanan

#	Ikun Item	Keterangan
7	 Pembaca kartu Multi-in-1	Menerima Secure Digital (SD), MultiMediaCard (MMC), Memory Stick (MS), Memory Stick PRO (MS PRO), xD-Picture Card (xD). Catatan: Tekan untuk melepas/memasang kartu. Hanya satu kartu yang bisa beroperasi saat Anda menggunakannya.
8	 Jack mikrofon-in	Menerima input dari mikrofon eksternal.
	 Port headphone/speaker/saluran output dengan dukungan S/PDIF	Menghubungkan ke perangkat line-out audio (mis. penguat suara, headphone).
9	 Port USB 2.0	Menghubungkan ke perangkat USB 2.0 (mis., mouse USB).
10	 Slot kunci Kensington	Menghubungkan ke kunci keamanan komputer yang kompatibel dengan kunci Kensington.
11	 Port ethernet (RJ-45)	Menghubungkan ke jaringan berbasis Ethernet 10/100/1000.

Pandangan belakang & Pandangan bawah

12	 Tempat baterai	Tempat kemasan baterai komputer.
13	 Penutup pelepas baterai	Untuk melepaskan baterai.
14	 Bay hard disk	Untuk memasang hard disk komputer (dipasang dengan sekrup).
	 Kompartemen memori	Untuk memasang memori utama komputer.
15	Slot ventilasi dan kipas pendingin	Membuat komputer tetap dingin, bahkan setelah pemakaian yang lama. Catatan: Lubang kipas jangan sampai tertutup atau terhalang.
16	 Kunci baterai	Mengunci baterai pada tempatnya.

Lingkungan

Suhu:

Beroperasi: 5°C hingga 35°C

Tidak beroperasi: -20°C hingga 65°C

Kelembaban (non-kondensasi):

Beroperasi: 20% hingga 80%

Tidak beroperasi: 20% hingga 80%

ซีรีส์ **ASPIRE** ONE

คู่มืออย่างย่อ

ซีรี่ส์ **ASPIRE** One

© 2010 สงวนลิขสิทธิ์

คู่มืออย่างย่อ *Aspire One* ซีรี่ส์
ฉบับดั้งเดิม: 04/2010

พีซีโน้ตบุ๊ก *Aspire One* ซีรี่ส์

หมายเลขรุ่น: _____

ซีเรียลนัมเบอร์: _____

วันที่ซื้อ: _____

สถานที่ซื้อ: _____

Federal Communications Commission

Declaration of Conformity

This device complies with Part 15 of the FCC Rules. Operation is subject to the following two conditions: (1) this device may not cause harmful interference, and (2) this device must accept any interference received, including interference that may cause undesired operation.

The following local Manufacturer / Importer is responsible for this declaration:

Product name:	Notebook PC
Brand:	Acer
Model number:	MS2296
Machine type:	AO 753 series
Name of Responsible Party:	Acer America Corporation
Address of responsible party:	333 West San Carlos St., San Jose CA 95110, U. S. A.
Contact person:	Acer Representative
Phone No.:	1-254-298-4000
Fax No.:	1-254-298-4147
April 30, 2010	

CE Declaration of Conformity

We,

Acer Incorporated

8F, 88, Sec. 1, Hsin Tai Wu Rd., Hsichih, Taipei Hsien 221, Taiwan

Contact Person: Mr. Easy Lai, e-mail:easy_lai@acer.com.tw

And,

Acer Europe SA

Via Cantonale, Centro Galleria 2 6928 Manno Switzerland

Hereby declare that:

Product: Notebook Computer

Trade Name: Acer

Model Number: MS2296

Machine Type: AO753 series

Is compliant with the essential requirements and other relevant provisions of the following EC directives, and that all the necessary steps have been taken and are in force to assure that production units of the same product will continue comply with the requirements.

EMC Directive 2004/108/EC as attested by conformity with the following harmonized standards:

- EN55022, AS/NZS CISPR22, Class B
- EN55024
- EN61000-3-2 Class D
- EN61000-3-3

Low Voltage Directive 2006/95/EC as attested by conformity with the following harmonized standard:

- EN60950-1

Council Decision 98/482/EC (CTR21):

(Applicable to product with pan- European single terminal connection to the Public Switched Telephone Network (PSTN).)

RoHS Directive 2002/95/EC on the Restriction of the Use of certain Hazardous Substances in Electrical and Electronic Equipment



- The maximum concentration values of the restricted substances by weight in homogenous material are:

Lead	0.1%	Polybrominated Biphenyls (PBB's)	0.1%
Mercury	0.1%	Polybrominated Diphenyl Ethers (PBDE's)	0.1%
Hexavalent Chromium	0.1%	Cadmium	0.01%

Directive 2009/125/EC with regard to establishing a framework for the setting of ecodesign requirements for energy-related product.

R&TTE Directive 1999/5/EC as attested by conformity with the following harmonized standard:

- Article 3.1(a) Health and Safety
 - EN60950-1
 - EN62311
- Article 3.1(b) EMC
 - EN301 489-1
 - EN301 489-3 (Applicable to non-bluetooth wireless keyboard mouse set).
 - EN301 489-7
 - EN301 489-17
 - EN301 489-24
- Article 3.2 Spectrum Usages
 - EN300 440-2 (Applicable to non-bluetooth wireless keyboard mouse set).
 - EN300 328
 - EN301 511
 - EN301 893 (Applicable to 5GHz high performance RLAN).
 - EN301 908-1
 - EN301 908-2

Year to begin affixing CE marking 2010.

Easy Lai

Easy Lai /Manager
Regulation Center, Acer Inc.

Apr. 30, 2010

Date

สำหรับผู้เริ่มใช้

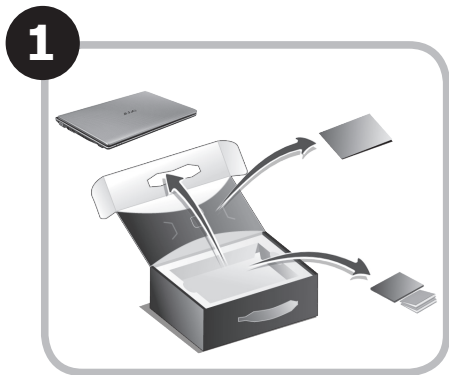

ภาพประกอบมีเพื่อการอ้างอิงเท่านั้น ข้อมูลจำเพาะผลิตภัณฑ์ที่แท้จริงอาจแตกต่างกัน

ก่อนอื่น

ขอขอบคุณที่คุณเลือกโน้ตบุ๊กจาก Acer เพื่อรองรับการใช้งานแบบพกพาของคุณ

คู่มือ

เพื่อช่วยสอนการใช้โน้ตบุ๊ก Acer เราจึงได้จัดทำคู่มือชุดนี้ขึ้น*:

อันดับแรกคือ คู่มือฉบับย่อที่จะช่วยคุณในการเริ่มใช้คอมพิวเตอร์ของคุณ

สอบถามข้อมูลการใช้งานคอมพิวเตอร์เพื่อให้เกิดประสิทธิภาพสูงสุดได้จาก AcerSystem User Guide คู่มือนี้ประกอบด้วยข้อมูลรายละเอียดเกี่ยวกับยูทิลิตี้ระบบ, การกู้คืนข้อมูล, ตัวเลือกเสริม, และวิธีในการแก้ไขปัญหา นอกจากนี้ยังประกอบด้วยข้อมูลการรับประกัน ขอบบังคับทั่วไป และการแจ้งเตือนด้านความปลอดภัยสำหรับโน้ตบุคของคุณ ซึ่งมีให้ในรูปแบบ Portable Document Format (PDF) และมาพร้อมกับโน้ตบุคของคุณ



หมายเหตุ: การเรียกดูไฟล์ต้องการ Adobe Reader หากคอมพิวเตอร์ของคุณไม่มี Adobe Reader ติดตั้งอยู่ การคลิกที่ AcerSystem User Guide จะเป็นการรันการติดตั้งโปรแกรม Adobe Reader ก่อน ทำตามคำแนะนำบนจอแสดงผลเพื่อติดตั้งให้เสร็จสมบูรณ์ สำหรับคำแนะนำในการใช้งาน Adobe Reader โปรดดูที่เมนูช่วยเหลือและสนับสนุน



* การแจ้งเตือนที่สำคัญ: คู่มือที่ได้กล่าวถึงไว้ในที่นี้ ทั้งในรูปแบบสิ่งพิมพ์หรืออิเล็กทรอนิกส์ มีเพื่ออ้างอิงเท่านั้นและไม่รวมถึงข้อมูลการรับประกันเฉพาะที่กล่าวถึงใน AcerSystem User Guide ไม่มีส่วนใดในคู่มือนี้จะแสดงถึงการเป็นตัวแทนหรือการรับประกันโดย Acer เกี่ยวกับผลิตภัณฑ์ที่คุณซื้อ Acer ขอปฏิเสธความรับผิดชอบอื่นๆทั้งหมดสำหรับข้อผิดพลาดที่มีในคู่มือนี้

การปรับตั้งค่าเครือข่าย

คู่มือนี้จะช่วยให้คุณในการปรับตั้งค่า LAN และตั้งค่าเครือข่ายไร้สายของคุณเพื่อช่วยให้คุณเชื่อมต่ออินเทอร์เน็ตได้

การตั้งค่าการเชื่อมต่อ LAN

ง่ายๆเพียงแคเสียบสาย LAN เข้ากับพอร์ต Ethernet (RJ-45) โปรดดูที่ "มุมมองด้านขวา" บนหน้า 6 สำหรับตำแหน่งของพอร์ต Ethernet

การตั้งค่าการเชื่อมต่อไร้สาย

1. กด <Fn> + <F3> เพื่อเข้าถึงโปรแกรมจัดการสื่อสาร ที่นี้คุณสามารถเปิดการเชื่อมต่อ Wi-Fi ได้โดยการคลิกที่ปุ่มสีแดงถัดจาก Wi-Fi
หมายเหตุ: 3G และ Bluetooth สามารถเข้าถึงได้จากโปรแกรมจัดการสื่อสาร อุปกรณ์สื่อสารอาจแตกต่างกันขึ้นอยู่กับแต่ละรุ่น
2. คลิก  ไอคอนบนแถบระบบและเลือกจุดเชื่อมต่อไร้สายที่คุณต้องการเชื่อมต่อ



ใส่ซิมการ์ด 3G (สำหรับบางรุ่น)

ถอดแบตเตอรี่ออกและใส่ซิมการ์ด 3G เข้าในสล็อตซิมการ์ด 3G อย่างระมัดระวัง โปรดดูที่ "มุมมองด้านหลังและด้านล่าง" ในหน้า 6 สำหรับตำแหน่งของสล็อตซิมการ์ด 3G

ชม *Aspire One* ของคุณ

หลังจากตั้งค่าคอมพิวเตอร์ของคุณตามภาพประกอบในส่วนสำหรับผู้เริ่มใช้ ให้เราได้พาคุณชมโน้ตบุ๊ก Acer ของคุณอย่างทั่วถึง

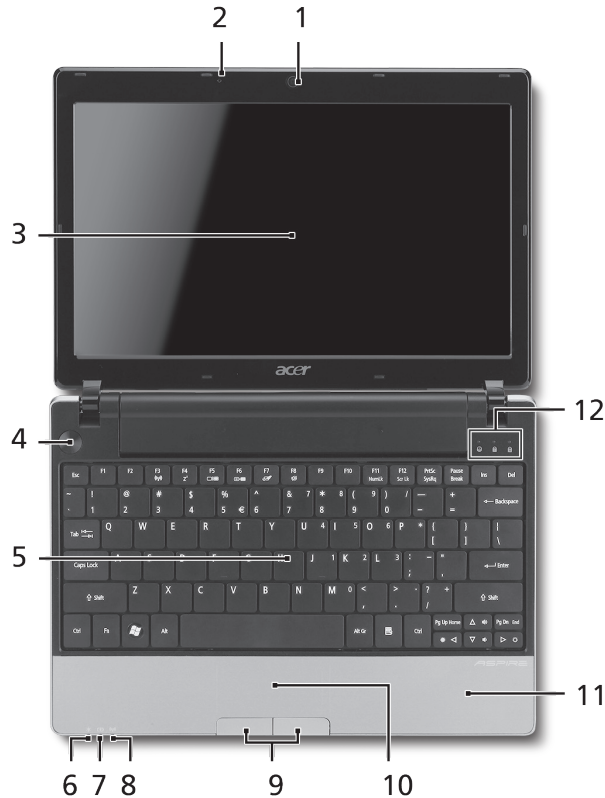

มุมมองด้านบน



#	ไอคอน	รายการ	คำอธิบาย									
1		เว็บแคม Acer Crystal Eye	กล้องเว็บแคมสำหรับการสื่อสารด้วยวิดีโอ (ส่วนประกอบอาจแตกต่างกันไปตามรุ่น)									
2		ไมโครโฟน	ไมโครโฟนในตัวสำหรับการบันทึกเสียง									
3		จอแสดงผล	หรือที่เรียกว่า Liquid-Crystal Display (LCD) ซึ่งใช้แสดงข้อมูลต่างๆ ของคอมพิวเตอร์ (ส่วนประกอบอาจแตกต่างกันไปตามรุ่น)									
4		ปุ่มเปิดปิด	เปิดและปิดคอมพิวเตอร์									
5		คีย์บอร์ด	เพื่อป้อนข้อมูลเข้าสู่คอมพิวเตอร์ของคุณ									
6		ไฟแสดงสถานะพลังงาน ¹	ระบุสถานะการเปิดใช้งานคอมพิวเตอร์									
7		ตัวแสดงสถานะแบตเตอรี่ ¹	แสดงถึงสถานะแบตเตอรี่ของคอมพิวเตอร์ 1. กำลังชาร์จ: ไฟสว่างเป็นสีเหลืองอำพันเมื่อทำการชาร์จแบตเตอรี่ 2. ชาร์จไฟเต็ม: ไฟสีน้ำเงินติดสว่างขณะอยู่ในโหมด AC									
8		ตัวแสดงสถานะ ¹	แสดงสถานะของการสื่อสาร 3G/Wireless LAN									
			<table border="1"> <thead> <tr> <th>ไฟสีน้ำเงินสว่าง</th> <th>ไฟสีส้มสว่าง</th> <th>ไม่มีไฟติด</th> </tr> </thead> <tbody> <tr> <td>3G เปิด/WiFi เปิด</td> <td>3G ปิด/WiFi เปิด</td> <td>3G ปิด/WiFi ปิด</td> </tr> <tr> <td>3G ปิด/WiFi ปิด</td> <td></td> <td></td> </tr> </tbody> </table>	ไฟสีน้ำเงินสว่าง	ไฟสีส้มสว่าง	ไม่มีไฟติด	3G เปิด/WiFi เปิด	3G ปิด/WiFi เปิด	3G ปิด/WiFi ปิด	3G ปิด/WiFi ปิด		
ไฟสีน้ำเงินสว่าง	ไฟสีส้มสว่าง	ไม่มีไฟติด										
3G เปิด/WiFi เปิด	3G ปิด/WiFi เปิด	3G ปิด/WiFi ปิด										
3G ปิด/WiFi ปิด												
9		ปุ่มคลิก (ซ้ายและขวา)	ปุ่มซ้ายและขวาทำงานเหมือนกับปุ่มเมาส์ซ้ายและขวา									
10		ทัชแพด	อุปกรณ์ชี้ตำแหน่งแบบสัมผัส ซึ่งทำงานแบบเดียวกับเมาส์คอมพิวเตอร์									
11		ที่วางมือ	พื้นที่รองรับมือเพื่อให้อารมณ์สบายขณะใช้คอมพิวเตอร์									
12		ตัวแสดงสถานะ HDD	แสดงเมื่อฮาร์ดดิสก์ไดรฟ์มีการทำงาน									
		Num Lock	ติดสว่างในกรณีที่เปิดใช้ Num Lock									
		Caps Lock	ไฟสว่างเมื่อเปิดใช้งาน Caps Lock									

1. สัญลักษณ์ที่แสดงด้านบนสามารถมองเห็นได้แม้จะปิดฝาพับคอมพิวเตอร์

ปิดมุมมองด้านบน

#	ไอคอน	รายการ	คำอธิบาย
1		ตัวแสดงสถานะ	Light-Emitting Diode (LED) ที่จะมีไฟปรากฏขึ้นเพื่อแสดงสถานะการใช้งานของคอมพิวเตอร์และส่วนประกอบต่างๆ

มุมมองด้านซ้าย

2		พอร์ตจอแสดงผลต่อพวง (VGA)	เชื่อมต่อกับจอแสดงผล (เช่น จอภาพภายนอก, โปรเจคเตอร์ LCD)
3		ช่องเสียบ DC-in	เชื่อมต่อกับอะแดปเตอร์ AC
4	HDMI	พอร์ต HDMI	รองรับการเชื่อมต่อระบบวิดีโอดิจิทัลความละเอียดสูง
5		ช่องระบายอากาศ	ช่วยให้คอมพิวเตอร์เย็นแมหลังจากใช้งานเป็นเวลานาน
6		พอร์ต USB 2.0	ต่ออุปกรณ์ USB 2.0 (เช่น เมาส์หรือกล่อง USB)

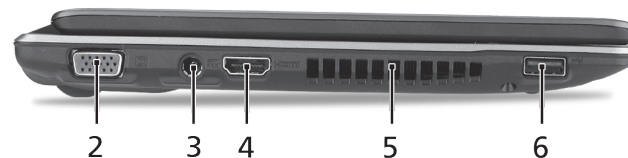

มุมมองด้านขวา

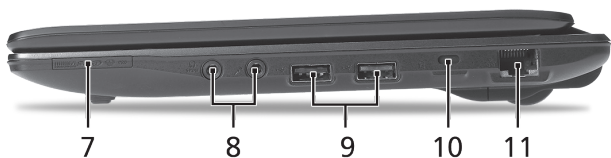

#	ไอคอน	รายการ	คำอธิบาย
7		การ์ดรีดเดอร์มัลติมีเดีย	รับ Secure Digital (SD), MultiMediaCard (MMC), Memory Stick (MS), Memory Stick PRO (MS PRO), xD-Picture Card (xD) หมายเหตุ: กดเพื่อถอด/ติดตั้งการ์ด ที่ทำงานได้ครั้งละหนึ่งการ์ดเท่านั้น
8		แจ็กเสียบไมโครโฟน	ใช้สำหรับต่อไมโครโฟน
		ช่องเสียบหูฟัง/ลำโพง/line-out รองรับ S/PDIF	เชื่อมต่อกับอุปกรณ์ระบบเสียงภายนอก (เช่น ลำโพง ชุดหูฟัง)
9		พอร์ต USB 2.0	เชื่อมต่อกับอุปกรณ์ USB 2.0 (เช่น เม้าส์ USB)
10		สล๊อตล็อก Kensington	พวงต่อกับระบบล็อกความปลอดภัยสำหรับคอมพิวเตอร์ที่ใช้งานได้กับ Kensington
11		พอร์ต Ethernet (RJ-45)	เชื่อมต่อไปยังเครือข่ายซึ่งใช้ Ethernet 10/100/1000

มุมมองด้านหลังและด้านล่าง

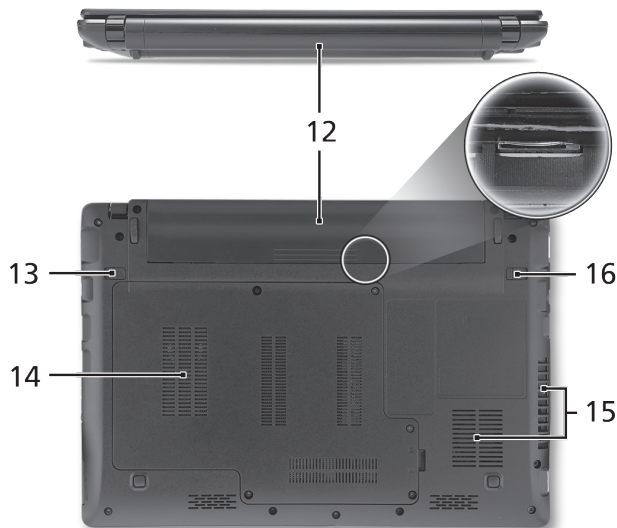

12		ช่องใส่แบตเตอรี่	ใช้สำหรับเก็บฝาแบตเตอรี่ของคอมพิวเตอร์
13		สลักปลดล็อกแบตเตอรี่	ปลดล็อกเพื่อนำแบตเตอรี่ออก
14		ช่องใส่ฮาร์ดดิสก์	ที่อยู่ของฮาร์ดดิสก์ของคอมพิวเตอร์ (ยึดติดแน่นด้วยนอต)
		ช่องหน่วยความจำ	ที่อยู่ของหน่วยความจำของคอมพิวเตอร์
15		สลัลดูอุปกรณ์ระบายอากาศและพัดลมระบายความร้อน	ช่วยให้คอมพิวเตอร์เย็นแม่หลังจากใช้งานเป็นเวลานาน หมายเหตุ: ห้ามปิดหรือกีดขวางช่องพัดลม
16		ล็อกแบตเตอรี่	ล็อกแบตเตอรี่ให้อยู่ในตำแหน่ง

สิ่งแวดล้อม

อุณหภูมิ:

ขณะทำงาน: 5 °C ถึง 35 °C

ขณะปิดเครื่อง: -20 °C ถึง 65 °C

ความชื้น (ไม่ควมแน่นเป็นไอน้ำ):

ขณะทำงาน: 20% ถึง 80%

ขณะปิดเครื่อง: 20% ถึง 80%