

**English**  
**Français**  
**Deutsch**  
**Italiano**  
**Español**  
**Português**  
**Nederlands**  
**Norsk**  
**Dansk**  
**Svenska**  
**Suomi**  
**Русский**  
**Polski**  
**Magyar**  
**Čeština**  
**Slovenčina**  
**Slovenski**  
**Hrvatski**  
**Română**  
**Български**  
**Eesti**  
**Latviski**  
**Lietuviškai**  
**Ελληνικά**  
**Türkçe**  
**한국어**  
**繁體中文**  
**简体中文**  
**Bahasa Indonesia**  
**ไทย**

# Contents



# TravelMate Notebook

## Quick Guide

### Product registration

When using your product for the first time, it is recommended that you immediately register it. This will give you access to some useful benefits, such as:

- Faster service from our trained representatives.
- Membership in the Acer community: receive promotions and participate in customer surveys.
- The latest news from Acer.

Hurry and register, as other advantages await you!

### How to register

To register your Acer product, please visit **www.acer.com**. Select your country, click **PRODUCT REGISTRATION** and follow the simple instructions.

You will also be asked to register your product during the setup process, or you can double-click the Registration icon on the desktop.

After we receive your product registration, you will be sent a confirmation email with important data that you should keep in a safe place.

### Obtaining Acer accessories

We are happy to inform you that Acer's warranty extension program and Notebook accessories are available online. Come and visit our online shop and find what you need at **store.acer.com**.

The Acer store is being progressively rolled out, and, unfortunately may not be available in some regions. Please check back regularly to see when it will be available in your country.

© 2012. All Rights Reserved.

TravelMate Notebook Quick Guide  
Original Issue: 07/2012

Model Number : \_\_\_\_\_

Serial Number: \_\_\_\_\_

Purchase Date: \_\_\_\_\_

Place of Purchase: \_\_\_\_\_

Acer recommends...

Productivity Software

**Work Great with Microsoft® Office 2010** - Express your ideas, solve problems and simplify everyday projects with Office 2010.

**Photo editing** - Easily edit and print your photos with Windows Live Photo Gallery. Then share them on Facebook, YouTube or Windows Live.

**Search & Decide with Bing** - Find and organize the answers you need using Bing™, so you can make faster, more informed decisions.

## First things first

We would like to thank you for making an Acer notebook your choice for meeting your mobile computing needs.

## Your guides

To help you use your Acer notebook, we have designed a set of guides: First off, the **Setup Poster** helps you get started with setting up your computer.

The **Quick Guide** introduces you to the basic features and functions of your new computer.

For more on how your computer can help you to be more productive, please refer to the **TravelMate User's Manual**. The **TravelMate User's Manual** contains useful information applying to your new computer. It covers basic topics such as using the keyboard and audio, etc.

This guide contains detailed information on such subjects as system utilities, data recovery, expansion options and troubleshooting. In addition it contains warranty information and the general regulations and safety notices for your notebook.

Follow these steps to access it:

- 1 Type "User" from *Start*.
- 2 Click on **Acer User's Manual**.





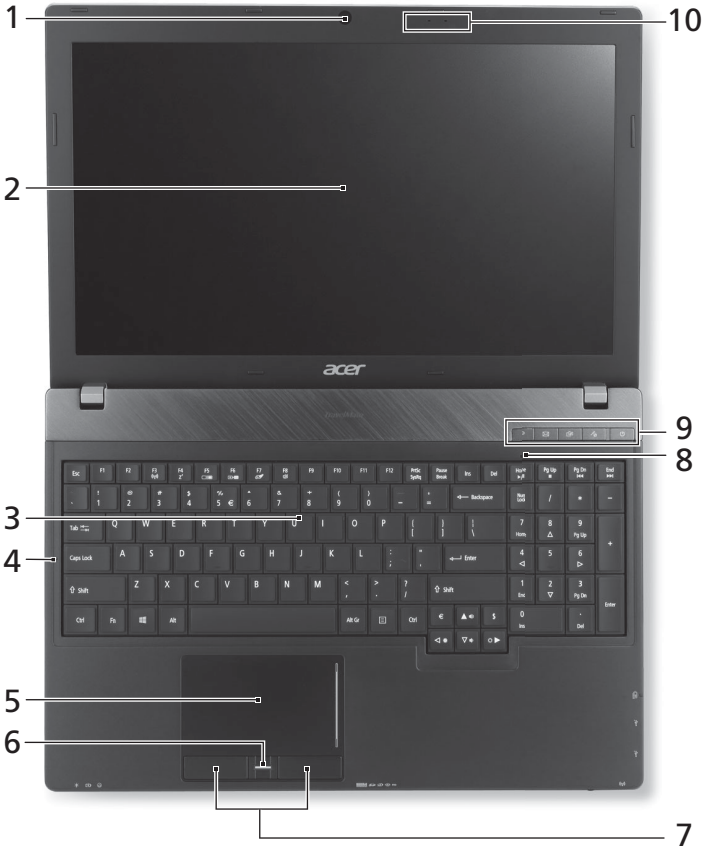

# Your Acer notebook tour

After setting up your computer as illustrated in the setup poster, let us show you around your new Acer notebook.

## Top view

















#	Icon	Item	Description
1		Integrated webcam	Web camera for video communication. <i>A light next to the webcam indicates that the webcam is active.</i>

#	Icon	Item	Description
2		Screen	Also called Liquid-Crystal Display (LCD), displays computer output (configuration may vary by model).
3		Keyboard	For entering data into your computer.
4		Caps Lock	Lights up when Caps Lock is activated.
5		Touchpad	Touch-sensitive pointing device which functions like a computer mouse.
6		Fingerprint reader	Fingerprint reader for Acer ProShield Security Suite.
7		Click buttons (left and right)	The left and right buttons function like the left and right mouse buttons.
8		Num Lock	Lights up when Num Lock is activated.
		P key	Programmable key (configuration may vary by model).
		Acer email key	Opens your default email application.
9		Backup key	Launches Acer Backup Management for three-step data backup.
		Microphone mute	Mutes the microphone.
		Power button / indicator	Turns the computer on and off. Indicates the computer's power status.
10		Microphones	Two internal microphones for stereo sound recording.

## Hotkeys

The computer employs hotkeys or key combinations to access most of the computer's controls like screen brightness and volume output.

To activate hotkeys, press and hold the <Fn> key before pressing the other key in the hotkey combination.

Hotkey	Icon	Function	Description
<Fn> + <F3>		Communication	Enables/disables the computer's communication devices.
<Fn> + <F4>		Sleep	Puts the computer in Sleep mode.
<Fn> + <F5>		Display toggle	Switches display output between the display screen, external monitor (if connected) and both.
<Fn> + <F6>		Screen blank	Turns the display screen backlight off to save power. Press any key to return.
<Fn> + <F7>		Touchpad toggle	Turns the internal touchpad on and off.
<Fn> + <F8>		Speaker toggle	Turns the speakers on and off.
<Fn> + <▷>		Brightness up	Increases the screen brightness.
<Fn> + <◁>		Brightness down	Decreases the screen brightness.
<Fn> + <△>		Volume up	Increases the sound volume.
<Fn> + <▽>		Volume down	Decreases the sound volume.
<Fn> + <Home>		Play/Pause	Play or pause a selected media file.
<Fn> + <Pg Up>		Stop	Stop playing the selected media file.
<Fn> + <Pg Dn>		Previous	Return to the previous media file.
<Fn> + <End>		Next	Jump to the next media file.





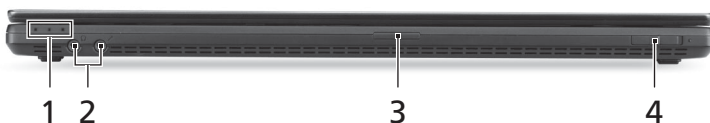

## Closed front view



#	Icon	Item	Description
		Power indicator	Indicates the computer's power status.
1		Battery indicator	Indicates the computer's battery status. <b>1. Charging:</b> The light shows amber when the battery is charging. <b>2. Fully charged:</b> The light shows blue when in AC mode.
		HDD indicator	Indicates when the hard disk drive is active.
2		Microphone jack	Accepts inputs from external microphones.
		Headphones/speaker jack	Connects to audio devices (e.g., speakers, headphones).
3		Multi-in-1 card reader	Accepts Secure Digital (SD), MultiMediaCard (MMC), Memory Stick PRO (MS PRO), xD-Picture Card (xD). <b>Note:</b> Push to remove/install the card. Only one card can operate at any time.
4		Communication switch / indicator	Enables/disables the computer's communication devices / indicates the computer's wireless connectivity device status.





## Left view



#	Icon	Item	Description
1		DC-in jack	Connects to an AC adapter.
3		External display (VGA) port	Connects to a display device (e.g., external monitor, LCD projector).
2		HDMI port	Supports high-definition digital video connections.
4		USB / eSATA port	Connects to USB or eSATA devices (only for certain models). <b>Note:</b> If you plug in an eSATA device you will have three USB ports available.
5		SmartCard slot	Accepts a SmartCard.
6		ExpressCard/34 slot	Accepts one ExpressCard/34 module. <b>Note:</b> Push to remove/insert the module.

## Right view







#	Icon	Item	Description
1		USB port	
2		USB port	Connects to USB devices. <i>If a port is black, it is USB 2.0 compatible; if it is blue it is also USB 3.0 compatible.</i>
3		USB port with power-off charging	
4		Optical drive	Internal optical drive; accepts CDs or DVDs.
5		Optical disk access indicator	Lights up when the optical drive is active.
6		Optical drive eject button	Ejects the optical disk from the drive.
7		Emergency eject hole	Ejects the optical drive tray when the computer is turned off. <b>Note:</b> <i>Insert a paper clip to the emergency eject hole to eject the optical drive tray when the computer is off.</i>
8		Ethernet (RJ-45) port	Connects to an Ethernet 10/100/1000-based network.
9		Kensington lock slot	Connects to a Kensington-compatible computer security lock. <b>Note:</b> <i>Wrap the computer security lock cable around an immovable object such as a table or handle of a locked drawer. Insert the lock into the notch and turn the key to secure the lock. Some keyless models are also available.</i>

## Information on USB 3.0

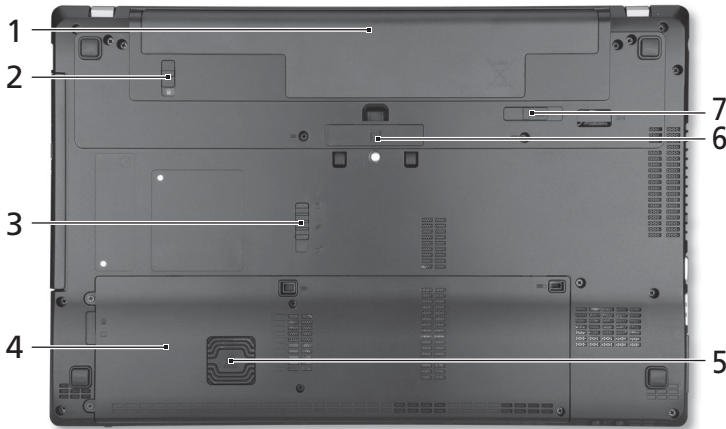
- Compatible with USB 3.0 and earlier USB devices.
- For optimal performance, use USB 3.0-certified devices.
- Defined by the USB 3.0 (SuperSpeed USB) specification.

## Base view



#	Icon	Item	Description
1		Battery bay	Houses the computer's battery pack.
2		Battery lock	Locks the battery in position.
3		Acer MediaBay release latch	Releases the Acer MediaBay module.
4		Hard disk bay	Houses the computer's hard disk (secured with screws).
		Memory compartment	Houses the computer's main memory.

#	Icon	Item	Description
5		Acer DASP (Disk Anti-Shock Protection)	Protects the hard disk from shocks and bumps.
6		Acer ProDock connector	Connects to the optional Acer ProDock.
7		Battery release latch	Releases the battery for removal.

## Environment

- Temperature:
  - Operating: 5 °C to 35 °C
  - Non-operating: -20 °C to 65 °C
- Humidity (non-condensing):
  - Operating: 20% to 80%
  - Non-operating: 20% to 80%



# Notebook TravelMate

## Guide rapide

### Enregistrer votre produit

Lors de la première utilisation de votre produit, il est recommandé de l'enregistrer immédiatement. Cela vous donne accès à des avantages utiles, comme :

- Service plus rapide de nos représentants entraînés.
- Une adhésion à la communauté Acer : recevez des promotions et participez à nos enquêtes clients.
- Les dernières nouvelles d'Acer.

Dépêchez-vous et inscrivez-vous, car d'autres avantages vous attendent !

### Comment s'enregistrer

Pour enregistrer votre produit Acer, veuillez visiter **www.acer.com**. Sélectionnez votre pays, cliquez sur **ENREGISTRER VOTRE PRODUIT** et suivez simplement les instructions.

Il vous sera également demandé d'enregistrer votre produit pendant le processus d'installation, ou vous pouvez double-cliquer sur l'icône Enregistrement sur le bureau.

Une fois votre demande d'inscription reçue, nous vous enverrons un email de confirmation avec les données importantes que vous devrez conserver précieusement.

### Obtenir des accessoires Acer

Nous sommes heureux de vous informer que le programme d'extension de garantie Acer et les accessoires pour notebook sont disponibles en ligne. Venez et visitez notre boutique en ligne et trouvez ce dont vous avez besoin sur **store.acer.com**.

La boutique Acer est progressivement mise en œuvre, et, malheureusement, peut ne pas être disponible dans certaines régions. Veuillez consulter le site régulièrement pour voir quand il sera disponible dans votre pays.

© 2012 Tous droits réservés.

Guide rapide du notebook TravelMate

Cette révision : 07/2012

Modèle : \_\_\_\_\_

No. de série : \_\_\_\_\_

Date d'achat : \_\_\_\_\_

Lieu d'achat : \_\_\_\_\_



## Pour commencer

Nous désirons vous remercier d'avoir fait d'un notebook Acer votre choix pour répondre à vos besoins informatiques mobiles.

## Vos guides

Pour vous aider à utiliser votre notebook Acer, nous avons conçu plusieurs guides :

Tout d'abord, le **Poster de configuration** vous aide à configurer votre ordinateur.

Le **Guide rapide** présente les fonctionnalités et fonctions de base de votre ordinateur.

Pour plus d'information sur l'aide que votre ordinateur peut vous apporter pour être plus productif, veuillez vous reporter au **Manuel d'utilisation**. Le **Manuel d'utilisation** contient des informations utiles qui s'appliquent à votre nouvel ordinateur. Il couvre les notions de base, telles que l'utilisation du clavier et du son, etc.

Ce guide contient des informations détaillées sur des sujets tels que les utilitaires systèmes, la récupération des données, les options d'extension et le dépannage. De plus, il contient des informations de garantie et les réglementations générales et les avis de sécurité pour votre notebook.

Procédez comme suit pour y accéder :





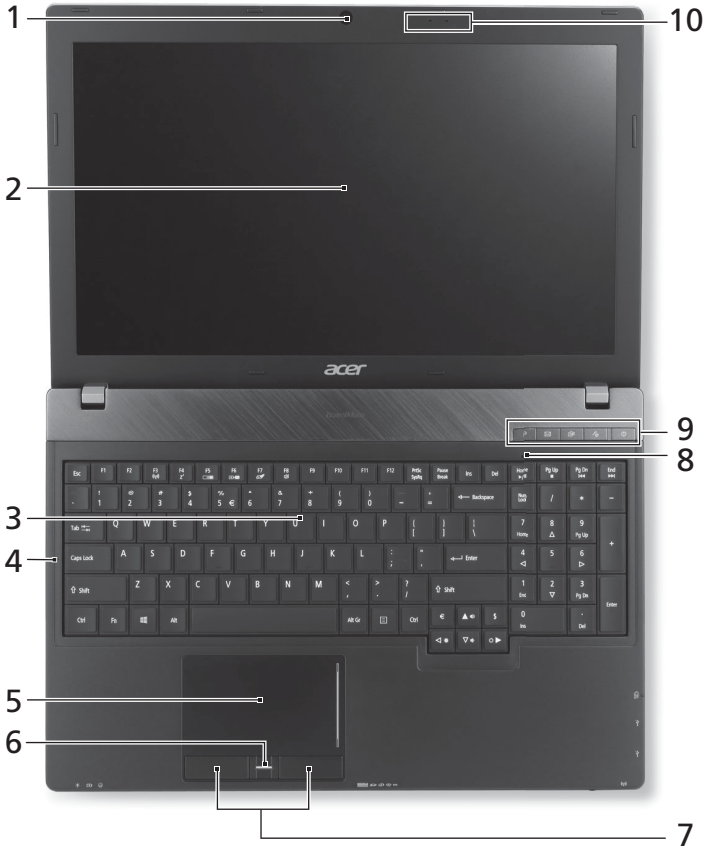

- 1 Saisissez « utilisation » depuis *Démarrer*.
- 2 Cliquez sur **Manuel d'utilisation Acer**.

## Visite guidée de votre notebook Acer

Après avoir configuré votre ordinateur comme illustré dans le poster de configuration, nous allons vous faire explorer votre nouveau notebook Acer.

### Vue supérieure

















N°	Icône	Élément	Description
1		Webcam intégrée	Webcam pour communication vidéo. <i>Une lumière à côté de la webcam indique que la webcam est active.</i>
2		Écran	Également appelé écran LCD (Liquid Crystal Display), il affiche les données de l'ordinateur (la configuration peut varier en fonction du modèle).
3		Clavier	Pour l'entrée des informations dans votre ordinateur.
4		Verr Maj	Est allumé lorsque Verr Maj est activée.
5		Touchpad	Périphérique de pointage sensible au touché qui fonctionne comme une souris.
6		Lecteur d'empreinte digitale	Lecteur d'empreinte digitale pour Acer ProShield Security Suite.
7		Boutons (gauche et droit)	Le bouton gauche et le bouton droit fonctionnent comme le bouton gauche et le bouton droit d'une souris.
8		Verr Num	Est allumé lorsque Verr Num est activée.
		Touche P	Touche programmable (la configuration peut varier en fonction du modèle).
		Touche e-mail Acer	Ouvre votre application de messagerie par défaut.
9		Touche de sauvegarde	Lance Acer Backup Management pour une sauvegarde des données en trois étapes.
		Microphone muet	Désactive le microphone.
		Bouton/Indicateur d'alimentation	Met l'ordinateur sous tension et hors tension. Indique l'état d'alimentation de l'ordinateur.
10		Microphones	Deux microphones internes pour l'enregistrement sonore stéréo.

## Touches spéciales

L'ordinateur emploie des touches spéciales (combinaisons de touches) pour accéder à la plupart des contrôles de l'ordinateur comme la luminosité de l'écran et le volume sonore.





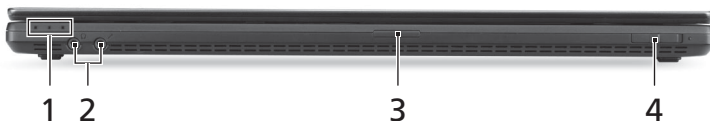

Pour activer les touches spéciales, appuyez et maintenez la touche **<Fn>** avant d'appuyer sur l'autre touche dans la combinaison de la touche spéciale.

Touche spéciale	Icône	Fonction	Description
<Fn> + <F3>		Communication	Active/désactive les périphériques de communication de l'ordinateur.
<Fn> + <F4>		Veille	Place l'ordinateur en mode de Sommeil.
<Fn> + <F5>		Choix de l'affichage	Permet de permuter l'affichage entre l'écran d'affichage, le moniteur externe (s'il est connecté) et les deux.
<Fn> + <F6>		Écran noir	Désactive le rétro éclairage de l'écran pour économiser l'énergie. Appuyez sur une touche pour le rallumer.
<Fn> + <F7>		Touchpad	Active et désactive le touchpad.
<Fn> + <F8>		Haut-parleur	Active et désactive les haut-parleurs.
<Fn> + <▷>		Luminosité +	Augmente la luminosité de l'écran.
<Fn> + <◁>		Luminosité -	Diminue la luminosité de l'écran.
<Fn> + <△>		Volume +	Augmente le volume sonore.
<Fn> + <▽>		Volume -	Diminue le volume sonore.
<Fn> + <Origine>		Lecture/Pause	Lisez ou effectuez une pause d'un fichier multimédia sélectionné.
<Fn> + <Pg préc.>		Arrêter	Arrêtez la lecture du fichier multimédia sélectionné.

Touche spéciale	Icône	Fonction	Description
<Fn> + <Pg suiv.>		Précédent	Retournez au fichier multimédia précédent.
<Fn> + <Fin>		Suivant	Passez au fichier multimédia suivant.





## Vue frontale fermée



N°	Icône	Élément	Description
		Indicateur d'alimentation	Indique l'état d'alimentation de l'ordinateur.
1		Indicateur de la batterie	Indique l'état de la batterie de l'ordinateur. <b>1. Charge</b> : La lumière est orange lorsque la batterie se recharge. <b>2. Pleine charge</b> : La diode est bleue en mode secteur.
		Indicateur du disque dur	Indique l'activité du disque dur.
2		Prise microphone	Accepte les entrées de microphones externes.
		Prise haut-parleurs/casque	Se connecte à des périphériques audio (p.ex. haut-parleurs ou un casque stéréo).
3		Lecteur de cartes multiples en un	Accepte une carte mémoire Secure Digital (SD), MultiMediaCard (MMC), Memory Stick Pro (MS PRO) et xD-Picture (xD). <b>Remarque</b> : Poussez pour retirer/installer la carte. Seule une carte peut fonctionner à tout moment.
4		Commutateur/indicateur de communication	Active/désactive les périphériques de communication de l'ordinateur/indique l'état du périphérique de connectivité sans fil de l'ordinateur.

## Vue gauche



N°	Icône	Élément	Description
1		Prise d'alimentation	Se connecte à l'adaptateur secteur.
2		Port HDMI	Prend en charge les connexions vidéo numériques à haute définition.
3		Port d'affichage (VGA) externe	Se connecte à un périphérique d'affichage (p. ex. un moniteur externe, un projecteur LCD).
4		Port USB/eSATA	Se connecte à des périphériques USB ou eSATA (seulement pour certains modèles). <b>Remarque :</b> Si vous connectez un périphérique eSATA, vous aurez trois ports USB disponibles.
5		Emplacement SmartCard	Accepte une SmartCard.
6		Emplacement pour ExpressCard/34	Accepte un module ExpressCard/34. <b>Remarque :</b> Poussez pour retirer/insérer la carte.

## Vue droite







N°	Icône	Élément	Description
1		Port USB	Se connecte à des périphériques USB.
2		Port USB	<i>Si un port est noir, il est compatible USB 2.0, si un port est bleu, il est également compatible USB 3.0.</i>
3		Port USB avec charge hors tension	
4		Lecteur optique	Lecteur optique interne, accepte les CD ou les DVD.
5		Indicateur d'accès du disque optique	S'allume lorsque le lecteur optique est actif.
6		Bouton d'éjection du lecteur optique	Éjecte le disque optique du lecteur.
7		Trou d'éjection d'urgence	Éjecte le plateau du lecteur optique lorsque l'ordinateur est hors tension. <b>Remarque :</b> Insérez un trombone dans le trou d'éjection d'urgence pour éjecter le plateau du lecteur optique même quand l'ordinateur est éteint.
8		Port Ethernet RJ-45	Se connecte à un réseau Ethernet 10/100/1000 Base.
9		Fente pour cadenas Kensington	Se connecte à un cadenas de sécurité pour ordinateur Kensington. <b>Remarque :</b> Enroulez le câble du cadenas de sécurité pour ordinateur autour d'une table, de la poignée d'un tiroir verrouillé, ou de tout autre objet fixe. Insérez le cadenas dans l'encoche et tournez la clef pour verrouiller le cadenas. Certains modèles ne possèdent pas de clef.

## Informations sur USB 3.0

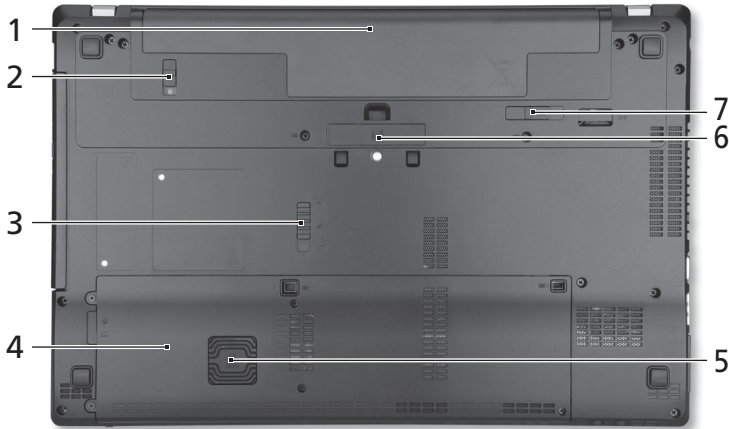
- Compatible avec USB 3.0 et périphériques USB antérieurs.
- Pour des performances optimales, utilisez des périphériques certifiés USB 3.0.
- Défini par la spécification USB 3.0 (SuperSpeed USB).

## Vue de la base



N°	Icône	Élément	Description
1		Baie de la batterie	Contient la batterie de l'ordinateur.
2		Verrou de la batterie	Verrouille la batterie en position.
3		Loquet de libération Acer MediaBay	Libère le module Acer MediaBay.
4		Baie du disque dur	Contient le disque dur de l'ordinateur (fixé avec des vis).
		Compartiment mémoire	Contient la mémoire principale de l'ordinateur.
5		Acer DASP (protection anti- choc du disque)	Protège votre disque dur des chocs accidentels et des secousses.



N°	Icône	Élément	Description
6		Connecteur Acer ProDock	Se connecte au Acer ProDock en option.
7		Loquet de libération de la batterie	Libère la batterie pour le retrait.

## Environnement

- Température :
  - En marche : 5°C à 35°C
  - À l'arrêt : -20°C à 65°C
- Humidité (sans condensation) :
  - En marche : 20% à 80%
  - À l'arrêt : 20% à 80%



# TravelMate-Notebook

## Kurzanleitung

### Produktregistrierung

Wenn Sie das Produkt zum ersten Mal verwenden, sollten Sie es umgehend registrieren. Sie kommen so in den Genuss einer Reihe von Vorteilen, einschließlich:

- Schnellere Dienstleistungen durch unsere geschulten Vertreter.
- Mitgliedschaft in der Acer-Community: Empfang von Sonderangeboten und Teilnahme an Kundenumfragen.
- Die aktuellsten Neuigkeiten von Acer.

Registrieren Sie sich auf der Stelle, da noch andere Vorteile auf Sie warten!

### Wie Sie Ihr Produkt registrieren können

Um Ihr Acer Produkt zu registrieren, besuchen Sie bitte **www.acer.com**. Wählen Sie Ihr Land aus, klicken Sie auf **PRODUKTREGISTRIERUNG** und folgen Sie den einfachen Anweisungen.

Sie werden während des Einrichtungsprozesses ebenfalls zur Registrierung Ihres Produktes aufgefordert. Alternativ können Sie einen Doppelklick auf das Symbol Registrierung auf dem Desktop ausführen.

Nachdem wir Ihre Produktregistrierung erhalten haben, senden wir Ihnen eine E-Mail zur Bestätigung, die wichtige Informationen enthält, die Sie an einem sicheren Ort aufbewahren sollten.

### Acer Zubehör

Wir freuen uns Ihnen mitzuteilen, dass das Garantie-Erweiterungsprogramm von Acer sowie Notebook-Zubehör online erhältlich sind. Besuchen Sie unseren Online Shop unter **store.acer.com**.

Der Acer Store befindet sich im Aufbau und könnte möglicherweise in einigen Regionen nicht verfügbar sein. Bitte schauen Sie regelmäßig vorbei, um zu erfahren, wann er in Ihrem Land verfügbar ist.

© 2012 Alle Rechte vorbehalten.

TravelMate-Notebook-Kurzanleitung  
Diese Überarbeitung: 07/2012

Modellnummer: \_\_\_\_\_

Seriennummer: \_\_\_\_\_

Kaufdatum: \_\_\_\_\_

Kaufort: \_\_\_\_\_

## Das Wichtigste zuerst

Wir möchten uns bei Ihnen dafür bedanken, dass Sie sich in Bezug auf mobilen Computerbedarf für ein Acer-Notebook entschieden haben.

## Hilfen

Als Hilfe für Sie beim Benutzen Ihres Acer-Notebooks haben wir einen Satz von Richtlinien aufgestellt:

Zuallererst hilft Ihnen das **Übersichtsblatt**, den Computer das erste Mal in Betrieb zu nehmen.

Die **Kurzanleitung** stellt Ihnen die grundlegenden Features und Funktionen Ihres neuen Computers vor.

Für weitere Informationen dazu, wie Ihnen Ihr Computer helfen kann, noch produktiver zu arbeiten, lesen Sie bitte das **Benutzerhandbuch**. Das **Benutzerhandbuch** enthält nützliche Informationen über Ihren neuen Computer. Es werden Themen wie z. B. die Verwendung von Tastatur und Audio usw. behandelt.

Dieses Benutzerhandbuch enthält detaillierte Informationen zu Themen wie z. B. Systemprogramme, Datenwiederherstellung, Erweiterungsoptionen und Problembeseitigung. Darüber hinaus enthält es Informationen zur Garantie und allgemeine Bestimmungen und Sicherheitshinweise zu Ihrem Notebook.

Gehen Sie folgendermaßen vor, um auf die Bedienungsanleitung zuzugreifen:

- 1 Geben Sie unter *Start* „Benutzer“ ein.
- 2 Klicken Sie auf **Acer Benutzerhandbuch**.







# Ihre Acer-Notebook-Tour

Nachdem Sie den Computer wie im Übersichtsblatt gezeigt aufgestellt haben, finden Sie im Folgenden eine Übersicht über Ihr neues Acer-Notebook.

## Ansicht von oben













#	Symbol	Element	Beschreibung
1		Integrierte Webcam	Web-Kamera für Videokommunikation. <i>Ein Licht neben der Webcam zeigt an, dass die Webcam aktiv ist.</i>

#	Symbol	Element	Beschreibung
2		Bildschirm	Wird auch als LCD (Liquid-Crystal-Display) bezeichnet. Zeigt die Ausgabe des Computers an (Konfiguration kann sich von Modell zu Modell unterscheiden).
3		Tastatur	Dient der Eingabe von Daten in den Computer.
4		Caps Lock	Leuchtet auf, wenn die Caps Lock-Funktion aktiviert ist.
5		Touchpad	Berührungssensibles Zeigergerät, das die gleichen Funktionen besitzt wie eine Computer-Maus.
6		Fingerabdruckleser	Fingerabdruckleser für Acer ProShield Security Suite.
7		Anklicktasten (links und rechts)	Die linken und rechten Tasten funktionieren wie die linken und rechten Tasten einer Maus.
8		Num Lock	Leuchtet auf, wenn die Num Lock-Funktion aktiviert ist.
		P-Taste	Programmierbare Taste (Konfiguration kann sich von Modell zu Modell unterscheiden).
		Acer-E-Mail-Taste	Hiermit öffnen Sie Ihre Standard-E-Mail-Applikation.
9		Sicherungsschlüssel	Hiermit starten Sie den Acer Backup Management für die dreistufige Datensicherung.
		Mikrofon aus	Hiermit deaktivieren Sie das Mikrofon.
		Ein/Aus-Taste/-Anzeige	Schaltet den Computer ein und aus. Zeigt den Ein/Aus-Status des Computers an.
10		Mikrofone	Zwei interne Mikrofone für die Stereo-Tonaufnahme.

## Direkttasten

Der Computer besitzt Direkttasten oder Tastenkombinationen für den Zugriff auf Computersteuerungen wie z. B. Bildschirmhelligkeit und Ausgangslautstärke.

Zum Aktivieren von Direkttasten müssen Sie zuerst die **<Fn>**-Taste drücken und halten und dann die andere Taste der Direkttastenkombination drücken.

Direkttaste	Symbol	Funktion	Beschreibung
<b>&lt;Fn&gt; + &lt;F3&gt;</b>		Kommunikation	Aktiviert/Deaktiviert die Kommunikationsgeräte des Computers.
<b>&lt;Fn&gt; + &lt;F4&gt;</b>		Energiesparmodus	Schaltet den Computer in den Energiesparmodus.
<b>&lt;Fn&gt; + &lt;F5&gt;</b>		Display-Schalter	Wechselt die Anzeigerausgabe zwischen Anzeigebildschirm, externem Monitor (falls angeschlossen) und gleichzeitig beiden Anzeigen.
<b>&lt;Fn&gt; + &lt;F6&gt;</b>		Bildschirm leer	Schaltet die Hintergrundbeleuchtung des Bildschirms aus, um Energie zu sparen. Drücken Sie zum Einschalten eine beliebige Taste.
<b>&lt;Fn&gt; + &lt;F7&gt;</b>		Touchpad-Schalter	Schaltet das interne Touchpad ein oder aus.
<b>&lt;Fn&gt; + &lt;F8&gt;</b>		Lautsprecher-schalter	Schaltet die Lautsprecher ein und aus.
<b>&lt;Fn&gt; + &lt;▷&gt;</b>		Heller	Erhöht die Bildschirmhelligkeit.
<b>&lt;Fn&gt; + &lt;◁&gt;</b>		Dunkler	Verringert die Bildschirmhelligkeit.
<b>&lt;Fn&gt; + &lt;△&gt;</b>		Lauter	Erhöht die Lautstärke.
<b>&lt;Fn&gt; + &lt;▽&gt;</b>		Leiser	Verringert die Lautstärke.
<b>&lt;Fn&gt; + &lt;Pos1&gt;</b>		Wiedergabe/ Pause	Geben Sie hiermit die ausgewählte Mediendatei wieder und halten Sie die Wiedergabe an.



Direkttaste	Symbol	Funktion	Beschreibung
<Fn> + <Pg Up>	■	Stopp	Beenden Sie hiermit die Wiedergabe der ausgewählten Mediendatei.
<Fn> + <Pg Dn>	◀◀	Zurück	Hiermit gelangen Sie zur vorherigen Mediendatei zurück.
<Fn> + <Ende>	▶▶	Weiter	Hiermit springen Sie zur nächsten Mediendatei.

## Geschlossene Vorderseite

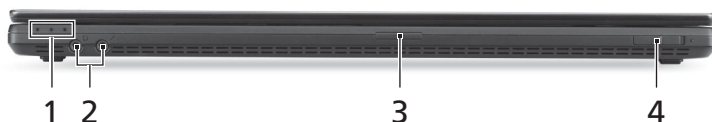





#	Symbol	Element	Beschreibung
		Energieanzeige	Zeigt den Ein/Aus-Status des Computers an.
1		Akku-Anzeige	Zeigt den Akkustatus des Computers an. <b>1. Aufladung:</b> Die Leuchte erscheint gelb, wenn der Akku aufgeladen wird. <b>2. Voll aufgeladen:</b> Die Leuchte erscheint blau, wenn Netzstrom verwendet wird.
		Festplatten-Anzeige	Leuchtet auf, wenn die Festplatte aktiv ist.
2		Mikrofonbuchse	Eignet sich für Eingaben aus externen Mikrofonen.
		Kopfhörer-/ Lautsprecher-Buchse	Zum Anschluss von Audiogeräten (z. B. Lautsprechern, Kopfhörern).
3		Mehrere-in-1-Kartenleser	Eignet sich für Secure Digital (SD), MultiMediaCard (MMC), Memory Stick PRO (MS PRO) und xD-Picture Card (xD). <b>Hinweis:</b> Drücken Sie hier, um die Karte zu entfernen/einzusetzen. Es kann nicht mehr als eine Karte gleichzeitig verwendet werden.

#	Symbol	Element	Beschreibung
4		Schalter/Anzeige für Kommunikation	Aktiviert/Deaktiviert die Kommunikationsgeräte des Computers; zeigt den Status der Drahtlosverbindung des Computers an.

## Linke Seite



#	Symbol	Element	Beschreibung
1		DC-Eingangsbuchse	Hier schließen Sie das Netzteil an.
2		HDMI-Anschluss	Unterstützt digitale High-Definition-Video-Verbindungen.
3		Anschluss für externe Anzeige (VGA)	Dient dem Anschluss eines Anzeigegerätes (z. B. einem externen Monitor oder LCD-Projektor).
4		USB/eSATA-Anschluss	Schließen Sie hier USB- oder eSATA-Geräte an (Nur für bestimmte Modelle). <b>Hinweis:</b> Wenn Sie ein eSATA-Gerät anschließen, stehen Ihnen drei USB-Schnittstellen zur Verfügung.
5		SmartCard-Steckplatz	Eignet sich für eine SmartCard.
6		ExpressCard/34-Steckplatz	Eignet sich für ein ExpressCard/34 Modul. <b>Hinweis:</b> Drücken Sie hier, um die Karte zu entfernen/einzusetzen.

## Rechte Seite







#	Symbol	Element	Beschreibung
1		USB-Anschluss	
2		USB-Anschluss	Dient dem Anschluss von USB-Geräten.
3		USB-Anschluss mit Ladung bei ausgeschaltetem Gerät	Wenn ein Anschluss schwarz ist, ist er mit USB 2.0 kompatibel; wenn er blau ist, ist er auch mit USB 3.0 kompatibel.
4		Optisches Laufwerk	Internes optisches Laufwerk; eignet sich für CDs oder DVDs.
5		Optische Disk Anzeige	Leuchtet auf, wenn optisches Laufwerk aktiv ist.
6		Auswurfaste für optisches Laufwerk	Führt das optische Laufwerk heraus.
7		Mechanisches Auswurfloch	Schiebt den Träger des optischen Laufwerkes aus, wenn der Computer ausgeschaltet ist. <b>Hinweis:</b> Stecken Sie eine Büroklammer in das Auswurfloch, um den Träger des optischen Laufwerkes herauszufahren, wenn der Computer nicht eingeschaltet ist.
8		Ethernet (RJ-45)-Anschluss	Hier schließen Sie ein auf Ethernet 10/100/1000-basiertes Netzwerk an.
9		Steckplatz für Kensington-Schloss	Hier können Sie ein Kensington-kompatibles Sicherheitsschloss für den Computer anbringen. <b>Hinweis:</b> Binden Sie ein Diebstahlsicherungskabel an ein unbewegliches Objekt wie einen Tisch oder einen Griff einer abgeschlossenen Schublade. Stecken Sie das Schloss in den Anschluss für die Diebstahlsicherung, und schließen Sie dieses ab. Es gibt auch Modelle ohne Schlüssel.

## Informationen zu USB 3.0

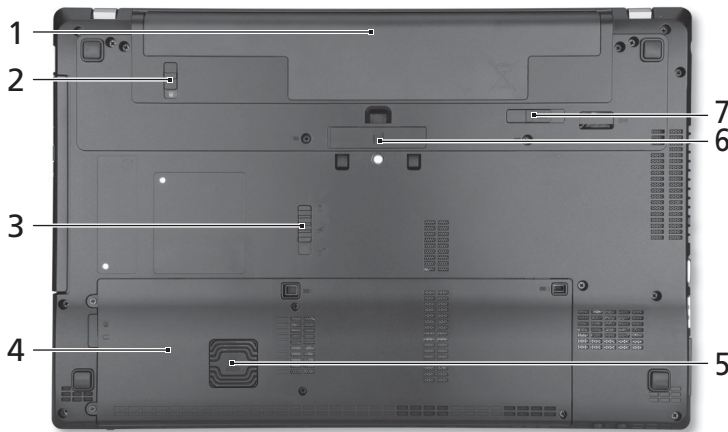
- Kompatibel mit USB 3.0 und früheren USB-Geräten.
- Für eine optimale Leistung sollten zertifizierte USB 3.0 Geräte verwendet werden.
- Definiert nach die USB 3.0 (SuperSpeed USB) Spezifikation.

## Unterseite



#	Symbol	Element	Beschreibung
1		Akkufach	Enthält den Akku des Computers.
2		Akkuerschluss	Sichert den Akku an seiner Position.
3		Verriegelung für Acer MediaBay	Gibt das Acer MediaBay Modul frei.
4		Festplattenfach	Enthält die Computer-Festplatte (durch Schrauben gesichert).
		Speicherfach	Enthält den Hauptspeicher des Computers.
5		Acer DASP (Disk Anti-Shock Protection)	Schützt die Festplatte vor Stößen und Erschütterungen.

#	Symbol	Element	Beschreibung
6		Acer ProDock Anschluss	Anschluss an das optionale Acer ProDock.
7		Verriegelung des Akkus	Entsperrt den Akku für die Herausnahme.

## Umgebung

- Temperatur:
  - Betrieb: 5°C bis 35°C
  - Nichtbetrieb: -20°C bis 65°C
- Luftfeuchtigkeit (nicht kondensierend):
  - Betrieb: 20% bis 80%
  - Nichtbetrieb: 20% bis 80%



# Notebook TravelMate

## Guida rapida

### Registrazione del prodotto

Quando usate il prodotto per la prima volta si raccomanda di registrarlo immediatamente. Ciò vi darà accesso ad una serie di benefici utili, come:

- Assistenza più veloce da parte dei nostri rappresentanti specializzati.
- Diventare membro della comunità Acer: ricezione di promozioni e partecipazione ai sondaggi.
- Le ultime notizie da Acer.

Affrettatevi e registratevi, altri vantaggi vi attendono!

### Come eseguire la registrazione

Per registrare il prodotto Acer, visitare **www.acer.com**. Selezionare il proprio paese, fare clic su **REGISTRAZIONE DEL PRODOTTO** e seguire le istruzioni.

Verrà richiesto di registrare il prodotto durante il processo di configurazione, oppure è possibile fare doppio clic sull'icona Registrazione sul desktop.

Dopo aver ricevuto la registrazione del vostro prodotto, vi invieremo una e-mail di conferma con dati importanti che dovrete conservare in un posto sicuro.

### Ottenere gli accessori Acer

Siamo lieti di informarvi che il programma di estensione della garanzia Acer e gli accessori Netbook sono disponibili online. Venite a visitare il nostro negozio online e trovate ciò che vi serve su **store.acer.com**.

Il negozio Acer è ancora in fase di lancio e, sfortunatamente, potrebbe non essere disponibile in alcune regioni. Ricontrollate regolarmente per vedere quando sarà disponibile nel vostro paese.

© 2012 Tutti i diritti riservati.

Guida rapida per Notebook TravelMate

Questa versione: 07/2012

Numero di modello: \_\_\_\_\_

Numero di serie: \_\_\_\_\_

Data di acquisto: \_\_\_\_\_

Luogo d'acquisto: \_\_\_\_\_



## Avvertenze preliminari

Grazie per aver scelto il notebook Acer, la scelta ideale per poter lavorare in piena libertà anche in movimento.

## Le guide disponibili

Sono state realizzate delle guide per assistere l'utente nell'uso del notebook Acer:

Innanzitutto, il **Manifesto** aiuta a semplificare la configurazione del computer.

La **Guida rapida** presenta le caratteristiche e le funzioni principali del nuovo computer.

Per altre nozioni su come il vostro computer può aiutarvi a diventare ancora più produttivi, consultate il **Manuale dell'utente**. Il **Manuale dell'utente** contiene informazioni utili relative al nuovo computer. Copre gli argomenti base come ad esempio l'uso della tastiera, audio, ecc.

Questa guida contiene informazioni dettagliate su argomenti come utilità del sistema, ripristino dei dati, opzioni di espansione e ricerca guasti. Contiene inoltre informazioni sulla garanzia, le norme e gli standard di riferimento e le avvertenze per la sicurezza del vostro notebook.

Per accedervi seguite questi passaggi:

- 1 Digitare "Utente" da *Start*.
- 2 Fare clic su **Manuale dell'utente Acer**.





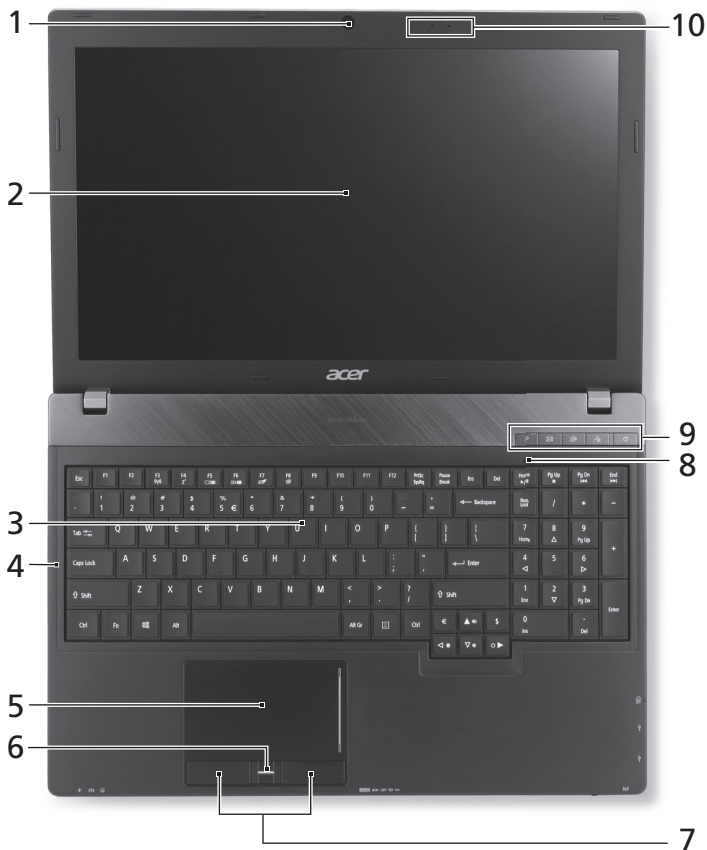

## Presentazione del notebook Acer

Dopo aver configurato il computer come illustrato nel manifesto, far riferimento alla presente documentazione per la presentazione del nuovo notebook Acer.

### Vista dall'alto













#	Icona	Elemento	Descrizione
1		Webcam integrata	Web camera per la comunicazione video. <i>Una luce accanto alla webcam indica che la webcam è attiva.</i>

#	Icona	Elemento	Descrizione
2		Schermo	Grande display a cristalli liquidi (Liquid-Crystal Display; LCD), per una visualizzazione confortevole (la configurazione può variare in relazione al modello).
3		Tastiera	Per l'immissione di dati sul computer.
4		Bloc Maiusc	Si illumina quando Bloc Maiusc è attivato.
5		Touchpad	Dispositivo di puntamento sensibile al tocco con funzioni simili a quelle di un comune mouse.
6		Lettoce impronte digitali	Lettoce impronte digitali per Acer ProShield Security Suite.
7		Tasti clic (sinistra e destra)	I tasti destra e sinistra hanno le stesse funzioni dei tasti destra e sinistra del mouse.
8		Bloc Num	Si illumina quando Bloc Num è attivato.
		Tasto P	Tasto programmabile (la configurazione può variare in relazione al modello).
		Tasto e-mail Acer	Apri l'applicazione e-mail predefinita.
9		Tasto Backup	Avvia Acer Backup Management per il backup dei dati in tre fasi.
		Microfono disattivo	Azzera il volume del microfono.
		Pulsante di accensione/indicatore	Accende/spegne il computer. Indicano lo stato di accensione/alimentazione del computer.
10		Microfoni	Due microfoni interni per la registrazione di audio stereo.

## Tasti di scelta rapida

Il computer utilizza i tasti di scelta o le combinazioni di tasti per l'accesso a molti controlli del computer come luminosità dello schermo e uscita volume.

Per attivare i tasti di scelta rapida, tenere premuto **<Fn>** e premere l'altro tasto della combinazione.

Tasti di scelta rapida	Icona	Funzione	Descrizione
<b>&lt;Fn&gt; + &lt;F3&gt;</b>		Comunicazioni	Attiva/disattiva i dispositivi di comunicazione del computer.
<b>&lt;Fn&gt; + &lt;F4&gt;</b>		Sospensione	Attiva la modalità sospensione del computer.
<b>&lt;Fn&gt; + &lt;F5&gt;</b>		Passaggio da uno schermo all'altro	Consente la commutazione in uscita display tra video del display o monitor esterno (se collegato) e entrambi.
<b>&lt;Fn&gt; + &lt;F6&gt;</b>		Avvio di screen saver	Disattiva la retroilluminazione dello schermo per risparmiare energia. Premere un tasto qualsiasi per tornare allo stato precedente.
<b>&lt;Fn&gt; + &lt;F7&gt;</b>		Attivazione e disattivazione del touchpad	Attiva e disattiva il touchpad interno.
<b>&lt;Fn&gt; + &lt;F8&gt;</b>		Attivazione e disattivazione degli altoparlanti	Attiva e disattiva gli altoparlanti.
<b>&lt;Fn&gt; + &lt;▷&gt;</b>		Aumento della luminosità	Aumenta la luminosità dello schermo.
<b>&lt;Fn&gt; + &lt;◁&gt;</b>		Riduzione della luminosità	Riduce la luminosità dello schermo.
<b>&lt;Fn&gt; + &lt;△&gt;</b>		Volume su	Aumenta il volume.
<b>&lt;Fn&gt; + &lt;▽&gt;</b>		Volume giù	Riduce il volume.
<b>&lt;Fn&gt; + &lt;Home&gt;</b>		Riproduci/Pausa	Riproduce o sospende la riproduzione del file multimediale selezionato.

Tasti di scelta rapida	Icona	Funzione	Descrizione
<Fn> + <Pag su>	■	Arresto	Interrompe la riproduzione del file multimediale selezionato.
<Fn> + <Pag giù>	◀◀	Precedente	Per passare al file multimediale precedente.
<Fn> + <Fine>	▶▶	Avanti	Per passare al file multimediale successivo.

## Vista frontale in dettaglio

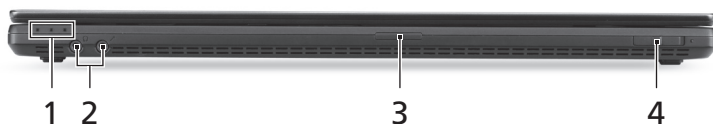





#	Icona	Elemento	Descrizione
		Indicatore di accensione/alimentazione	Indicano lo stato di accensione/alimentazione del computer.
1		Indicatore della batteria	Indica lo stato della batteria del computer. <b>1. In carica:</b> Luce di colore giallo quando la batteria è in ricarica. <b>2. Completamente carica:</b> Luce di colore blu quando è nella modalità CA.
		Indicatore disco rigido	Si accende quando l'unità disco rigido è attiva.
2		Jack microfono	Accetta ingressi provenienti da microfoni esterni.
		Jack auricolari/altoparlanti	Effettua il collegamento ai dispositivi audio (ad es., altoparlanti, auricolari).
3		Lettoře di schede multiple	Supporta Secure Digital (SD), MultiMediaCard (MMC), Memory Stick Pro (MS PRO), xD-Picture Card (xD). <b>Nota:</b> Premere per rimuovere/installare la scheda. È possibile utilizzare una sola scheda di memoria alla volta.

#	Icona	Elemento	Descrizione
4		Indicatore/interruttore di comunicazione	Attiva/disattiva i dispositivi di comunicazione del computer/indica lo stato del dispositivo di connettività wireless del computer.





## Vista da sinistra



#	Icona	Elemento	Descrizione
1		Jack CC-in	Per il collegamento all'adattatore CA.
2		Porta HDMI	Supporta il collegamento per video digitali ad alta definizione.
3		Porta display esterno (VGA)	Effettua il collegamento a un dispositivo di visualizzazione (ad es., monitor esterno, proiettore LCD).
4		Porta USB/eSATA	Per collegamento a dispositivi USB o eSATA (solo per alcuni modelli). <b>Nota:</b> Se viene collegato un dispositivo eSATA, saranno contemporaneamente disponibili tre porte USB.
5		Slot SmartCard	Accetta una SmartCard.
6		Slot ExpressCard/34	Accetta un modulo ExpressCard/34. <b>Nota:</b> Premere per rimuovere/inserire la scheda.

## Vista da destra







#	Icona	Elemento	Descrizione
1		Porta USB	Connette a dispositivi USB.
2		Porta USB	<i>Se la porta è nera, è compatibile con USB 2.0, se la porta è blu è compatibile anche con USB 3.0.</i>
3		Porta USB con caricamento da spento	
4		Lettoce ottico	Unità ottica interna, accetta CD o DVD.
5		Indicatore accesso disco ottico	Si accende quando il disco ottico è attivo.
6		Tasto di espulsione del disco ottico	Espelle il disco ottico dall'unità.
7		Foro di espulsione di emergenza	Espelle il vassoio del disco ottico se il computer è spento. <b>Nota:</b> <i>Inserire la punta di un fermaglio nel foro di apertura di emergenza per espellere il vassoio dell'unità ottica quando il computer è spento.</i>
8		Porta Ethernet (RJ-45)	Per il collegamento a una rete con Ethernet 10/100/1000.
9		Slot blocco Kensington	Per il collegamento al blocco di sicurezza dei computer Kensington-compatibili. <b>Nota:</b> <i>Avvolgere un cavo di sicurezza per computer intorno ad un oggetto fisso, ad esempio un tavolo o la maniglia di un cassetto chiuso a chiave. Inserire la serratura nel foro e girare la chiave per fissare il blocco. Sono disponibili anche modelli senza chiave.</i>

## Informazioni su USB 3.0

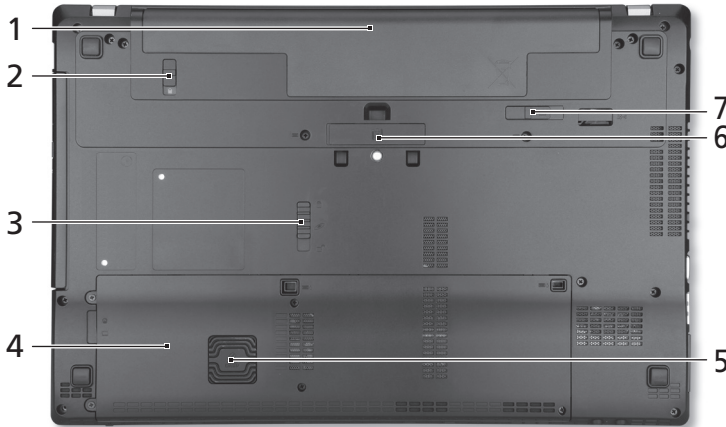
- Compatibile con USB 3.0 e i dispositivi USB precedenti.
- Per una prestazione ottimale, usare dispositivi certificati USB 3.0.
- Definito dalle specifiche USB 3.0 (SuperSpeed USB).

## Vista base



#	Icona	Elemento	Descrizione
1		Alloggiamento della batteria	Contiene il modulo batteria del computer.
2		Blocco batteria	Blocca la batteria al suo posto.
3		Chiusura a scatto Acer MediaBay	Rilascia il modulo Acer MediaBay.
4		Alloggiamento per il disco rigido	Contiene il disco rigido del computer (fissato con viti).
		Vano per la memoria	Contiene la memoria principale del computer.
5		Acer DASP (Disk Anti-Shock Protection – Protezione disco anti-shock)	Protegge l'unità disco rigido da urti e colpi.
6		Connettore Acer ProDock	Collega l'Acer ProDock opzionale.
7		Gancio di rilascio della batteria	Per togliere la batteria.



## Condizioni operative

---

- Temperatura:
    - Di esercizio: Da 5°C a 35°C
    - Non di esercizio: Da -20°C a 65°C
  - Umidità (senza condensa):
    - Di esercizio: Da 20% a 80%
    - Non di esercizio: Da 20% a 80%
-



# Portátil TravelMate

## Guía rápida

### Registro del producto

Al usar su producto por primera vez, se recomienda que lo registre inmediatamente. Ello le permitirá disfrutar de algunas útiles ventajas, tales como:

- Un servicio más rápido de nuestros representantes cualificados.
- Ser miembro de la comunidad Acer: recibir promociones y participará en encuestas de clientes.
- Las últimas noticias de Acer.

Apresúrese a registrarse, ¡allí le esperan un sinfín de ventajas!

### Cómo registrarse

Para registrar su producto de Acer, visite **www.acer.com**. Seleccione su país, haga clic en **REGISTRO DE PRODUCTO** y siga las sencillas instrucciones.

También se le pedirá que registre su producto durante el proceso de configuración, o puede hacer doble clic en el icono de Registro en el escritorio.

Después de recibir su registro de producto, se le remitirá un correo electrónico de confirmación con datos importantes que deberá guardar en un lugar seguro.

### Obtener los accesorios de Acer

Nos complace informarle que el programa de ampliación de garantía de Acer y los accesorios del portátil están disponibles en línea. Venga a visitar nuestra tienda en línea y encuentre lo que necesita en **store.acer.com**.

La tienda de Acer se está implementando de forma progresiva y, lamentablemente, puede que no esté disponible en algunas regiones. Consúltela regularmente para ver cuándo estará disponible en su país.

© 2012 Reservados todos los derechos.

Guía rápida del portátil TravelMate

Esta revisión: 07/2012

Número de modelo: \_\_\_\_\_

Número de serie: \_\_\_\_\_

Fecha de compra: \_\_\_\_\_

Lugar de compra: \_\_\_\_\_

# Primero lo más importante

Le agradecemos que haya elegido el ordenador portátil de Acer para satisfacer sus necesidades de informática móvil.

## Sus guías

Para ayudarle a utilizar el ordenador portátil Acer, hemos elaborado un conjunto de guías:

En primer lugar, el **Póster de configuración** contiene información de ayuda para configurar su ordenador.

Esta **Guía rápida** presenta las características y funciones básicas de su nuevo ordenador.

Si desea más información sobre cómo puede su ordenador ayudarle a ser más productivo, consulte el **Manual de usuario**. El **Manual de usuario** contiene información útil sobre su nuevo equipo. Contempla aspectos básicos como el uso del teclado, el audio, etc.

Esta guía contiene información detallada sobre temas como utilidades del sistema, recuperación de datos, opciones de ampliación y solución de problemas. Además, contiene información sobre garantías y las normativas generales y advertencias de seguridad para su ordenador portátil.

Siga estos pasos para acceder al manual:

- 1 Escriba "Usuario" desde *Inicio*.
- 2 Haga clic en **Manual de usuario de Acer**.







# Un paseo por el ordenador portátil Acer

Una vez configurado el ordenador del modo indicado en el póster, iniciaremos un paseo por su nuevo portátil Acer.

## Vista superior











#	Icono	Elemento	Descripción
1		Webcam integrada	Cámara Web para comunicación de vídeo. <i>Una luz junto a la webcam indica que esta está activa.</i>

#	Icono	Elemento	Descripción
2		Pantalla	También denominada pantalla de cristal líquido (LCD) es el dispositivo de salida visual del ordenador (la configuración puede variar según el modelo).
3		Teclado	Para introducir datos en su ordenador.
4		Bloq Mayús	Se enciende al activar el bloqueo de mayúsculas.
5		Panel táctil	Dispositivo apuntador táctil que funciona como un ratón de ordenador.
6		Lector de huellas dactilares	Lector de huellas dactilares para Acer ProShield Security Suite.
7		Botones de clic (izquierdo y derecho)	Los botones izquierdo y derecho funcionan como los botones izquierdo y derecho del ratón.
8		Bloqueo numérico	Se enciende al activar el bloqueo del teclado numérico.
9		Tecla P	Tecla programable (la configuración puede variar según el modelo).
		Tecla de correo electrónico de Acer	Permite abrir su aplicación de correo electrónico predeterminada.
		Tecla Copia de seguridad	Inicia Acer Backup Management para poder realizar una copia de seguridad de datos en tres pasos.
		Silenciar micrófono	Silencia el micrófono.
		Indicador/botón de alimentación	Enciende o apaga el ordenador. Proporciona información sobre el estado de energía del ordenador.
10		Micrófonos	Dos micrófonos internos estéreo para la grabación de sonido estéreo.

## Teclas de acceso directo

El ordenador permite usar teclas de acceso directo o combinaciones de teclas para acceder a la mayoría de controles del ordenador, como el brillo de la pantalla o la salida de volumen.

Para activar las teclas de acceso directo, mantenga pulsada la tecla **<Fn>** y pulse la otra tecla de la combinación.

Tecla de acceso directo	Icono	Función	Descripción
<b>&lt;Fn&gt; + &lt;F3&gt;</b>		Comunicación	Activa/desactiva los dispositivos de comunicación del ordenador.
<b>&lt;Fn&gt; + &lt;F4&gt;</b>		Suspensión	Pone el ordenador en modo de suspensión.
<b>&lt;Fn&gt; + &lt;F5&gt;</b>		Selector de pantalla	Permite cambiar la salida entre la pantalla y el monitor externo (si está conectado) o ambos.
<b>&lt;Fn&gt; + &lt;F6&gt;</b>		Pantalla en blanco	Apaga la luz de fondo de la pantalla para ahorrar energía. Pulse cualquier tecla para encenderla.
<b>&lt;Fn&gt; + &lt;F7&gt;</b>		Alternar panel táctil	Activa o desactiva el panel táctil interno.
<b>&lt;Fn&gt; + &lt;F8&gt;</b>		Alternar altavoces	Activa o desactiva los altavoces.
<b>&lt;Fn&gt; + &lt;▷&gt;</b>		Aumentar brillo	Aumenta el brillo de la pantalla.
<b>&lt;Fn&gt; + &lt;◁&gt;</b>		Disminuir brillo	Disminuye el brillo de la pantalla.
<b>&lt;Fn&gt; + &lt;△&gt;</b>		Subir volumen	Sube el volumen.
<b>&lt;Fn&gt; + &lt;▽&gt;</b>		Bajar volumen	Baja el volumen.
<b>&lt;Fn&gt; + &lt;Inicio&gt;</b>		Reproducir/ Pausa	Reproduce o hace una pausa en un archivo multimedia seleccionado.



Tecla de acceso directo	Icono	Función	Descripción
<Fn> + <Re Pág>	■	Detener	Detiene la reproducción del archivo multimedia seleccionado.
<Fn> + <Av Pág>	◀◀	Anterior	Regresa al archivo multimedia anterior.
<Fn> + <Fin>	▶▶	Siguiente	Salta al siguiente archivo multimedia.

## Vista frontal cerrada

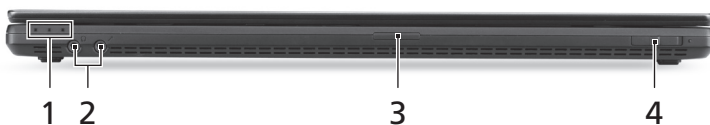





#	Icono	Elemento	Descripción
		Indicador de encendido	Proporciona información sobre el estado de energía del ordenador.
1		Indicador de batería	Proporciona información sobre el estado de la batería. <b>1. Carga:</b> La luz se vuelve ámbar cuando se carga la batería. <b>2. Carga completa:</b> La luz se vuelve azul en modo de CA.
		Indicador de disco duro	Indica si la unidad de disco duro está activa.
2		Conector del micrófono	Permite la entrada de audio de micrófonos externos.
		Toma de auriculares/altavoces	Conexión para dispositivos de audio (p. ej., altavoces, auriculares, etc.).
3		Lector de tarjetas multifunción	Admite la tarjeta Secure Digital (SD), MultiMediaCard (MMC), Memory Stick PRO (MS PRO), xD-Picture Card (xD). <b>Nota:</b> Presione para extraer/instalar la tarjeta. No se pueden usar varias tarjetas a la vez.

#	Icono	Elemento	Descripción
4		Interruptor/indicador de comunicación	Habilita/deshabilita los dispositivos de comunicación del ordenador e indica el estado del dispositivo de conectividad inalámbrica del ordenador.

## Vista izquierda



#	Icono	Elemento	Descripción
1		Conector de entrada de CC	Permite conectar a un adaptador de CA.
2		Puerto HDMI	Compatible con conexiones de vídeo digital de alta definición.
3		Puerto de visualización externo (VGA)	Conexión para pantallas (p. ej., monitor externo o proyector LCD).
4		Puerto USB/eSATA	Permite la conexión con dispositivos USB o eSATA (solo para determinados modelos). <b>Nota:</b> Si conecta un dispositivo eSATA, tendrá tres puertos USB disponibles.
5		Ranura para SmartCard	Acepta una SmartCard.
6		Ranura para ExpressCard/34	Admite un módulo ExpressCard/34. <b>Nota:</b> Presione para extraer/instalar la tarjeta.

## Vista derecha



#	Icono	Elemento	Descripción
1		Puerto USB	Conexión para dispositivos USB.
2		Puerto USB	<i>Si un puerto es negro, significa que es compatible con USB 2.0. Si es azul, también es compatible con USB 3.0.</i>
3		Puerto USB con carga en estado apagado	
4		Unidad óptica	Dispositivo óptico interno; acepta CDs y DVDs.
5		Indicador de acceso del disco óptico	Se enciende cuando la unidad óptica está activa.
6		Botón de expulsión de la unidad óptica	Expulsa el disco óptico de la unidad.
7		Orificio de expulsión de emergencia	Permite expulsar la bandeja de la unidad óptica cuando el ordenador está apagado. <b>Nota:</b> Introduzca un clip sujetapapeles en el orificio de expulsión para expulsar la bandeja de la unidad óptica cuando el ordenador esté apagado.
8		Puerto Ethernet (RJ-45)	Conexión para una red basada en Ethernet 10/100/1000.
9		Ranura de bloqueo Kensington	Permite conectar un candado de seguridad para ordenadores compatibles con Kensington. <b>Nota:</b> Enganche el cable de seguridad para ordenadores a un objeto fijo como una mesa o el tirador de un cajón cerrado con llave. Introduzca el candado en la ranura y gire la llave. También hay modelos sin llave.

## Información sobre USB 3.0

- Compatible con dispositivos USB 3.0 y anteriores.
- Para un rendimiento óptimo, utilice dispositivos con certificación USB 3.0.
- Definido por la especificación USB 3.0 (SuperSpeed USB).

## Vista de la base

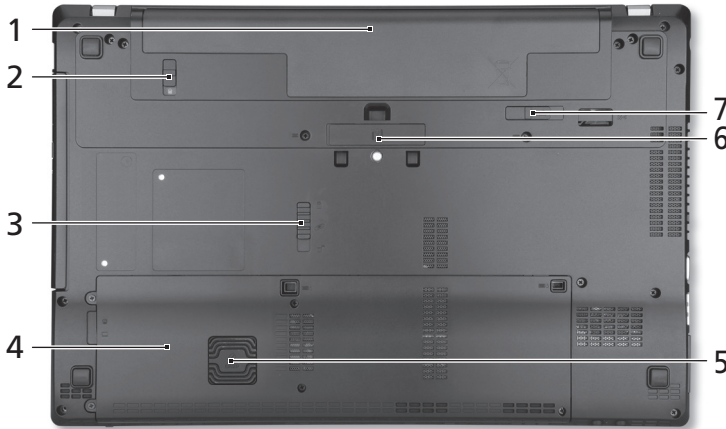

#	Icono	Elemento	Descripción
1		Compartimento de la batería	Aloja la batería del ordenador.
2		Bloqueo de la batería	Permite que la batería quede trabada.
3		Lengüeta para extracción, Acer MediaBay	Desbloquea el módulo Acer MediaBay.
4		Compartimento del disco duro	Contiene el disco duro del ordenador (fijado con tornillos).
		Compartimento de memoria	Contiene la memoria principal de ordenador.
5		Acer DASP (Sistema de protección de disco)	Protege el disco duro contra golpes e impactos. antichoque)

#	Icono	Elemento	Descripción
6		Conector Acer ProDock	Permite conectar al Acer ProDock opcional.
7		Pestillo de liberación de la batería	Libera la batería para poder sacarla.

## Medio ambiente

- Temperatura:
  - Encendido: Entre 5°C y 35°C
  - Apagado: Entre -20°C y 65°C
- Humedad (sin condensación):
  - Encendido: Entre 20% y 80%
  - Apagado: Entre 20% y 80%

## Notificacion Regulatoria Adicional

### [Argentina]

Acer notebook is bundled with the approved telecom modules for your networking. Those modules' model number and specific homologation number refers to below:

#### [Modem]

Modelo: RD02-D330	CNC 54-4512
Modelo: Delphi D40 (AM5)	CNC 54-5681

#### [Bluetooth]

Modelo: BCM92046	CNC 16-6735
Modelo: BCM92070MD_REF	CNC 16-7165
Modelo: T77H056	CNC 16-7788
Modelo: AR5BBU12	CNC 16-7946

#### [Bluetooth+802.11bgn]

Modelo: BCM943225HMB	CNC C-7497
----------------------	------------

#### [802.11AGN]

Modelo: 512AN_MMW	CNC C-6399
Modelo: 533AN_MMW	CNC C-6385
Modelo: 512AN_HMW	CNC C-7612
Modelo: 533AN_HMW	CNC C-7618
Modelo: 622ANHMW	CNC C-7682
Modelo: 633ANHMW	CNC C-7681

#### [802.11BGN]

Modelo: AR5B95	CNC C-7152
Modelo: AR5B93	CNC C-7151
Modelo: 112BNHMW	CNC C-7470
Modelo: 112BNMMW	CNC C-7471
Modelo: RTL8192SE	CNC C-7495
Modelo: BCM943225HM	CNC C-7395
Modelo: AR5B97	CNC C-7781
Modelo: BCM94313HMG2L	CNC C-7881

#### [802.11BG]

Modelo: BCM94312HMG	CNC 16-6180
---------------------	-------------



#### [3G]

Modelo: UNDP-1	CNC 17-6334
Modelo: Gobi2000	CNC 17-7291

## [Brasil] Noticia adicional de regulamento Anatel

Os componentes de telecomunicacao usados nos notebooks Acer em Portugues sao homologados atendendo a requisicao da Agencia Nacional de Telecomunicacoes Anatel, conforme referencia abaixo:

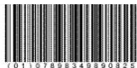

### [Modem]

Modelo: RD02-D330	 1406-05-1675	 (01)07898349890228
Modelo: Delphi_D40	 0455-06-2565	 (01) 0789 834089 0382

### [Bluetooth]

Modelo: BCM92046	 1434-08-2859	 (01)07898349892942
Modelo: BCM92070MD_REF	 0395-09-1869	 (01)07898349893048
Modelo: T77H056	 2281-09-3987	 (01)07898349890337
Modelo: AR5BBU12	 0127-10-3987	 (01)07898915960112

### [Bluetooth+802.11bgn]

Modelo: BCM943225HMB	 1260-09-1869	 (01)07898349893543
-------------------------	--	---



### [802.11AGN]

Modelo: 512AN_MMW	 0800-08-2198	 (01) 07898355950018
Modelo: 512AN_HMW	 0807-08-2198	 (01) 07898355950025
Modelo: 533AN_MMW	 0809-08-2198	 (01) 07898355950032
Modelo: 533AN_HMW	 0812-08-2198	 (01) 07898355950049
Modelo: 622ANHMW	 2123-09-2198	 (01) 07898355950094
Modelo: 633ANHMW	 2128-09-2198	 (01) 07898355950087





## [802.11BGN]

Modelo: AR5B95	 ANATEL 0223-09-3987	 0107898915959871
Modelo: AR5B93	 ANATEL 0190-09-3987	 (01) 07898915959864
Modelo: 112BNHMW	 ANATEL 1238-09-2198	 (01) 07898355950063
Modelo: 112BNMMW	 ANATEL 1237-09-2198	 (01) 07898355950070
Modelo: RTL8192SE	 ANATEL 1349-09-4076	 (01) 07898914152143
Modelo: BCM943225HM	 ANATEL 0795-09-1869	 (01) 07898349893246
Modelo: AR5B97	 ANATEL 2178-09-3987	 (01)07898915960013
Modelo: BCM94313HMG2L	 ANATEL 2429-09-1869	 (01)07898349893741

## [802.11BG]

Modelo: BCM94312HMG	 ANATEL 0060-08-1869	 (01) 0789 834989 234 8
------------------------	--	---

## [3G]

Modelo: UNDP-1	 ANATEL 0307-08-0540	 (01) 078989133101-8
Modelo: Gobi2000	 ANATEL 0412-09-0540	NA
Modelo: EM770W	 ANATEL 2460-09-3257	NA



## Notificación Regulatoria Adicional

### [Mexico-COFETEL]

Acer notebook is bundled with the approved telecom modules for your networking. Those modules' model number and specific homologation number refers to below:

#### [Modem]

Modelo: RD02-D330	COFETEL: TTDCORD06-536
Modelo: Delphi_D40 (AM5)	COFETEL: TTDAGDE07-056

#### [Bluetooth]

Modelo: BCM92046	COFETEL: RCPFOBC08-0472
Modelo: BCM92070MD_REF	COFETEL: RCPBRBC09-0213
Modelo: T77H056	COFETEL: RCPATT709-1049
Modelo: AR5BBU12	COFETEL: RCPATAR10-0064

#### [Bluetooth+802.11BGN]

Modelo: BCM943225HMB	COFETEL: RCPBRBC09-0574
----------------------	-------------------------

#### [802.11AGN]

Modelo: 512AN_HMW	COFETEL:RCPIN5108-0260
Modelo: 512AN_MMW	COFETEL:RCPIN5108-0260-A3
Modelo: 533AN_HMW	COFETEL:RCPIN5108-0260-A2
Modelo: 533AN_MMW	COFETEL:RCPIN5108-0260-A1
Modelo: 622ANHMW	COFETEL:RCPIN6209-1009
Modelo: 633ANHMW	COFETEL:RCPIN6309-1010

#### [802.11BGN]

Modelo: AR5B95	COFETEL:RCPATAR09-0168
Modelo: AR5B93	COFETEL: RCPATAR09-0167
Modelo: 112BNHMW	COFETEL: RCPIN1109-0613-A1
Modelo: 112BNMMW	COFETEL: RCPIN1109-0613
Modelo: RTL8192SE	COFETEL: RCPRERT09-0751
Modelo: BCM943225HM	COFETEL: RCPBRBC09-0464
Modelo: AR5B97	COFETEL: RCPATAR09-1103
Modelo: BCM94313HMG2L	COFETEL: RCPBRBC09-1196

#### [802.11BG]

Modelo: BCM94312HMG	COFETEL: RCPBRBC08-0015
---------------------	-------------------------

#### [3G]

Modelo: UNDP-1	COFETEL:RTIQUUN08-0253
Modelo: Gobi2000	COFETEL:RTIQUGO09-0555
Modelo: EM770W	COFETEL:RTIHUEM10-0096

#### [WiMax]

Modelo: 622ANXHMW	COFETEL: RCPIN6210-0219
-------------------	-------------------------



# Portátil TravelMate

## Guia rápido

### Registo do produto

Ao utilizar o dispositivo pela primeira vez, recomenda-se que o registe. O registo dar-lhe-á acesso a vantagens úteis, como:

- Assistência mais rápida por representantes formados.
- Subscrição na comunidade Acer para receber promoções e participar em inquéritos ao cliente.
- As últimas novidades da Acer.

Registe-se já e usufrua tantas outras vantagens!

### Como registar

Para registar o seu produto Acer, visite **www.acer.com**. Seleccione o seu país, clique em **REGISTAR PRODUTO** e siga as instruções.

Também ser-lhe-á solicitado que registe o seu produto durante a instalação, ou poderá clicar duas vezes no ícone de registo no ambiente de trabalho.

Quando recebermos o seu registo, ser-lhe-á enviada uma mensagem de confirmação com dados importantes que deverá guardar.

### Obter acessórios Acer

Temos o prazer de o informar que poderá encontrar online o programa de extensão da garantia da Acer e acessórios para Notebook. Visite a nossa loja online e encontre o que precisa em **store.acer.com**.

A loja Acer é actualizada de forma progressiva, sendo que poderá não estar disponível em alguns países. Aceda ao site regularmente de modo verificar quando estará disponível no seu país.

© 2012 Todos os Direitos Reservados.

Guia rápido do Portátil TravelMate

Esta revisão: 07/2012

Número de modelo: \_\_\_\_\_

Número de série: \_\_\_\_\_

Data de aquisição: \_\_\_\_\_

Local de aquisição: \_\_\_\_\_

## Primeiro que tudo

Gostaríamos de lhe agradecer por ter escolhido um computador portátil Acer para preencher as suas necessidades de computador móvel.

## Os seus manuais

Para o ajudar a usar o seu computador portátil Acer, preparámos uma série de manuais:

Antes de mais, o **Cartaz de configuração** ajuda-o a iniciar e a configurar o seu computador.

O **Guia Rápido** apresenta as características e funções básicas do seu novo computador.

Para mais detalhes sobre como o seu computador o pode ajudar a ser mais produtivo, consulte o **Manual do Utilizador**. O **Manual do Utilizador** contém informações úteis aplicáveis ao seu novo computador. Abrange tópicos básicos como a utilização do teclado, áudio, etc.

Esse manual contém informações pormenorizadas sobre temas como utilitários do sistema, recuperação de dados, opções de expansão e solução de problemas. Além disso, contém a informação da garantia e as regulamentações gerais e notas de segurança para o seu computador portátil.

Siga estes passos para o aceder:

- 1 Digite "Utilizador" a partir de *Iniciar*.
- 2 Clique em **Manual do Utilizador Acer**.





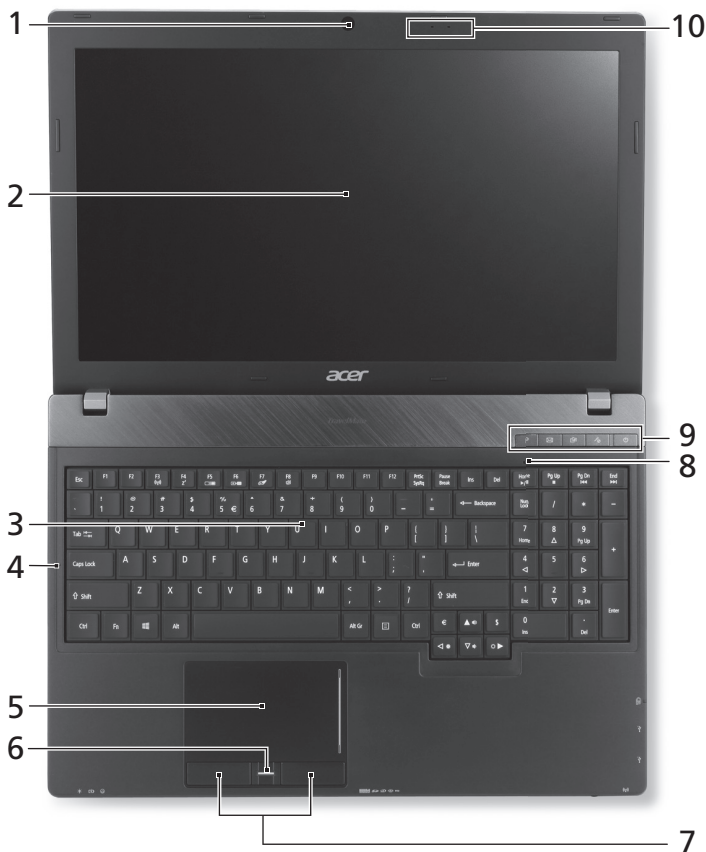

## Visita guiada ao seu computador portátil Acer

Após montar o computador tal como indicado na ilustração do cartaz de configuração, deixe-nos mostrar-lhe o seu novo computador portátil Acer.

### Vista de cima



#	Ícone	Item	Descrição
1		Webcam integrada	Câmara web para comunicações vídeo. <i>Uma luz junto da Webcam indica que a webcam está ativa.</i>

#	Ícone	Item	Descrição
2		Ecrã	Também chamado ecrã de cristais líquidos (LCD), permite visualizar a informação do computador (a configuração pode variar consoante o modelo).
3		Teclado	Para introduzir informações no seu computador.
4		Caps Lock	Acende-se quando a função Caps Lock é activada.
5		Teclado táctil	Dispositivo apontador sensível ao toque, que funciona como um rato de computador.
6		Leitor de impressões digitais	Leitor de impressões digitais para o Acer ProShield Security Suite.
7		Botões de clique (esquerdo e direito)	Os botões esquerdo e direito funcionam como os botões esquerdo e direito de um rato.
8		Num Lock	Acende-se quando a função Num Lock é activada.
		Tecla P	Tecla programável (a configuração pode variar consoante o modelo).
		Tecla de email Acer	Abre a sua aplicação de email predefinida.
9		Tecla de cópia de segurança	Abre o Acer Backup Management para cópias de segurança em três passos.
		Silenciar microfone	Silencia o microfone.
		Indicador/Botão de alimentação	Liga e desliga o computador. Indica o estado da alimentação do computador.
10		Microfones	Dois microfones internos para gravação de som em estéreo.

## Teclas de atalho

O computador utiliza teclas de atalho ou combinações de teclas para aceder à maior parte dos seus comandos, tais como a luminosidade do ecrã e o volume de saída.

Para activar as teclas de atalho, prima e mantenha premida a tecla **<Fn>** antes de premir a outra tecla na combinação de teclas de atalho.



Tecla de atalho	Ícone	Função	Descrição
<Fn> + <F3>		Comunicação	Activa/desactiva os dispositivos de comunicação do computador.
<Fn> + <F4>		Suspensão	Coloca o computador no modo de Suspensão.
<Fn> + <F5>		Comutação de visualização	Alterna a saída entre o ecrã de visualização, o monitor externo (se está ligado) e ambos.
<Fn> + <F6>		Ecrã em branco	Desliga a luz de fundo do ecrã de visualização para economizar energia. Prima qualquer tecla para retomar a actividade.
<Fn> + <F7>		Comutação de teclado táctil	Liga e desliga o teclado táctil interno.
<Fn> + <F8>		Comutação de altifalante	Liga e desliga os altifalantes.
<Fn> + <▷>		Aumentar luminosidade	Aumenta a luminosidade do ecrã.
<Fn> + <◁>		Reduzir luminosidade	Reduz a luminosidade do ecrã.
<Fn> + <△>		Aumentar volume	Aumenta o volume de som.
<Fn> + <▽>		Diminuir volume	Diminui o volume de som.
<Fn> + <Home>		Reproduzir/ Pausar	Reproduz ou pausa um ficheiro multimédia seleccionado.
<Fn> + <Pg Up>		Parar	Para a reprodução do ficheiro multimédia seleccionado.
<Fn> + <Pg Dn>		Anterior	Retorna ao ficheiro multimédia anterior.

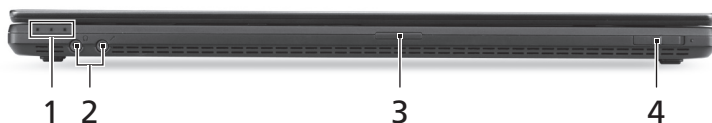

Tecla de atalho	Ícone	Função	Descrição
<Fn> + <End>		Seguinte	Avança até ao ficheiro multimédia seguinte.

## Vista frontal, fechado



#	Ícone	Item	Descrição
		Indicador de alimentação	Indica o estado da alimentação do computador.
1		Indicador da bateria	Indica o estado da bateria do computador. <b>1. A carregar:</b> A luz é âmbar quando a bateria está a carregar. <b>2. Carga completa:</b> A luz é azul no modo CA.
		Indicador HDD	Indica quando o disco rígido está activo.
2		Tomada para microfone	Aceita entradas de microfones externos.
		Tomada de auscultadores/altifalante	Liga a dispositivos áudio (por ex. colunas, auscultadores).
3		Leitor de cartões vários-em-um	Aceita cartões Secure Digital (SD), MultiMediaCard (MMC), Memory Stick PRO (MS PRO), xD-Picture Card (xD). <b>Nota:</b> Empurre para remover/instalar o cartão. Apenas pode ser utilizado um cartão.
4		Indicador/Interruptor de comunicação	Activa/desactiva os dispositivos de comunicação do computador/indica o estado de conectividade sem fios do dispositivo do computador.

## Vista esquerda



#	Ícone	Item	Descrição
1		Tomada de entrada CC	Liga a um adaptador CA.
2		Porto HDMI	Suporta ligações de vídeo digital de alta definição.
3		Ligação a ecrã externo (VGA)	Liga a um dispositivo de visualização (por exemplo, monitor externo, projector LCD).
4		Porta USB/eSATA	Liga a dispositivos USB ou eSATA (apenas em certos modelos). <b>Nota:</b> Se ligar um dispositivo eSATA, ficará com três portas USB disponíveis.
5		Ranhura de SmartCard	Aceita um SmartCard.
6		Ranhura para ExpressCard/34	Aceita um módulo de ExpressCard/34. <b>Nota:</b> Empurre para remover/inserir o cartão.

## Vista direita







#	Ícone	Item	Descrição
1		Porta USB	
2		Porta USB	Liga a dispositivos USB.
3		Porta USB com carregamento em modo desligado	<i>Se uma porta for preta é compatível com USB 2.0, se for azul é também compatível com USB 3.0.</i>
4		Unidade óptica	Unidade óptica interna; aceita CDs ou DVDs.
5		Indicador de acesso do disco óptico	Acende quando a unidade óptica está activa.
6		Botão de ejeção da unidade óptica	Ejecta o disco óptico da unidade.
7		Furo de ejeção de emergência	Ejecta o tabuleiro da unidade óptica quando o computador está desligado. <b>Nota:</b> Introduza um clipe no orifício de ejeção de emergência, para a unidade óptica ejectar o tabuleiro quando desligado o computador.
8		Porta Ethernet (RJ-45)	Liga a uma rede Ethernet de base 10/100/1000.
9		Ranhura para fecho Kensington	Liga a um cadeado de segurança Kensington (ou compatível). <b>Nota:</b> Enrole o cabo de bloqueio de segurança do computador em torno de um objecto imóvel, como por exemplo uma mesa ou o puxador de uma gaveta fechada. Introduza o cabo de segurança na ranhura e rode a chave para proteger o bloqueio. Também estão disponíveis modelos sem chave.

## Informações sobre USB 3.0

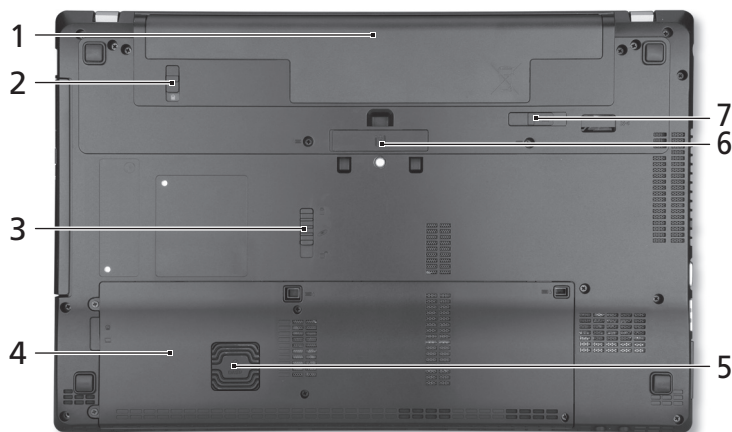
- Compatível com dispositivos USB 3.0 e anteriores.
- Para melhor desempenho, utilize dispositivos com certificação USB 3.0.
- Definido pela especificação USB 3.0 (USB SuperSpeed).

## Visão da base



#	Ícone	Item	Descrição
1		Baía da bateria	Contém a bateria do computador.
2		Bloqueio da bateria	Bloqueia a bateria, mantendo-a no sítio.
3		Patilha de libertação Acer MediaBay	Liberta o módulo Acer MediaBay.
4		Compartimento do disco rígido	Aloja o disco rígido do computador (seguro por parafusos).
		Compartimento da memória	Aloja a memória principal do computador.
5		Acer DASP (Protecção anti-choque do disco)	Protege a unidade do disco rígido de choques e pancadas.

#	Ícone	Item	Descrição
6		Conector Acer ProDock	Liga-se ao Acer ProDock opcional.
7		Patilha de libertação da bateria	Liberta a bateria para remoção.

## Ambiente

- Temperatura:
  - Funcionamento: 5°C a 35°C
  - Não em funcionamento: -20°C a 65°C
- Humidade (não condensação):
  - Funcionamento: 20% a 80%
  - Não em funcionamento: 20% a 80%



# TravelMate Notebook

## Snelgids

### Productregistratie

Als u het product voor het eerst gebruikt, wordt aanbevolen dat u het onmiddellijk registreert. U heeft dan namelijk toegang tot enkele handige voordelen, zoals:

- Snellere dienstverlening door onze opgeleide vertegenwoordigers.
- Lidmaatschap van de Acer-community: aanbiedingen ontvangen en meedoen aan enquêtes.
- Het laatste nieuws van Acer.

Aarzel niet en registreer, andere voordelen wachten op u!

### Zo registreert u

Registreer uw Acer-product op **www.acer.com**. Selecteer uw land, klik op **PRODUCTREGISTRATIE** en volg de eenvoudige instructies.

Eveneens zal u tijdens het installatieproces gevraagd worden uw product te registreren; ook kunt u dubbelklikken op het registratiepictogram op het bureaublad.

Zodra we uw productregistratie hebben ontvangen, sturen we u via e-mail een bevestiging met belangrijke gegevens. Bewaar deze gegevens op een veilige plek.

### Acer accessoires verkrijgen

Het verheugt ons u te kunnen informeren dat verlenging van de Acer garantie en Notebookaccessoires u online ter beschikking staan. Bezoek onze online-winkel en vind alles wat u nodig hebt op **store.acer.com**.

De Acer-winkels wordt stapsgewijs gelanceerd en is helaas in sommige regio's niet beschikbaar. Controleert u regelmatig opnieuw om te zien wanneer de site in uw land beschikbaar zal zijn.

© 2012 Alle rechten voorbehouden.

TravelMate Notebook Snelgids

Deze uitgave: 07/2012

Modelnummer: \_\_\_\_\_

Serienummer: \_\_\_\_\_

Aankoopdatum: \_\_\_\_\_

Plaats van aankoop: \_\_\_\_\_



## Om te beginnen

Bedankt dat u hebt gekozen voor een notebook van Acer als oplossing voor uw mobiele computereisen.

## Uw gidsen

Om u te helpen met het werken op het Acer notebook hebben we een aantal gidsen ontworpen:

Allereerst helpt de **Instelkaart** u bij het instellen van uw computer.

In de **Snelgids** krijgt u een introductie over de basiseigenschappen en functies van uw nieuwe computer.

Als u meer wilt weten over hoe uw computer u kan helpen productiever te werken, raadpleeg dan de **Gebruikershandleiding**. De **Gebruikershandleiding** bevat nuttige informatie over uw nieuwe computer. De handleiding behandelt basale onderwerpen, zoals het gebruik van het toetsenbord, geluid, enz.

Deze Gebruikershandleiding bevat gedetailleerde informatie over onderwerpen zoals systeemfuncties, gegevensherstel, uitbreidingsopties en problemen oplossen. Daarnaast bevat het informatie over garantie en de algemene voorwaarden en veiligheid voor uw notebook.

Volg deze stappen voor toegang tot dit document:





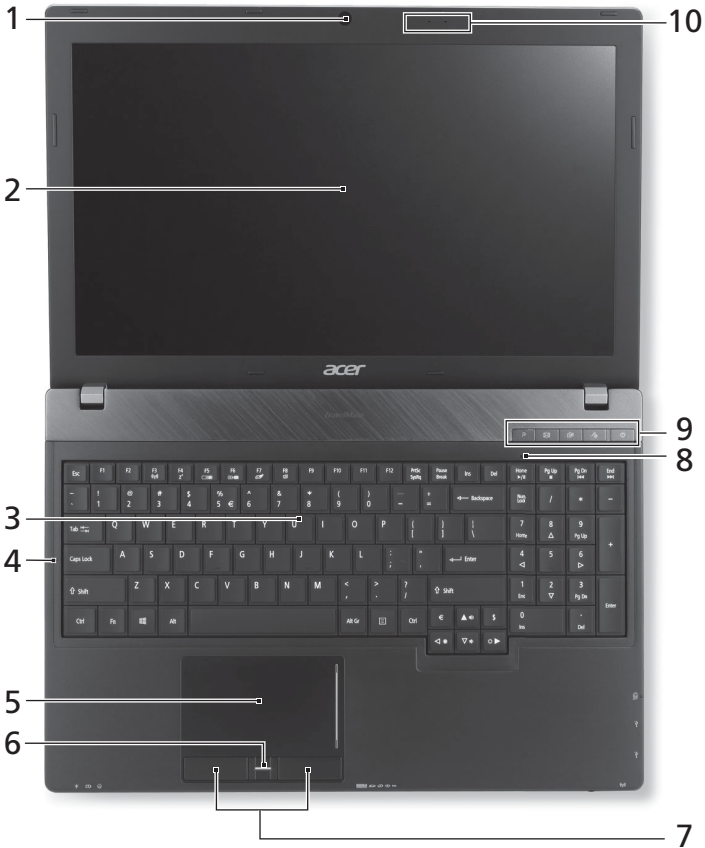

- 1 Voer in *Start* "Gebruiker" in.
- 2 Klik op **Acer Gebruikershandleiding**.

# Rondleiding door uw Acer notebook

Nadat u de computer hebt ingesteld zoals is beschreven op de poster, bent u nu klaar voor een rondleiding door de nieuwe Acer notebook.

## Bovenkant

















#	Pictogram	Item	Beschrijving
1		Geïntegreerde webcam	Webcam voor videocommunicatie. <i>Een lichtje naast de webcam geeft aan dat de webcam actief is.</i>
2		Scherm	Ook wel Liquid-Crystal Display (LCD) genoemd, geeft de output van de computer weer (configuratie kan per model verschillen).
3		Toetsenbord	Om gegevens in te voeren in de computer.
4		Caps Lock	Brandt als het Caps Lock is ingeschakeld.
5		Touchpad	Tastgevoelig aanwijsapparaat dat functioneert als een computermuis.
6		Vingerafdruklezer	Vingerafdruklezer voor Acer ProShield Security Suite.
7		Kliktoetsen (links en rechts)	De toetsen links en rechts functioneren als de linker en rechter muistoetsen.
8		Num Lock	Brandt als Num Lock is ingeschakeld.
		P-toets	Programmeerbare toets (configuratie kan per model verschillen).
		Acer e-mail-toets	Opent uw standaard e-mailtoepassing.
9		Back-up-toets	Start Acer Backup Management voor databack-up in drie stappen.
		Microfoon uitschakelen	Schakelt de microfoon uit.
		Aan/uit-knop/indicator	Schakelt de computer aan en uit. Geeft de energiestatus van de computer aan.
10		Microfoons	Twee interne microfoons voor stereogeluidsopname.

## Sneltoetsen

De computer gebruikt sneltoetsen of toetscombinaties voor toegang tot de meeste besturingselementen, zoals helderheid en geluidsvolume.





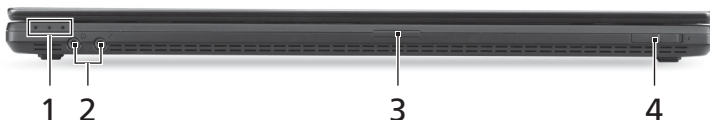

Om een sneltoets te gebruiken drukt u de **<Fn>** -toets in voordat u de andere toets van de combinatie indrukt.

Sneltoets	Pictogram	Functie	Beschrijving
<b>&lt;Fn&gt; + &lt;F3&gt;</b>		Communicatie	Schakelt de communicatieapparaten van de computer in/uit.
<b>&lt;Fn&gt; + &lt;F4&gt;</b>		Standby	Hiermee plaatst u de computer in de Standby-stand.
<b>&lt;Fn&gt; + &lt;F5&gt;</b>		Schakeltoets voor beeldscherm	Schakelt de weergave-uitvoer tussen het scherm, externe monitor (indien aangesloten) en beide.
<b>&lt;Fn&gt; + &lt;F6&gt;</b>		Leeg scherm	Hiermee schakelt u de lamp van het beeldscherm uit om stroom te besparen. Druk op een willekeurige toets om het beeldscherm weer te activeren.
<b>&lt;Fn&gt; + &lt;F7&gt;</b>		Schakeltoets voor touchpad	Hiermee schakelt u het interne touchpad in en uit.
<b>&lt;Fn&gt; + &lt;F8&gt;</b>		Schakeltoets voor luidspreker	Hiermee schakelt u de luidsprekers in en uit.
<b>&lt;Fn&gt; + &lt;D&gt;</b>		Helderheid verhogen	Verhoogt de helderheid van het beeldscherm.
<b>&lt;Fn&gt; + &lt;D&gt;</b>		Helderheid verlagen	Hiermee verlaagt u de helderheid van het beeldscherm.
<b>&lt;Fn&gt; + &lt;A&gt;</b>		Volume omhoog	Hiermee verhoogt u het luidsprekervolume.
<b>&lt;Fn&gt; + &lt;A&gt;</b>		Volume omlaag	Hiermee verlaagt u het luidsprekervolume.
<b>&lt;Fn&gt; + &lt;Home&gt;</b>		Afspelen/pauze	Een geselecteerd mediabestand afspelen of pauzeren.
<b>&lt;Fn&gt; + &lt;Pg Up&gt;</b>		Stoppen	Het afspelen stoppen van het geselecteerde mediabestand.

Sneltoets	Pictogram	Functie	Beschrijving
<Fn> + <Pg Dn>		Vorige	Terugkeren naar het vorige mediabestand.
<Fn> + <End>		Volgende	Naar het volgende mediabestand springen.





## Voorkant gesloten



#	Pictogram	Item	Beschrijving
		Energie-indicator	Geeft de energiestatus van de computer aan.
1		Accu-indicator	Geeft de batterijstatus van de computer aan. <b>1. Opladen:</b> Het licht is oranje wanneer de accu wordt opgeladen. <b>2. Volledig opgeladen:</b> Het licht is blauw in de AC-modus.
		HDD-indicator	Licht op wanneer de harde schijf actief is.
2		Microfoonaansluiting	Aansluitingen voor externe microfoon.
		Aansluiting voor hoofdtelefoon/luidspreker	Aansluiting voor audioapparaten (bijv. luidsprekers, hoofdtelefoon).
3		Meer-in-één-kaartlezer	Accepteert Secure Digital (SD), MultiMediaCard (MMC), Memory Stick PRO (MS PRO), xD-Picture Card (xD). <b>Opmerking:</b> Duwen om de kaart te verwijderen/plaatsen. Kaarten kunnen niet tegelijkertijd functioneren.
4		Communicatieschakelaar-/indicator	Schakelt communicatieapparatuur van de computer in/uit, geeft de status van het draadloze communicatieapparaat van de computer aan.

## Linkerkant



#	Pictogram	Item	Beschrijving
1		Gelijkstroomaansluiting	Aansluiting voor een adapter.
2		HDMI-poort	Ondersteunt high-definition digitale videesignalen.
3		Externe weergavepoort (VGA)	Aansluiting voor een beeldscherm (bijv. een externe monitor, LCD-projector).
4		USB/eSATA-poort	Aansluiting voor USB of eSATA-apparaten (alleen voor bepaalde modellen). <b>Opmerking:</b> Als u een eSATA-apparaat aansluit, zijn er drie usb-poorten beschikbaar.
5		SmartCard-sleuf	Accepteert een SmartCard.
6		ExpressCard/34 sleuf	Accepteert een ExpressCard/34-module. <b>Opmerking:</b> Duwen om de kaart te verwijderen/plaatsen.

## Rechterkant







#	Pictogram	Item	Beschrijving
1		USB-poort	
2		USB-poort	Aansluiting voor usb-apparaten.
3		Usb-poort met uitschakeling van opladen	<i>Is de poort zwart, dan is deze compatibel met usb 2.0; wanneer hij blauw is, dan is hij ook compatibel met usb 3.0.</i>
4		Optisch station	Intern optisch station; accepteert CDs of DVDs.
5		Toegangsindicator optische schijf	Brandt wanneer het optisch station actief is.
6		Uitwerpknop optisch station	Werpt de optische schijf uit het station.
7		Nood-uitwerpopening	Opent de lade van het optisch station wanneer de computer is uitgeschakeld. <b>Opmerking:</b> Steek een paperclip in de nooduitwerpopening om de lade van het optisch station uit te werpen als de computer is uitgeschakeld.
8		Ethernetpoort (RJ-45)	Aansluiting voor een op Ethernet 10/100/1000-gebaseerd netwerk.
9		Kensington-slot sleuf	Aansluiting voor een Kensington-compatibel computerbeveiligingsslot. <b>Opmerking:</b> Wikkel een kabel rond een vast, onwrikbaar object, zoals een tafel of een handgreep van een lade. Plaats het slot in de uitsparing en draai de sleutel om zodat het slot is vergrendeld. Er zijn ook modellen beschikbaar zonder Kensington-slot.

## Informatie over USB 3.0

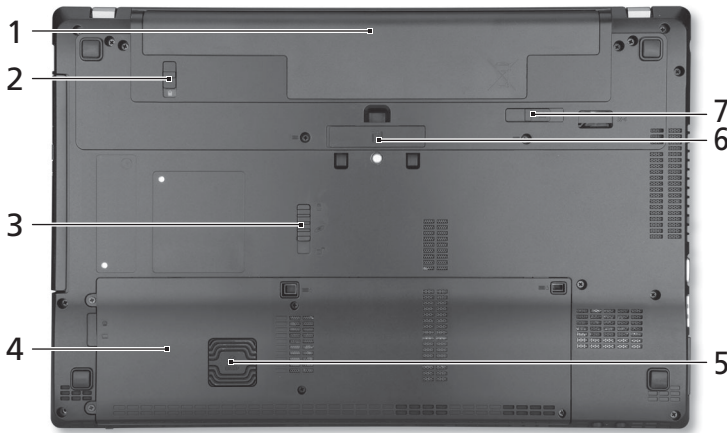
- Compatibel met USB 3.0 en eerdere usb-apparaten.
- Voor optimale prestaties gebruikt u USB 3.0-gecertificeerde apparaten.
- Op basis van de usb 3.0-specificatie (SuperSpeed usb).

## Onderkant



#	Pictogram	Item	Beschrijving
1		Batterijnis	Bevat de batterij van de computer.
2		Batterijgrendel	Vergrendelt de accu op z'n plaats.
3		Acer MediaBay ontgrendeling	Ontgrendelt de Acer MediaBay-module
4		Harde schijf nis	Bevat de harde schijf van de computer (vastgeschroefd).
		Geheugenvak	Bevat het hoofdgeheugen van de computer.
5		Acer DASP (Disk Anti-Shock Protection)	Beschermt de harde schijf tegen schokken en stoten.



#	Pictogram	Item	Beschrijving
6		Acer ProDock-aansluiting	Voor het aansluiten van de optionele Acer ProDock.
7		Batterijvergrendeling	Maakt de batterij los.

## Omgeving

- **Temperatuur:**
  - In gebruik: 5°C tot 35°C
  - Niet in gebruik: -20°C tot 65°C
- **Vochtigheidsgraad (geen condensvorming):**
  - In gebruik: 20% tot 80%
  - Niet in gebruik: 20% tot 80%



# TravelMate Notebook

## Hurtigguide

### Produktregistrering

Når du bruker produktet for første gang, bør du registrere det umiddelbart. Dette gir deg noen nyttige fordeler, for eksempel:

- Raskere service fra våre kvalifiserte representanter.
- Medlemskap i Acer-brukergruppen: kampanjetilbud og deltakelse i kundeundersøkelser.
- De siste nyhetene fra Acer.

Vær rask med å registrere deg – du har flere fordeler i vente!

### Hvordan registrere deg

Når du skal registrere Acer-produktet ditt, gå til **www.acer.com**. Velg land, klikk på **PRODUKTREGISTRERING** og følg de enkle instruksjonene.

Du vil også bli bedt om å registrere produktet under oppsettprosessen, eller du kan dobbeltklikke på Registrering-ikonet på skrivebordet.

Etter at vi har mottatt produktregistreringen, blir du tilsendt en bekreftelsesmelding med viktige data som du bør oppbevare på en trygg plass.

### Få tak i Acer-tilbehør

Vi er glade for å informere deg om at Acers garantiutvidelsesprogram og Notebook-tilbehør er tilgjengelig online. Kom og besøk vår onlinebutikk og finn det du ønsker på **store.acer.com**.

Acer-butikken er under kontinuerlig utvikling, men er dessverre ikke tilgjengelig i alle regioner. Besøk oss igjen regelmessig for å se når den blir tilgjengelig i landet ditt.

© 2012 Med enerett.

Hurtigguide for TravelMate Notebook  
Denne revisjonen: 07/2012

Modellnummer: \_\_\_\_\_

Serienummer: \_\_\_\_\_

Kjøpsdato: \_\_\_\_\_

Innkjøpssted: \_\_\_\_\_

## Begynne med begynnelsen

Vi vil gjerne takke deg for at du har valgt en Acer-notisbok til dine mobile databehandlingsbehov.

### Dine veiledere

Som hjelp til bruk av Acer-notisboken har vi utformet et sett av veiledere:

Til å begynne med vil **oppsettplakaten** hjelpe deg i gang med oppsettet av datamaskinen.

I **Hurtigguide** får du en innføring i de grunnleggende egenskapene og funksjonene til den nye datamaskinen.

Hvis du vil vite mer om hvordan datamaskinen kan gjøre deg mer produktiv, kan du slå opp i **brukerhåndboken**. **Brukerhåndboken** inneholder nyttig informasjon om din nye datamaskin. Den dekker grunnleggende emner som systemgjenoppretting, bruk av tastaturet, lyd, osv.

Denne guiden inneholder detaljert informasjon om emner som systemverktøy, datagjenvinning, utbyggingsalternativer og feilsøking/problemøsning. I tillegg finner du garantiopplysninger, generell informasjon og sikkerhetsmerknader for notisbokmaskinen din.

Følg disse trinnene for å åpne den:





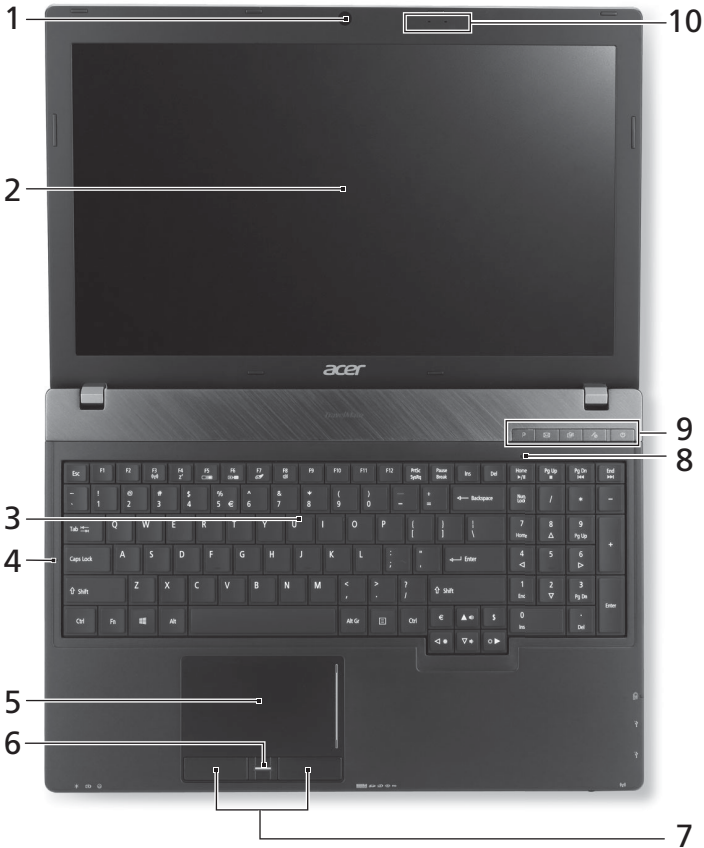

- 1 Skriv "Bruker" fra *Start*.
- 2 Klikk på **Acer-bruikerhåndboken**.

## En omvisning i Acer-notisboken

Når du har satt opp datamaskinen som vist på plakaten, la oss ta en omvisning i din nye Acer-notisbokmaskin.

### Visning ovenfra















#	Ikon	Element	Beskrivelse
1		Integrert webkamera	Webkamera til videokommunikasjon. <i>Et lys ved siden av webkameraet angir at det er aktivt.</i>
2		Skjerm	Kalles også LCD-skjerm (Liquid-Crystal Display; LCD), viser utdata fra datamaskinen (konfigurasjonen kan variere mellom modellene).
3		Tastatur	Legger inn data i datamaskinen.
4		Caps Lock	Lyser når Caps Lock er aktivert.
5		Pekeplate	Pekeenhet som reagerer på berøring og fungerer som en mus.
6		Fingeravtrykksleser	Fingeravtrykksleser for Acer ProShield Security Suite.
7		Klikkeknapper (venstre og høyre)	Venstre og høyre knapp fungerer på samme måte som venstre og høyre museknapp.
8		Num Lock	Lyser når Num Lock er aktivert.
		P-tast	Programmerbar tast (konfigurasjonen kan variere mellom modellene).
		Acer E-post-tast	Åpner din standard e-postapplikasjon.
9		Sikkerhetskopi-tast	Starter Acer Backup Management for tretrinns sikkerhetskopiering av data.
		Mikrofon av	Slår av lyden på mikrofonen
		Strømknapp/-indikator	Slår datamaskinen av og på. Angir datamaskinens strømstatus.
10		Mikrofoner	To interne mikrofoner for lydinnspilling i stereo.



## Hurtigtaster

Datamaskinen bruker hurtigtaster eller tastekombinasjoner for å få tilgang til datamaskinens kontroller, for eksempel skjermens lysstyrke og volumutgang.

Når du skal aktivere hurtigtaster, trykker du på og holder **<Fn>**-tasten før du trykker på den neste tasten i hurtigtastkombinasjonen.







Hurtigtast	Ikon	Funksjon	Beskrivelse
<b>&lt;Fn&gt; + &lt;F3&gt;</b>		Kommunikasjon	Aktiverer/deaktiverer datamaskinens kommunikasjonsenheter.
<b>&lt;Fn&gt; + &lt;F4&gt;</b>		Søvn	Setter datamaskinen i søvnmodus.
<b>&lt;Fn&gt; + &lt;F5&gt;</b>		Skjermbytte	Bytter mellom visning på vanlig skjerm, ekstern skjerm (hvis tilkoblet) eller begge deler.
<b>&lt;Fn&gt; + &lt;F6&gt;</b>		Blank skjerm	Slå av skjermens bakgrunnsbelysning for å spare strøm. Trykk på en hvilken som helst tast for å gå tilbake.
<b>&lt;Fn&gt; + &lt;F7&gt;</b>		Pekeplate av/på	Slår den interne pekeplaten av og på.
<b>&lt;Fn&gt; + &lt;F8&gt;</b>		Høytaler av/på	Slår høytalerne av og på.
<b>&lt;Fn&gt; + &lt;▷&gt;</b>		Lysstyrke opp	Øker skjermens lysstyrke.
<b>&lt;Fn&gt; + &lt;◁&gt;</b>		Lysstyrke ned	Reduserer skjermens lysstyrke.
<b>&lt;Fn&gt; + &lt;△&gt;</b>		Volum opp	Øker lydvolument.
<b>&lt;Fn&gt; + &lt;▽&gt;</b>		Volum ned	Reduserer lydvolument.
<b>&lt;Fn&gt; + &lt;Home&gt;</b>		Spill av/Pause	Spill av eller pause en valgt mediefil.
<b>&lt;Fn&gt; + &lt;Pg Up&gt;</b>		Stopp	Stopp avspilling av den valgte mediefilen.

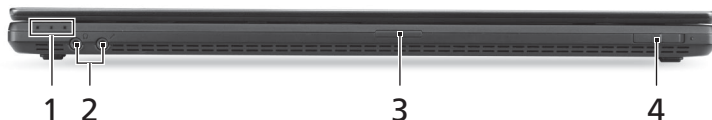

Hurtigtast	Ikone	Funksjon	Beskrivelse
<Fn> + <Pg Dn>		Forrige	Returner til forrige mediefil.
<Fn> + <End>		Neste	Hopp til neste mediefil.





## Lukket frontvisning



#	Ikone	Element	Beskrivelse
		Strømindikator	Angir datamaskinens strømstatus.
1		Batteriindikator	Angir datamaskinens batteristatus. <b>1. Lading:</b> Lampen lyser gult når batteriet lades. <b>2. Helt oppladet:</b> Lampen viser blått i nettstrømmodus.
		Harddiskindikator	Lyser når harddisken er aktiv.
2		Mikrofonport	Mottar inndata fra eksterne mikrofoner.
		Hodetelefoner/ høytaler-kontakt	Kobler til lydenheter (f.eks. høyttalere, hodetelefoner).
3		Multi-i-1-kortleser	Godtar Secure Digital (SD), MultiMediaCard (MMC), Memory Stick Pro (MS PRO) og xD-Picture Card (xD). <b>Merk:</b> Skyv inn for å fjerne/installere kortet. Bare ett kort kan operere til enhver tid.
4		Kommunikasjons- bryter/-indikator	Aktiverer/deaktiverer datamaskinens kommunikasjonsenheter/angir datamaskinens status for trådløs tilkobling.





## Venstre visning



#	Ikone	Element	Beskrivelse
1		Strømtilkobling	Kobler til en batterieliminatør.
2		HDMI-port	Støtter høydefinisjons digitale videoforbindelser.
3		Port for ekstern skjerm (VGA)	Kobler til en skjermenhet (f.eks. ekstern skjerm, LCD-prosjektor).
4		USB/eSATA-port	Kobler til USB eller eSATA-enheter (bare på visse modeller). <b>Merk:</b> Hvis du plugges inn en eSATA-enhet, vil du ha tre tilgjengelige USB-porter.
5		SmartCard-spor	Godtar et SmartCard.
6		ExpressCard/34-spor	Godtar en ExpressCard/34-modul. <b>Merk:</b> Skyv inn for å fjerne/sette inn kortet.

## Høyre visning







#	Ikon	Element	Beskrivelse
1		USB-port	Kobler til USB -enheter.
2		USB-port	<i>Hvis en port er svart, er den USB 2.0-kompatibel. Hvis den er blå, er den også USB 3.0-kompatibel.</i>
3		USB-port med avslått-lading	
4		Optisk stasjon	Intern optisk stasjon. Godtar CDer og DVDer.
5		Tilgangssindikator for optisk disk	Lyser når den optiske stasjonen er aktiv.
6		Utløserknapp for optisk stasjon	Løser ut den optiske disken fra stasjonen.
7		Nødutløserhull	Løser ut platen i den optiske stasjonen når datamaskinen er slått av. <b>Merk:</b> Sett en binders i nødutløserhullet hvis du må løse ut den optiske stasjonen når datamaskinen er av.
8		Ethernet-port (RJ-45)	Kobler til et Ethernet 10/100/1000-basert nettverk.
9		Spør for Kensington-lås	Kobler til en Kensington-kompatibel sikkerhetslås for datamaskinen. <b>Merk:</b> Koble en sikkerhetslås-kabel rundt et ubevegelig objekt som et bord eller håndtaket på en låst skuff. Sett inn låsen i sporet og vri om nøkkelen for å låse. Noen nøkkelløse modeller er også tilgjengelige.

## Informasjon om USB 3.0

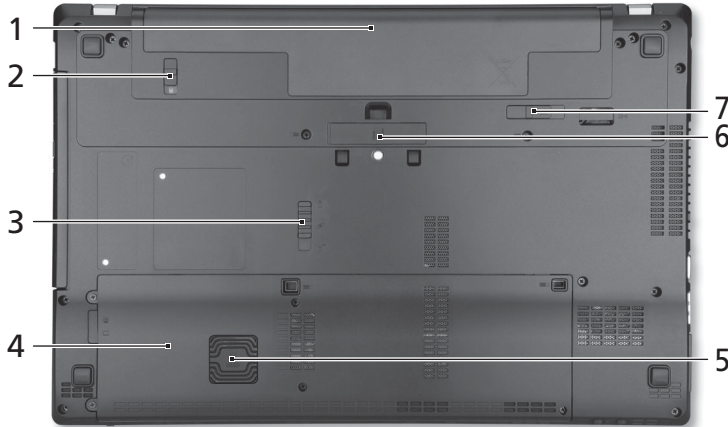
- Kompatibel med USB 3.0 og tidligere USB-enheter.
- Optimal ytelse oppnås med USB 3.0-sertifiserte enheter.
- Definert av USB 3.0- (SuperSpeed USB) spesifikasjonen.

## Bunnvisning



#	Ikon	Element	Beskrivelse
1		Batterirom	Huser datamaskinens batterier.
2		Batterilås	Låser batteriet på plass.
3		Utløser for Acer MediaBay	Frigjør Acer MediaBay-modulen.
4		Harddiskplass	Huser datamaskinens harddisk (sikret med skruer).
		Minnerom	Huser datamaskinens hovedminne.
5		Acer DASP (Disk Anti-Shock Protection)	Beskytter harddisken mot slag og støt.
6		Acer ProDock-kontakt	Kobler til den valgfrie Acer ProDock.
7		Batteriutløserbolt	Frigir batteriet for fjerning.

## Miljø

---

- Temperatur:
    - Drift: 5°C til 35°C
    - Ikke i bruk: -20°C til 65°C
  - Luftfuktighet (ikke-kondenserende):
    - Drift: 20% til 80%
    - Ikke i bruk: 20% til 80%
-



# TravelMate Notebook

## Hurtig-guide

### Produktregistrering

Det anbefales, når du bruger produktet for første gang, at du registrerede det med det samme. Derved får du adgang til nogle nyttige fordele, f.eks.:

- Hurtigere service fra vores uddannede repræsentanter.
- Medlemskab i Acer-fællesskabet: du får særtilbud og deltager i kundeundersøgelser.
- De seneste nyheder fra Acer.

Skynd dig og registrer. Der er flere fordele!

### Sådan registrerer du

Registrer dit Acer-produkt på **www.acer.com**. Vælg dit land, klik på **PRODUKTREGISTRERING**, og følg den enkle vejledning.

Du bliver også bedt om at registrere dit produkt under konfigurationsprocessen, eller du kan dobbeltklikke på registreringsikonet på skrivebordet.

Når vi har modtaget din produktregistrering, får du tilsendt en bekræftelses-e-mail med vigtige oplysninger, som du bør opbevare på et sikkert sted.

### Hente Acer-tilbehør

Vi er glade for at kunne fortælle dig, at Acers garantiudvidelsesprogramer og Notebook-tilbehør findes online. Besøg vores onlinebutik, og find det, du har brug for på **store.acer.com**.

Acer-butikken åbnes lidt efter lidt, og desværre er den ikke tilgængelig i nogle områder. Vend tilbage med regelmæssige mellemrum for at se, om den er tilgængelig i dit land.

© 2012 Alle Rettigheder Forbeholdes.

TravelMate Notebook - Hurtig guide  
Denne revision: 07/2012

Modelnummer: \_\_\_\_\_

Serienummer: \_\_\_\_\_

Købsdato: \_\_\_\_\_

Købt hos: \_\_\_\_\_



## For det første

Vi vil gerne takke for, at du har valgt en Acer bærbar til at opfylde dine mobile computerbehov.

## Dine vejledninger

Vi har udarbejdet et sæt vejledninger til at hjælpe dig med at anvende din Acer notebook.

Til at begynde med, kan **konfigurationsplakaten** hjælpe dig til at komme i gang med konfigurationen af computeren.

Den trykte **Hurtig-guide** beskriver de grundlæggende funktioner ved din nye computer.

Du kan finde flere oplysninger om, hvordan computeren kan hjælpe dig til at blive mere produktiv, i **Brugervejledning**. **Brugervejledning** indeholder nyttige oplysninger, der gælder for din nye computer. Den dækker grundlæggende emner som brugen af tastaturet og lyd osv.

Denne vejledning indeholder detaljerede oplysninger om emner som systemhjælpeprogrammer, datagenoprettelse, udvidelsesvalg og fejlfinding. Derudover indeholder den garantioplysninger og generelle regulativer og sikkerhedsmeddelelser til din bærbare.

Følg disse trin for at få adgang til den:

- 1 Indtast "Bruger" fra *Start*.
- 2 Klik på **Acer Brugervejledning**.





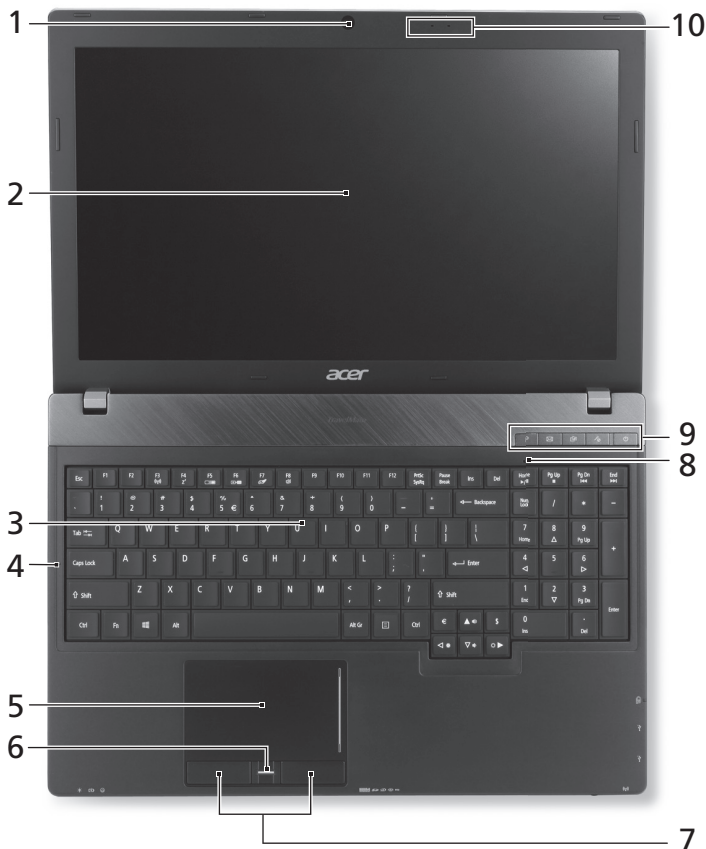

## En præsentation af din Acer notebook

Når du har sat computeren op som vist på illustrationerne på konfigurationsplakaten, bør du bruge et par minutter på at lære din nye Acer notebook at kende.

### Fra oven















#	Ikonelement	Beskrivelse
1	Integreret webcam	Webkamera til videokommunikation. <i>En lampe ved siden af webcammet angiver, at det er aktivt.</i>



#	Ikon	Element	Beskrivelse
2		Skærm	Den kaldes også for et LCD (Liquid-Crystal Display - flydende krystalskærm), og den viser computerens output (konfiguration kan variere fra model til model).
3		Tastatur	Til indtastning af data på computeren.
4		Caps Lock	Lyser, når Caps Lock er aktiveret.
5		Touchpad (pegefelt)	Et berøringfølsomt pegeuredskab, der fungerer ligesom en computermus.
6		Fingeraftrykslæser	Fingeraftrykslæser til Acer ProShield Security Suite.
7		Klik-knapper (til venstre og til højre)	Knapperne til højre og venstre fungerer på samme måde som musens højre og venstre knapper.
8		Num Lock	Lyser, når Num Lock er aktiveret.
		P-taste	Programmerbar taste (Konfiguration kan variere fra model til model).
		Acer e-mail-taste	Åbner dit standard e-mail-program.
9		Sikkerhedskopieringstaste	Starter Acer Backup Management for datasikkerhedskopiering med tre trin.
		Mikrofon slået fra	Slår mikrofonen fra.
		Afbryderknop/ Strømindikator	Tænder/slukker for computeren. Angiver computerens strømstatus.
10		Mikrofoner	To interne stereomikrofoner til optagelse af lyd.

## Hurtigtaster

Computeren bruger genvejstaster eller tastekombinationer til at få adgang til de fleste af computerens funktioner, f.eks. skærmens lysstyrke og lydstyrke.





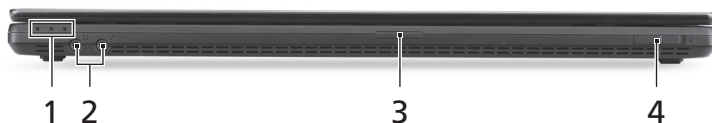

Hvis du vil aktivere genvejstaster, skal du holde **<Fn>**-tasten nede og derefter trykke på den anden taste i genvejstastekombinationen.

Hurtigtast	Ikon	Funktion	Beskrivelse
<b>&lt;Fn&gt; + &lt;F3&gt;</b>		Kommunikation	Aktiverer/deaktiverer computerens kommunikationsenheder.
<b>&lt;Fn&gt; + &lt;F4&gt;</b>		Dvale	Sætter computeren i dvaletilstand.
<b>&lt;Fn&gt; + &lt;F5&gt;</b>		Skærm til/fra	Skifter skærmoutputtet mellem skærmen, en ekstern skærm (hvis den er tilsluttet) og begge to.
<b>&lt;Fn&gt; + &lt;F6&gt;</b>		Tom skærm	Slukker for skærmens baggrundslys for at spare strøm. Tryk på en vilkårlig taste for at returnere.
<b>&lt;Fn&gt; + &lt;F7&gt;</b>		Touchpad til/fra	Tænder og slukker for det interne touchpad.
<b>&lt;Fn&gt; + &lt;F8&gt;</b>		Højtaler til/fra	Tænder og slukker for højttalerne.
<b>&lt;Fn&gt; + &lt;▷&gt;</b>		Lysstyrke op	Forøger skærmens lysstyrke.
<b>&lt;Fn&gt; + &lt;◁&gt;</b>		Lysstyrke ned	Sænker skærmens lysstyrke.
<b>&lt;Fn&gt; + &lt;△&gt;</b>		Lydstyrke op	Forøger højttalerens lydstyrke.
<b>&lt;Fn&gt; + &lt;▽&gt;</b>		Lydstyrke ned	Sænker højttalerens lydstyrke.
<b>&lt;Fn&gt; + &lt;Home&gt;</b>		Play/Pause	Afspil eller pause en udvalgt mediefil midlertidigt.
<b>&lt;Fn&gt; + &lt;Pg Up&gt;</b>		Stop	Standser afspilningen af den valgte mediefil.

Hurtigtast	Ikon	Funktion	Beskrivelse
<Fn> + <Pg Dn>		Forrige	Går tilbage til den forrige mediefil.
<Fn> + <End>		Næste	Springer til den næste mediefil.





## Forfra - Lukket



#	Ikon	Element	Beskrivelse
		Strømindikator	Angiver computerens strømstatus.
1		Batteriindikator	Angiver computerens batteristatus. <b>1. Oplader:</b> Lampen lyser gult, når batteriet oplader. <b>2. Fuldt opladet:</b> Lampen lyser blå i AC-tilstand.
		Harddiskindikator	Lyser, når harddisken er aktiv.
2		Mikrofonstik	Accepterer input fra eksterne mikrofoner.
		Hovedtelefoner/ højtalerstik	Tilslutter til lydenheder (f. eks. højttalere, hovedtelefoner).
3		Flere-i-en-kortlæser	Accepterer Secure Digital (SD), MultiMediaCard (MMC), Memory Stick PRO (MS PRO), xD-Picture Card (xD). <b>Bemærk:</b> Skub for at fjerne/installere kortet. Der kan kun være et aktivt kort ad gangen.
4		Kommunikationsafbry- der/indikator	Aktiverer/deaktiverer computerens kommunikationsenheder/angiver computerens trådløse forbindelsesenhedsstatus.





## Fra venstre



#	Ikon	Element	Beskrivelse
1		Jævnstrøm ind-stik	Tilslutter til en vekselstrømsadapter.
2		HDMI-port	Understøtter HD digitale netværksforbindelser.
3		Port til ekstern skærm (VGA)	Tilslutter til en skærmenhed (f.eks. ekstern skærm, LCD-projektor).
4		USB/eSATA-port	De er beregnet til tilslutning af to USB eller eSATA-enheder (kun på visse modeller). <b>Bemærk:</b> Hvis du tilslutter en eSATA-enhed, har du tre ledige USB-porte tilgængelige.
5		SmartCard-stik	Accepterer et SmartCard.
6		ExpressCard/34 stik	Accepterer et ExpressCard/34 modul. <b>Bemærk:</b> Skub for at fjerne/indsætte kortet.

## Fra højre







#	Ikon	Element	Beskrivelse
1		USB-port	Tilslutter til USB-enheder.
2		USB-port	<i>Hvis porten er sort, er den USB 2.0-kompatibel. Hvis den er blå er den også USB 3.0-kompatibel.</i>
3		USB-port med opladning, når strømmen er slukket	
4		Optisk drev	Internt optisk drev; accepterer CD'er og DVD'er.
5		Optisk disk - adgangsimpikator	Lyser, når det optiske drev er aktivt.
6		Skub ud-knap for det optiske drev	Skubber den optiske disk ud ad drevet.
7		Mekanisk udløserhul	Det åbner skuffen til det optiske drev, når computeren er slukket. <b>Bemærk:</b> <i>Indsæt en papirklips i hullet til nødudskubning for at skubbe den optiske drevbakke ud, når computeren er slukket.</i>
8		Ethernet (RJ-45)-port	Tilslutter til et Ethernet 10/100/1000-baseret netværk.
9		Åbning til en Kensington-lås	Tilslutter til en Kensington-kompatibel computers sikkerhedslås. <b>Bemærk:</b> <i>Sno kablet til computersikkerhedslåsen rundt om en fast genstand, f.eks. et bord eller et håndtag på en låst skuffe. Sæt låsen i indhakkert, og drej nøglen, så låsen sættes fast. Der findes også modeller uden nøgle.</i>

## Oplysninger om USB 3.0

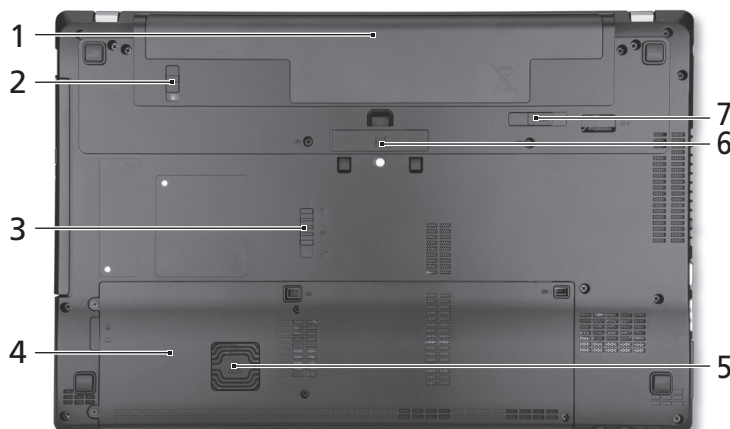
- Kompatibel med USB 3.0 og tidligere USB-enheder.
- For at få optimal ydelse skal du bruge USB 3.0-certificerede enheder.
- Definere af USB 3.0 (SuperSpeed USB)-specifikationen.

## Set fra bunden



#	Ikon	Element	Beskrivelse
1		Batterirum	Indeholder computerens batteri.
2		Batterilås	Låser batteriet på plads.
3		Acer MediaBay udløsermekanisme	Frigør Acer MediaBay-modulet.
4		Harddiskbås	Indeholder computerens harddisk (fastsat med skruer).
		Hukommelsesrum	Her sidder computerens centrale hukommelse.
5		Acer DASP (Disk Anti-Shock Protection)	Beskytter harddisken mod rystelser og stød.
6		Acer ProDock-stik	Tilslutter til den valgfrie Acer ProDock.
7		Frigørelsesrigel til batteri	Frigør batteriet til udtagning.



## Miljø

---

- Temperatur:
    - Under brug: 5°C til 35°C
    - Ikke i brug: -20°C til 65°C
  - Fugtighed (ikke-kondenserende):
    - Under brug: 20% til 80%
    - Ikke i brug: 20% til 80%
-



# TravelMate bärbar dator

## Snabbguide

### Registrera produkten

Vi rekommenderar att du registrerar produkten redan första gången du använder den. På så sätt får du bland annat tillgång till följande förmåner:

- Snabbare service från vår specialutbildade kundtjänstpersonal.
- Medlemskap i s Acer-gemenskapen: kampanjerbjudanden och möjlighet att delta i kundenkäter.
- Senaste nytt från Acer.

Registrera dig redan nu - flera andra förmåner väntar!

### Så här registrerar du dig

För att registrera din Acer-produkt, besök **www.acer.com**. Välj ditt land och klicka på **PRODUKTREGISTRERING** och följ de enkla instruktionerna.

Du kommer också att uppmanas att registrera produkten under installationen, eller så kan du dubbelklicka på Registreringsikonen på skrivbordet.

När vi har mottagit produktregistreringen skickar vi en bekräftelse till dig via e-post. E-postmeddelandet innehåller viktiga uppgifter som du bör förvara på ett säkert ställe.

### Skaffa Acertillbehör

Vi är glada att kunna meddela att Acers garantiförlängningsprogram och tillbehör för bärbara datorer finns tillgängliga online. Kom och besök vår webbshop och hitta det du behöver på **store.acer.com**.

Vår Acer-butik sprider sig successivt men kanske inte finns tillgänglig i vissa regioner. Kontrollera regelbundet för att se när den blir tillgänglig i ditt hemland.

© 2012 Med ensamrätt.

Snabbguide för TravelMate bärbar dator  
Denna revidering: 07/2012

Modellnummer: \_\_\_\_\_

Serienummer: \_\_\_\_\_

Inköpsdatum: \_\_\_\_\_

Inköpsställe: \_\_\_\_\_

## Först och främst

Vi vill tacka för att du valde en bärbar Acer-dator för att uppfylla dina behov av mobil databehandling.

## Dina guider

För att hjälpa dig använda din bärbara Acer-dator har vi skapat ett antal bruksanvisningar:

I **instruktionsfoldern** beskriver vi hur du kommer igång med installationen av datorn.

I **Snabbguide** får du en introduktion till grundläggande funktioner och detaljer i datorn.

Om du vill ha mer information om hur datorn kan göra dig mer produktiv, se **användarhandbok**. **Användarhandboken** innehåller användbar information om din nya dator. Den tar upp grundläggande teman som användning av tangentbord, ljud osv.

Den användarguiden innehåller detaljerad information om ämnen som systemverktyg, återhämtning av data, utökningsmöjligheter och felsökning. Dessutom innehåller den garantiinformation samt allmänna föreskrifter och säkerhetsmeddelanden angående den bärbara datorn.

Följ de här anvisningarna för att visa den:

- 1 Ange "Användare" i *Start*.
- 2 Klicka på **Acer användarhandbok**.





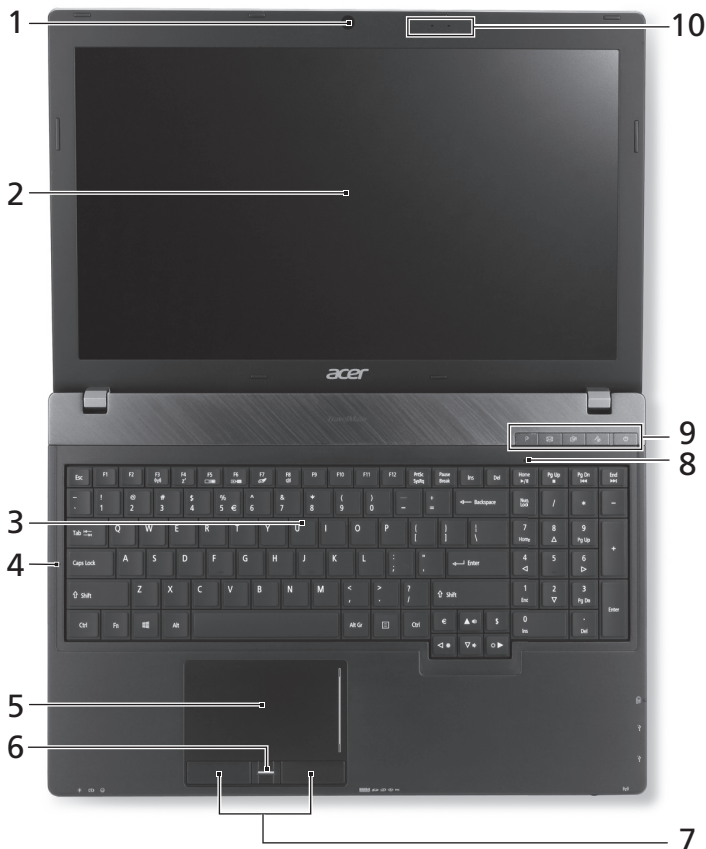

## Beskrivning av din bärbara Acer-dator

När du har installerat datorn enligt illustrationen i instruktionsfoldern vill vi beskriva din nya bärbara Acer-dator.

### Vy över ovensidan



#	Ikon	Objekt	Beskrivning
1		Integrerad webbkamera	Webbkamera för videokommunikation. <i>En lampa intill webbkameran indikerar att webbkameran är aktiv.</i>

#	Ikon	Objekt	Beskrivning
2		Skärm	Kallas även Liquid-Crystal Display (LCD), visar utdata från datorn (konfigurationen kan variera mellan olika modeller).
3		Tangentbord	För inmatning av data i datorn.
4		Caps Lock	Tänds när Caps Lock aktiveras.
5		Pekplatta	Beröringskänslig pekenhet som fungerar som en datormus.
6		Fingeravtrycks läsare	Fingeravtrycks läsare för Acer ProShield Security Suite.
7		Klickknappar (vänster och höger)	Vänster och höger knapp fungerar som vänster och höger musknapp.
8		Num Lock	Tänds när Num Lock aktiveras.
		P-knapp	Programmerbar knapp (konfigurationen kan variera mellan olika modeller).
		Knapp för Acer e-post	Öppnar ditt standardprogram för e-post.
9		Säkerhetskopieringsknapp	Startar Acer Backup Management för säkerhetskopiering av data i tre steg.
		Stänger av mikrofonen	Stänger av mikrofonen.
		Av-/på-knapp/indikator	Slår på och stänger av datorn. Anger om datorn är av eller på.
10		Mikrofoner	Två inbyggda mikrofoner för stereoljudinspelning.



## Snabbtangenter

Datorn använder snabbknappar eller knappkombinationer för att komma åt de flesta av datorns kontroller, t.ex. skärmens ljusstyrka och volym.

Du aktiverar snabbknappar genom att hålla ned **<Fn>** innan du trycker på den andra knappen i snabbknappskombinationen.







Snabbtangenter	Ikoner	Funktion	Beskrivning
<b>&lt;Fn&gt; + &lt;F3&gt;</b>		Kommunikation	Aktiverar/avaktiverar datorns kommunikationsenheter.
<b>&lt;Fn&gt; + &lt;F4&gt;</b>		Viloläge	Placerar datorn i viloläge.
<b>&lt;Fn&gt; + &lt;F5&gt;</b>		Växla bildskärm	Växlar visning mellan datorns bildskärm och en extern monitor (om ansluten) och båda.
<b>&lt;Fn&gt; + &lt;F6&gt;</b>		Skärmsläckare	Stänger av bildskärmens bakgrundsbelysning för att spara ström. Återgå genom att trycka på en valfri tangent.
<b>&lt;Fn&gt; + &lt;F7&gt;</b>		Aktivera/ avaktivera pekplatta	Aktiverar/avaktiverar den interna pekplattan.
<b>&lt;Fn&gt; + &lt;F8&gt;</b>		Aktivera/ inaktivera högtalare	Sätter på/stänger av högtalarna.
<b>&lt;Fn&gt; + &lt;◀&gt;</b>		Öka ljusstyrkan	Ökar bildskärmens ljusstyrka.
<b>&lt;Fn&gt; + &lt;▶&gt;</b>		Minska ljusstyrka	Minskar bildskärmens ljusstyrka.
<b>&lt;Fn&gt; + &lt;▲&gt;</b>		Höj volymen	Höjer högtalarvolymen.
<b>&lt;Fn&gt; + &lt;▼&gt;</b>		Sänk volymen	Sänker högtalarvolymen.
<b>&lt;Fn&gt; + &lt;Home&gt;</b>		Spela upp/pausa	Spelar upp eller pausar en vald mediefil.
<b>&lt;Fn&gt; + &lt;Pg Up&gt;</b>		Stopp	Stoppar uppspelning av vald mediefil.

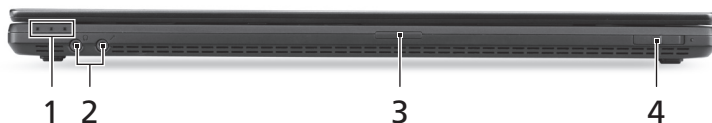

Snabbtangent	Ikön	Funktion	Beskrivning
<Fn> + <Pg Dn>		Föregående	Atergår till föregående mediefil.
<Fn> + <End>		Nästa	Hoppar till nästa mediefil.





## Vy över stängd framsida



#	Ikön	Objekt	Beskrivning
		På-indikator	Anger om datorn är av eller på.
1		Batteriindikator	Anger status för datorns batteri. <b>1. Laddad:</b> Lyser orange när batteriet laddas. <b>2. Fulladdad:</b> Lyser blått då datorn är ansluten till nätström.
		Hårddiskindikator	Tänds när hårddisken arbetar.
2		Mikrofoningång	Anslutning för externa mikrofoner.
		Utgång för hörlurar/ högtalare	Ansluts till ljudenheter (t.ex. högtalare, hörlurar).
3		Flera-i-1-kortläsare	Avsedd för Secure Digital (SD), MultiMediaCard (MMC), Memory Stick PRO (MS PRO), xD-Picture Card (xD). <b>Obs:</b> Tryck för att ta bort/sätta i kortet. Endast ett enda kort kan vara aktivt åt gången.
4		Kommunikationsbrytare/ strömindikator	Aktiverar/avaktiverar datorns kommunikationsenheter/anger datorns trådlösa status.

## Vy från vänster



#	Ikön	Objekt	Beskrivning
1		DC in-anlutning	Ansluts till en växelströmsadapter.
2		HDMI-port	Har stöd för digitala videoanslutningar av högdefinitionstyp.
3		Port för extern bildskärm (VGA)	Anslutning till en visningsenhet (t.ex. extern bildskärm, LCD-projektor).
4		USB/eSATA-port	Anslutning för USB- eller eSATA-enheter (bara för vissa modeller). <b>Obs:</b> Om du ansluter en eSATA-enhet har du tre tillgängliga USB-portar.
5		SmartCard-plats	För SmartCard.
6		ExpressCard/34-plats	För en ExpressCard/34-modul. <b>Obs:</b> Tryck för att ta bort/sätta i kortet.

## Vy från höger







#	Ikon	Objekt	Beskrivning
1		USB-port	Ansluter till USB-enheter.
2		USB-port	<i>Om en port är svart är den USB 2.0-kompatibel. Om den är blå är den dessutom USB 3.0-kompatibel.</i>
3		USB-port med power-off laddning	
4		Optisk läsenhet	Inbyggd optisk läsenhet för CD- eller DVD-skivor.
5		Åtkomstindikator för optisk läsenhet	Tänds när den optiska läsenheten arbetar.
6		Utmatningsknapp för optisk läsenhet	Matar ut skivan från den optiska läsenheten.
7		Hål för mekanisk utmatning	Matar ut skivluckan från den optiska läsenheten när datorn är avstängd. <b>Obs:</b> För in spetsen på ett gem i det mekaniska utmatningshålet för att mata ut det optiska enhetsfacket när datorn är avslagen.
8		Ethernet-port (RJ-45)	Ansluts till ett Ethernet 10/100/1000-baserat nätverk.
9		Skåra för Kensingtonlås	Ansluts till ett Kensington-kompatibelt datorskyddslås. <b>Obs:</b> Lägg datorns låsvajer runt ett fast föremål, t.ex. ett bord eller handtaget till en låst skrivbordslåda. Sätt in låset i uttaget och lås det sedan genom att vrida om nyckeln. Vissa modeller är dock nyckellösa.

## Information om USB 3.0

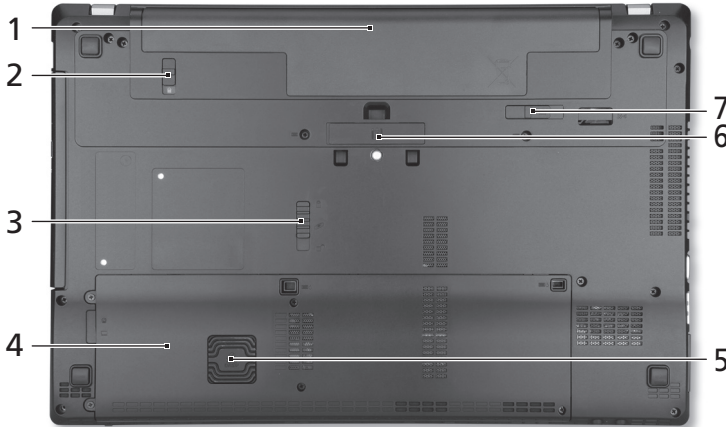
- Kompatibel med USB 3.0 och tidigare USB-enheter.
- För optimal prestanda, använd USB 3.0-certifierade enheter.
- Definieras i specifikationen USB 3.0 (SuperSpeed USB).

## Vy underifrån



#	Ikön	Objekt	Beskrivning
1		Batterifack	Avsett för datorns batteripack.
2		Batterilås	Låser batteriet på plats.
3		Frigöringshake för Acer MediaBay	Frigör Acer MediaBay-modulen.
4		Härdiskfack	Utrymme för datorns hårddisk (fastskruvad).
		Minnesfack	Här finns datorns huvudminne.
5		Acer DASP (Disk Anti-Shock Protection)	Skyddar hårddiskenheten mot stötar och törnar.
6		Acer ProDock-anslutning	Ansluter till den valfria Acer ProDock.

#	Ikön	Objekt	Beskrivning
7		Hake för frigöring av batteriet	Frigör batteriet före borttagning.

---

## Miljö

---

- Temperatur:
    - Vid drift: 5°C till 35°C
    - Utom drift: -20°C till 65°C
  - Luftfuktighet (icke-kondenserande):
    - Vid drift: 20% till 80%
    - Utom drift: 20% till 80%
-



# TravelMate kannettava tietokone

## Pikaohje

### Tuotteen rekisteröinti

Kun käytät tuotetta ensimmäisen kerran, on suositeltavaa, että rekisteröit sen välittömästi. Tämä antaa sinulle pääsyn joihinkin hyödyllisiin etuihin, kuten:

- Nopeampi palvelu koulutetuilta edustajiltamme.
- Jäsenyys Acer-yhteisössä: vastaanottaa myyinnedistämistä ja osallistua asiakastutkimuksiin.
- Uusimmat uutiset Acerilta.

Kiirehdi ja rekisteröi, koska muut edut odottavat sinua!

### Kuinka rekisteröityä

Lisätietoja Acer-tuotteen rekisteröimisestä saat osoitteesta **www.acer.com**. Valitse maasi, napsauta **TUOTTEEN REKISTERÖINTI** ja noudata annettuja ohjeita.

Sinua pyydetään rekisteröimään tuote myös asetusten teon yhteydessä tai voit napsauttaa työpöydällä olevaa Rekisteröintikuvaketta.

Sen jälkeen kun olemme vastaanottaneet tuotteesi rekisteröinnin, sinulle lähetetään vahvistussähköposti tärkeän tiedon kanssa, jonka sinun täytyy säilyttää turvallisessa paikassa.

### Alkuperäisten Acer-lisävarusteiden hankinta

Acerin laajennettu takuuohjelma ja Notebook-lisävarusteet ovat saatavana online-kaupastamme. Tule vierailemaan online-kauppaamme osoitteessa **store.acer.com**.

Acer-kauppa on uusi ja esittelyvaiheessa, valitettavasti se ei ole käytössä kaikilla alueilla. Tarkista säännöllisesti milloin se on käytettävissä omassa maassasi.

© 2012 Kaikki oikeudet pidätetään.

TravelMate kannettavan tietokoneen pikaopas

Tämä versio: 07/2012

Mallinumero: \_\_\_\_\_

Sarjanumero: \_\_\_\_\_

Ostopäivämäärä: \_\_\_\_\_

Ostopaikka: \_\_\_\_\_



# Tärkeimmät asiat ensin

Haluamme kiittää sinua Acerin kannettavan tietokoneen valitsemisesta liikkuvien tietokonetarpeitasi täyttämässä.

## Ohjeet

Helpottaaksesi sinua Acer-tietokoneen käyttämisessä olemme suunnitelleet sarjan ohjekirjoja:

Aluksi **Asetusjulist**e auttaa sinua tietokoneen käyttöönotossa.

Tämä **Pikaohje** esittelee uuden tietokoneesi perusominaisuudet ja -toiminnot.

Lisätietoja tietokoneesi mahdollisuuksista tuottavuutesi lisäämisessä saat **Käyttöohjekirjasta**. **Käyttöohjekirja** sisältää hyödyllisiä uutta tietokonettasi koskevia tietoja. Se kattaa perusaiheet, kuten näppäimistön, äänen, jne. käyttämisen.

Tässä oppaassa on yksityiskohtaisia tietoja sellaisista aiheista kuin järjestelmän apuohjelmat, tietojen palauttaminen, lisäasetukset ja vianetsintä. Siinä on myös annettu yleisiä ohjeita, tietoja takuusta sekä turvallisuusohjeita.

Seuraa näitä ohjeita:

- 1 Kirjoita *Käynnistä*-kohtaan "Käyttäjä".
- 2 Napsauta **Acer-käyttöohje**.



# Tutustuminen kannettavaan Acer - tietokoneeseen

Kun olet asentanut tietokoneesi kuten asennus julisteessa on kuvattu, anna meidän esitellä uusi kannettava Acer-tietokoneesi.

## Näkymä ylhäältä













#	Kuvake	Osio	Kuvaus
1		Integroitu web-kamera	Web-kamera video-tietoliikenteeseen. <i>Web-kameran vieressä oleva merkkivalo osoittaa web-kameran olevan toiminnassa.</i>

#	Kuvake	Osio	Kuvaus
2		Ruutu	Nimeltään myös nestekidenäyttö (Liquid-Crystal Display; LCD), näyttää tietokoneen ulostulon (konfiguraatio voi vaihdella malleista riippuen).
3		Näppäimistö	Tiedon syöttämiseen tietokoneelle.
4		Caps Lock	Syttyy, kun Caps Lock on aktivoituneena.
5		Kosketusalusta	Kosketusherkkä osoitinlaite, joka toimii kuten tietokoneen hiiri.
6		Sormenjälkilukija	Acer ProShield Security Suiten sormenjälkilukija.
7		Napsautuspainikkeet (vasen ja oikea)	Vasen ja oikea painike toimivat kuten hiiren vasen ja oikea painike.
8		Num Lock	Syttyy, kun Num Lock on aktivoituneena.
		P-näppäin	Ohjelmoitava näppäin (konfiguraatio voi vaihdella malleista riippuen).
		Acer-sähköpostinäppäin	Avaa oletussähköpostisovelluksesi.
9		Varmistusnäppäin	Avaa Acer Backup Managementin, jossa voit varmuuskopioida tietoja kolmessa vaiheessa.
		Mikrofonin mykistys	Mykistää mikrofonin.
		Virtapainike/-ilmaisin	Käynnistää ja sulkee koneen. Osoittaa tietokoneen virran tilan.
10		Mikrofonit	Kaksi sisäistä mikrofonia stereoäänen tallentamista varten.

## Pikavalintanäppäimet

Tietokoneessa on pikavalintanäppäimet tai näppäinyhdistelmät sen useimpia säätöjä, kuten näyttöruudun kirkkautta, äänenvoimakkuutta varten.





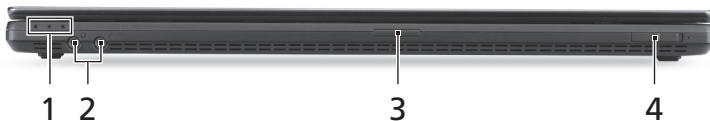

Aktivoidaksesi pikavalintanäppäimet paina ja pidä painettuna **<Fn>** -näppäintä ja paina sitten pikavalintanäppäinyhdistelmän toista näppäintä.

Pikanäppäin	Kuvake	Toiminto	Kuvaus
<Fn> + <F3>		Tietoliikenne	Ottaa käyttöön/poistaa käytöstä tietokoneen tietoliikennelaitteet.
<Fn> + <F4>		Lepotila	Siirtää tietokoneen lepotilaan.
<Fn> + <F5>		Näytön vaihto	Kytkee näytön ulostulon näyttöruudun, ulkoisen monitorin (jos kytketty) ja molempien välillä.
<Fn> + <F6>		Näyttöruudun tyhjennys	Sammuttaa näytön taustavalon virran säästämiseksi. Paina mitä tahansa näppäintä palataksesi normaalitilaan.
<Fn> + <F7>		Kosketusalustan vaihtokytkin	Kytkee sisäisen kosketusalustan käyttöön ja pois käytöstä.
<Fn> + <F8>		Kaiuttimien vaihtokytkin	Kytkee kaiuttimet käyttöön ja pois käytöstä.
<Fn> + <▷>		Kirkkauden lisäys	Lisää näytön kirkkautta.
<Fn> + <◁>		Kirkkauden vähennys	Vähentää näytön kirkkautta.
<Fn> + <△>		Äänenvoimakkuus ylös	Lisää äänenvoimakkuutta.
<Fn> + <▽>		Äänenvoimakkuus alas	Vähentää äänenvoimakkuutta.
<Fn> + <Home>		Toista/Tauko	Toista tai pysäytä valittu mediatiedosto.
<Fn> + <Pg Up>		Pysäytä	Pysäytä valitun mediatiedoston toistaminen.
<Fn> + <Pg Dn>		Edellinen	Palaa edelliseen mediatiedostoon.

Pikanäppäin	Kuvake	Toiminto	Kuvaus
<Fn> + <End>		Seuraava	Hyppää seuraavaan mediatiedostoon.





## Etunäkymä suljettuna



#	Kuvake	Osio	Kuvaus
		Virranilmaisin	Osoittaa tietokoneen virran tilan.
1		Akkutilan ilmais-in	Osoittaa tietokoneen akun tilan. <b>1. Lataus meneillään:</b> Valo palaa oranssina, kun akku latautuu. <b>2. Täyteen ladattu:</b> Valo palaa sinisenä, kun tietokone toimii verkkovirralla.
		HDD-ilmais-in	Palaa, kun kiintolevy on aktiivinen.
2		Mikrofoni-jakki	Hyväksyy syötteet ulkoisilta mikrofoneilta.
		Kuulokkeet/kaiutin jakki	Yhdistää audiolaitteisiin (esim. kaiuttimet, kuulokkeet).
3		Monta yhdessä - kortinlukija	Hyväksyy seuraavat muistikortit: Secure Digital (SD), MultiMediaCard (MMC), Memory Stick PRO (MS PRO) ja xD-Picture Card (xD). <b>Huomaa:</b> Poistaa/asenna kortti työntämällä. Vain yksi kortti toimii kerrallaan.
4		Tietoliikennekytkin/-ilmais-in	Ottaa käyttöön/poistaa käytöstä tietokoneen tietoliikennelaitteet/ilmaisee tietokoneen langattomien tietoliikennelaitteiden tilan.

## Vasen näkymä



#	Kuvake	Osio	Kuvaus
1		DC-tulojalkki	Liittää AC-sovitteeseen.
2		HDMI-portti	Tukee korkealaatuisia digitaalisia videoliitäntöjä.
3		Ulkoinen näyttöportti (VGA)	Liittää näyttölaitteeseen (esim. ulkoinen näyttö, LCD-projektori).
4		USB/eSATA -portti	Liitäntä USB- tai eSATA-laitteisiin (vain valituille malleille). <b>Huomautus:</b> Jos liität eSATA-laitteen, sinulla on käytössäsi kolme USB-porttia.
5		SmartCard-aukko	Hyväksyy SmartCard'in.
6		ExpressCard/ 34 -paikka	Hyväksyy ExpressCard/34 -moduulin. <b>Huomautus:</b> Poista/asenna kortti työntämällä.

## Oikea näkymä







#	Kuvake	Osoie	Kuvaus
1		USB-portti	
2		USB-portti	Yhdistää USB -laitteisiin. <i>Musta portti on USB 2.0 -yhteensopiva ja sininen portti on USB 3.0 -yhteensopiva.</i>
3		USB-portti, jossa lataustoiminto virran ollessa sammutettuna	
4		Optinen asema	Sisäinen optinen levyasema, hyväksyy CD:t ja DVD:t.
5		Optisen levyn tilan osoitin	Syttyy, kun optinen asema on aktiivinen.
6		Optisen aseman ulostyöntöpainike	Työntää optisen levykkeen ulos asemasta.
7		Hätäulostyöntöaukko	Työntää ulos optisen aseman kelkan, kun tietokone on sammutettu. <b>Huomaa:</b> Pane paperiliitin hätäpoistoreikään optisen aseman levyn poistamiseksi asemasta, kun tietokone on pois päältä.
8		Ethernet (RJ-45) -portti	Liittää Ethernet 10/100/1000 -pohjaiseen verkkoon.
9		Kensington-lukon paikka	Liittää Kensington-yhteensopivaan tietokoneen turvalukkuun. <b>Huomaa:</b> Kierrä tietokoneen turvalukon kaapeli kiinteään esineen, kuten pöydän tai lukitun laatikon kahvan ympärille. Paina lukko paikalleen ja lukitse se kiertämällä avainta. Saatavana on myös joitakin avaimettomia lukkoja.

## Tietoja USB 3.0

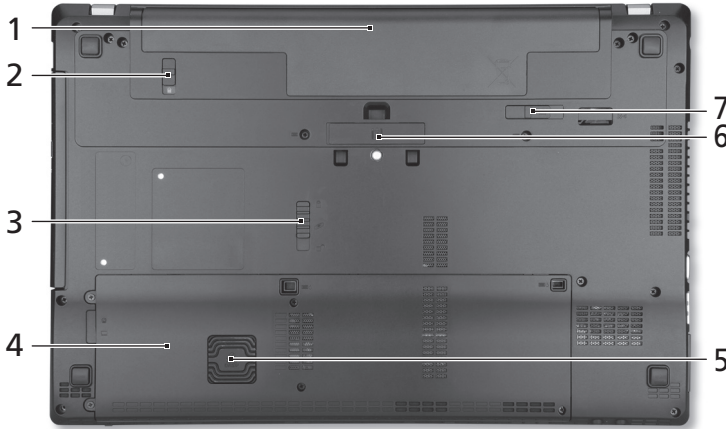
- Yhteensopiva USB 3.0:n ja vanhempien USB-laitteiden kanssa.
- Käytä USB 3.0-laitteita parhaan suorituskyvyn takaamiseksi.
- Määritely USB 3.0 (SuperSpeed USB) -määritelmässä.

## Pohjanäkymä



#	Kuvake	Osio	Kuvaus
1		Akkutila	Sisältää tietokoneen akkuyksikön.
2		Akun lukko	Lukitsee akun paikoilleen.
3		Acer MediaBay vapautussalpa	Vapauttaa Acer MediaBay -moduulin sen poistamista varten.
4		Kovalevytila	Sisältää koneen kovalevyn (varmistettu ruuveilla).
		Muistilokero	Sisältää tietokoneen päämuisti.
5		Acer DASP (Levyn iskunestosuojaus)	Suojaa kovalevyä iskuilta ja tärähdyksiltä.
6		Acer ProDock -liitin	Liitäntä valinnaiselle Acer ProDockille.
7		Akun vapautussalpa	Vapauttaa akun poistamista varten.



## Ympäristö

---

- Lämpötila:
    - Käyttö: 5°C:sta 35°C:een
    - Ei käytössä: -20°C:sta 65°C:een
  - Kosteus (ei kondensoitunut):
    - Käyttö: 20%:sta 80%:een
    - Ei käytössä: 20%:sta 80%:een
-



# Ноутбук TravelMate

## Краткое руководство

### Регистрация устройства

При первом использовании устройства советуем сразу его зарегистрировать. Это даст вам определенные преимущества, включая:

- Ускоренное обслуживание нашими специалистами.
- Членство в сообществе Асер: получение уведомлений о рекламных акциях и участие в опросах пользователей.
- Получение новостных рассылок от компании Асер.

Спешите зарегистрироваться, так как вас ждет много других льготных предложений!

### Порядок регистрации

Для регистрации своего устройства Асер зайдите на веб-сайт **www.acer.com**. Выберите свою страну, нажмите **РЕГИСТРАЦИЯ УСТРОЙСТВА** и выполните простые указания.

Вам будет предложено зарегистрировать свой продукт в процессе установки, кроме того, можно будет дважды щелкнуть значок Регистрация на рабочем столе.

После того, как мы регистрируем ваше устройство, вы получите подтверждение по эл. почте с важной информацией, которую нужно будет сохранить для использования в будущем.

### Получение аксессуаров Асер

Мы рады сообщить вам, что программа расширения гарантии Асер и аксессуары для ноутбуков доступны в режиме онлайн. Посетите наш онлайн-магазин и найдите нужные элементы на сайте **store.acer.com**.

Магазин Асер стремительно расширяется, но, к сожалению, его услуги могут быть недоступны в некоторых странах. Регулярно проверяйте, когда его услуги будут доступны в вашей стране.

© 2012 Все права защищены.

Краткое руководство пользователя ноутбука TravelMate  
Эта редакция: 07/2012

Номер модели: \_\_\_\_\_

Серийный номер: \_\_\_\_\_

Дата покупки: \_\_\_\_\_

Место покупки: \_\_\_\_\_

## Вначале о главном

Благодарим вас за то, что для решения своих мобильных вычислительных задач вы выбрали ноутбук Acer.

## Ваши руководства

Мы разработали ряд руководств, которые помогут вам в использовании ноутбука Acer:

Этот **Плакат по настройке** поможет выполнить первоначальную настройку компьютера.

**Краткое руководство** знакомит вас с основными характеристиками и функциями вашего нового компьютера.

Чтобы узнать больше о том, как с помощью компьютера повысить продуктивность своей работы, см. **Руководство пользователя**.

**Руководство пользователя** содержит полезную информацию о вашем новом компьютере. В нем описываются основные темы, такие как работа с клавиатурой, звуком и т.д.

Это руководство содержит подробные сведения о системных функциях, восстановлении данных, возможностях расширения и устранении неисправностей. Кроме того, оно содержит гарантийную информацию, а также общие предписания и правила безопасности при работе с вашим ноутбуком.

Чтобы открыть его, выполните следующее:

- 1 На экране *Пуск* введите "Пользователь".
- 2 Нажмите **Руководство пользователя Acer**.

# Знакомство с ноутбуком Acer

Теперь, когда вы выполнили настройки, как показано на плакате по настройке, давайте поближе познакомимся с вашим новым ноутбуком Acer.

## Вид сверху

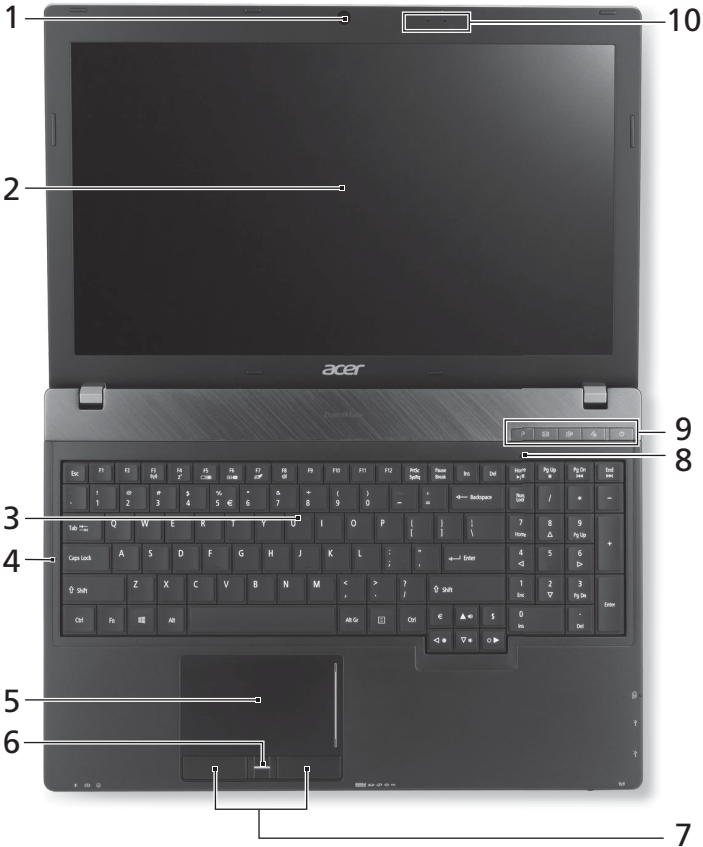

#	Значок	Элемент	Описание
1		Встроенная веб-камера	Веб-камера для видеосвязи. <i>Горящий индикатор рядом с веб-камерой означает, что она активна.</i>
2		Экран	Другое название - жидкокристаллический дисплей (ЖК-дисплей); служит для вывода изображения, формируемого компьютером (конфигурация может отличаться в зависимости от модели).
3		Клавиатура	Служит для ввода данных в компьютер.
4		Caps Lock	Загорается при включенной функции Caps Lock.
5		Сенсорная панель	Чувствительное к прикосновениям указательное устройство, позволяющее управлять курсором на экране так же, как и мышью.
6		Сканер отпечатков пальцев	Сканер отпечатков пальцев для Acer ProShield Security Suite.
7		Кнопки управления (левая и правая)	Эти левая и правая кнопки действуют так же, как левая и правая кнопки мыши.
8		Num Lock	Загорается при включенной функции Num Lock.
		Клавиша P	Программируемая клавиша (конфигурация может отличаться в зависимости от модели).
		Клавиша Эл. почта Асер	Запуск используемой по умолчанию программы эл. почты.
9		Клавиша резервного копирования	Запуск программы Acer Backup Management для архивирования данных за три шага.
		Отключение микрофона	Отключение микрофона.
		Кнопка/индикатор питания	Служит для включения/выключения компьютера. Отображает состояние питания компьютера.
10		Микрофоны	Два встроенных микрофона для записи стереозвука.

## "Горячие" клавиши

В компьютере используются комбинации клавиш ("горячие" клавиши) для быстрого вызова большинства функций управления компьютером, таких как яркость экрана и громкость.

Для использования комбинации клавиш сначала нажмите клавишу **<Fn>** и затем, не отпуская ее, нажмите вторую клавишу этой комбинации.

Комбинация клавиш	Значок	Функция	Описание
<b>&lt;Fn&gt; + &lt;F3&gt;</b>		Связь	Включение/выключение модулей связи в компьютере.
<b>&lt;Fn&gt; + &lt;F4&gt;</b>		Режим Сон	Переводит компьютер в режим Сон.
<b>&lt;Fn&gt; + &lt;F5&gt;</b>		Переключение видеовыхода	Переключает вывод изображения либо на дисплей, либо на внешний монитор (если он подключен), либо одновременно и на дисплей, и на внешний монитор.
<b>&lt;Fn&gt; + &lt;F6&gt;</b>		Выключение экрана	Выключение экрана дисплея для экономии заряда аккумулятора. Для включения экрана нажмите любую клавишу.
<b>&lt;Fn&gt; + &lt;F7&gt;</b>		Выключатель сенсорной панели	Включение и выключение встроенной сенсорной панели.
<b>&lt;Fn&gt; + &lt;F8&gt;</b>		Выключатель динамиков	Попеременное включение и выключение динамиков.
<b>&lt;Fn&gt; + &lt;D&gt;</b>		Повышение яркости	Увеличение яркости экрана.
<b>&lt;Fn&gt; + &lt;D&gt;</b>		Уменьшение яркости	Уменьшение яркости экрана.
<b>&lt;Fn&gt; + &lt;A&gt;</b>		Увеличение громкости	Повышение громкости звука.
<b>&lt;Fn&gt; + &lt;A&gt;</b>		Уменьшение громкости	Уменьшение громкости звука.



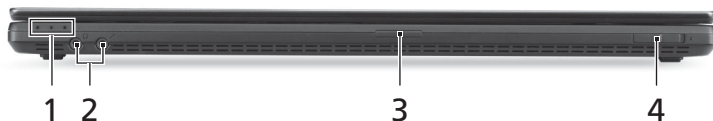

Комбинация клавиш	Значок	Функция	Описание
<Fn> + <Home>	▶/	Воспроизвести/ Приостановить	Воспроизведение или приостановка воспроизведения выбранного медиафайла.
<Fn> + <Pg Up>	■	Остановить	Останов воспроизведения выбранного медиафайла.
<Fn> + <Pg Dn>	◀◀	Предыдущий	Возврат к предыдущему медиафайлу.
<Fn> + <End>	▶▶	Следующий	Переход к следующему медиафайлу.

## Вид спереди с закрытой крышкой







#	Значок	Элемент	Описание
		Индикатор питания	Отображает состояние питания компьютера.
1		Индикатор аккумулятора	Отображает состояние аккумулятора компьютера. <b>1. Зарядка:</b> этот индикатор горит желтым во время зарядки аккумулятора. <b>2. Полностью заряжен:</b> этот индикатор горит синим при питании от электросети.
		Индикатор работы жесткого диска	Горит при обращении к жесткому диску.
2		Гнездо микрофона	Служит для подключения внешнего микрофона.
		Гнездо наушников/динамиков	Служит для подключения звуковых устройств (например, динамиков, наушников).

#	Значок	Элемент	Описание
3		Комбинированное устройство считывания карт памяти различных форматов	Поддерживает форматы Secure Digital (SD), MultiMediaCard (MMC), Memory Stick PRO (MS PRO), xD-Picture Card (xD). <b>Примечание:</b> надавите, чтобы извлечь/вставить карту. Одновременно можно использовать только одну карту памяти.
4		Выключатель/индикатор связи	Включение/выключение модулей связи в компьютере/индикация состояния модуля беспроводной связи в компьютере.

## Вид слева



#	Значок	Элемент	Описание
1		Разъем для подключения питания постоянного тока	Служит для подключения адаптера переменного тока.
2		Разъем HDMI	Служит для подключения к источникам цифрового видео высокой четкости.
3		Разъем внешнего дисплея (VGA)	Служит для подключения устройства отображения (например, внешнего монитора, ЖК-проектора).
4		Разъем USB/eSATA	Служит для подключения устройств USB или eSATA (только для определенных моделей). <b>Примечание:</b> При подключении устройства eSATA высвобождаются три разъема USB.
5		Гнездо SmartCard	Служит для установки карт SmartCard.
6		Гнездо ExpressCard/34	Служит для подключения модуля ExpressCard/34. <b>Примечание:</b> чтобы извлечь/вставить карту, надавите ее.

## Вид справа





#	Значок	Элемент	Описание
1		Разъем USB	Служит для подключения USB-устройств.
2		Разъем USB	
3		Разъем USB, через который даже при выключенном питании можно заряжать подключенные устройства	Черный цвет разъема означает его совместимость со стандартом USB 2.0, а его синий цвет означает, что он также совместим со стандартом USB 3.0.
4		Привод оптических дисков	Внутренний привод оптических компакт-дисков или DVD-дисков.
5		Индикатор обращения к оптическому диску	Горит во время работы привода оптических дисков.
6		Кнопка извлечения диска из привода	Служит для извлечения оптического диска из привода.
7		Отверстие аварийного извлечения	Служит для открытия лотка привода оптических дисков, когда питание компьютера отключено. <b>Примечание:</b> чтобы открыть лоток привода оптических дисков, когда компьютер выключен, вставьте скрепку в это отверстие аварийного извлечения.
8		Разъем Ethernet (RJ-45)	Служит для подключения к сети Ethernet 10/100/1000 Мбит/с.
9		Замок типа Kensington	Служит для подсоединения защитного тросика с замком типа Kensington для предотвращения кражи компьютера. <b>Примечание:</b> этим защитным тросиком обвяжите какой-нибудь неподвижный предмет, например, стол или ручку запертого ящика. Вставьте замок тросика в гнездо и поверните ключ, чтобы запереть замок. Бывают модели замков и без ключей.

## Сведения об интерфейсе USB 3.0

- Совместим с USB-устройствами с разъемами USB 3.0 и предыдущих стандартов.
- Для обеспечения оптимальной производительности используйте устройства, сертифицированные по стандарту USB 3.0.
- Соответствует стандарту USB 3.0 (сверхвысокоскоростной интерфейс USB).

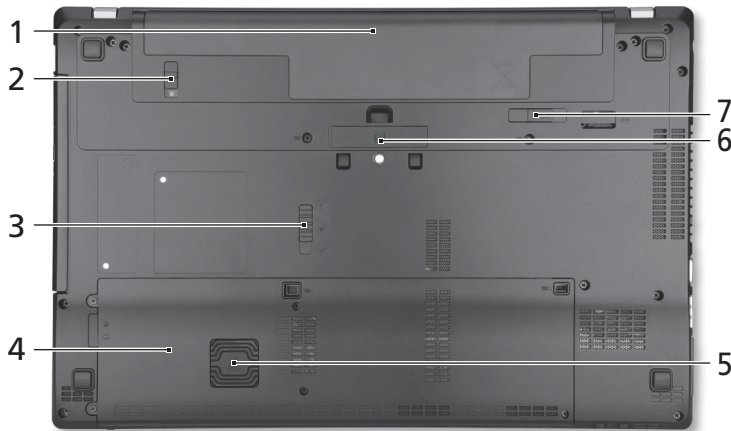
## Вид снизу



#	Значок	Элемент	Описание
1		Отсек аккумулятора	В этот отсек устанавливается аккумулятор компьютера.
2		Защелка аккумулятора	Служит для фиксации аккумулятора в отсеке.
3		Защелка отсека Acer MediaBay	Разблокирует модуль Acer MediaBay.
4		Отсек жесткого диска	Здесь размещается жесткий диск компьютера (крепится винтами).
		Отсек модулей оперативной памяти	В этот отсек устанавливаются модули оперативной памяти компьютера.

#	Значок	Элемент	Описание
5		Acer DASP (Disk Anti-Shock Protection - защита жесткого диска от ударов)	Защищает жесткий диск от случайных ударов и вибрации.
6		Разъем Acer ProDock	Служит для подключения к покупаемой отдельно док-станции Acer ProDock.
7		Защелка извлечения аккумулятора	Разблокирует аккумулятор для его извлечения.

## Условия эксплуатации

- Температура:
  - Рабочая: От 5°C до 35°C
  - Нерабочая: От -20°C до 65°C
- Влажность (без конденсации):
  - Рабочая: От 20% до 80%
  - Нерабочая: От 20% до 80%



# Notebook TravelMate

## Skrócony poradnik

### Rejestracja produktu

Przed pierwszym użyciem urządzenia zalecane jest niezwłoczne zarejestrowanie go. Zapewni to dostęp do następujących korzyści:

- Szybsza obsługa ze strony naszych przeszkolonych przedstawicieli.
- Członkostwo w społeczności Acer: możliwość uczestniczenia w akcjach promocyjnych i ankietach dla klientów.
- Najnowsze wiadomości od firmy Acer.

Nie trać ani chwili i zarejestruj się, czekają na Ciebie jeszcze inne korzyści!

### Sposób rejestracji

Aby zarejestrować ten produkt firmy Acer, odwiedź witrynę **www.acer.com**. Wybierz kraj, kliknij **REJESTRACJA PRODUKTU** i postępuj zgodnie z prostymi instrukcjami.

Zostaniesz również poproszony o zarejestrowanie produktu podczas procesu konfiguracji. Możesz również kliknąć dwukrotnie ikonę Rejestracja na pulpicie.

Po otrzymaniu informacji o rejestracji produktu wyślemy wiadomość e-mail z potwierdzeniem, zawierającym ważne dane, które należy przechowywać w bezpiecznym miejscu.

### Uzyskiwanie akcesoriów firmy Acer

Z przyjemnością informujemy o programie rozszerzenia gwarancji Acer oraz akcesoriach do notebooka dostępnych online. Zapraszamy do odwiedzenia naszego sklepu online i znalezienia tego, co Państwo potrzebujecie w witrynie **store.acer.com**.

Sklep Acer jest stopniowo rozwijany i niestety może nie być jeszcze dostępny w niektórych regionach. Prosimy o regularne sprawdzanie, czy jest już dostępny w Państwa kraju.

© 2012 Wszelkie prawa zastrzeżone.

Skrócony poradnik notebooka TravelMate

Ta zmiana: 07/2012

Oznaczenie modelu: \_\_\_\_\_

Numer seryjny: \_\_\_\_\_

Data zakupu: \_\_\_\_\_

Miejsce zakupu: \_\_\_\_\_



## Po kolei

Dziękujemy za wybranie komputera firmy Acer do spełnienia potrzeb w zakresie mobilnego przetwarzania.

## Instrukcje

Aby pomóc w korzystaniu z notebooka Acer, opracowaliśmy zestaw instrukcji:

Jako pierwszy **plakat instalacyjny** pomoże użytkownikom rozpocząć konfigurowanie komputera.

**Skrócony poradnik** przedstawia podstawowe właściwości i funkcje nowego komputera.

Aby uzyskać więcej informacji o tym, w jaki sposób nowy komputer może pomóc Ci być bardziej produktywnym, zapoznaj się z **Podręcznik użytkownika**. **Podręcznik użytkownika** zawiera przydatne informacje dotyczące nowego komputera. Obejmuje podstawowe zagadnienia, takie jak używanie klawiatury, dźwięki itd.

Podręcznik ten zawiera szczegółowe informacje dotyczące takich tematów, jak narzędzia systemowe, odzyskiwanie danych, opcje rozszerzeń oraz rozwiązywanie problemów. Oprócz nich zawiera także informacje na temat gwarancji oraz informacje dotyczące bezpieczeństwa pracy z komputerem przenośnym.

Wykonaj poniższe czynności, aby uzyskać do niego dostęp:





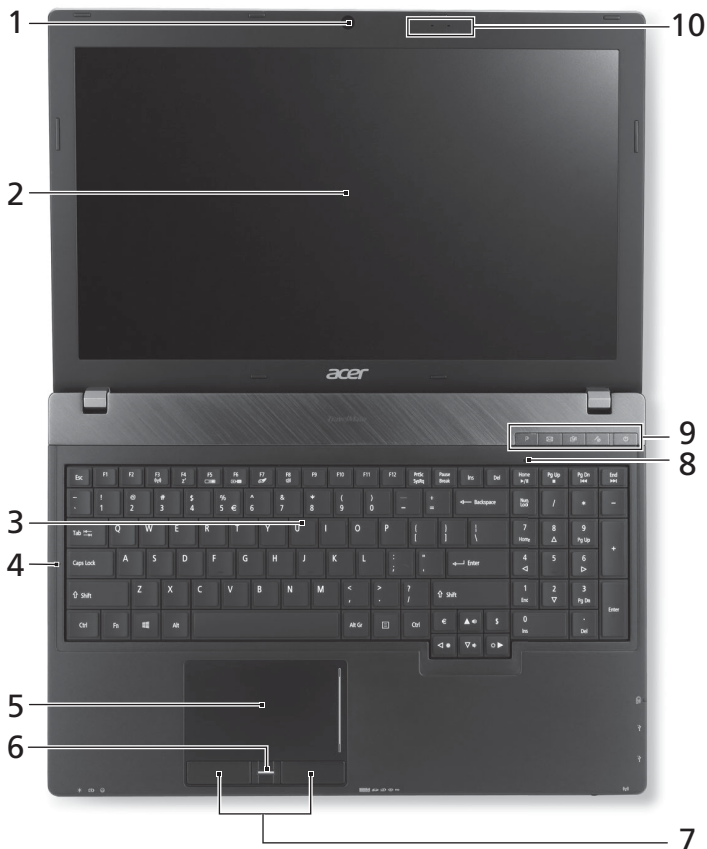

- 1 Wpisz „User” w polu tekstowym menu *Start*.
- 2 Kliknij **Podręcznik użytkownika komputera Acer**.

## Zapoznanie z notebookiem Acer

Po ustawieniu komputera jak to przedstawiono na ilustracji w plakacie instalacyjnym, przyjrzyjmy się nowemu notebookowi Acer.

### Widok z góry

















#	Ikona	Element	Opis
1		Zintegrowana kamera internetowa	Kamera internetowa do komunikacji wideo. <i>Świecenie wskaźnika obok kamery internetowej sygnalizuje, że jest ona aktywna.</i>
2		Ekran	Nazywany jest także wyświetlaczem ciekłokrystalicznym (Liquid-Crystal Display; LCD), wyświetla informacje wyjściowe komputera (konfiguracja może być różna w zależności od modelu).
3		Klawiatura	Umożliwia wprowadzanie danych do komputera.
4		Caps Lock	Świeci po uaktywnieniu klawisza Caps Lock.
5		Touchpad	Dotykowe urządzenie wskazujące, które działa jak myszka komputerowa.
6		Czytnik odcisków palców	Czytnik odcisków palców do pakietu zabezpieczeń Acer ProShield Security Suite.
7		Przyciski kliknięć (lewy i prawy)	Działanie lewego i prawego przycisku jest podobne do działania lewego i prawego przycisku myszki.
8		NumLk	Świeci po uaktywnieniu klawisza NumLk.
		Klawisz P	Klawisz programowalny (konfiguracja może być różna w zależności od modelu).
		Klawisz Acer e-mail	Służy do otwierania domyślnej aplikacji poczty e-mail.
9		Klawisz kopii zapasowej	Uruchamia program Acer Backup Management pozwalający na wykonywanie kopii zapasowych w trzech krokach.
		Wyciszenie mikrofonu	Wycisza mikrofon.
		Przycisk/wskaźnik zasilania	Służy do włączania i wyłączania komputera. Wskazuje stan zasilania komputera.
10		Mikrofony	Dwa wewnętrzne mikrofony do nagrywania dźwięku stereofonicznego.

## Klawisze skrótów

Komputer umożliwia używanie klawiszy skrótów lub kombinacji klawiszy w celu uzyskania dostępu do większości kontrolowanych parametrów, takich jak jasność ekranu czy ustawienia głośności.





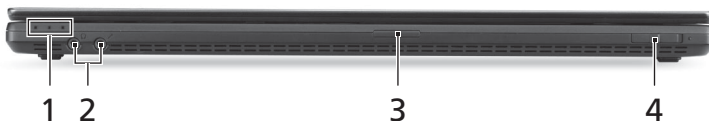

Aby uaktywnić klawisze skrótów, naciśnij i przytrzymaj klawisz **<Fn>** przed naciśnięciem innego klawisza w kombinacji klawisza skrótu.

Klawisz skrótu	Ikona	Funkcja	Opis
<b>&lt;Fn&gt; + &lt;F3&gt;</b>		Komunikacja	Włącza/wyłącza urządzenia komunikacyjne komputera.
<b>&lt;Fn&gt; + &lt;F4&gt;</b>		Wstrzymanie	Powoduje przejście komputera do trybu Wstrzymanie.
<b>&lt;Fn&gt; + &lt;F5&gt;</b>		Przełączenie wyświetlania	Umożliwia przełączanie sygnału wyjściowego wyświetlacza na ekran wyświetlacza lub na zewnętrzny monitor (jeśli jest przyłączony) lub na oba.
<b>&lt;Fn&gt; + &lt;F6&gt;</b>		Pusty ekran	Wyłącza podświetlenie ekranu wyświetlacza w celu oszczędzania energii. Naciśnij dowolny klawisz w celu przywrócenia wyświetlania.
<b>&lt;Fn&gt; + &lt;F7&gt;</b>		Przełączenie touchpada	Umożliwia włączanie i wyłączenie wewnętrznego touchpada.
<b>&lt;Fn&gt; + &lt;F8&gt;</b>		Przełączenie głośnika	Umożliwia włączanie i wyłączenie głośników.
<b>&lt;Fn&gt; + &lt;▷&gt;</b>		Zwiększenie jasności	Zwiększa jasność ekranu.
<b>&lt;Fn&gt; + &lt;◁&gt;</b>		Zmniejszenie jasności	Zmniejsza jasność ekranu.
<b>&lt;Fn&gt; + &lt;△&gt;</b>		Zwiększenie głośności	Zwiększa głośność dźwięku.
<b>&lt;Fn&gt; + &lt;▽&gt;</b>		Zmniejszenie głośności	Zmniejsza głośność dźwięku.
<b>&lt;Fn&gt; + &lt;Home&gt;</b>		Odtwórz/ Wstrzymaj	Odtwarzanie lub wstrzymanie wybranego pliku multimedialnego.
<b>&lt;Fn&gt; + &lt;Pg Up&gt;</b>		Zatrzymaj	Zatrzymanie odtwarzania wybranego pliku multimedialnego.

Klawisz skrót	Ikona	Funkcja	Opis
<Fn> + <Pg Dn>		Wstecz	Powrót do wcześniejszego pliku multimedialnego.
<Fn> + <End>		Dalej	Przeskoczenie do następnego pliku multimedialnego.





## Widok z przodu (pokrywa zamknięta)



#	Ikona	Element	Opis
		Wskaźnik zasilania	Wskazuje stan zasilania komputera.
1		Wskaźnik akumulatora	Wskazuje stan akumulatora komputera. <b>1. Ładowanie:</b> Świeci żółtym światłem, gdy akumulator jest ładowany. <b>2. Pełne naładowanie:</b> Świeci niebieskim światłem podczas pracy w trybie zasilania prądem przemiennym.
		Wskaźnik dysku twardego	Świeci, gdy działa dysk twardy.
2		Gniazdo mikrofonowe	Służy do przyłączenia sygnału z zewnętrznych mikrofonów.
		Gniazdo słuchawek/głośników	Służy do przyłączenia urządzeń audio (np. głośniki, słuchawki).
3		Wielofunkcyjny czytnik kart pamięci	Obsługuje następujące typy kart: Secure Digital (SD), MultiMediaCard (MMC), Memory Stick PRO (MS PRO) oraz xD-Picture Card (xD). <b>Uwaga:</b> Aby wyjąć/zainstalować kartę, wciśnij ją delikatnie. Jednocześnie można obsługiwać tylko jedną kartę.
4		Przełącznik/wskaźnik komunikacji	Włącza/wyłącza urządzenia komunikacyjne komputera/wskaźnik połączenia bezprzewodowego komputera z urządzeniem.

## Widok z lewej



#	Ikona	Element	Opis
1		Gniazdo zasilania	Gniazdo zasilacza.
2		Port HDMI	Obsługuje połączenie cyfrowego wideo o wysokiej rozdzielczości.
3		Port zewnętrznego wyświetlacza (VGA)	Służy do przyłączenia urządzenia wyświetlającego (np. zewnętrzny monitor, projektor LCD).
4		Port USB/eSATA	Służy do przyłączenia urządzeń USB lub eSATA (tylko w niektórych modelach). <b>Uwaga:</b> W czasie podłączenia urządzenia eSATA będą dostępne trzy porty USB.
5		Gniazdo SmartCard	Obsługuje SmartCard.
6		Gniazdo kart pamięci ExpressCard/34	Obsługuje jeden moduł ExpressCard/34. <b>Uwaga:</b> Aby wyjąć/włożyć kartę, wciśnij ją delikatnie.

## Widok z prawej





#	Ikona	Element	Opis
1		Port USB	
2		Port USB	Służy do podłączania urządzeń USB.
3		Port USB z funkcją ładowania przy wyłączonym zasilaniu	<i>Port czarny jest zgodny z USB 2.0, natomiast port niebieski jest zgodny z USB 3.0.</i>
4		Napęd optyczny	Wewnętrzny napęd optyczny; obsługuje dyski CD lub DVD.
5		Wskaźnik dostępu do dysku optycznego	Świeci, kiedy napęd optyczny jest aktywny.
6		Przycisk wysuwania napędu optycznego	Wyrzuca dysk optyczny z napędu.
7		Otwór wysuwania awaryjnego	Umożliwia wysunięcie tacy napędu optycznego, kiedy komputer jest wyłączony. <b>Uwaga:</b> Wsuń spinacz do otworu wysuwania awaryjnego w celu wysunięcia tacy napędu optycznego, kiedy komputer jest wyłączony.
8		Port Ethernet (RJ-45)	Służy do przyłączenia do sieci komputerowej typu Ethernet 10/100/1000.
9		Gniazdo blokady Kensington	Służy do podłączania blokady zgodnej ze standardem firmy Kensington. <b>Uwaga:</b> Kabel zabezpieczenia komputera należy owinąć wokół ciężkiego nieruchomego obiektu, takiego jak stół lub uchwyt zabloковanej szuflady. Wstaw zamek blokady do gniazda i przekręć klucz w celu zamknięcia blokady. Dostępne są także modele bez kluczy.

## Informacje dotyczące interfejsu USB 3.0

- Zgodność z USB 3.0 oraz wcześniejszymi urządzeniami USB.
- W celu optymalizacji działania używaj urządzeń z certyfikatem USB 3.0.
- Obsługuje specyfikację USB 3.0 (SuperSpeed USB).

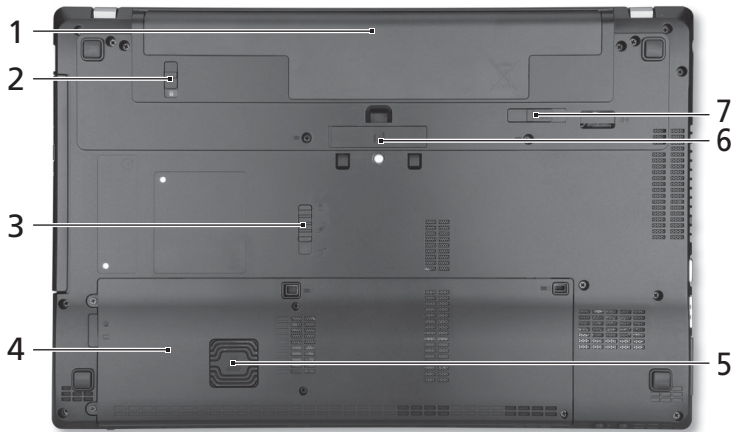
## Widok od strony podstawy



#	Ikona	Element	Opis
1		Wnęka na baterię	Przechowuje baterię komputera.
2		Zatrzask baterii	Pozwala zabezpieczyć baterię w prawidłowej pozycji.
3		Zatrzask zwalniania Acer MediaBay	Zwalnia moduł Acer MediaBay.
4		Wnęka na dysk twardy	Mieści dysk twardy komputera (zabezpieczona śrubami).
		Przegroda na pamięć	Mieści główną pamięć komputera.
5		Acer DASP (zabezpieczenie przeciwwstrząsowe dysku)	Chroni napęd dysku twardego przed wstrząsami i uderzeniami.



#	Ikona	Element	Opis
6		Złącze Acer ProDock	Podłączanie do opcjonalnej stacji dokującej Acer ProDock.
7		Blokada baterii	Umożliwia zwolnienie i wyjęcie baterii.

## Warunki środowiska

- Temperatura:
  - Podczas pracy: Od 5°C do 35°C
  - Podczas przechowywania: Od -20°C do 65°C
- Wilgotność (bez kondensacji pary):
  - Podczas pracy: Od 20% do 80%
  - Podczas przechowywania: Od 20% do 80%



# TravelMate notebook

## Rövid útmutató

### Termékregisztráció

Javasoljuk, hogy az első használatkor azonnal regisztrálja a terméket. A regisztráció révén hasznos szolgáltatásokhoz férhet hozzá:

- Gyorsabb kiszolgálást kap szakképzett képviselőinktől.
- Tagjává válik az Acer közösségnek: értesülhet az akciókról és részt vehet a fogyasztói felmérésekben.
- Megkaphatja a legújabb híreket az Acer-től.

Regisztráljon, hiszen számos további előny vár Önre!

### A regisztrálás módja

Acer termékének regisztrálásához látogasson el a következő honlapra: **www.acer.com**. Válassza ki a megfelelő országot, kattintson a **TERMÉKREGISZTRÁCIÓ** elemre, kövesse az útmutatást.

A telepítés közben is regisztrálhatja termékét, vagy duplán rákattinthat az asztalon lévő regisztráció ikonra is.

Miután megkaptuk a termékregisztrációt, egy visszaigazoló e-mailt küldünk. Javasoljuk, hogy őrizze meg ezt az e-mailt, mert fontos adatokat tartalmaz.

### Acer kellékek beszerzése

Örömmel tájékoztatjuk Önt, hogy az Acer garancia kiterjesztési program és Notebook kellékek online elérhetőek. Látogasson el online üzletünkbe: **store.acer.com**.

Az Acer üzlet folyamatos fejlesztés alatt áll, és egyes régiókban sajnos nem elérhető. Az Ön országában való elérhetőség megállapításához kérjük, rendszeresen látogasson vissza.

© 2012 Minden jog fenntartva.

TravelMate notebook – Rövid útmutató  
Ez egy javított változat: 07/2012

Modellszám: \_\_\_\_\_

Sorozatszám: \_\_\_\_\_

Vásárlás időpontja: \_\_\_\_\_

Vásárlás helye: \_\_\_\_\_

## Az első lépések

Köszönjük, hogy mobil számítástechnikai feladatai elvégzéséhez egy Acer hordozható számítógépet választott.

## Útmutatók

Minden segítséget szeretnénk megadni Önnek új Acer gépének használatához, ezért a következő útmutatókat dolgoztuk ki:

Első lépésként a **telepítési poszteren** szereplő útmutatást követve helyezze üzembe a számítógépet.

A jelen **Rövid útmutató** ismerteti az Ön új számítógépének alapvető jellemzőit és funkciót.

A számítógép még hatékonyabb használatával kapcsolatban a **Felhasználói Kézikönyve** tartalmaz útmutatást. A **Felhasználói Kézikönyve** hasznos információkat tartalmaz új számítógépének használatára vonatkozóan. Olyan alapvető témaköröket tartalmaz, mint a billentyűzet és hang, stb.

Ez a kézikönyv részletes információkat tartalmaz például az előre telepített segédprogramokról, az adat-helyreállításról, a bővítési lehetőségekről és a hibaelhárításról. Emellett ismerteti a garanciával kapcsolatos tudnivalókat, valamint a számítógépre vonatkozó általános szabályokat és biztonsági előírásokat.

Megnyitásához kövesse az alábbi lépéseket:





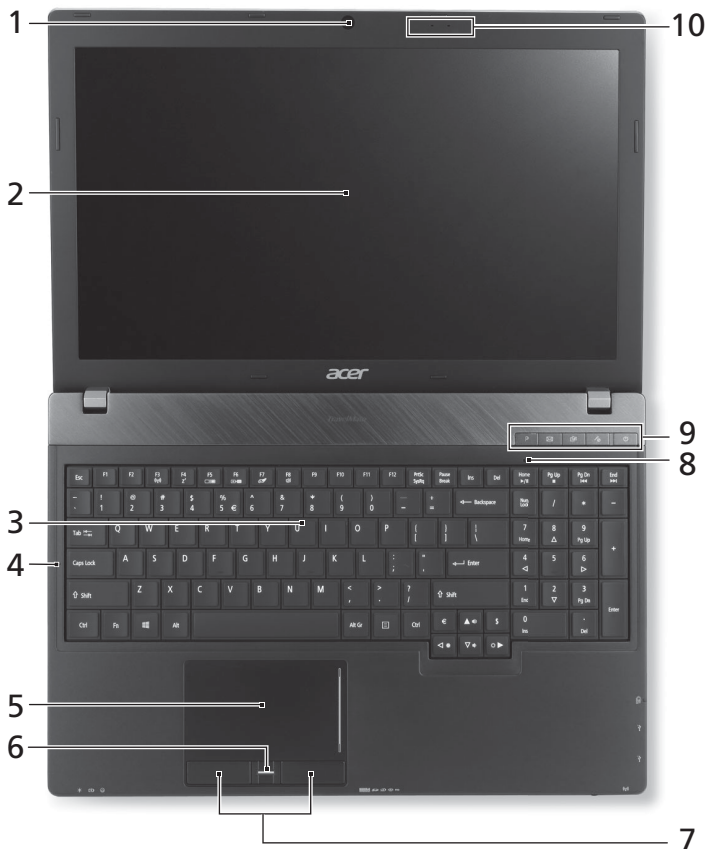

- 1 Írja be a "Felhasználót" a *Startból*.
- 2 Kattintson az **Acer Felhasználói kézikönyv**.

## Ismerkedjen meg új Acer gépével!

Miután a telepítési poszter alapján üzembe helyezte a számítógépet, ismerkedjen meg új Acer notebookjával!

### Felülnézet















#	Ikon	Tétel	Leírás
1		Beépített webkamera	Webkamera videokommunikációs célokra. <i>A webkamera mellett felvillanó fény azt jelzi, hogy a webkamera aktív.</i>
2		Képernyő	Más néven folyadékkristályos kijelző (Liquid-Crystal Display, LCD), a számítógép kimenetét jeleníti meg (a konfiguráció típustól függően változhat).
3		Billentyűzet	Az adatbevitel eszköze.
4		Caps Lock	Akkor világít, ha a Caps Lock be van kapcsolva.
5		Érintőpad	Érintésérzékeny mutatóeszköz, a számítógépek egeréhez hasonlóan működik.
6		Ujjlenyomat olvasó	Ujjlenyomat olvasó az Acer ProShield Security Suite.
7		Kattintógombok (bal és jobb)	A bal és a jobb gomb az egér bal és jobb gombjához hasonlóan működik.
8		Num Lock	Akkor világít, ha a Num Lock be van kapcsolva.
		P billentyű	Programozható billentyű (a konfiguráció típustól függően változhat).
		Acer e-mail gomb	Megnyitja az alapértelmezett levelező alkalmazását.
9		Biztonsági mentés gomb	Elindítja az Acer biztonsági mentés kezelőt a három lépéses mentéshez.
		Mikrofon elnémítása	Elnémítja a mikrofont.
		Bekapcsoló gomb/ jelzőfény	Be- és kikapcsolja a számítógépet. A számítógép üzemállapotát jelzi.
10		Mikrofonok	Két belső mikrofon sztereó hangfelvételek készítéséhez.



## Gyorsbillentyűk

A számítógép a legtöbb beállítás elérését gyorsbillentyűkkel vagy billentyűkombinációkkal teszi lehetővé; ilyen például a képernyő fényereje és a hangerő.

Gyorsbillentyű használatához nyomja le és tartsa lenyomva az **<Fn>** billentyűt, a billentyűkombináció másik billentyűjét csak ezt követően nyomja le.







Gyorsbillentyű	Ikon	Funkció	Leírás
<b>&lt;Fn&gt; + &lt;F3&gt;</b>		Kommunikáció	A számítógép kommunikációs moduljainak be- és kikapcsolására használható.
<b>&lt;Fn&gt; + &lt;F4&gt;</b>		Alvás	A számítógépet alvó üzemmódba helyezi.
<b>&lt;Fn&gt; + &lt;F5&gt;</b>		A kijelző be- és kikapcsolása	Váltás a következő megjelenítési módok között: kijelző, külső monitor (ha csatlakoztatva van), illetve mindkettő.
<b>&lt;Fn&gt; + &lt;F6&gt;</b>		Kijelző kikapcsolása	Kikapcsolja a kijelző háttérvilágítását, ezzel energiát takarítva meg. A háttérvilágítás bármely billentyű megnyomására visszakapcsol.
<b>&lt;Fn&gt; + &lt;F7&gt;</b>		Az érintőpad be- és kikapcsolása	A beépített érintőpad be- és kikapcsolása.
<b>&lt;Fn&gt; + &lt;F8&gt;</b>		Hangszóró be- és kikapcsolása	A hangszórók be- és kikapcsolását teszi lehetővé.
<b>&lt;Fn&gt; + &lt;▷&gt;</b>		Fényerő növelése	Növeli a kijelző fényerejét.
<b>&lt;Fn&gt; + &lt;◁&gt;</b>		Fényerő csökkentése	Csökkenti a kijelző fényerejét.
<b>&lt;Fn&gt; + &lt;△&gt;</b>		A hangerő növelése	Növeli a hangerőt.
<b>&lt;Fn&gt; + &lt;▽&gt;</b>		A hangerő csökkentése	Csökkenti a hangerőt.
<b>&lt;Fn&gt; + &lt;Home&gt;</b>		Lejátszás/Szünet	A kijelölt médiafajl lejátszása vagy lejátszásának szüneteltetése.
<b>&lt;Fn&gt; + &lt;Pg Up&gt;</b>		Leállítás	A kijelölt médiafajl lejátszásának leállítása.

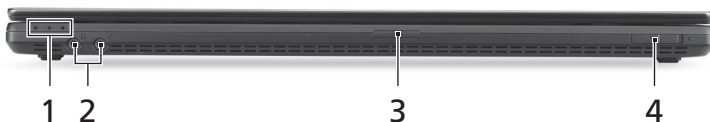

Gyorsbillentyű	Ikon	Funkció	Leírás
<Fn> + <Pg Dn>		Előző	Visszalépés az előző médiafájltra.
<Fn> + <End>		Tovább	Ugrás a következő médiafájltra.





## Előnézet lehajtott kijelzővel



#	Ikon	Tétel	Leírás
		Üzemállapot jelzőfénye	A számítógép üzemállapotát jelzi.
1		Akkumulátor állapotjelző	Az akkumulátor üzemállapotát jelzi. <b>1. Töltés:</b> Sárgán világít, ha az akkumulátor töltése folyamatban van. <b>2 Teljesen feltöltve:</b> Hálózati tápellátás használatakor kéken világít.
		Merevlemez jelzőfénye	Jelzi, ha a merevlemez használatban van.
2		Mikrofon aljzat	Külső mikrofon csatlakoztatását teszi lehetővé.
		Fejhallgató/hangszóró jack	Audió eszközök (pl. hangszórók, fejhallgató) csatlakoztatását teszi lehetővé.
3		Multifunkciós kártyaolvasó	Secure Digital (SD), MultiMediaCard (MMC), Memory Stick PRO (MS PRO) és xD-Picture Card (xD) kártyák fogadására képes. <b>Megjegyzés:</b> A kártyák finoman benyomva helyezhetők be és vehetők ki. Egy adott időpontban csak egyféle kártya használatára van lehetőség.
4		Kommunikációs kapcsoló/jelzőfény	A számítógép kommunikációs moduljainak be- és kikapcsolására használható/jelzi a számítógép vezeték nélküli kapcsolati eszközeinek állapotát.

## Bal oldali nézet



#	Ikon	Tétel	Leírás
1		Egyenáramú bemeneti aljzat	A váltakozó áramú hálózati adapter csatlakoztatását teszi lehetővé.
2		HDMI port	A nagy felbontású, digitális videokapcsolatokat támogatja.
3		Külső kijelző (VGA) port	Megjelenítő eszköz (pl. külső monitor vagy LCD kivetítő) csatlakoztatását teszi lehetővé.
4		USB/eSATA port	USB eszközök és eSATA eszközök csatlakoztatására használható (csak bizonyos modellek esetében). <b>Megjegyzés:</b> Ha eSATA eszközt csatlakoztat, akkor három USB port áll a rendelkezésére.
5		SmartCard foglalat	SmartCard befogadására képes.
6		ExpressCard/34 foglalat	Egy darab ExpressCard/34 modul befogadására képes. <b>Megjegyzés:</b> A kártya benyomással helyezhető be/vehető ki.

## Jobb oldali nézet







#	Ikön	Tétel	Leírás
1		USB port	
2		USB port	USB eszközökhöz csatlakozik.
3		USB port kikapcsolás közbeni töltéssel	<i>Ha a port fekete, akkor USB 2.0-kompatibilis, ha pedig kék, akkor USB 3.0-kompatibilis is egyben.</i>
4		Optikai meghajtó	Belső optikai meghajtó, CD- és DVD-lemezek kezelésére képes.
5		Az optikai lemez elérését jelző fény	Akkor világít, amikor az optikai meghajtó aktív.
6		Optikai meghajtó kiadógombja	Segítségével kiadatható a lemez az optikai meghajtóból.
7		Vészkiadó furat	Lehetővé teszi az optikai meghajtó tálcájának a számítógép kikapcsolt állapotában történő kinyitását. <b>Megjegyzés:</b> Helyezzen egy papír klipset a vészkiadó nyílásba az optikai meghajtó lemeztálcájának kinyitásához, ha a számítógép ki van kapcsolva.
8		Ethernet (RJ-45) port	Ethernet 10/100/1000 típusú hálózattal képes biztosítani a kapcsolatot.
9		Kensington záraljzat	Kensington számítógépes biztonsági zár alkalmazását teszi lehetővé. <b>Megjegyzés:</b> Hurkolja a számítógépes biztonsági zárhoz tartozó drótkötelet egy mozdíthatatlan tárgy, például asztal vagy zárt fiók fogantyúja köré. Illessze be a zárat, majd a kulcsot elfordítva rögzítse. Kaphatók kulcs nélküli modellek is.

## Információk az USB 3.0 -ról

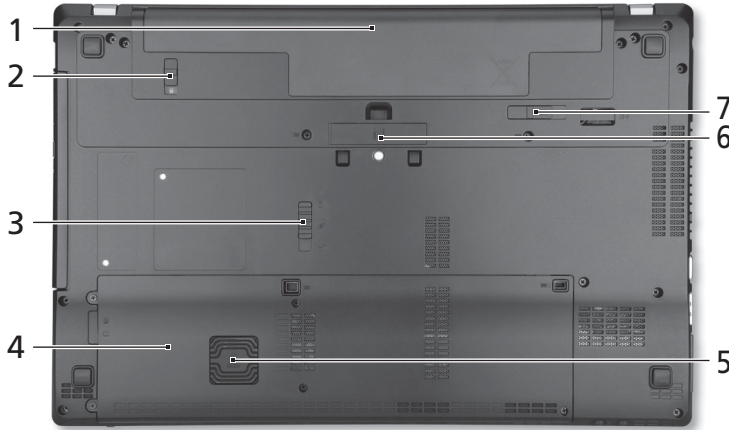
- USB 3.0 és korábbi USB eszközökkel kompatibilis.
- Az optimális teljesítmény eléréséhez használjon minősített USB 3.0-ás eszközöket.
- Az USB 3.0 (SuperSpeed USB) műszaki paraméterek definiálják.

## Alulnézet



#	Ikon	Tétel	Leírás
1		Akkumulátorfoglat	A számítógép akkumulátorát fogadja be.
2		Akkumulátor retesze	Az akkumulátor rögzítését biztosítja.
3		Az Acer MediaBay kioldógombja	Az Acer MediaBay modult oldja ki.
4		Merevlemez-foglat	A számítógép merevlemezét fogadja be (csavaros rögzítésű).
		Memóriarekesz	A számítógép memóriáját fogadja be.
5		Acer DASP (Disk Anti-Shock Protection, lemezek ütés elleni védelme)	A merevlemez meghajtót védi az ütésektől és a rázkódástól.

#	Ikon	Tétel	Leírás
6		Acer ProDock csatlakozó	Opcionális Acer ProDock eszközhöz csatlakozik.
7		Akkumulátor kioldógombja	Az akkumulátor eltávolítását teszi lehetővé.

## Környezet

- Hőmérséklet:
  - Üzemeltetés: 5°C – 35°C
  - Kikapcsolt állapotban: -20°C – 65°C
- Páratartalom (kicsapódás nélkül):
  - Üzemeltetés: 20% – 80%
  - Kikapcsolt állapotban: 20% – 80%



# Notebook TravelMate

## Stručné pokyny

### Registrace produktu

Doporučujeme vám, abyste si při prvním použití produkt zaregistrovali. Získáte tak přístup k některým užitečným výhodám, například:

- Rychlejší služby našich vyškolených zástupců.
- Členství v komunitě Acer: možnost dostávat nabídky promoakcí a účastnit se průzkumů mezi zákazníky.
- Aktuální informace od společnosti Acer.

Neváhejte a zaregistrujte se, protože na vás čekají další výhody!

### Postup registrace

Chcete-li zaregistrovat svůj produkt Acer, navštivte naše webové stránky na adrese **www.acer.com**. Zvolte zemi, klepněte na položku **REGISTRACE PRODUKTU** a postupujte podle jednoduchých pokynů.

O registraci produktu budete také požádáni při procesu nastavení nebo můžete poklepat na ikonu Registrace na ploše.

Po obdržení registrace produktu vám pošleme potvrzovací e-mail s důležitými údaji, které byste měli uchovávat na bezpečném místě.

### Získání příslušenství Acer

S potěšením vás informujeme, že program Prodloužená záruka Acer a příslušenství k notebookům jsou k dispozici online. Podívejte se na náš online obchod a najděte co potřebujete na adrese **store.acer.com**.

Obchod Acer se postupně stále obměňuje, ale žel není k dispozici v některých regionech. Pravidelně prosím zjišťujte, kdy bude k dispozici i ve vaší zemi.

© 2012 Všechna práva vyhrazena.

Stručné pokyny k notebooku TravelMate  
Tato revize: 07/2012

Číslo modelu: \_\_\_\_\_

Sériové číslo: \_\_\_\_\_

Datum zakoupení: \_\_\_\_\_

Místo zakoupení: \_\_\_\_\_



## Stručné pokyny

Děkujeme vám, že jste si k uspokojení svých potřeb v oblasti přenosných počítačů vybrali notebook Acer.

## Uživatelské příručky

Abychom vám při používání notebooku Acer pomohli, vytvořili jsme pro vás sadu příruček:

**Instalační leták** vám pomůže při úvodním nastavení počítače.

Tyto **Stručné pokyny** vás seznámí se základními schopnostmi a funkcemi nového počítače.

Další informace o tom, jak můžete pomocí počítače zvýšit svou produktivitu, naleznete v **Uživatelská příručka**. **Uživatelská příručka** obsahuje užitečné informace, které se týkají vašeho nového počítače. Obsahuje základní témata, např. používání klávesnice a zvuku atd.

Tato příručka obsahuje podrobné informace týkající se například systémových nástrojů, obnovování dat, možností rozšíření a odstraňování potíží. Dále obsahuje záruční informace, informace týkající se všeobecných předpisů a bezpečnostní upozornění k notebooku.

Zobrazíte ji následujícím postupem:





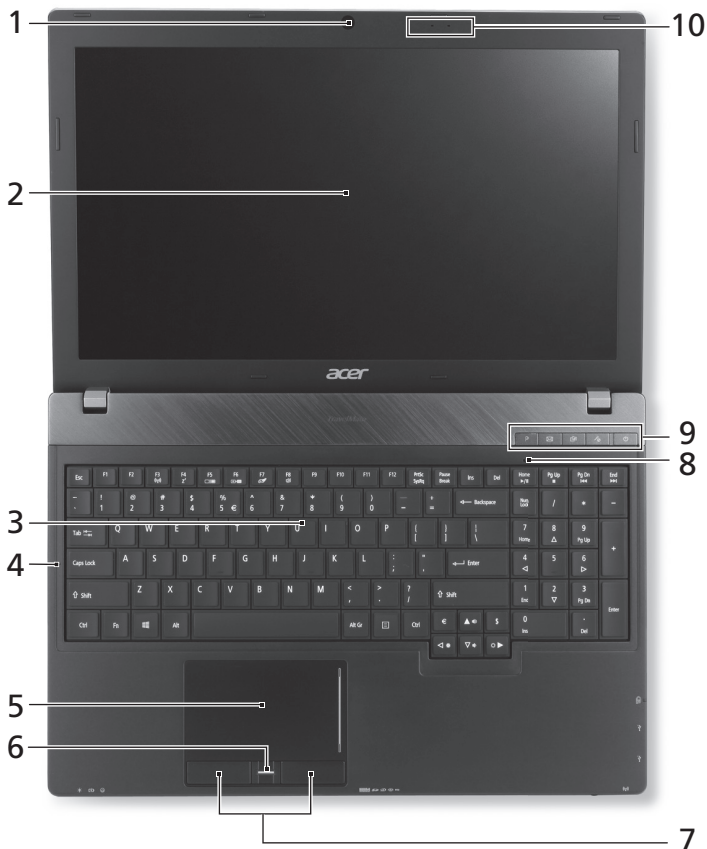

- 1 Zadejte „Uživatel“ z nabídky *Start*.
- 2 Klepněte na **Uživatelská příručka Acer**.

## Seznámení s notebookem Acer

Po nastavení počítače podle pokynů znázorněných na instalačním letáku vás seznámíme s vaším novým notebookem Acer.

### Pohled shora

















#	Ikona	Položka	Popis
1		Integrovaná webová kamera	Webová kamera pro obrazovou komunikaci. <i>Kontrolka vedle webové kamery ukazuje, že je webová kamera aktivní.</i>
2		Obrazovka	Na displeji, označovaném také displej z tekutých krystalů (Liquid-Crystal Display; LCD), se zobrazuje grafický výstup počítače (konfigurace se může lišit podle modelů).
3		Klávesnice	Slouží k zadávání údajů do počítače.
4		Caps Lock	Svítlí při aktivaci funkce Caps Lock.
5		Touchpad	Polohovací zařízení citlivé na dotek, které má podobnou funkci jako počítačová myš.
6		Čtečka otisků prstů	Čtečka otisků prstů pro Acer ProShield Security Suite.
7		Tlačítka (levé a pravé)	Levé a pravé tlačítko funguje jako levé a pravé tlačítko myši.
8		Num Lock	Svítlí při aktivaci funkce NumLk.
		Klávesa P	Programovatelná klávesa (konfigurace se může lišit podle modelů).
		Klávesa Acer email	Otevře vaši výchozí e-mailovou aplikaci.
9		Klávesa zálohování	Slouží ke spuštění aplikace Acer Backup Management pro vytvoření zálohy ve třech krocích.
		Ztlumit mikrofon	Ztlumí mikrofon.
		Tlačítko a indikátor napájení	Slouží k zapnutí a vypnutí počítače. Indikuje stav napájení počítače.
10		Mikrofony	Dva interní mikrofony pro stereofonní nahrávání zvuku.

## Klávesové zkratky

Tento počítač využívá klávesové zkratky nebo kombinace kláves ke zpřístupnění většiny ovládacích prvků počítače, jako je jas zobrazení a hlasitost výstupu.





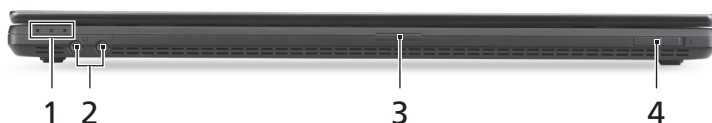

Klávesovou zkratku aktivujete stisknutím a podržením klávesy **<Fn>** dříve, než stisknete druhou klávesu této kombinace.

Klávesová zkratka	Ikona	Funkce	Popis
<b>&lt;Fn&gt; + &lt;F3&gt;</b>		Komunikace	Povoluje/zakazuje komunikační zařízení počítače.
<b>&lt;Fn&gt; + &lt;F4&gt;</b>		Režim spánku	Slouží k přepnutí počítače do režimu spánku.
<b>&lt;Fn&gt; + &lt;F5&gt;</b>		Přepnutí displeje	Přepíná výstup zobrazení mezi displejem, externím monitorem (pokud je připojen) a oběma zařízeními.
<b>&lt;Fn&gt; + &lt;F6&gt;</b>		Prázdná obrazovka	Slouží k vypnutí podsvícení obrazovky displeje, čímž se ušetří energie. Podsvícení obnovíte stisknutím libovolné klávesy.
<b>&lt;Fn&gt; + &lt;F7&gt;</b>		Přepnutí zařízení touchpad	Slouží k zapnutí a vypnutí interního zařízení touchpad.
<b>&lt;Fn&gt; + &lt;F8&gt;</b>		Přepnutí reproduktoru	Slouží k zapnutí a vypnutí reproduktorů.
<b>&lt;Fn&gt; + &lt;▷&gt;</b>		Zvýšení jasu	Slouží ke zvýšení jasu obrazovky.
<b>&lt;Fn&gt; + &lt;◁&gt;</b>		Snížení jasu	Slouží ke snížení jasu obrazovky.
<b>&lt;Fn&gt; + &lt;△&gt;</b>		Zvýšení hlasitosti	Slouží ke zvýšení hlasitosti zvuku.
<b>&lt;Fn&gt; + &lt;▽&gt;</b>		Snížení hlasitosti	Slouží ke snížení hlasitosti zvuku.
<b>&lt;Fn&gt; + &lt;Home&gt;</b>		Přehrávat/ Pozastavit	Přehrát nebo pozastavit vybraný mediální soubor.
<b>&lt;Fn&gt; + &lt;Pg Up&gt;</b>		Zastavit	Zastavit přehrávání vybraného mediálního souboru.

Klávesová zkratka	Ikona	Funkce	Popis
<Fn> + <Pg Dn>		Předchozí	Návrat na předchozí mediální soubor.
<Fn> + <End>		Další	Přeskočit na další mediální soubor.





## Pohled na zavřenou přední stranu



#	Ikona	Položka	Popis
		Indikátor napájení	Indikuje stav napájení počítače.
1		Indikátor baterie	Indikuje stav baterie počítače. <b>1. Nabíjení:</b> Při nabíjení baterie svítí indikátor jantarově. <b>2. Plně nabití:</b> V režimu napájení ze sítě svítí indikátor modře.
		Indikátor HDD	Svítí, pokud je aktivní pevný disk.
2		Konektor mikrofonu	Slouží k připojení vstupů z externího mikrofonu.
		Konektor pro připojení sluchátek a reproduktorů	Slouží k připojení zvukových zařízení (například reproduktorů nebo sluchátek).
3		Čtečka karet Více v 1	Podporuje karty Secure Digital (SD), MultiMediaCard (MMC), Memory Stick PRO (MS PRO) a xD-Picture Card (xD). <b>Poznámka:</b> Stisknutím vyjměte nebo vložte kartu. V jednom okamžiku lze použít jen jednu kartu.
4		Spínač a indikátor komunikace	Povoluje/zakazuje komunikační zařízení počítače/indikuje stav zařízení pro bezdrátové připojení počítače.

## Pohled zleva



#	Ikona	Položka	Popis
1		Napájecí konektor	Zajišťuje připojení k síťovému adaptéru.
2		Port HDMI	Podporuje připojení digitálního videa ve vysokém rozlišení.
3		Port externího zobrazovacího zařízení (VGA)	Umožňuje připojení zobrazovacího zařízení (například externího monitoru nebo projektoru LCD).
4		Port USB/eSATA	Umožňuje připojení zařízení s rozhraním USB nebo eSATA (pouze u vybraných modelů). <b>Poznámka:</b> Když připojíte zařízení eSATA, budete mít dostupné tři USB porty.
5		Slot SmartCard	Podpora karet SmartCard.
6		Slot ExpressCard/34	Umožňuje vložit jeden modul ExpressCard/34. <b>Poznámka:</b> Stisknutím vyjměte nebo vložte kartu.

## Pohled zprava







#	Ikona	Položka	Popis
1		Port USB	
2		Port USB	Připojení k zařízením USB. <i>Pokud je port černý, je kompatibilní s USB 2.0, pokud je port modrý, je kompatibilní také s USB 3.0.</i>
3		Port USB s nabíjením při vypnutí	
4		Optická jednotka	Interní optická jednotka, přijímá disky CD a DVD.
5		Indikátor přístupu k optickému disku	Svítlí, pokud je optická jednotka aktivní.
6		Tlačítko vysunutí optické jednotky	Vysouvá optický disk z jednotky.
7		Otvor pro nouzové vysunutí	Umožňuje vysunutí přihrádky optické jednotky, pokud je počítač vypnutý. <b>Poznámka:</b> Chcete-li vysunout přihrádku optické jednotky, jestliže je počítač vypnutý, vložte do otvoru pro nouzové vysunutí kancelářskou sponku.
8		Port Ethernet (RJ-45)	Slouží k připojení počítače k síti Ethernet 10/100/1000.
9		Drážka pro zámeček Kensington	Umožňuje připojení počítačového bezpečnostního zámku kompatibilního s typem Kensington. <b>Poznámka:</b> Připevněte bezpečnostní kabel k nehybnému předmětu, například ke stolu nebo rukojeti uzamčené zásuvky. Vložte zámeček do drážky a otočením klíče zámeček zamkněte. Vložte zámeček do drážky a otočením klíče zámeček zamkněte.

## Informace na USB 3.0

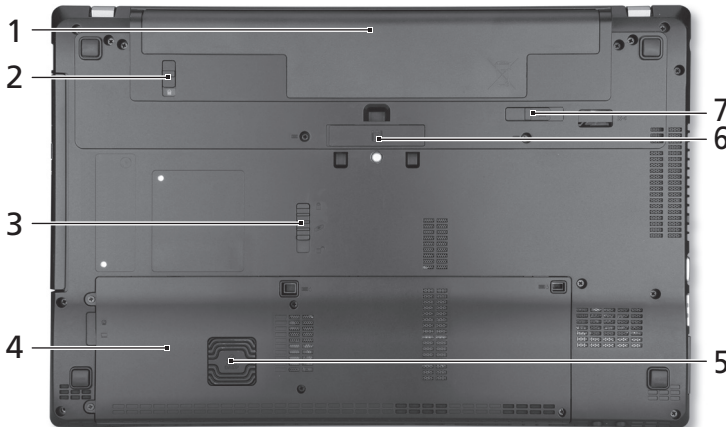
- Kompatibilní se zařízeními USB 3.0 a dřívějšími.
- Pro optimální výkon používejte zařízení certifikované pro USB 3.0.
- Definováno specifikací USB 3.0 (SuperSpeed USB).

## Pohled zespodu



#	Ikona	Položka	Popis
1		Pozice pro baterii	Zde je uložena baterie počítače.
2		Zámek baterie	Zamkne baterii na místě.
3		Západkový systém Acer MediaBay	Uvolňuje modul Acer MediaBay.
4		Pozice pro pevný disk	Zde je uložen pevný disk počítače (zajištěný šrouby).
		Pozice pro paměť	Zde je uložena hlavní paměť počítače.
5		Acer DASP (Disk Anti-Shock Protection)	Chrání pevný disk před nárazy a otřesy.
6		Konektor Acer ProDock	Slouží k připojení volitelného zařízení Acer ProDock.
7		Uvolňovací západka baterie	Uvolňuje baterii k vyjmutí.



## Prostředí

---

- Teplota:
    - Provozní: 5°C až 35°C
    - Neprovozní: -20°C až 65°C
  - Vlhkost (nekondenzující):
    - Provozní: 20% až 80%
    - Neprovozní: 20% až 80%
-



# Prenosný počítač TravelMate

## Stručná príručka

### Registrácia produktu

Pri prvom použití tohto produktu ho odporúčame bezodkladne zaregistrovať. Registráciou produktu získate prístup k ďalším výhodám, ako napríklad:

- Rýchlejšie poskytovanie služieb našimi skúsenými zástupcami.
- Členstvo v komunite Acer: informácie o rôznych akciách a účasť v zákazníckych prieskumoch.
- Najnovšie správy od spoločnosti Acer.

Neváhajte a zaregistrujte sa! Tieto i ďalšie výhody čakajú len na vás!

### Ako sa zaregistrovať

Na zaregistrovanie Vášho produktu od spoločnosti Acer navštívte stránku **www.acer.com**. Zvoľte svoju krajinu, kliknite na odkaz **REGISTRÁCIA PRODUKTU** a riadte sa jednoduchým návodom.

Výzva na registráciu produktu sa zobrazí aj počas procesu inštalácie, ale v prípade potreby môžete dvakrát kliknúť na ikonu Registrácia na ploche.

Po úspešnej registrácii produktu vám bude zaslaný potvrdzujúci email s dôležitými údajmi. Uchovajte si ich na bezpečnom mieste.

### Získanie príslušenstva spoločnosti Acer

S radosťou vám oznamujeme, že príslušenstvo pre prenosné počítače, ako aj program predĺženia záruky na produkty Acer sú Vám k dispozícii online. Navštívte náš internetový obchod na stránke **store.acer.com** a nájdite si tam všetko, čo potrebujete.

Internetový obchod spoločnosti Acer je momentálne v štádiu postupného rozširovania, preto sa môže stať, že v niektorých regiónoch nebude dostupný. V prípade neúspešného prístupu pravidelne kontrolujte dostupnosť stránky vo vašej krajine.

© 2012 Všetky práva vyhradené.

Stručná príručka pre prenosný počítač TravelMate  
Táto revízia: 07/2012

Číslo modelu: \_\_\_\_\_

Sériové číslo: \_\_\_\_\_

Dátum zakúpenia: \_\_\_\_\_

Miesto zakúpenia: \_\_\_\_\_

## Hneď na úvod

Radi by sme vám poďakovali za rozvoj prenosných počítačov Acer – vašej voľby pre svoje mobilné počítačové potreby.

## Vaše príručky

Aby sme vám pomohli s používaním prenosného počítača Acer, vytvorili sme pre vás sadu príručiek:

V prvom rade **plagát nastavenia**, ktorý vám pomôže začať s nastavením počítača.

Obsahom dokumentu **Stručná príručka** sú základné funkcie a vlastnosti vášho nového počítača.

Informácie o tom, ako vám počítač pomôže byť produktívnejší, nájdete v dokumente **Používateľská príručka**. **Používateľská príručka** obsahuje užitočné informácie týkajúce sa vášho nového počítača. Obsahuje základné témy, napríklad o používaní klávesnice a zvuku atď.

Táto príručka obsahuje podrobné informácie o systémových programoch, obnove údajov, možnostiach rozšírenia a riešenie problémov. Okrem toho obsahuje informácie o záruke a všeobecné vyhlásenia k predpisom a bezpečnosti.

Ak si chcete pozrieť jej obsah, postupujte podľa nasledovných krokov:





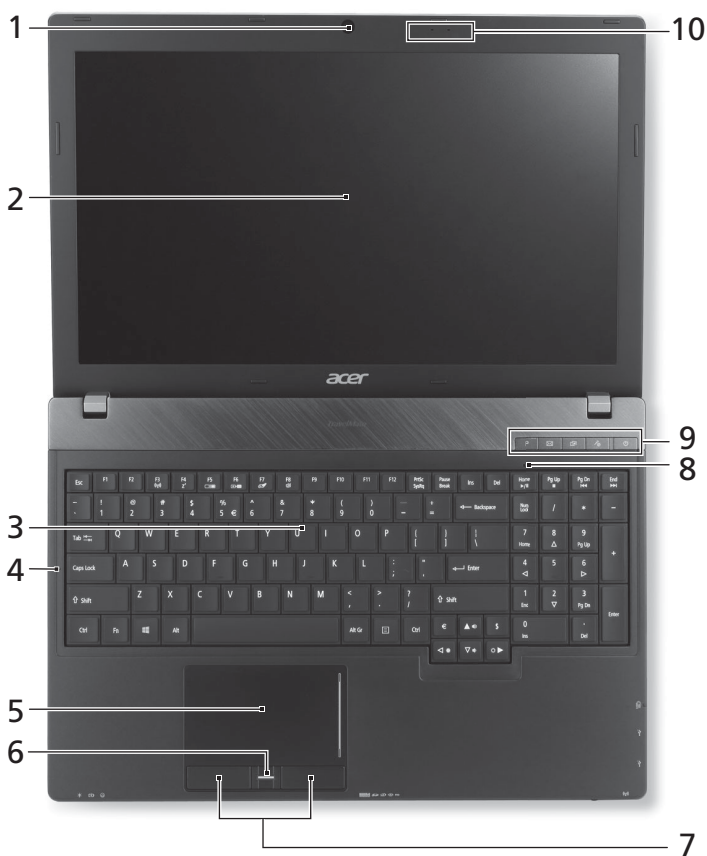

- 1 V ponuke **Štart** napíšte „Používateľ“.
- 2 Kliknite na tlačidlo **Používateľská príručka Acer**.

## Zoznámte sa so svojím prenosným počítačom Acer

Po nastavení počítača podľa letáku o nastavení nám dovoľte, aby sme vás zoznámili s vaším novým prenosným počítačom Acer.

### Pohľad zhora



#	Ikona	Položka	Popis
1		Zabudovaná webkamera	Webová kamera na video komunikáciu. <i>Kontrolka vedľa webkamery signalizuje, či je webkamera aktívna.</i>
2		Obrazovka	Nazýva sa tiež Liquid-Crystal Display (LCD), zobrazuje výstup z počítača (konfigurácia sa môže v závislosti od modelu líšiť).
3		Klávesnica	Slúži na zadávanie údajov do počítača.
4		Caps Lock	Svieti, keď je Caps Lock aktivovaný.
5		Dotyková plocha	Zariadenie s citlivosťou na dotyk, ktoré funguje ako počítačová myš.
6		Čítačka odtlačkov prstov	Čítačka odtlačkov prstov pre program Acer ProShield Security Suite.
7		Tlačidlá na klikanie (ľavé a pravé)	Funkcia ľavého a pravého tlačidla je podobná ako funkcia ľavého a pravého tlačidla myši.
8		Num Lock	Svieti, keď je Num Lock aktivovaný.
		Kláves P	Programovateľný kláves (konfigurácia sa môže v závislosti od modelu líšiť).
		Kláves Acer E-mail	Otvára predvolenú e-mailovú aplikáciu.
9		Kláves Zálohovať	Spúšťa aplikáciu Acer Backup Management pre zálohovanie údajov v troch krokoch.
		Stlmiť mikrofón	Stlmí mikrofón.
		Tlačidlo/kontrolka napájania	Zapína a vypína počítač. Signalizuje stav napájania počítača.
10		Mikrofóny	Dva interné mikrofóny na nahrávanie stereo zvuku.

## Klávesové skratky

Počítač využíva klávesové skratky alebo kombinácie klávesov na prístup k väčšine nastavení počítača, ako je napríklad jas obrazovky a hlasitosť výstupu.

Ak chcete aktivovať klávesové skratky, stlačte a podržte kláves **<Fn>** pred stlačením ďalšieho klávesu v klávesovej skratke.

Klávesová skratka	Ikona	Funkcia	Popis
<Fn> + <F3>		Komunikácia	Zapína a vypína komunikačné zariadenia počítača.
<Fn> + <F4>		Režim spánku	Prepne počítač do režimu spánku.
<Fn> + <F5>		Prepínanie zobrazenia	Prepína výstup zobrazenia – obrazovka, externý monitor (ak je pripojený) a obidva súčasne.
<Fn> + <F6>		Prázdna obrazovka	Vypína podsvietenie obrazovky kvôli úspore energie. Stlačením ľubovoľného klávesu vrátite.
<Fn> + <F7>		Prepínanie dotykovej plochy	Zapína a vypína internú dotykovú plochu.
<Fn> + <F8>		Prepínanie reproduktora	Zapína a vypína reproduktory.
<Fn> + <▷>		Zvýšenie jasu	Zvyšuje jas obrazovky.
<Fn> + <◁>		Zníženie jasu	Znižuje jas obrazovky.
<Fn> + <△>		Zvýšenie hlasitosti	Zvyšuje hlasitosť zvuku.
<Fn> + <▽>		Zníženie hlasitosti	Znižuje hlasitosť zvuku.
<Fn> + <Home>		Prehrať/ Pozastaviť	Prehrávanie alebo pozastavenie vybraného súboru média.
<Fn> + <Pg Up>		Zastaviť	Zastavenie prehrávania vybraného súboru média.
<Fn> + <Pg Dn>		Predchádzajúce	Návrat na predchádzajúci súbor média.
<Fn> + <End>		Nasledujúce	Preskočenie na nasledujúci súbor média.





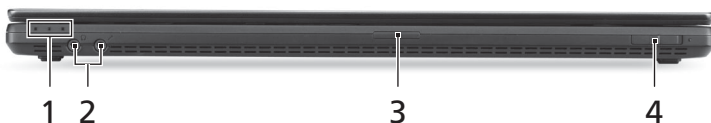

## Pohľad spredu (zatvorený)



#	Ikona	Položka	Popis
		Kontrolka napájania	Signalizuje stav napájania počítača.
1		Kontrolka batérie	Signalizuje stav batérie počítača. <b>1. Nabíjanie:</b> Pri nabíjaní batérie svieti žltá. <b>2. Nabité:</b> V režime AC svieti modrá.
		Kontrolka pevného disku	Svieti, keď je jednotka pevného disku aktívna.
2		Konektor mikrofónu	Slúži na vstup zvuku z externých mikrofónov.
		Konektor na slúchadlá/reproduktor	Pripojenie zvukových zariadení (napr. reproduktorov, slúchadiel).
3		Čítačka kariet Multi-in-1	Podporuje karty Secure Digital (SD), MultiMediaCard (MMC), Memory Stick PRO (MS PRO) a xD-Picture Card (xD). <b>Poznámka:</b> Stlačením vyťahnete/vložíte kartu. Nie je možné pracovať s viacerými kartami naraz.
4		Prepínač/kontrolka komunikácie	Aktivuje a deaktivuje komunikačné zariadenia počítača a signalizuje stav zariadenia na bezdrôtovú pripojenie počítača.

## Pohľad zľava



#	Ikona	Položka	Popis
1		Konektor vstupu jednosmerného napätia	Pripojenie adaptéra striedavého napätia.
2		Port HDMI	Podporuje pripojenia digitálneho videa s vysokým rozlíšením.
3		Port externej obrazovky (VGA)	Pripojenie zobrazovacieho zariadenia (napr. externého monitora, LCD projektora).
4		Port USB/eSATA	Pripojenie zariadení cez rozhranie USB alebo eSATA (len pre určité modely). <b>Poznámka:</b> Ak pripojíte zariadenie eSATA, budete mať k dispozícii tri porty rozhrania USB.
5		Zásuvka SmartCard	Je určená na kartu SmartCard.
6		Zásuvka ExpressCard/34	Určené pre modul ExpressCard/34. <b>Poznámka:</b> Stlačením vytiahnete/vložíte kartu.

## Pohľad sprava







#	Ikona	Položka	Popis
1		Port USB	Pripojenie zariadení USB.
2		Port USB	<i>Ak je port čierny, ide o rozhranie USB 2.0. Ak je port modrý, je tiež kompatibilný s rozhraním USB 3.0.</i>
3		Port USB s nabíjaním aj vo vypnutom stave	
4		Optická mechanika	Interná optická mechanika na CD alebo DVD disky.
5		Indikátor prístupu na optický disk	Svieti, keď je optická mechanika aktívna.
6		Tlačidlo vysúvania optickej mechaniky	Vysúva optický disk z jednotky.
7		Otvor núdzového vysúvania	Vysúva optickú mechaniku pri vypnutom počítači. <b>Poznámka:</b> Keď je počítač vypnutý, optickú jednotku vysuniete zasunutím kancelárskej sponky do núdzového otvoru.
8		Port siete Ethernet (RJ-45)	Pripojenie k sieti Ethernet 10/100/1000.
9		Zásuvka na zámok Kensington	Pripojenie počítačového bezpečnostného kľúča Kensington. <b>Poznámka:</b> Pripojte kábel bezpečnostného zámku počítača k nepohyblivému predmetu, napríklad stolu alebo držadlu zaistenej zásuvky. Vložte zámok do otvoru a otočte kľúčom kvôli zaisteniu zámku. Niektoré modely sú dostupné aj bez zámku.

## Informácie o USB 3.0

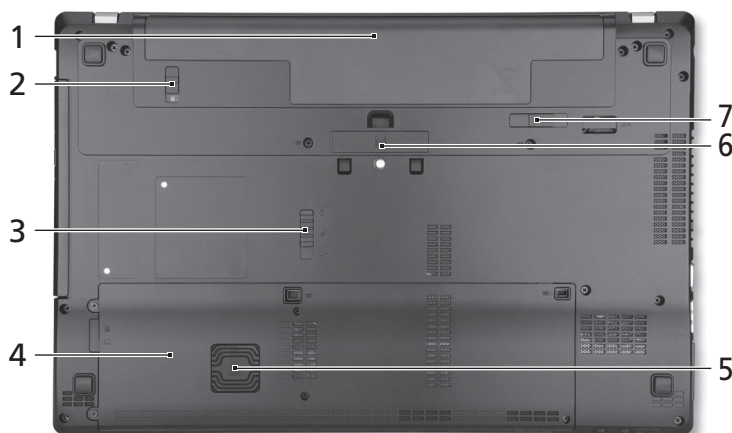
- Kompatibilné so zariadeniami USB 3.0 a staršími.
- Optimálny výkon sa dosiahne pri použití so zariadeniami s certifikátom na USB 3.0.
- Definované podľa normy USB 3.0 (SuperSpeed USB).

## Pohľad zdola



#	Ikona	Položka	Popis
1		Jednotka batérie	Slúži na uloženie batérie počítača.
2		Zámok batérie	Uzamyká batériu na jej mieste.
3		Západka uvoľnenia Acer MediaBay	Slúži na uvoľnenie modulu Acer MediaBay.
4		Jednotka pevného disku	Slúži na uchytienie pevného disku počítača (zaistené skrutkou).
		Pozícia pre pamäť	Tu je uložená hlavná pamäť počítača.
5		Acer DASP (ochrana disku proti otrasom)	Chráni jednotku pevného disku pred otrasmi a nárazmi.
6		Konektor zariadenia Acer ProDock	Slúži na pripojenie k voliteľnému zariadeniu Acer ProDock.
7		Západka uvoľnenia batérie	Slúži na uvoľnenie batérie pri jej vyberaní.

## Prostredie

---

- Teplota:
    - Prevádzková: 5°C až 35°C
    - Mimoprevádzková: -20°C až 65°C
  - Vlhkosť (nekondenzačná):
    - Prevádzková: 20% až 80%
    - Mimoprevádzková: 20% až 80%
-



# Prenosnik TravelMate

## Hitri vodič

### Registracija izdelka

Ob prvi uporabi izdelka priporočamo takojšnjo registracijo. S tem boste pridobili dostop do nekaj ugodnosti, kot so:

- Hitrejše storitve pomoči s strani naših usposobljenih zastopnikov.
- Članstvo v skupnosti Acer: prejemajte ponudbe in sodelujte v anketah za stranke.
- Novosti iz podjetja Acer.

Pohitite in se registrirajte, saj vas čakajo tudi druge ugodnosti!

### Kako se registrirati

Če želite registrirati svoj izdelek Acer, prosimo obiščite **www.acer.com**. Izberite državo, kliknite na **REGISTRACIJA IZDELKA** in sledite preprostim navodilom.

Na registracijo izdelka vas bomo opomnili med postopkom namestitve, lahko pa dvokliknete tudi ikono Registracija na namizju.

Po izvedbi registracije vašega izdelka vam bomo poslali e-poštno sporočilo s potrdilom in pomembnimi podatki, ki jih morate shraniti na varno.

### Nakup dodatkov Acer

Veseli nas, da vas lahko obvestimo, da so program podaljšanja garancije in dodatki za prenosnik Acer na voljo preko spleta. Pridite in obiščite našo spletno trgovino in preverite, kaj potrebujete na **store.acer.com**.

Trgovino Acer razvijamo postopoma, zato v nekaterih regijah na žalost še ni na voljo. Prosimo redno preverjajte, ali je trgovina za vašo državo že na voljo.

© 2012 Vse pravice pridržane.

Hitri vodič za prenosnik TravelMate

Ta različica: 07/2012

Številka modela: \_\_\_\_\_

Serijska številka: \_\_\_\_\_

Datum nakupa: \_\_\_\_\_

Mesto nakupa: \_\_\_\_\_



## Začnimo pri začetku

Želimo se vam zahvaliti, ker ste za zadovoljevanje prenosnih računalniških potreb izbrali prenosnik Acer.

## Vaša navodila

Za pomoč pri uporabi vašega prenosnika Acer, smo izdelali paket navodil:

**Namestitveni plakat** vam bo pomagal pri nastavitvi vašega računalnika.

**Hitri vodnik** vsebuje osnovne funkcije vašega novega računalnika.

Za več informacij o tem, kako vam lahko računalnik pomaga postati bolj produktivni, si oglejte **Uporabniški priročnik**. **Uporabniški priročnik** vsebuje uporabne informacije o vašem novem računalniku. Priročnik opisuje osnovne teme, kot so uporaba tipkovnice in zvočnih nastavitev itd.

Ta navodila vsebujejo podrobne informacije o sistemskih pripomočkih, obnovi podatkov, možnostih razširitve in odpravljanju težav. Poleg tega vsebuje garancijske informacije in splošne uredbe in varnostna obvestila za vaš prenosnik.

Da bi ga našli, sledite naslednjim korakom:

- 1 V meniju *Start* vnesite besedo „User“.
- 2 Kliknite na **Uporabniški priročnik Acer**.



## Predstavitev vašega prenosnika Acer

Ko ste nastavili računalnik, kot je prikazano na plakatu z navodili za nastavitve, dovolite, da vam predstavimo vaš novi prenosnik Acer.

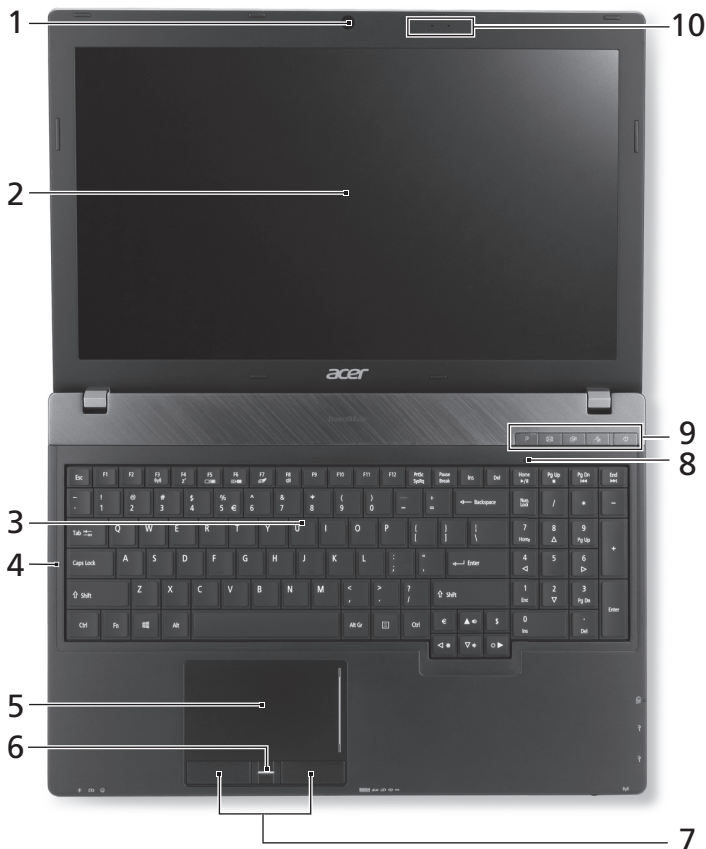
### Pogled od zgoraj















#	Ikona	Predmet	Opis
1		Integrirana spletna kamera	Spletna kamera za videokomunikacijo. <i>Lučka ob spletni kameri kaže, da je ta dejavna.</i>

#	Ikona	Predmet	Opis
2		Zaslon	Zaslon s tekočimi kristali (LCD) prikazuje izhodni signal vašega računalnika (konfiguracija se lahko pri posameznih modelih razlikuje).
3		Tipkovnica	Za vnos podatkov v računalnik.
4		Caps Lock	Zasveti, ko je tipka Caps Lock aktivna.
5		Sledilna plošča	Na dotik občutljiva naprava, ki deluje kot računalniška miška.
6		Čitalec prstnih odtisov	Čitalec prstnih odtisov za aplikacijo Acer ProShield Security Suite.
7		Gumbi miške (levi in desni)	Leva in desna tipka delujejo kot leva in desna tipka na miški.
8		Num Lock	Zasveti, ko je tipka Num Lock aktivna.
		Tipka P	Programljiva tipka (konfiguracija se lahko pri posameznih modelih razlikuje).
		E-poštni tipka Acer	Odpre privzeto aplikacijo za e-pošto.
9		Tipka za varnostno kopiranje	Zagon aplikacije Acer Backup Management za varnostno kopiranje podatkov v treh korakih.
		Utišanje mikrofona	Utiša mikrofona.
		Indikator/gumb za vklop/izklop	Vklop in izklop računalnika. Označuje stanje napajanja računalnika.
10		Mikrofoni	Dva notranja mikrofona za snemanje zvoka stereo.

## Bližnjične tipke

Računalnik uporablja bližnjice ali kombinacijo tipk za dostop do računalniških nastavitev kot sta svetlost zaslona in glasnost.





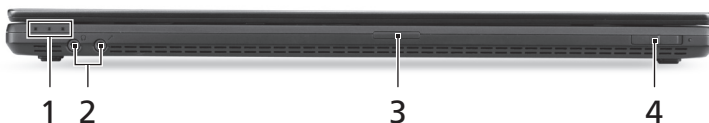

Za aktivacijo bližnjic pritisnite in držite tipko **<Fn>** in nato pritisnite drugo tipko v kombinaciji bližnjice.

Bližnjica	Ikona	Funkcija	Opis
<b>&lt;Fn&gt; + &lt;F3&gt;</b>		Komunikacije	Omogoči/onemogoči komunikacijske naprave računalnika.
<b>&lt;Fn&gt; + &lt;F4&gt;</b>		Način mirovanja	Preklopi računalnik v način mirovanja.
<b>&lt;Fn&gt; + &lt;F5&gt;</b>		Preklop zaslona	Preklopi izhod zaslona med zaslonom, zunanjim monitorjem (če je priključen) in obema.
<b>&lt;Fn&gt; + &lt;F6&gt;</b>		Prazen zaslon	Izključi osvetlitev ozadja zaslona za namene varčevanja z energijo. Za ponovno vključitev pritisnite katero koli tipko.
<b>&lt;Fn&gt; + &lt;F7&gt;</b>		Preklapljanje sledilne tablice	Vključi in izključi notranjo sledilno ploščo.
<b>&lt;Fn&gt; + &lt;F8&gt;</b>		Preklop zvočnikov	Vklop in izklop zvočnikov.
<b>&lt;Fn&gt; + &lt;▷&gt;</b>		Povečanje svetlosti	Poveča svetlost zaslona.
<b>&lt;Fn&gt; + &lt;◁&gt;</b>		Zmanjšanje svetlosti	Zmanjša svetlost zaslona.
<b>&lt;Fn&gt; + &lt;△&gt;</b>		Povečanje glasnosti	Poveča glasnost zvoka.
<b>&lt;Fn&gt; + &lt;▽&gt;</b>		Zmanjšanje glasnosti	Zmanjša glasnost zvoka.
<b>&lt;Fn&gt; + &lt;Home&gt;</b>		Predvajaj/napravi premor	Predvaja ali zaustavi izbrano medijsko datoteko.
<b>&lt;Fn&gt; + &lt;Pg Up&gt;</b>		Zaustavi	Zaustavi predvajanje izbrane medijske datoteke.
<b>&lt;Fn&gt; + &lt;Pg Dn&gt;</b>		Predhodna	Vrnitev na predhodno medijsko datoteko.

Bližnjica	Ikona	Funkcija	Opis
<Fn> + <End>		Naprej	Skok na naslednjo medijsko datoteko.





## Zaprto pogled od spredaj



#	Ikona	Predmet	Opis
		Indikator stanja napajanja	Označuje stanje napajanja računalnika.
1		Indikator stanja baterije	Označuje stanje baterije računalnika. <b>1. Polnjenje:</b> Lučka sveti rumenkasto rjavo, ko se baterija polni. <b>2. Baterija je polna:</b> V načinu AC lučka sveti modro.
		Indikator trdega diska	Označuje, ko je trdi disk aktiven.
2		Vhod za mikrofonski	Sprejema vhode z zunanjih mikrofonskih.
		Vtičnica za slušalke/zvočnik	Omogoča priključitev zvočnih naprav (npr. zvočnikov ali slušalk).
3		Bralnik kartic več-v-1	Za kratice Secure Digital (SD), MultiMediaCard (MMC), Memory Stick Pro (MS PRO) in xD Picture Card (xD). <b>Opomba:</b> Potisnite kartico v režo, da bi jo vstavili ali odstranili. Naenkrat lahko uporabljate le eno kartico.
4		Stikalo/pokazatelj komunikacijskih naprav	Omogoči/onemogoči komunikacijske naprave računalnika/Označuje stanje naprave za brezžično povezavo.





## Pogled z leve



#	Ikona	Predmet	Opis
1		Priključek napajalnika	Priključek na napajalnik.
2		Vhod HDMI	Podpira priključke za visokoločljivostni digitalni video.
3		Vhod za zunanji zaslon (VGA)	Priključitev na prikazovalno napravo (npr. zunanji monitor, projektor LCD).
4		Vrata USB/eSATA	Priključek za naprave USB ali eSATA (le na določenih modelih). <b>Opomba:</b> Če napravo priključite na vhod eSATA, boste imeli na razpolago tri proste vhode USB.
5		Reža za SmartCard	Čita kartice SmartCard.
6		Reža za ExpressCard/34	Sprejme en modul ExpressCard/34. <b>Opomba:</b> Potisnite kartico v režo, da bi jo odstranili ali vstavili.

## Pogled z desne







#	Ikona	Predmet	Opis
1		Vrata USB	
2		Vrata USB	Priključek za naprave USB. Črni vhod pomeni združljivost z USB 2.0, modri vhod pa združljivost tudi z USB 3.0.
3		Vrata USB za polnjenje brez priključenega napajanja	
4		Optični pogon	Vgrajeni optični pogon za branje CD-jev in DVD-jev.
5		Pokazatelj dostopa do optičnega diska	Zasveti, ko je optični pogon aktiven.
6		Tipka optičnega pogona za izmet	Izvrže optični disk iz pogona.
7		Luknja za izmet v nujnih primerih	Izvrže pladenj optičnega pogona, ko je računalnik izključen. <b>Opomba:</b> Vstavite sponko v luknjo za izvržbo v nujnem primeru, da izvržete pladenj optičnega pogona, ko je računalnik izključen.
8		Priključek Ethernet (RJ-45)	Priključek na omrežja Ethernet 10/100/1000.
9		Reža za zaklep Kensington	Priključek za računalniško ključavnico, združljivo s standardom Kensington. <b>Opomba:</b> Kabel varnostne ključavnice ovijte okoli nepremičnega predmeta, kot je miza ali ročaj zaklenjenega predala. Ključavnico vstavite v vdolbino in obrnite ključ, da bi jo zaklenili. Na voljo so tudi nekateri modeli brez ključev.

## Informacije o vhodu USB 3.0

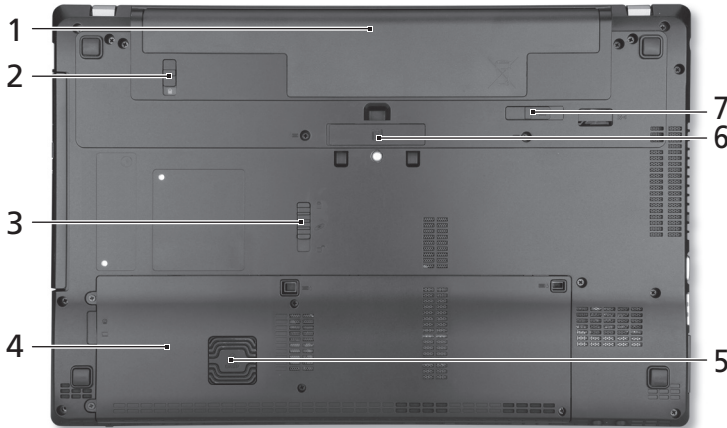
- Združljivo z napravami USB 3.0 in starejšimi različicami USB.
- Za optimalno delovanje uporabite naprave USB 3.0.
- Njegove tehnične lastnosti opredeljuje standard različice USB 3.0 (SuperSpeed USB).

## Pogled od spodaj



#	Ikona	Predmet	Opis
1		Predel za baterijo	Hrani baterijo računalnika.
2		Zaklep za baterijo	Zaklene baterijo na mesto.
3		Zaponka za Acer MediaBay	Sprosti modul Acer MediaBay.
4		Nosilec trdega diska	Hrani trdi disk računalnika (pričvrščeno z vijaki).
		Reža pomnilnika	Hrani glavni pomnilnik računalnika.
5		Acer DASP (zaščita za disk pred udarci)	Ščiti pogon trdega diska pred udarci in sunki.
6		Priključek Acer ProDock	Je namenjen povezavi z izbirnim Acer ProDock.
7		Zapah za odpenjanje baterije	Odklene baterije, da bi jo lahko odstranili.



## Okolje

---

- Temperatura:
    - Delovanje: Od 5°C do 35°C
    - Mirovanje: Od -20°C do 65°C
  - Vlažnost (brez kondenza):
    - Delovanje: Od 20% do 80%
    - Mirovanje: Od 20% do 80%
-



# TravelMate prijenosno računalo

## Kratki vodič

### Registracija proizvoda

Preporučujemo registraciju proizvoda kojeg ste kupili već prilikom prve uporabe. Tako će vam biti dostupne mnoge korisne usluge, kao primjerice:

- Brža usluga koju pružaju naši obučeni predstavnici.
- Članstvo u Acer zajednici: primanje promotivnih materijala i sudjelovanje u ispitivanju zadovoljstva kupaca.
- Najnovije vijesti iz Acera.

Požurite i registrirajte se jer vas čekaju i druge pogodnosti!

### Kako se registrirati

Da biste registrirali Acer proizvod koji koristite, posjetite **www.acer.com**. Odaberite vašu državu, kliknite na **REGISTRACIJA PROIZVODA** i slijedite jednostavne upute.

Upit za registraciju proizvoda koji koristite dobit ćete i prilikom postupka podešavanja ili registraciju pokrenite dvoklikom na ikonu Registracija na radnoj površini.

Nakon što primimo vašu registraciju, elektroničkom poštom poslat ćemo vam potvrdnu poruku s važnim podacima koje trebate čuvati na sigurnom mjestu.

### Nabavka Acer pribora

Zadovoljstvo nam je obavijestiti vas da je Acerov program produljenog jamstva i pribor za prijenosnike dostupan i mrežno. Posjetite našu mrežnu trgovinu i potražite ono što vam je potrebno na adresi **store.acer.com**.

Acer trgovina stalno se razvija i nudi nove proizvode no nažalost nije dostupna u nekim državama. Redovito provjeravajte je li trgovina postala dostupna i u vašoj državi.

© 2012 Sva prava pridržana.

Kratki vodič za TravelMate prijenosno računalo  
Ova izmjena: 07/2012

Broj modela: \_\_\_\_\_

Serijski broj: \_\_\_\_\_

Datum kupnje: \_\_\_\_\_

Mjesto kupovine: \_\_\_\_\_

## Krenimo od početka

Željeli bismo vam zahvaliti na izboru Acer prijenosnog računala koje će vam poslužiti kamo god krenuli.

## Vaši priručnici

Da bismo vam pomogli pri uporabi vašeg Acer prijenosnog računala, pripremili smo nekoliko priručnika:

Prvenstveno **poster za podešavanje** pomaže u postavljanju početnih postavki vašeg računala.

**Kratki vodič** upoznaje vas s osnovnim obilježjima i funkcijama vašeg novog računala.

Više informacija o tome kako vam računalo može povećati produktivnost, naći ćete u **korisničkom priručniku**. **Korisnički priručnik** sadrži korisne informacije o uporabi vašeg novog računala. Priručnik obuhvaća osnovne teme poput uporabe tipkovnice, zvuka, i sl.

Priručnik sadrži detaljne informacije o temama kao što su uslužni programi sustava, vraćanje podataka, opcije za proširivanje i rješavanje problema. Uz to sadrži i podatke o jamstvu i općim uvjetima te sigurnosne upute za vaše prijenosno računalo.

Za pristup priručniku, učinite sljedeće:

- 1 U izbornik *Početak* unesite "Korisnik".
- 2 Kliknite na **Acer korisnički priručnik**.





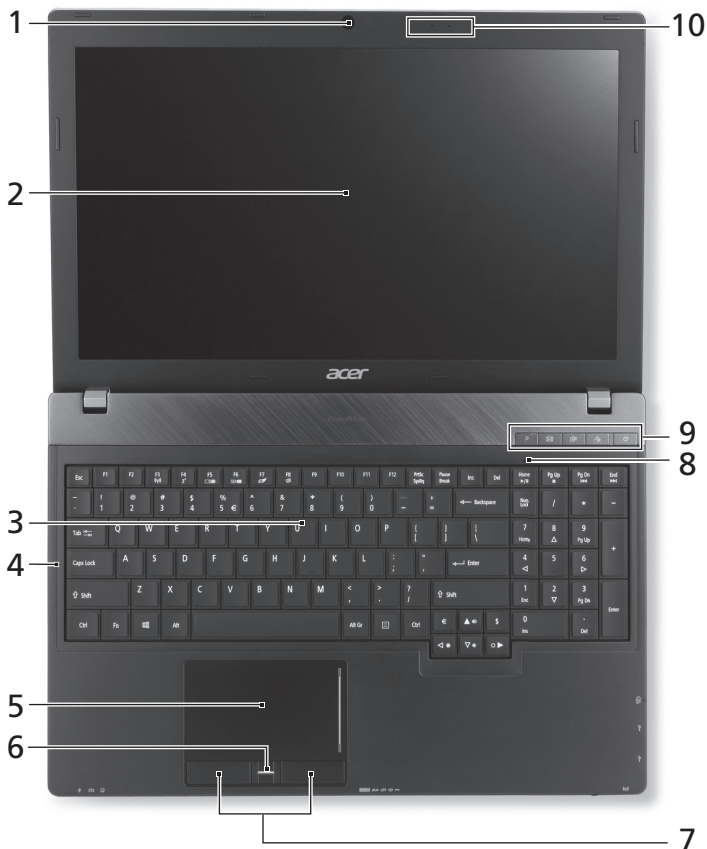

## Upoznajte Acer prijenosnik

Nakon postavljanja vašeg računala kao što je prikazano posterom, upoznajte vaše novo Acer prijenosno računalo.

### Pogled odozgo





#	Ikona	Stavka	Opis
1		Ugrađena web kamera	Web kamera za video komunikaciju. <i>Svjetlo pokraj web kamere pokazuje da je web kamera aktivna.</i>

#	Ikona	Stavka	Opis
2		Zaslon	Također nazivan i Liquid-Crystal Display (LCD), prikazuje izlaz računala (Konfiguracija se može razlikovati ovisno o modelu).
3		Tipkovnica	Za unos podataka u vaše računalo.
4		Caps Lock	Svijetli kada je Caps Lock aktiviran.
5		Dodirna ploča	Pokazivački uređaj osjetljiv na dodir koji funkcionira kao računalni miš.
6		Čitač otiska prsta	Čitač otiska prsta za Acer ProShield Security Suite.
7		Tipke za odabir (lijeva i desna)	Lijeva i desna tipka djeluju kao lijeva i desna tipka miša.
8		Num Lock	Svijetli kada je Num Lock aktiviran.
		P tipka	Programabilni ključ (konfiguracija se može razlikovati ovisno o modelu).
		Tipka za Acer e-poštu	Otvora vašu zadanu aplikaciju za e-poštu.
9		Tipka za sigurnosnu kopiju	Pokreće Acer Backup Management za sigurnosno kopiranje podataka u tri koraka.
		Utišavanje mikrofona	Utišava mikrofon.
		Tipka za uključivanje/indikator	Uključuje i isključuje računalo. Pokazuje stanje napajanja računala.
10		Mikrofoni	Dva unutarnja mikrofona za stereo snimanje zvuka.



## Tipkovnički prečaci

Računalo koristi tipkovničke prečace ili kombinacije tipki za pristup većini upravljačkih tipki računala, kao što je osvjetljenost zaslona i izlazna glasnoća.

Za aktiviranje tipkovničkih prečaca, pritisnite i držite **<Fn>** tipku prije pritiska druge tipke u kombinaciji tipkovničkog prečaca.







Tipkovnički prečac	Ikona	Funkcija	Opis
<b>&lt;Fn&gt; + &lt;F3&gt;</b>		Komunikacija	Omoгуćava/onemogućava komunikacijske uređaje računala.
<b>&lt;Fn&gt; + &lt;F4&gt;</b>		Stanje mirovanja	Stavlja računalo u stanja mirovanja.
<b>&lt;Fn&gt; + &lt;F5&gt;</b>		Prekidač prikaza	Prebacuje izlaz prikaza između zaslona prikaza, vanjskog monitora (ako je priključen) i oba.
<b>&lt;Fn&gt; + &lt;F6&gt;</b>		Prazan zaslon	Isključuje pozadinsko osvjetljenje zaslona prikaza radi uštede energije. Pritisnite bilo koju tipku za povrat.
<b>&lt;Fn&gt; + &lt;F7&gt;</b>		Prekidač dodirne ploče	Uključuje i isključuje unutarnju dodirnu ploču.
<b>&lt;Fn&gt; + &lt;F8&gt;</b>		Prekidač zvučnika	Uključuje i isključuje zvučnike.
<b>&lt;Fn&gt; + &lt;D&gt;</b>		Pojaćanje svjetline	Povećava osvjetljenost zaslona.
<b>&lt;Fn&gt; + &lt;D&gt;</b>		Smanjivanje osvjetljenosti	Smanjuje osvjetljenost zaslona.
<b>&lt;Fn&gt; + &lt;A&gt;</b>		Pojaćavanje glasnoće	Pojaćava glasnoću zvuka.
<b>&lt;Fn&gt; + &lt;V&gt;</b>		Smanjivanje glasnoće	Smanjuje glasnoću zvuka.
<b>&lt;Fn&gt; + &lt;Home&gt;</b>		Reprodukcija/stanka	Izvodi ili zaustavlja izvođenje odabrane medijske datoteke.
<b>&lt;Fn&gt; + &lt;Pg Up&gt;</b>		Zaustavi	Zaustavlja izvođenje odabrane medijske datoteke.

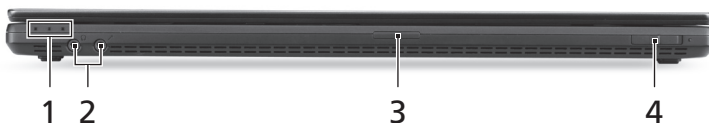

Tipkovnički prečac	Ikona	Funkcija	Opis
<Fn> + <Pg Dn>		Prethodna	Povrat na prethodnu medijsku datoteku.
<Fn> + <End>		Sljedeća	Skok na sljedeću medijsku datoteku.





## Pogled sprijeda izbliza



#	Ikona	Stavka	Opis
		Indikator napajanja	Pokazuje stanje napajanja računala.
1		Indikator baterije	Pokazuje stanje baterije računala. <b>1. Punjenje:</b> Svijetli žuto kada se baterija puni. <b>2. Sasvim napunjeno:</b> Svijetli plavo kada radi na izmjeničnom napajanju.
		HDD indikator	Pokazuje kada je pogon čvrstog diska aktivan.
2		Utičnica za mikrofon	Prihvća ulaze iz vanjskih mikrofona.
		Utičnica za slušalice/zvučnik	Povezuje audio uređaje (primjerice zvučnike, slušalice).
3		Više-u-1 čitač kartica	Prihvća Secure Digital (SD), MultiMediaCard (MMC), Memory Stick PRO (MS PRO), xD-Picture Card (xD) kartice. <b>Napomena:</b> Gurnite za uklanjanje/postavljanje kartice. Istodobno je moguće koristiti samo jednu karticu.
4		Sklopka/indikator komunikacije	Omogućuje/onemogućuje komunikacijske uređaje računala/označava status bežičnog spajanja računala.





## Pogled s lijeve strane



#	Ikona	Stavka	Opis
1		DC-in utičnica	Povezuje se s AC adapterom.
2		HDMI ulaz	Podržava veze digitalnog videa visoke definicije.
3		Priključak vanjskog ekrana (VGA)	Povezuje se s uređajem za prikaz (primjerice vanjskim monitorom, LCD projektorom).
4		USB/eSATA priključak	Povezuje USB ili eSATA uređaje (samo za određene modele). <b>Napomena:</b> Ako priključite eSATA uređaj, imat ćete dostupna tri USB priključka.
5		SmartCard utor	Prihvaća SmartCard.
6		ExpressCard/34 utor	Prihvaća jedan ExpressCard/34 modul. <b>Napomena:</b> Gurnite za uklanjanje/umetanje kartice.

## Pogled s desne strane







#	Ikona	Stavka	Opis
1		USB priključak	Povezuje USB uređaje.
2		USB priključak	<i>Ako je vaš priključak crne boje on je kompatibilan sa USB 2.0, ako je plave boje kompatibilan je i sa USB 3.0.</i>
3		USB priključak za punjenje u isključenom stanju	
4		Optički pogon	Unutarnji optički pogon; prihvaća CD-e ili DVD-e.
5		Indikator pristupa optičkom disku	Svijetli kada je optički pogon aktivan.
6		Tipka za izbacivanje optičkog pogona	Izbacuje optički disk iz pogona.
7		Otvor za izbacivanje u slučaju nužde	<b>Napomena:</b> Umetnite spajalicu za papir u otvor za izbacivanje u slučaju nužde kako bi izbacili ladicu optičkog pogona kada je računalo isključeno.
8		Ethernet (RJ-45) priključak	Povezuje se na Ethernet 10/100/1000-baziranu mrežu.
9		Utor za Kensington bravu	Povezuje se s Kensington-kompatibilnom računalnom sigurnosnom bravom. <b>Napomena:</b> Omotajte kabel sigurnosne brave računala oko nepokretnog objekta kao što je stol ili ručka zaključane ladice. Umetnite bravu u utor i okrenite ključ kako bi osigurali bravu. Dostupni su i neki modeli bez ključa.

## Informacije o USB 3.0

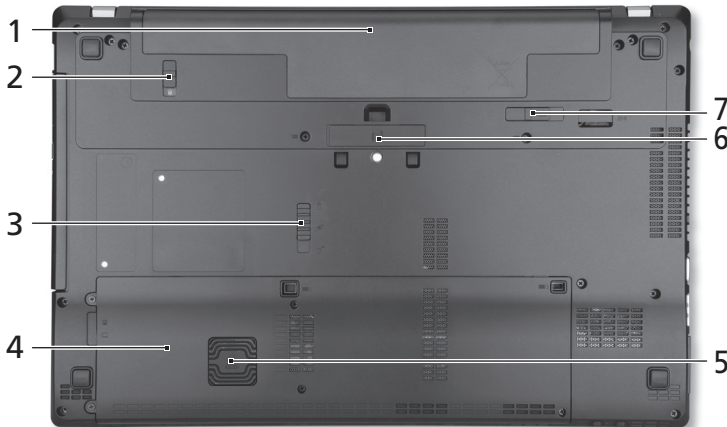
- Kompatibilno s USB 3.0 i starijim USB uređajima.
- Za najbolja radna svojstva, koristite uređaje s USB 3.0 potvrdom.
- Definirano USB 3.0 (SuperSpeed USB) specifikacijom.

## Pogled odozdo



#	Ikona	Stavka	Opis
1		Prostor za bateriju	Sadrži baterijski komplet računala.
2		Brava baterije	Zaključava bateriju u njen položaj.
3		Acer MediaBay zasun za oslobađanje	Oslobađa Acer MediaBay modul.
4		Prostor za čvrsti disk	Sadrži tvrdi disk računala (učvršćen vijcima).
		Odjeljak za memoriju	Sadrži glavnu memoriju računala.
5		Acer DASP (zaštita diska od šokova)	Štiti pogon tvrdog diska od potresa i udara.
6		Acer ProDock priključnica	Povezuje dodatni Acer ProDock.
7		Bravica za oslobađanje baterije	Oslobađa bateriju radi uklanjanja.

## Okruženje

---

- Temperatura:
    - Radna: 5°C do 35°C
    - Pohrana: -20°C do 65°C
  - Vlažnost (nekondenzirajuća):
    - Radna: 20% do 80%
    - Pohrana: 20% do 80%
-



# Computer portabil TravelMate

## Ghid rapid

### Înregistrarea produsului

Este recomandabil să înregistrați computerul la prima utilizare. Astfel, veți beneficia de anumite avantaje, cum ar fi:

- Deservire mai rapidă din partea reprezentanților noștri.
- Calitatea de membru în comunitatea Acer: profitați de promoții și participați la studii de piață.
- Noutăți de la Acer.

Înregistrați-vă acum și beneficiați și de alte avantaje!

### Mod de înregistrare

Pentru înregistrarea produsului Acer, vizitați **www.acer.com**. Selectați-vă țara, faceți clic pe **ÎNREGISTRAREA PRODUSULUI** și urmați instrucțiunile simple.

Veți fi invitat să vă înregistrați produsul în timpul procesului de configurare sau puteți face dublu clic pe pictograma Înregistrare de pe desktop.

După primirea înregistrării produsului dumneavoastră, vă vom trimite un mesaj de confirmare cu informații importante, pe care vă recomandăm să le păstrați într-un loc sigur.

### Obținerea accesoriilor Acer

Ne face plăcere să vă informăm că programul de extindere a garanției Acer și accesoriile pentru computere portabile sunt disponibile online. Vizitați magazinul nostru online și găsiți tot ce aveți nevoie la **store.acer.com**.

Magazinul Acer este lansat progresiv și, din păcate, s-ar putea să nu fie disponibil în unele regiuni. Reveniți periodic pentru a vedea când va fi disponibil în țara dvs.

© 2012 Toate drepturile rezervate.

Ghid rapid al computerului portabil TravelMate  
Această ediție: 07/2012

Numărul modelului: \_\_\_\_\_

Numărul seriei: \_\_\_\_\_

Data cumpărării: \_\_\_\_\_

Locul achiziției: \_\_\_\_\_



## Înainte de toate

Dorim să vă mulțumim că ați ales un computer portabil Acer pentru a răspunde nevoilor dvs. de procesare mobilă.

## Ghidurile dumneavoastră

Pentru a vă ajuta să folosiți computerul portabil Acer, am conceput un set de ghiduri:

Primul dintre acestea, **Posterul de configurare** vă ajută să începeți configurarea computerului.

**Ghidul rapid** tipărit vă prezintă caracteristicile și funcțiile de bază ale noului dvs. computer.

Pentru mai multe informații privind modul în care computerul vă poate ajuta să fiți mai productiv, consultați **Manualul de utilizare**. **Manualul de utilizare** conține informații utile valabile pentru noul dvs. computer. Acoperă subiecte cum ar fi folosirea tastaturii, a sistemului audio etc.

Acest ghid conține informații detaliate despre astfel de subiecte, precum utilitarele de sistem, recuperarea datelor, opțiunile de extensie și depanarea. În plus, acesta conține informații despre garanție, reglementări generale și note de siguranță pentru computerul dvs portabil.

Urmați acești pași pentru a-l accesa:

- 1 Tastați „User” din meniul *Start*.
- 2 Dați clic pe **Manualul de utilizare Acer**.





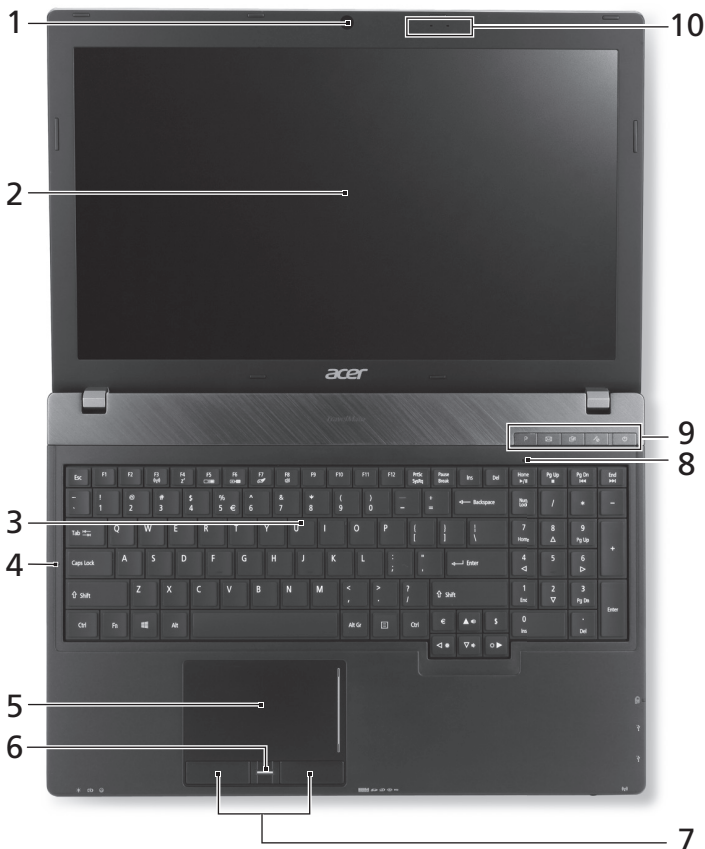

## Turul computerului dvs. Acer

După configurarea computerului, așa cum se arată în afișul de configurare, permiteți-ne să vă prezentăm noul dvs. computer portabil Acer.

### Vedere de sus



#	Pictogramă	Element	Descriere
1		Camăra Web integrată	Camăra Web pentru comunicare video. <i>Indicatorul luminos de lângă camera Web indică faptul că aceasta este activă.</i>

#	Pictogramă	Element	Descriere
2		Ecran	Mai este numit și Afișaj cu cristale lichide (LCD) și afișează activitatea computerului (configurația poate diferi în funcție de model).
3		Tastatură	Pentru introducerea datelor în computer.
4		Caps Lock	Se aprinde când tasta Caps Lock este activată.
5		Zona de atingere	Dispozitiv de indicare sensibil la atingere care funcționează ca un maus de computer.
6		Cititor de amprente	Cititor de amprente pentru Acer ProShield Security Suite.
7		Butoane clic (stânga și dreapta)	Butoanele stânga și dreapta funcționează ca butoanele stânga și dreapta ale mouse-ului.
8		Num Lock	Se aprinde când tasta Num Lock este activată.
9		Tastă P	Tastă programabilă (configurația poate diferi în funcție de model).
		Tastă e-mail Acer	Deschide aplicația dvs. implicită pentru e-mail.
		Tastă pentru copie de siguranță	Lansează Acer Backup Management pentru copierea de siguranță în trei pași a datelor.
		Dezactivare microfon	Dezactivează microfonul.
		Indicator/buton de alimentare cu energie a computerului	Pornește și oprește computerul. Indică nivelul de alimentare al computerului.
10		Microfoane	Două microfoane interne pentru înregistrarea stereo a sunetului.

## Taste rapide

Computerul folosește tastele rapide sau combinațiile de taste pentru a accesa majoritatea comenzilor precum luminozitatea ecranului și volumul.





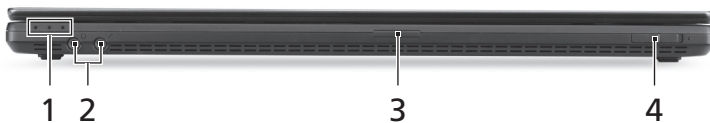

Pentru a activa tastele rapide, apăsați și mențineți tasta **<Fn>** înainte de a apăsa cealaltă tastă din combinația de tastă rapidă.

Tastă rapidă	Pictogramă	Funcție	Descriere
<Fn> + <F3>		Comunicații	Activează/dezactivează dispozitivele de comunicație ale computerului.
<Fn> + <F4>		Repaus	Pune computerul în modul Repaus.
<Fn> + <F5>		Comutare afișaj	Comută afișajul între ecran de afișaj, monitor extern (dacă este conectat) și ambele.
<Fn> + <F6>		Ecran gol	Oprește lumina de fundal a ecranului pentru a economisi energie. Apăsați orice tastă pentru reveni.
<Fn> + <F7>		Comutare zonă de atingere	Activează și dezactivează zona de atingere.
<Fn> + <F8>		Comutare difuzor	Pornește și oprește difuzoarele.
<Fn> + <D>		Luminozitate mărită	Mărește luminozitatea afișajului.
<Fn> + <D>		Luminozitate scăzută	Reduce luminozitatea afișajului.
<Fn> + <Δ>		Volum mărit	Mărește volumul sunetului.
<Fn> + <▽>		Volum scăzut	Reduce volumul sunetului.
<Fn> + <Home>		Redare/Pauză	Redă sau oprește temporar fișierul media selectat.
<Fn> + <Pg Up>		Opire	Oprește redarea fișierului media selectat.
<Fn> + <Pg Dn>		Anterior	Revine la fișierul media anterior.

Tastă rapidă	Pictogramă	Funcție	Descriere
<Fn> + <End>		Următorul	Trece la următorul fișier media.





## Vedere din față închis



#	Pictogramă	Element	Descriere
		Indicator de alimentare cu energie	Indică nivelul de alimentare al computerului.
1		Indicator baterie	Indică starea bateriei computerului. <b>1. Încărcare:</b> Lumina este galbenă când acumulatorul se încarcă. <b>2. Complet încărcat:</b> Lumina este albastră în modul c.a.
		Indicator HDD	Indică dacă unitatea de hard disc este activă.
2		Mufă microfon	Acceptă intrări de la microfoane externe.
		Căști pentru căști/difuzoare	Conectează la dispozitivele audio (de ex. difuzoare, căști).
3		Cititor de cartele multi-in-1	Acceptă carduri Secure Digital (SD), MultiMediaCard (MMC), Memory Stick PRO (MS PRO) și xD-Picture Card. <b>Notă:</b> Apăsați pentru a extrage/a instala cardul. Poate funcționa un singur card la un moment dat.
4		Indicator/comutator pentru comunicații	Activează/dezactivează dispozitivele de comunicație ale computerului/indică starea dispozitivului de comunicație wireless ale computerului.

## Vedere din stânga



#	Pictogramă	Element	Descriere
1		Mufă c.c. intrare	Conectează la un adaptor de c.a.
2		Port HDMI	Acceptă conexiuni video digitale de înaltă definiție.
3		Port pentru afișaj extern (VGA)	Conectează la un dispozitiv de afișare (de ex. monitor extern sau proiector LCD).
4		Port USB/eSATA	Conectează la dispozitivele USB sau eSATA (doar pentru anumite modele). <b>Notă:</b> În cazul în care conectați un dispozitiv eSATA, veți avea la dispoziție trei porturi USB.
5		Slot SmartCard	Acceptă unitatea de citire carduri SmartCard.
6		Slot pentru ExpressCard/34	Acceptă un modul ExpressCard/34. <b>Notă:</b> Apăsați pentru a extrage/a insera cardul.

## Vedere din dreapta







#	Pictogramă	Element	Descriere
1		Port USB	Conectează la dispozitivele USB.
2		Port USB	<i>Dacă portul este negru, acesta este compatibil USB 2.0, dacă portul este albastru este compatibil și USB 3.0.</i>
3		Port USB cu încărcare fără pornire	
4		Unitate optică	Unitate optică internă, acceptă CD-uri sau DVD-uri.
5		Indicator de acces la discul optic	Se aprinde când unitatea optică este activă.
6		Buton de eliminare unitate optică	Elimină discul optic din unitate.
7		Orificiu de eliminare de urgență	Scoate tava unității optice când computerul este oprit. <b>Notă:</b> <i>Introduceți o bucată de hârtie în orificiul de eliminare de urgență pentru a elimina tava unității optice când computerul este oprit.</i>
8		Port Ethernet (RJ-45)	Conectează la o rețea Ethernet 10/100/1000.
9		Slot de blocare Kensington	Conectează la un dispozitiv de securitate pentru computer compatibil Kensington. <b>Notă:</b> <i>Înfășurați cablul blocajului de securitate al computerului în jurul unui obiect fix precum o masă sau un mâner al unui sertar încuiat. Introduceți blocajul în zăvor și răsuciți cheia pentru a fixa blocajul. Sunt disponibile și unele modele fără chei.</i>

## Informații despre USB 3.0

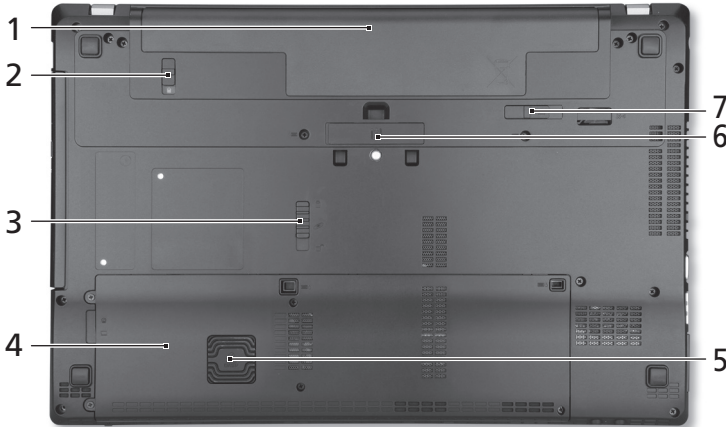
- Compatibil cu dispozitive USB 3.0 și mai vechi.
- Pentru performanțe optime, utilizați dispozitive certificate USB 3.0.
- Definit prin specificația USB 3.0 (SuperSpeed USB).

## Vedere bază



#	Pictogramă	Element	Descriere
1		Nișa pentru acumulator	Adăpostește setul de acumulatori ai computerului.
2		Blocaj acumulator	Blochează acumulatorul în poziție.
3		Zăvor de eliberare Acer MediaBay	Eliberează modulul Acer MediaBay.
4		Locaș unitate de harddisk	Adăpostește unitatea de harddisk a computerului (fixată cu șuruburi).
		Compartiment de memorie	Adăpostește memoria principală a computerului.
5		Acer DASP (Protecție antișoc a discului)	Protejează unitatea de harddisk la șocuri și lovituri.



#	Pictogramă	Element	Descriere
6		Conector Acer ProDock	Se conectează la Acer ProDock opțional.
7		Zăvor de eliberare a acumulatorului.	Eliberează acumulatorul pentru a fi scos.

## Mediu

- Temperatură:
  - Funcționare: 5°C - 35°C
  - Nefuncționare: -20°C - 65°C
- Umiditate (fără condensare):
  - Funcționare: 20% - 80%
  - Nefuncționare: 20% - 80%



# TravelMate ноутбук

## Кратко ръководство

### Регистрация на продукта

Когато използвате своя продукт за пръв път, препоръчително е незабавно да го регистрирате. Това ще Ви даде достъп до някои полезни предимства, като напр.:

- По-бързо обслужване от нашите обучени представители.
- Членство в Асег общността: Промоции и участие в проучвания на клиенти.
- Последните новини от Асег.

Побързайте и се регистрирайте, тъй като Ви очакват и други предимства!

### Как да се регистрирате

За да регистрирате своя Асег продукт, посетете [www.acer.com](http://www.acer.com). Изберете своята държава, щракнете върху **РЕГИСТРАЦИЯ НА ПРОДУКТА** и следвайте лесните инструкции.

Също така ще бъдете подканени да регистрирате своя продукт по време на настройката или да щракнете два пъти върху иконата Регистрация на работния плот.

След като получим регистрацията на Вашия продукт, ще Ви изпратим имейл с потвърждение, съдържащ важни данни, които трябва да съхраните на сигурно място.

### Закупуване на Асег аксесоари

Щастливи сме да Ви осведоим, че програмата за удължаване на гаранцията на Асег и аксесоари за ноутбука са достъпни онлайн. Посетете нашия онлайн магазин и намерете това, което Ви е необходимо, на адрес [store.acer.com](http://store.acer.com).

Асег магазинът се закрива постепенно и може да не е достъпен в някои региони. Моля, проверявайте редовно, за да видите кога ще бъде достъпен за Вашата държава.

© 2012 Всички права запазени.

Ръководство за бърз старт за TravelMate ноутбук  
Тази редакция: 07/2012

Модел номер: \_\_\_\_\_

Сериен номер: \_\_\_\_\_

Дата на покупка: \_\_\_\_\_

Място на закупуване: \_\_\_\_\_

## Преди всичко

Бихме желали да ви благодарим, че сте избрали ноутбук на Асег за вашите нужди в областта на мобилните компютри.

## Вашите ръководства

За да ви помогнем при употребата на вашия ноутбук Асег, ние изготвихме следните ръководства:

Първо, **Плакатът с настройки** Ви помага с началните настройки на компютъра.

Печатната версия на **Бързото ръководство** ви представя основните функции и възможности на новия ви компютър.

За повече информация как Вашият компютър може да Ви помогне да сте по-продуктивни, моля, вижте **Ръководството на потребителя**. **Ръководството на потребителя** съдържа полезна информация за Вашия нов компютър. Покрива основни теми като използване на клавиатура, аудио и др.

То съдържа подробна информация за теми като системни инструменти, възстановяване на данни, опции за ъпгрейд и решаване на проблеми. В допълнение, то съдържа и гаранционна информация, както и основните регулации и бележки за безопасност, свързани с вашия ноутбук.

За да го отворите, следвайте тези стъпки:

- 1 Напишете "Потребител" от *Start*.
- 2 Щракнете върху **Асег Ръководство на потребителя**.





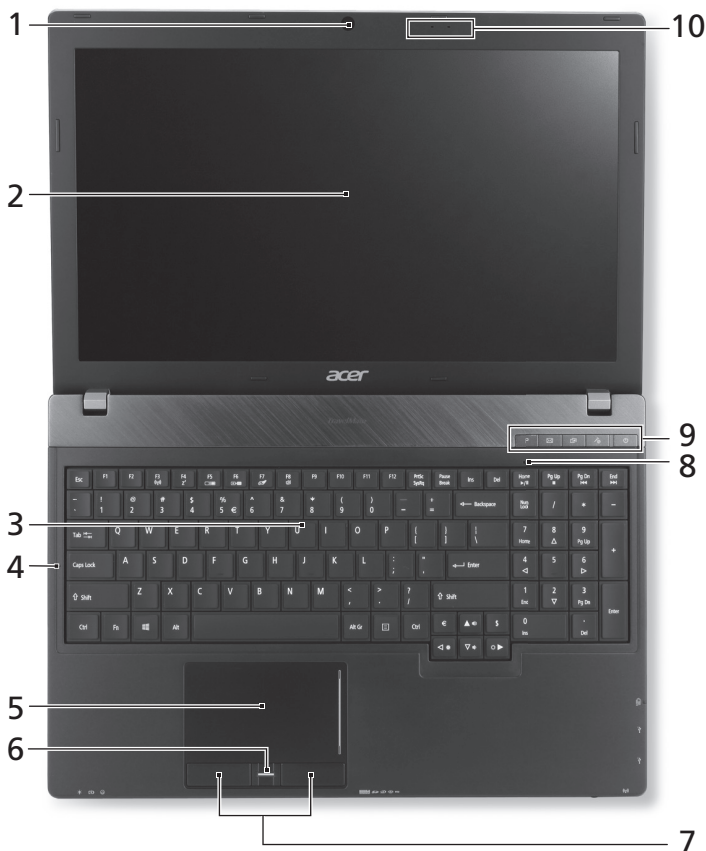

## Преглед на Вашия Асер ноутбук

След като настроите компютъра си, както е показано на плаката с настройки, ще Ви запознаем с Вашия нов ноутбук Асер.

### Изглед отгоре



#	Икона	Елемент	Описание
1		Вградена уеб камера	Уеб камера за видео комуникации. Светлинен индикатор близо до уеб камерата показва, че уеб камерата е активна.

#	Икона	Елемент	Описание
2		Екрана	Нарича се още "Течнокристален дисплей" (LCD) и е екранът на компютъра (конфигурацията може да се различава в зависимост от моделите).
3		Клавиатура	Служи за въвеждане на данни в компютъра Ви.
4		Caps Lock	Светва, когато активирате Caps Lock.
5		Тъчпад	Чувствително на допир посочващо устройство, което функционира като компютърна мишка.
6		Четец за пръстови отпечатащи	Четец за пръстови отпечатащи за Acer ProShield Security Suite.
7		Бутони за щракане (ляв и десен)	Левият и десният бутони функционират като ляв и десен бутон на мишка.
8		Num Lock	Светва, когато активирате Num Lock.
		P клавиш	Програмираем клавиш (конфигурацията може да се различава в зависимост от модела).
		Асег имейл клавиш	Отваря Вашето имейл приложение по подразбиране.
9		Бутон за архивиране	Стартира Acer Backup Management за архивиране на данни в три стъпки.
		Микрофон без звук	Изключва звука на микрофона.
		Бутон на захранването/индикатор	Включва и изключва компютъра. Показва статуса на захранване на компютъра.
10		Микрофони	Два вътрешни микрофона за запис на стерео звук.

## Бързи клавиши

Компютърът има "бързи клавиши" - клавишни комбинации за бърз достъп до повечето от контролите му, като например яркост на дисплея и сила на звука.

За да активирате бързите клавиши, натиснете и задръжте клавиша <Fn> преди да натиснете другия бърз клавиш от комбинацията.

Бърз клавиш	Икона	Функция	Описание
<Fn> + <F3>		Комуникация	Включва/изключва устройствата за комуникация на компютъра.
<Fn> + <F4>		Сън	Вкарва компютъра в режим Sleep (Сън).
<Fn> + <F5>		Превключване на дисплей	Превключва активния дисплей между екрана, външния монитор (ако е свързан такъв), или и двете.
<Fn> + <F6>		Затъмняване на екрана	Изключва задното осветяване на екрана с цел икономия на енергия. Натиснете произволен клавиш, за да се върнете.
<Fn> + <F7>		Превключване на тъчпада	Включва и изключва тъчпада.
<Fn> + <F8>		Превключване на високоговорителите	Включва и изключва високоговорителите.
<Fn> + <▷>		Засилване на яркостта	Увеличава яркостта на екрана.
<Fn> + <◁>		Намаляване на яркостта	Намалява яркостта на екрана.
<Fn> + <△>		Усилване на звука	Усилва силата на звука.
<Fn> + <▽>		Намаляване на звука	Намалява силата на звука.
<Fn> + <Home>		Възпроизвеждане/ Пауза	Възпроизвеждане или пауза за избрания мултимедиен файл.
<Fn> + <Pg Up>		Стой	Спира възпроизвеждането на избрания мултимедиен файл.
<Fn> + <Pg Dn>		Предишен	Връщане към предишен мултимедиен файл.



Бърз клавиш	Икона	Функция	Описание
<Fn> + <End>		Напред	Прескачане до следващия мултимедиен файл.

## Преден изглед при затворен лаптоп

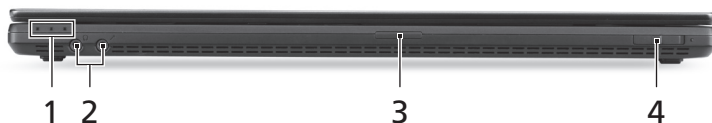

#	Икона	Елемент	Описание
		Индикатор на захранването	Показва статуса на захранване на компютъра.
1		Индикатор за нивото на батерията	Показва статуса на батерията на компютъра. <b>1. Зареждане:</b> Индикаторът свети в жълто, докато батерията се зарежда. <b>2. Напълно заредена:</b> Индикаторът свети синьо, когато сте в режим AC.
		Индикатор на твърдия диск	Показва дали твърдият диск е активен.
2		Вход за микрофон	Приема входящ сигнал от външни микрофони.
		Жак за слушалки/високоговорители	За връзка с аудио устройства (напр. колони, слушалки).
3		Четец на карти Multi-in-1 (Много-в-1)	Чете Secure Digital (SD), MultiMediaCard (MMC), Memory Stick Pro (MS PRO), xD-Picture Card (xD). <b>Забележка:</b> Натиснете, за да извадите/инсталирате картата. Не е възможно използването на повече от една карта.
4		Бутон за комуникации/индикатор	Активира/деактивира комуникационните устройства на компютъра/показва статуса на устройствата за безжична връзка на компютъра.

## Изглед отляво



#	Икона	Елемент	Описание
1		Жак за DC вход	За връзка с AC адаптер.
2		HDMI порт	Поддържа високодетаилна цифрова видео връзка.
3		Порт за външен дисплей (VGA)	За връзка с дисплейно устройство (напр. външен монитор, LCD проектор).
4		USB/eSATA порт	За свързване към USB или eSATA устройства (само за някои модели). <b>Забележка:</b> Ако свържете устройство eSATA, ще имате налични три USB порта.
5		Слот за карти SmartCard	Приема карти от типа SmartCard.
6		Слот за ExpressCard/34	Побира един модул ExpressCard/34. <b>Забележка:</b> Натиснете, за да извадите/поставите картата.

## Изглед отдясно







#	Икона	Елемент	Описание
1		USB порт	
2		USB порт	За свързване на USB устройства.
3		USB порт със зареждане при изключен компютър	Ако даден порт е черен, то той е съвместим с USB 2.0; ако даден порт е син, то той поддържа и USB 3.0.
4		Оптично устройство	Вътрешно оптично устройство; чете CD или DVD дискове.
5		Индикатор за достъп до оптичен диск	Светва, когато оптичното устройство е активно.
6		Бутон за отваряне на оптичното устройство	Изважда оптичния диск от устройството.
7		Отвор за спешно изваждане	За изваждане на оптичния диск, когато компютърът е изключен. <b>Забележка:</b> Пъхнете кламер в отвора за аварийно изваждане, за да извадите тавата на оптичното устройство, докато компютърът е изключен.
8		Порт за Ethernet (RJ-45)	За връзка с мрежа, базирана на Ethernet 10/100/1000.
9		Отвор за заключващ механизъм Kensington	За връзка с Kensington-съвместим компютърен заключващ механизъм. <b>Забележка:</b> Увийте осигурителния кабел около неподвижен обект като закрепена за пода маса или дръжката на заключено чекмедже. Поставете ключалката в жлеба и завъртете ключа, за да я заключите. Има и някои модели без ключове.

## Информация за USB 3.0

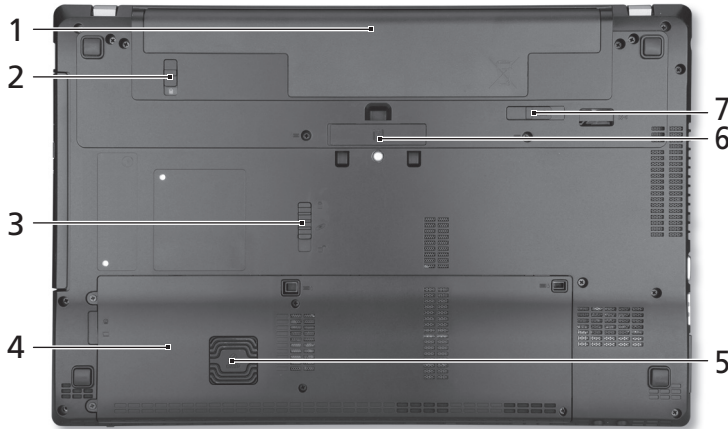
- Съвместимост с USB 3.0 и по-стари USB устройства.
- За оптимална производителност използвайте сертифицирани USB 3.0 устройства.
- Според спецификацията на USB 3.0 (SuperSpeed USB).

## Изглед отдолу



#	Икона	Елемент	Описание
1		Отделение за батерии	Тук се поставя батерийният модул на компютъра.
2		Заклучващ механизъм на батерията	Държи батерията на мястото ѝ.
3		Освобождаващо езиче за Acer MediaBay	Освобождава Acer MediaBay модула.
4		Отделение за твърдия диск	Тук се намира твърдият диск на компютъра (прикрепен с винтове).
		Отделение за памет	Тук се поставя главната памет на компютъра.
5		Acer DASP (дисква антишокова защита)	Предпазва твърдия диск от удари и вибрации.

#	Икона	Елемент	Описание
6		Асер ProDock конектор	За свързване на Асер ProDock, който се предлага като опция.
7		Ключе за освобождаване на батерията	Освобождава батерията, за да можете да я извадите.

## Околна среда

- Температура:
  - Работна: от 5°C до 35°C
  - За съхранение: от -20°C до 65°C
- Влажност (без кондензация):
  - Работна: от 20% до 80%
  - За съхранение: от 20% до 80%



# TravelMate sülearvuti

## Lühijuhend

### Toote registreerimine

Toote esmakordsel kasutamisel on soovitatav see kohe registreerida. See annab teile juurdepääsu mõningatele kasulikele eelistele, näiteks:

- Kiirem teenindus meie koolitatud esindajatelt.
- Aceri kogukonna liikmelisus: pakkumiste saamine ja kliendiuringutes osalemine.
- Värskeimad uudised Acerilt.

Kiirustage ja registreerige, teid ootavad ka muud eelised!

### Kuidas registreerida

Aceri toote registreerimiseks külastage veebisaiti **www.acer.com**. Valige oma riik, klõpsake nupul **TOOTE REGISTREERIMINE** ja järgige lihtsaid juhiseid.

Teil palutakse toode registreerida seadistustoimingu ajal, kuid võite ka klõpsata töölaual oleval registreerimise ikoonil.

Kui oleme teie tooteregistreeringu kätte saanud, saadetakse teile olulisi andmeid sisaldav kinnitusmeil, mille peaksite kindlas kohas alles hoidma.

### Aceri tarvikute hankimine

Meil on hea meel teile teatada, et Aceri garantilaienduse programm ja sülearvutitarvikud on võrgus saadaval. Külastage meie veebipoodi aadressil **store.acer.com** ja leidke sealt endale vajalik.

Aceri veebipoodi avatakse järk-järgult ja kahjuks ei pruugi see kõigis piirkondades saadaval olla. Palun käige aeg-ajalt vaatamas, kas see on teie riigis juba avatud.

© 2012 Kõik õigused kaitstud.

TravelMate sülearvuti lühijuhend

See versioon: 07/2012

Mudeli number: \_\_\_\_\_

Seerianumber: \_\_\_\_\_

Ostukuupäev: \_\_\_\_\_

Ostukoht: \_\_\_\_\_



## Tähtsamad asjad kõigepealt

Täname teid, et valisite oma kaasaskantavaks arvutiks Aceri sülearvuti.

### Teie teejuhid

Et aidata Teil kasutada oma Acer'i sülearvutit, oleme loonud komplekti juhiseid:

Kõigepealt aitab **seadistuse poster** teil alustada oma arvuti häälestamist.

Trükitud **Lühijuhend** tutvustab Teile uue arvuti põhilisi omadusi ja funktsioone.

Kui soovite rohkem teada saada, kuidas arvuti aitab teil produktiivsem olla, vaadake **kasutusjuhendit**. **Kasutusjuhend** sisaldab kasulikku teavet arvuti kasutuselevõtmise kohta. See katab põhilisi teemasid nagu klaviatuuri kasutamine, heli jne.

See juhend sisaldab täpsemat teavet teemadel nagu süsteemiutiliidid, andmete taastamine, laiendusvõimalused ja veaotsing. Sellele lisaks sisaldab see garantiiteavet ning sülearvuti kohta kehtivaid üldiseid regulatsioone ja ohutuseeskirju.

Juhised selle avamiseks:

- 1 Trüki *start*-menüüs „Kasutaja”.
- 2 Klõpsake real **Aceri kasutusjuhend**.





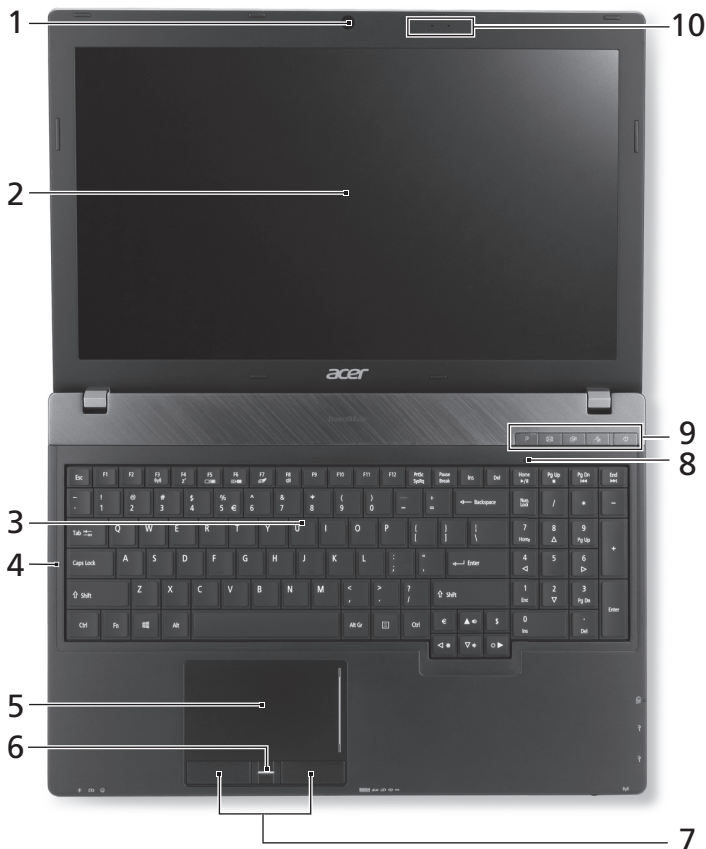

## Teie Acer'i sülearvuti ülevaade

Kui olete oma arvuti häälestanud häälestuse postril kujutatud viisil, lubage meil teile tutvustada teie uut Aceri sülearvutit.

### Pealtvaade















#	Ikon	Objekt	Kirjeldus
1		Integreeritud veebikaamera	Veebikaamera videosuhtluseks. Veebikaamera kõrval olev märgutuli näitab, kas veebikaamera on aktiivne.

#	Icoon	Objekt	Kirjeldus
2		Ekraan	Seda nimetatakse ka vedelkristallekraaniks (LCD) ning see kuvab arvuti pilti (mudelite konfiguratsioon võib olla erinev).
3		Klaviatuur	Andmete sisestamiseks arvutisse.
4		Caps Lock	Süttib siis, kui Caps Lock aktiveeritakse.
5		Puuteplaat	Puutetundlik osutusseadis, mis töötab arvutihiirena.
6		Sõrmejäljelugeja	Sõrmejäljelugeja rakenduse Acer ProShield Security Suite jaoks.
7		Klõpsunupud (vasak ja parem)	Vasak ja parem nupp funktsioneerivad vasaku ja parema hiirenupuna.
8		Num Lock	Süttib siis, kui Num Lock aktiveeritakse.
		Klahv P	Seadistatav klahv (mudeli konfiguratsioon võib erineda).
		Aceri e-posti võti	Avab teie vaikimisi e-posti rakenduse.
9		Varuvõti	Käivitab rakenduse Acer Backup Management andmete varundamiseks kolme sammuga.
		Mikrofoni vaigistamine	Vaigistab mikrofoni.
		Voolunupp/-indikaator	Arvuti sisse- ja väljalülitamiseks. Näitab arvuti olekut.
10		Mikrofonid	Kaks sisseehitatud mikrofoni stereoheli salvestamiseks.

## Kiirklahvid

Arvutil on enamiku seadete jaoks (nt ekraani heledus, heliväljund) olemas kiirklahvid ja klahvikombinatsioonid.





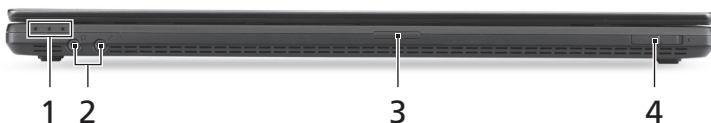

Kiirklahvide aktiveerimiseks vajutage ning hoidke enne teise kombinatsiooni kuuluva klahvi vajutamist all klahvi **<Fn>**.

Kiirklahv	Ikoon	Funktsioon	Kirjeldus
<Fn> + <F3>		Kommunikatsioon	Aktiveerib/desaktiveerib arvuti sideseadmed.
<Fn> + <F4>		Unerežiim	Lülitab arvuti unerežiimi.
<Fn> + <F5>		Ekraani valik	Lülitab ekraanipildi kuvaekraanile, välisele ekraanile (kui see on ühendatud) või mõlemale.
<Fn> + <F6>		Tühi ekraan	Lülitab ekraani tagantvalgustuse energia säästmiseks välja. Tagasipöördumiseks vajutage suvalisele klahvile.
<Fn> + <F7>		Puuteplaadi lülit	Lülitab integreeritud puuteplaadi sisse või välja.
<Fn> + <F8>		Kõlarilüliti	Lülitab kõlarid sisse või välja.
<Fn> + <▷>		Heledus üles	Suurendab ekraani heledust.
<Fn> + <◁>		Heledus alla	Vähendab ekraani heledust.
<Fn> + <△>		Helitugevus üles	Tõstab helitugevust.
<Fn> + <▽>		Helitugevus alla	Vähendab helitugevust.
<Fn> + <Home>		Esita/paus	Esitab või peatab valitud meediumifaili.
<Fn> + <Pg Up>		Lõpeta	Lõpetab valitud meediumifaili esitamise.
<Fn> + <Pg Dn>		Eelmine	Pöördub tagasi eelmise meediumifaili jurde.

Kiirklahv	Ikoon	Funktsioon	Kirjeldus
<Fn> + <End>		Järgmine	Ligub edasi järgmise meediumifaili juurde.





## Suletud eestvaade



#	Ikoon	Objekt	Kirjeldus
		Vooluindikaator	Näitab arvuti olekut.
1		Akuindikaator	Näitab arvuti aku olekut. <b>1. Laadimine:</b> kui akut laetakse, on tuli kollakat värvi. <b>2. Täielikult laetud:</b> kui arvuti on vooluvõrgus, on tuli sinist värvi.
		Kõvakettaindikaator	Näitab kõvaketta aktiivsust.
2		Mikrofonisisend	Võtab vastu sisendheli välisest mikrofonist.
		Kõrvaklappide/ kõlarite pistik	Heliseadmete ühendamiseks (nt kõlarid, kõrvaklapid).
3		Mitu-ühes kaardilugeja	Võtab vastu Secure Digital (SD), MultiMediaCard (MMC), Memory Stick PRO (MS PRO) ja xD-Picture kaarte (xD). <b>Märkus:</b> Kaardi eemaldamiseks/ paigaldamiseks vajutage sellele. Korraga saab töötada ainult üks kaart.
4		Ühenduse lüliti/ indikaator	Aktiveerib/keelab arvuti ühenduse seadmetega/näitab arvuti juhtmevaba ühenduse seadme olekut.





## Vaade vasakult



#	Ikoon	Objekt	Kirjeldus
1		Alalisvoolusisendi pistik	Vahelduvvooluadapteri (toiteploki) ühendamiseks.
2		HDMI-port	Toetab kõrglahutusega digitaalvideoühendusi.
3		Välise kuvari (VGA) port	Kuvaseadme (nt välise kuvari või LCD-projektori) ühendamiseks.
4		USB/eSATA port	USB või eSATA seadmetega ühendamiseks (ainult teatud mudelitel) <b>Märkus:</b> Kui ühendate eSATA seadme, on teil võimalik kasutada kolme USB-porti.
5		SmartCard kaardipesa	Sobib SmartCard kaartidele.
6		ExpressCard/34 pesa	Võtab vastu ühe ExpressCard/34 mooduli. <b>Märkus:</b> Kaardi eemaldamiseks/ sisestamiseks vajutage sellele.

## Vaade paremalt







#	Ikoon	Objekt	Kirjeldus
1		USB porti	
2		USB porti	USB-seadmetega ühendamiseks. <i>Kui port on musta värvi, siis ühildub see USB 2.0-ga, kui sinine, siis ühildub see ka USB 3.0-ga.</i>
3		USB-port koos väljalülitatud olekus laadimise funktsiooniga	
4		Optiline seade	Sisemine optiline seade; loeb CD-sid või DVD-sid.
5		Optilise ketta lugemise indikaator	Süttib, kui optiline seade on aktiivne.
6		Optilise seadme väljastusnupp	Väljastab optilise ketta seadmest.
7		Hädaväljastusava	Avab optilise seadme sahtli, kui arvuti on välja lülitatud. <b>Märkus:</b> Optilise seadme avamiseks siis, kui arvuti on välja lülitatud, lükake hädaväljastusavasse kirjaklamber.
8		Etherneti (RJ-45) port	Ethernet 10/100/1000-põhise võrguga ühendamiseks.
9		Kensington-luku pesa	Kensington-tüüpi arvuti turvaluku ühendamiseks. <b>Märkus:</b> Vedage arvuti turvaluku kaabel ümber liikumatu objekti, näiteks laua või lukustatud sahtli käepideme. Lükake lukk avasse ning keerake luku sulgemiseks võtit. Saadaval on ka võtmeta mudelid.

## Teabe USB 3.0 kohta

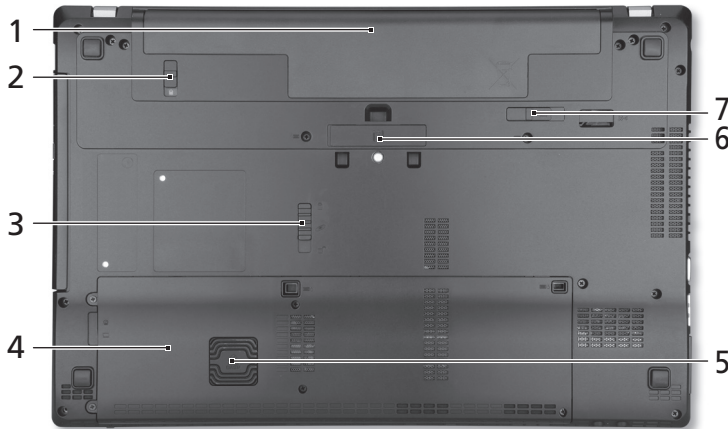
- Ühildub USB 3.0 ja varasemate USB-seadmetega.
- Optimaalse jõudluse saavutamiseks kasutage USB 3.0 sertifikaadiga seadmeid.
- Määratletud standardi USB 3.0 (SuperSpeed USB) alusel.

## Põhjavaade



#	Ikoon	Objekt	Kirjeldus
1		Akusektsioon	Siin asuvad arvuti akud.
2		Akulukk	Lukustab aku kohale.
3		Acer MediaBay vabastusriiv	Vabastab Acer MediaBay mooduli.
4		Kõvakettasektsioon	Siin asub arvuti kõvaketas (kinnitatud kruvidega).
		Mälusahtel	Siin asub arvuti põhimälu.
5		Acer DASP (ketta lõõgivastane kaitse)	Kaitseb kõvaketast löökide ja müksude eest.
6		Acer ProDocki liitmik	Valikulise Acer ProDocki ühendamiseks.
7		Aku vabastamise riiv	Vabastab aku, et seda saaks välja võtta.



## Keskkond

---

- Temperatuur:
    - Töötamiseks sobiv: 5°C kuni 35°C
    - Sobimatu: -20°C kuni 65°C
  - Niiskus (mittekondenseeruv):
    - Töötamiseks sobiv: 20% kuni 80%
    - Sobimatu: 20% kuni 80%
-



# TravelMate piezīmjdators

## Ātrais ceļvedis

### Produkta reģistrācija

Pirmajā produkta lietošanas reizē ir ieteicams to nekavējoties reģistrēt. Jūs iegūsiet vairākas noderīgas priekšrocības, piemēram:

- Ātrāku apkalpošanu no mūsu apmācītajiem pārstāvjiem.
- Dalību Acer kopienā: saņemiet piedāvājumus un piedalieties klientu aptaujās.
- Jaunākās ziņas no Acer.

Pasteidzieties un reģistrējieties, jo jūs gaida arī citas priekšrocības!

### Kā reģistrēt

Lai reģistrētu savu Acer produktu, lūdzu, apmeklējiet **www.acer.com**. Izvēlieties savu valsti, noklikšķiniet **PRODUKTA REĢISTRĀCIJA**, un izpildiet vienkāršās instrukcijas.

Iestatīšanas procesa laikā jums arī tiks jautāts, vai vēlaties reģistrēt savu produktu, taču jūs varat arī dubultklikšķināt uz darbvirsmas novietoto reģistrācijas ikonu.

Kad būsīm saņēmuši jūsu produkta reģistrāciju, jums tiks nosūtīts apstiprinājuma e-pasts ar svarīgiem datiem, kurus vajadzētu saglabāt drošā vietā.

### Acer piederumu saņemšana

Ar prieku varam jūs informēt, ka Acer garantijas pagarināšanas programma un piezīmjdatoru piederumi ir pieejami tiešsaistē. Nāciet un apmeklējiet mūsu tiešsaistes veikalu **store.acer.com**, un atrodiat tieši to, kas jums nepieciešams.

Acer veikals tiek ieviests pakāpeniski, tādēļ diemžēl tas var nebūt pieejams dažos apgabalos. Lūdzu, regulāri sekojiet jaunumiem, lai uzzinātu, kad tas ir pieejams jūsu valstī.

© 2012 Visas tiesības paturētas.

TravelMate piezīmjdatora ātrais ceļvedis  
Šī versija: 07/2012

Modeļa numurs: \_\_\_\_\_

Sērijas numurs: \_\_\_\_\_

Iegādes datums: \_\_\_\_\_

Pirkuma vieta: \_\_\_\_\_

## Galvenais vispirms

Mēs vēlamies jums pateikties, ka esat izvēlējis Acer piezīmjdatoru, lai nodrošinātu savas mobilās skaitļošanas vajadzības.

## Jūsu rokasgrāmatas

Lai palīdzētu jums lietot Acer piezīmjdatoru, esam sagatavojuši rokasgrāmatu komplektu:

Pirmkārt, **uzstādīšanas attēls** jums palīdz sagatavot datoru darbam.

**Ātrais ceļvedis** sniedz ieskatu par jūsu jaunā datora galvenajiem līdzekļiem un funkcijām.

Lai uzzinātu vairāk, kā jūsu dators jums var palīdzēt būt vēl produktīvākam, lūdzu, skatiet **lietotāja rokasgrāmatā**. **Lietotāja rokasgrāmatā** ir noderīga informācija par jūsu jauno datoru. Tas aptver pamata tematiku, tādu kā tastatūras un audio izmantošana utt.

Šajā ceļvedī ir detalizēta informācija par tādām tēmām kā sistēmas utilītas, datu atkopšana, paplašināšanas opcijas un problēmu novēršana.

Bez tam tajā ir iekļauta informācija par garantijām un piezīmjdatora lietošanas vispārīgas regulas un drošības paziņojumi.

Veiciet šīs darbības, lai tam piekļūtu:

- 1 Izvēlnē **Sākt** ievadiet „Lietotājs”.
- 2 Noklikšķiniet uz **Acer lietotāja rokasgrāmata**.





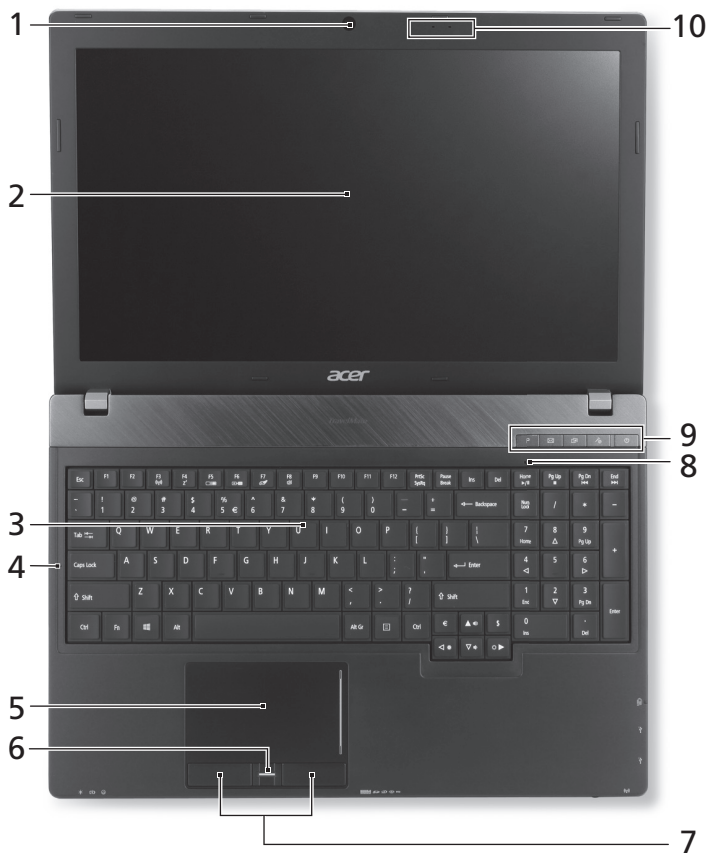

## Acer piezīmjdatora pārskats

Ja esat sagatavojis datoru darbam, kā redzams uzstādīšanas attēlā, ļaujiet mums jūs iepazīstināt ar jūsu jauno Acer piezīmjdatoru.

### Skats no augšpuses



#	Ikona	Vienums	Apraksts
1		Integrēta tīmekļa kamera	Tīmekļa kamera videosakariem. <i>Indikators blakus tīmekļa kamerai norāda, ka tīmekļa kamera ir aktīva.</i>

#	Ikona	Vienums	Apraksts
2		Ekrāns	Saukts arī par šķidro kristālu displeju (LCD); rāda datora izvadi (konfigurācija modeļiem var atšķirties).
3		Tastatūra	Datu ievadīšanai datorā.
4		Caps Lock	Deg, ja ir aktivizēts Caps Lock.
5		Skārienpanelis	Skārienjutīga rādītājierīce, kas darbojas kā datora pele.
6		Pirkstu nospiedumu lasītājs	Pirkstu nospiedumu lasītājs Acer ProShield Security Suite.
7		Klikšķināmas pogas (kreisā un labā)	Kreisā un labā poga darbojas tāpat kā peles kreisā un labā poga.
8		Num Lock	Deg, ja ir aktivizēts Num Lock.
		P taustiņš	Programmējams taustiņš (konfigurācija modeļiem var atšķirties).
		Acer e-pasta taustiņš	Atver jūsu noklusējuma e-pasta lietojumprogrammu.
9		Dublēšanas taustiņš	Palaiž Acer Backup Management, lai veiktu trīssoļu datu dublēšanu.
		Klusums mikrofonam	Izslēdz mikrofona sakņu.
		Barošanas poga/indicators	Ieslēdz un izslēdz datoru. Norāda datora barošanas statusu.
10		Mikrofoni	Divi iekšējie mikrofoni stereo skaņas ierakstīšanai.

## Ātrie taustiņi

Lai piekļūtu lielākajai daļai datora vadības funkciju, piemēram, ekrāna spilgtumam un skaļuma izvadi, tiek izmantoti datora ātrie taustiņi vai taustiņu kombinācijas.

Lai aktivizētu ātros taustiņus, vispirms nospiediet un turiet nospiestu taustiņu **<Fn>** un pēc tam nospiediet ātro taustiņu kombinācijas otru taustiņu.

Ātrais taustiņš	Ikona	Funkcija	Apraksts
<b>&lt;Fn&gt; + &lt;F3&gt;</b>		Sakari	Iespējo/atspējo datora sakaru ierīces.
<b>&lt;Fn&gt; + &lt;F4&gt;</b>		Miega režīms	Pārslēdz datoru miega režīmā.
<b>&lt;Fn&gt; + &lt;F5&gt;</b>		Displeja pārslēgšana	Pārslēdz displeja izvadi starp displeja ekrāna un ārējo monitoru (ja tas ir pievienots), vai rāda izvadi abos.
<b>&lt;Fn&gt; + &lt;F6&gt;</b>		Tukšs ekrāns	Enerģijas taupīšanas nolūkā izslēdz displeja ekrāna pretgaismu. Lai atjaunotu pretgaismu, nospiediet jebkuru taustiņu.
<b>&lt;Fn&gt; + &lt;F7&gt;</b>		Skārienpaneļa pārslēgšana	Ieslēdz un izslēdz iekšējo skārienpaneli.
<b>&lt;Fn&gt; + &lt;F8&gt;</b>		Skaļruņu pārslēgšana	Ieslēdz un izslēdz skaļruņus.
<b>&lt;Fn&gt; + &lt;▷&gt;</b>		Spilgtāk	Palielina ekrāna spilgtumu.
<b>&lt;Fn&gt; + &lt;◁&gt;</b>		Blīvāk	Samazina ekrāna spilgtumu.
<b>&lt;Fn&gt; + &lt;△&gt;</b>		Skaļāk	Palielina skaņas skaļumu.
<b>&lt;Fn&gt; + &lt;▽&gt;</b>		Klusāk	Samazina skaņas skaļumu.
<b>&lt;Fn&gt; + &lt;Home&gt;</b>		Atskaņot/pauze	Atskaņo vai aptur izvēlēto multivides failu.



Ātrais taustiņš	Ikona	Funkcija	Apraksts
<Fn> + <Pg Up>	■	Apturēt	Pārtrauc izvēlētajā multivides faila atskaņošanu.
<Fn> + <Pg Dn>	◀◀	Atpakaļ	Atgriežas pie iepriekšējā multivides faila.
<Fn> + <End>	▶▶	Tālāk	Pārlec uz nākamo multivides failu.



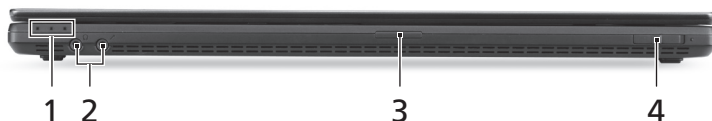

## Skats no priekšpuses aizvērtā veidā



#	Ikona	Vienums	Apraksts
		Barošanas indikators	Norāda datora barošanas statusu.
1		Akumulatora indikators	Norāda datora akumulatora statusu. <b>1. Uzlāde:</b> Indikators ir oranžā krāsā, akumulatoram lādējoties. <b>2. Pilnībā uzlādēts:</b> Datoram darbojoties maiņstrāvas režīmā, indikators ir zils.
		Cietā diska indikators	Norāda, kad cietā diska draiveris ir aktīvs.
2		Mikrofona ligzda	Pieņem ievadi no ārējiem mikrofoniem.
		Austiņu/skaļruņu ligzda	Pievieno audio ierīces (piem., skaļruņus, austiņas).
3		Karšu lasītājs "Vairāki vienā"	Pieņem datu nesējus Secure Digital (SD), MultiMediaCard (MMC), Memory Stick PRO (MS PRO) un xD-Picture Card (xD). <b>Piezīme:</b> Nospiediet, lai izņemtu/instalētu karti. Vienlaikus var lietot tikai vienu karti.
4		Sakaru slēdzis/indikators	Iespējo/atspējo datora sakaru ierīces/norāda datora bezvadu savienojuma ierīces statusu.

## Skats no kreisās puses



#	Ikona	Vienums	Apraksts
1		Līdzstrāvas ieejas ligzda	Šeit pieslēdz maiņstrāvas adapteru.
2		HDMI ports	Atbalsta augstas kvalitātes ciparu video savienojumus.
3		Ārējā displeja (VGA) ports	Šeit pieslēdz displeja ierīci (piemēram, ārēju monitoru, LCD projektoru).
4		USB/eSATA ports	Šeit pieslēdz USB vai eSATA ierīces (tikai noteiktiem modeļiem). <b>Piezīme:</b> Pievienojot eSATA ierīci, jums būs pieejami trīs USB porti.
5		SmartCard slots	Paredzēts SmartCard.
6		ExpressCard/34 slots	Pieņem vienu ExpressCard/34 moduli. <b>Piezīme:</b> Nospiediet, lai izņemt/ievietotu karti.

## Skats no labās puses







#	Ikona	Vienums	Apraksts
1		USB ports	Pieslēdz USB ierīces.
2		USB ports	<i>Ja ports ir melns, tas ir saderīgs ar USB 2.0; ja tas ir zils, tas ir saderīgs arī ar USB 3.0</i>
3		USB ports ar izslēgtas ierīces uzlādi	
4		Optiskais diskdzinis	Iekšējais optiskais diskdzinis; pieņem CD vai DVD diskus.
5		Optiskā diska piekļuves indikators	Iedegas, kad optiskais diskdzinis ir aktīvs.
6		Optiskā diska izstumšanas poga	Izstumj no diskdzināja optisko disku.
7		Ārkārtas diska izņemšanas caurums	Izstumj optiskā diskdzināja paliktni, kad dators ir izslēgts. <b>Piezīme:</b> <i>Lai izstumtu optiskā diskdzināja paliktni, kad dators ir izslēgts, iebāziet ārkārtas diska izņemšanas caurumā papīra saspraudi.</i>
8		Ethernet (RJ-45) ports	Šeit pieslēdz Ethernet 10/100/1000 tīkla vadu.
9		Kensingtona atslēgas slots	Šeit pieslēdz Kensingtona atslēgu datora drošībai. <b>Piezīme:</b> <i>Aplieciet datora drošības slēdzenes vadu ap nekustīgu priekšmetu, piemēram, galdu vai aizslēgtas atvilktnes rokturi. Ielieciet slēdzeni ierobā un pagrieziet atslēgu, lai nofiksētu slēdzeni. Pieejami arī modeļi bez atslēgas.</i>

## Informācija par USB 3.0

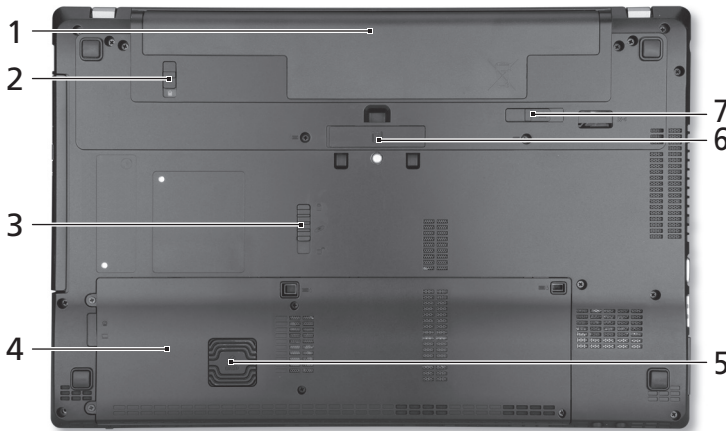
- Saderīgs ar USB 3.0 un vecākām USB ierīcēm.
- Lai sasniegtu optimālu kvalitāti, izmantojiet USB 3.0 sertificētas ierīces.
- Atkarīgs no USB 3.0 (SuperSpeed USB) specifikācijas.

## Skats no apakšpuses



#	Ikona	Vienums	Apraksts
1		Akumulatora nodalījums	Šeit ievieto datora akumulatoru.
2		Akumulatora aizslēgs	Notur akumulatoru vietā.
3		Acer MediaBay fiksators	Atlaiž Acer MediaBay moduli.
4		Cietā diska nodalījums	Šeit atrodas datora cietais disks (nostiprināts ar skrūvēm).
		Atmiņas nodalījums	Šeit atrodas datora pamatatmiņa.
5		Acer DASP (tehnoloģija cietā diska aizsardzībai pret fizisku bojājumu)	Aizsargā cieto disku pret triecieniem un sitieniem.

#	Ikona	Vienums	Apraksts
6		Acer ProDock savienotājs	Pieslēdz Acer ProDock (papildu piederums).
7		Akumulatora atlaišanas slēdzis	Atlaiž akumulatoru, lai to varētu izņemt.

## Vide

- Temperatūra:
  - Ieslēgtā stāvoklī: No 5°C līdz 35°C
  - Izslēgtā stāvoklī: No -20°C līdz 65°C
- Mitrums (bez kondensācijas):
  - Ieslēgtā stāvoklī: No 20% līdz 80%
  - Izslēgtā stāvoklī: No 20% līdz 80%



# TravelMate nešiojamasis kompiuteris

## Trumpa instrukcija

### Gaminio registravimas

Pradėjus naudotis įsigytu gaminiu rekomenduojame nedelsiant jį užregistruoti. Tai jums suteiks galimybę pasinaudoti įvairiomis privilegijomis, tokiomis kaip:

- Greitesnė mūsų kvalifikuotų atstovų pagalba.
- Narystė „Acer“ bendruomenėje: galimybė gauti informaciją apie akcijas ir dalyvauti klientų apklausose.
- Paskutinės naujienos iš „Acer“.

Paskubėkite užsiregistruoti – jūsų laukia daug įvairių privalumų!

### Kaip užsiregistruoti

Norėdami užregistruoti įsigytą „Acer“ gaminį, apsilankykite adresu **www.acer.com**. Pasirinkite savo šalį, spustelėkite **GAMINIO REGISTRAVIMAS** ir vykdykite nesudėtingas instrukcijas.

Jūsų paprašys užregistruoti gaminį per sąrankos procesą, arba galite dukart spustelėti darbalaukyje esančią piktogramą Registravimas.

Gavę jūsų gaminio registraciją mes elektroniniu paštu išsiųsime patvirtinimo laišką su svarbiais duomenimis, kuriuos jūs turėtumėte laikyti saugioje vietoje.

### „Acer“ priedų įsigijimas

Džiaugiamės galėdami jums pranešti, kad „Acer“ garantijos pratęsimo programa ir nešiojamųjų kompiuterių priedai yra prieinami internete. Apsilankykite mūsų internetinėje parduotuvėje ir rasite tai, ko jums reikia, adresu **store.acer.com**.

„Acer“ parduotuvė vystoma palaipsniui ir, deja, gali būti neprieinama kai kuriuose regionuose. Reguliariai tikrinkite, kad sužinotumėte, kad ji taps prieinama jūsų šalyje.

© 2012 Visos teisės saugomos.

TravelMate nešiojamojo kompiuterio trumpa instrukcija

Ši pataisa: 07/2012

Modelio numeris: \_\_\_\_\_

Serijos numeris: \_\_\_\_\_

Išėjimo data: \_\_\_\_\_

Pirkimo vieta: \_\_\_\_\_



## Dalykai, kuriuos reikia atlikti pirmiausia

Leiskite padėkoti, kad pasirinkote „Acer“ nešiojamąjį kompiuterį – tikimės Jūsų nenuvilti ir užtikrinti visus nešiojamojo kompiuterio teikiamus privalumus.

## Instrukcijos Jums

Tam, kad palengvintume Jums naudojimąsi „Acer“ kompiuteriu, parengėme kelias instrukcijas:

Pirmoji yra **sąrankos plakatas** – ši informacija padės pirmosiomis kompiuterio naudojimo minutėmis.

**Trumpoje instrukcijoje** pateikiama informacija apie pagrindines Jūsų įsigyto kompiuterio savybes ir funkcijas.

Išsamesnės informacijos apie tai, kaip padaryti kompiuterį produktyvesniu, rasite **naudotojo vadove**. **Naudotojo vadove** pateikiama naudinga informacija apie jūsų naująjį kompiuterį. Jis apima bendruosius klausimus, kaip, pvz. klaviatūros ir audio sistemos naudojimas ir t.t.

Šioje instrukcijoje išsamiai aprašoma tokia informacija, kaip sisteminiai failai, duomenų atstatymas, kompiuterio galimybių praplėtimas ir gedimų diagnostika. Be to, šioje instrukcijoje yra ir garantinė informacija, bendrieji reikalavimai ir su sauga susiję įspėjimai.

Jei norite peržiūrėti šį gidą:

- 1 Meniu *Paleisti* įrašykite „Naudotojo“.
- 2 Spauskite **Acer naudotojo vadovas**.







# Ekskursija po jūsų Acer nešiojamąjį kompiuterį

Atlikus kompiuterio sąranką kaip parodyta sąrankos plakate, leiskite jus supažindinti su jūsų naujuoju Acer nešiojamuoju kompiuteriu.

## Vaizdas iš viršaus















#	Piktograma	Objektas	Aprašymas
1		Integruota interneto kamera	Interneto kamera vaizdinei komunikacijai. Šalia internetinės kameros deganti lemputė rodo, kad kamera veikia.



#	Piktograma	Objektas	Aprašymas
2		Ekranas	Taip pat vadinamas skystųjų kristalų ekranu (angl. Liquid-Crystal Display (LCD)), jame pateikiamas kompiuterio rodomas vaizdas (konfigūravimo tvarka gali kisti priklausomai nuo modelio).
3		Klaviatūra	Skirta duomenų įvedimui į kompiuterį.
4		Caps Lock	Dega kai yra aktyvuotas „Caps Lock“ klavišas.
5		Liečiamasis laukelis	Lietimui jautrus įrenginys, veikiantis kaip kompiuterio pelė.
6		Pirštų atspaudų skaitytuvas	Acer ProShield Security Suite skirtas pirštų atspaudų skaitytuvas.
7		Pelės klavišai (kairysis ir dešinysis)	Kairysis ir dešinysis klavišai veikia kaip kairysis ir dešinysis pelės mygtukai.
8		Num Lock	Dega kai yra aktyvuotas „Num Lock“ klavišas.
		„P“ klavišas	Programuojamasis klavišas (konfigūravimo tvarka gali kisti priklausomai nuo modelio).
		Acer el. pašto klavišas	Atidaro numatytąją pašto programą.
9		Atsarginės kopijos mygtukas	Paleidžia „Acer Backup Management“, skirtą padaryti duomenų atsargines kopijas trimis etapais.
		Mikrofono nutildymas	Nutildo mikrofoną.
		Energijos mygtukas/ indikatorius	Ijungia ir išjungia kompiuterį. Nurodo kompiuterio energijos sistemos būklę.
10		Mikrofonai	Du vidiniai mikrofonai stereo garso įrašymui.

## Greitieji klavišai

Kompiuteryje įrengti greitieji klavišai ar numatytos klavišų kombinacijos, leidžiančios valdyti daugelį kompiuterio funkcijų, tokių kaip ekrano ryškumas ar garsiakalbių garsas.





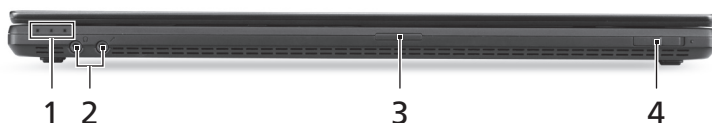

Norėdami pasinaudoti greitaisiais klavišais, prieš spausdami bet kokią greitųjų klavišų kombinaciją nuspauskite ir laikykite klavišus **<Fn>**.

Greitasis klavišas	Piktograma	Funkcija	Aprašymas
<b>&lt;Fn&gt; + &lt;F3&gt;</b>		Komunikacija	Ijungia/išjungia kompiuterio komunikacijos prietaisus.
<b>&lt;Fn&gt; + &lt;F4&gt;</b>		Sustabdyti	Ijungia hibernacijos (kompiuterio sustabdymo) režimą.
<b>&lt;Fn&gt; + &lt;F5&gt;</b>		Ekranų perjungimas	Perjungia kompiuterio rodomą vaizdą iš kompiuterio monitoriaus į išorinį monitorių (jei prijungtas) ir atvirkščiai.
<b>&lt;Fn&gt; + &lt;F6&gt;</b>		Tuščias ekranas	Energijos taupymo tikslais išjungia ekraną. Norint vėl įjungti spauskite bet kurį klavišą.
<b>&lt;Fn&gt; + &lt;F7&gt;</b>		Lietimui jautraus ekrano jungiklis	Ijungia ir išjungia lietimui jautrų ekraną.
<b>&lt;Fn&gt; + &lt;F8&gt;</b>		Garsiakalbio jungiklis	Išjungia ir įjungia garsiakalbius.
<b>&lt;Fn&gt; + &lt;▷&gt;</b>		Padidinti ryškumą	Padidina ekrano ryškumą.
<b>&lt;Fn&gt; + &lt;◁&gt;</b>		Sumažinti ryškumą	Sumažina ekrano ryškumą.
<b>&lt;Fn&gt; + &lt;△&gt;</b>		Padidinti garsą	Padidina kompiuterio audio sistemos garsą.
<b>&lt;Fn&gt; + &lt;▽&gt;</b>		Sumažinti garsą	Sumažina kompiuterio audio sistemos garsą.
<b>&lt;Fn&gt; + &lt;Home&gt;</b>		Leisti/pristabdyti	Leisti ar pristabdyti pasirinktą medijų failą.
<b>&lt;Fn&gt; + &lt;Pg Up&gt;</b>		Stabdyti	Sustabdyti pasirinktą medijų failą.

Greitasis klavišas	Piktograma	Funkcija	Aprašymas
<Fn> + <Pg Dn>		Ankstesnis	Grįžta prie ankstesnio medijų failo.
<Fn> + <End>		Toliau	Pereina prie paskesnio medijų failo.





## Uždaryto kompiuterio vaizdas iš priekio



#	Piktograma	Objektas	Aprašymas
		Maitinimo indikatorius	Nurodo kompiuterio energijos sistemos būklę.
1		Baterijos indikatorius	Nurodo kompiuterio baterijos būklę. <b>1. Kraunasi:</b> Kraunantis baterijai lemputė dega gintaro spalva. <b>2. Pilnai pakrauta:</b> Dirbant iš kintamos srovės (AC) tinklo lemputė dega mėlynai.
		HDD indikatorius	Nurodo ar kietasis diskas yra naudojamas (į jį rašoma ar skaitoma).
2		Mikrofono prijungimo lizdas	Skirtas prijungti išorinį mikrofoną.
		Ausinių/garsiakalbio kištukas	Skirtas audio prietaisams prijungti (pvz., garsiakalbiams, ausinėms).
3		„Multi-in-1“ atminties kortelių skaitytuvas	Skaito Secure Digital (SD), MultiMediaCard (MMC), Memory Stick PRO (MS PRO), xD-Picture Card (xD) tipų atminties korteles. <b>Pastaba:</b> Spauskite norėdami įdėti/išimti kortelę. Viena metu galima naudotis tik viena kortele.
4		Komunikacijos jungiklis/indikatorius	Įjungia/išjungia kompiuterio komunikacijos įrenginius/nurodo kompiuterio belaidžio ryšio įtaiso būseną.





## Vaizdas iš kairės



#	Piktograma	Objektas	Aprašymas
1		Nuolatinės srovės (DC) kištuko lizdas	Skirtas prijungti kintamos srovės (AC) adapteriui.
2		HDMI lizdas	Skirtas prijungti didelės raiškos skaitmeniniams vaizdo prietaisams.
3		Išorinio ekrano (VGA) lizdas	Skirtas prijungti papildomą monitorių (pvz. išorinį monitorių, LCD projektorių).
4		USB/eSATA lizdas	Prijungia USB arba eSATA įrenginius (tik tam tikruose modeliuose). <b>Pastaba:</b> Jei prijungsite eSATA įrenginį, galėsite naudotis trimis USB lizdais.
5		„SmartCard“ lizdas	Prijungia „SmartCard“.
6		„ExpressCard/34“ lizdas	Prijungia „ExpressCard/34“ modulį. <b>Pastaba:</b> Spauskite norėdami išimti/įdėti kortelę.

## Vaizdas iš dešinės







#	Piktograma	Objektas	Aprašymas
1		USB lizdas	Skirtas prijungti USB įrenginius.
2		USB lizdas	<i>Jei prievadas yra juodas, jis yra suderinamas su USB 2.0, jei jis yra mėlynas, jis taip pat yra suderinamas su USB 3.0.</i>
3		USB prievadas su įkrovimo išjungus funkcija	
4		Optinių diskų įrenginys	Vidinis optinių diskų įrenginys; skaito CD arba DVD.
5		Optinio disko darbo indikatorius	Dega kai optinių diskų įrenginys dirba.
6		Optinių diskų išstūmimo mygtukas	Atidaro optinių diskų įrenginio dureles.
7		Avarinio atidarymo anga	Atidaro optinių diskų įrenginio dureles kai kompiuteris yra išjungtas. <b>Pastaba:</b> <i>Norėdami esant išjungtam kompiuteriui atidaryti optinių diskų įrenginio dureles, į avarinio atidarymo angą įkiškite sąvaržėlę.</i>
8		Ethernet (RJ-45) lizdas	Skirtas prisijungti prie Ethernet 10/100/1000 tipo tinklo.
9		Kensington spynos lizdas	Skirtas užfiksuoti Kensington tipo kompiuterio užraktui. <b>Pastaba:</b> <i>Kompiuterio užrakto kabelį apvyniokite aplink nejudamą objektą, pvz. stalą arba užrakinto stalčiaus rankeną. Įkiškite užraktą į įpjovą ir pasukite raktelį, kad užsirakintų. Siūloma ir modelių be raktelių.</i>

## Informacija apie USB 3.0

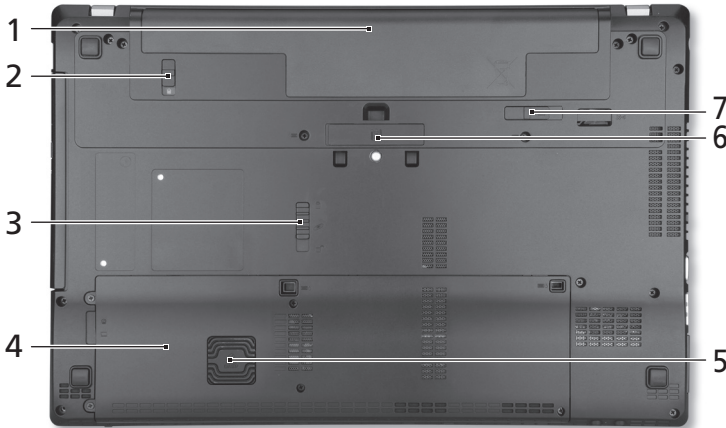
- Dera su USB 3.0 ir senesniais USB įrenginiais.
- Siekdami užtikrinti optimalų našumą, naudokite USB 3.0 sertifikuotus įrenginius.
- Nustatyta pagal USB 3.0 („SuperSpeed USB“) specifikaciją.

## Vaizdas iš apačios



#	Piktograma	Objektas	Aprašymas
1		Baterijos lizdas	Skirtas montuoti kompiuterio baterijai.
2		Baterijos užraktas	Fiksuoja įdėtą bateriją darbinėje padėtyje.
3		„Acer MediaBay“ fiksatorius	Atpalaiduoja „Acer MediaBay“ modulį.
4		Kietųjų diskų lizdas	Montuojamas kietasis diskas (įtvirtintas varžtais).
		Operatyviosios atminties lizdas	Montuojama pagrindinė kompiuterio atmintis.
5		„Acer DASP“ (disko apsauga nuo smūgių)	Apsaugo standųjį diską nuo smūgių ir atsitrekimų.
6		Acer ProDock jungtis	Prijungia pasirenkamą Acer ProDock.
7		Baterijos fiksatorius	Atpalaiduoja baterijos fiksavimą, leidžia ją išimti.



## Aplinka

---

- Temperatūra:
    - Darbinė: Nuo 5°C iki 35°C
    - Saugojimo: Nuo -20°C iki 65°C
  - Drėgmė (be kondensacijos):
    - Darbinė: Nuo 20% iki 80%
    - Saugojimo: Nuo 20% iki 80%
-



# Φορητός υπολογιστής TravelMate

## Γρήγορος οδηγός

### Δήλωση προϊόντος

Την πρώτη φορά που θα χρησιμοποιήσετε το προϊόν, συνιστάται να το δηλώνετε αμέσως. Αυτό σας παρέχει ορισμένα χρήσιμα πλεονεκτήματα, όπως:

- Ταχύτερη εξυπηρέτηση από τους εκπαιδευμένους εκπροσώπους μας.
- Ιδιότητα μέλους στην κοινότητα της Acer: λήψη προωθήσεων προϊόντων και συμμετοχή σε έρευνες πελατών.
- Τελευταίες ειδήσεις από την Acer.

Βιαστείτε και εγγραφείτε, καθώς σας περιμένουν και άλλα πλεονεκτήματα!

### Πώς θα εγγραφείτε

Για να δηλώσετε το προϊόν σας Acer, επισκεφθείτε τον ιστότοπο **www.acer.com**. Επιλέξτε τη χώρα σας, κάντε κλικ στο **ΔΗΛΩΣΗ ΠΡΟΙΟΝΤΟΣ** και ακολουθήστε τις απλές οδηγίες.

Θα σας ζητηθεί να δηλώσετε το προϊόν σας και κατά τη διάρκεια της διαδικασίας εγκατάστασης ή μπορείτε να κάνετε διπλό κλικ στο εικονίδιο Εγγραφή της επιφάνειας εργασίας.

Μετά τη δήλωση του προϊόντος, θα σας αποσταλεί επιβεβαιωτικό e-mail με σημαντικά στοιχεία που θα πρέπει να φυλάξετε σε ασφαλές μέρος.

### Αγορά αξεσουάρ Acer

Είμαστε στην ευχάριστη θέση να σας πληροφορήσουμε ότι το πρόγραμμα επέκτασης εγγύησης της Acer και τα αξεσουάρ φορητού υπολογιστή είναι διαθέσιμα online. Επισκεφθείτε το ηλεκτρονικό μας κατάστημα και βρείτε αυτό που χρειάζεστε στο **store.acer.com**.

Το κατάστημα της Acer βρίσκεται στο στάδιο της ανάπτυξης και, δυστυχώς, ενδέχεται να μην είναι διαθέσιμο σε κάποιες περιοχές. Ελέγχετε τακτικά για να διαπιστώσετε πότε θα είναι διαθέσιμο στη χώρα σας.

© 2012 Με την επιφύλαξη κάθε νόμιμου δικαιώματος.

Σύντομος οδηγός φορητού υπολογιστή TravelMate  
Αυτή η αναθεώρηση: 07/2012

Αριθμός μοντέλου: \_\_\_\_\_

Σειριακός αριθμός: \_\_\_\_\_

Ημερομηνία αγοράς: \_\_\_\_\_

Τόπος αγοράς: \_\_\_\_\_

## Πρώτα από όλα

Θα επιθυμούσαμε να σας ευχαριστήσουμε που επιλέξατε το φορητό υπολογιστή της Acer με σκοπό την αντιμετώπιση των αναγκών σας για φορητό υπολογιστή.

## Οι οδηγοί σας

Για να σας βοηθήσουμε στη χρήση του φορητού υπολογιστή της Acer, έχουμε σχεδιάσει ένα σετ εγχειριδίων χρήσης:

Πρώτα απ' όλα, η **Αφίσα εγκατάστασης** σας βοηθά να ξεκινήσετε με την εγκατάσταση του υπολογιστή σας.

Ο **Γρήγορος οδηγός** παρουσιάζει τις βασικές δυνατότητες και λειτουργίες του νέου σας υπολογιστή.

Για περισσότερες πληροφορίες όσον αφορά στον τρόπο με τον οποίο ο υπολογιστής μπορεί να σας βοηθήσει να αυξήσετε την παραγωγικότητά σας, ανατρέξτε στο **Εγχειρίδιο Χρήστη**. Το **Εγχειρίδιο Χρήστη** περιέχει χρήσιμες πληροφορίες που ισχύουν για το νέο σας υπολογιστή. Καλύπτει βασικά θέματα όπως τη χρήση του πληκτρολογίου και τον ήχο κ.τ.λ.

Ο οδηγός αυτός περιλαμβάνει λεπτομερείς πληροφορίες για θέματα όπως τα βοηθητικά προγράμματα του συστήματος, την ανάκτηση δεδομένων, τις επιλογές επέκτασης και την αντιμετώπιση προβλημάτων. Επιπλέον, περιλαμβάνει πληροφορίες σχετικά με την εγγύηση καλής λειτουργίας και τους γενικούς κανονισμούς όπως και τις προειδοποιήσεις ασφαλείας για το φορητό υπολογιστή.

Ακολουθήστε τα επόμενα βήματα για την πρόσβαση σε αυτόν.





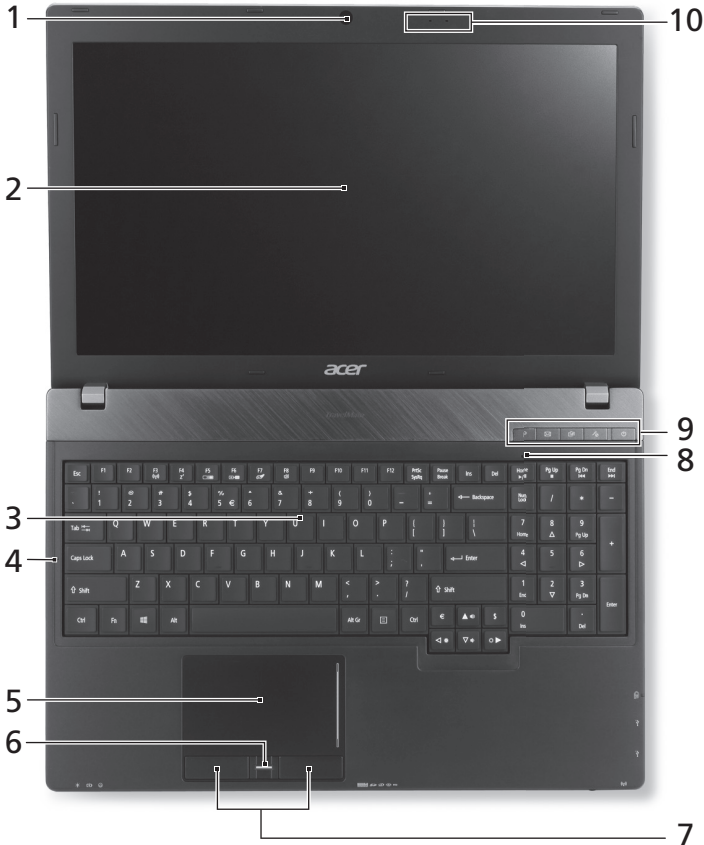

- 1 Πληκτρολογήστε "User" από το *Έναρξη*.
- 2 Κάντε κλικ στο **Εγχειρίδιο Χρήστη Acer**.

# Μια ξενάγηση του φορητού υπολογιστή Acer

Μετά την εγκατάσταση του υπολογιστή όπως απεικονίζεται στην αφίσα εγκατάστασης, θα σας περιγράψουμε τα διάφορα μέρη του νέου σας φορητού υπολογιστή της Acer.

## Κάτοψη















#	Εικονίδιο	Στοιχείο	Περιγραφή
1		Ενσωματωμένη κάμερα διαδικτύου	Κάμερα διαδικτύου για βιντεοεπικοινωνία. <i>Ένα λαμπάκι δίπλα στην κάμερα διαδικτύου επισημαίνει ότι η κάμερα διαδικτύου είναι ενεργοποιημένη.</i>
2		Οθόνη	Καλείται επίσης Οθόνη Υγρών Κρυστάλλων (Liquid-Crystal Display, LCD), απεικονίζει την έξοδο του υπολογιστή (Η διαμόρφωση ενδέχεται να ποικίλλει ανάλογα με το μοντέλο).
3		Πληκτρολόγιο	Χρησιμοποιείται για την καταχώριση δεδομένων στον υπολογιστή.
4		Caps Lock	Ανάβει όταν ενεργοποιηθεί το Caps Lock.
5		Επιφάνεια αφής	Συσκευή κατάδειξης ευαίσθητη στην αφή που λειτουργεί ως ποντίκι υπολογιστή.
6		Μονάδα ανάγνωσης δαχτυλικών αποτυπωμάτων	Μονάδα ανάγνωσης δαχτυλικών αποτυπωμάτων για το Acer ProShield Security Suite.
7		Κουμπιά κλικ (αριστερό και δεξιό)	Το κουμπιά, αριστερό και δεξιό, λειτουργούν σαν τα κουμπιά, αριστερό και δεξιό, του ποντικιού.
8		Num Lock	Ανάβει όταν ενεργοποιηθεί το Num Lock.
		Πλήκτρο P	Προγραμματιζόμενο πλήκτρο (η διαμόρφωση ενδέχεται να ποικίλλει ανάλογα με το μοντέλο).
		Πλήκτρο email Acer	Ανοίγει την προεπιλεγμένη εφαρμογή email.
9		Πλήκτρο δημιουργίας αντιγράφου ασφαλείας	Εκτελεί το Acer Backup Management για τη διαδικασία δημιουργίας αντιγράφου ασφαλείας δεδομένων σε τρία βήματα.
		Σίγαση μικροφώνου	Σιγεί το μικρόφωνο.
		Κουμπί/ενδεικτική λυχνία τροφοδοσίας	Ενεργοποιεί και απενεργοποιεί τον υπολογιστή. Δηλώνει την κατάσταση τροφοδοσίας του υπολογιστή.
10		Μικρόφωνα	Δύο εσωτερικά μικρόφωνα για εγγραφή στερεοφωνικού ήχου.



## Πλήκτρα συντόμευσης

Ο υπολογιστής χρησιμοποιεί πλήκτρα συντόμευσης ή συνδυασμούς πλήκτρων για πρόσβαση στα περισσότερα από τα στοιχεία ελέγχου του υπολογιστή, όπως η φωτεινότητα οθόνης και η ένταση ήχου.

Για να ενεργοποιήσετε τα πλήκτρα συντόμευσης, πιάστε παρατεταμένα το πλήκτρο **<Fn>** πριν πιάσετε το άλλο πλήκτρο του συνδυασμού πλήκτρων συντόμευσης.



Πλήκτρο συντόμευσης	Εικονίδιο	Λειτουργία	Περιγραφή
<b>&lt;Fn&gt; + &lt;F3&gt;</b>		Επικοινωνία	Ενεργοποιεί/απενεργοποιεί τις συσκευές επικοινωνίας του υπολογιστή.
<b>&lt;Fn&gt; + &lt;F4&gt;</b>		Αναμονή	Θέτει τον υπολογιστή σε λειτουργία αναμονής.
<b>&lt;Fn&gt; + &lt;F5&gt;</b>		Εναλλαγή οθόνης	Μεταγωγή της εξόδου οθόνης μεταξύ οθόνης απεικόνισης, εξωτερικού μόνιτορ (εάν υπάρχει) ή και των δύο.
<b>&lt;Fn&gt; + &lt;F6&gt;</b>		Κενή οθόνη	Απενεργοποιεί τον οπίσθιο φωτισμό της οθόνης απεικόνισης για εξοικονόμηση ενέργειας. Πιάστε οποιοδήποτε πλήκτρο για επιστροφή.
<b>&lt;Fn&gt; + &lt;F7&gt;</b>		Εναλλαγή Επιφάνειας Αφής	Ενεργοποιεί και απενεργοποιεί την εσωτερική επιφάνεια αφής.
<b>&lt;Fn&gt; + &lt;F8&gt;</b>		Εναλλαγή ηχείων	Ενεργοποιεί και απενεργοποιεί τα ηχεία.
<b>&lt;Fn&gt; + &lt;D&gt;</b>		Αύξηση φωτεινότητας	Αυξάνει τη φωτεινότητα της οθόνης.
<b>&lt;Fn&gt; + &lt;D&gt;</b>		Μείωση φωτεινότητας	Μειώνει τη φωτεινότητα της οθόνης.
<b>&lt;Fn&gt; + &lt;Δ&gt;</b>		Αύξηση έντασης	Αυξάνει την ένταση του ήχου.
<b>&lt;Fn&gt; + &lt;∇&gt;</b>		Μείωση έντασης	Μειώνει την ένταση του ήχου.
<b>&lt;Fn&gt; + &lt;Home&gt;</b>		Αναπαραγωγή/ Πάυση	Αναπαραγωγή ή παύση ενός επιλεγμένου αρχείου μέσων.
<b>&lt;Fn&gt; + &lt;Pg Up&gt;</b>		Διακοπή	Διακοπή αναπαραγωγής του επιλεγμένου αρχείου μέσων.



Πλήκτρο συντόμευσης	Εικονίδιο	Λειτουργία	Περιγραφή
<Fn> + <Pg Dn>		Προηγούμενο	Επιστροφή στο προηγούμενο αρχείο μέσων.
<Fn> + <End>		Επόμενο	Πηδήξτε στο επόμενο αρχείο μέσων.

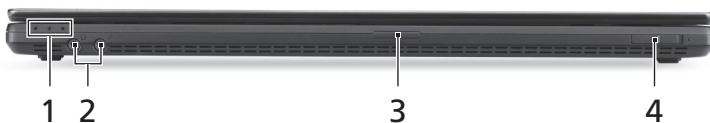



## Πρόσοψη με το καπάκι κλειστό



#	Εικονίδιο	Στοιχείο	Περιγραφή
		Ενδεικτική λυχνία τροφοδοσίας	Δηλώνει την κατάσταση τροφοδοσίας του υπολογιστή.
1		Ενδεικτική λυχνία μπαταρίας	<p>Δηλώνει την κατάσταση της μπαταρίας του υπολογιστή.</p> <p><b>1. Φόρτιση:</b> Η ενδεικτική λυχνία κατά τη φόρτιση της μπαταρίας μετατρέπεται σε πορτοκαλί.</p> <p><b>2. Πλήρως φορτισμένη:</b> Η ενδεικτική λυχνία γίνεται μπλε όταν βρίσκεται σε λειτουργία εναλλασσόμενου ρεύματος (AC).</p>
		Ενδεικτική λυχνία HDD	Δηλώνει πότε είναι ενεργοποιημένη η μονάδα σκληρού δίσκου.
2		Τζακ μικροφώνου	Δέχεται εισόδους από εξωτερικά μικρόφωνα.
		Βύσμα (τζακ) ακουστικών/ηχείου	Συνδέεται σε συσκευές ήχου (π.χ. ηχεία, ακουστικά).
3		Αναγνώστης καρτών πολλών-σε-1	<p>Δέχεται Secure Digital (SD), MultiMediaCard (MMC), Memory Stick PRO (MS PRO) και xD-Picture Card (xD).</p> <p><b>Σημείωση:</b> Πιέστε για αφαίρεση/τοποθέτηση της κάρτας. Οιαδήποτε στιγμή είναι δυνατή η ανάγνωση μόνο μιας κάρτας.</p>
4		Διακόπτης/ενδεικτική λυχνία επικοινωνίας	Ενεργοποιεί/απενεργοποιεί τις συσκευές επικοινωνίας του υπολογιστή/επισημαίνει την κατάσταση της συσκευής ασύρματης σύνδεσης του υπολογιστή.

## Αριστερή πλευρά



#	Εικονίδιο	Στοιχείο	Περιγραφή
1		Τζακ εισόδου συνεχούς ρεύματος (DC)	Συνδέεται σε προσαρμογέα εναλλασσόμενου ρεύματος (AC).
2		Θύρα HDMI	Υποστηρίζει συνδέσεις ψηφιακού βίντεο υψηλής ανάλυσης.
3		Θύρα εξωτερικής οθόνης απεικόνισης (VGA)	Συνδέεται σε συσκευή απεικόνισης (π.χ. εξωτερικό μόνιτορ, προβολέα LCD).
4		Θύρα USB/eSATA	Συνδέεται με συσκευές USB ή eSATA (ορισμένα μοντέλα μόνο). <b>Σημείωση:</b> Αν συνδεθείτε με συσκευή eSATA, θα έχετε διαθέσιμες τρεις θύρες USB.
5		Υποδοχή SmartCard	Δέχεται την SmartCard.
6		Υποδοχή κάρτας ExpressCard/34	Δέχεται μία μονάδα ExpressCard/34. <b>Σημείωση:</b> Πιέστε για αφαίρεση/ τοποθέτηση της κάρτας.

## Δεξιά πλευρά



#	Εικονίδιο	Στοιχείο	Περιγραφή
1		Θύρα USB	
2		Θύρα USB	Συνδέεται σε συσκευές USB. <i>Αν μια θύρα είναι μαύρη, είναι συμβατή με USB 2.0, ενώ αν είναι μπλε, είναι συμβατή με USB 3.0.</i>
3		Θύρα USB με φόρτιση σε κατάσταση απενεργοποίησης	
4		Μονάδα οπτικού δίσκου	Εσωτερική μονάδα οπτικού δίσκου, δέχεται CD ή DVD.
5		Φωτεινή ένδειξη πρόσβασης οπτικού δίσκου	Ανάβει κατά την ενεργοποίηση της μονάδας οπτικού δίσκου.
6		Κουμπί εκτίναξης της μονάδας οπτικού δίσκου	Χρησιμοποιείται για την εκτίναξη του συρταριού της μονάδας οπτικού δίσκου από τη μονάδα.
7		Οπή έκτακτης εκτίναξης	Χρησιμοποιείται για την εκτίναξη του συρταριού της μονάδας οπτικού δίσκου όταν ο υπολογιστής είναι απενεργοποιημένος. <b>Σημείωση:</b> Τοποθετήστε ένα μεταλλικό συνδετήρα μέσα στην οπή έκτακτης εκτίναξης για εκτίναξη του συρταριού της μονάδας οπτικού δίσκου όταν ο υπολογιστής είναι απενεργοποιημένος.
8		Θύρα Ethernet (RJ-45)	Συνδέεται σε δίκτυο Ethernet 10/100/1000.

#	Εικονίδιο	Στοιχείο	Περιγραφή
9		Υποδοχή λουκέτου τύπου Kensington	<p>Συνδέεται σε λουκέτο ασφαλείας υπολογιστή συμβατό με Kensington.</p> <p><b>Σημείωση:</b> Τυλίξτε το καλώδιο της κλειδαριάς ασφαλείας γύρω από ένα αμετακίνητο αντικείμενο όπως ένα τραπέζι ή το χερούλι ενός κλειδωμένου συρταριού. Εισάγετε την κλειδαριά στην εγκοπή και γυρίστε το κλειδί για να ασφαλίσετε την κλειδαριά. Διατίθενται επίσης μερικά μοντέλα χωρίς κλειδί.</p>

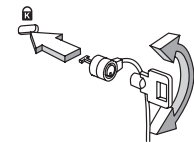



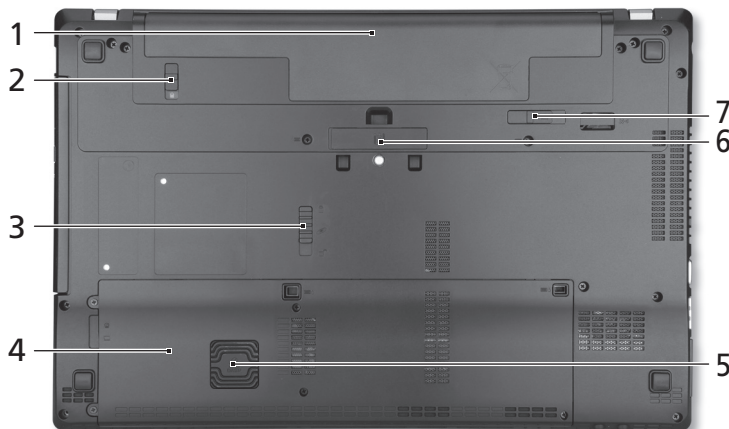

## Πληροφορίες για το USB 3.0

- Συμβατό με USB 3.0 και παλαιότερες συσκευές USB.
- Για βέλτιστη απόδοση, χρησιμοποιείτε συσκευές με πιστοποίηση USB 3.0.
- Καθορίζεται από την προδιαγραφή USB 3.0 (SuperSpeed USB).

## Όψη βάσης



#	Εικονίδιο	Στοιχείο	Περιγραφή
1		Φατνίο μπαταρίας	Περιέχει το πακέτο μπαταρίας του υπολογιστή.
2		Λουκέτο μπαταρίας	Ασφαλίζει τη μπαταρία στη θέση της.

#	Εικονίδιο	Στοιχείο	Περιγραφή
3		Μάνδαλο απασφάλισης Acer MediaBay	Απασφαλίζει τη μονάδα Acer MediaBay.
4		Φατνίο σκληρού δίσκου	Περιέχει το σκληρό δίσκο του υπολογιστή (ασφαλίζεται με βίδες).
		Διαμέρισμα μνήμης	Περιέχει την κύρια μνήμη του υπολογιστή.
5		Acer DASP (Disk Anti-Shock Protection)	Προστατεύει τη μονάδα σκληρού δίσκου από κραδασμούς και βίαια τραντάγματα.
6		Συνδετήρας Acer ProDock	Συνδέεται στο προαιρετικό Acer ProDock.
7		Μάνδαλο απασφάλισης μπαταρίας	Απασφαλίζει τη μπαταρία για αφαίρεση.

## Περιβάλλον

- Θερμοκρασία:
  - Λειτουργίας: 5°C έως 35°C
  - Μη λειτουργίας: -20°C έως 65°C
- Υγρασία (μη συμπυκνούμενη):
  - Λειτουργίας: 20% έως 80%
  - Μη λειτουργίας: 20% έως 80%



# TravelMate Dizüstü

## Hızlı Başlama Kılavuzu

### Ürün kaydı

Ürününüzü ilk kez kullanırken, hemen kayıt olmanız önerilir. Böylece aşağıdaki gibi bazı faydalı yerlere erişim sağlayabileceksiniz:

- Eğitimli bir temsilciden hızlı hizmet alımı.
- Acer topluluğuna üyelik: promosyonlar alın ve müşteri anketlerine katılın.
- Acer'dan en yeni haberler.

Acele edin ve kaydolun, diğer avantajlar sizi bekliyor!

### Nasıl kaydolursunuz

Acer ürününüzü kaydettirmek için lütfen [www.acer.com](http://www.acer.com)'u ziyaret edin. Ülkenizi seçin, **ÜRÜN KAYDI**'ni tıklatın ve verilen talimatları uygulayın.

Kurulum sırasında da ürününüzü kaydettirmeniz istenecek. Masaüstündeki Kayıt simgesini de çift tıklatabilirsiniz.

Ürün kaydınızı aldıktan sonra güvenilir bir yerde saklamanız istenen bir onay epostası alacaksınız.

### Acer Aksesuarları Alma

Acer'ın garanti uzatma programı ve Dizüstü bilgisayar aksesuarlarının çevrimiçi satın alınabileceğini size bildirmekten memnuniyet duyarız. [store.acer.com](http://store.acer.com) adresindeki çevrimiçi mağazamızı ziyaret edin ve aradıklarınızı bulun.

Acer mağazası kademeli olarak hizmete açılmaktadır ve maalesef bazı bölgelerde kullanılamıyor olabilir. Lütfen ülkenizde ne zaman hizmet vereceğini görmek için sık kontrol edin.

© 2012 Tüm Hakları Saklıdır.

TravelMate Dizüstü Hızlı Başlangıç Kılavuzu  
Bu deęişiklik: 07/2012

Model numarası: \_\_\_\_\_

Seri numarası: \_\_\_\_\_

Satın alma Tarihi: \_\_\_\_\_

Satın alma yeri: \_\_\_\_\_



## İlk Yapılacaklar

Taşınabilir bilgisayar ihtiyacınızı karşılamak için Acer dizüstü bilgisayarını tercih ettiğiniz için teşekkür ederiz.

## Kılavuzlarınız

Acer dizüstü bilgisayarını kullanırken size yardımcı olması için bir dizi kılavuz tasarladık:

İlk olarak **Ayar Poster**i bilgisayarınızı ayarlamanıza yardımcı olur.

**Hızlı Başlama Kılavuzu** size yeni bilgisayarınızın temel özelliklerini ve işlevlerini tanıtır.

Bilgisayarınızın, daha üretken olmanızı sağlamasına nasıl yardımcı olabileceği ile ilgili daha fazla bilgi için lütfen **Kullanım Kılavuzu**'na bakın. **Kullanım Kılavuzu**, yeni bilgisayarınızla ilgili yararlı bilgiler içerir. Klavyeyi kullanma, Ses vs. gibi temel konular içermektedir.

Bu kılavuz sistem hizmet programları, veri düzeltme, genişletme seçenekleri ve arıza giderme üzerine detaylı bilgiler içermektedir. Buna ek olarak bilgisayarınızla ilgili garanti bilgileri, genel kuralları ve güvenlik uyarılarını içerir.

Ulaşmak için şu adımları izleyin:

- 1 **Başla**'ta "Kullanım" yazın.
- 2 **Acer Kullanım Kılavuzu**'na tıklayın.





## Acer dizüstü bilgisayarınızda bir gezinti

Bilgisayarınızı ayar posterinde gösterildiği gibi ayarladıktan sonra yeni Acer dizüstü bilgisayarınızı tanıtmamıza izin verin.

### Üstten görünüş



#	Simge	Öğe	Açıklama
1		Tümleşik video kamera	Görüntülü iletişim için video kamera. <i>Web kamerasının yanında bir ışık, web kamerasının etkin olduğunu gösterir.</i>

#	Simge	Öge	Açıklama
2		Ekran	Sıvı Kristal Ekran (LCD) olarak da bilinir ve bilgisayar çıktılarını gösterir (yapılandırma modellere göre farklı olabilir).
3		Klavye	Bilgisayarınıza veri girebilmek için.
4		Caps Lock	Caps Lock etkin olduğunda yanar.
5		Dokunmatik yüzey	Bilgisayar faresi gibi fonksiyonu olan, dokunmaya duyarlı işaret aygıtı.
6		Parmakizi okuyucu	Acer ProShield Security Suite için parmakizi okuyucu.
7		Tıklama tuşları (sol ve sağ)	Sol ve sağ düğmeler, bilgisayar faresinin sağ ve sol düğmeleri ile aynı işleve sahiptir.
8		Num Lock	Num Lock etkin olduğunda yanar.
		P tuşu	Programlanabilir tuş (yapılandırma modele göre farklı olabilir).
		Acer e-posta tuşu	Varsayılan e-posta uygulamanızı açar.
9		Yedekleme Tuşu	Üç adımda veri yedeklemesi için Acer Backup Management'ı başlatır.
		Mikrofon sessiz	Mikrofon sesini kapatır.
		Güç düğmesi/ göstergesi	Bilgisayarı açar ve kapatır. Bilgisayarın güç durumunu gösterir.
10		Mikrofonlar	Stereo ses kaydı için iki dahili mikrofon.

## Kısayol Tuşları

Bilgisayarda, ekran parlaklığı ve ses çıkışı gibi bilgisayarın birçok kontrolüne erişimin sağlanması için faydalı tuşlar yer almaktadır.

Kısayol tuşlarını etkinleştirmek için, kısayol tuş kombinasyonundaki diğer tuşa basmadan önce **<Fn>** tuşuna basılı tutun.

Kısayol tuşu	Simge	İşlev	Açıklama
<b>&lt;Fn&gt; + &lt;F3&gt;</b>		İletişim	Bilgisayarın iletişim aygıtlarını etkinleştirir/devre dışı bırakır.
<b>&lt;Fn&gt; + &lt;F4&gt;</b>		Uyku	Bilgisayarı Uyku moduna sokar.
<b>&lt;Fn&gt; + &lt;F5&gt;</b>		Ekran değişikliği	Görüntü ekranı, harici monitör (eğer bağlıysa) ve ikisi arasında ekran çıktısını değiştirir.
<b>&lt;Fn&gt; + &lt;F6&gt;</b>		Ekran boş	Görüntü ekran arka ışığını, güçten kazanmak için kapatır. Geriye dönmek için herhangi bir tuşa basın.
<b>&lt;Fn&gt; + &lt;F7&gt;</b>		Dokunmatik yüzey değişikliği	Dahili dokunmatik yüzeyi açar ve kapatır.
<b>&lt;Fn&gt; + &lt;F8&gt;</b>		Hoparlör değişikliği	Hoparlörleri açar ve kapatır.
<b>&lt;Fn&gt; + &lt;▶▶&gt;</b>		Parlaklığı artır	Ekran parlaklığını artırır.
<b>&lt;Fn&gt; + &lt;◀◀&gt;</b>		Parlaklığı azalt	Ekran parlaklığını azaltır.
<b>&lt;Fn&gt; + &lt;▲&gt;</b>		Ses aç	Sesi artırır.
<b>&lt;Fn&gt; + &lt;▼&gt;</b>		Ses kapat	Sesi azaltır.
<b>&lt;Fn&gt; + &lt;Giriş&gt;</b>		Yürüt/Duraklat	Seçilen ortam dosyasını oynatın veya duraklatın.
<b>&lt;Fn&gt; + &lt;Pg Up&gt;</b>		Durdur	Seçilen ortam dosyasının oynatılmasını durdurur.
<b>&lt;Fn&gt; + &lt;Pg Dn&gt;</b>		Önceki	Önceki ortam dosyasına döner.

Kısayol tuşu	Simge	İşlev	Açıklama
<Fn> + <Bitir>	▶▶	İleri	Sonraki ortam dosyasına geçer.



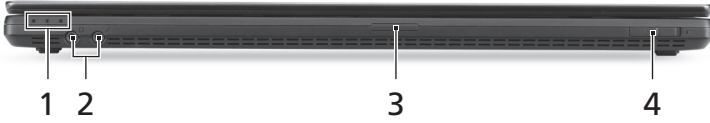

## Kapalı ön görünüm



#	Simge	Öge	Açıklama
		Güç göstergesi	Bilgisayarın güç durumunu gösterir.
1		Pil göstergesi	Bilgisayarın pil durumunu gösterir. <b>1. Şarj:</b> Pil şarj olurken ışık kehribar renginde yanar. <b>2. Tamamen şarj oldu:</b> AC modundayken ışık mavi yanar.
		Sabit disk göstergesi	Sabit diskin etkin olduğunu gösterir.
2		Mikrofon jakı	Harici mikrofon girişlerini kabul eder.
		Kulaklık/hoparlör jakı	Ses aygıtlarına bağlanır (örneğin, hoparlörler, kulaklıklar).
3		Çoklu kart okuyucu	Secure Digital (SD), MultiMediaCard (MMC), Memory Stick PRO (MS PRO), xD-Picture Card'ı (xD) kabul eder. <b>Not:</b> Kartı çıkartmak/takmak için itin. Herhangi bir zamanda sadece bir kart çalışabilir.
4		İletişim anahtarı/ göstergesi	Bilgisayarın iletişim aygıtlarını etkinleştirir/engeller, bilgisayarın kablosuz aygıt bağlantı durumunu gösterir.

## Sol görünüm



#	Simge	Öğe	Açıklama
1		DC-in jakı	AC adaptöre bağlanır.
2		HDMI portu	Yüksek çözünürlüklü (High Definition) dijital video bağlantılarını destekler.
3		Harici görüntü (VGA) portu	Bir görüntü aygıtına bağlar (örneğin, harici monitör, LCD projektör).
4		USB/eSATA portu	USB veya eSATA aygıtlarına bağlanır (sadece belli modellerde). <b>Not:</b> eSATA aygıtı bağlarsanız üç USB portu kullanabilirsiniz.
5		SmartCard yuvası	SmartCard'ı kabul eder.
6		ExpressCard/34 yuvası	Bir ExpressCard/34 modülünü kabul eder. <b>Not:</b> Kartı çıkartmak/takmak için itin.

## Sağ görünüm







#	Simge	Öğe	Açıklama
1		USB portu	
2		USB portu	USB aygıtlarına bağlanır. <i>Eğer bağlantı noktası siyahsa, USB 2.0 uyumludur, bağlantı noktası maviyse aynı zamanda USB 3.0 uyumludur.</i>
3		Kapalıyken şarj özellikli USB bağlantı noktası	
4		Optik sürücü	Dahili optik sürücü; CD'leri veya DVD'leri kabul eder.
5		Optik sürücü erişim göstergesi	Optik sürücü etkinken yanar.
6		Optik sürücü çıkarma tuşu	Optik diski sürücüden çıkarır.
7		Acil durum çıkarma yuvası	Bilgisayar kapandığında optik sürücü tepsisini çıkarır. <b>Not:</b> Bilgisayar kapatıldığında optik sürücü tepsisini çıkarmak için acil durum çıkarma yuvasına bir kağıt atacı sokun.
8		Ethernet (RJ-45) portu	Ethernet 10/100/1000-temelli ağa bağlar.
9		Kensington kilit yuvası	Kensington-uyumlu bilgisayar güvenlik kilidine bağlar. <b>Not:</b> Bilgisayar güvenlik kilidi kablosunu, masa ya da kilitli bir çekmecenin tutacağı gibi hareket etmeyen bir nesnenin etrafına dolayın. Kilidi çentiğe sokun ve kilidi kapamak için anahtarını çevirin. Anahtarsız modeller de mevcuttur.

## USB 3.0 hakkında bilgi

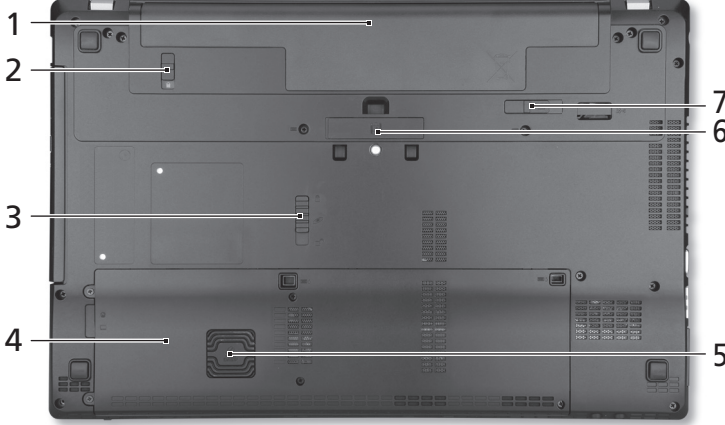
- USB 3.0 ya da daha önceki aygıtlarla uyumludur.
- En iyi performans için USB 3.0 onaylı cihazlar kullanın.
- USB 3.0 (SuperSpeed USB) spesifikasyonları tarafından tanımlanmıştır.

## Alt görünüm



#	Simge	Öge	Açıklama
1		Pil bölmesi	Bilgisayar pil takımının yeridir.
2		Pil kilidi	Pil yerine oturduğunda kilittir.
3		Acer MediaBay açma mandalı	Acer MediaBay modülünü serbest bırakır.
4		Sabit disk yuvası	Bilgisayarın sabit diskini barındırır (vidalarla sabitlenmiştir).
		Bellek bölmesi	Bilgisayarın ana hafızasını barındırır.
5		Acer DASP (Disk Çarpmaya Karşı Koruma)	Sabit diski darbelere ve sarsıntılara karşı korur.
6		Acer ProDock konektörü	İsteğe bağlı Acer ProDock'a bağlantı sağlar.
7		Pil çıkarma mandalı	Çıkarılabilmesi için pili serbest duruma getirir.



## Ortam

---

- Sıcaklık:
    - Çalışma: 5°C ila 35°C arasında
    - Çalışmadığı durumda: -20°C ila 65°C arasında
  - Nem (yoğunlaşmayan):
    - Çalışma: %20 ila %80 arasında
    - Çalışmadığı durumda: %20 ila %80 arasında
-



# TravelMate 노트북

## 빠른 시작 설명서

### 제품 등록

제품을 처음 사용할 때 즉시 등록하는 것이 좋습니다. 제품을 등록하면 다음과 같은 혜택을 받을 수 있습니다 :

- 교육받은 전문가의 빠른 서비스 .
- Acer 커뮤니티 회원 자격 부여 : 홍보자료 수신 및 고객 설문 조사 참여 .
- Acer 로부터 최신 뉴스 수신 .

서둘러 등록하십시오 . 이 외에도 많은 혜택이 기다리고 있습니다 !

### 등록 방법

Acer 제품을 등록하려면 **www.acer.com** 을 방문하십시오 . 국가를 선택하고 **제품 등록** 을 클릭한 다음 간단한 지침을 따릅니다 .

설치 과정에서도 제품 등록 메시지가 나타나며 , 바탕화면에서 등록 아이콘을 두 번 클릭할 수도 있습니다 .

제품 등록이 접수된 후 중요한 데이터가 포함된 확인 전자 메일을 보내드립니다 . 이를 안전한 곳에 보관해야 합니다 .

### Acer 액세서리 구하기

Acer 의 보증 연장 프로그램과 노트북 액세서리를 온라인에서 이용할 수 있게 되었음을 알려드리게 되어 기쁩니다 . 당사 온라인 쇼핑몰 **store.acer.com** 을 방문하여 귀하에게 필요한 것을 검색하십시오 .

Acer 스토어는 점진적으로 출시 중이며 , 불행히도 일부 지역에서는 사용하지 못할 수도 있습니다 . 거주 중인 국가에서 사용 가능한지 정기적으로 확인해 보십시오 .

© 2012 모든 권리 보유 .

**TravelMate** 노트북 빠른 시작 설명서  
이 버전 : 07/2012

모델 번호 : \_\_\_\_\_

일련 번호 : \_\_\_\_\_

구입 날짜 : \_\_\_\_\_

구입 장소 : \_\_\_\_\_

## 사용 전 유의 사항

Acer 노트북을 선택해주셔서 감사합니다. 이 노트북이 귀하의 모바일 컴퓨팅 요구를 충족시켜 드릴 것입니다.

## 제공되는 설명서

Acer 노트북을 사용하는 데 도움을 줄 수 있는 여러 설명서가 제공됩니다.

**설치 포스터**는 컴퓨터 설정을 시작하는 데 유용합니다.

**빠른 시작 설명서**에서는 새 컴퓨터의 기본 특징 및 기능을 소개합니다.

컴퓨터를 좀더 생산적으로 활용하는 방법에 대한 자세한 내용은 **사용 설명서**를 참조하십시오. **사용 설명서**에는 새로 구입한 컴퓨터와 관련된 유용한 정보가 들어 있습니다. 이 설명서에서는 키보드 사용, 오디오 등과 같은 기본적인 주제를 다룹니다.

이 설명서에서는 시스템 유틸리티, 데이터 복구, 확장 옵션 및 문제 해결과 같은 주제를 자세하게 설명합니다. 또한 노트북에 대한 일반 규정과 안전 주의 사항 및 보증 정보가 포함되어 있습니다.

다음 단계에 따라 설명서에 액세스할 수 있습니다.

- 1 시/쪽에서 "사용자"를 입력합니다.
- 2 **Acer 사용 설명서**를 클릭합니다.

## Acer 노트북 둘러보기

설치 포스터에 설명된 대로 컴퓨터를 설정했으면 이제 새 Acer 노트북을 살펴볼 차례입니다.

### 위에서 본 모습

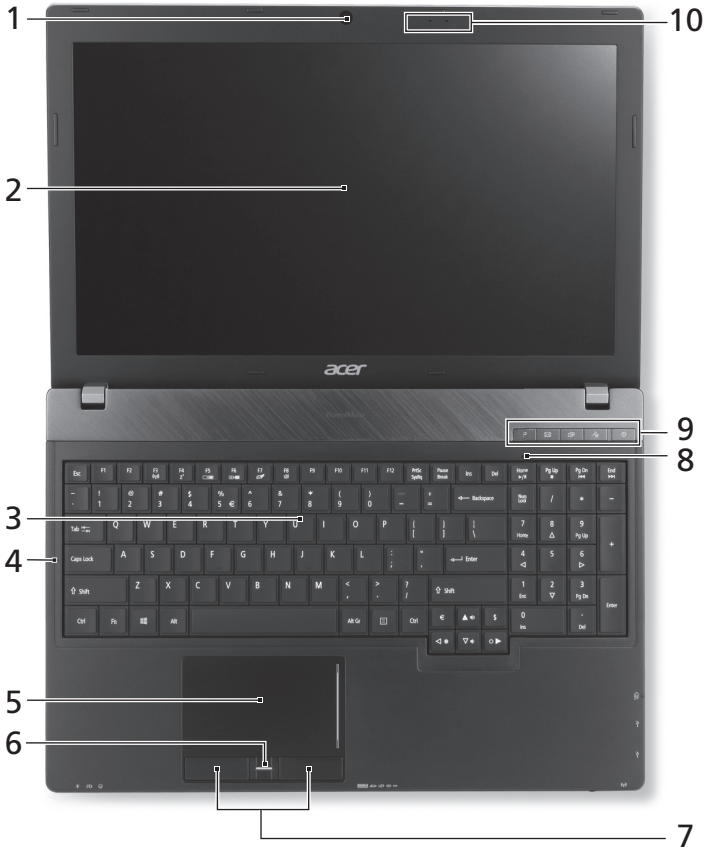

#	아이콘	항목	설명
1		통합형 웹캠	비디오 통신용 웹 카메라입니다 . <i>웹캠 옆의 불빛은 웹캠이 작동 중임을 나타냅니다.</i>
2		화면	LCD ( 액정 디스플레이 ) 라고도 하며 , 컴퓨터 출력을 표시합니다 ( 구성은 모델에 따라 다를 수 있음 ) .
3		키보드	컴퓨터에 데이터를 입력하는 데 사용됩니다 .
4		Caps Lock	Caps Lock 이 활성화되어 있으면 불이 켜집니다 .
5		터치패드	컴퓨터 마우스와 같은 역할을 하는 접촉식 포인팅 장치입니다 .
6		지문 판독기	Acer ProShield Security Suite 를 위한 지문 판독기입니다 .
7		누름 단추들 ( 왼쪽 및 오른쪽 )	왼쪽과 오른쪽의 단추는 마우스의 왼쪽 및 오른쪽 단추와 같은 역할을 합니다 .
8		Num Lock	Num Lock 이 활성화되어 있으면 불이 켜집니다 .
		P 키	프로그램 가능한 키 ( 구성은 모델에 따라 다를 수 있음 ) .
		Acer 전자 메일 키	기본 전자 메일 응용 프로그램을 엽니다 .
9		백업 키	Acer Backup Management 를 실행하여 3 단계로 데이터를 백업합니다 .
		마이크 음소거	마이크를 음소거합니다 .
		전원 단추 / 표시등	컴퓨터를 켜고 끕니다 . 컴퓨터의 전원 상태를 표시합니다 .
10		마이크	소리를 녹음할 수 있는 두 개의 내부 마이크입니다 .

## 바로 가기 키

컴퓨터에서는 화면 밝기와 볼륨 출력 같은 대부분의 컴퓨터 컨트롤에 액세스하기 위해 바로 가기 키 또는 키 조합이 사용됩니다.





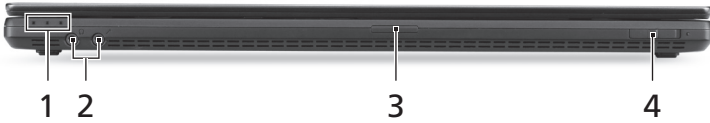

바로 가기 키를 활성화하려면 바로 가기 키 조합의 다른 키를 누르기 전에 **<Fn>** 키를 누릅니다.

바로 가기 키	아이콘	기능	설명
<b>&lt;Fn&gt; + &lt;F3&gt;</b>		통신	컴퓨터의 통신 장치를 활성화 / 비활성화합니다.
<b>&lt;Fn&gt; + &lt;F4&gt;</b>		절전	컴퓨터를 절전 모드로 설정합니다.
<b>&lt;Fn&gt; + &lt;F5&gt;</b>		디스플레이 전환	디스플레이 출력을 디스플레이 화면, 외부 모니터 (연결된 경우) 또는 둘 다에 보내도록 선택합니다.
<b>&lt;Fn&gt; + &lt;F6&gt;</b>		화면 끄기	전원을 절약하기 위해 디스플레이 화면의 백라이트를 끕니다. 화면을 다시 켜려면 임의의 키를 누릅니다.
<b>&lt;Fn&gt; + &lt;F7&gt;</b>		터치패드 전환	내부 터치패드를 켜고 끕니다.
<b>&lt;Fn&gt; + &lt;F8&gt;</b>		스피커 전환	스피커를 켜고 끕니다.
<b>&lt;Fn&gt; + &lt;D&gt;</b>		밝게	화면 밝기를 증가시킵니다.
<b>&lt;Fn&gt; + &lt;D&gt;</b>		어둡게	화면 밝기를 감소시킵니다.
<b>&lt;Fn&gt; + &lt;A&gt;</b>		볼륨 크게	소리를 높입니다.
<b>&lt;Fn&gt; + &lt;V&gt;</b>		볼륨 작게	소리를 낮춥니다.
<b>&lt;Fn&gt; + &lt;Home&gt;</b>		재생 / 일시 중지	선택된 미디어 파일을 재생 또는 일시 중지합니다.
<b>&lt;Fn&gt; + &lt;Pg Up&gt;</b>		중지	선택된 미디어 파일 재생을 중지합니다.
<b>&lt;Fn&gt; + &lt;Pg Dn&gt;</b>		이전	이전 미디어 파일로 돌아갑니다.
<b>&lt;Fn&gt; + &lt;End&gt;</b>		다음	다음 미디어 파일로 이동합니다.







## 달린 상태의 앞 모습



#	아이콘	항목	설명
		전원 표시등	컴퓨터의 전원 상태를 표시합니다.
1		배터리 표시등	컴퓨터의 배터리 상태를 표시합니다. <b>1. 충전 중 :</b> 배터리가 충전 중이면 황색 불이 켜집니다. <b>2. 충전 완료 :</b> AC 모드일 때 파란 불이 켜집니다.
		HDD 표시등	하드 디스크 드라이브가 동작 중이면 불이 켜집니다.
2		마이크 잭	외부 마이크로 소리를 입력할 때 사용합니다.
		헤드폰 / 스피커 잭	오디오 장치에 연결합니다 ( 예 : 스피커 , 헤드폰 ).
3		멀티 카드 판독기	Secure Digital (SD), MultiMediaCard (MMC), Memory Stick PRO (MS PRO) 및 xD-Picture Card (xD) 를 사용할 수 있습니다. <b>참고 :</b> 카드를 눌러 제거 또는 설치합니다 . 카드를 한 번에 하나만 사용할 수 있습니다 .
4		통신 스위치 / 표시등	컴퓨터의 통신 장치를 활성화 / 비활성화 하고 / 컴퓨터의 무선 연결 장치 상태를 나타냅니다 .

## 왼쪽 모습



#	아이콘	항목	설명
1		DC 입력 잭	AC 어댑터에 연결합니다 .
2		HDMI 포트	고선명 디지털 비디오 연결을 지원합니다 .
3		외부 디스플레이 (VGA) 포트	디스플레이 장치 ( 예 : 외부 모니터 , LCD 프로젝터 ) 를 연결합니다 .
4		USB/eSATA 포트	USB 또는 eSATA 장치에 연결합니다 ( 특정 모델에만 해당 ). <b>참고</b> : eSATA 장치를 연결하는 경우 USB 포트 세 개를 사용할 수 있습니다 .
5		SmartCard 슬롯	SmartCard 를 꽂습니다 .
6		ExpressCard/34 슬롯	한 개의 ExpressCard/34 모듈을 장착할 수 있습니다 . <b>참고</b> : 카드를 눌러 제거 / 삽입합니다 .

## 오른쪽 모습







#	아이콘	항목	설명
1		USB 포트	
2		USB 포트	USB 장치에 연결합니다. 검정색 포트는 <b>USB 2.0</b> 호환이며, 파란색 포트는 <b>USB 3.0</b> 과도 호환됩니다.
3		전원 충전 기능이 있는 USB 포트	
4		광드라이브	내부 광드라이브. CD 또는 DVD 를 넣습니다.
5		광디스크 액세스 표시등	광드라이브가 작동 중이면 불이 켜집니다.
6		광드라이브 꺼내기 단추	드라이브에서 광디스크를 꺼냅니다.
7		비상용 꺼내기 구멍	컴퓨터가 꺼졌을 때 광드라이브 트레이를 꺼낼 수 있습니다. <b>참고</b> : 컴퓨터가 꺼졌을 때 클립을 비상용 꺼내기 구멍에 삽입하여 광드라이브 트레이를 꺼내십시오.
8		이더넷 (RJ-45) 포트	10/100/1000 이더넷 네트워크에 연결합니다.
9		Kensington 잠금 장치 슬롯	Kensington 호환 컴퓨터 보호용 잠금 장치를 연결합니다. <b>참고</b> : 테이블이나 장금 서랍의 손잡이 같은 고정된 물체에 컴퓨터 보호용 케이블을 맵니다. 노치에 자물쇠를 걸고 열쇠를 돌려 잠금합니다. 열쇠가 없는 모델을 사용할 수도 있습니다.

## USB 3.0 정보

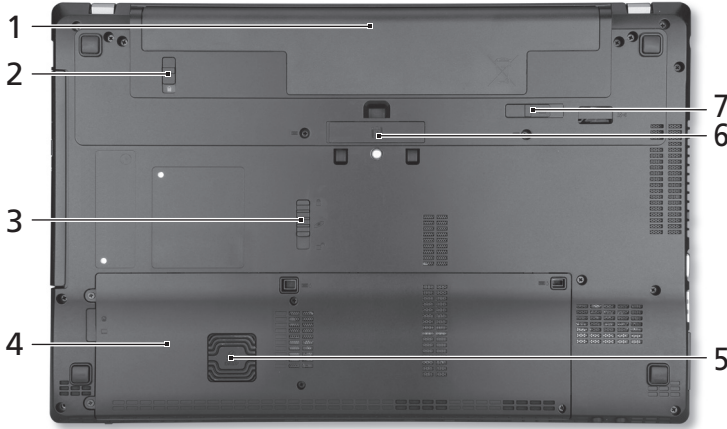
- USB 3.0 및 이전 USB 장치와 호환됩니다 .
- 최적의 성능을 위해서는 USB 3.0 인증 장치를 사용하십시오 .
- USB 3.0 ( 초고속 USB) 규격에 의해 정의됨 .

## 바닥 모습



#	아이콘	항목	설명
1		배터리 장착부	컴퓨터의 배터리 팩을 넣습니다 .
2		배터리 잠금	장착된 배터리를 빠지지 않도록 잠급니다 .
3		Acer MediaBay 제거용 래치	Acer MediaBay 모듈을 뺄 때 사용합니다 .
4		하드 디스크 장착부	컴퓨터의 하드 디스크를 넣습니다 ( 나사로 고정 ) .
		메모리 장착부	컴퓨터의 주 메모리를 넣습니다 .
5		Acer DASP ( 디스크 충격방지 )	충격과 충돌로부터 하드 디스크를 보호하 입니다 .
6		Acer ProDock 커넥터	선택 품목인 Acer ProDock 에 연결합니다 .
7		배터리 제거용 래치	제거를 위해 배터리를 뺄 때 사용합니다 .

## 환경

---

- 온도 :
    - 작동 : 5°C ~ 35°C
    - 비작동 : -20°C ~ 65°C
  - 습도 ( 비응축 ) :
    - 작동 : 20% ~ 80%
    - 비작동 : 20% ~ 80%
-



# TravelMate 筆記型電腦

## 快速使用指南

### 產品註冊

第一次使用本產品時，建議您先完成產品註冊。完成註冊可以獲得許多好處，包括：

- 由我們訓練有素的人員為您提供更快速的服務。
- 獲得成為 Acer 社群成員的資格：可以收到我們的促銷資訊，並參加客戶調查活動。
- 收到來自 Acer 的最新消息。

趕快完成註冊，還有多項好處等著您！

### 註冊方式

若要註冊 Acer 產品，請造訪 [www.acer.com](http://www.acer.com)。請選擇您所在的國家，按一下**產品註冊**，然後遵循簡易的指示進行。

畫面會在設定程序期間要求您完成產品註冊，或者您也可以連按兩下桌面上的註冊圖示。

當我們收到您的產品註冊後，我們會寄給您一封確認的電子郵件，當中含有一些重要資料，請您務必妥善保管。

### 取得 Acer 配件

我們很高興通知您，Acer 延長保固計劃及筆記型電腦配件現在都可從線上購得。請造訪我們的線上商店 ([store.acer.com](http://store.acer.com))，找出您想要的配件。

Acer 商店目前如火如荼準備中，但可能不適用於某些地區。請定期造訪本網站，以瞭解您所在國家的推出時間。

© 2012 版權所有。

TravelMate 筆記型電腦快速使用指南  
本修訂版本：2012 年 7 月

產品型號： \_\_\_\_\_

產品序號： \_\_\_\_\_

購買日期： \_\_\_\_\_

購買地點： \_\_\_\_\_



## 初步設定

首先，感謝您選擇 Acer 筆記型電腦，其會是滿足您行動運算需求的最佳首選。

## 使用指南

為協助您順利使用 Acer 筆記型電腦，我們特地設計了以下的使用指南：

首先，**設定海報**可協助您開始設定您的電腦。

本「**快速使用指南**」介紹本電腦的基本特性和功能。

有關本電腦如何幫助您提高效率的更多資訊，請參閱**使用手冊**。**使用手冊**包含適用於您電腦的有益資訊。其中包括基本主題，例如使用鍵盤、音訊等。

本指南包含系統公用程式、資料復原、擴充選項及疑難排解等主題的詳細資訊。此外，本指南也包含筆記型電腦的保固資訊、一般規範及安全注意事項。

請遵循下列步驟存取手冊：

- 1 在**開始**輸入「使用者」。
- 2 按一下「**Acer 使用手冊**」。

## Acer 筆記型電腦導覽

在依照設定海報中所提及的說明完成電腦的設定之後，就讓我們為您展示一下全新 Acer 筆記型電腦的各項功能吧！

### 上視圖

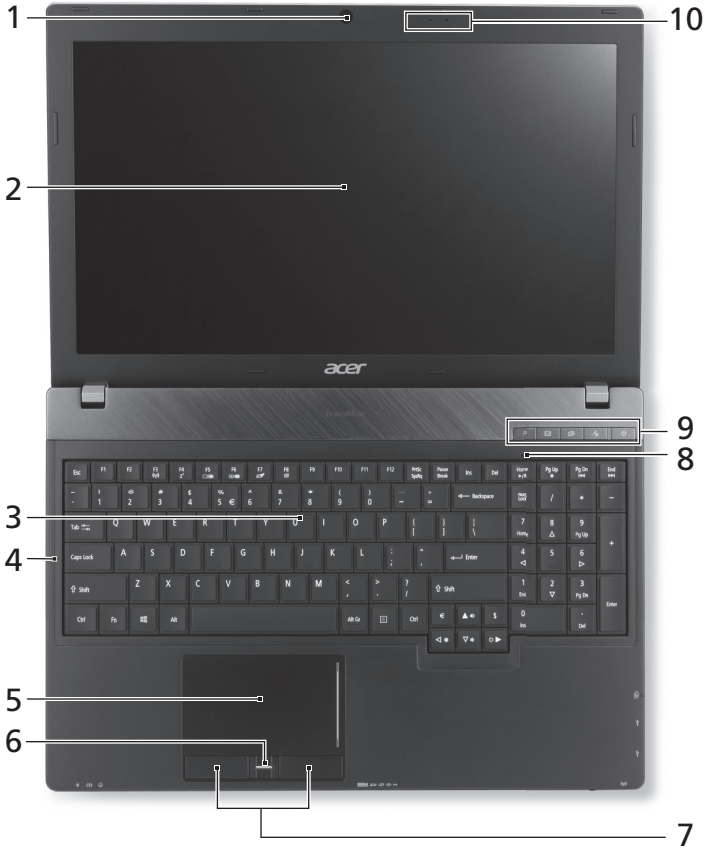

#	圖示	項目	說明
1		內建網路攝影機	用於視訊通訊的網路相機。 <i>網路攝影機旁的燈號代表網路攝影機已啟用。</i>
2		螢幕	亦稱為液晶顯示器 (Liquid-Crystal Display : LCD)，用於顯示電腦資料的輸出 (設定將依機型而有所不同)。
3		鍵盤	可用來將資料輸入電腦。
4		Caps Lock	Caps Lock 功能啟用時，指示燈會亮起。
5		觸控板	觸控感應式移動游標裝置，功能等同於電腦的滑鼠。
6		指紋辨識器	Acer ProShield Security Suite 所包含的指紋辨識器。
7		點選鍵 (左和右)	左鍵和右鍵的功能等同於滑鼠的左鍵和右鍵。
8		Num Lock	Num Lock 功能啟用時，指示燈會亮起。
		P 鍵	自訂功能鍵 (設定將依型號而有所不同)。
		Acer 電子郵件按鍵	開啓預設的電子郵件應用程式。
9		備份鍵	啓動 Acer Backup Management，以執行三步驟的資料備份程序。
		麥克風靜音	將麥克風設為靜音。
		電源按鈕 / 指示燈	開啓和關閉電腦。表示電腦的電源狀態。
10		麥克風	內建兩個可錄製立體聲音效的麥克風。

## 快速鍵





利用此電腦的快速鍵或組合鍵可存取大部分的控制指令，例如：螢幕亮度和音量輸出。

若要使用快速鍵，請先按住 **<Fn>** 鍵，再按下組合鍵的另一按鍵。

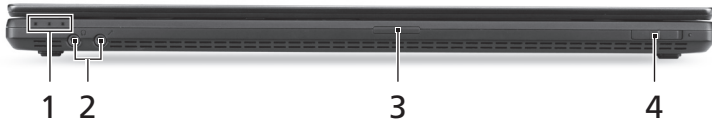
快速鍵	圖示	功能	說明
<b>&lt;Fn&gt; + &lt;F3&gt;</b>		通訊	啓用 / 停用電腦的通訊裝置。
<b>&lt;Fn&gt; + &lt;F4&gt;</b>		睡眠	讓電腦進入睡眠模式。
<b>&lt;Fn&gt; + &lt;F5&gt;</b>		螢幕顯示切換	在螢幕及外接顯示器 (如有連接) 之間切換，或同時顯示。
<b>&lt;Fn&gt; + &lt;F6&gt;</b>		螢幕空白	關閉顯示螢幕背光，以節省電力。按下任意鍵即可返回。
<b>&lt;Fn&gt; + &lt;F7&gt;</b>		觸控板切換鈕	開啓和關閉內建的觸控板。
<b>&lt;Fn&gt; + &lt;F8&gt;</b>		喇叭切換鈕	開啓和關閉喇叭。
<b>&lt;Fn&gt; + &lt;▷&gt;</b>		調高亮度	調高螢幕亮度。
<b>&lt;Fn&gt; + &lt;◁&gt;</b>		調低亮度	調低螢幕亮度。
<b>&lt;Fn&gt; + &lt;△&gt;</b>		提高音量	提高喇叭音量。
<b>&lt;Fn&gt; + &lt;▽&gt;</b>		降低音量	降低喇叭音量。
<b>&lt;Fn&gt; + &lt;Home&gt;</b>		播放 / 暫停	播放或暫停選取的媒體檔。
<b>&lt;Fn&gt; + &lt;Pg Up&gt;</b>		停止	停止播放選取的媒體檔。
<b>&lt;Fn&gt; + &lt;Pg Dn&gt;</b>		上一個	返回上一個媒體檔。
<b>&lt;Fn&gt; + &lt;End&gt;</b>		下一個	跳到下一個媒體檔。





## 上蓋闔起的前視圖



#	圖示	項目	說明
		電源指示燈	表示電腦的電源狀態。
1		電池指示燈	表示電腦的電池狀態。 <b>1. 充電中：</b> 當電池充電時，指示燈會亮琥珀色。 <b>2. 充電完畢：</b> 當使用 AC 電源模式時，指示燈會亮藍色。
		硬碟指示燈	當存取硬碟時，指示燈會亮起。
2		麥克風插孔	接受從外接麥克風所輸入的聲音。
		耳機 / 喇叭插孔	連接到音訊裝置的插孔 (例如：喇叭、耳機)。
3		多合一讀卡機	可支援 Secure Digital (SD)、MultiMediaCard (MMC)、Memory Stick PRO (MS PRO)、xD-Picture Card (xD)。 <b>注意：</b> 輕壓即可移除 / 安裝卡片。無論何時皆只能使用一張卡片。
4		通訊開關 / 指示燈	啓用 / 停用電腦的通訊裝置 / 表示電腦無線連線能力的狀態。

## 左視圖



#	圖示	項目	說明
1		DC 輸入插孔	連接到 AC 變壓器。
2		HDMI 連接埠	支援高清晰度數位視訊連線。
3		外接顯示螢幕 (VGA) 連接埠	連接到顯示器裝置 (例如：外接式顯示器、LCD 投影機)。
4		USB/eSATA 埠	連接到 USB 或 eSATA 裝置 (僅適用於特定機型)。 <b>注意：</b> 若將 eSATA 裝置插入，則有三個 USB 埠可供使用。
5		SmartCard 插槽	可插入 SmartCard。
6		ExpressCard/34 插槽	可支援一組 ExpressCard/34 模組。 <b>注意：</b> 推一下即可取出 / 插入卡片。

## 右視圖







#	圖示	項目	說明
1		USB 埠	連接到 USB 裝置。
2		USB 埠	如果連接埠為黑色，表示為 USB 2.0 相容； 如果為藍色，則可同時相容 USB 3.0 (請參閱下方)。
3		USB 連接埠含關機 充電功能	
4		光碟機	內部光碟機，可放入 CD 或 DVD。
5		光碟存取指示燈	當正在存取光碟時，指示燈會亮起。
6		光碟退出按鈕	可將光碟從光碟機中退出。
7		緊急退出孔	可在電腦關機狀態下退出光碟機托盤。 <b>注意：</b> 在電腦關機時將迴紋針插入緊急退出 孔，即可退出光碟機托盤。
8		乙太網路 (RJ-45) 連接埠	連接到以 10/100/1000 為基礎的乙太網路。
9		Kensington 安全鎖 插槽	連接到與 Kensington 相容的電腦安全鎖。 <b>注意：</b> 將電腦安全鎖電纜繞著無法移動的 物品打個圈；例如：桌子或鎖住的抽屜把 手。再將鎖插入鎖孔中，並轉動鑰匙以便上 鎖。此外，還有些無鑰匙安全鎖的型號可供 使用者選擇。

## USB 3.0 資訊

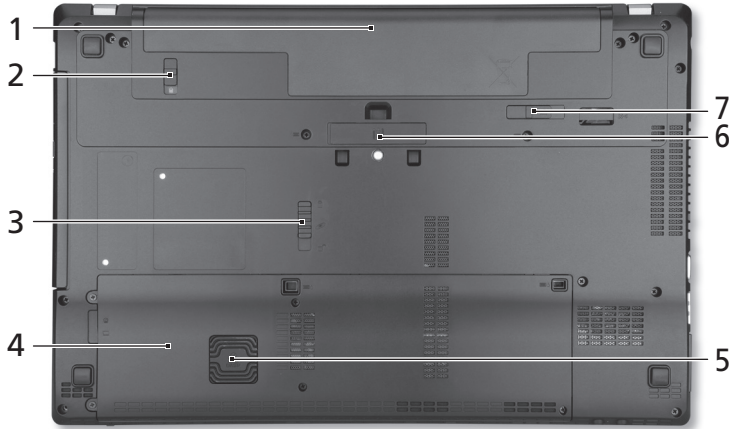
- 相容於 USB 3.0 和較舊的 USB 裝置。
- 如需達到最佳效能，請使用具 USB 3.0 認證的裝置。
- 使用 USB 3.0 (SuperSpeed USB) 規格。

## 底視圖



#	圖示	項目	說明
1		電池槽	用於安裝電腦的電池組。
2		電池組固定鎖	可將電池鎖到定位。
3		Acer MediaBay 模組拆卸卡榫	用於鬆開 Acer MediaBay 模組。
4		硬碟槽	用於安裝電腦的硬碟 (以螺絲鎖定)。
		記憶體槽	用於安裝電腦的主記憶體。
5		Acer DASP (Disk Anti- Shock Protection) 硬碟防震系統	保護硬碟，使其免於震動或碰撞。
6		Acer ProDock 連接器	連接至選購的 Acer ProDock。
7		電池卸除卡榫	用於卸下電池組。



## 環境

---

- 溫度：
    - 操作中：5°C 至 35°C
    - 非操作中：-20°C 至 65°C
  - 溼度（非冷凝狀態）：
    - 操作中：20% 至 80%
    - 非操作中：20% 至 80%
-



# TravelMate 笔记本电脑

## 快速指南

### 产品注册

当首次使用您的产品时，建议您立即注册。这可给您带来有用的好处，例如：

- 享受专业代表提供的快捷服务。
- Acer 社区中的成员：获得促销信息，并参加客户调查。
- 来自 Acer 的最新新闻。

马上注册，更多精彩等着您！

### 如何注册

要注册 Acer 产品，请访问 [www.acer.com](http://www.acer.com)。选择您所在国家，点击**产品注册**并按照说明进行注册。

在设置进程中，您也需要注册，您可以双击桌面的“注册”图标。

我们收到您的产品注册后，将向您发送一封确认电子邮件，该邮件含有重要数据，请保存在安全位置。

### 获取 Acer 配件

我们很高兴的告诉您，Acer 在线提供保修期延长计划与笔记本电脑配件。请登录和访问我们的在线商铺，在 [store.acer.com](http://store.acer.com) 找到您需要的东西。

Acer 在线商店在不断扩大中，但遗憾的是目前某些地区可能不可用。请定期检查，以确定您所在国家什么时间可用。

© 2012 版权所有。

TravelMate 笔记本电脑快速指南  
本次修订：2012 年 7 月

产品型号: \_\_\_\_\_

产品序号: \_\_\_\_\_

购买日期: \_\_\_\_\_

购买地点: \_\_\_\_\_

# 使用入门

感谢您选购 Acer 笔记本电脑，让它满足您随时随地使用计算机的需要。

## 用户指南

为帮助您设置和使用 Acer 笔记本电脑，我们为您设计了以下用户指南：

首先，请按照电脑所附带的**安装彩图**来安装电脑。

本**快速指南**介绍了您新购电脑的基本特性和功能。

要了解关于您的电脑如何能够帮助您提高工作效率的详细信息，请参见**用户手册**。**用户手册**包含适用于这款新电脑的有用信息。该手册包括键盘和音频的使用方法等基本内容。

本指南包含了诸如系统实用程序、数据恢复、扩展选项和疑难解答等详细信息。此外，它还包含了保修信息和笔记本电脑的一般规则和安全注意事项。

请按以下步骤访问：

- 1 从**开始**输入“用户”。
- 2 单击 **Acer 用户指南**。

## 熟悉 Acer 笔记本电脑

当您按照安装彩图中的示例安装完电脑后，就让我们一起来熟悉您的 Acer 笔记本电脑吧。

### 俯视图

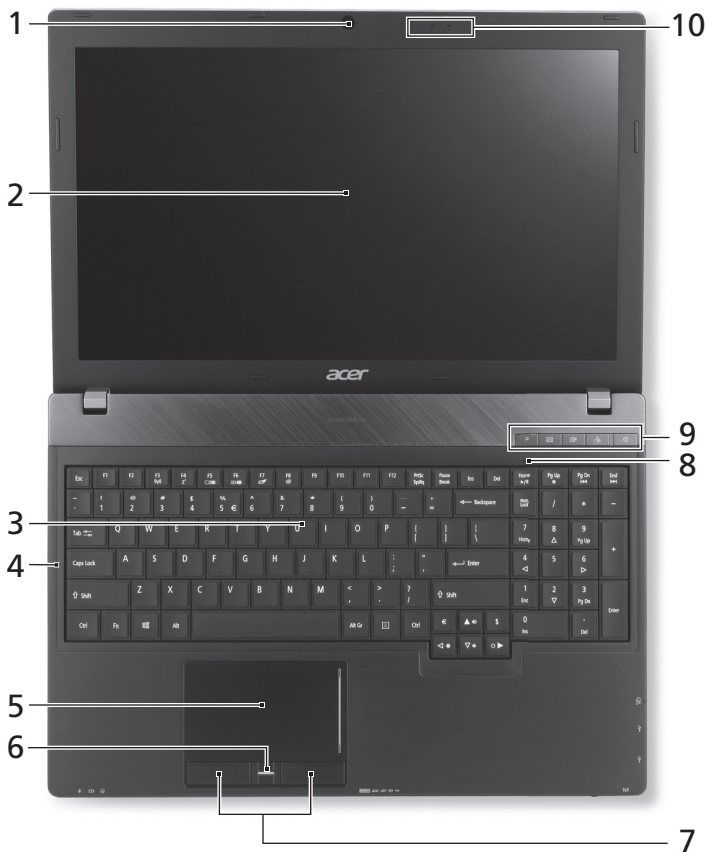

#	图标	项目	说明
1		集成摄像头	网络相机，用于视频通信。 <i>摄像机旁边的灯表明摄像机在运行。</i>
2		屏幕	也称液晶显示屏 (Liquid-Crystal Display ; LCD)，用于显示电脑的输出内容 (不同型号配置可能有所不同)。
3		键盘	将数据输入到电脑中。
4		Caps Lock	当 Caps Lock 键启用时，该指示灯亮起。
5		触控板	触摸式定位设备，功能和电脑鼠标相同。
6		指纹读取器	用于 Acer ProShield Security Suite 的指纹读取器。
7		单击按钮 (左和右)	左右按钮的功能与鼠标的左右键相同。
8		Num Lock	当 Num Lock 键启用时，该指示灯亮起。
		P 键	编程键 (不同型号配置可能有所不同)。
		Acer 电子邮箱键	打开默认电子邮件应用程序。
9		备份键	启动 Acer Backup Management 以进行三个步骤的数据备份。
		麦克风静音	对麦克风静音。
		电源按钮 / 指示灯	用于打开和关闭电脑电源。显示电脑的电源状态。
10		麦克风	两个用于立体声录音的内置麦克风。

## 热键

本款电脑提供热键或组合键来实现许多操控，例如：调节屏幕亮度以及音量输出。

要激活热键，先按住 **<Fn>** 键，然后再按热键组合中的另一个键。

热键	图标	功能	说明
<b>&lt;Fn&gt; + &lt;F3&gt;</b>		通信	启用 / 禁用电脑的通信设备。
<b>&lt;Fn&gt; + &lt;F4&gt;</b>		睡眠	让电脑进入睡眠模式。
<b>&lt;Fn&gt; + &lt;F5&gt;</b>		显示屏幕切换	可以在以下三种显示方式间切换： 只使用显示屏、只使用已连接的外部显示器、同时使用显示屏和外部显示器。
<b>&lt;Fn&gt; + &lt;F6&gt;</b>		屏幕空白	关闭显示屏背光以节省电量。按任意键将恢复正常显示。
<b>&lt;Fn&gt; + &lt;F7&gt;</b>		触控板切换	打开或关闭内置触控板。
<b>&lt;Fn&gt; + &lt;F8&gt;</b>		扬声器切换	打开或关闭扬声器。
<b>&lt;Fn&gt; + &lt;▷&gt;</b>		调高亮度	调高屏幕亮度。
<b>&lt;Fn&gt; + &lt;◁&gt;</b>		调低亮度	调低屏幕亮度。
<b>&lt;Fn&gt; + &lt;△&gt;</b>		调高音量	调高扬声器音量。
<b>&lt;Fn&gt; + &lt;▽&gt;</b>		调低音量	调低扬声器音量。
<b>&lt;Fn&gt; + &lt;Home&gt;</b>		播放 / 暂停	播放或暂停选定的媒体文件。
<b>&lt;Fn&gt; + &lt;Pg Up&gt;</b>		停止	停止播放选定的媒体文件。
<b>&lt;Fn&gt; + &lt;Pg Dn&gt;</b>		上一个	返回上一个媒体文件。
<b>&lt;Fn&gt; + &lt;End&gt;</b>		下一个	跳至下一个媒体文件。





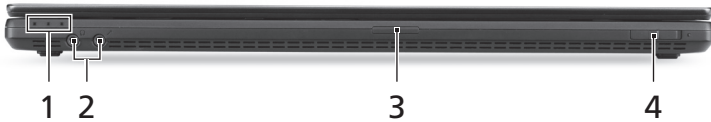

## 前视图



#	图标	项目	说明
		电源指示灯	显示电脑的电源状态。
1		电池指示灯	显示目前电脑电池的状态。 <b>1. 充电中:</b> 当电池在充电时, 指示灯显示琥珀色。 <b>2. 完全充电:</b> 处在 AC 模式时, 指示灯亮蓝色。
		硬盘指示灯	硬盘启用时, 该指示灯亮起。
2		麦克风插口	连接外接麦克风。
		耳机 / 扬声器插孔	连接音频设备 (例如: 扬声器、耳机)。
3		多合一读卡器	可支持安全数码卡 (SD)、多媒体卡 (MMC)、PRO 记忆棒 (MS PRO) 及 xD-Picture 卡 (xD)。 <b>注:</b> 轻推取下 / 安装卡。任何时候, 仅支持读取一张卡。
4		通信开关 / 指示灯	启用 / 禁用电脑的通信设备 / 表示电脑的无线连接设备状态。

## 左视图



#	图标	项目	说明
1		直流电源输入插孔	连接交流适配器。
2		HDMI 端口	支持高清数字视频连接。
3		外部显示器 (VGA) 端口	连接显示设备 (例如: 外接显示器、LCD 投影机)。
4		USB/eSATA 端口	连接 USB 或 eSATA 设备 (仅限部分型号)。 <b>注:</b> 如果插入 eSATA 设备, 您将有三个 USB 端口可用。
5		SmartCard 插槽	支持 SmartCard。
6		ExpressCard/34 插槽	支持一个 ExpressCard/34 模块。 <b>注:</b> 轻推取下 / 插入卡。

## 右视图







#	图标	项目	说明
1		USB 端口	
2		USB 端口	连接到 USB 装置。 如果端口为黑色，则兼容 USB 2.0，如果端口为蓝色，则兼容 USB 3.0。
3		关机充电的 USB 端口	
4		光驱	内置光驱，可支持读取 CD 或 DVD。
5		光驱访问指示灯	当光驱启用时指示灯会亮起。
6		光驱弹出按钮	按下此按钮可弹出光驱。
7		紧急弹出孔	当电脑关闭时，可弹出光驱托盘。 <b>注：</b> 如果电脑关闭，将回形针插入紧急弹出孔可使光驱弹出。
8		以太网 (RJ-45) 端口	连接 10/100/1000 以太网网络。
9		Kensington 安全锁 插槽	连接 Kensington 兼容电脑安全锁。 <b>注：</b> 您可以将电脑锁链与不可移动的物体相连，例如：桌子或上锁的抽屉手柄。将锁插入锁孔中然后旋转钥匙便可上锁。您也可以选购不带安全锁的型号。

## 有关 USB 3.0 的信息

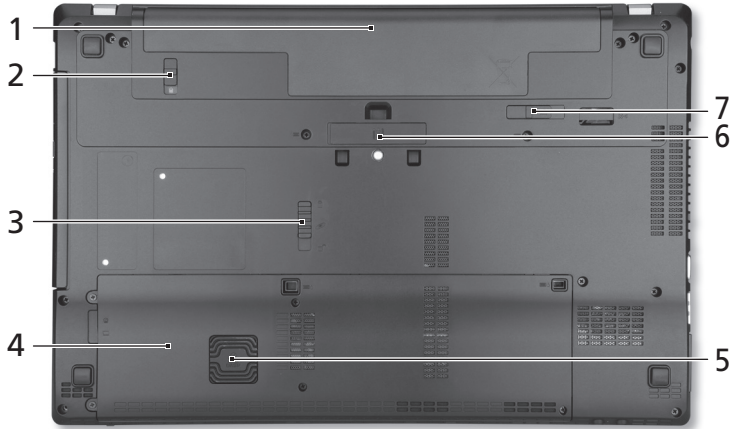
- 与 USB 3.0 和较早 USB 设备兼容。
- 用 USB 3.0 认可设备获得最优性能。
- 符合 USB 3.0 (SuperSpeed USB) 技术规范。

## 底视图



#	图标	项目	说明
1		电池槽	安装电池组。
2		电池锁	可固定锁紧电池组。
3		Acer MediaBay 释放栓	释放 Acer MediaBay 模块。
4		硬盘槽	安装电脑硬盘的位置 (用螺丝紧固)。
		内存槽	安装电脑主内存的位置。
5		Acer 硬盘抗震系统 (Disk Anti-Shock Protection; DASP)	保护硬盘避免受到震动和碰撞。
6		Acer ProDock 连接器	连接可选的 Acer ProDock。
7		电池释放门锁	释放电池门锁可取下电池组。

## 环境

---

- 温度：
    - 操作时：5°C 至 35°C
    - 不操作时：-20°C 至 65°C
  - 湿度 (非冷凝)：
    - 操作时：20% 至 80%
    - 不操作时：20% 至 80%
-



# Notebook TravelMate

## Panduan cepat

### Registrasi Produk

Ketika Anda menggunakan produk untuk pertama kalinya, Anda dianjurkan untuk segera mendaftarkan komputer Anda. Dengan registrasi ini Anda akan memperoleh keuntungan yang bermanfaat, seperti:

- Layanan lebih cepat dari perwakilan kami yang terlatih.
- Keanggotaan dalam komunitas Acer: menerima promosi dan berpartisipasi dalam survei pelanggan.
- Berita terkini dari Acer.

Bergegaslah mendaftar, karena banyak keuntungan lainnya menunggu Anda!

### Cara Mendaftar

Untuk mendaftarkan produk Acer Anda, harap kunjungi **www.acer.com**. Pilih negara Anda, klik **REGISTRASI PRODUK** dan ikuti petunjuknya yang sederhana.

Anda juga akan diminta untuk mendaftarkan produk Anda selama proses penyiapan, atau Anda dapat mengklik dua kali ikon Registrasi di desktop.

Setelah kami menerima registrasi produk Anda, email konfirmasi yang berisi data penting akan dikirimkan kepada Anda. Simpan data tersebut di tempat aman.

### Memperoleh aksesoris Acer

Dengan gembira kami memberikan informasi kepada Anda bahwa program perpanjangan jaminan Acer dan aksesoris Notebook tersedia online. Datang dan kunjungi toko online kami dan dapatkan yang Anda butuhkan di **store.acer.com**.

Toko Acer diperkenalkan secara progresif, dan sayangnya tidak tersedia di beberapa wilayah. Harap periksa kembali secara berkala untuk melihat kapan toko Acer tersedia di negara Anda.

© 2012 Hak Cipta Dilindungi Undang-undang.

Panduan Cepat Notebook TravelMate

Revisi ini: 07/2012

Nomor model: \_\_\_\_\_

Nomor seri: \_\_\_\_\_

Tanggal pembelian: \_\_\_\_\_

Alamat pembelian: \_\_\_\_\_



## Dahulukan, hal pertama

Kami mengucapkan terima kasih kepada Anda yang telah memilih notebook Acer untuk memenuhi kebutuhan Anda akan komputer.

## Panduan Anda

Kami telah mendesain serangkaian panduan guna membantu Anda menggunakan notebook Acer Anda:

Pertama-tama, **Lembar Petunjuk Penyiapan** ini membantu Anda mulai melakukan setup atau penyiapan komputer Anda.

**Panduan Cepat** ini akan menjelaskan fitur dan fungsi dasar komputer baru Anda.

Untuk informasi lebih lanjut tentang cara komputer ini membantu Anda agar lebih produktif, lihat **Manual Pengguna**. **Manual Pengguna** berisi informasi berguna yang berlaku bagi komputer baru Anda. Panduan ini mencakup topik-topik dasar seperti, menggunakan keyboard, audio, dsb.

Petunjuk ini berisi informasi rinci tentang topik seperti utilitas sistem, pemulihan data, opsi-opsi ekspansi, dan pemecahan masalah. Di samping itu, panduan ini berisi informasi jaminan dan peraturan umum serta peringatan keselamatan untuk notebook Anda.

Ikuti langkah ini untuk mengaksesnya:

- 1 Ketik "Pengguna" dari *Mulai*.
- 2 Klik pada **Manual Pengguna Acer**.



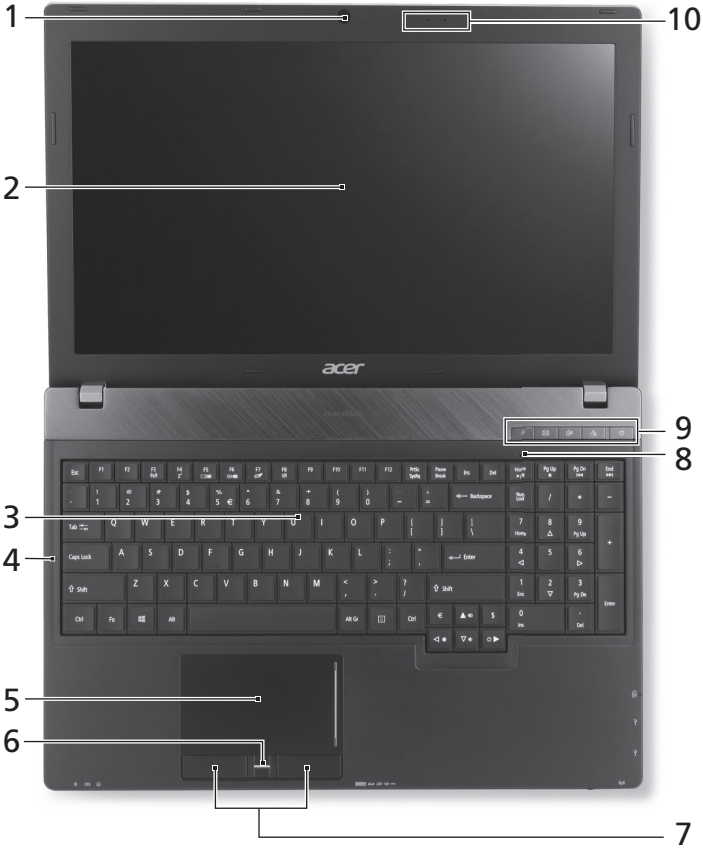

# Tur notebook Acer Anda

Setelah mempersiapkan komputer seperti pada gambar dalam lembar petunjuk penyiapan, kami akan menunjukkan bagian-bagian notebook Acer baru Anda.

## Tampak atas













#	Ikun	Item	Keterangan
1		Webcam terpadu	Webcam untuk komunikasi video. <i>Lampu di sebelah kamera web menunjukkan bahwa kamera web aktif.</i>

#	Ikon	Item	Keterangan
2		Layar	Disebut juga sebagai LCD (Liquid-Crystal Display), menampilkan output komputer (konfigurasi mungkin berbeda tergantung model).
3		Keyboard	Untuk memasukkan data ke komputer.
4		Caps Lock	Menyala bila Caps Lock diaktifkan.
5		Panel sentuh	Perangkat penunjuk sensitif sentuhan yang berfungsi seperti mouse komputer.
6		Pembaca sidik jari	Pembaca sidik jari untuk Acer ProShield Security Suite.
7		Tombol klik (kiri dan kanan)	Tombol kiri dan kanan berfungsi seperti tombol mouse kiri dan kanan.
8		Num Lock	Menyala bila Num Lock diaktifkan.
		Tombol P	Tombol yang dapat diprogram (konfigurasi mungkin berbeda-beda bergantung model).
		Tombol email Acer	Membuka aplikasi email default Anda.
9		Tombol cadangan	Meluncurkan Acer Backup Management untuk tiga langkah pembuatan cadangan.
		Mikrofon senyap	Menyetel mikrofon ke senyap
		Indikator/tombol daya	Menghidupkan/mematikan komputer. Menunjukkan status daya komputer.
10		Mikrofon	Dua mikrofon internal stereo untuk perekaman suara.

## Tombol pintas

Komputer ini menggunakan tombol pintas atau kombinasi tombol untuk mengakses sebagian besar kontrol komputer, misalnya kecerahan layar dan output volume suara.





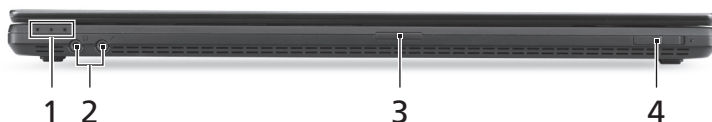

Untuk mengaktifkan tombol pintas, tekan dan tahan tombol **<Fn>** sebelum menekan tombol lain pada kombinasi tombol pintas.

Tombol pintas	Ikon	Fungsi	Keterangan
<b>&lt;Fn&gt; + &lt;F3&gt;</b>		Komunikasi	Mengaktifkan/menonaktifkan perangkat komunikasi komputer.
<b>&lt;Fn&gt; + &lt;F4&gt;</b>		Tidur	Memasukkan komputer ke mode Tidur.
<b>&lt;Fn&gt; + &lt;F5&gt;</b>		Tombol layar	Mengalihkan output tampilan antara layar tampilan, monitor eksternal (jika dipasang), dan keduanya.
<b>&lt;Fn&gt; + &lt;F6&gt;</b>		Layar kosong	Menonaktifkan cahaya latar layar tampilan untuk menghemat daya. Tekan tombol apa saja untuk kembali.
<b>&lt;Fn&gt; + &lt;F7&gt;</b>		Tombol panel sentuh	Mengaktifkan dan menonaktifkan panel sentuh internal.
<b>&lt;Fn&gt; + &lt;F8&gt;</b>		Tombol pengeras suara	Mengaktifkan dan menonaktifkan pengeras suara.
<b>&lt;Fn&gt; + &lt;↑&gt;</b>		Kecerahan meningkat	Meningkatkan kecerahan layar.
<b>&lt;Fn&gt; + &lt;↓&gt;</b>		Kecerahan berkurang	Mengurangi kecerahan layar.
<b>&lt;Fn&gt; + &lt;▲&gt;</b>		Volume naik	Menaikkan volume suara.
<b>&lt;Fn&gt; + &lt;▼&gt;</b>		Volume turun	Menurunkan volume suara.
<b>&lt;Fn&gt; + &lt;Home&gt;</b>		Putar/Jeda	Memutar atau menjeda file media yang dipilih.

Tombol pintas	Ikon	Fungsi	Keterangan
<Fn> + <Pg Up>	■	Berhenti	Menghentikan pemutaran file media yang dipilih.
<Fn> + <Pg Dn>	⏮	Sebelumnya	Kembali ke file media sebelumnya.
<Fn> + <End>	⏭	Berikutnya	Lompat ke file media berikutnya.





## Tampak depan tertutup



#	Ikon	Item	Keterangan
1		Indikator daya	Menunjukkan status daya komputer.
			Menunjukkan status baterai komputer. <b>1. Mengisi daya:</b> Lampu menyala kuning kecokelatan bila daya baterai sedang diisi. <b>2. Daya terisi penuh:</b> Lampu menyala biru bila dalam mode AC.
2		Indikator baterai	
3		Indikator HDD	Menunjukkan bila hard disk drive aktif.
4		Jack mikrofon	Menerima input dari mikrofon eksternal.
2		Jack headphone/ pengeras suara	Menyambungkan ke perangkat audio (mis. pengeras suara, headphone).
3		Pembaca kartu Multi-in-1	Menerima Secure Digital (SD), MultiMediaCard (MMC), Memory Stick PRO (MS PRO), xD-Picture Card (xD). <b>Catatan:</b> Tekan untuk melepas/memasang kartu. Kapan saja hanya satu kartu yang bisa beroperasi.
4		Tombol/indikator komunikasi	Mengaktifkan/menonaktifkan perangkat komunikasi komputer/menunjukkan status perangkat konektivitas nirkabel komputer.





## Tampak kiri



#	Ikon	Item	Keterangan
1		Jack DC-in	Menghubungkan ke Adaptor AC.
2		Port HDMI	Mendukung koneksi video digital definisi tinggi.
3		Port tampilan (VGA) eksternal	Menghubungkan perangkat tampilan (mis., monitor eksternal, proyektor LCD).
4		Port USB/eSATA	Menghubungkan ke perangkat USB atau eSATA (hanya untuk model tertentu). <b>Catatan:</b> Jika Anda mencolokkan sebuah perangkat eSATA, maka akan tersedia tiga port USB.
5		Slot SmartCard	Menerima SmartCard.
6		Slot ExpressCard/34	Menerima modul ExpressCard/34. <b>Catatan:</b> Tekan untuk melepas/memasukkan kartu.

## Tampak kanan







#	Ikon	Item	Keterangan
1		Port USB	Menyambungkan ke perangkat USB.
2		Port USB	<i>Jika sebuah port berwarna hitam, port itu kompatibel dengan USB 2.0, jika port itu berwarna biru, port itu juga kompatibel dengan USB 3.0.</i>
3		Port USB dengan pengisian daya-mati	
4		Drive optik	Drive optik internal; menerima CD atau DVD.
5		Indikator akses disk optik	Menyala saat drive optik aktif.
6		Tombol pengeluaran drive optik	Mengeluarkan disk optik dari drive.
7		Lubang pengeluaran darurat	Mengeluarkan nampan drive optik saat komputer mati. <b>Catatan:</b> Masukkan klip kertas ke lubang pengeluaran darurat untuk mengeluarkan nampan drive optik bila komputer mati.
8		Port ethernet (RJ-45)	Menghubungkan ke jaringan berbasis Ethernet 10/100/1000.
9		Slot kunci Kensington	Menyambungkan ke kunci keamanan komputer yang kompatibel dengan kunci Kensington. <b>Catatan:</b> Lilitkan kabel kunci keamanan komputer ke benda sekitar yang tidak dapat bergerak, misalnya, meja atau gagang laci yang terkunci. Masukkan kunci ke dalam lubang, kemudian putar kunci untuk menguncinya. Juga tersedia beberapa model tanpa kunci.

## Informasi mengenai USB 3.0

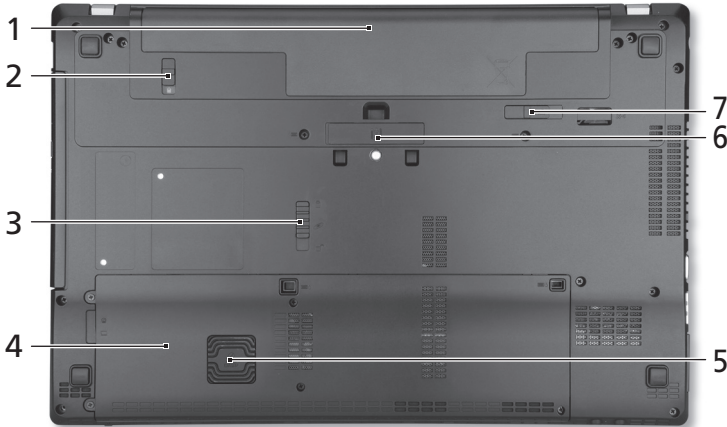
- Kompatibel dengan USB 3.0 dan perangkat USB sebelumnya.
- Untuk kinerja optimal, gunakan perangkat USB 3.0 bersertifikat.
- Ditentukan oleh spesifikasi USB 3.0 (SuperSpeed USB).

## Tampak bawah



#	Ikon	Item	Keterangan
1		Tempat baterai	Tempat unit baterai komputer.
2		Kunci baterai	Mengunci baterai pada tempatnya.
3		Kunci pelepas Acer MediaBay	Untuk melepas modul Acer MediaBay.
4		Tempat hard disk	Untuk memasang hard disk komputer (dipasang dengan sekrup).
		Kompartemen memori	Untuk memasang memori utama komputer.
5		Acer DASP (Perlindungan Anti Guncangan Disk)	Melindungi hard disk dari guncangan dan benturan.
6		Konektor Acer ProDock	Menghubungkan ke Acer ProDock opsional.
7		Penutup pelepas baterai	Untuk melepaskan baterai.



## Lingkungan

---

- Suhu:
    - Beroperasi: 5°C hingga 35°C
    - Tidak beroperasi: -20°C hingga 65°C
  - Kelembaban (non-kondensasi):
    - Beroperasi: 20% hingga 80%
    - Tidak beroperasi: 20% hingga 80%
-



# โน้ตบุ๊ก TravelMate

## คู่มืออย่างย่อ

### การลงทะเบียนผลิตภัณฑ์

เมื่อคุณใช้ผลิตภัณฑ์ของคุณเป็นครั้งแรก ขอแนะนำให้คุณทำการลงทะเบียนในทันที ซึ่งจะเป็นการช่วยให้คุณได้รับสิทธิประโยชน์ต่างๆ เช่น:

- บริการที่รวดเร็วจากตัวแทนที่ได้รับการฝึกอบรมจากเรา
- สมาชิกในชุมชน Acer: รับโปรแกรมต่างๆ และเข้าร่วมในการสำรวจความคิดเห็นลูกค้า
- ข่าวล่าสุดจาก Acer

อย่าช้า ลงทะเบียนและรับสิทธิประโยชน์ที่รอคุณอยู่!

### วิธีการลงทะเบียน

เพื่อลงทะเบียนผลิตภัณฑ์ Acer โปรดแวะไปยัง [www.acer.com](http://www.acer.com) เลือกประเทศของคุณ คลิก การลงทะเบียนผลิตภัณฑ์ และทำตามขั้นตอนง่ายๆ ที่ระบุ

คุณจะถูกร้องขอให้ลงทะเบียนผลิตภัณฑ์ของคุณในระหว่างขั้นตอนการตั้งค่าใช้งาน หรือคุณสามารถดับเบิลคลิกที่ไอคอนการลงทะเบียนที่อยู่บนเดสก์ท็อปได้

หลังจากที่เราได้รับการลงทะเบียนผลิตภัณฑ์จากคุณแล้ว เราจะส่งอีเมลแสดงการยืนยันพร้อมด้วยข้อมูลที่สำคัญที่คุณควรนำไปเก็บไว้ในที่ที่ปลอดภัยให้กับคุณ

### อุปกรณ์เสริม

เรายินดีที่จะแจ้งให้ทราบว่าโปรแกรมขยายการรับประกัน Acer และอุปกรณ์เสริมสำหรับโน้ตบุ๊กมีให้ซื้อออนไลน์แล้ว โปรดแวะชมร้านค้าออนไลน์ของเราและพบสิ่งที่คุณต้องการได้ที่ [store.acer.com](http://store.acer.com)

อุปกรณ์เสริมต่างๆ จะวางจำหน่ายเพิ่มขึ้นอย่างต่อเนื่อง และอาจเป็นไปได้ว่าอุปกรณ์เสริมบางรุ่นอาจไม่มีจำหน่ายในบางภูมิภาค โปรดแวะกลับมาชมเป็นประจำเพื่อดูว่าอุปกรณ์เสริมเหล่านั้นจะมีจำหน่ายในประเทศของคุณเมื่อใด

© 2012 สงวนลิขสิทธิ์

คู่มือฉบับย่อเน็ตบุค TravelMate  
เวอร์ชันนี้: 07/2012

หมายเลขรุ่น: \_\_\_\_\_

ซีรียลนัมเบอร์: \_\_\_\_\_

วันที่ซื้อ: \_\_\_\_\_

สถานที่ซื้อ: \_\_\_\_\_

## ก่อนอื่น

ขอขอบคุณที่คุณเลือกโน้ตบุ๊กจาก Acer เพื่อรองรับการใช้งานแบบพกพาของคุณ

## คู่มือ

เพื่อช่วยสอนการใช้โน้ตบุ๊ก Acer เราจึงได้จัดทำคู่มือชุดนี้ขึ้น

อันดับแรกคือ **โปรแกรมการตั้งค่า**ที่จะช่วยในการเริ่มใช้คอมพิวเตอร์ของคุณ

**คู่มืออย่างย่อ** เป็นข้อมูลคุณสมบัติและฟังก์ชันเบื้องต้นในคอมพิวเตอร์เครื่องใหม่ของคุณ

สอบถามข้อมูลการใช้งานคอมพิวเตอร์เพื่อให้เกิดประสิทธิภาพสูงสุดได้จาก **คู่มือผู้ใช้**

**คู่มือผู้ใช้** มีข้อมูลที่เป็นประโยชน์สำหรับใช้กับคอมพิวเตอร์เครื่องใหม่ของคุณ

โดยระบุรายการทำงานเบื้องต้นต่างๆ เช่น การใช้คีย์บอร์ด ระบบเสียง ฯลฯ

คู่มือนี้ประกอบด้วยข้อมูลรายละเอียดเกี่ยวกับยูทิลิตี้ระบบ, การกู้คืนข้อมูล, ตัวเลือกเสริม, และวิธีในการแก้ไขปัญหา นอกจากนี้ยังประกอบด้วยข้อมูลการรับประกัน ข้อบังคับทั่วไป และการแจ้งเตือนด้านความปลอดภัยสำหรับโน้ตบุ๊กของคุณ

ทำตามขั้นตอนดังต่อไปนี้เพื่อเรียกดู

- 1 พิมพ์ "User" จาก **เริ่มต้น**
- 2 คลิกที่ **คู่มือผู้ใช้ Acer**

## แนะนำเกี่ยวกับโน้ตบุ๊ก Acer ของคุณ

หลังจากติดตั้งคอมพิวเตอร์ตามภาพในโปสเตอร์การติดตั้ง ต่อไปนี้เป็นวิธีการใช้งานโน้ตบุ๊ก Acer ใหม่ของคุณ

### มุมมองด้านบน

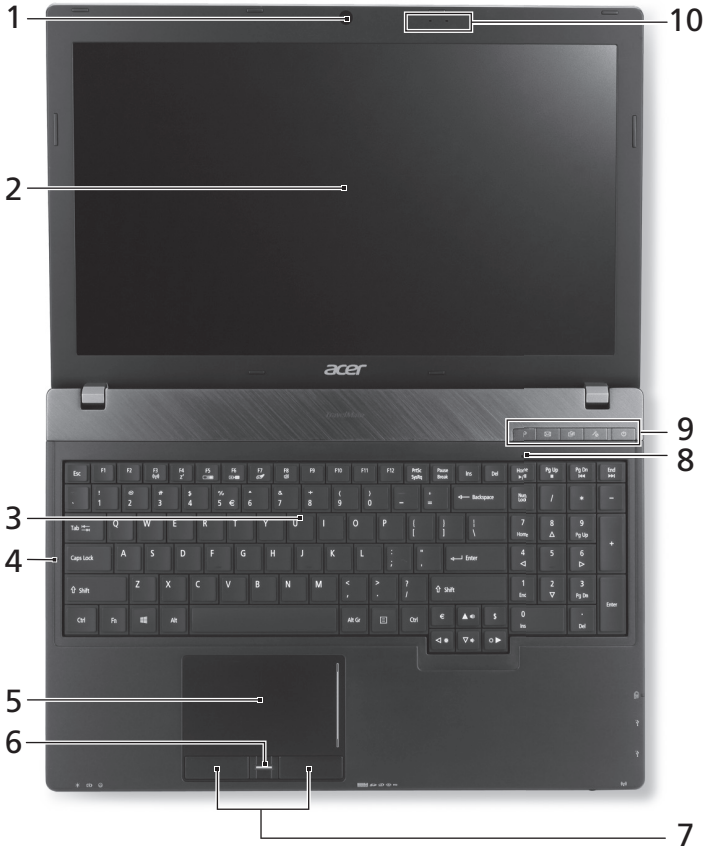

#	ไอคอน	รายการ	คำอธิบาย
1		กล่องเว็บแคมในตัว	กล่องเว็บแคมสำหรับระบบการสื่อสารด้วยวิดีโอ ไฟที่อยู่ถัดจากเว็บแคมแสดงว่าเว็บแคมกำลังทำงานอยู่

#	ไอคอน	รายการ	คำอธิบาย
2		หน้าจ	หรือที่เรียกว่า Liquid-Crystal Display (LCD) ซึ่งใช้แสดงข้อมูลต่างๆ ของคอมพิวเตอร์ (ส่วนประกอบอาจแตกต่างกันไปตามรุ่น)
3		คีย์บอร์ด	เพื่อป้อนข้อมูลเข้าสู่คอมพิวเตอร์ของคุณ
4		Caps Lock	ติดสว่างในกรณีที่เปิดใช้ Caps Lock
5		ทัชแพด	อุปกรณ์ชี้ตำแหน่งแบบสัมผัส ซึ่งทำงานแบบเดียวกับเมาส์คอมพิวเตอร์
6		เครื่องอ่านลายนิ้วมือ	เครื่องอ่านลายนิ้วมือสำหรับ Acer ProShield Security Suite
7		ปุ่มคลิก (ซ้ายและขวา)	ปุ่มซ้ายและขวาทำงานเหมือนกับปุ่มเมาส์ซ้ายและขวา
8		Num Lock	ติดสว่างในกรณีที่เปิดใช้ Num Lock
		ปุ่ม P	ปุ่มแบบกำหนดการทำงานเองได้ (ส่วนประกอบอาจแตกต่างกันไปตามรุ่น)
		ปุ่ม Acer email	เปิดแอปพลิเคชันอีเมลเริ่มต้นของคุณ
9		ปุ่มสำรองข้อมูล	เรียกใช้ Acer Backup Management เพื่อการสำรองข้อมูลสามขั้นตอน
		ปิดเสียงไมโครโฟน	ปิดเสียงไมโครโฟนชั่วคราว
		ปุ่มพาวเวอร์/ตัวแสดงสถานะ	เปิดและปิดคอมพิวเตอร์ ระบุสถานะการเปิดใช้งานคอมพิวเตอร์
10		ไมโครโฟน	ไมโครโฟนในตัวสองตัวสำหรับการบันทึกเสียงสเตอริโอ

## ปุ่มลัด

คอมพิวเตอร์จะมีคีย์ลัดหรือชุดแป้นกดเพื่อเข้าใช้งานส่วนควบคุมต่าง ๆ ของคอมพิวเตอร์ เช่น ความสว่างของหน้าจอและระดับเสียง

เพื่อเปิดใช้งานฮ็อตคีย์ ให้กดปุ่ม <Fn> ค้างเอาไว้ก่อนที่จะกดปุ่มอื่นในชุดฮ็อตคีย์





ฮ็อตคีย์	ไอคอน	ฟังก์ชัน	คำอธิบาย
<Fn> + <F3>		การสื่อสาร	เปิด/ปิด อุปกรณ์สื่อสารของคอมพิวเตอร์
<Fn> + <F4>		Sleep	ตั้งคอมพิวเตอร์ให้อยู่ในโหมด Sleep
<Fn> + <F5>		สลับจอแสดงผล	สลับเอาที่พู่จอแสดงผลระหว่างหน้าจอแสดงผล, จอแสดงผลภายนอก (หากเชื่อมต่ออยู่) และทั้งสองชนิด
<Fn> + <F6>		หน้าจอว่าง	ปิดไฟพื้นหลังจอแสดงผลเพื่อประหยัดพลังงาน กดปุ่มใดก็ได้เพื่อเปิดหน้าจอกลับมาอีกครั้ง
<Fn> + <F7>		เปิดปิดการใช้งานทัชแพด	เปิดและปิดทัชแพดบนเครื่อง
<Fn> + <F8>		เปิดปิดลำโพง	เปิดและปิดลำโพง
<Fn> + <+>		เพิ่มความสว่าง	เพิ่มความสว่างของหน้าจอ
<Fn> + <->		ลดความสว่าง	ลดความสว่างของหน้าจอ
<Fn> + <+>		เพิ่มเสียง	เพิ่มระดับเสียง
<Fn> + <->		ลดเสียง	ลดระดับเสียง
<Fn> + <Home>		เล่น/หยุดเล่น	เล่นหรือหยุดเล่นไฟล์มีเดียชั่วคราว
<Fn> + <Pg Up>		หยุด	หยุดการเล่นไฟล์มีเดีย
<Fn> + <Pg Dn>		ก่อนหน้า	กลับสู่ไฟล์มีเดียก่อนหน้า

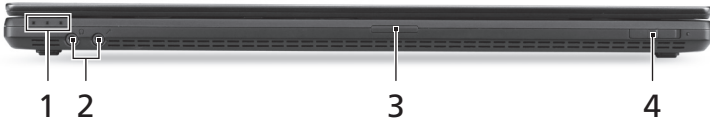

ชื่อย่อ	ไอคอน	ฟังก์ชัน	คำอธิบาย
<Fn> + <End>		ตัดไป	ไปสู่ไฟล์เมื่อดูวิดีโอ





## ปิดมุมมองด้านบน



#	ไอคอน	รายการ	คำอธิบาย
		ตัวแสดงพลังงาน	ระบุสถานะการเปิดใช้งานคอมพิวเตอร์
1		ตัวแสดงระดับแบตเตอรี่	แสดงถึงสถานะแบตเตอรี่ของคอมพิวเตอร์ <b>1. กำลังชาร์จ:</b> ไฟสว่างเป็นสีเหลืองอำพัน เมื่อทำการชาร์จแบตเตอรี่ <b>2. ชาร์จไฟเต็ม:</b> ไฟสีน้ำเงินติดสว่างขณะอยู่ในโหมด AC
		ตัวแสดงสถานะ HDD	แสดงเมื่อฮาร์ดดิสก์ไดรฟ์มีการทำงาน
2		ช่องต่อไมโครโฟน	ใช้สำหรับต่อไมโครโฟน
		แจ๊คหูฟัง/ลำโพง	เชื่อมต่ออุปกรณ์ออดิโอ (เช่น ลำโพง, หูฟัง)
3		การ์ดรีดเดอร์มัลติมีเดีย	สามารถใช้งานร่วมกับ Secure Digital (SD), MultiMediaCard (MMC), Memory Stick PRO (MS PRO), xD-Picture Card (xD) <b>หมายเหตุ:</b> กดเพื่อถอด/ใส่การ์ด ใช้งานได้ที่ละหนึ่งการ์ด
4		สวิทช์/ ตัวแสดงสถานะการสื่อสาร	เปิด/ปิดอุปกรณ์สื่อสารของคอมพิวเตอร์/ แสดงสถานะของอุปกรณ์เชื่อมต่อแบบไร้สาย

## มุมมองด้านหลัง



#	ไอคอน	รายการ	คำอธิบาย
1		ช่องเสียบ DC-in	เชื่อมต่อกับอะแดปเตอร์ AC
2		พอร์ต HDMI	รองรับการเชื่อมต่อระบบวีดีโอดิจิทัลความละเอียดสูง
3		พอร์ตจอแสดงผลภายนอก (VGA)	เชื่อมต่อกับจอแสดงผล (เช่น จอภาพภายนอก, โปรเจคเตอร์ LCD)
4		พอร์ต USB/eSATA	ใช้เชื่อมต่อกับอุปกรณ์ USB หรือ eSATA (สำหรับบางรุ่น) <b>หมายเหตุ:</b> หากคุณเสียบอุปกรณ์ eSATA คุณจะมีพอร์ต USB เหลือให้ใช้งานสามพอร์ต
5		สล็อต SmartCard	รองรับ SmartCard
6		สล็อต ExpressCard/34	รองรับโมดูล ExpressCard/34 <b>หมายเหตุ:</b> กดเพื่อถอด/ติดตั้งการ์ด

## มุมมองด้านขวา





#	ไอคอน	รายการ	คำอธิบาย
1		พอร์ต USB	
2		พอร์ต USB	เชื่อมต่อเข้ากับอุปกรณ์ USB หากพอร์ตเป็นสีดำ แสดงว่ามีความเข้ากันได้กับ USB 2.0 หากพอร์ตเป็นสีน้ำเงิน แสดงว่ามีความเข้ากันได้กับ USB 3.0
3		พอร์ต USB ที่สามารถชาร์จได้แม้เมื่อปิดเครื่อง	
4		ไดรฟ์ออปติคัล	ไดรฟ์ออปติคัลภายใน สำหรับใส่ CD หรือ DVD
5		ไฟแสดงการอ่านออปติคัลดิสก์	ติดสว่างเมื่อมีการอ่านแผ่นออปติคัล
6		ปุ่มกดแผ่นออปติคัลออก	นำแผ่นออปติคัลออกจากไดรฟ์
7		ปุ่มนำแผ่นออกฉุกเฉิน	ใช้เปิดถาดใส่แผ่นออปติคัลขณะปิดคอมพิวเตอร์ <b>หมายเหตุ:</b> สอดคลิปหนีบกระดาษเข้าในช่องนำแผ่นออกฉุกเฉิน เพื่อเปิดถาดใส่แผ่นออปติคัลขณะปิดคอมพิวเตอร์อยู่
8		พอร์ต Ethernet (RJ-45)	เชื่อมต่อเครือข่าย Ethernet 10/100/1000
9		สล็อกสล็อก Kensington	พ่วงต่อกับระบบสล็อกความปลอดภัยสำหรับคอมพิวเตอร์ที่ใช้งานร่วมกับ Kensington <b>หมายเหตุ:</b> คล้องสายสล็อกป้องกันคอมพิวเตอร์กับส่วนประกอบที่ยึดตาย เช่น โต๊ะ มือจับหรือลิ้นชักที่สล็อกอยู่ ใส่ตัวสล็อกลงในร่องบากและหมุนตัวสล็อกไปยังตำแหน่งสล็อกในบางรุ่นอาจไม่มีระบบสล็อกนี้

## ข้อมูลเกี่ยวกับ USB 3.0

- เข้ากันได้กับ USB 3.0 และอุปกรณ์ USB รุ่นก่อนหน้า
- เพื่อประสิทธิภาพสูงสุด ใช้อุปกรณ์ USB 3.0 ที่ได้รับการรับรอง
- กำหนดตามมาตรฐาน USB 3.0 (SuperSpeed USB)

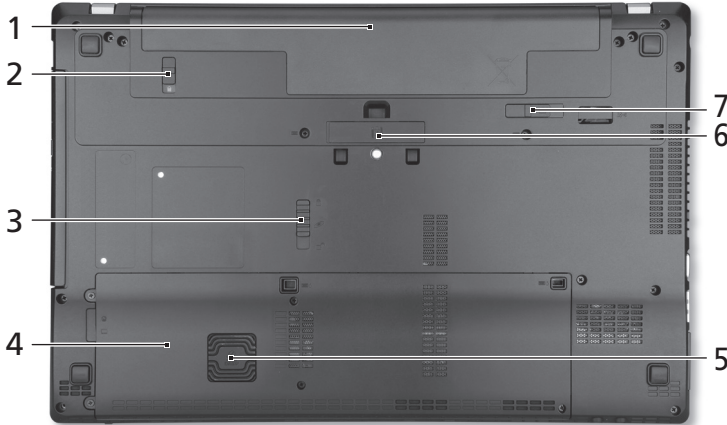
## มุมมองด้านล่าง



#	ไอคอน	รายการ	คำอธิบาย
1		ช่องใส่แบตเตอรี่	ที่อยู่ของแบตเตอรี่ของคอมพิวเตอร์
2		ลิ้นคแบตเตอรี่	ลิ้นคแบตเตอรี่ให้อยู่ในตำแหน่ง
3		สลักปลด Acer MediaBay	ปลดโมดูล Acer MediaBay
4		ช่องใส่ฮาร์ดดิสก์	ที่อยู่ของฮาร์ดดิสก์ของคอมพิวเตอร์ (ยึดติดแน่นด้วยน็อต)
		ช่องหน่วยความจำ	ที่อยู่ของหน่วยความจำของคอมพิวเตอร์
5		Acer DASP (Disk Anti-Shock Protection)	ปกป้องฮาร์ดดิสก์จากการสั่นสะเทือนและการกระแทก
6		คอนเน็กเตอร์ Acer ProDock	เชื่อมต่ออุปกรณ์เสริม Acer ProDock
7		สลักเปิดแบตเตอรี่	เปิดเพื่อนำแบตเตอรี่ออก

## สิ่งแวดล้อม

---

- อุณหภูมิ:
    - ขณะทำงาน: 5°C ถึง 35°C
    - ขณะไม่ได้ใช้งาน: -20°C ถึง 65°C
  - ความชื้น (ไม่ควบนั่นเป็นไอน้ำ):
    - ขณะทำงาน: 20% ถึง 80%
    - ขณะไม่ได้ใช้งาน: 20% ถึง 80%
-