

English
Français
Deutsch
Italiano
Español
Português
Nederlands
Norsk
Dansk
Svenska
Suomi
Русский
Polski
Magyar
Čeština
Slovenčina
Slovenski
Hrvatski
Română
Български
Eesti
Latviski
Lietuviškai
Ελληνικά
Türkçe
日本語
한국어
繁體中文
简体中文
Bahasa Indonesia
ไทย

Contents

TravelMate 4740/4740Z/4340 Series

Quick Guide

© 2010 All Rights Reserved.

TravelMate 4740/4740Z/4340 Series Quick Guide
Original Issue: 02/2010

TravelMate 4740/4740Z/4340 Series Notebook PC

Model number: _____

Serial number: _____

Date of purchase: _____

Place of purchase: _____

First things first

We would like to thank you for making an Acer notebook your choice for meeting your mobile computing needs.

Your guides

To help you use your Acer notebook, we have designed a set of guides:

First off, the poster helps you get started with setting up your computer.

The **TravelMate Series Generic User Guide** contains useful information applying to all models in the TravelMate product series. It covers basic topics such as using the keyboard and audio, etc. Please understand that due to its nature, the **Generic User Guide** as well as the **AcerSystem User Guide** mentioned below will occasionally refer to functions or features which are only contained in certain models of the series, but not necessarily in the model you purchased. Such instances are marked in the text with language such as "only for certain models".

The **Quick Guide** introduces you to the basic features and functions of your new computer. For more on how your computer can help you to be more productive, please refer to the **AcerSystem User Guide**. This guide contains detailed information on such subjects as system utilities, data recovery, expansion options and troubleshooting. In addition it contains warranty information and the general regulations and safety notices for your notebook. It is available in Portable Document Format (PDF) and comes preloaded on your notebook. Follow these steps to access it:

- 1 Click on  **Start > All Programs > AcerSystem**.
- 2 Click on **AcerSystem User Guide**.



.....

Note: Viewing the file requires Adobe Reader. If Adobe Reader is not installed on your computer, clicking on **AcerSystem User Guide** will run the Adobe Reader setup program first. Follow the instructions on the screen to complete the installation. For instructions on how to use Adobe Reader, access the **Help and Support** menu.





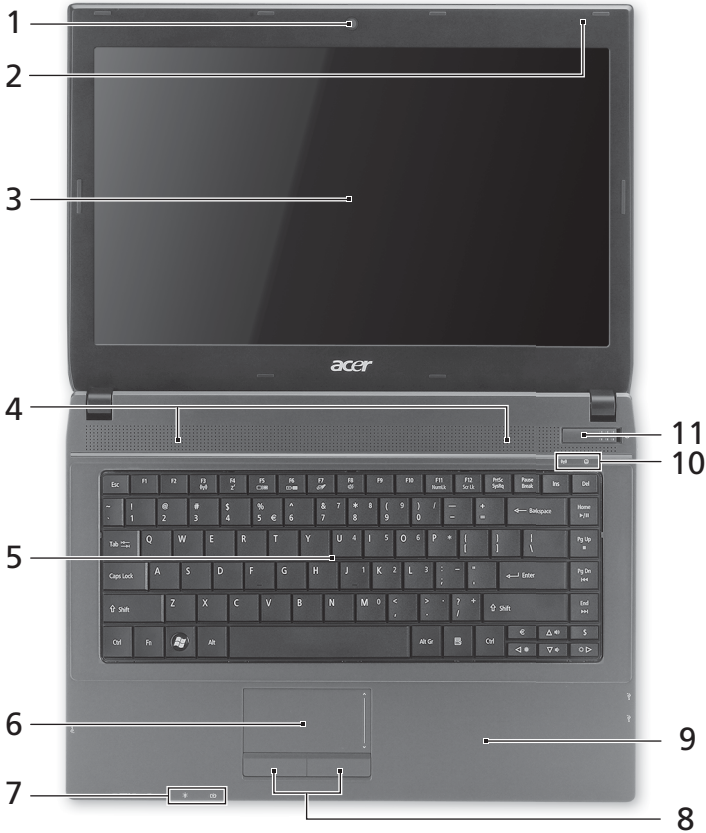

Your Acer notebook tour

After setting up your computer as illustrated in the poster, let us show you around your new Acer notebook.

Top view



#	Icon	Item	Description
1		Acer Crystal Eye webcam	Web camera for video communication (only for certain models).

#	Icon	Item	Description
2		Microphone	Internal microphone for recording sound.
3		Display screen	Also called Liquid-Crystal Display (LCD), displays computer output (configuration may vary by model).
4		Speakers	Left and right speakers deliver stereo audio output.
5		Keyboard	For entering data into your computer.
6		Touchpad	Touch-sensitive pointing device which functions like a computer mouse.
7		Power indicator ¹	Indicates the computer's power status.
		Battery indicator ¹	Indicates the computer's battery status. 1. Charging: The light shows amber when the battery is charging. 2. Fully charged: The light shows blue when in AC mode.
8		Click buttons (left and right)	The left and right buttons function like the left and right mouse buttons.
9		Palmrest	Comfortable support area for your hands when you use the computer.
10		Communication indicator	Indicates the computer's wireless connectivity device status.
		HDD indicator	Indicates when the hard disk drive is active.
11		Power switch	Turns the computer on and off.

1. The front panel indicators are visible even when the computer cover is closed up.









Note: The exact configuration of your PC depends on the model purchased.

Hotkeys

The computer employs hotkeys or key combinations to access most of the computer's controls like screen brightness and volume output.

To activate hotkeys, press and hold the **<Fn>** key before pressing the other key in the hotkey combination.

Hotkey	Icon	Function	Description
<Fn> + <F3>		Communication key	Enables / disables the computer's communication devices. (Communication devices may vary by configuration.)
<Fn> + <F4>		Sleep	Puts the computer in Sleep mode.
<Fn> + <F5>		Display toggle	Switches display output between the display screen, external monitor (if connected) and both.
<Fn> + <F6>		Display off	Turns the display screen backlight off to save power. Press any key to return.
<Fn> + <F7>		Touchpad toggle	Turns the internal touchpad on and off.
<Fn> + <F8>		Speaker toggle	Turns the speakers on and off.
<Fn> + <F11>	NumLk	NumLock	Turns the embedded numeric keypad on or off.
<Fn> + <F12>	Scr Lk	Scroll Lock	When Scroll Lock is on, the screen moves one line up or down when you press the up or down arrow keys respectively. Scroll Lock does not work with some applications.
<Fn> + <↑>		Brightness up	Increases the screen brightness.
<Fn> + <↓>		Brightness down	Decreases the screen brightness.
<Fn> + <△>		Volume up	Increases the sound volume.
<Fn> + <▽>		Volume down	Decreases the sound volume.
<Fn> + <Home>		Play/Pause	Play or pause a selected media file.
<Fn> + <Pg Up>		Stop	Stop playing the selected media file.
<Fn> + <Pg Dn>		Previous	Return to the previous media file.
<Fn> + <End>		Next	Jump to the next media file.





Closed front view

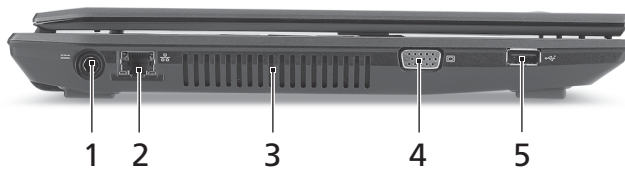

#	Icon	Item	Description
1		Multi-in-1 card reader	Accepts Secure Digital (SD), MultiMediaCard (MMC), Memory Stick (MS), Memory Stick PRO (MS PRO), xD-Picture Card (xD). Note: Push to remove/install the card. Only one card can operate at any given time.





Left view

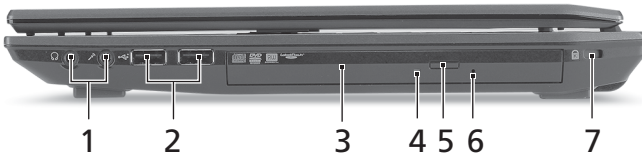

#	Icon	Item	Description
1		DC-in jack	Connects to an AC adapter.
2		Ethernet (RJ-45) port	Connects to an Ethernet 10/100/1000-based network.
3		Ventilation slots	Enable the computer to stay cool, even after prolonged use.
4		External display (VGA) port	Connects to a display device (e.g., external monitor, LCD projector).
5		USB 2.0 port	Connect to USB 2.0 devices (e.g., USB mouse, USB camera).





Right view



#	Icon	Item	Description
1		Headphones/ speaker/line-out jack	Connects to audio line-out devices (e.g., speakers, headphones).
		Microphone jack	Accepts inputs from external microphones.
2		USB 2.0 port	Connect to USB 2.0 devices (e.g., USB mouse, USB camera).
3		Optical drive	Internal optical drive; accepts CDs or DVDs.
4		Optical disk access indicator	Lights up when the optical drive is active.
5		Optical drive eject button	Ejects the optical disk from the drive.
6		Emergency eject hole	Ejects the optical drive tray when the computer is turned off. Note: Insert a paper clip to the emergency eject hole to eject the optical drive tray when the computer is off.
7		Kensington lock slot	Connects to a Kensington-compatible computer security lock.

Base view



#	Icon	Item	Description
1		Battery bay	Houses the computer's battery pack.
2		Battery lock	Locks the battery in position.
3		Hard disk bay	Houses the computer's hard disk (secured with screws).
4		Memory compartment	Houses the computer's main memory.
5		Ventilation slots and cooling fan	Enable the computer to stay cool, even after prolonged use. Note: Do not cover or obstruct the opening of the fan.
6		Battery release latch	Releases the battery for removal.

Environment

- Temperature:
 - Operating: 5°C to 35°C
 - Non-operating: -20°C to 65°C
- Humidity (non-condensing):
 - Operating: 20% to 80%
 - Non-operating: 20% to 80%

Gamme TravelMate 4740/ 4740Z/4340

Guide rapide

© 2010 Tous droits réservés.

Guide rapide de la gamme TravelMate 4740/4740Z/4340

Première publication : 03/2010

Ordinateur notebook de la gamme TravelMate 4740/4740Z/4340

Modèle : _____

No. de série : _____

Date d'achat : _____

Lieu d'achat : _____

Pour commencer

Nous désirons vous remercier d'avoir fait d'un notebook Acer votre choix pour répondre à vos besoins informatiques mobiles.

Vos guides

Pour vous aider à utiliser votre notebook Acer, nous avons conçu plusieurs guides:

Tout d'abord, le poster vous aide à configurer votre ordinateur.

Le **Guide Utilisateur Générique de la gamme TravelMate** contient des informations utiles qui s'appliquent à tous les modèles de la gamme des produits TravelMate. Il couvre les sujets de base, telles qu'utiliser le clavier, le son, etc. Il faut comprendre que du fait de sa nature, le **Guide générique** ainsi que le **Guide utilisateur AcerSystem** mentionné ci-dessous fera référence parfois à des fonctions ou des caractéristiques qui ne sont contenues que dans certains modèles de la gamme, mais pas nécessaire dans le modèle que vous avez acheté. Ces cas sont marqués dans le texte avec des mentions telles que «seulement pour certains modèles».

Le **Guide rapide** présente les fonctionnalités et fonctions de base de votre ordinateur. Pour plus d'information sur l'aide que peut vous apporter pour être plus productif, veuillez vous reporter au **Guide Utilisateur AcerSystem**. Ce guide contient des informations détaillées sur des sujets tels que les utilitaires systèmes, la récupération des données, les options d'extension et le dépannage. De plus, il contient des informations de garantie et les réglementations générales et les avis de sécurité pour votre notebook. Il est disponible au format PDF (Portable Document Format) et est préchargé sur votre notebook. Procédez comme suit pour y accéder :

- 1 Cliquez sur  **Démarrer** > **Tous les programmes** > **AcerSystem**.
- 2 Cliquez sur le **Guide utilisateur AcerSystem**.



.....

Remarque : L'affichage du fichier nécessite Adobe Reader. Si Adobe Reader n'est pas installé dans votre ordinateur, le clic sur le **Guide utilisateur AcerSystem** va exécuter le programme d'installation d'Adobe Reader. Suivez les instructions à l'écran pour terminer l'installation. Pour des instructions sur l'utilisation de Adobe Reader, accédez au menu **Aide et Support**.





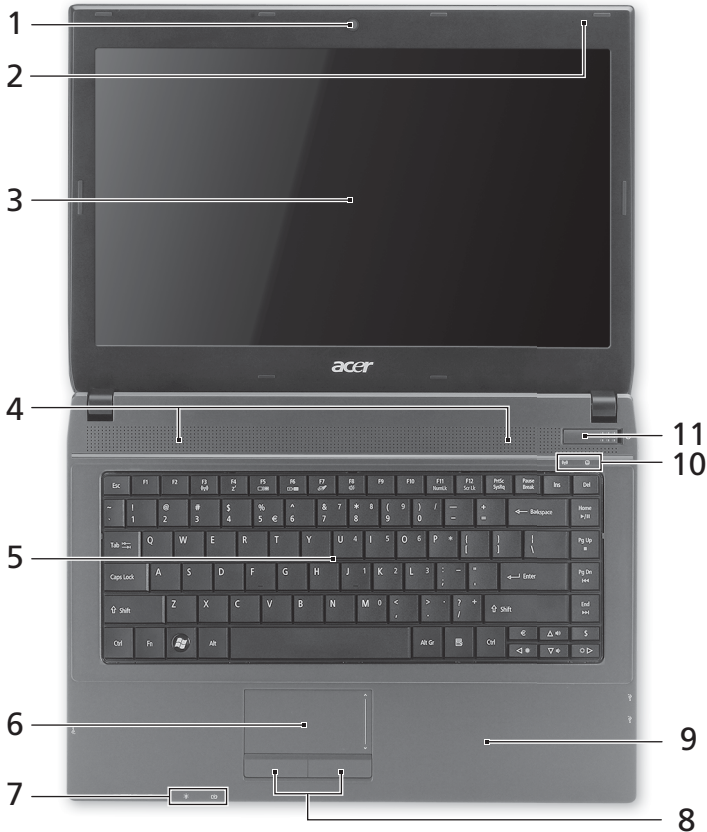

Votre visite guidée du notebook Acer

Après avoir configuré votre ordinateur comme illustré dans le poster, nous allons vous faire explorer votre nouveau notebook Acer.

Vue supérieure



#	Icône	Élément	Description
1		Webcam Acer Crystal Eye	Webcam pour communication video (seulement pour certains modèles).

#	Icône	Élément	Description
2		Microphone	Microphone interne pour l'enregistrement sonore.
3		Écran d'affichage	Également appelé écran LCD (Liquid Crystal Display), affiche les données de l'ordinateur (la configuration peut varier en fonction du modèle).
4		Haut-parleurs	Les haut-parleurs de gauche et de droite produisent une sortie audio stéréo.
5		Clavier	Pour l'entrée des informations dans votre ordinateur.
6		Touchpad	Périphérique de pointage sensible au touché qui fonctionne comme une souris.
7		Indicateur d'alimentation ¹	Indique l'état d'alimentation de l'ordinateur.
		Indicateur de batterie ¹	Indique l'état de la pile de l'ordinateur. 1. Charge : La diode est orange lorsque la batterie se recharge. 2. Pleine charge : La diode est bleue en mode secteur.
8		Boutons (gauche et droit)	Le bouton gauche et le bouton droit fonctionnent comme le bouton gauche et le bouton droit d'une souris.
9		Repose mains	Zone de support confortable pour vos mains lorsque vous utilisez l'ordinateur.
10		Indicateur de communication	Indique l'état du périphérique de connectivité sans fil de l'ordinateur.
		Indicateur du disque dur	Indique l'activité du disque dur.
11		Interrupteur d'alimentation	Met l'ordinateur sous tension et hors tension.

1. Les indicateurs du panneau avant sont visibles même lorsque l'écran LCD est fermé.

















Remarque : La configuration exacte de votre ordinateur dépend du modèle acheté.

Touches spéciales

L'ordinateur emploie des touches spéciales (combinaisons de touches) pour accéder à la plupart des contrôles de l'ordinateur comme la luminosité de l'écran et le volume sonore.

Pour activer les touches spéciales, appuyez et maintenez la touche **<Fn>** avant d'appuyer sur l'autre touche dans la combinaison de la touche spéciale.

Touche spéciale	Icône	Fonction	Description
<Fn> + <F3>		Touche Communication	Active/désactive les périphériques de communication de l'ordinateur. (Les périphériques de communication peuvent varier en fonction de la configuration.)
<Fn> + <F4>		Sommeil	Place l'ordinateur en mode de Sommeil.
<Fn> + <F5>		Choix de l'affichage	Permet de permuter l'affichage entre l'écran d'affichage, le moniteur externe (s'il est connecté) et les deux.
<Fn> + <F6>		Affichage éteint	Désactive le rétro éclairage de l'écran pour économiser l'énergie. Appuyez sur une touche pour le rallumer.
<Fn> + <F7>		Touchpad	Active et désactive le touchpad.
<Fn> + <F8>		Haut-parleur	Active et désactive les haut-parleurs.
<Fn> + <F11>	NumLk	NumLock	Active ou désactive le pavé numérique intégré.
<Fn> + <F12>	Scr Lk	Scroll Lock	Quand Arrêt Défil est allumé, l'écran se déplace d'une ligne vers le haut ou le bas quand vous appuyez sur la touche fléchée vers le haut ou le bas respectivement. Cette touche de verrouillage ne fonctionne pas avec certaines applications.
<Fn> + <▷>		Accroissement de la luminosité	Augmente la luminosité de l'écran.
<Fn> + <◁>		Décroissement de la luminosité	Diminue la luminosité de l'écran.
<Fn> + <△>		Volume +	Augmente le volume sonore.
<Fn> + <▽>		Volume -	Diminue le volume sonore.
<Fn> + <Origine>		Lecture/Pause	Lisez ou effectuez une pause d'un fichier multimédia sélectionné.
<Fn> + <Pg préc.>		Arrêter	Arrêtez la lecture du fichier multimédia sélectionné.

Touche spéciale	Icône	Fonction	Description
<Fn> + <Pg suiv.>		Précédent	Retournez au fichier multimédia précédent.
<Fn> + <Fin>		Suiv	Passez au fichier multimédia suivant.



Vue frontale fermée

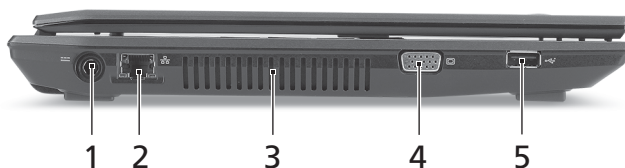

#	Icône	Élément	Description
1		Lecteur de cartes multiples en un	<p>Accepte une carte mémoire Secure Digital (SD), MultiMediaCard (MMC), Memory Stick (MS), Memory Stick Pro (MS PRO), et xD-Picture (xD).</p> <p>Remarque : Poussez pour retirer/installer la carte. Seule une carte peut fonctionner à un moment donné.</p>

Vue gauche





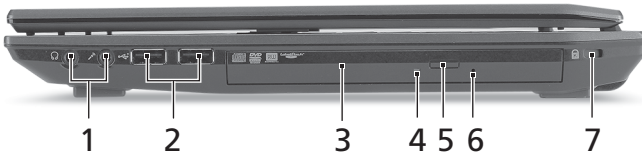

#	Icône	Élément	Description
1		Prise d'alimentation	Se connecte à l'adaptateur secteur.
2		Port Ethernet RJ-45	Se connecte à un réseau Ethernet 10/100/1000 Base.
3		Fentes de ventilation	Permettent à l'ordinateur de rester froid, même après une longue utilisation.
4		Port d'affichage (VGA) externe	Se connecte à un périphérique d'affichage (p.ex. un moniteur externe, un projecteur LCD).

#	Icône	Élément	Description
5		Port USB 2.0	Se connectent à des périphériques USB 2.0 (p.ex. une souris USB, une caméra USB).





Vue droite



#	Icône	Élément	Description
1		Prise de sortie audio/haut-parleurs/casque	Se connecte à des périphériques audio en sortie (p.ex. haut-parleurs ou un casque stéréo).
		Prise microphone	Accepte les entrées de microphones externes.
2		Port USB 2.0	Se connectent à des périphériques USB 2.0 (p.ex. une souris USB, une caméra USB).
3		Lecteur optique	Lecteur optique interne, accepte les CD ou les DVD.
4		Indicateur d'accès du disque optique	S'allume lorsque le lecteur optique est actif.
5		Bouton d'éjection du lecteur optique	Éjecte le disque optique du lecteur.
6		Trou d'éjection d'urgence	Éjecte le plateau du lecteur optique lorsque l'ordinateur est hors tension. Remarque : Insérez un trombone dans le trou d'éjection d'urgence pour éjecter le plateau du lecteur optique même quand l'ordinateur est éteint.
7		Fente pour cadenas Kensington	Se connecte à un cadenas de sécurité pour ordinateur Kensington.

Vue de la base



#	Icône	Élément	Description
1		Baie de la batterie	Contient la batterie de l'ordinateur.
2		Verrou de la batterie	Verrouille la batterie en position.
3		Baie du disque dur	Contient le disque dur de l'ordinateur (fixé avec des vis).
4		Compartiment mémoire	Contient la mémoire principale de l'ordinateur.
5		Fentes de ventilation et ventilateur de refroidissement	Permettent à l'ordinateur de rester froid, même après une longue utilisation. Remarque : Ne couvrez pas et ne bloquez pas l'ouverture du ventilateur.
6		Loquet de libération de la batterie	Libère la batterie pour le retrait.

Environnement

- Température :
 - En marche : 5°C à 35°C
 - À l'arrêt : -20°C à 65°C
- Humidité (sans condensation) :
 - En marche : 20% à 80%
 - À l'arrêt : 20% à 80%

TravelMate 4740/ 4740Z/4340 Serie

Kurzanleitung

© 2010 Alle Rechte vorbehalten.

Kurzanleitung für TravelMate 4740/4740Z/4340 Serie
Originalausgabe: 03/2010

Notebook-PC der TravelMate 4740/4740Z/4340 Serie

Modellnummer: _____

Seriennummer: _____

Kaufdatum: _____

Kaufort: _____

Das Wichtigste zuerst

Wir möchten uns bei Ihnen dafür bedanken, dass Sie sich in Bezug auf mobilen Computerbedarf für ein Acer-Notebook entschieden haben.

Hilfen

Als Hilfe für Sie beim Benutzen Ihres Acer-Notebooks haben wir einen Satz von Richtlinien aufgestellt:

Zuallererst hilft Ihnen das Übersichtsblättchen, den Computer das erste Mal in Betrieb zu nehmen.

Die ausgedruckte **Allgemeine Bedienungsanleitung für die TravelMate Serie** enthält hilfreiche Informationen, die sich auf alle Modelle der TravelMate-Produktserien beziehen. Es werden Themen wie z. B. die Verwendung der Tastatur und der Audiofunktion usw. behandelt. Die **Allgemeine Bedienungsanleitung** und die **AcerSystem Bedienungsanleitung** können sich z. T. auf Funktionen oder Eigenschaften beziehen, die es nur in bestimmten Modellen der Serien und nicht unbedingt in dem von Ihnen erworbenen Modell gibt. Solche Stellen sind im Text mit „Nur für bestimmte Modelle“ gekennzeichnet.

Die **Kurzanleitung** stellt Ihnen die grundlegenden Features und Funktionen Ihres neuen Computers vor. Für weitere Informationen dazu, wie Ihnen Ihr Computer helfen kann, noch produktiver zu arbeiten, lesen Sie bitte die **AcerSystem Benutzeranleitung**. Dieses Benutzerhandbuch enthält detaillierte Informationen zu Themen wie z.B. System-Programmen, Datenwiederherstellung, Erweiterungsoptionen und Problembehebung. Darüber hinaus enthält es Informationen zur Garantie und allgemeine Bestimmungen und Sicherheitshinweise zu Ihrem Notebook. Das Benutzerhandbuch steht in PDF (Portable Document Format) zur Verfügung und ist bereits in Ihrem Notebook installiert. Gehen Sie folgendermaßen vor, um auf das Benutzerhandbuch zuzugreifen:

- 1 Klicken Sie auf  **Start > Alle Programme > AcerSystem.**
- 2 Klicken Sie auf **AcerSystem-Bedienungsanleitung.**



Hinweis: Zum Betrachten der Datei muß Adobe Reader installiert sein. Wenn Adobe Reader nicht auf Ihrem Computer installiert ist, wird durch Klicken auf **AcerSystem-Bedienungsanleitung** zuerst das Setup-Programm von Adobe Reader ausgeführt. Folgen Sie zur Durchführung der Installation den Anweisungen auf dem Bildschirm. Hinweise über die Verwendung von Adobe Reader finden Sie im Menü **Hilfe und Support.**



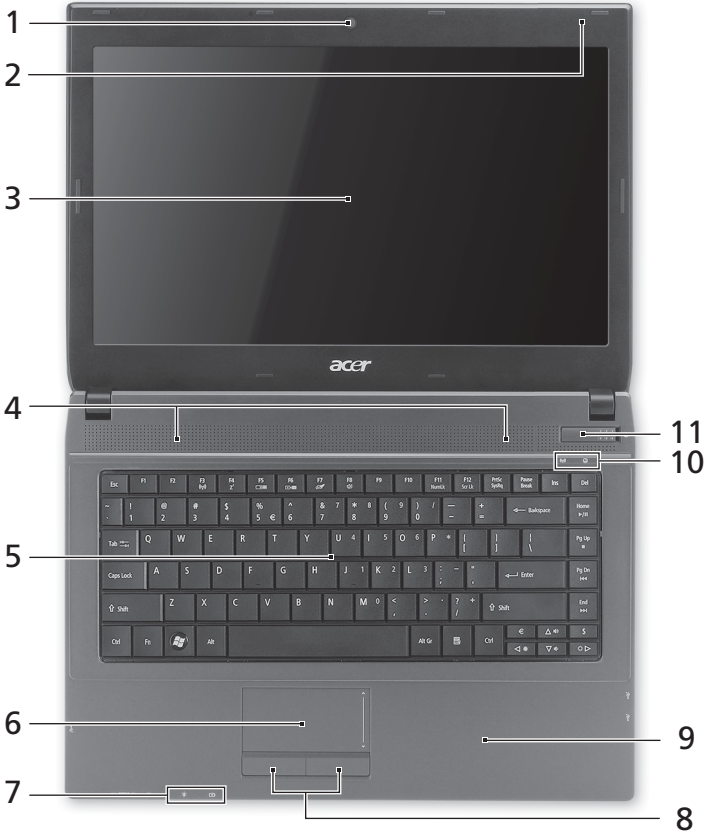

Ihre Acer-Notebook-Tour

Nachdem Sie den Computer wie im Übersichtsblättchen gezeigt aufgestellt haben, finden Sie im Folgenden eine Übersicht über Ihr neues Acer-Notebook.

Ansicht von oben



#	Symbol	Element	Beschreibung
1		Acer Crystal Eye Webcam	Web-Kamera für Videokommunikation (Nur für bestimmte Modelle).

#	Symbol	Element	Beschreibung
2		Mikrofon	Internes Mikrofon für Tonaufnahme.
3		Anzeigebildschirm	Wird auch als LCD (Liquid-Crystal-Display) bezeichnet. Zeigt die Ausgabe des Computers an (Konfiguration kann sich von Modell zu Modell unterscheiden).
4		Lautsprecher	Linker und rechter Lautsprecher bieten Audioausgabe in Stereo.
5		Tastatur	Dient der Eingabe von Daten in den Computer.
6		Touchpad	Berührungssensibles Zeigegerät, das die gleichen Funktionen besitzt wie eine Computer-Maus.
7		Stromanzeige ¹	Zeigt den Ein/Aus-Status des Computers an.
		Akkuanzeige ¹	Zeigt den Akkustatus des Computers an. 1. Ladung wird durchgeführt: Die Leuchte erscheint gelb, wenn der Akku aufgeladen wird. 2. Voll aufgeladen: Die Leuchte erscheint blau, wenn Netzstrom verwendet wird.
8		Anklicktasten (links und rechts)	Die linken und rechten Tasten funktionieren wie die linken und rechten Tasten einer Maus.
9		Handablage	Bequemer Ablagebereich für Ihre Hände während der Bedienung des Computers.
10		Anzeige für Kommunikation	Zeigt den Drahtlos-Konnektivitätsstatus des Computers an.
		HDD-Anzeige	Leuchtet auf, wenn die Festplatte aktiv ist.
11		Netzschalter	Schaltet den Computer ein und aus.

1. Die Statusanzeigen auf der Vorderseite sind selbst dann zu sehen, wenn die Computerklappe geschlossen ist.













.....
Hinweis: Die genaue Konfiguration Ihres PCs hängt von dem Modell ab, das Sie kaufen.

Tastenkombinationen

Der Computer besitzt Direkttasten oder Tastenkombinationen für den Zugriff auf Computersteuerungen wie z. B. Bildschirmhelligkeit und Ausgangslautstärke.

Zum Aktivieren von Hotkeys müssen Sie zuerst die **<Fn>**-Taste drücken und halten und dann die andere Taste der Hotkey-Kombination drücken.

Tastenkombination	Symbol	Funktion	Beschreibung
<Fn> + <F3>		Kommunikationstaste	Aktiviert/deaktiviert die Kommunikationseinrichtungen des Computers. (Kommunikationsgeräte können sich je nach Konfiguration unterscheiden.)
<Fn> + <F4>		Energiesparmodus	Schaltet den Computer in den Energiesparmodus.
<Fn> + <F5>		Display-Schalter	Wechselt die Anzeigeausgabe zwischen Anzeigebildschirm, externem Monitor (falls angeschlossen) und gleichzeitig beiden Anzeigen.
<Fn> + <F6>		Anzeige aus	Schaltet die Hintergrundbeleuchtung des Bildschirms aus, um Energie zu sparen. Drücken Sie zum Einschalten eine beliebige Taste.
<Fn> + <F7>		Touchpad-Schalter	Schaltet das interne Touchpad ein oder aus.
<Fn> + <F8>		Lautsprecher-schalter	Schaltet die Lautsprecher ein und aus.
<Fn> + <F11>	NumLk	NumLock	Schaltet integrierte numerische Tastenfeld ein oder aus.
<Fn> + <F12>	Scr Lk	Scroll Lock	Wenn Scroll Lock (Rollen) aktiviert ist, bewegt sich die Bildschirmanzeige eine Zeile nach oben oder unten, wenn Sie die jeweiligen Pfeiltasten drücken. Bei einigen Anwendungen hat Rollen keine Funktion.
<Fn> + <◀▶>		Heller	Erhöht die Bildschirmhelligkeit.
<Fn> + <◀◀>		Dunkler	Verringert die Bildschirmhelligkeit.
<Fn> + <▲>		Lauter	Erhöht die Lautstärke.
<Fn> + <▲▼>		Leiser	Verringert die Lautstärke.

Tastenkombination	Symbol	Funktion	Beschreibung
<Fn> + <Pos1>	▶/	Wiedergabe/ Pause	Geben Sie hiermit die ausgewählte Mediendatei wieder und halten Sie die Wiedergabe an.
<Fn> + <Seite nach oben>	■	Stopp	Beenden Sie hiermit die Wiedergabe der ausgewählten Mediendatei.
<Fn> + <Seite nach unten>	◀◀	Zurück	Hiermit gelangen Sie zur vorherigen Mediendatei zurück.
<Fn> + <Ende>	▶▶	Weiter	Hiermit springen Sie zur nächsten Mediendatei.





Geschlossene Vorderseite

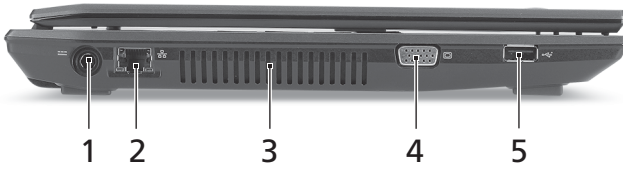

#	Symbol	Element	Beschreibung
1		Mehrere-in-1-Kartenleser	<p>Eignet sich für Secure Digital (SD), MultiMediaCard (MMC), Memory Stick (MS), Memory Stick PRO (MS PRO) und xD-Picture Card (xD).</p> <p>Hinweis: Drücken Sie hier, um die Karte zu entfernen/einzusetzen. Es kann nicht mehr als eine Karte gleichzeitig verwendet werden.</p>

Linke Seite



#	Symbol	Element	Beschreibung
1		DC-Eingangsbuchse	Hier schließen Sie das Netzteil an.
2		Ethernet (RJ-45)-Anschluss	Hier schließen Sie ein auf Ethernet 10/100/1000-basiertes Netzwerk an.
3		Belüftungsschlitze	Schützt den Computer vor Überhitzung, selbst bei längerem Einsatz.
4		Anschluss für externe Anzeige (VGA)	Hier schließen Sie ein Anzeigegerät an. (z. B. einen externen Monitor oder LCD-Projektor).
5		USB 2.0-Anschluss	Zum Anschluss von USB 2.0-Geräten (z. B. USB-Maus, USB-Kamera).





Rechte Seite

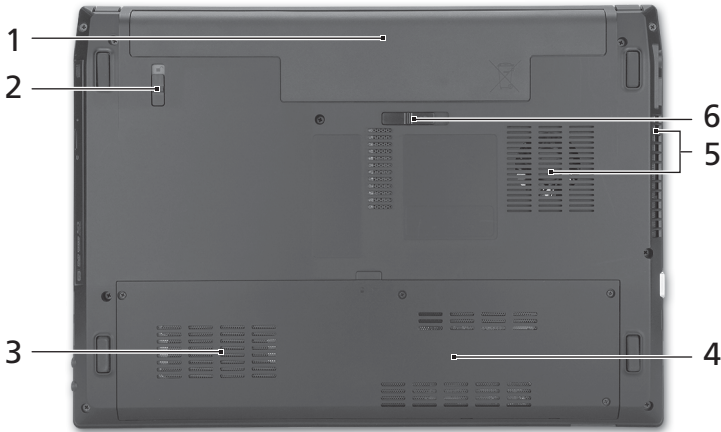

#	Symbol	Element	Beschreibung
1		Kopfhörer-/ Lautsprecher-/ Ausgabe-Buchse	Zum Anschluss von Audioausgabe-Geräten (z. B. Lautsprecher, Kopfhörer).
		Mikrofonbuchse	Eignet sich für Eingaben aus externen Mikrofonen.
2		USB 2.0-Anschluss	Zum Anschluss von USB 2.0-Geräten (z. B. USB-Maus, USB-Kamera).
3		Optisches Laufwerk	Internes optisches Laufwerk; eignet sich für CDs oder DVDs.
4		Optische Disk Anzeige	Leuchtet auf, wenn optisches Laufwerk aktiv ist.
5		Auswurfmechanismus für optisches Laufwerk	Fährt das optische Laufwerk heraus.
6		Mechanisches Auswurfloch	Schiebt den Träger des optischen Laufwerkes aus, wenn der Computer ausgeschaltet ist. Hinweis: Stecken Sie eine Büroklammer in das Auswurfloch, um den Träger des optischen Laufwerkes herauszufahren, wenn der Computer nicht eingeschaltet ist.
7		Steckplatz für Kensington-Schloss	Hier können Sie ein Kensington- kompatibles Sicherheitsschloss für den Computer anbringen.

Unterseite



#	Symbol	Element	Beschreibung
1		Akkufach	Enthält den Akku des Computers.
2		Akkuerschluss	Sichert den Akku an seiner Position.
3		Festplattenfach	Gehäuse der Computer-Festplatte (durch Schrauben gesichert).
4		Speicherfach	Enthält den Hauptspeicher des Computers.
5		Belüftungsschlitze und Ventilator	Schützt den Computer vor Überhitzung, selbst bei längerem Einsatz. Hinweis: Verdecken oder schließen Sie nicht die Öffnungen des Ventilators.
6		Verriegelung des Akkus	Entsperrt den Akku für die Herausnahme.

Umgebung

- Temperatur:
 - Betrieb: 5°C bis 35°C
 - Nichtbetrieb: -20°C bis 65°C
- Luftfeuchtigkeit (nicht kondensierend):
 - Betrieb: 20% bis 80%
 - Nichtbetrieb: 20% bis 80%

Serie TravelMate 4740/ 4740Z/4340

Guida rapida

© 2010 Tutti i diritti riservati.

Guida rapida Serie TravelMate 4740/4740Z/4340
Prima edizione: 03/2010

PC Notebook Serie TravelMate 4740/4740Z/4340

Numero di modello: _____

Numero di serie: _____

Data di acquisto: _____

Luogo d'acquisto: _____

Avvertenze preliminari

Grazie per aver scelto il notebook Acer, la scelta ideale per poter lavorare in piena libertà anche in movimento.

Le guide disponibili

Sono state realizzate delle guide per assistere l'utente nell'uso del notebook Acer:

Innanzitutto, il manifesto aiuta a semplificare la configurazione del computer.

Il **Manuale dell'utente di TravelMate Series** contiene informazioni utili per tutti i modelli della serie TravelMate. Copre gli argomenti base come ad esempio l'uso di tastiera e audio, ecc. A causa della sua natura, la **Guida generale** così come il **Manuale utente di AcerSystem** menzionata in precedenza a volte fa riferimento a funzioni o caratteristiche presenti solamente in alcuni modelli della serie, ma non necessariamente del modello acquistato. Per questo motivo alcuni elementi nel testo sono indicati con "solo per alcuni modelli".

La **Guida rapida** presenta le caratteristiche e le funzioni principali del nuovo computer. Per altre nozioni su come il vostro computer può aiutarvi a diventare ancora più produttivi, consultate la **AcerSystem User's Guide**. Questa guida contiene informazioni dettagliate su argomenti come utilità del sistema, ripristino dei dati, opzioni di espansione e ricerca guasti. Contiene inoltre informazioni sulla garanzia, le norme e gli standard di riferimento e le avvertenze per la sicurezza del vostro notebook. È disponibile nel formato PDF e viene fornita già caricata nel notebook. Per accedervi seguite questi passaggi:

- 1 Fare clic su  **Start > Programmi > AcerSystem**.
- 2 Fare clic su **AcerSystem User's Guide**.



.....

Nota: Per visualizzare il file, è necessario che sul computer sia installato Adobe Reader. Se Adobe Acrobat Reader non è installato sul computer, fare clic su **AcerSystem User's Guide** per eseguire il programma di installazione di Adobe Reader. Per completare l'installazione, attenersi alle istruzioni visualizzate sullo schermo. Per istruzioni sull'uso di Adobe Reader, consultare il menu **Guida in linea e supporto tecnico**.





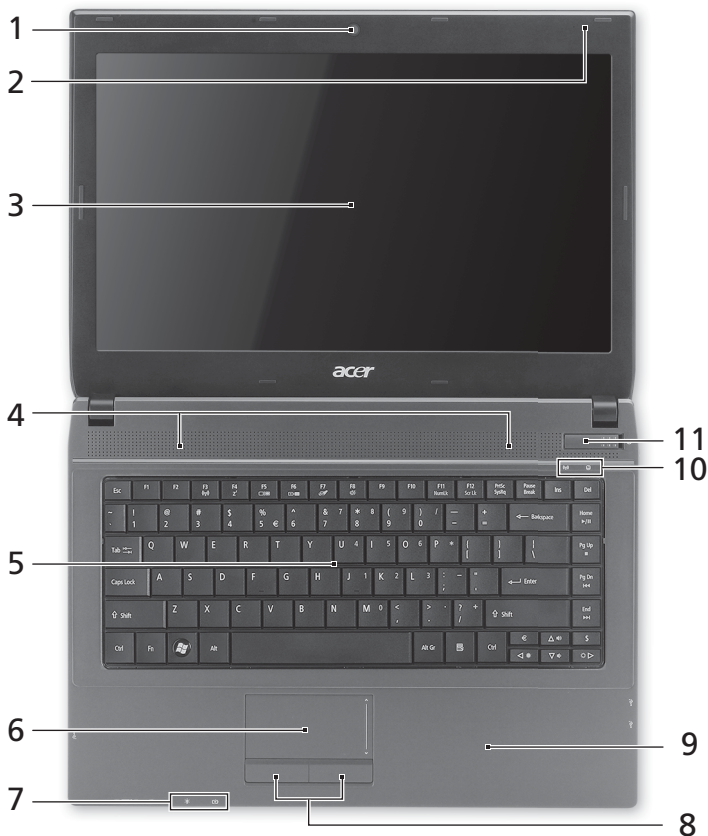

Presentazione del notebook Acer

Dopo aver configurato il computer come illustrato nel manifesto, far riferimento alla presente documentazione per la presentazione del nuovo notebook Acer.

Vista dall'alto



#	Icona	Elemento	Descrizione
1		Webcam Acer Crystal Eye	Web camera per la comunicazione video (solo per alcuni modelli).

#	Icona	Elemento	Descrizione
2		Microfono	Microfono interno per la registrazione di audio.
3		Display	Grande display a cristalli liquidi (Liquid-Crystal Display; LCD), per una visualizzazione confortevole (la configurazione può variare in relazione al modello).
4		Altoparlanti	Altoparlante sinistro e destro per la diffusione di audio in uscita.
5		Tastiera	Per l'immissione di dati sul computer.
6		Touchpad	Dispositivo di puntamento sensibile al tocco con funzioni simili a quelle di un comune mouse.
7		Indicatore di alimentazione ¹	Indicano lo stato di accensione/alimentazione del computer.
		Indicatore batteria ¹	Indicano lo stato della batteria del computer. 1. In carica: Luce di colore giallo quando la batteria è in ricarica. 2. Completamente carica: Luce di colore blu quando è nella modalità AC.
8		Tasti clic (sinistra e destra)	I tasti destra e sinistra hanno le stesse funzioni dei tasti destra e sinistra del mouse.
9		Poggiapolsi	Comoda area su cui poggiare i polsi durante l'utilizzo del computer.
10		Indicatore comunicazione	Indica lo stato della connettività wireless del computer.
		Indicatore disco rigido	Si accende quando l'hard disk è attivo.
11		Interruttore alimentazione	Accende/spenge il computer.

1. Gli indicatori del pannello frontale sono visibili anche quando il coperchio del computer è chiuso.













Nota: La configurazione esatta del PC dipende dal modello acquistato.

Tasti di scelta rapida

Il computer utilizza i tasti di scelta o le combinazioni di tasti per l'accesso a molti controlli del computer come luminosità dello schermo e uscita volume.

Per attivare i tasti di scelta rapida, tenere premuto **<Fn>** e premere l'altro tasto della combinazione.

Tasti di scelta rapida	Icona	Funzione	Descrizione
<Fn> + <F3>		Tasto comunicazioni	Attiva/disattiva i dispositivi di comunicazione del computer. (i dispositivi di comunicazione possono variare in relazione alla configurazione.)
<Fn> + <F4>		Sospensione	Attiva la modalità sospensione del computer.
<Fn> + <F5>		Passaggio da uno schermo all'altro	Consente la commutazione in uscita display tra video del display o monitor esterno (se collegato) e entrambi.
<Fn> + <F6>		Disattiva display	Disattiva la retroilluminazione dello schermo per risparmiare energia. Premere un tasto qualsiasi per tornare allo stato precedente.
<Fn> + <F7>		Attivazione e disattivazione del touchpad	Attiva e disattiva il touchpad interno.
<Fn> + <F8>		Attivazione e disattivazione degli altoparlanti	Attiva e disattiva gli altoparlanti.
<Fn> + <F11>	NumLk	NumLock	Attiva o disattiva il tastierino numerico integrato.
<Fn> + <F12>	Scr Lk	Scroll Lock	Quando Bloc Scorr è attivo, lo schermo si sposta di una riga verso l'alto o verso il basso, a seconda che venga premuta la freccia verso l'alto o verso il basso. Bloc Scorr non funziona con tutte le applicazioni.
<Fn> + <↑>		Aumento della luminosità	Consente di aumentare la luminosità dello schermo.
<Fn> + <↓>		Riduzione della luminosità	Riduce la luminosità dello schermo.
<Fn> + <→>		Aumento del volume	Aumenta il volume.
<Fn> + <←>		Riduzione del volume	Riduce il volume.

Tasti di scelta rapida	Icona	Funzione	Descrizione
<Fn> + <Home>	▶/	Play/Pausa	Riproduce o sospende la riproduzione del file multimediale selezionato.
<Fn> + <Pag su>	■	Interrompi	Interrompe la riproduzione del file multimediale selezionato.
<Fn> + <Pag giù>	◀◀	Precedente	Per passare al file multimediale precedente.
<Fn> + <Fine>	▶▶	Avanti	Per passare al file multimediale successivo.





Vista frontale in dettaglio

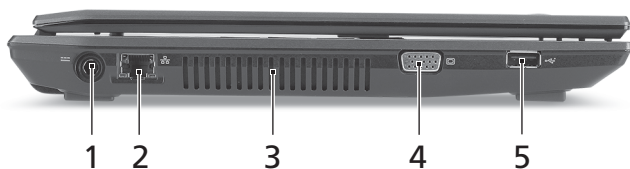

#	Icona	Elemento	Descrizione
1		Letto di schede multiplo	Supporta Secure Digital (SD), MultiMediaCard (MMC), Memory Stick (MS), Memory Stick Pro (MS PRO), e xD-Picture Card (xD). Nota: Premere per rimuovere/installare la scheda. È possibile utilizzare una sola scheda di memoria alla volta.





Vista da sinistra



#	Icona	Elemento	Descrizione
1		Jack CC-in	Per il collegamento all'adattatore CA.
2		Porta Ethernet (RJ-45)	Effettua il collegamento a una rete con Ethernet 10/100/1000.
3		Aperture per la ventilazione	Permettono il raffreddamento del computer, anche dopo un uso prolungato.
4		Porta display esterno (VGA)	Effettua il collegamento a un dispositivo di visualizzazione (ad es., monitor esterno, proiettore LCD).
5		Porta USB 2.0	Effettua il collegamento ai dispositivi USB 2.0 (ad es., mouse USB, fotocamera USB).





Vista da destra

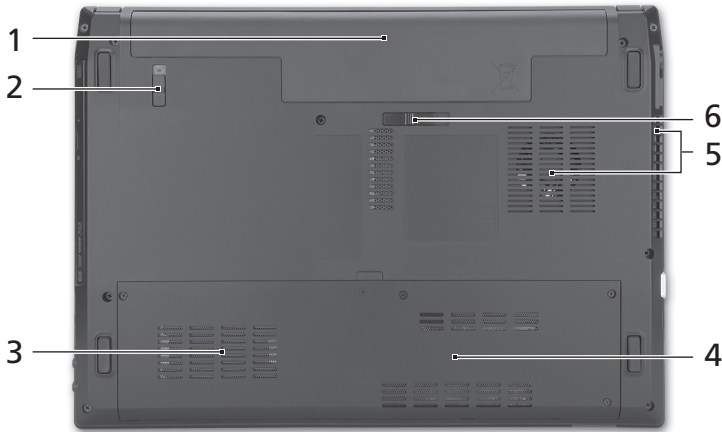

#	Icona	Elemento	Descrizione
1		Jack auricolari/ altoparlante/ line-out	Effettua il collegamento ai dispositivi audio line-out (ad es., altoparlanti, auricolari).
		Jack microfono	Accetta ingressi provenienti da microfoni esterni.
2		Porta USB 2.0	Effettua il collegamento ai dispositivi USB 2.0 (ad es., mouse USB, fotocamera USB).
3		Lettore ottico	Unità ottica interna, accetta CD o DVD.
4		Indicatore accesso disco ottico	Si accende quando il disco ottico è attivo.
5		Tasto di espulsione del disco ottico	Espelle il disco ottico dall'unità.
6		Foro di espulsione di emergenza	Espelle il vassoio del disco ottico se il computer è spento. Nota: Inserire la punta di un fermaglio nel foro di apertura di emergenza per espellere il vassoio dell'unità ottica quando il computer è spento.
7		Slot blocco Kensington	Per il collegamento al blocco di sicurezza dei computer Kensington-compatibili.

Vista base



#	Icona	Elemento	Descrizione
1		Alloggiamento della batteria	Contiene il pacco batteria del computer.
2		Blocco batteria	Blocca la batteria al suo posto.
3		Alloggiamento per il disco rigido	Contiene il disco rigido del computer (fissato con viti).
4		Vano per la memoria	Contiene la memoria principale del computer.
5		Aperture per la ventilazione e ventola di raffreddamento	Permettono il raffreddamento del computer, anche dopo un uso prolungato. Nota: Non coprire e non ostruire l'apertura della ventola.
6		Gancio di rilascio della batteria	Per togliere la batteria.

Condizioni operative

- Temperatura:
 - Di esercizio: da 5°C a 35°C
 - Non di esercizio: da -20°C a 65°C
- Umidità (senza condensa):
 - Di esercizio: da 20% a 80%
 - Non di esercizio: da 20% a 80%

Serie TravelMate 4740/ 4740Z/4340

Guía rápida

© 2010 Reservados todos los derechos.

Guía rápida de la Serie TravelMate 4740/4740Z/4340
Versión original: 03/2010

Ordenador portátil Serie TravelMate 4740/4740Z/4340

Número de modelo: _____

Número de serie: _____

Fecha de compra: _____

Lugar de compra: _____

Primero lo más importante

Le agradecemos que haya elegido el ordenador portátil de Acer para satisfacer sus necesidades de informática móvil.

Sus guías

Para ayudarle a utilizar el ordenador portátil Acer, hemos elaborado un conjunto de guías:

En primer lugar, el póster contiene información de ayuda para configurar su ordenador.

La **Guía de usuario genérica de la serie TravelMate** en formato impreso contiene información útil aplicable a todos los modelos de productos de la serie TravelMate. Contempla aspectos básicos como el uso del teclado y el audio, etc. No obstante, no se olvide que debido a su carácter, la **Guía genérica** además de la **Guía del usuario de AcerSystem** mencionada a continuación se referirá ocasionalmente a las funciones o características incluidas sólo en ciertos modelos de la serie, pero no necesariamente al modelo que haya adquirido usted. Dichos ejemplos se marcan en el texto del idioma como por ejemplo "sólo en determinados modelos".

La **Guía rápida** presenta las características y funciones básicas de su nuevo ordenador. Si desea más información sobre cómo puede su ordenador ayudarle a ser más productivo, consulte la **Guía del usuario de AcerSystem**. Esa guía contiene información detallada sobre temas como utilidades del sistema, recuperación de datos, opciones de expansión y resolución de problemas. Además, contiene información sobre garantías y las normativas generales y advertencias de seguridad para su ordenador portátil. Está disponible en PDF (Formato de Documento Portátil) y viene precargada en su ordenador portátil. Siga estos pasos para acceder al manual:

- 1 Haga clic en  **Inicio > Todos los programas > AcerSystem**.
- 2 Haga clic en **Guía del usuario de AcerSystem**.



.....

Nota: Para poder ver el archivo, debe tener instalado Adobe Reader. Si no lo tiene instalado, haga clic en **Guía del usuario de AcerSystem** para que se ejecute el programa de instalación de Adobe Reader. Siga las instrucciones en pantalla para completar la instalación. Para obtener información sobre cómo utilizar Adobe Reader, acceda al menú **Ayuda y soporte técnico**.





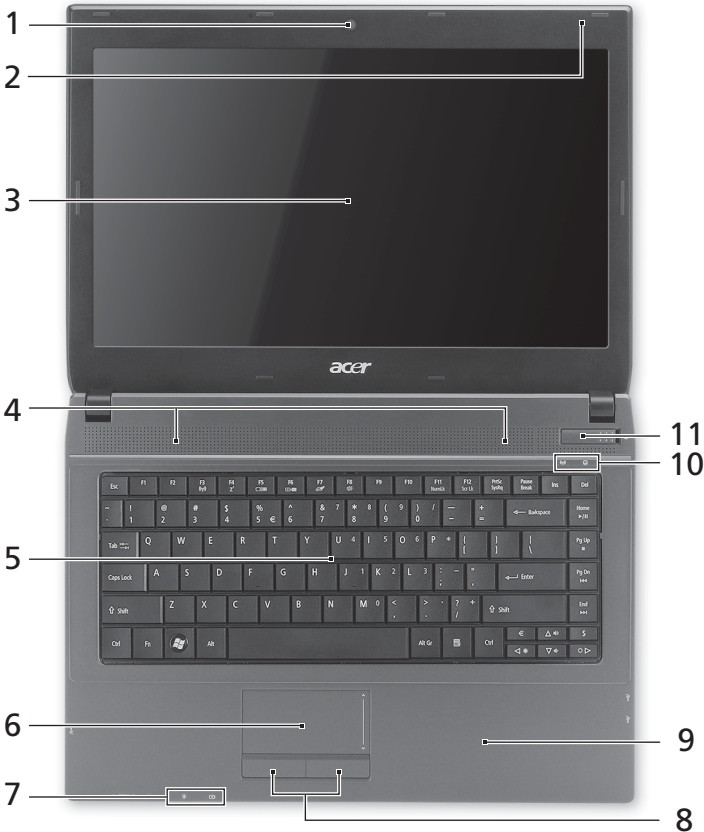

Un paseo por el ordenador portátil Acer

Una vez configurado el ordenador del modo indicado en el póster, iniciaremos un paseo por su nuevo portátil Acer.

Vista superior



#	Icono	Elemento	Descripción
1		Webcam Acer Crystal Eye	Cámara Web para comunicación de vídeo (sólo en ciertos modelos).

#	Icono	Elemento	Descripción
2		Micrófono	Micrófono interno para la grabación de sonido.
3		Visualización en pantalla	También denominada pantalla de cristal líquido (Liquid-Crystal Display; LCD) es el dispositivo de salida visual del ordenador (la configuración puede variar según el modelo).
4		Altavoces	Los altavoces izquierdo y derecho proporcionan una salida de audio.
5		Teclado	Para introducir datos en su ordenador.
6		Teclado táctil	Dispositivo apuntador táctil que funciona como un ratón de ordenador.
7		Indicador de encendido ¹	Proporciona información sobre el estado de energía del ordenador.
		Indicador de batería ¹	Proporciona información sobre el estado de la batería. 1. Carga: La luz se vuelve ámbar cuando se carga la batería. 2. Carga completa: La luz se vuelve azul en modo de CA.
8		Botones de clic (izquierdo y derecho)	Los botones izquierdo y derecho funcionan como los botones izquierdo y derecho del ratón.
9		Soporte para las palmas	Área de soporte que permite reposar cómodamente las palmas de las manos cuando se utiliza el ordenador.
10		Indicador de comunicación	Proporciona información sobre el estado del dispositivo de conectividad inalámbrica.
		Indicador de disco duro	Indica si la unidad de disco duro está activa.
11		Interruptor de encendido	Enciende o apaga el ordenador.

1. Los indicadores del panel frontal son visibles aunque se cierre la tapa del ordenador.



Nota: La configuración exacta de su PC depende del modelo adquirido.

Teclas de acceso directo

El ordenador utiliza teclas de acceso directo o combinaciones de teclas para acceder a la mayoría de controles del ordenador como el brillo de la pantalla o la salida de volumen.

Para activar las teclas de acceso directo, mantenga pulsada la tecla **<Fn>** y pulse la siguiente tecla de la combinación.

Tecla de acceso directo	Icono	Función	Descripción
<Fn> + <F3>		Tecla de comunicación	Activa/desactiva los dispositivos de comunicación del ordenador. (Los dispositivos de comunicación pueden variar según la configuración.)
<Fn> + <F4>		Suspensión	Pone el ordenador en modo de suspensión.
<Fn> + <F5>		Selector de pantalla	Cambia la salida entre la pantalla y el monitor externo (si está conectado) o ambos.
<Fn> + <F6>		Apagado de pantalla	Apaga la luz de fondo de la pantalla para ahorrar energía. Pulse cualquier tecla para encenderla.
<Fn> + <F7>		Panel táctil	Activa o desactiva el panel táctil interno.
<Fn> + <F8>		Alternar altavoces	Activa o desactiva los altavoces.
<Fn> + <F11>	Bloq Núm	Bloq Núm	Activa o desactiva el teclado numérico integrado.
<Fn> + <F12>	Bloq Despl	Bloquea el desplazamiento	Si se activa esta tecla, la pantalla se mueve una línea hacia arriba o hacia abajo al pulsar las teclas de dirección arriba y abajo. Esta función no funciona con algunas aplicaciones.
<Fn> + <▷>		Aumentar brillo	Aumenta el brillo de la pantalla.
<Fn> + <◁>		Disminuir brillo	Disminuye el brillo de la pantalla.
<Fn> + <△>		Subir volumen	Sube el volumen.
<Fn> + <▽>		Bajar volumen	Baja el volumen.
<Fn> + <Inicio>		Reproducir/Pausa	Reproduce o hace una pausa en un archivo multimedia seleccionado.
<Fn> + <Re Pág>		Detener	Detiene la reproducción del archivo multimedia seleccionado.
<Fn> + <Av Pág>		Anterior	Regresa al archivo multimedia anterior.
<Fn> + <Fin>		Siguiente	Salta al siguiente archivo multimedia.





Vista frontal cerrada

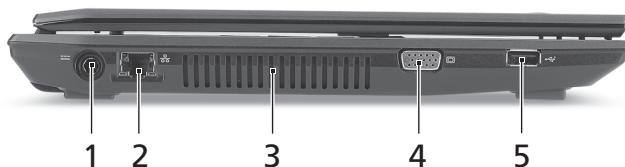

#	Icono	Elemento	Descripción
1		Lector de tarjetas multifunción	Admite la tarjeta Secure Digital (SD), MultiMedia (MMC), Memory Stick (MS), Memory Stick PRO (MS PRO), xD-Picture (xD). Nota: Presionar para extraer/installar la tarjeta. Sólo puede funcionar una tarjeta en un momento dado.

Vista izquierda



#	Icono	Elemento	Descripción
1		Conector de entrada de DC	Permite conectar a un adaptador de CA.
2		Puerto Ethernet (RJ-45)	Conexión para una red basada en Ethernet 10/100/1000.
3		Ranuras de ventilación	Permite que el ordenador esté frío, incluso tras un uso prolongado.
4		Puerto de visualización externo (VGA)	Conexión para pantallas (p. ej., monitor externo, proyector de LCD).
5		Puerto USB 2.0	Conexión para dispositivos USB 2.0 (por ejemplo: ratón USB, cámara USB).

Vista derecha

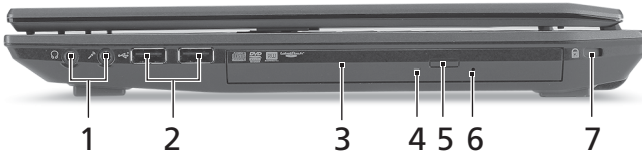

#	Icono	Elemento	Descripción
1		Auriculares/ altavoz/conector de línea de salida	Conexión para dispositivos de salida de audio (p.ej., altavoces, auriculares).
		Conector del micrófono	Permite la entrada de audio de micrófonos externos.
2		Puerto USB 2.0	Conexión para dispositivos USB 2.0 (por ejemplo: ratón USB, cámara USB).
3		Unidad óptica	Dispositivo óptico interno; acepta CD y DVD.
4		Indicador de acceso del disco óptico	Se enciende cuando la unidad óptica está activa.
5		Botón de expulsión de la unidad óptica	Expulsa el disco óptico de la unidad.
6		Orificio de expulsión de emergencia	Expulsa la bandeja de la unidad óptica cuando el ordenador está apagado. Nota: Introduzca un clip sujetapapeles en el orificio de expulsión para expulsar la bandeja de la unidad óptica cuando el ordenador esté apagado.
7		Ranura de bloqueo Kensington	Permite conectar a un candado de seguridad para ordenador compatible con Kensington.

Vista de la base



#	Icono	Elemento	Descripción
1		Compartimento de la batería	Aloja la batería del ordenador.
2		Bloqueo de la batería	Permite que la batería quede trabada.
3		Compartimento del disco duro	Contiene el disco duro del ordenador (fijado con tornillos).
4		Compartimento de memoria	Contiene la memoria principal de ordenador.
5		Ranuras de ventilación y ventilador de refrigeración	Permite que el ordenador esté frío, incluso tras un uso prolongado. Nota: No tape ni obstruya la apertura del ventilador.
6		Pestillo de liberación de la batería	Libera la batería para poder sacarla.

Medio ambiente

- Temperatura:
 - Encendido: entre 5°C y 35°C
 - Apagado: entre -20°C y 65°C
- Humedad (sin condensación):
 - Encendido: entre 20% y 80%
 - Apagado: entre 20% y 80%

Notificacion Regulatoria Adicional

[Argentina]

El portatil Acer viene con los modulos de telecomunicaciones aprobados ya incorporados para su conexion a la red. El numero de modelo y numero de homologacion especifico para estos modelos se refieren a continuacion.

[Modem]

Modelo: RD02-D330	CNC 54-4512
Modelo: Delphi_D40	CNC 53-4581
Modelo: Delphi_D40 (AM5)	CNC 54-5681

[Bluetooth]

Modelo: BCM92045NMD	CNC 16-4062
---------------------	-------------

[802.11AGN]

Modelo: 4965AGN	CNC C-5421
Modelo: BCM94321MC	CNC C-5225
Modelo: 512AN_MMW	CNC C-6399
Modelo: 533AN_MMW	CNC C-6385

[802.11ABG]

Modelo: 4965AG_	CNC C-5424
Modelo: WM3945ABG	CNC C-4531
Modelo: AR5BXB6	CNC C-4340





[802.11BG]

Modelo: BCM94311MCG	CNC C-4250
Modelo: AR5BXB63	CNC C-5448
Modelo: BCM94312MCG	CNC C-5871



[Brasil] Noticia adicional de regulamento Anatel

Os componentes de telecomunicacao usados nos notebooks Acer em Portugues sao homologados atendendo a requisicao da Agencia Nacional de Telecomunicacoes Anatel, conforme referencia abaixo:

[Modem]

Modelo: RD02-D330	 1406-05-1675	 <small>01107898349890382</small>
Modelo: Delphi_D40	 0455-06-2565	 <small>(01) 0789 834989 0382</small>



[Bluetooth]

Modelo: BCM92045NMD	 0578-05-1869	 <small>0107898349891648</small>
------------------------	---	--

[802.11AGN]

Modelo: 4965AGN	 ANATEL 0578-07-2198	 (01)0789 8355950322
Modelo: BCM94321MC	 ANATEL 1761-06-1869	 0107898349891846
Modelo: 512AN_MMW	 ANATEL 0807-08-2198	 (01) 078983355950018
Modelo: 512AN_HMW	 ANATEL 0800-08-2198	 (01) 078983355950025
Modelo: 533AN_MMW	 ANATEL 0809-08-2198	 (01) 078983355950032
Modelo: 533AN_HMW	 ANATEL 0812-08-2198	 (01) 078983355950049







[802.11BGN]

Modelo: AR5B91	 ANATEL 1182-08-3987	 7898915959 50 5
-------------------	---	--

[802.11ABG]

Modelo: 4965AG_	 ANATEL 0350-07-2198	 (01)07898355950339
Modelo: WM3945ABG	 ANATEL 0151-06-2198	 01078983355950063
Modelo: AR5BxB6	 ANATEL 1188-05-2634	 0107898914152020

[802.11BG]

Modelo: BCM94311MCG	 ANATEL 0979-05-1869	 0107898349891747
Modelo: AR5BxB63	 ANATEL 1188-05-2634	 0107898915959123
Modelo: BCM94312MCG	 ANATEL 1558-07-1869	 (01)07898349892140

Série TravelMate 4740/ 4740Z/4340

Guia rápido

© 2010 Todos os Direitos Reservados.

Guia rápido da Série TravelMate 4740/4740Z/4340

Edição Original: 03/2010

Computador Portátil Série TravelMate 4740/4740Z/4340

Número de Modelo: _____

Número de Série: _____

Data de Compra: _____

Local de Aquisição: _____

Primeiro que tudo

Gostaríamos de lhe agradecer por ter escolhido um computador portátil Acer para preencher as suas necessidades de computador móvel.

Os seus manuais

Para o ajudar a usar o seu computador portátil Acer, preparámos uma série de manuais:

Antes de mais, o cartaz ajuda-o a iniciar e a configurar o seu computador.

O **Manual Genérico do utilizador da Série TravelMate** contém informações úteis que se aplicam a todos os modelos da série de produtos TravelMate. Abrange tópicos básicos como a utilização do teclado, áudio, etc. Pedimos a sua compreensão para o facto de, pela sua natureza, o **Manual Genérico** e o **Manual do Utilizador do AcerSystem** abaixo mencionados referem-se ocasionalmente a funções ou funcionalidades apenas aplicáveis a determinados modelos da série, mas não necessariamente ao modelo específico que adquiriu. Tais situações estão assinaladas no texto com expressões como "apenas em certos modelos".

O **Guia rápido** apresenta as características e funções básicas do seu novo computador. Para mais detalhes sobre como o seu computador o pode ajudar a ser mais produtivo, consulte o **AcerSystem User Guide**. Esse manual contém informações pormenorizadas sobre temas como utilitários do sistema, recuperação de dados, opções de expansão e solução de problemas. Além disso, contém a informação da garantia e as regulamentações gerais e notas de segurança para o seu computador portátil. Está disponível no formato PDF (Portable Document Format) e vem já instalado no seu computador. Siga estes passos para a ele aceder:

- 1 Clique em  **Iniciar > Todos os programas > AcerSystem**.
- 2 Clique em **AcerSystem User Guide**.



Nota: é necessário instalar o Adobe Reader para visualizar o ficheiro. Se o Adobe Reader não estiver instalado no seu computador, ao clicar em **AcerSystem User Guide** (Manual do Utilizador AcerSystem) é executado o programa de instalação do Acrobat Reader. Siga as instruções do ecrã para finalizar a instalação. Para obter instruções sobre como utilizar o Adobe Reader, vá ao menu **Ajuda e Suporte**





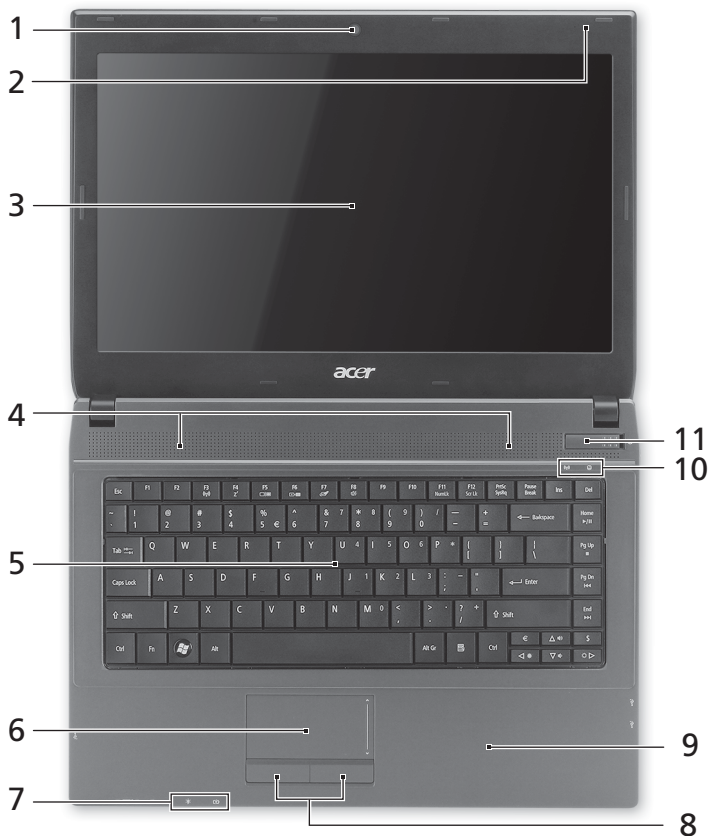

Visita guiada ao seu computador portátil Acer

Após montar o computador tal como indicado na ilustração do cartaz, deixe-nos mostrar-lhe o seu novo computador portátil Acer.

Vista de cima



#	Ícone	Item	Descrição
1		Webcam Acer Crystal Eye	Webcam para comunicação por vídeo (apenas para determinados modelos).

#	Ícone	Item	Descrição
2		Microfone	Microfone interno para gravação de som.
3		Ecrã	Também chamado ecrã de cristais líquidos (LCD), permite visualizar a informação do computador (a configuração pode variar consoante o modelo).
4		Altifalantes	Os altifalantes esquerdo e direito permitem saída de áudio estéreo.
5		Teclado	Para introduzir informações no seu computador.
6		Teclado táctil	Dispositivo apontador sensível ao toque, que funciona como um rato de computador.
7		Indicador de alimentação ¹	Indica o estado da alimentação do computador.
		Indicador de bateria ¹	Indica o estado da bateria do computador. 1. A carregar: A luz é âmbar quando a bateria está a carregar. 2. Carga completa: A luz é azul no modo CA.
8		Botões de clique (esquerdo e direito)	Os botões esquerdo e direito funcionam como os botões esquerdo e direito de um rato.
9		Descanso de mãos	Área confortável de apoio para as suas mãos enquanto utiliza o computador.
10		Indicador de comunicação	Indica o estado do dispositivo de ligação sem fios do computador.
		Indicador HDD	Indica quando o disco rígido está activo.
11		Interruptor de energia	Liga e desliga o computador.

1. Os indicadores no painel dianteiro são visíveis mesmo com a tampa do monitor fechada.

















.....

Nota: A configuração exacta do seu PC depende do modelo adquirido.

Teclas de atalho

O computador utiliza teclas de atalho ou combinações de teclas para aceder à maior parte dos seus comandos, tais como a luminosidade do ecrã e o volume de saída.

Para activar as teclas de atalho, prima e mantenha premeida a tecla **<Fn>** antes de premir a outra tecla na combinação de teclas de atalho.

Tecla de atalho	Ícone	Função	Descrição
<Fn> + <F3>		Tecla de comunicações	Activa / desactiva os dispositivos de comunicação do computador. (Os dispositivos de comunicação podem variar consoante a configuração.)
<Fn> + <F4>		Suspensão	Coloca o computador no modo de Suspensão.
<Fn> + <F5>		Comutação de visualização	Alterna a saída entre o ecrã de visualização, o monitor externo (se está ligado) e ambos.
<Fn> + <F6>		Ecrã desligado	Desliga a luz de fundo do ecrã de visualização para economizar energia. Prima qualquer tecla para retomar a actividade.
<Fn> + <F7>		Comutação de touchpad (teclado táctil)	Liga e desliga o teclado táctil interno.
<Fn> + <F8>		Comutação de altifalante	Liga e desliga os altifalantes.
<Fn> + <F11>	NumLk	NumLock	Liga ou desliga o teclado numérico integrado.
<Fn> + <F12>	Scr Lk	Scroll Lock	Quando Scr Lk está activo, o conteúdo do ecrã sobe e desce uma linha de cada vez, conforme as teclas direccionais (setas) forem premidas. A função Scr Lk não funciona com algumas aplicações.
<Fn> + <D>		Aumentar luminosidade	Aumenta a luminosidade do ecrã.
<Fn> + <D>		Reduzir luminosidade	Reduz a luminosidade do ecrã.
<Fn> + <Δ>		Aumentar volume	Aumenta o volume de som.
<Fn> + <▽>		Diminuir volume	Diminui o volume de som.
<Fn> + <Home>		Reproduzir/Pausa	Reproduz ou pausa um ficheiro multimédia seleccionado.
<Fn> + <Pg Up>		Parar	Para a reprodução do ficheiro multimédia seleccionado.
<Fn> + <Pg Dn>		Anterior	Retorna ao ficheiro multimédia anterior.
<Fn> + <End>		Seguinte	Avança até ao ficheiro multimédia seguinte.





Vista frontal, fechado

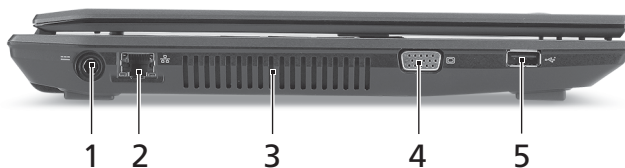

#	Ícone	Item	Descrição
1		Leitor de cartões vários-em-um	Aceita cartões Secure Digital (SD), MultiMediaCard (MMC), Memory Stick (MS), Memory Stick PRO (MS PRO), xD-Picture Card (xD). Nota: Empurre para remover/instalar o cartão. Apenas pode ser utilizado um cartão de cada vez.

Vista esquerda



#	Ícone	Item	Descrição
1		Tomada de entrada CC	Liga a um adaptador CA.
2		Entrada Ethernet (RJ-45)	Liga a uma rede Ethernet de base 10/100/1000.
3		Ranuras de ventilação	Permite ao computador manter-se fresco, mesmo após uso prolongado.
4		Ligação a ecrã externo (VGA)	Liga a um dispositivo de imagem (por ex., monitor externo, projector LCD).
5		Entrada USB 2.0	Liga a dispositivos USB 2.0 (por exemplo, rato USB, câmara USB).





Vista direita

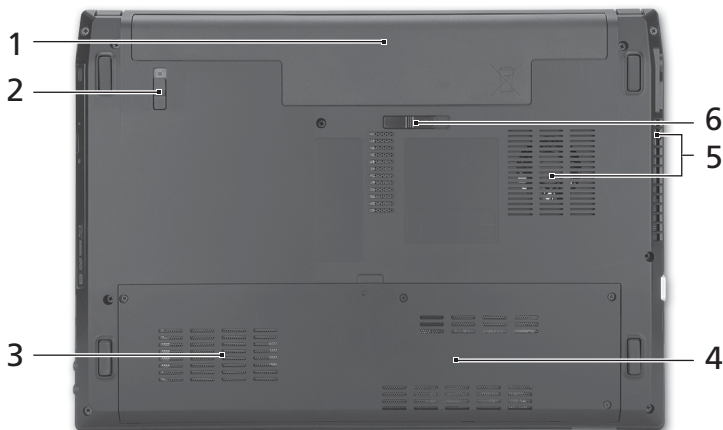

#	Ícone	Item	Descrição
1		Tomada de auscultadores/altifalante/saída	Liga a dispositivos de saída de áudio (por exemplo, altifalantes, auscultadores).
		Tomada para microfone	Aceita entradas de microfones externos.
2		Entrada USB 2.0	Liga a dispositivos USB 2.0 (por exemplo, rato USB, câmara USB).
3		Unidade óptica	Unidade óptica interna; aceita CD ou DVD.
4		Indicador de acesso do disco óptico	Acende quando a unidade óptica está activa.
5		Botão de ejeção da unidade óptica	Ejecta o disco óptico da unidade.
6		Furo de ejeção de emergência	Ejecta o tabuleiro da unidade óptica quando o computador está desligado. Nota: Introduza um clipe no orifício de ejeção de emergência, para a unidade óptica ejectar o tabuleiro quando desligado o computador.
7		Ranhura de bloqueio Kensington	Liga a um cadeado de segurança Kensington (ou compatível).

Visão da base



#	Ícone	Item	Descrição
1		Baía da bateria	Contém a bateria do computador.
2		Bloqueio da bateria	Bloqueia a bateria, mantendo-a no sítio.
3		Compartimento do disco rígido	Aloja o disco rígido do computador (seguro por parafusos).
4		Compartimento da memória	Aloja a memória principal do computador.
5		Ranhuras de ventilação e ventoinha de arrefecimento	Permite ao computador manter-se fresco, mesmo após uso prolongado. Nota: Não tape nem obstrua a abertura da ventoinha.
6		Patilha de libertação da bateria	Liberta a bateria para remoção.

Ambiente

- Temperatura:
 - Funcionamento: 5°C a 35°C
 - Não em funcionamento: -20°C a 65°C
- Humidade (não condensação):
 - Funcionamento: 20% a 80%
 - Não em funcionamento: 20% a 80%

TravelMate 4740/4740Z/4340 Serie

Snelgids

© 2010 Alle rechten voorbehouden.

Snelgids voor de TravelMate 4740/4740Z/4340 Serie
Oorspronkelijke uitgave: 03/2010

TravelMate 4740/4740Z/4340 Serie Notebook PC

Modelnummer: _____

Serienummer: _____

Aankoopdatum: _____

Plaats van aankoop: _____

Om te beginnen

Bedankt dat u hebt gekozen voor een notebook van Acer als oplossing voor uw mobiele computereisen.

Uw gidsen

Om u te helpen met het werken op het Acer notebook hebben we een aantal gidsen ontworpen:

Allereerst helpt de kaart u bij het instellen van uw computer.

De gedrukte **Algemene gebruikershandleiding van de TravelMate Serie** bevat handige informatie die van toepassing zijn op alle modellen uit de TravelMate productreeks. De handleiding behandelt basale onderwerpen, zoals de Empowering Technology van Acer, het gebruik van het toetsenbord, geluid, enz. Vandaar dat zowel de **Algemene handleiding** als de hieronder genoemde **AcerSystem gebruikershandleiding** af en toe naar functies of kenmerken verwijzen die slechts voor enkele modellen in de reeks gelden, en dus niet noodzakelijk voor het model dat u heeft aangeschaft. Dit wordt in de tekst aangegeven met opmerkingen in de trand van "alleen voor bepaalde modellen".

In de **Snelgids** krijgt u een introductie over de basiseigenschappen en functies van uw nieuwe computer. Als u meer wilt weten over hoe uw computer u kan helpen productiever te werken, raadpleeg dan de **AcerSystem Gebruikershandleiding**. Deze Gebruikershandleiding bevat gedetailleerde informatie over onderwerpen zoals systeemfuncties, gegevensherstel, uitbreidingsopties en probleem oplossen. Daarnaast bevat het informatie over garantie en de algemene voorwaarden en veiligheid voor uw notebook. Het is als Portable Document Format (PDF) beschikbaar en is al van te voren op uw notebook gezet. Volg deze stappen voor toegang tot dit document:

- 1 Klik op  **Start > Alle programma's > AcerSystem**.
- 2 Klik vervolgens op **AcerSystem Gebruikershandleiding**.



.....

Opmerking: Als u het bestand wilt inzien, dient Adobe Reader te zijn geïnstalleerd. Als Adobe Reader nog niet op uw computer is geïnstalleerd, wordt, als u op **AcerSystem Gebruikershandleiding** klikt, eerst het installatieprogramma van Adobe Reader gestart. Volg de instructies op het scherm om het programma te installeren. Gebruiksaanwijzingen bij Adobe Reader vindt u in het menu **Help en Ondersteuning**.





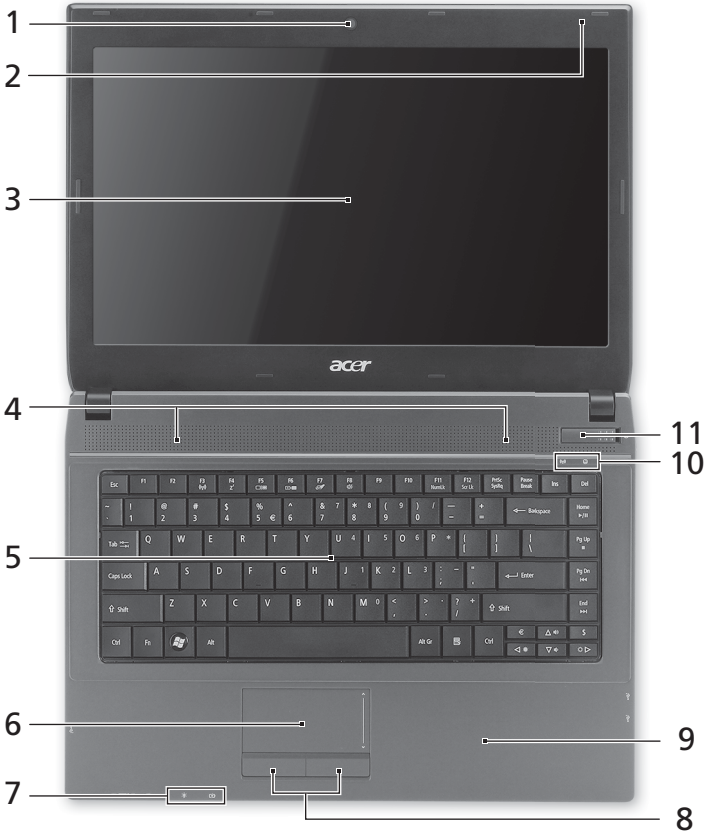

Rondleiding door uw Acer notebook

Nadat u de computer hebt ingesteld zoals is beschreven op de poster, bent u nu klaar voor een rondleiding door de nieuwe Acer notebook.

Bovenkant



#	Pictogram	Item	Beschrijving
1		Acer Crystal Eye webcam	Webcam voor videocommunicatie (alleen voor bepaalde modellen).

#	Pictogram	Item	Beschrijving
2		Microfoon	Interne microfoon voor geluidsopname.
3		Beeldscherm	Ook wel Liquid-Crystal Display (LCD) genoemd, geeft de output van de computer weer (configuratie kan per model verschillen).
4		Luidsprekers	De luidsprekers links en rechts zorgen voor stereogeluid.
5		Toetsenbord	Om gegevens in te voeren in de computer.
6		Touchpad	Tastgevoelig aanwijsapparaat dat functioneert als een computermuis.
7		Stroomindicator ¹	Geeft de vermogenstatus van de computer aan.
		Accu-indicator ¹	Geeft de batterijstatus van de computer aan. 1. Opladen: Het licht is oranje wanneer de accu wordt opgeladen. 2. Volledig opgeladen: Het licht is blauw in de AC-modus.
8		Kliktoetsen (links en rechts)	De toetsen links en rechts functioneren als de linker en rechter muistoetsen.
9		Polssteun	Comfortabele ondersteuning voor uw handen wanneer u de computer gebruikt.
10		Communicatie-indicator	Geeft de status van het draadloze communicatieapparaat van de computer aan.
		HDD-indicator	Licht op wanneer de harde schijf actief is.
11		Aan/uit-toets	Schakelt de computer aan en uit.

1. De statusindicatoren aan de voorkant zijn zelfs zichtbaar als het scherm gesloten is.













.....
Opmerking: De exacte configuratie van de pc is afhankelijk van het aangeschafte model.

Sneltoetsen

De computer gebruikt sneltoetsen of toetscombinaties voor toegang tot de meeste besturingselementen, zoals helderheid en geluidsvolume.

Om een sneltoets te gebruiken drukt u de <Fn> -toets in voordat u de andere toets van de combinatie indrukt.

Sneltoets	Pictogram	Functie	Beschrijving
<Fn> + <F3>		Communicati-etoets	Schakelt de communicatie-apparaten van de computer in/uit. (Beschikbare communicatie-apparaten kunnen per configuratie verschillen.)
<Fn> + <F4>		Standby	Hiermee plaatst u de computer in de Standby-stand.
<Fn> + <F5>		Schakeltoets voor beeldscherm	Schakelt de weergave-uitvoer tussen het scherm, externe monitor (indien aangesloten) en beide.
<Fn> + <F6>		Beeldscherm uit	Hiermee schakelt u de lamp van het beeldscherm uit om stroom te besparen. Druk op een willekeurige toets om het beeldscherm weer te activeren.
<Fn> + <F7>		Schakeltoets voor touchpad	Hiermee schakelt u het interne touchpad in en uit.
<Fn> + <F8>		Schakeltoets voor luidspreker	Hiermee schakelt u de luidsprekers in en uit.
<Fn> + <F11>	NumLk	NumLock	Schakelt het geïntegreerde numerieke toetsenblok in of uit.
<Fn> + <F12>	Scr Lk	Scroll Lock.	Als Scroll Lock is ingeschakeld, schuift het scherm één regel omhoog of omlaag als u de toets pijl-omhoog of pijl-omlaag indrukt. Scroll Lock werkt niet in alle toepassingen.
<Fn> + <Δ>		Helderheid verhogen	Verhoogt de helderheid van het beeldscherm.
<Fn> + <◀Δ>		Helderheid verlagen	Hiermee verlaagt u de helderheid van het beeldscherm.
<Fn> + <Δ>		Volume omhoog	Hiermee verhoogt u het luidsprekervolume.
<Fn> + <◀Δ>		Volume omlaag	Hiermee verlaagt u het luidsprekervolume.

Sneltoets	Pictogram	Functie	Beschrijving
<Fn> + <Home>	▶/	Afspelen/Pauze	Een geselecteerd mediabestand afspelen of pauzeren.
<Fn> + <Pg Up>	■	Stoppen	Het afspelen stoppen van het geselecteerde mediabestand.
<Fn> + <Pg Dn>	◀◀	Vorige	Terugkeren naar het vorige mediabestand.
<Fn> + <End>	▶▶	Volgende	Naar het volgende mediabestand springen.





Voorkant gesloten

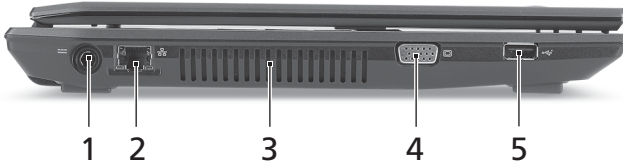

#	Pictogram	Item	Beschrijving
1		Meer-in-één-kaartlezer	<p>Accepteert Secure Digital (SD), MultiMediaCard (MMC), Memory Stick (MS), Memory Stick PRO (MS PRO) en xD-Picture Card (xD).</p> <p>Opmerking: Duwen om de kaart te verwijderen/plaatsen. Slechts één kaart tegelijk mag gebruikt worden.</p>





Linkerkant



#	Pictogram	Item	Beschrijving
1		Gelijk-stroomaansluiting	Aansluiting voor een adapter.
2		Ethernetpoort (RJ-45)	Aansluiting voor een op Ethernet 10/100/1000-gebaseerd netwerk.
3		Ventilatie-sleuven	Zorgen dat de computer koel blijft, zelfs na langdurig gebruik.
4		Externe weergavepoort (VGA)	Aansluiting voor een beeldscherm (bijv. een externe monitor, lcd-projector).
5		Usb 2.0-poort	Aansluiting voor usb 2.0-apparaten (bijv. USB-muis, USB-camera).





Rechterkant

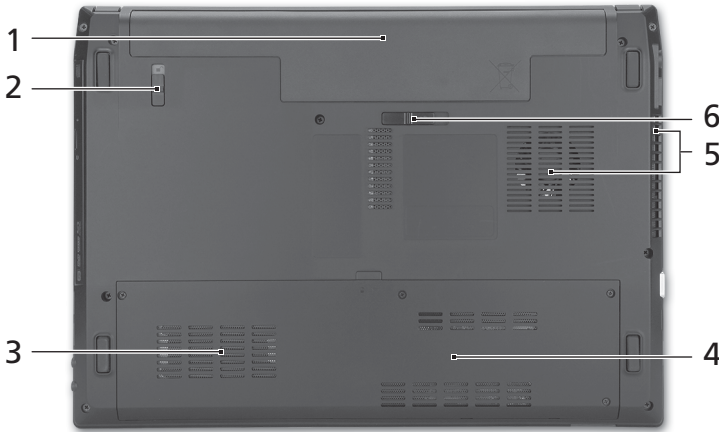

#	Pictogram	Item	Beschrijving
1		Aansluiting voor hoofdtelefoon/luidspreker/lijn-uit	Aansluiting voor lijn-uit audioapparaten (bijv. luidsprekers, hoofdtelefoon).
		Microfoonaansluiting	Aansluitingen voor externe microfoon.
2		Usb 2.0-poort	Aansluiting voor usb 2.0-apparaten (bijv. USB-muis, USB-camera).
3		Optisch station	Intern optisch station; accepteert CDs of DVDs.
4		Toegangsindicator optische schijf	Brandt wanneer het optisch station actief is.
5		Uitwerpknop optisch station	Werpt de optische schijf uit het station.
6		Nood-uitwerpopening	Opent de lade van het optisch station wanneer de computer is uitgeschakeld. Opmerking: Steek een paperclip in de nooduitwerpopening om de lade van het optisch station uit te werpen als de computer is uitgeschakeld.
7		Sleuf voor Kensington-slot	Aansluiting voor een Kensington-compatibel computerbeveiligingslot.

Onderkant



#	Pictogram	Item	Beschrijving
1		Batterijnis	Bevat de batterij van de computer.
2		Batterijgrendel	Vergrendelt de accu op z'n plaats.
3		Harde schijf nis	Bevat de harde schijf van de computer (vastgeschroefd).
4		Geheugenvak	Bevat het hoofdgeheugen van de computer.
5		Ventilatiesleuven en koelventilator	Zorgen dat de computer koel blijft, zelfs na langdurig gebruik. Opmerking: Dek de opening van de ventilator nooit af.
6		Batterijvergrendeling	Maakt de batterij los.

Omgeving

- **Temperatuur:**
 - In gebruik: 5°C tot 35°C
 - Niet in gebruik: -20°C tot 65°C
- **Vochtigheidsgraad (geen condensvorming):**
 - In gebruik: 20% tot 80%
 - Niet in gebruik: 20% tot 80%

TravelMate 4740/4740Z/4340- serien

Hurtigguide

© 2010 Med enerett.

Hurtigguide for TravelMate 4740/4740Z/4340-serien
Opprinnelig utgave: 03/2010

Notebook-PC i TravelMate 4740/4740Z/4340-serien

Modellnummer: _____

Serienummer: _____

Innkjøpsdato: _____

Innkjøpssted: _____

Begynne med begynnelsen

Vi vil gjerne takke deg for at du har valgt en Acer-notebook til dine mobile databehandlingsbehov.

Dine veiledere

Som hjelp til bruk av Acer-notebooken har vi utformet et sett av veiledere:

Til å begynne med vil plakaten hjelpe deg i gang med oppsettet av datamaskinen.

Den trykte **generiske håndboken for TravelMate-serien** inneholder nyttig informasjon om alle modeller i TravelMate-produktserien. Den dekker grunnleggende emner som bruk av tastatur og lyd, osv. Vennligst merk at både den **generiske håndboken** og **AcerSystem User's Guide** som er nevnt nedenfor, fra tid til annen vil referere til funksjoner eller egenskaper som bare finnes på visse modeller, men ikke nødvendigvis på modellen du kjøpte. Slike forekomster er markert i teksten med språk som "bare for visse modeller".

I **Hurtigguide** får du en innføring i de grunnleggende egenskapene og funksjonene til den nye datamaskinen. Hvis du vil vite mer om hvordan datamaskinen kan gjøre deg mer produktiv, kan du slå opp i **AcerSystem User's Guide**. Denne håndboken inneholder detaljert informasjon om emner som systemverktøy, datagjenvinning, utvidelsesalternativer og feilsøking/problemløsning. I tillegg finner du garantiopplysninger, generell informasjon og sikkerhetsmerknader for notisbokmaskinen din. Boken er tilgjengelig som PDF-fil (Portable Document Format) og leveres forhåndslastet på maskinen. Følg disse trinnene for å åpne den:

- 1 Klikk på  **Start > Alle Programmer > AcerSystem**.
- 2 Klikk på **AcerSystem User's Guide**.



.....

Merk: Visning av filen krever at du har Adobe Reader installert. Hvis Adobe Reader ikke er installert på datamaskinen din, vil klikking på **AcerSystem User's Guide** føre til at installeringsprogrammet for Adobe Reader kjøres i stedet. Følg instruksjonene på skjermen for å fullføre installeringen. Hvis du vil vite hvordan du bruker Adobe Reader, åpner du menyen **Hjelp og Støtte**.





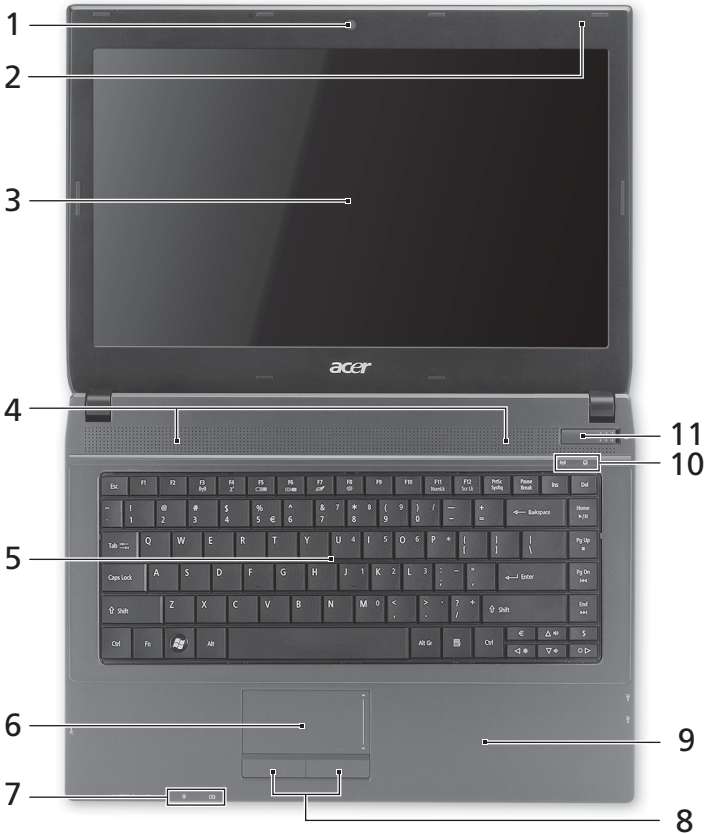

En omvisning i Acer-notebooken

Når du har satt opp datamaskinen som vist på plakaten, la oss ta en omvisning i din nye Acer-notisbokmaskin.

Visning ovenfra



#	Ikon	Element	Beskrivelse
1		Acer Crystal Eye-webkamera	Webkamera til videokommunikasjon (bare for visse modeller).

#	Ikone	Element	Beskrivelse
2		Mikrofon	Intern mikrofon for lydinnspilling.
3		Skjerm	Kalles også LCD-skjerm (Liquid-Crystal Display; LCD), viser utdata fra datamaskinen (Konfigurasjonen kan variere mellom modellene).
4		Høytalere	Venstre og høyre høyttaler leverer stereolyd.
5		Tastatur	Legger inn data i datamaskinen.
6		Pekeplate	Pekeenhet som reagerer på berøring og fungerer som en mus.
7		Strømindikator ¹	Angir datamaskinens strømstatus.
		Batteriindikator ¹	Angir datamaskinens batteristatus. 1. Lading: Lampen lyser gult når batteriet lades. 2. Helt oppladet: Lampen viser blått i nettstrømmodus.
8		Klikkeknapper (venstre og høyre)	Venstre og høyre knapp fungerer på samme måte som venstre og høyre museknapp.
9		Håndleddshviler	Komfortabelt støtteområde for hendene når du bruker datamaskinen.
10		Kommunikasjonsindikator	Angir datamaskinens status for trådløs tilkobling.
		Harddiskindikator	Lyser når harddisken er aktiv.
11		Strømbryter	Slår datamaskinen av og på.

1. Frontpanelindikatorene er synlige selv når skjermen er lukket.

















Merk: PCens eksakte konfigurasjon avhenger av den kjøpte modellen.

Hurtigtaster

Datamaskinen bruker hurtigtaster eller tastekombinasjoner for å få tilgang til datamaskinens kontroller, for eksempel skjermens lysstyrke og volumutgang.

Når du skal aktivere hurtigtaster, trykker du på og holder <Fn>-tasten før du trykker på den neste tasten i hurtigtastkombinasjonen.

Hurtigtast	Ikone	Funksjon	Beskrivelse
<Fn> + <F3>		Kommunikasjonstast	Aktiverer/deaktiverer datamaskinens kommunikasjonsenheter. (Kommunikasjonsenheter kan variere i konfigurasjon.)
<Fn> + <F4>		Dvale	Setter datamaskinen i dvalemodus.
<Fn> + <F5>		Skjermbytte	Bytter mellom visning på vanlig skjerm, ekstern skjerm (hvis tilkoblet) eller begge deler.
<Fn> + <F6>		Visning av	Slå av skjermens bakgrunnsbelysning for å spare strøm. Trykk på en hvilken som helst tast for å gå tilbake.
<Fn> + <F7>		Pekeplate av/på	Slår den interne pekeplaten av og på.
<Fn> + <F8>		Høytaler av/på	Slår høytalerne av og på.
<Fn> + <F11>	NumLk	NumLock	Slår det innebygde talltastaturet av eller på.
<Fn> + <F12>	Scr Lk	Scroll Lock	Når rullelåsen er på, beveger skjermen seg en linje opp eller ned når du trykker på henholdsvis opp- eller nedpil. Rullelåsen fungerer ikke med alle applikasjoner.
<Fn> + <◀▶>		Lysstyrke opp	Øker skjermens lysstyrke.
<Fn> + <◀◀>		Lysstyrke ned	Reduserer skjermens lysstyrke.
<Fn> + <▲>		Volum opp	Øker lydvolumet.
<Fn> + <▲▼>		Volum ned	Reduserer lydvolumet.
<Fn> + <Home>		Play/Pause	Spill av eller pause en valgt mediefil.
<Fn> + <Pg Up>		Stopp	Stopp avspilling av den valgte mediefilen.
<Fn> + <Pg Dn>		Forrige	Returner til forrige mediefil.
<Fn> + <End>		Neste	Hopp til neste mediefil.

Lukket frontvisning



#	Ikon	Element	Beskrivelse
1		Multi-i-1-kortleser	Godtar Secure Digital (SD), MultiMediaCard (MMC), Memory Stick (MS), Memory Stick Pro (MS PRO), og xD-Picture Card (xD). Merk: Skyv inn for å fjerne/installere kortet. Bare ett kort kan operere til enhver tid.



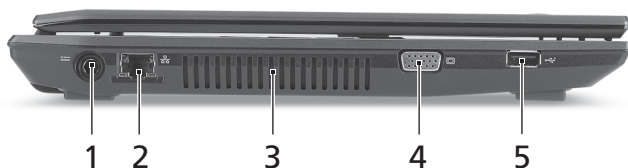

Venstre visning

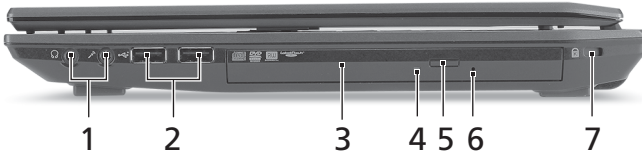

#	Ikon	Element	Beskrivelse
1		Strømtilkobling	Kobler til en batterieliminatort.
2		Ethernet-port (RJ-45)	Kobler til et Ethernet 10/100/1000-basert nettverk.
3		Ventilasjonsåpninger	Gir datamaskinen mulighet til å holde seg kjølig, selv etter lang tids bruk.
4		Port for ekstern skjerm (VGA)	Kobler til en skjermenhet (f.eks. ekstern skjerm, LCD-projektor).
5		USB 2.0-port	Kobler til USB 2.0-enheter (f.eks. USB-mus, USB-kamera).





Høyre visning



#	Ikon	Element	Beskrivelse
1		Hodetelefon/ høyttalere/ line-out-port	Kobles til utdataenheter for lyd (f.eks. høyttalere, hodetelefon).
		Mikrofonport	Mottar inndata fra eksterne mikrofoner.
2		USB 2.0-port	Kobler til USB 2.0-enheter (f.eks. USB-mus, USB-kamera).
3		Optisk stasjon	Intern optisk stasjon. Godtar CDer og DVDer.
4		Tilgangsindikator for optisk disk	Lyser når den optiske stasjonen er aktiv.
5		Utløserknapp for optisk stasjon	Løser ut den optiske disken fra stasjonen.
6		Nødutløserhull	Løser ut platen i den optiske stasjonen når datamaskinen er slått av. Merk: Sett en binders i nødutløserhullet hvis du må løse ut den optiske stasjonen når datamaskinen er av.
7		Spor for Kensington-lås	Kobler til en Kensington-kompatibel sikkerhetslås for datamaskinen.

Bunnvisning



#	Ikonelement	Beskrivelse
1	Batterierom	Huser datamaskinens batterier.
2	 Batterilås	Låser batteriet på plass.
3	 Harddiskplass	Huser datamaskinens harddisk (sikret med skruer).
4	 Minnerom	Huser datamaskinens hovedminne.
5	Ventilasjonsåpninger og kjølevifte	Gir datamaskinen mulighet til å holde seg kjølig, selv etter lang tids bruk. Merk: Ikke dekk til eller blokker viftens åpning.
6	 Batterifrigivelsesbolt	Frigir batteriet for fjerning.

Miljø

- Temperatur:
 - Drift: 5°C til 35°C
 - Ikke i bruk: -20°C til 65°C
- Luftfuktighet (ikke-kondenserende):
 - Drift: 20% til 80%
 - Ikke i bruk: 20% til 80%

TravelMate 4740/4740Z/4340 Seriens

Hurtig-guide

© 2010 Alle Rettigheder Forbeholdes.

TravelMate 4740/4740Z/4340 Seriens Hurtig-guide

Oprindeligt udgivet: 03/2010

TravelMate 4740/4740Z/4340 seriens notebook-pc

Modelnummer: _____

Serienummer: _____

Købsdato: _____

Købt hos: _____

For det første

Vi vil gerne takke for, at du har valgt en Acer bærbar til at opfylde dine mobile computerbehov.

Dine vejledninger

Vi har udarbejdet et sæt vejledninger til at hjælpe dig med at anvende din Acer notebook.

Til at begynde med, på plakaten kan du finde hjælp til at komme i gang med opsætningen af computeren.

TravelMate-seriens Fælles brugervejledning indeholder nyttige oplysninger, der gælder alle modellerne i TravelMate-produktserien. Den dækker grundlæggende emner, f. eks. brug af tastatur, lyd osv. Husk venligst, at **Fælles guide** såvel som **AcerSystem User's Guide** nævnt nedenfor nogle gange henviser til funktioner eller kapaciteter, der kun findes i udvalgte modeller, og ikke nødvendigvis i den model du købte. Sådanne tilfælde er markeret i teksten med f.eks. "kun på visse modeller".

Den trykte **Hurtigvejledning** beskriver de grundlæggende funktioner ved din nye computer. Du kan finde flere oplysninger om, hvordan computeren kan hjælpe dig til at blive mere produktiv, i **AcerSystem User's Guide**. Denne vejledning indeholder detaljerede oplysninger om emner som systemprogrammer, datagendannelse, udvidelsesmuligheder og fejlfinding. Derudover indeholder den garantioplysninger og generelle regulativer og sikkerhedsmeddelelser til din bærbare. Den findes i Portable Document Format (PDF) og leveres forudindstalleret på din bærbare. Følg disse trin for at få adgang til den:

- 1 Klik på  **Start > Alle programmer > AcerSystem.**
- 2 Klik på **AcerSystem User's Guide.**



Bemærk: For at få vist filen skal du have Adobe Reader installeret. Hvis Adobe Reader ikke er installeret på din computer, kører installationsprogrammet til Adobe Reader automatisk, når du klikker på **AcerSystem User's Guide**. Følg instruktionerne på skærmen for at fuldføre installationen. Yderligere oplysninger om, hvordan du bruger Adobe Reader, finder du i menuen **Hjælp og support**.





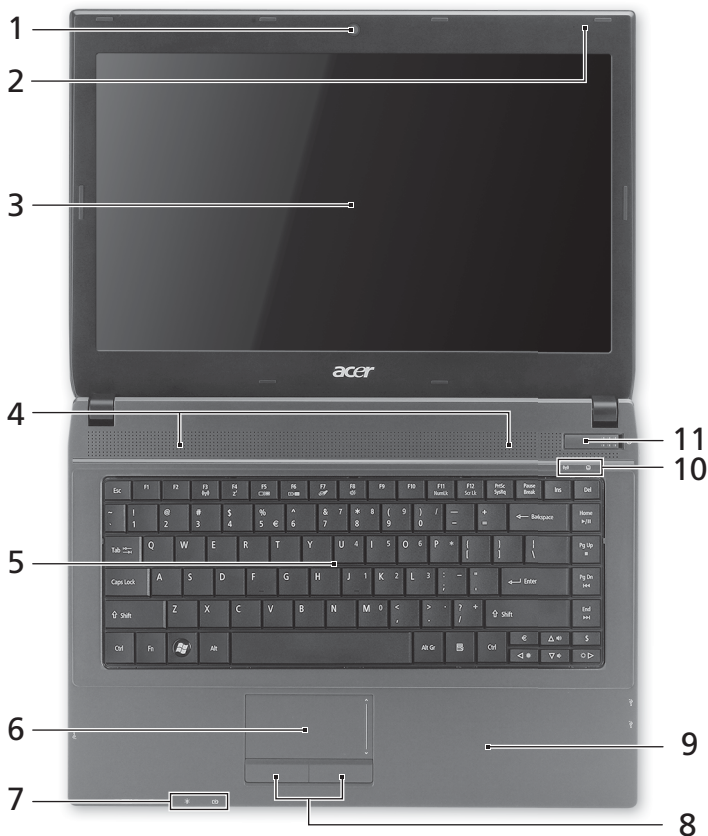

En præsentation af din Acer notebook

Når du har sat computeren op som vist på illustrationerne på plakaten, bør du bruge et par minutter på at lære din nye Acer notebook at kende.

Fra oven



#	Ikon	Emne	Beskrivelse
1		Acer Crystal Eye webcam	Webkamera til videokommunikation (kun for udvalgte modeller).

#	Ikon	Emne	Beskrivelse
2		Mikrofon	Intern mikrofon til optagelse af lyd.
3		Skærm	Det kaldes også for et LCD (Liquid-Crystal Display - flydende krystaldisplay), og det viser computerens output (Konfiguration kan variere fra model til model).
4		Højtalere	Venstre og højre højttalere udsender lyd i stereo.
5		Tastatur	Til indtastning af data på computeren.
6		Touchpad (pegefelt)	Et berøringfølsomt pegeredskab, der fungerer ligesom en computermus.
7		Strømindikator ¹	Angiver computerens strømstatus.
		Batteriindikator ¹	Angiver computerens batteristatus. 1. Oplader: Lampen lyser gult, når batteriet oplader. 2. Fuldt opladet: Lampen lyser blå i AC-tilstand.
8		Klik-knapper (til venstre og til højre)	Knapperne til højre og venstre fungerer på samme måde som musens højre og venstre knapper.
9		Håndfladestøtte	Et komfortabelt støtteområde for dine hænder, når du bruger computeren.
10		Kommunikationsindikator	Angiver status for computerens trådløse enhedsforbindelse.
		Harddiskindikator	Lyser, når harddisken er aktiv.
11		Strømafbryder	Tænder/slukker for computeren.

1. Frontpanelets indikatorer er synlige, selvom computerens låg er lukket.

















Bemærk: Den nøjagtige konfiguration af din pc afhænger af den købte model.

Hurtigtaster

Computeren bruger hurtigtaster eller tastkombinationer til at få adgang til de fleste af computerens kontroller som skærmens lysstyrke og lydstyrke.

Hvis du vil aktivere hurtigtaster, skal du holde **<Fn>**-tasten nede og derefter trykke på den anden tast i hurtigtastkombinationen.

Hurtigtast	Ikon	Funktion	Beskrivelse
<Fn> + <F3>		Kommunikationstaste	Aktiverer/deaktiverer computerens kommunikationsenheder. (Kommunikationsenheder kan variere efter konfiguration).
<Fn> + <F4>		Dvale	Sætter computeren i dvaletilstand.
<Fn> + <F5>		Skærm til/fra	Skifter skærmoutputtet mellem skærmen, en ekstern skærm (hvis den er tilsluttet) og begge to.
<Fn> + <F6>		Skærm fra	Slukker for skærmens baggrundslys for at spare strøm. Tryk på en vilkårlig tast for at fortsætte.
<Fn> + <F7>		Pegefelt til/fra	Tænder og slukker for det interne pegefelt.
<Fn> + <F8>		Højtaler til/fra	Tænder og slukker for højttalerne.
<Fn> + <F11>	NumLk	NumLock	Tænder/slukker for det indbyggede numeriske tastatur.
<Fn> + <F12>	Scr Lk	Scroll Lock	Når Scroll Lock er slået til, ruller skærbilledet en linje op eller ned, når du trykker på henholdsvis Pil op og Pil ned. I visse programmer fungerer Scroll Lock ikke.
<Fn> + <◀▶>		Lysstyrke op	Forøger skærmens lysstyrke.
<Fn> + <◀◀>		Lysstyrke ned	Formindsker skærmens lysstyrke.
<Fn> + <▲>		Lydstyrke op	Forøger højttalerens lydstyrke.
<Fn> + <▲▼>		Lydstyrke ned	Reducerer højttalerens lydstyrke.
<Fn> + <Home>		Afspil/Afbryd	Afspil eller stands midlertidigt en udvalgt mediefil.
<Fn> + <Pg Up>		Stop	Standser afspilningen af den valgte mediefil.
<Fn> + <Pg Dn>		Forrige	Går tilbage til forrige mediefil.
<Fn> + <End>		Næste	Springer til den næste mediefil.





Forfra - Lukket

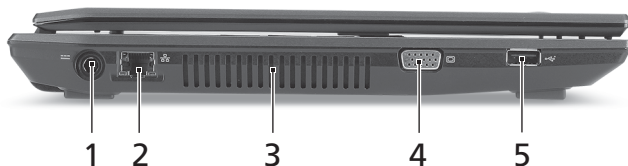

#	Ikon	Emne	Beskrivelse
1		Flere-i-en-kortlæser	Accepterer Secure Digital (SD), MultiMediaCard (MMC), Memory Stick (MS), Memory Stick PRO (MS PRO), og xD-Picture Card (xD). Bemærk: Skub for at fjerne/installere kortet. Der kan kun være et kort aktivt ad gangen.





Set fra venstre



#	Ikon	Emne	Beskrivelse
1		Jævnstrøm ind-stik	Tilslutter til en AC-adapter.
2		Netværksport (RJ-45)	Til tilslutning af et Ethernet 10/100/1000-baseret netværk.
3		Ventilationsåbninger	Lader computeren være kølig selv efter lang tids brug.
4		Stik til ekstern skærm (VGA)	Tilslutter til en skærmenhed (f.eks. ekstern skærm, LCD-projektor).
5		USB 2.0-port	De er beregnet til tilslutning af to USB 2.0-enheder (f. eks. en USB-mus, USB-kamera).





Set fra højre



#	Ikon	Emne	Beskrivelse
1		Hovedtelefoner/ højtalere/linje ud-stik	Der kan tilsluttes ekstraudstyr (f. eks. højtalere, hovedtelefoner).
		Mikrofonstik	Accepterer input fra eksterne mikrofoner.
2		USB 2.0-port	De er beregnet til tilslutning af to USB 2.0- enheder (f. eks. en USB-mus, USB-kamera).
3		Optisk drev	Internt optisk drev; accepterer CD'er og DVD'er.
4		Optisk disk - adgangsindikator	Lyser når det optiske drev er aktivt.
5		Udløserknap for det optiske drev	Skubber den optiske disk ud ad drevet.
6		Mekanisk udløserhul	Det åbner skuffen til det optiske drev, når computeren er slukket. Bemærk: Indsæt en papirklips i hullet til nødduskubning for at skubbe den optiske drevbakke ud, når computeren er slukket.
7		Åbning til en Kensington-lås	Tilslutter til en Kensington-kompatibel computers sikkerhedslås.

Set fra bunden



#	Ikon	Emne	Beskrivelse
1		Batterirum	Indeholder computerens batteri.
2		Batterilås	Låser batteriet på plads.
3		Harddiskbås	Indeholder computerens harddisk (sikret med skruer).
4		Hukommelsesrum	Her sidder computerens centrale hukommelse.
5		Ventilationshuller og køleblæser	Lader computeren være kølig selv efter lang tids brug. Bemærk: Du må aldrig tildække eller spærre åbningen til køleren.
6		Frigørelsesarm til batteri	Frigør batteriet til udtagning.

Omgivelser

- Temperatur:
 - Under brug: 5°C til 35°C
 - Ikke i brug: -20°C til 65°C
- Fugtighed (ikke-kondenserende):
 - Under brug: 20% til 80%
 - Ikke i brug: 20% til 80%

TravelMate 4740/ 4740Z/4340-serien

Snabbguide

© 2010 Med ensamrätt.

TravelMate 4740/4740Z/4340-serien - Snabbguide
Ursprunglig utgåva: 03/2010

TravelMate 4740/4740Z/4340-serien – bärbar PC-dator

Modellnummer: _____

Serienummer: _____

Inköpsdatum: _____

Inköpsställe: _____

Först och främst

Vi vill tacka för att du valde en bärbar Acer-dator för att uppfylla dina behov av mobil databehandling.

Dina guider

Vi har tagit fram en uppsättning guider som hjälper vid användning av din bärbara Acer-dator:

Till att börja med finns instruktionsfoldern som hjälper dig komma igång med installationen av datorn.

Den tryckta **Allmän guide för TravelMate-serien** innehåller användbar information som gäller alla modeller i TravelMate-produktserien. Den omfattar grundläggande ämnen som användning av tangentbordet och ljud med mera. Var medveten om att **Allmän användarguide** samt **AcerSystem User Guide** som nämns nedan till följd av sin natur då och då hänvisar till funktioner som bara finns i vissa av seriens modeller men inte nödvändigtvis i den modell som du har köpt. Sådana förekomster markeras i texten med "bara för vissa modeller".

I **Snabbguide** presenteras de grundläggande funktionerna i din nya dator. Mer information om hur datorn kan hjälpa dig att bli mer produktiv finns i **AcerSystem User Guide**. Denna handbok innehåller detaljerad information om ämnen som systemverktyg, dataåterhämtning, expansionsalternativ och felsökning. Dessutom innehåller den garantiinformation samt allmänna föreskrifter och säkerhetsmeddelanden angående den bärbara datorn. Den finns i Portable Document Format (PDF) och har förinstallerats i den bärbara datorn. Följ de här stegen för att få tillgång till den:

- 1 Välj  **Start > Alla program > AcerSystem.**
- 2 Klicka på **AcerSystem User Guide.**



Obs! Du måste ha Adobe Reader installerat för att kunna visa filen. Om Adobe Reader inte är installerat på datorn kommer det att installeras när du dubbelklickar på **AcerSystem User Guide**. Följ anvisningarna på skärmen för att genomföra installationen. Instruktioner för hur du använder Adobe Reader finns på menyn **Hjälp och Support**.





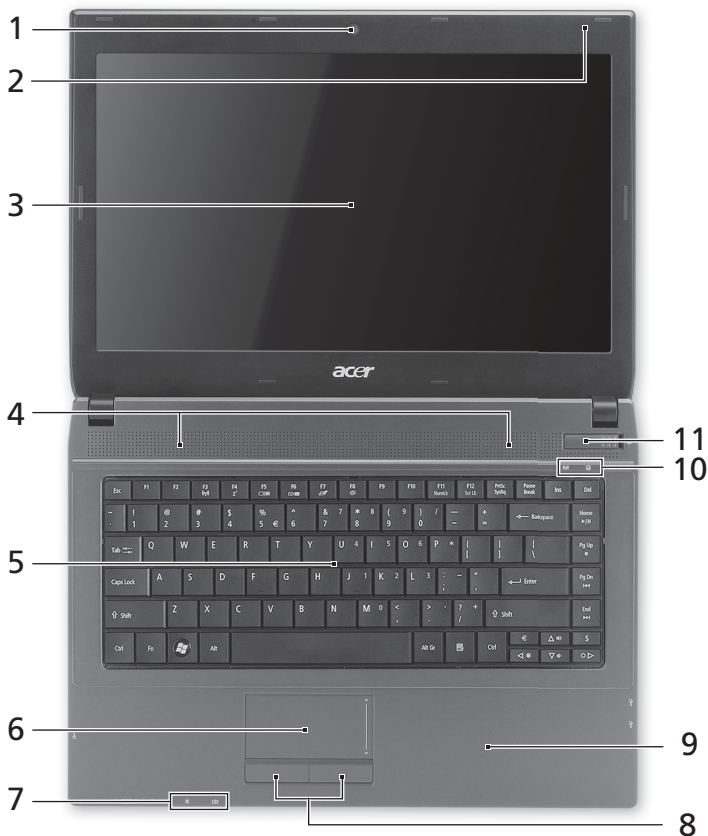

Beskrivning av din bärbara Acer-dator

När du har installerat datorn enligt illustrationen i instruktionsfoldern vill vi beskriva din nya bärbara Acer-dator.

Vy över ovasidan



#	Ikon	Objekt	Beskrivning
1		Acer Crystal Eye webbkamera	Webbkamera för videokommunikation (endast för vissa modeller).

#	Ikön	Objekt	Beskrivning
2		Mikrofon	Inbyggd mikrofon för ljudinspelning.
3		Bildskärm	Kallas även Liquid-Crystal Display (LCD), visar utdata från datorn (konfigurationen kan variera från modell till modell).
4		Högtalare	Vänster och höger högtalare som ger stereoljud.
5		Tangentbord	För inmatning av data i datorn.
6		Pekplatta	Beröringskänslig pekenhet som fungerar som en datormus.
7		På-indikator ¹	Anger om datorn är av eller på.
		Batteriindikator ¹	Anger status för datorns batteri. 1. Laddar: Lyser orange när batteriet laddas. 2. Fulladdad: Lyser blått då datorn är ansluten till nätström.
8		Klickknappar (vänster och höger)	Vänster och höger knapp fungerar som vänster och höger musknapp.
9		Handlovsstöd	Handlovsstödet ger bekvämt stöd för händerna när du använder datorn.
10		Kommunikationsindikator	Anger status för datorns trådlösa anslutningsenhet.
		Hårddiskindikator	Tänds när hårddisken arbetar.
11		Strömbrytare	Slår på och stänger av datorn.

1. Indikatorerna på frontpanelen syns även när datorhöljet är stängt.















.....

Obs! Den exakta konfigurationen i din dator beror på vilken modell du har köpt.

Snabbtangenter

Datorn använder snabbtangenter eller tangentkombinationer för att komma åt de flesta av datorns kontroller som t.ex. skärmens ljusstyrka och volym.

Du aktiverar snabbtangenter genom att hålla ned <Fn> innan du trycker på den andra tangenten i snabbtangentskombinationen.

Snabbtangent	Ikön	Funktion	Beskrivning
<Fn> + <F3>		Kommunikationstangent	Aktiverar/avaktiverar datorns kommunikationsenheter. (Kommunikationsenheterna kan variera beroende på konfiguration.)
<Fn> + <F4>		Vänteläge	Placerar datorn i vänteläge.
<Fn> + <F5>		Växla bildskärm	Växlar visning mellan datorns bildskärm och en extern monitor (om ansluten) och båda.
<Fn> + <F6>		Bildskärm av	Stänger av bildskärmens bakgrundsbelysning för att spara ström. Återgå genom att trycka på en valfri tangent.
<Fn> + <F7>		Aktivera/inaktivera pekplatta	Aktivera/inaktivera den interna pekplattan.
<Fn> + <F8>		Aktivera/inaktivera högtalare	Sätter på/stänger av högtalarna.
<Fn> + <F11>	NumLk	NumLock	Aktiverar/inaktiverar den inbyggda numeriska knappsetsen.
<Fn> + <F12>	Scr Lk	Scroll Lock	När rullningslåset (Scroll Lock) är aktiverad flyttas skärmbilden en rad uppåt eller nedåt när du trycker på upp- eller nedpilen. Den här funktionen fungerar inte med alla program.
<Fn> + <◀>		Öka ljusstyrkan	Ökar bildskärmens ljusstyrka.
<Fn> + <◀◀>		Minska ljusstyrka	Minskar bildskärmens ljusstyrka.
<Fn> + <▶>		Volym upp	Höjer högtalarvolymen.
<Fn> + <▶▶>		Volym ned	Sänker högtalarvolymen.
<Fn> + <Home>		Spela upp/pausa	Spelar upp eller pausar en vald mediefil.
<Fn> + <Pg Up>		Stopp	Stoppar uppspelning av vald mediefil.

Snabbtangent	Ikon	Funktion	Beskrivning
<Fn> + <Pg Dn>	⏪	Föregående	Återgår till föregående mediefil.
<Fn> + <End>	⏩	Nästa	Hoppar till nästa mediefil.





Vy över stängd framsida

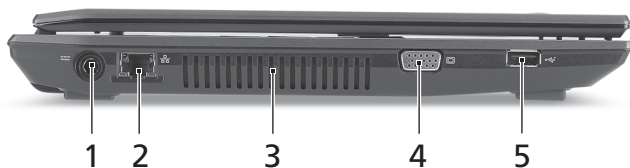

#	Ikon	Objekt	Beskrivning
1		Flera-i-1-kortläsare	<p>Avsedd för Secure Digital (SD), MultiMediaCard (MMC), Memory Stick (MS), Memory Stick PRO (MS PRO), xD-Picture Card (xD).</p> <p>Obs! Tryck för att ta bort/sätta i kortet. Endast ett enda kort kan vara aktivt åt gången.</p>





Vy från vänster



#	Ikon	Objekt	Beskrivning
1		DC in-anlutning	Ansluts till en växelströmsadapter.
2		Ethernet-port (RJ-45)	Ansluts till ett Ethernet 10/100/1000-baserat nätverk.
3		Ventilationsöppningar	Möjliggör att datorn håller sig sval, även efter långvarig användning.
4		Port för extern bildskärm (VGA)	Ansluts till en visningsenhet (t.ex. extern bildskärm, LCD-projektor).
5		USB 2.0-port	Anslutning för USB 2.0-enheter (t.ex. USB-mus, USB-kamera).





Vy från höger

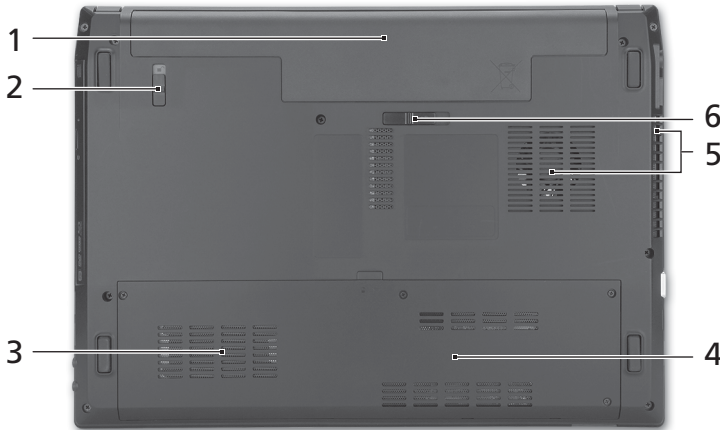

#	Ikon	Objekt	Beskrivning
1		Utgång för hörlurar/högtalare/linje ut	Ansluts till ljud ut-enheter (t.ex. högtalare, hörlurar).
		Mikrofoningång	Anslutning för externa mikrofoner.
2		USB 2.0-port	Anslutning för USB 2.0-enheter (t.ex. USB-mus, USB-kamera).
3		Optisk läsenhet	Inbyggd optisk läsenhet för CD- eller DVD-skivor.
4		Åtkomstindikator för optisk läsenhet	Tänds när den optiska läsenheten arbetar.
5		Utmatningsknapp för optisk läsenhet	Matar ut skivan från den optiska läsenheten.
6		Hål för mekanisk utmatning	Matar ut skivluckan från den optiska läsenheten när datorn är avstängd. Obs! För in spetsen på ett gem i det mekaniska utmatningshålet för att mata ut det optiska enhetsfacket när datorn är avslagen.
7		Skåra för Kensingtonlås	Ansluts till ett Kensington-kompatibelt datorskyddslås.

Vy underifrån



#	Ikon	Objekt	Beskrivning
1		Batterifack	Avsett för datorns batteripack.
2		Batterilås	Låser batteriet på plats.
3		Hårddiskfack	Utrymme för datorns hårddisk (fastskruvad).
4		Minnesfack	Här finns datorns huvudminne.
5		Ventilationsöppningar och kylfläkt	Möjliggör att datorn håller sig sval, även efter långvarig användning. Obs! Täck eller blockera aldrig öppningen till fläkten.
6		Hake för frigöring av batteriet	Frigör batteriet före borttagning.

Miljö

- Temperatur:
 - Vid drift: 5°C till 35°C
 - Utom drift: -20°C till 65°C
- Luftfuktighet (icke-kondenserande):
 - Vid drift: 20% till 80%
 - Utom drift: 20% till 80%

TravelMate 4740/4740Z/4340
-sarja

Pikaohje

© 2010 Kaikki oikeudet pidätetään.

TravelMate 4740/4740Z/4340 -sarjan Pikaohje
Ensimmäinen julkistus: 03/2010

TravelMate 4740/4740Z/4340 -sarjan Kannettava tietokone

Mallinumero: _____

Sarjanumero: _____

Ostopäivämäärä: _____

Ostopaikka: _____

Aloitetaan perusasioista

Haluamme kiittää sinua Acerin kannettavan tietokoneen valitsemisesta liikkuvien tietokonetarpeittesi täyttämässä.

Ohjeet

Helpottaaksesi sinua Acer-tietokoneen käyttämisessä olemme suunnitelleet sarjan ohjekirjoja:

Ihan aluksi juliste auttaa sinua tietokoneen käyttöönotossa.

TravelMate Series Generic Guide (TravelMate-sarjan perusopas) sisältää hyödyllisiä tietoja, jotka käyvät TravelMate -tuotesarjan kaikille malleille. Se kattaa perusaiheet kuten näppäimistön ja äänen, jne. käyttäminen.

On ymmärrettävä, että luonteestaan johtuen, **Peruskäyttäjän opas** sekä alla mainittu **AcerSystem Käyttäjän opas** viittaavat ajoittain toimintoihin tai ominaisuuksiin, jotka on sisällytetty vain tiettyihin sarjojen malleihin, mutta ei välttämättä ostamaasi malliin. Sellaiset tapaukset on merkitty tekstissä kyseisellä kielellä "vain tietyille malleille".

Tämä **Pikaohje** esittelee uuden tietokoneesi perusominaisuudet ja -toiminnot. Saadaksesi lisätietoja siitä, miten tietokoneesi voi auttaa sinua lisäämään tuottavuutta, katso **AcerSystem User Guide**. Tässä ohjeessa on yksityiskohtaiset ohjeet järjestelmätoiminnoista, tietojen palauttamisesta, tietokoneen laajentamisesta ja ongelmanratkaisusta. Siinä on myös annettu yleisiä ohjeita, tietoja takuusta sekä turvallisuusohjeita. Se on saatavana Portable Document Format (PDF) -muodossa, ja ja tulee esiasennettuna tietokoneellesi. Seuraa näitä ohjeita siihen pääsemiseksi:

- 1 Napsauta  **Käynnistä** > **Kaikki ohjelmat** > **AcerSystem**.
- 2 Napsauta **AcerSystem User Guide**.



.....

Huomautus: Jotta voit näyttää tiedoston, Adobe Readerin on oltava asennettu. Jos Adobe Reader ei ole asennettu tietokoneessasi, napsauttamalla **AcerSystem User Guide** se suorittaa ensin Adobe Reader -asennusohjelman. Noudata näytölle tulevia ohjeita, kunnes asennus on valmis. Saat lisätietoja Adobe Readerin käytöstä valikosta **Ohje ja tukikeskus**.

Tutustuminen Acerin kannettavaan tietokoneeseen

Kun olet asentanut tietokoneesi kuten julisteessa on kuvattu, anna meidän esitellä uusi kannettava Acer-tietokoneesi.

Näkymä ylhäältä

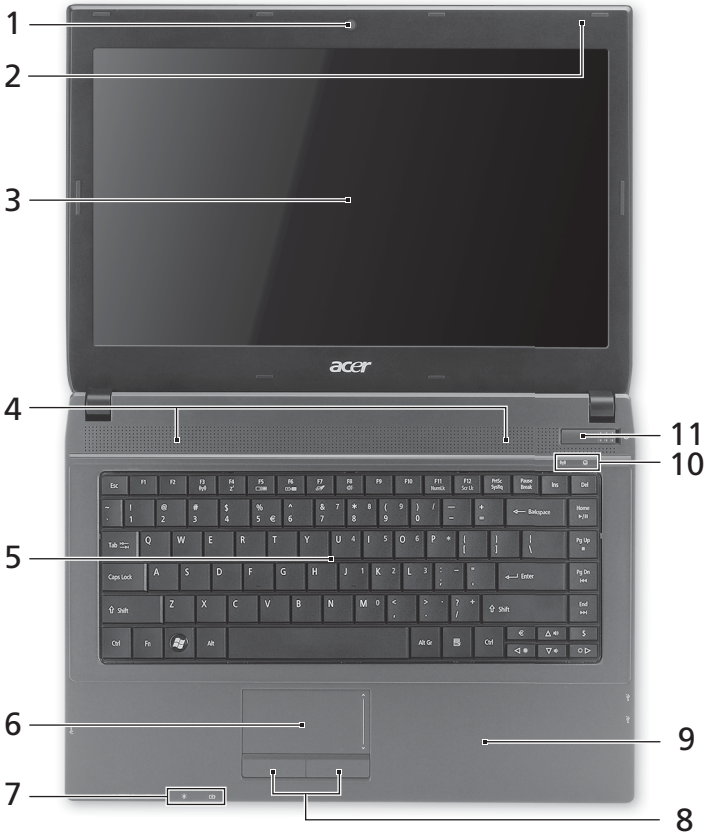

#	Kuvake	Osoi	Kuvaus
1		Acer Crystal Eye - webkamera	Web-kamera video-tietoliikenteeseen (vain tietyille malleille).

#	Kuvake	Osio	Kuvaus
2		Mikrofoni	Sisäinen mikrofoni äänen tallentamista varten.
3		Näyttörüuutu	Nimeltään myös nestekidenäyttö (Liquid-Crystal Display; LCD), näyttää tietokoneen ulostulon (konfiguraatio voi vaihdella mallista riippuen).
4		Kaiuttimet	Vasen ja oikea kaiutin tuottavat stereoääntä.
5		Näppäimistö	Tiedon syöttämiseen tietokoneelle.
6		Kosketusalue	Kosketusherkkä osoitinlaite, joka toimii kuten tietokoneen hiiri.
7		Virranilmaisimien ¹	Osoittaa tietokoneen virran tilan.
		Akun tilan ilmaisimien ¹	Osoittaa tietokoneen akun tilan. 1. Lataus meneillään: Valo palaa kellanruskeana, kun akku latautuu. 2. Täyteen ladattu: Valo palaa sinisenä, kun tietokone toimii verkkovirralla.
8		Napsauta painikkeita (vasen ja oikea)	Vasen ja oikea painike toimivat kuten hiiren vasen ja oikea painike.
9		Rannetuki	Mukava tuki käsillesi konetta käyttäessäsi.
10		Tietoliikenteen ilmaisimien	Osoittaa tietokoneen langattoman yhdistettävyyden tilan.
		HDD-ilmaisimien	Palaa, kun kiintolevy on aktiivinen.
11		Virtakytkin	Käynnistää ja sulkee koneen.

1. Etupaneelin tilailmaisimet näkyvät, vaikka tietokoneen kansi olisi suljettu.















Huomautus: PC:n tarkka konfigurointi riippuu ostetusta mallista.

Pikavalintanäppäimet

Tietokoneessa on pikavalintanäppäimet tai näppäinyhdistelmät sen useimpia säätöjä, kuten näyttöruudun kirkkautta, äänenvoimakkuutta varten.

Aktivoidaksesi pikavalintanäppäimet paina ja pidä painettuna <Fn> -näppäintä ja paina sitten pikavalintanäppäinyhdistelmän toista näppäintä.

Pikanäppäin	Kuvake	Toiminto	Kuvaus
<Fn> + <F3>		Tietoliikennenäppäin	Ottaa käyttöön/poistaa käytöstä tietokoneen tietoliikennelaitteet. (Tietoliikennelaitteet voivat vaihdella konfiguroinnilla.)
<Fn> + <F4>		Lepotila	Siirtää tietokoneen lepotilaan.
<Fn> + <F5>		Näytön vaihto	Kytkee näytön ulostulon näyttöruudun, ulkoisen monitorin (jos kytketty) ja molempien välillä.
<Fn> + <F6>		Näyttö pois	Sammuttaa näytön taustavalon virran säästämiseksi. Paina mitä tahansa näppäintä palataksesi normaalitilaan.
<Fn> + <F7>		Kosketusalustan vaihtokytkin	Kytkee kosketusalustan käyttöön ja pois käytöstä.
<Fn> + <F8>		Kaiuttimien vaihtokytkin	Kytkee kaiuttimet käyttöön ja pois käytöstä.
<Fn> + <F11>	NumLk	NumLock	Kääntää sulautetun numeerisen näppäimistön päälle tai pois.
<Fn> + <F12>	Scr Lk	Scroll Lock	Kun Scroll Lock on päällä, näytön kuva liikkuu yhden rivin verran ylös tai alas, kun painat ylös- tai alas-nuolinäppäimiä. Scroll Lock ei toimi joissakin sovelluksissa.
<Fn> + <▷>		Kirkkauden lisäys	Lisää näytön kirkkautta.
<Fn> + <◁>		Kirkkauden vähennys	Vähentää näytön kirkkautta.
<Fn> + <△>		Äänenvoimakkuus ylös	Lisää äänenvoimakkuutta.
<Fn> + <▽>		Äänenvoimakkuus alas	Vähentää äänenvoimakkuutta.
<Fn> + <Koti>		Toista/Tauko	Toista tai pysäytä valittu mediatiedosto.
<Fn> + <Sivu ylös>		Pysäytä	Pysäytä valitun mediatiedoston toistaminen.

Pikanäppäin	Kuvake	Toiminto	Kuvaus
<Fn> + <Sivu alas>	⏪	Edellinen	Palaa edelliseen mediatiedostoon.
<Fn> + <Loppu>	⏩	Seuraava	Hyppää seuraavaan mediatiedostoon.





Etunäkymä suljettuna

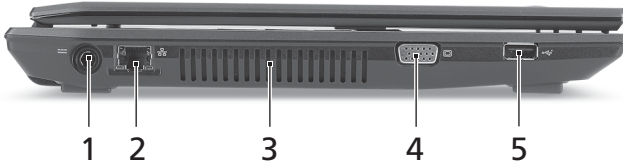

#	Kuvake	Osio	Kuvaus
1		Monta yhdessä - kortinlukija	<p>Hyväksyy seuraavat muistikortit: Secure Digital (SD), MultiMediaCard (MMC), Memory Stick (MS), Memory Stick PRO (MS PRO) ja xD-Picture Card (xD).</p> <p>Huomautus: Poista/Asenna kortti työntämällä. Vain yksi kortti voi toimia mihin aikaan hyvänsä.</p>





Vasen näkymä

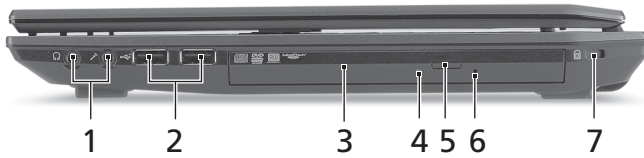

#	Kuvake	Osio	Kuvaus
1		DC-tulolinja	Yhdistää AC-sovittimeen.
2		Ethernet (RJ-45)- portti	Yhdistää Ethernet 10/100/1000 -pohjaiseen verkkoon.
3		Tuuletuspaikat	Mahdollistaa tietokoneen pysymisen viileänä jopa pitkitetyn käytön jälkeen.
4		Ulkoinen näyttöportti (VGA)	Yhdistää näyttölaitteeseen (esim. ulkoinen näyttö, LCD-projektori).
5		USB 2.0 -portti	Yhdistää USB 2.0 -laitteisiin (esim. USB-hiiri, USB-kamera).





Oikea näkymä

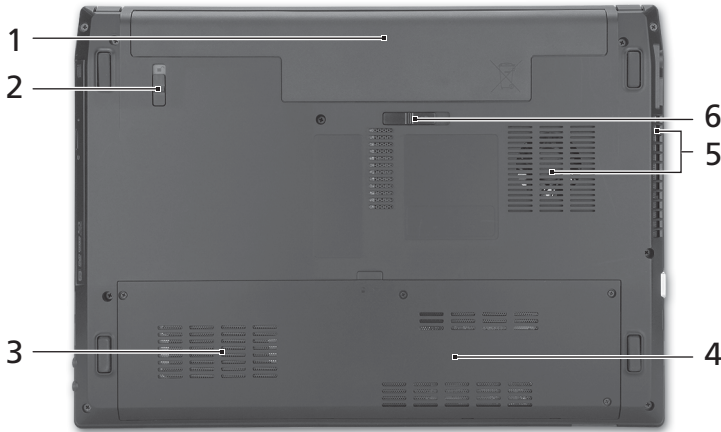

#	Kuvake	Osoite	Kuvaus
1		Kuulokkeet/kaiutin/ jakkiliitäntä	Yhdistää audioliitäntälaitteisiin (esim. kaiuttimet, kuulokkeet).
		Mikrofoni-jakki	Hyväksyy syötteet ulkoisilta mikrofoneilta.
2		USB 2.0 -portti	Yhdistää USB 2.0 -laitteisiin (esim. USB-hiiri, USB-kamera).
3		Optinen asema	Sisäinen optinen levyasema, hyväksyy CD:t ja DVD:t.
4		Optisen levyn tilan osoitin	Syttyy, kun optinen asema on aktiivinen.
5		Optisen aseman ulostyöntöpainike	Työntää optisen levykkeen ulos asemasta.
6		Hätäulostyöntöaukko	Työntää ulos optisen aseman kelkan, kun tietokone on sammutettu. Huomautus: Pane paperiliitin häätäpoistoreikään optisen aseman tarjottimen poistamiseksi asemasta, kun tietokone on pois päältä.
7		Kensington-lukon paikka	Yhdistää Kensington-yhteensopivaan tietokoneen turvalukkuun.

Pohjanäkymä



#	Kuvake	Osio	Kuvaus
1		Akkutila	Sisältää tietokoneen akkuyksikön.
2		Akun lukko	Lukitsee akun paikoilleen.
3		Kovalevytila	Sisältää koneen kovalevyn (varmistettu ruuveilla).
4		Muistilokero	Sisältää tietokoneen päämuisti.
5		Tuuletusaukot ja jäähdytystuuletin	Mahdollistaa tietokoneen pysymisen viileänä jopa pitkitetyn käytön jälkeen. Huomautus: Älä peitä tai tuki tuulettimen aukkoa.
6		Akun vapautussalpa	Vapauttaa akun poistamista varten.

Ympäristö

- Lämpötila:
 - Käyttö: 5°C - 35°C
 - Ei käytössä: -20°C - 65°C
- Kosteus (ei kondensoitunut):
 - Käyttö: 20% - 80%
 - Ei käytössä: 20% - 80%

Серия TravelMate 4740/ 4740Z/4340

Краткое руководство

© 2010 Все права сохранены.

Краткое руководство по компьютеру серии TravelMate 4740/4740Z/4340
Первый выпуск: 03/2010

Портативный компьютер серии TravelMate 4740/4740Z/4340

Номер модели: _____

Серийный номер: _____

Дата покупки: _____

Место покупки: _____

Вначале о главном

Благодарим вас за то, что для решения своих мобильных вычислительных задач вы выбрали ноутбук Acer.

Ваши руководства

Мы разработали ряд руководств, которые помогут вам в использовании ноутбука Acer:

Этот плакат поможет вам выполнить первоначальную настройку компьютера.

Типовое руководство для серии TravelMate содержит полезную информацию, применимую ко всем моделям серии TravelMate. В нем описываются основные темы, такие как работа с клавиатурой, звуком и т.д. Учтите, что **Типовое руководство пользователя** и упомянутое ниже **Руководство пользователя системы Acer** являются обобщенными, поэтому в них иногда будут описываться функции или свойства, реализованные не в купленной вами модели, а лишь в определенных моделях этой серии. В таких случаях в тексте дается пометка "только для определенных моделей".

Краткое руководство знакомит вас с основными характеристиками и функциями вашего нового компьютера. Чтобы узнать больше о том, как повысить продуктивность вашей работы с помощью компьютера, вы можете обратиться к **AcerSystem User Guide**. Это руководство содержит подробную информацию о системных функциях, восстановлении данных, возможностях расширения и устранении неисправностей. В нем также приведена информация о гарантийном обслуживании, а также общие предписания и правила безопасности при работе с ноутбуком. Это руководство в виде файла PDF изначально загружено в компьютер. Для его открытия выполните следующее:

- 1 Нажмите  **Пуск > Все программы > AcerSystem.**
- 2 Нажмите **Руководство пользователя системы Acer.**



.....

Примечание: для просмотра этого файла нужна программа Adobe Acrobat Reader. Если программа Adobe Acrobat Reader не установлена в вашем компьютере, то после нажатия пункта **Руководство пользователя системы Acer** сначала запустится утилита установки программы Acrobat Reader. Для завершения установки выполните отображаемые на экране инструкции. Указания по работе с программой Adobe Acrobat Reader см. в меню **Справка и поддержка**.





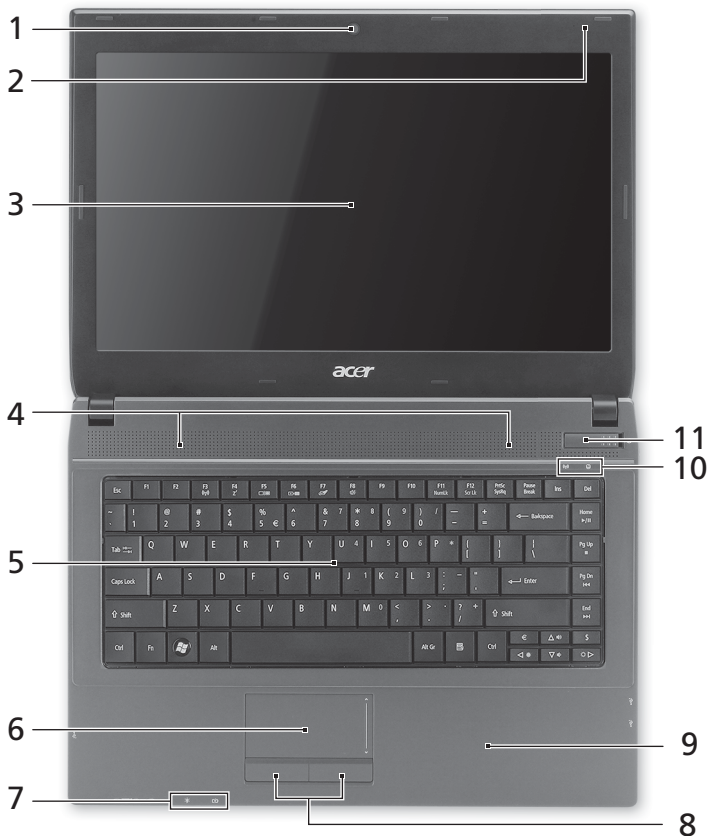

Знакомство с ноутбуком Acer

Теперь, когда вы выполнили настройки, как показано на плакате, давайте поближе познакомимся с вашим новым ноутбуком Acer.

Вид сверху



#	Значок	Элемент	Описание
1		Веб-камера Acer Crystal Eye	Веб-камера для видеосвязи (только для определенных моделей).

#	Значок	Элемент	Описание
2		Микрофон	Внутренний микрофон для записи звука.
3		Экран дисплея	Другое название - жидкокристаллический дисплей (ЖК-дисплей); служит для вывода изображения, формируемого компьютером (конфигурация может отличаться в зависимости от модели).
4		Динамики	Левый и правый динамики служат для вывода стереозвuka.
5		Клавиатура	Служит для ввода данных в компьютер.
6		Сенсорная панель	Чувствительное к прикосновениям указательное устройство, позволяющее управлять курсором на экране так же, как и мышью.
7		Индикатор питания ¹	Отображает состояние питания компьютера.
		Индикатор аккумулятора ¹	Отображает состояние аккумулятора компьютера. 1. Зарядка: Этот индикатор горит желтым во время зарядки аккумулятора. 2. Полностью заряжен: Этот индикатор горит синим при питании от электросети.
8		Кнопки управления (левая и правая)	Эти левая и правая кнопки действуют так же, как левая и правая кнопки мыши.
9		Подставка для запястий	Упорная площадка, на которую удобно положить руки при работе на компьютере.
10		Индикатор связи	Отображает состояние модуля беспроводной связи компьютера.
		Индикатор работы жесткого диска	Горит при обращении к жесткому диску.
11		Выключатель питания	Служит для включения/выключения компьютера.

1. Индикаторы на передней панели видны даже при закрытой крышке компьютера.













Примечание: Фактическая конфигурация ПК зависит от купленной вами модели.

Клавишные комбинации

В компьютере используются "горячие" клавиши (комбинации клавиш) для быстрого вызова большинства функций управления компьютером, таких как яркость экрана и громкость.

Для использования клавишной комбинации сначала нажмите клавишу **<Fn>** и затем, не отпуская ее, нажмите вторую клавишу этой комбинации.

Клавишная комбинация	Значок	функция	Описание
<Fn> + <F3>		Клавиша "Связь"	Включение/выключение модулей связи в компьютере. (Тип модуля связи зависит от конфигурации системы.)
<Fn> + <F4>		Режим сна	Переводит компьютер в режим Сон.
<Fn> + <F5>		Переключение видеовыхода	Переключает вывод изображения либо на дисплей, либо на внешний монитор (если он подключен), либо одновременно и на дисплей, и на внешний монитор.
<Fn> + <F6>		Выкл. дисплей	Выключает экран дисплея для экономии заряда аккумулятора. Для включения экрана нажмите любую клавишу.
<Fn> + <F7>		Переключатель сенсорной панели	Включает и выключает встроенную сенсорную панель.
<Fn> + <F8>		Выключатель динамиков	Попеременно включает и выключает динамики.
<Fn> + <F11>	NumLk	NumLock	Включение/отключение встроенной цифровой клавиатуры.
<Fn> + <F12>	Scr Lk	Scroll Lock	При включенной функции Scroll Lock, экран двигается на строку вверх или вниз, когда нажимаете соответствующую клавишу со стрелками вверх или вниз. С некоторыми приложениями Scroll Lock не работает.
<Fn> + <↑>		Повышение яркости	Увеличение яркости экрана.
<Fn> + <↓>		Понижение яркости	Уменьшает яркость экрана.
<Fn> + <△>		Увеличение громкости	Повышает громкость звука.
<Fn> + <▽>		Уменьшение громкости	Уменьшает громкость звука.

Клавишная комбинация	Значок	функция	Описание
<Fn> + <Home>	▶/	Воспроизвести/ Приостановить	Воспроизведение или приостановка воспроизведения выбранного медиафайла.
<Fn> + <Pg Up>	■	Остановить	Останов воспроизведения выбранного медиафайла.
<Fn> + <Pg Dn>	◀◀	Пред.	Возврат к предыдущему медиафайлу.
<Fn> + <End>	▶▶	След.	Переход к следующему медиафайлу.





Вид спереди с закрытой крышкой

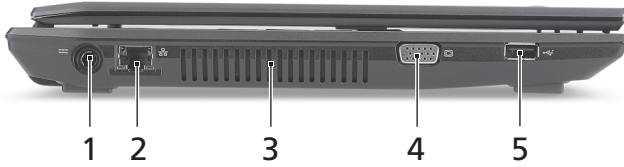

#	Значок	Элемент	Описание
1		Комбинированное устройство считывания карт памяти различных форматов	Поддерживает форматы Secure Digital (SD), MultiMediaCard (MMC), Memory Stick (MS), Memory Stick PRO (MS PRO) и xD-Picture Card (xD). Примечание: Надавите, чтобы извлечь/вставить карту. Одновременно можно использовать только одну карту памяти.

Вид слева



#	Значок	Элемент	Описание
1		Разъем для подключения питания постоянного тока	Служит для подключения адаптера переменного тока.
2		Разъем Ethernet (RJ-45)	Служит для подключения к сети Ethernet 10/100/1000 Мбит/с.
3		Вентиляционные отверстия	Позволяют компьютеру не перегреваться даже при длительной работе.
4		Разъем внешнего дисплея (VGA)	Служит для подключения дисплея (например, внешнего монитора, ЖК-проектора).
5		Разъем USB 2.0	Служит для подключения устройств с интерфейсом USB 2.0 (например, мыши или камеры).





Вид справа

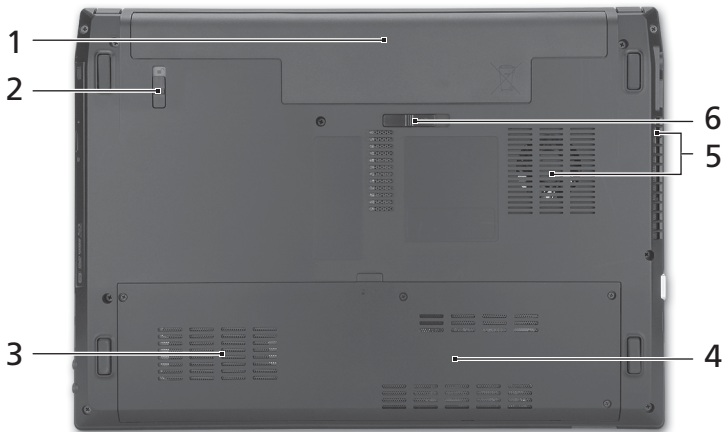

#	Значок	Элемент	Описание
1		Гнездо наушников/ динамика/ линейный выход	Служит для подключения звуковых устройств к линейному выходу (например, динамиков, наушников).
		Гнездо микрофона	Служит для подключения внешнего микрофона.
2		Разъем USB 2.0	Служит для подключения устройств с интерфейсом USB 2.0 (например, мыши или камеры).
3		Привод оптических дисков	Внутренний привод оптических дисков рассчитан на использование компакт-дисков или DVD-дисков.
4		Индикатор обращения к оптическому диску	Горит во время работы привода оптических дисков.
5		Кнопка извлечения диска из привода	Служит для извлечения оптического диска из привода.
6		Отверстие аварийного извлечения	Служит для открытия лотка привода оптических дисков, когда питание компьютера отключено. Примечание: чтобы открыть лоток привода оптических дисков, когда компьютер выключен, вставьте скрепку в это отверстие аварийного извлечения.
7		Замок типа Kensington	Служит для подсоединения защитного тросика с замком типа Kensington для предотвращения кражи компьютера.

Вид снизу



#	Значок	Элемент	Описание
1		Отсек аккумулятора	В этот отсек устанавливается аккумулятор компьютера.
2		Защелка аккумулятора	Служит для фиксации аккумулятора в отсеке.
3		Отсек жесткого диска	Здесь размещается жесткий диск компьютера (крепится винтами).
4		Отсек модулей оперативной памяти	В этот отсек устанавливаются модули оперативной памяти компьютера.
5		Вентиляционные отверстия и вентилятор охлаждения	Позволяют компьютеру не перегреваться даже при длительной работе. Примечание: Не заслоняйте и не загромождайте входное отверстие вентилятора.
6		Защелка извлечения аккумулятора	Разблокирует аккумулятор для его извлечения.

Условия эксплуатации

- Температура:
 - Рабочая: от 5°C до 35°C
 - Нерабочая: от -20°C до 65°C
 - Влажность (без конденсации):
 - Рабочая: от 20% до 80%
 - Нерабочая: от 20% до 80%
-

Komputer serii TravelMate 4740/4740Z/4340

Skrócony poradnik

© 2010 Wszelkie prawa zastrzeżone.

Skrócony poradnik komputera serii TravelMate 4740/4740Z/4340

Wydanie oryginalne: 03/2010

Notebook PC serii TravelMate 4740/4740Z/4340

Oznaczenie modelu: _____

Numer seryjny: _____

Data zakupu: _____

Miejsce zakupu: _____

Po kolei

Dziękujemy za wybranie komputera firmy Acer do spełnienia potrzeb w zakresie mobilnego przetwarzania.

Instrukcje

Aby pomóc w korzystaniu z notebooka Acer, opracowaliśmy zestaw instrukcji:

Jako pierwszy plakat pomoże użytkownikom rozpocząć ustawianie komputera.

Ogólny podręcznik użytkownika urządzenia serii TravelMate zawiera przydatne informacje dotyczące wszystkich modeli serii TravelMate. Obejmuje podstawowe zagadnienia, takie jak używanie klawiatury, dźwięki itd. Należy pamiętać, że **Ogólny podręcznik** oraz **Podręcznik użytkownika AcerSystem**, o którym mowa poniżej, odnoszą się czasami do funkcji lub elementów tylko niektórych modeli serii, które nie muszą występować w zakupionym modelu. Przypadki takie są oznaczone w tekście dopiskiem „w wybranych modelach”.

Skrócony poradnik przedstawia podstawowe właściwości i funkcje nowego komputera. Aby uzyskać więcej informacji o tym, w jaki sposób nowy komputer może pomóc Ci być bardziej produktywnym, zapoznaj się z **AcerSystem User's Guide**. Przewodnik ten zawiera szczegółowe informacje dotyczące takich tematów, jak narzędzia systemowe, odzyskiwanie danych, opcje rozszerzeń oraz rozwiązywanie problemów. Oprócz nich zawiera także informacje na temat gwarancji oraz informacje dotyczące bezpieczeństwa pracy z Twoim komputerem przenośnym. Jest on dostępny w formie elektronicznej jako plik PDF zapisany fabrycznie na dysku komputera. Wykonaj poniższe czynności, aby uzyskać do niego dostęp:

- 1 Kliknij  **Start > Wszystkie programy > AcerSystem**.
- 2 Kliknij **AcerSystem User's Guide**.



.....

Uwaga: Aby można było przeglądać ten plik, konieczne jest zainstalowanie programu Adobe Reader. Jeżeli w komputerze nie zainstalowano programu Adobe Reader, kliknięcie **AcerSystem User's Guide** spowoduje uruchomienie instalatora programu Adobe Reader. Aby zakończyć instalację, należy postępować zgodnie z instrukcjami wyświetlanymi na ekranie. Instrukcje dotyczące używania programu Adobe Reader, znajdują się w menu **Pomocy i obsługi technicznej**.





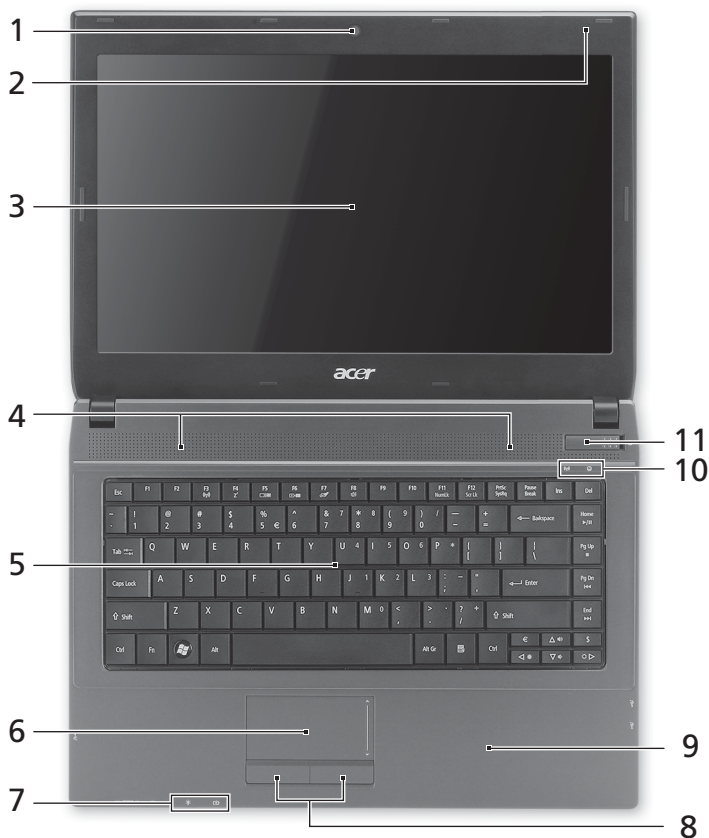

Zapoznanie z notebookiem Acer

Po ustawieniu komputera jak to przedstawiono na ilustracji w posterze, przyjrzyjmy się nowemu notebookowi Acer.

Widok z góry



#	Ikona	Element	Opis
1		Kamera Acer Crystal Eye	Kamera internetowa do komunikacji wideo (tylko w niektórych modelach).

#	Ikona	Element	Opis
2		Mikrofon	Wewnętrzny mikrofon do rejestracji dźwięku.
3		Ekran wyświetlacza	Nazywany jest także wyświetlaczem ciekłokrystalicznym (Liquid-Crystal Display; LCD), wyświetla informacje wyjściowe komputera (konfiguracja może być różna w zależności od modelu).
4		Głośniki	Lewy i prawy głośnik zapewniają możliwość słuchania stereofonicznego dźwięku.
5		Klawiatura	Umożliwia wprowadzanie danych do komputera.
6		Touchpad	Dotykowe urządzenie wskazujące, które działa jak myszka komputerowa.
7		Wskaźnik zasilania ¹	Wskazuje stan zasilania komputera.
		Wskaźnik akumulatora ¹	Wskazuje stan akumulatora komputera. 1. Ładowanie: Świeci żółtym światłem, gdy akumulator jest ładowany. 2. Pełne naładowanie: Świeci niebieskim światłem podczas pracy w trybie zasilania prądem przemiennym.
8		Przyciski kliknięć (lewy i prawy)	Działanie lewego i prawego przycisku jest podobne do działania lewego i prawego przycisku myszki.
9		Podparcie nadgarstków	Wygodne podparcie dłoni podczas używania komputera.
10		Wskaźnik komunikacji	Wskazuje stan połączenia bezprzewodowego komputera z urządzeniem.
		Wskaźnik dysku twardego	Świeci, gdy działa dysk twardy.
11		Włącznik zasilania	Służy do włączania i wyłączenia komputera.

1. Wskaźniki panelu czołowego są widoczne nawet po zamknięciu pokrywy komputera.



Uwaga: Dokładna konfiguracja komputera PC zależy od zakupionego modelu.

Klawisze skrótów

Komputer umożliwia używanie klawiszy skrótów lub kombinacji klawiszy w celu uzyskania dostępu do większości kontrolowanych parametrów, takich jak jasność ekranu czy ustawienia głośności.

Aby uaktywniać klawisze skrótów, naciśnij i przytrzymaj klawisz **<Fn>** przed naciśnięciem innego klawisza w kombinacji klawisza skrótu.

Klawisz skrótu	Ikona	Funkcja	Opis
<Fn> + <F3>		Klawisz komunikacji	Włącza/wyłącza urządzenia komunikacyjne komputera. (urządzenia komunikacyjne mogą być różne w zależności od konfiguracji.)
<Fn> + <F4>		Wstrzymanie	Powoduje przejście komputera do trybu Wstrzymanie.
<Fn> + <F5>		Przełączenie wyświetlania	Umożliwia przełączanie sygnału wyjściowego wyświetlacza na ekran wyświetlacza lub na zewnętrzny monitor (jeśli jest przyłączony) lub na oba.
<Fn> + <F6>		Wyłączenie ekranu	Wyłącza podświetlenie ekranu wyświetlacza w celu oszczędzania energii. Naciśnij dowolny klawisz w celu przywrócenia wyświetlania.
<Fn> + <F7>		Przełączenie touchpada	Umożliwia włączanie i wyłączenie wewnętrznego touchpada.
<Fn> + <F8>		Przełączanie głośnika	Umożliwia włączanie i wyłączenie głośników.
<Fn> + <F11>	NumLk	NumLock	Włączanie i wyłączenie wbudowanego bloku klawiszy numerycznych
<Fn> + <F12>	Scr Lk	Scroll Lock	Kiedy włączona jest funkcja Scroll Lock, ekran przesuwa się o jedną linię w górę lub w dół, przy naciśnięciu odpowiednio strzałki w górę lub w dół. Scroll Lock nie działa z niektórymi aplikacjami.
<Fn> + <◀▶>		Zwiększenie jasności	Zwiększa jasność ekranu.
<Fn> + <◀◀>		Zmniejszenie jasności	Zmniejsza jasność ekranu.
<Fn> + <◀Δ>		Zwiększenie głośności	Zwiększa głośność dźwięku.
<Fn> + <◀▽>		Zmniejszenie głośności	Zmniejsza głośność dźwięku.
<Fn> + <Home>		Odtwórz/ Wstrzymaj	Odtwarzanie lub wstrzymanie wybranego pliku multimedialnego.
<Fn> + <Pg Up>		Zatrzymaj	Zatrzymanie odtwarzania wybranego pliku multimedialnego.

Klawisz skrótu	Ikona	Funkcja	Opis
<Fn> + <Pg Dn>	◀◀	Wstecz	Powrót do wcześniejszego pliku multimedialnego.
<Fn> + <End>	▶▶	Dalej	Przeskoczenie do następnego pliku multimedialnego.





Widok z przodu (pokrywa zamknięta)

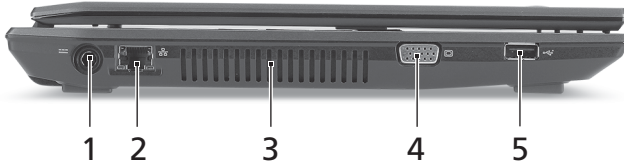

#	Ikona	Element	Opis
1		Wielofunkcyjny czytnik kart pamięci	<p>Obsługuje następujące typy kart: Secure Digital (SD), MultiMediaCard (MMC), Memory Stick (MS), Memory Stick PRO (MS PRO) oraz xD-Picture Card (xD).</p> <p>Uwaga: Aby wyjąć/zainstalować kartę, wciśnij ją delikatnie. Jednorazowo można obsługiwać tylko jedną kartę.</p>





Widok z lewej strony



#	Ikona	Element	Opis
1		Gniazdo zasilania	Gniazdo zasilacza.
2		Port Ethernet (RJ-45)	Służy do przyłączenia do sieci komputerowej typu Ethernet 10/100/1000.
3		Szczeliny wentylacyjne	Umożliwiają chłodzenie komputera nawet podczas długotrwałego użytkowania.
4		Port zewnętrznego wyświetlacza (VGA)	Służy do podłączenia dodatkowego wyświetlacza (np. monitor zewnętrzny lub projektor LCD).
5		Port USB 2.0	Służą do przyłączenia urządzeń USB 2.0 (np. mysz USB, aparat cyfrowy USB).





Widok z prawej strony

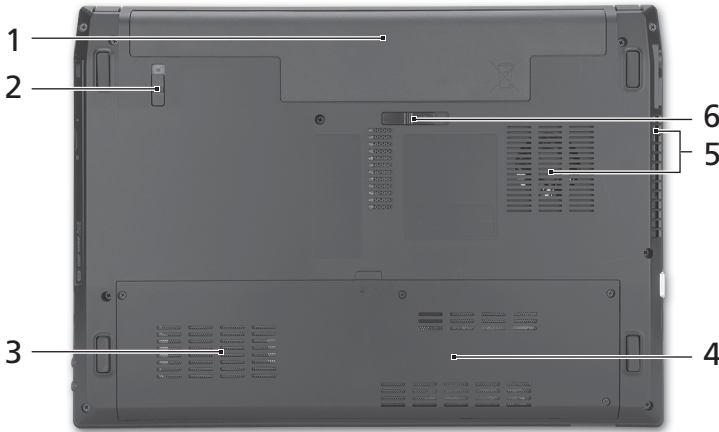

#	Ikona	Element	Opis
1		Gniazdo słuchawki/ głośniki/wyjścia liniowego	Służy do przyłączenia urządzeń liniowego wyjścia audio (np. głośniki, słuchawki).
		Gniazdo mikrofonowe	Służy do przyłączenia sygnału z zewnętrznych mikrofonów.
2		Port USB 2.0	Służą do przyłączenia urządzeń USB 2.0 (np. mysz USB, aparat cyfrowy USB).
3		Napęd optyczny	Wewnętrzny napęd optyczny; obsługuje dyski CD lub DVD.
4		Wskaźnik dostępu do dysku optycznego	Świeci, kiedy napęd optyczny jest aktywny.
5		Przycisk wysuwania napędu optycznego	Wyrzuca dysk optyczny z napędu.
6		Otwór wysuwania awaryjnego	Umożliwia wysunięcie tacy napędu optycznego, kiedy komputer jest wyłączony. Uwaga: Wsuń spinacz do otworu wysuwania awaryjnego w celu wysunięcia tacy napędu optycznego, kiedy komputer jest wyłączony.
7		Gniazdo blokady Kensington	Służy do podłączenia blokady zgodnej ze standardem firmy Kensington.

Widok od strony podstawy



#	Ikona	Element	Opis
1		Wnęka na baterię	Przechowuje baterię komputera.
2		Zatrzask baterii	Pozwala zabezpieczyć baterię w prawidłowej pozycji.
3		Wnęka na dysk twardy	Mieści dysk twardy komputera (zabezpieczona śrubami).
4		Przegroda na pamięć	Mieści główną pamięć komputera.
5		Otwory wentylacyjne oraz wentylator	Umożliwiają chłodzenie komputera nawet podczas długotrwałego użytkowania. Uwaga: Nie wolno zakrywać ani blokować otworu wentylatora.
6		Blokada baterii	Umożliwia zwolnienie i wyjęcie baterii.

Warunki środowiska

- Temperatura:
 - Podczas pracy: Od 5°C do 35°C
 - Podczas przechowywania: Od -20°C do 65°C
- Wilgotność (bez kondensacji pary):
 - Podczas pracy: Od 20% do 80%
 - Podczas przechowywania: Od 20% do 80%

TravelMate 4740/4740Z/4340 sorozat

Rövid útmutató

© 2010 Minden jog fenntartva.

TravelMate 4740/4740Z/4340 sorozat Rövid útmutató
Eredeti kiadás: 03/2010

TravelMate 4740/4740Z/4340 sorozatú hordozható számítógép

Modellszám: _____

Sorozatszám: _____

Vásárlás időpontja: _____

Vásárlás helye: _____

Az első lépések

Köszönjük, hogy mobil számítástechnikai feladatai elvégzéséhez egy Acer hordozható számítógépet választott.

Útmutatók

Minden segítséget szeretnénk megadni Önnek új Acer gépének használatához, ezért a következő útmutatókat dolgoztuk ki:

Első lépésként a poszteren szereplő útmutatást követve helyezze üzembe a számítógépet.

A **TravelMate sorozat általános felhasználói útmutatója** a TravelMate terméksorozat összes tagjára vonatkozó hasznos tudnivalókat tartalmaz. Olyan általános témaköröket tárgyal, mint a billentyűzet használata, a hangok stb. Felhívjuk figyelmét arra, hogy jellegéből fakadóan az **általános felhasználói útmutató** és az alább említett **AcerSystem User Guide** egyes esetekben olyan funkcióra vagy szolgáltatásra is hivatkozhat, amely a terméksorozatnak csak bizonyos tagjain érhető el, és amelyet az Ön által megvásárolt típus nem támogat. Az ilyen eseteket a szövegben a „csak bizonyos modellek esetében” vagy hasonló megjegyzés jelöli.

A jelen **Rövid útmutató** ismerteti az Ön új számítógépének alapvető jellemzőit és funkciót. A számítógép még hatékonyabb használatával kapcsolatban az **AcerSystem User Guide tartalmaz útmutatást**. Ez a kézikönyv részletes információkat tartalmaz például az előre telepített segédprogramokról, az adathelyreállításról, a bővítési lehetőségekről és a hibaelhárításról. Emellett ismerteti a garanciával kapcsolatos tudnivalókat, valamint a számítógépre vonatkozó általános szabályokat és biztonsági előírásokat is. A kézikönyv Portable Document Format (PDF) formátumú, és gyárilag telepítve van a számítógépre. Megnyitáshoz kövesse az alábbi lépéseket:

- 1 Kattintson a következő elemekre:  **Start > Minden program > AcerSystem.**
- 2 Kattintson az **AcerSystem User Guide** elemre.



Megjegyzés: A fájl megtekintéséhez szükség van az Adobe Reader alkalmazásra. Ha az Adobe Reader nincs telepítve a számítógépre, akkor az **AcerSystem User Guide** elemre kattintva először az Adobe Reader telepítőprogramja jelenik meg. A telepítés elvégzéséhez kövesse a képernyőn megjelenő utasításokat. Az Adobe Reader használatával kapcsolatban a **Súgó és támogatás** menüben talál útmutatást.

Ismerkedjen meg új Acer gépével!

Miután a poszter alapján üzembe helyezte a számítógépet, ismerkedjen meg új Acer notebookjával!

Felülnézet

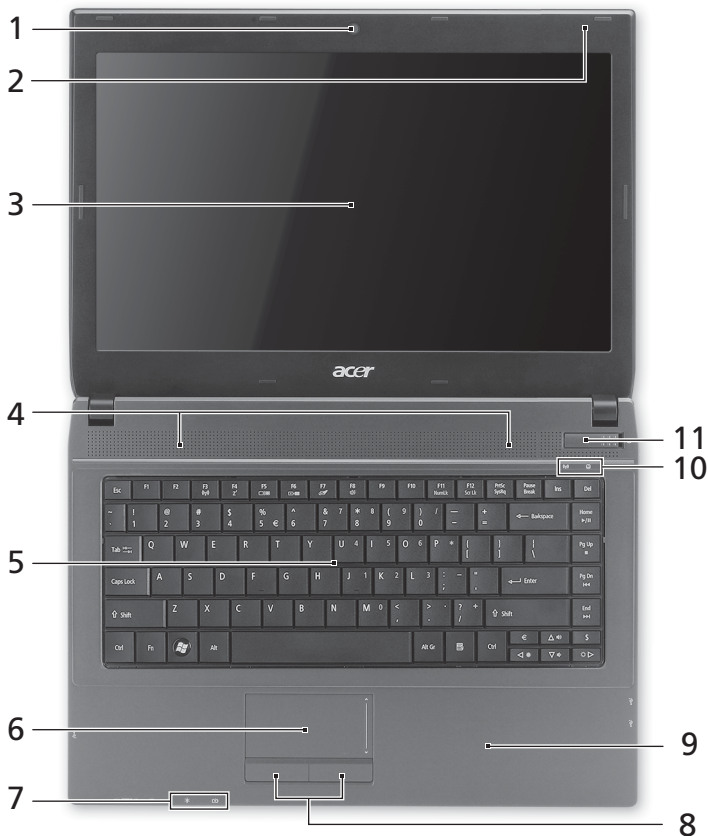

#	Ikon	Elem	Leírás
1		Acer Crystal Eye webkamera	Webkamera videokommunikációs célokra (csak bizonyos típusok esetében).

#	Ikon	Elem	Leírás
2		Mikrofon	Belső mikrofon hangfelvételek készítéséhez.
3		Kijelző	Más néven folyadékkristályos kijelző (Liquid-Crystal Display; LCD), a számítógép kimenetét jeleníti meg (A konfiguráció típusától függően változhat.)
4		Hangszórók	A bal és a jobb oldali hangszórók sztereó hangkimenetet biztosítanak.
5		Billentyűzet	Az adatbevitel eszköze.
6		Érintőpad	Érintésérzékeny mutatóeszköz, a számítógépek egeréhez hasonlóan működik.
7		Üzemállapot jelzőfénye ¹	A számítógép üzemállapotát jelzi.
		Akkumulátor állapotjelzője ¹	Az akkumulátor üzemállapotát jelzi. 1. Töltés: Sárgán világít, ha az akkumulátor töltése folyamatban van. 2. Teljesen feltöltve: Hálózati tápellátás használatakor kéken világít.
8		Kattintógombok (bal és jobb)	A bal és a jobb gomb az egér bal és jobb gombjához hasonlóan működik.
9		Csuklótámasz	Kényelmes támaszkodási felület a számítógép használatának idejére.
10		Kommunikációs állapotjelző	A számítógép vezeték nélküli kommunikációs egységének állapotát jelzi.
		Merevlemez jelzőfénye	Jelzi, ha a merevlemez használatban van.
11		Bekapcsoló gomb	A számítógép be- és kikapcsolására szolgál.

1. Az előlap jelzői akkor is láthatók, ha a számítógép fedele le van hajtva.

















Megjegyzés: A számítógép pontos konfigurációja a megvásárolt modell függvénye.

Gyorsbillentyűk

A számítógép a beállítások jelentős részének elérését gyorsbillentyűkkel vagy billentyűkombinációkkal teszi lehetővé; ilyen például a képernyő fényereje és a hangerő.

Gyorsbillentyű használatához nyomja le és tartsa lenyomva az **<Fn>** billentyűt, a billentyűkombináció másik billentyűjét csak ezt követően nyomja le.

Gyorsbillentyű	Ikron	Funkció	Leírás
<Fn> + <F3>		Kommunikációs billentyű	A számítógép kommunikációs moduljainak be- és kikapcsolására használható. (A kommunikációs modulok konfigurációtól függően eltérők lehetnek.)
<Fn> + <F4>		Alvás	A számítógép alvó üzemmódba helyezése.
<Fn> + <F5>		A kijelző be- és kikapcsolása	Váltás a következő megjelenítési módok között: kijelző, külső monitor (ha csatlakoztatva van), illetve mindkettő.
<Fn> + <F6>		A kijelző kikapcsolása	A kijelző háttérvilágításának kikapcsolása energiamegtakarítás céljából. A háttérvilágítás bármely billentyű megnyomására visszakapcsol.
<Fn> + <F7>		Az érintőpad be- és kikapcsolása	A beépített érintőpad be- és kikapcsolása.
<Fn> + <F8>		Hangszóró be- és kikapcsolása	A hangszórók be- és kikapcsolását teszi lehetővé.
<Fn> + <F11>	NumLk	NumLock	Segítségével be- és kikapcsolható a beépített számbillentyűzet.
<Fn> + <F12>	Scr Lk	Scroll Lock	Amikor a Scroll Lock be van kapcsolva, akkor a képernyő tartalma a felfelé vagy a lefelé mutató nyílal jelölt billentyű megnyomásakor egy sorral feljebb vagy lejjebb gördül. A Scr Lk egyes alkalmazásoknál nem működik.
<Fn> + <▷>		A fényerő növelése	A kijelző fényerejének növelése.
<Fn> + <◁>		A fényerő csökkentése	A kijelző fényerejének csökkentése.
<Fn> + <◁△>		A hangerő növelése	A hangerő növelésére használható.
<Fn> + <▷▽>		A hangerő csökkentése	A hangerő csökkentése.
<Fn> + <Home>		Lejátszás/ szünet	A kijelölt médiafájl lejátszása vagy lejátszásának szüneteltetése.
<Fn> + <Pg Up>		Leállítás	A kijelölt médiafájl lejátszásának leállítása.

Gyorsbillentyű	Ikon	Funkció	Leírás
<Fn> + <Pg Dn>		Előző	Visszalépés az előző médiafájltra.
<Fn> + <End>		Tovább	Ugrás a következő médiafájltra.





Előlnézet lehajtott kijelzővel

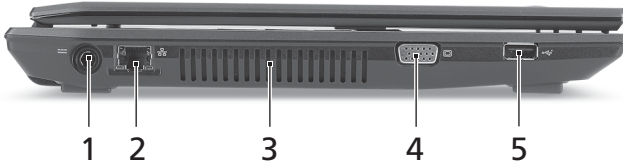

#	Ikon	Elem	Leírás
1		Multifunkciós kártyaolvasó	Secure Digital (SD), MultiMediaCard (MMC), Memory Stick (MS), Memory Stick PRO (MS PRO) és xD-Picture Card (xD) kártyák fogadására képes. Megjegyzés: A kártyák finoman benyomva helyezhetők be és vehetők ki. Egyszerre csak egyféle kártya használatára van lehetőség.





Bal oldali nézet



#	Ikon	Elem	Leírás
1		Egyenáramú bemeneti aljzat	A váltakozó áramú hálózati adapter csatlakoztatását teszi lehetővé.
2		Ethernet (RJ-45) port	Ethernet 10/100/1000 típusú hálózattal képes biztosítani a kapcsolatot.
3		Szellőzőnyílások	Segítségükkel még hosszas használat esetén is fenntartható a számítógép megfelelő üzemi hőmérséklete.
4		Külső kijelző (VGA) port	Megjelenítő eszköz (pl. külső monitor vagy LCD kivetítő) csatlakoztatását teszi lehetővé.
5		USB 2.0 port	USB 2.0 eszközök (pl. USB-s egér vagy kamera) csatlakoztatását teszi lehetővé.





Jobb oldali nézet

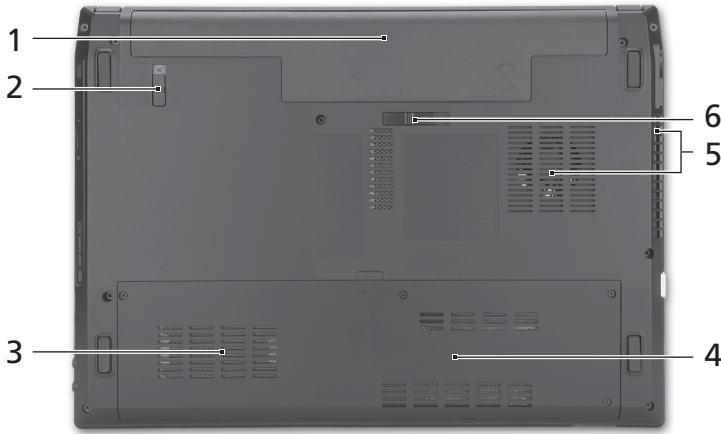

#	Ikon	Elem	Leírás
1		Fejhallgató/ hangszóró/vonali kimenet aljzat	Hangkimeneti eszközök (pl. hangszóró, fejhallgató) csatlakoztatására alkalmas.
		Mikrofonaljzat	Külső mikrofon csatlakoztatását teszi lehetővé.
2		USB 2.0 port	USB 2.0 eszközök (pl. USB-s egér vagy kamera) csatlakoztatását teszi lehetővé.
3		Optikai meghajtó	Belső optikai meghajtó, CD- és DVD-lemezek kezelésére képes.
4		Az optikai lemez elérését jelző fény	Akkor világít, amikor az optikai meghajtó aktív.
5		Optikai meghajtó kiadógombja	Segítségével kiadatható a lemez az optikai meghajtóból.
6		Vészkiadó furat	Lehetővé teszi az optikai meghajtó tálcájának a számítógép kikapcsolt állapotában történő kinyitását. Megjegyzés: Az optikai meghajtó lemeztálcájának kinyitásához helyezzen egy papírkapcsot a vészkiadó nyílásba, miközben a számítógép ki van kapcsolva.
7		Kensington záraljzat	Kensington számítógépes biztonsági zár alkalmazását teszi lehetővé.

Alulnézet



#	Ikon	Elem	Leírás
1		Akkumulátorfoglat	A számítógép akkumulátorát fogadja be.
2		Akkumulátor retesze	Az akkumulátor rögzítését biztosítja.
3		Merevlemez-foglat	A számítógép merevlemezét fogadja be (csavaros rögzítésű).
4		Memóriarekesz	A számítógép memóriáját fogadja be.
5		Szellőzőnyílások és hűtőventilátor	Segítségükkel még hosszas használat esetén is fenntartható a számítógép megfelelő üzemi hőmérséklete. Megjegyzés: A ventilátor nyílását nem szabad elfedni, illetve a levegő áramlását egyéb módon sem szabad akadályozni.
6		Akkumulátor kioldógombja	Az akkumulátor eltávolítását teszi lehetővé.

Környezet

- Hőmérséklet:
 - Üzemeltetés: 5°C – 35°C
 - Kikapcsolt állapotban: -20°C – 65°C
- Páratartalom (kicsapódás nélkül):
 - Üzemeltetés: 20% – 80%
 - Kikapcsolt állapotban: 20% – 80%

Řada TravelMate 4740/ 4740Z/4340

Stručné pokyny

© 2010 Všechna práva vyhrazena.

Stručné pokyny pro počítače řady TravelMate 4740/4740Z/4340

Původní vydání: 03/2010

Notebook řady TravelMate 4740/4740Z/4340

Číslo modelu: _____

Sériové číslo: _____

Datum zakoupení: _____

Místo zakoupení: _____

Stručné pokyny

Děkujeme vám, že jste si k uspokojení svých potřeb v oblasti přenosných počítačů vybrali notebook Acer.

Uživatelské příručky

Abychom vám při používání notebooku Acer pomohli, vytvořili jsme pro vás sadu příruček:

Leták vám pomůže při úvodním nastavení počítače.

Obecná uživatelská příručka pro počítače TravelMate obsahuje užitečné informace pro všechny modely řady TravelMate. Obsahuje základní témata, např. používání klávesnice a zvuku atd. Berte laskavě na vědomí, že **Obecná uživatelská příručka**, jak již její název předesílá, stejně jako níže zmíněná **AcerSystem User's Guide**, může popisovat funkce nebo vlastnosti, kterými jsou vybaveny pouze určité modely dané řady, a kterými nemusí být nutně vybaven vámi zakoupený model. V takových případech je text označen frází „pouze u vybraných modelů“.

Tyto **Stručné pokyny** vás seznámí se základními schopnostmi a funkcemi nového počítače. Další informace o tom, jak můžete pomocí počítače zvýšit svou produktivitu, naleznete v příručce **AcerSystem User's Guide**. Tato příručka obsahuje podrobné informace týkající se například systémových nástrojů, obnovování dat, možností rozšíření a odstraňování potíží. Dále obsahuje záruční informace, informace týkající se všeobecných předpisů a bezpečnostní upozornění k notebooku. Příručka je k dispozici ve formátu PDF (Portable Document Format) a je již uložena do notebooku. Zobrazíte ji následujícím postupem:

- 1 Klepněte na tlačítko  **Start > Všechny programy > AcerSystem**.
- 2 Klepněte na položku **AcerSystem User's Guide**.



Poznámka: K zobrazení tohoto souboru je vyžadován program Adobe Reader. Pokud v počítači není program Adobe Reader nainstalován, klepnutím na položku **AcerSystem User's Guide** nejprve spustíte instalační program. Dokončete instalaci podle pokynů na obrazovce. Pokyny týkající se používání programu Adobe Reader jsou k dispozici v nabídce **Nápověda a odborná pomoc**.





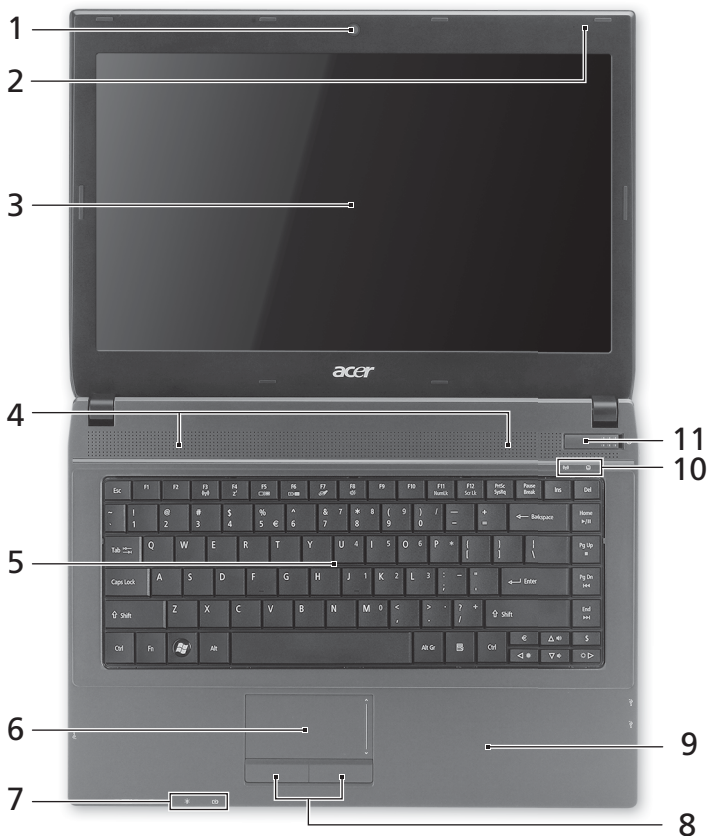

Seznámení s notebookem Acer

Po nastavení počítače podle pokynů zázorněných na letáku vás seznámíme s vaším novým notebookem Acer.

Pohled shora



#	Ikona	Položka	Popis
1		Webová kamera Acer Crystal Eye	Webová kamera pro obrazovou komunikaci (pouze u vybraných modelů).

#	Ikona	Položka	Popis
2		Mikrofon	Interní mikrofon pro nahrávání zvuku.
3		Displej	Na displeji, označovaném také displej z tekutých krystalů (Liquid-Crystal Display; LCD), se zobrazuje grafický výstup počítače (konfigurace se může lišit podle modelu).
4		Reproduktory	Levý a pravý reproduktor zajišťují stereofonní zvukový výstup.
5		Klávesnice	Slouží k zadávání údajů do počítače.
6		Touchpad	Polohovací zařízení citlivé na dotek, které má podobnou funkci jako počítačová myš.
7		Indikátor napájení ¹	Indikuje stav napájení počítače.
		Indikátor baterie ¹	Indikuje stav baterie počítače. 1. Nabíjení: Při nabíjení baterie svítí indikátor jantarově. 2. Plné nabití: V režimu napájení ze sítě svítí indikátor modře.
8		Tlačítka (levé a pravé)	Levé a pravé tlačítko funguje jako levé a pravé tlačítko myši.
9		Podložka ruky	Oblast k pohodlnému opření rukou při používání počítače.
10		Indikátor komunikace	Indikuje stav zařízení pro bezdrátové připojení počítače.
		Indikátor HDD	Svítí, pokud je aktivní pevný disk.
11		Vypínač napájení	Slouží k zapnutí a vypnutí počítače.

1. Stavové indikátory na předním panelu jsou viditelné i po zavření víka počítače.

















Poznámka: Přesná konfigurace počítače závisí na zakoupeném modelu.

Klávesové zkratky

Tento počítač využívá klávesové zkratky nebo kombinace kláves ke zpřístupnění většiny ovládacích prvků počítače, jako je jas zobrazení a hlasitost výstupu.

Klávesovou zkratku aktivujete stisknutím a podržením klávesy <Fn> dříve, než stisknete druhou klávesu této kombinace.

Klávesová zkratka	Ikona	Funkce	Popis
<Fn> + <F3>		Komunikační klávesa	Povoluje / zakazuje komunikační zařízení počítače. (Komunikační zařízení mohou mít různou konfiguraci.)
<Fn> + <F4>		Režim spánku	Slouží k přepnutí počítače do režimu spánku.
<Fn> + <F5>		Přepnutí displeje	Přepíná výstup zobrazení mezi displejem, externím monitorem (pokud je připojen) a oběma zařízeními.
<Fn> + <F6>		Vypnout displej	Slouží k vypnutí podsvícení obrazovky displeje, čímž se ušetří energie. Podsvícení obnovíte stisknutím libovolné klávesy.
<Fn> + <F7>		Přepnutí zařízení touchpad	Slouží k zapnutí a vypnutí interního zařízení touchpad.
<Fn> + <F8>		Přepnutí reproduktoru	Slouží k zapnutí a vypnutí reproduktorů.
<Fn> + <F11>	NumLk	NumLock	Zapnutí nebo vypnutí integrované numerické klávesnice.
<Fn> + <F12>	Scr Lk	Scr Lk	Je-li funkce Scr Lk zapnutá, posune se každým stisknutím ovládacích tlačítek kurzoru nahoru nebo dolů obrazovka o jeden řádek. Funkce Scr Lk nefunguje ve všech programech.
<Fn> + <▷>		Zvýšení jasu	Slouží ke zvýšení jasu obrazovky.
<Fn> + <◁>		Snížení jasu	Slouží ke snížení jasu obrazovky.
<Fn> + <△>		Zvýšení hlasitosti	Slouží ke zvýšení hlasitosti zvuku.
<Fn> + <▽>		Snížení hlasitosti	Slouží ke snížení hlasitosti zvuku.
<Fn> + <Home>		Přehrávat/ Pozastavit	Přehrát nebo pozastavit vybraný mediální soubor.
<Fn> + <Pg Up>		Zastavit	Zastavit přehrávání vybraného mediálního souboru.
<Fn> + <Pg Dn>		Předchozí	Návrat na předchozí mediální soubor.
<Fn> + <End>		Další	Přeskočit na další mediální soubor.





Pohled na zavřenou přední stranu

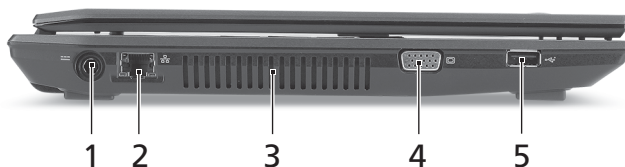

#	Ikona	Položka	Popis
1		Čtečka karet Více v 1	Podporuje karty Secure Digital (SD), MultiMediaCard (MMC), Memory Stick (MS), Memory Stick PRO (MS PRO) a xD-Picture Card (xD). Poznámka: Stisknutím vyjměte nebo vložte kartu. V jednom okamžiku lze použít jen jednu kartu.



Pohled zleva



#	Ikona	Položka	Popis
1		Napájecí konektor	Zajišťuje připojení k síťovému adaptéru.
2		Port Ethernet (RJ-45)	Slouží k připojení počítače k síti Ethernet 10/100/1000.
3		Ventilační otvory	Umožňují chlazení počítače i při dlouhodobém používání.
4		Port externího zobrazovacího zařízení (VGA)	Umožňuje připojení zobrazovacího zařízení (například externího monitoru nebo projektoru LCD).
5		Port USB 2.0	Umožňuje připojení zařízení s rozhraním USB 2.0 (například myš nebo fotoaparát USB).





Pohled zprava



#	Ikona	Položka	Popis
1		Konektor pro připojení sluchátek, reproduktorů nebo zvukového výstupu	Slouží k připojení vnějších výstupních zvukových zařízení (například reproduktorů nebo sluchátek).
2		Port USB 2.0	Umožňuje připojení zařízení s rozhraním USB 2.0 (například myš nebo fotoaparát USB).
3		Optická jednotka	Interní optická jednotka, používá disky CD a DVD.
4		Indikátor přístupu k optickému disku	Svíí, pokud je optická jednotka aktivní.
5		Tlačítko vysunutí optické jednotky	Vysouvá optický disk z jednotky.
6		Otvor pro nouzové vysunutí	Umožňuje vysunutí přihrádky optické jednotky, pokud je počítač vypnutý. Poznámka: Chcete-li vysunout přihrádku optické jednotky, jestliže je počítač vypnutý, vložte do otvoru pro nouzové vysunutí kancelářskou sponku.
7		Patice pro zámek Kensington	Umožňuje připojení počítačového bezpečnostního zámku kompatibilního s typem Kensington.

Pohled zespodu



#	Ikona	Položka	Popis
1		Pozice pro baterii	Zde je uložena baterie počítače.
2		Zámek baterie	Zamkne baterii na místě.
3		Pozice pro pevný disk	Zde je uložen pevný disk počítače (zajištěný šrouby).
4		Pozice pro paměť	Zde je uložena hlavní paměť počítače.
5		Ventilační otvory a ventilátor	Umožňují chlazení počítače i při dlouhodobém používání. Poznámka: Nezakrývejte ani neblokuje otvor ventilátoru.
6		Uvolňovací západka baterie	Uvolňuje baterii k vyjmutí.

Prostředí

- Teplota:
 - Provozní: 5°C až 35°C
 - Neprovozní: -20°C až 65°C
- Vlhkost (nekondenzující):
 - Provozní: 20% až 80%
 - Neprovozní: 20% až 80%

Séria TravelMate 4740/ 4740Z/4340

Stručná príručka

© 2010 Všetky práva vyhradené.

Stručná príručka pre sériu TravelMate 4740/4740Z/4340
Pôvodné vydanie: 03/2010

Prenosný počítač série TravelMate 4740/4740Z/4340

Číslo modelu: _____

Sériové číslo: _____

Dátum zakúpenia: _____

Miesto zakúpenia: _____

Hned' na úvod

Radi by sme vám poďakovali za rozvoj prenosných počítačov Acer – vašej voľby pre svoje mobilné počítačové potreby.

Vaše príručky

Aby sme vám pomohli s používaním prenosného počítača Acer, vytvorili sme pre vás sadu príručiek:

V prvom rade plagát, ktorý vám pomôže začať s nastavením počítača.

Dokument **Všeobecná príručka pre sériu TravelMate** obsahuje užitočné informácie týkajúce sa všetkých modelov v produktovom rade TravelMate. Obsahuje základné témy, ako napríklad informácie o používaní klávesnice, zvuku atď. Majte teda na pamäti, že **Všeobecná používateľská príručka** ako aj **Používateľská príručka AcerSystem**, ktorá je spomenutá ďalej, občas obsahujú informácie o funkciách a vlastnostiach, ktorými sú vybavené iba určité modely produktovej série, a model, ktorý ste si zakúpili, nimi nemusí byť vybavený. Opis takýchto funkcií je v texte označený poznámkou v zmysle „len pre určité modely“.

Obsahom dokumentu **Stručná príručka** sú základné funkcie a vlastnosti vášho nového počítača. Informácie o tom, ako vám počítač pomôže byť produktívnejší, nájdete v dokumente **Používateľská príručka AcerSystem**. Táto príručka obsahuje podrobné informácie o systémových programoch, oprave dát, možnostiach rozšírenia a riešenie problémov. Okrem toho obsahuje informácie o záruke a všeobecne vyhlásenia k predpisom a bezpečnosti. Je dostupná vo formáte PDF a je umiestnená vo vašom prenosnom počítači. Ak si chcete pozrieť jej obsah, postupujte podľa nasledovných krokov:

- 1 Kliknite na  **Štart > Všetky programy > AcerSystem**.
- 2 Kliknite na **AcerSystem User's Guide**.



.....

Poznámka: Na prezeranie súboru je potrebný program Adobe Reader. Ak na vašom počítači nie je program Adobe Reader nainštalovaný, kliknutím na **AcerSystem User's Guide** sa najprv spustí inštalácia programu Adobe Reader. Inštaláciu dokončíte podľa pokynov, ktoré uvidíte na obrazovke. Pokyny na používanie programu Adobe Reader nájdete v ponuke **Pomocník a Podpora**.





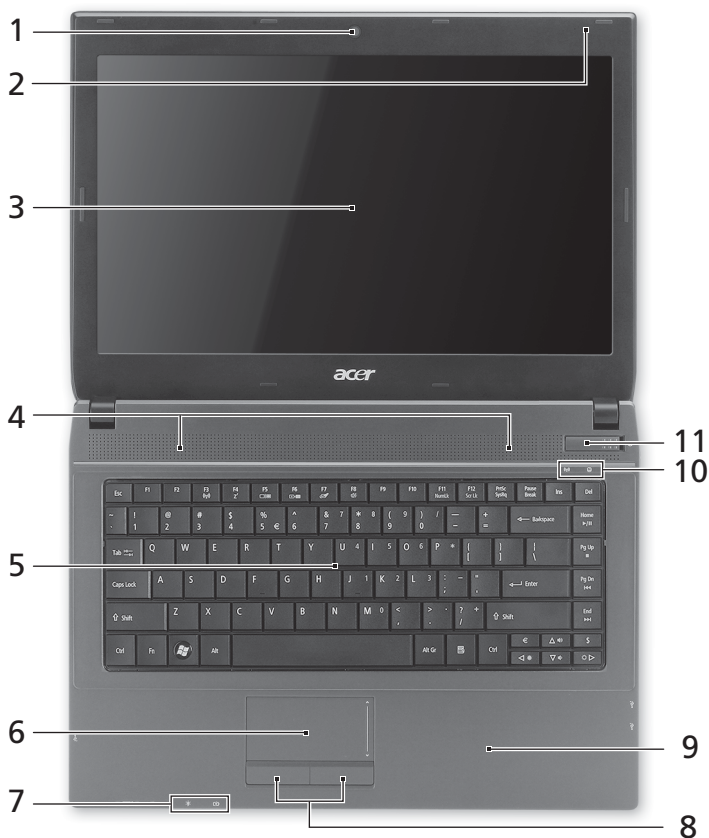

Zoznámte sa so svojím prenosným počítačom Acer

Po nastavení počítača podľa letáku nám dovoľte, aby sme vás zoznámili s vaším novým prenosným počítačom Acer.

Pohľad zhora



#	Ikona	Položka	Popis
1		Webkamera Acer Crystal Eye	Webová kamera na video komunikáciu (len určité modely).

#	Ikona	Položka	Popis
2		Mikrofón	Interný mikrofón na nahrávanie zvuku.
3		Obrazovka	Nazýva sa tiež Liquid-Crystal Display (LCD), zobrazuje výstup z počítača (konfigurácia sa môže v závislosti od modelu líšiť).
4		Reproduktory	Ľavý a pravý reproduktor poskytujúci stereo audio výstup.
5		Klávesnica	Služi na zadávanie údajov do počítača.
6		Dotyková plocha	Zariadenie s citlivosťou na dotyk, ktoré funguje ako počítačová myš.
7		Kontrolka napájania ¹	Signalizuje stav napájania počítača.
		Kontrolka batérie ¹	Signalizuje stav batérie počítača. 1. Nabíjanie: Pri nabíjaní batérie svieti žltá. 2. Nabité: V režime AC svieti modrá.
8		Tlačidlá na klikanie (ľavé a pravé)	Funkcia ľavého a pravého tlačidla je podobná ako funkcia ľavého a pravého tlačidla myši.
9		Podložka rúk	Pohodlná opora rúk pri práci s počítačom.
10		Kontrolka komunikácie	Signalizuje stav zariadenia na bezdrôtovú komunikáciu v počítači.
		Kontrolka pevného disku	Svieti, keď je jednotka pevného disku aktívna.
11		hlavný vypínač	Zapína a vypína počítač.

1. Kontrolky na prednom paneli sú viditeľné, aj keď je veko počítača zatvorené.

















.....

Poznámka: Presná konfigurácia počítača závisí od zakúpeného modelu.

Klávesové skratky

Počítač využíva klávesové skratky alebo kombinácie klávesov na prístup k väčšine nastavení počítača, ako je napríklad jas obrazovky a hlasitosť výstupu.

Ak chcete aktivovať klávesové skratky, stlačte a podržte kláves **<Fn>** pred stlačením ďalšieho klávesu v klávesovej skratke.

Klávesová skratka	Ikona	Funkcia	Popis
<Fn> + <F3>		Kláves komunikácie	Zapína a vypína komunikačné zariadenia počítača. (Komunikačné zariadenia sa môžu líšiť v závislosti od konfigurácie.)
<Fn> + <F4>		Režim spánku	Prepne počítač do režimu spánku.
<Fn> + <F5>		Prepínanie zobrazenia	Prepína výstup zobrazenia – obrazovka, externý monitor (ak je pripojený) a obidva súčasne.
<Fn> + <F6>		Vypnutie obrazovky	Vypína podsvietenie obrazovky kvôli úspore energie. Pre návrat stlačte akýkoľvek kláves.
<Fn> + <F7>		Prepínanie dotykovej plochy	Zapína a vypína internú dotykovú plochu.
<Fn> + <F8>		Prepínanie reproduktora	Zapína a vypína reproduktory.
<Fn> + <F11>	NumLk	NumLock	Zapína a vypína zabudovanú číselnú klávesnicu.
<Fn> + <F12>	Scr Lk	Scroll Lock	Ak je Scroll Lock zapnutý, obrazovka sa pri stlačení kurzorových kláves nahor a nadol posunie o jeden riadok. Scroll Lock nefunguje v niektorých aplikáciách.
<Fn> + <▷>		Zvýšenie jasu	Zvyšuje jas obrazovky.
<Fn> + <◁>		Zníženie jasu	Znižuje jas obrazovky.
<Fn> + <△>		Zvýšenie hlasitosti	Zvyšuje hlasitosť zvuku.
<Fn> + <▽>		Zníženie hlasitosti	Znižuje hlasitosť zvuku.
<Fn> + <Home>		Prehrať/pauza	Prehrávanie alebo pozastavenie vybraného súboru média.
<Fn> + <Pg Up>		Zastaviť	Zastavenie prehrávania vybraného súboru média.
<Fn> + <Pg Dn>		Predch.	Návrat na predchádzajúci súbor média.
<Fn> + <End>		Ďalej	Preskočenie na nasledujúci súbor média.





Pohľad spredu (zatvorený)

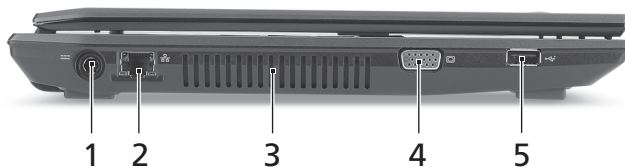

#	Ikona	Položka	Popis
1		Čítačka kariet Multi-in-1	Podporuje karty Secure Digital (SD), MultiMediaCard (MMC), Memory Stick (MS), Memory Stick PRO (MS PRO) a xD-Picture Card (xD). Poznámka: Stlačením vytiahnete/vložíte kartu. Nie je možné pracovať s viacerými kartami naraz.





Pohľad zľava



#	Ikona	Položka	Popis
1		Konektor vstupu jednosmerného napätia	Pripojenie adaptéra striedavého napätia.
2		Port siete Ethernet (RJ-45)	Pripojenie k sieti Ethernet 10/100/1000.
3		Otvory na ventiláciu	Pomáha udržať pri dlhom používaní počítač chladný.
4		Port externej obrazovky (VGA)	Pripojenie zobrazovacieho zariadenia (napr. externého monitora, LCD projektora).
5		Port USB 2.0	Pripojenie zariadení cez rozhranie USB 2.0 (napr. USB myš, USB fotoaparát).





Pohľad sprava

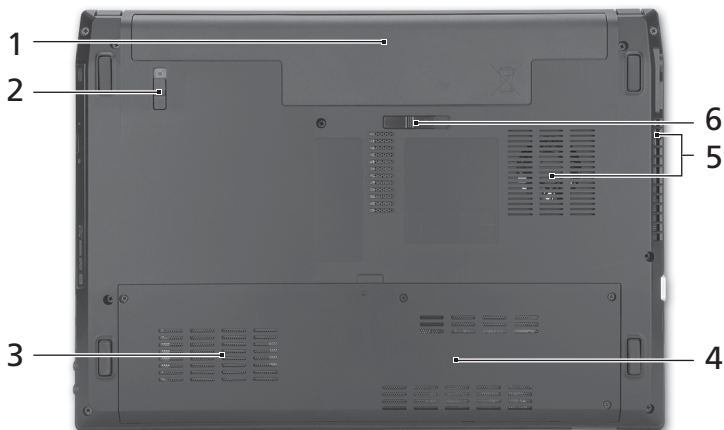

#	Ikona	Položka	Popis
1		Konektor na slúchadlá/ reproduktor/ audio výstup	Výstup zvuku do zvukových zariadení (napr. reproduktorov, slúchadiel).
		Konektor mikrofónu	Slúži na vstup zvuku z externých mikrofónov.
2		Port USB 2.0	Pripojenie zariadení cez rozhranie USB 2.0 (napr. USB myš, USB fotoaparát).
3		Optická mechanika	Interná optická mechanika na CD alebo DVD disky.
4		Indikátor prístupu na optický disk	Svieti, keď je optická mechanika aktívna.
5		Tlačidlo vysúvania optickej mechaniky	Vysúva optický disk z jednotky.
6		Otvor núdzového vysúvania	Vysúva optickú mechaniku pri vypnutom počítači. Poznámka: Keď je počítač vypnutý, optickú jednotku vysuniete zasunutím kancelárskej sponky do núdzového otvoru.
7		Zásuvka na zámok Kensington	Pripojenie počítačového bezpečnostného kľúča Kensington.

Pohľad zdola



#	Ikona	Položka	Popis
1		Jednotka batérie	Slúži na uloženie batérie počítača.
2		Zámok batérie	Uzamyká batériu na jej mieste.
3		Jednotka pevného disku	Slúži na uchytenie pevného disku počítača (zaistené skrutkami).
4		Pozícia pre pamäť	Tu je uložená hlavná pamäť počítača.
5		Otvory na ventiláciu a ventilátor chladenia	Pomáha udržať pri dlhom používaní počítač chladný. Poznámka: Neuzatvárajte ani neupchávajte otvor ventilátora.
6		Západka uvoľnenia batérie	Slúži na uvoľnenie batérie pri jej vyberaní.

Prostredie

- Teplota:
 - Prevádzková: 5°C až 35°C
 - Mimoprevádzková: -20°C až 65°C
- Vlhkosť (nekondenzačná):
 - Prevádzková: 20% až 80%
 - Mimoprevádzková: 20% až 80%

Seriya TravelMate 4740/ 4740Z/4340

Hitri vodič

© 2010 Vse pravice pridržane.

Hitri vodič za serijo TravelMate 4740/4740Z/4340
Originalna izdaja: 03/2010

Prenosni računalnik serije TravelMate 4740/4740Z/4340

Številka modela: _____

Serijska številka: _____

Datum nakupa: _____

Mesto nakupa: _____

Začnimo pri začetku

Želimo se vam zahvaliti, ker ste za zadovoljevanje prenosnih računalniških potreb izbrali prenosnik Acer.

Vaša navodila

Za pomoč pri uporabi vašega prenosnika Acer, smo izdelali paket navodil:

Plakat vam bo pomagal pri začetni nastavitvi računalnika.

Natisnjeni splošni **uporabniški priročnik serije TravelMate** vsebuje uporabne informacije, ki veljajo za vse modele serije izdelkov TravelMate. Pokriva osnovne teme, kot so uporaba tipkovnice, nastavitve zvoka itd. Prosimo, da upoštevate, da bosta se **splošni uporabniški priročnik** kot tudi **uporabniški priročnik AcerSystem** omenjen spodaj, zaradi svoje splošne narave včasih nanašala na funkcije ali lastnosti, ki jih imajo le nekateri modeli iz serije, ne pa nujno tudi model, ki ste ga kupili. Takšni primeri so označeni z napisom „velja le za določene modele“.

Hitri vodič vsebuje osnovne funkcije vašega novega računalnika. Za več informacije o tem kako vam lahko računalnik pomaga postati bolj produktivne, prosimo glejte uporabniški priročnik **AcerSystem**. Ta navodila vsebujejo podrobne informacije o sistemskih pripomočkih, obnovi podatkov, možnostih razširitve in odpravljanju težav. Poleg tega vsebuje garancijske informacije in splošne uredbe in varnostna obvestila za vaš prenosnik. Navodila so na voljo v obliki prenosnega dokumenta (PDF) in so naložena na vaš prenosnik. Da bi ga našli, sledite naslednjim korakom:

- 1 Kliknite  **Start > Vse programi > AcerSystem**.
- 2 Kliknite na **Uporabniški priročnik AcerSystem**.



Opomba: Za pregledovanje datoteke potrebujete Adobe Reader. Če Adobe Reader ni nameščen na računalnik se bo zagnal namestitveni program Adobe Reader, ko kliknete na **uporabniški priročnik AcerSystem**. Za zaključek postopka sledite navodilom na zaslonu. Za navodila o uporabi Adobe Reader, odprite meni **Pomoč in podpora**.





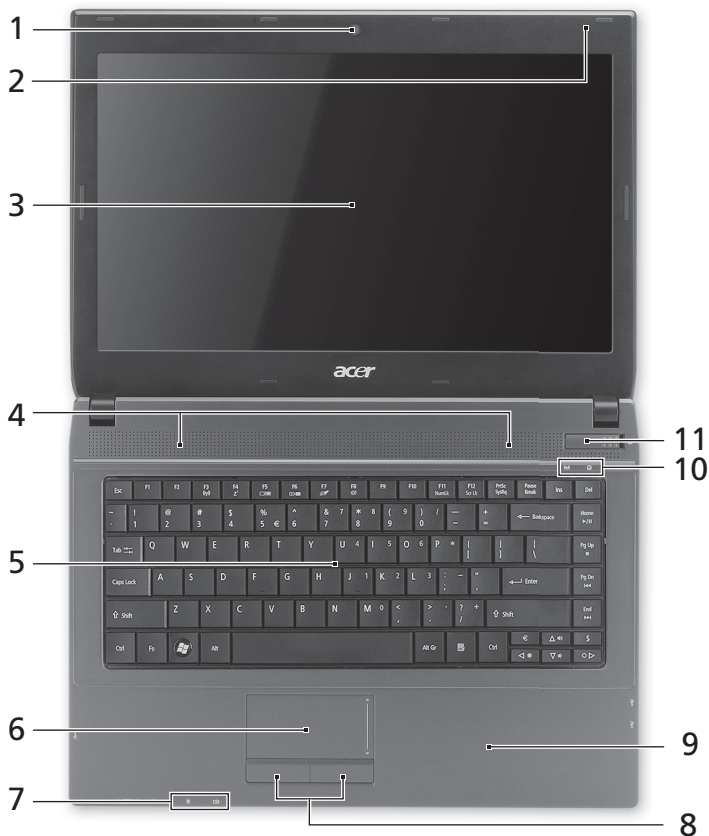

Vodič po vašem prenosniku Acer

Ko ste nastavili računalnik, kot je prikazano na plakatu, dovolite, da vam predstavimo vaš novi prenosnik Acer.

Pogled od zgoraj



#	Ikona	Predmet	Opis
1		Integrirana spletna kamera Acer Crystal Eye	Spletna kamera za video komunikacijo (le na določenih modelih).

#	Ikona	Predmet	Opis
2		Mikrofon	Notranji mikrofon za snemanje zvoka.
3		Zaslon	Takoimenovani zaslon s tekočimi kristali (LCD), prikazuje izhod vašega računalnika (konfiguracija je za različne modele različna).
4		Zvočniki	Levi in desni zvočnik nudita stereo zvočni izhod.
5		Tipkovnica	Za vnos podatkov v računalnik.
6		Sledilna plošča	Na dotik občutljiva naprava, ki deluje kot računalniška miška.
7		Indikator stanja napajanja ¹	Označuje stanje napajanja računalnika.
		Indikator stanja baterije ¹	Označuje stanje baterije računalnika. 1. Polnjenje: Lučka sveti rumenkasto rjavo, ko se baterija polni. 2. V celoti napolnjena: V načinu AC lučka sveti modro.
8		Tipke (levo in desno)	Leva in desna tipka deluje kot leva in desna tipka na miški.
9		Podpora za dlan	Udobna podpora za vaše roke, ko uporabljate računalnik.
10		Indikator komunikacije	Označuje stanje naprave za brezžično povezavo.
		Indikator trdega diska	Označuje, ko je trdi disk aktiven.
11		Gumb za vklop/izklop	Vklop in izklop računalnika.

1. Indikatorji na sprednji plošči so vidni tudi, ko je pokrov računalnika zaprt.

















Opomba: Dejanska konfiguracija vašega računalnika je odvisna od kupljenega modela.

Vročé tipke

Računalnik uporablja vroče tipke ali kombinacijo tipk za dostop do računalniških nastavitev kot sta svetlost zaslona in glasnost.

Za aktiviranje vročih tipk pritisnite in držite tipko **<Fn>** preden pritisnete drugo tipko v kombinaciji.

Bližnjica	Ikona	Funkcija	Opis
<Fn> + <F3>		Komunikacijska tipka	Omogoči/onemogoči komunikacijske naprave računalnika. (Komunikacijske naprave se lahko razlikujejo po konfiguraciji.)
<Fn> + <F4>		Mirovanje	Preklopi računalnik v stanje mirovanja.
<Fn> + <F5>		Preklop zaslona	Preklopi izhod zaslona med zaslonom, zunanjim monitorjem (če je priključen) in obema.
<Fn> + <F6>		Izklop zaslona	Izključi luč zaslona za varčevanje z energijo. Pritisnite poljubno tipko za vrnitev.
<Fn> + <F7>		Preklop sledilne plošče	Vključi in izključi notranjo sledilno ploščo.
<Fn> + <F8>		Preklop zvočnikov	Vklop in izklop zvočnikov.
<Fn> + <F11>	NumLk	NumLock	Vključite ali izključite vgrajeno številčnico.
<Fn> + <F12>	Scr Lk	Scroll Lock	Ko je tipka Scroll Lock vključena se zaslon pomika gor in dol za eno vrstico, ko pritisnete smerne tipke za pomikanje gor in dol. Tipka Scroll Lock ne deluje v nekaterih programih.
<Fn> + <▷>		Poveča svetlost	Poveča svetlost zaslona.
<Fn> + <◁>		Zmanjša svetlost	Zmanjša svetlost zaslona.
<Fn> + <△>		Povečanje glasnosti	Poveča glasnost zvoka.
<Fn> + <▽>		Zmanjšanje glasnosti	Zmanjša glasnost zvoka.
<Fn> + <Home>		Predvajaj/ Premor	Predvaja ali zaustavi izbrano medijski datoteko.
<Fn> + <Pg Up>		Ustavi	Zaustavi predvajanje izbrane medijske datoteke.
<Fn> + <Pg Dn>		Predhodni	Vrnitev na predhodno medijsko datoteko.
<Fn> + <End>		Naslednji	Skok na naslednjo medijsko datoteko.

Zaprto pogled od spredaj



#	Ikona	Predmet	Opis
1		Čitalec kartic več-v-1	<p>Sprejema Secure Digital (SD), MultiMediaCard (MMC), Memory Stick (MS), Memory Stick Pro (MS PRO), in xD-kartico za fotografije.</p> <p>Opomba: Pritisnite, da bi odstranili/vstavili kartico. Naenkrat lahko uporabljate le eno kartico.</p>



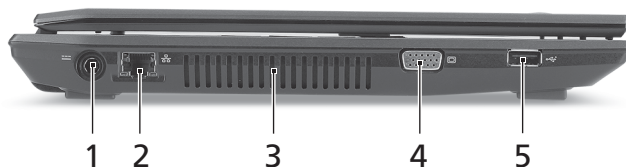

Pogled iz leve strani



#	Ikona	Predmet	Opis
1		Priključek napajalnika	Priključek na AC napajalnik.
2		Priključek Ethernet (RJ-45)	Priključek na omrežja Ethernet 10/100/1000.
3		Reže za prezračevanje	Omogočajo, da računalnik ostane hladen tudi po dolgotrajni uporabi.
4		Priključek za zunanji zaslon (VGA)	Priključevanje na prikazovalno napravo (npr. zunanji monitor, projektor LCD).
5		Vrata USB 2.0	Priključek za naprave USB 2.0 (npr., USB miška, USB fotoaparati).





Pogled iz desne strani

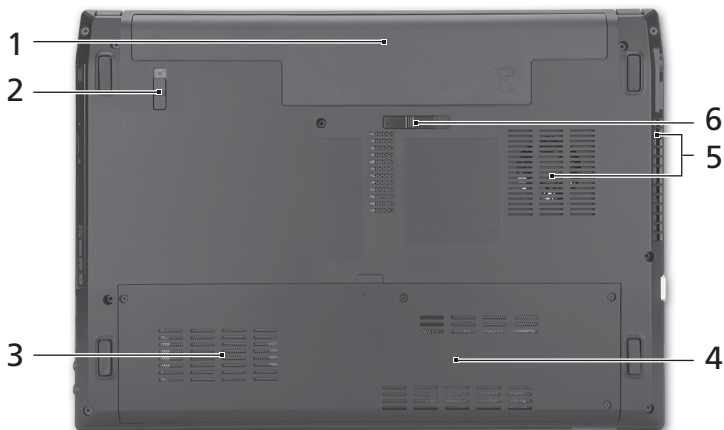

#	Ikona	Predmet	Opis
1		Vtičnica za slušalke/ zvočnik/napravo	Priključek za avdio naprave (npr. zvočniki, slušalke).
		Vtičnica za mikrofون	Sprejema vhode iz zunanjih mikrofonov.
2		Vrata USB 2.0	Priključek za naprave USB 2.0 (npr., USB miška, USB fotoaparati).
3		Optični pogon	Notranji optični pogon; sprejema CD-je ali DVD-je.
4		Pokazatelj dostopa do optičnega diska	Zasveti, ko je optični pogon aktiven.
5		Tipka za izvreči optični pogon	Izvrže optični disk iz pogona.
6		Luknja za izvržbo v nujnem primeru	Izvrže pladenj optičnega pogona, ko je računalnik izključen. Opomba: Vstavite sponko v luknjo za izvržbo v nujnem primeru, da izvržete pladenj optičnega pogona, ko je računalnik izključen.
7		Reža za zaklep Kensington	Priključek za Kensington združljivo računalniško ključavnico.

Pogled od spodaj



#	Ikona	Predmet	Opis
1		Nosilec za baterijo	Hrani baterijo računalnika.
2		Zaklep za baterijo	Zaklene baterijo na mesto.
3		Nosilec trdega diska	V njem je nameščen trdi disk računalnika (pritrjen z vijaki).
4		Razdelek za pomnilnik	Hrani glavni spomin računalnika.
5		Reže za prezračevanje in hladilni ventilator	Omogočajo, da računalnik ostane hladen tudi po dolgotrajni uporabi. Opomba: Odprtine ventilatorja ne prekrivajte ali zapirajte.
6		Zapah za sprostitve baterije	Sprostitev baterije za odstranjevanje.

Okolje

- Temperatura:
 - Delovanje: od 5°C do 35°C
 - Mirovanje: od -20°C do 65°C
- Vlažnost (brez kondenza):
 - Delovanje: od 20% do 80%
 - Mirovanje: od 20% do 80%

TravelMate 4740/4740Z/4340 serije

Kratki vodič

© 2010 Sva prava pridržana.

TravelMate 4740/4740Z/4340 serije - kratki vodič
Izvorno izdanje: 03/2010

TravelMate 4740/4740Z/4340 serije prijenosno osobno računalo

Broj modela: _____

Serijski broj: _____

Datum kupovine: _____

Mjesto kupovine: _____

Prvo osnovne stvari

Željeli bismo vam zahvaliti na izboru Acer prijenosnog računala koje će vam poslužiti kamo god krenuli.

Vaši vodiči

Kako bismo vam pomogli pri uporabi Vašeg Acer prijenosnog računala, kreirali smo skup vodiča:

Na samom početku, poster vam pomaže u postavljanju vašeg računala.

Opći priručnik za korisnike TravelMate serije sadrži korisne informacije koje se odnose na sve modele proizvođača TravelMate serije. Priručnik obuhvaća osnovne teme poput uporabe tipkovnice i zvuka i slično. Obratite pažnju na činjenicu kako zbog načina izdanja **Opći priručnik za korisnike** kao i **AcerSystem priručnik za korisnike** koji su navedeni dolje, ponekad navode obilježja ili funkcije koje su dostupne samo na određenim modelima serije, što ne znači da su dostupni i na modelu koji ste kupili. U takvim slučajevima bit će naveden tekst poput "samo za određene modele".

Kratki vodič upoznaje vas s osnovnim obilježjima i funkcijama vašeg novog računala. Više informacija o tome kako vam računalo može povećati produktivnost, molimo, pogledajte **AcerSystem Korisnički vodič**. Priručnik sadrži detaljne informacije o temama kao što su uslužni programi sustava, vraćanje podataka, opcije za proširivanje i rješavanje problema. Nadalje, sadrži informacije o jamstvima i osnovne obavijesti o propisima i sigurnosti za vaš prijenosnik. Priručnik je dostupan u Portable Document Formatu (PDF), a dolazi i snimljen na prijenosnik. Za pristup priručniku, učinite sljedeće:

- 1 Kliknite na  **Početak > Svi programi > AcerSystem**.
- 2 Kliknite na **AcerSystem korisnički vodič**.



.....

Napomena: Za pregled dokumenta potreban je Adobe Reader. Ako na računalu nemate instaliran Adobe Reader, klik na **AcerSystem korisnički vodič** najprije će pokrenuti program za instalaciju Adobe Readera. Slijedite upute na zaslonu da biste završili instalaciju. Za upute kako koristiti Adobe Reader, pristupite izborniku **Pomoć i podrška**.





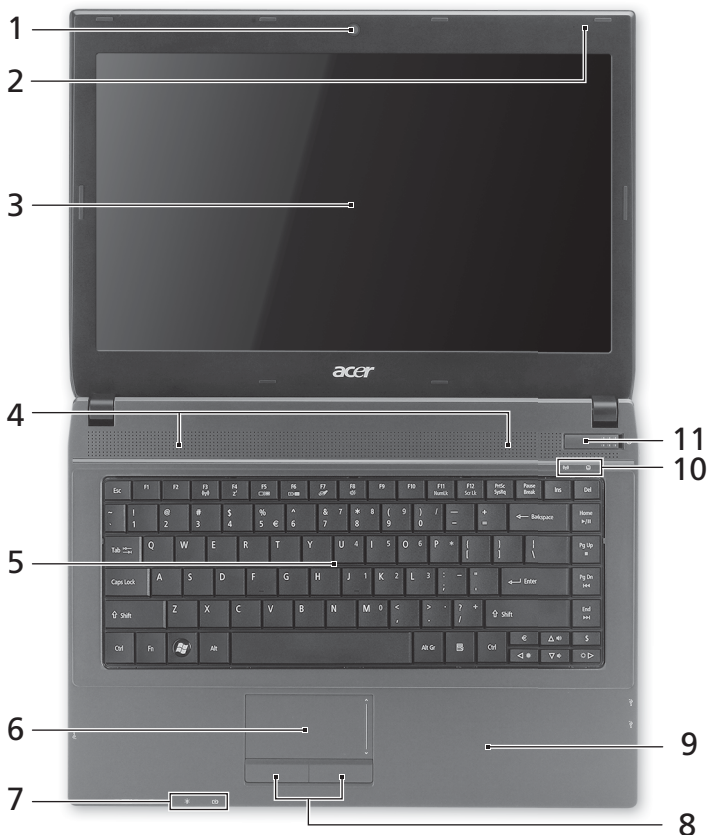

Upoznajte Vaš Acer prijenosnik

Nakon postavljanja vašeg računala kao što je ilustrirano posterom, dopustite nam da Vas upoznamo s Vašim novim Acer prijenosnikom.

Pogled odozgo



#	Ikona	Stavka	Opis
1		Acer Crystal Eye web kamera	Web kamera za video komunikaciju (samo određeni modeli).

#	Ikona	Stavka	Opis
2		Mikrofon	Unutarnji mikrofon za snimanje zvuka.
3		Zaslon prikaza	Naziva se i Liquid-Crystal Display (LCD zaslon), a prikazuje izlazne podatke računala (konfiguracija se može razlikovati ovisno o modelu).
4		Zvučnici	Lijevi i desni zvučnik pružaju stereo audio izlaz.
5		Tipkovnica	Za unos podataka u vaše računalo.
6		Dodirna ploča	Pokazivački uređaj osjetljiv na dodir koji funkcionira kao računalni miš.
7		Indikator napajanja ¹	Pokazuje stanje napajanja računala.
		Indikator baterije ¹	<p>Pokazuje stanje baterije računala.</p> <p>1. Punjenje: Svijetli žuto kada se baterija puni.</p> <p>2. Sasvim napunjeno: Svijetli plavo kada radi na izmjeničnom napajanju.</p>
8		Tipke za klikanje (lijeva i desna)	Lijeva i desna tipka funkcionira kao lijeva i desna tipka miša.
9		Oslonac za dlanove	Udobno područje koje pruža potporu rukama dok koristite računalo.
10		Indikator komunikacije	Pokazuje status uređaja za bežično spajanje računala.
		HDD indikator	Pokazuje kada je pogon tvrdog diska aktivan.
11		Glavni prekidač	Uključuje i isključuje računalo.

1. Indikatori na prednjoj ploči su vidljivi čak i kada je poklopac računala zatvoren.

















Napomena: Točna konfiguracija vašeg računala ovisi o kupljenom modelu.

Vruće tipke

Računalo koristi "vruće" tipke ili kombinacije tipki za pristup većini upravljačkih tipki računala, kao što je osvjetljenost zaslona i izlazna glasnoća.

Za aktiviranje „vruće“ tipke, pritisnite i držite **<Fn>** tipku prije pritiskanja druge tipke u kombinaciji "vrućih" tipki.

„Vruća“ tipka	Ikona	Funkcija	Opis
<Fn> + <F3>		Tipka za komunikaciju	Omogućava / onemogućava komunikacijske uređaje računala. (Komunikacijski uređaji razlikuju se prema konfiguraciji.)
<Fn> + <F4>		Stanje mirovanja	Stavlja računalo u stanja mirovanja.
<Fn> + <F5>		Prekidač prikaza	Prebacuje izlaz prikaza između zaslona prikaza, vanjskog monitora (ako je priključen) i oba.
<Fn> + <F6>		Isključivanje zaslona	Isključuje pozadinsko osvjetljenje zaslona prikaza radi uštede energije. Pritisnite bilo koju tipku za povrat.
<Fn> + <F7>		Prekidač dodirne ploče	Uključuje i isključuje unutarnju dodirnu ploču.
<Fn> + <F8>		Prekidač zvučnika	Uključuje i isključuje zvučnike.
<Fn> + <F11>	NumLk	NumLock	Uključuje ili isključuje uklopljenu numeričku tipkovnicu.
<Fn> + <F12>	Scr Lk	Scroll Lock	Kada je Scroll Lock uključen, zaslon se pomiče jednu liniju gore ili dolje prilikom pritiska na tipku sa strelicom prema gore ili dolje. Scroll Lock ne radi s nekim aplikacijama.
<Fn> + <D>		Povećanje osvjetljenosti	Povećava osvjetljenost zaslona.
<Fn> + <C>		Smanjivanje osvjetljenosti	Smanjuje osvjetljenost zaslona.
<Fn> + <Δ>		Pojačavanje glasnoće	Pojačava glasnoću zvuka.
<Fn> + <▽>		Smanjivanje glasnoće	Smanjuje glasnoću zvuka.
<Fn> + <Home>		Reprodukcija/pauza	Izvodi ili zaustavlja izvođenje odabrane medijske datoteke.
<Fn> + <Pg Up>		Zaustavi	Zaustavlja izvođenje odabrane medijske datoteke.
<Fn> + <Pg Dn>		Prethodno	Povrat na prethodnu medijsku datoteku.
<Fn> + <End>		Sljedeća	Skok na sljedeću medijsku datoteku.

Pogled sprijeda izbliza



#	Ikona	Stavka	Opis
1		Više-u-1 čitač kartica	Prihvaća Secure Digital (SD), MultiMediaCard (MMC), Memory Stick (MS), Memory Stick PRO (MS PRO), xD-Picture Card (xD) kartice. Napomena: Gurnite za uklanjanje/postavljanje kartice. Istodobno u pogonu možete koristiti samo jednu kartica.



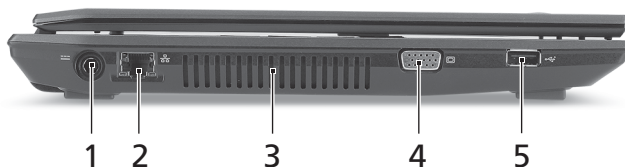

Pogled s lijeve strane



#	Ikona	Stavka	Opis
1		DC-in utičnica	Povezuje se s AC adapterom.
2		Ethernet (RJ-45) priključak	Povezuje se na Ethernet 10/100/1000-baziranu mrežu.
3		Utori za prozračivanje	Omogućavaju rashlađivanje računala i prilikom dugotrajne uporabe.
4		Priključak vanjskog ekrana (VGA)	Povezuje se sa uređajem za prikaz (npr. vanjskim monitorom, LCD projektorom).
5		USB 2.0 priključak	Povezuje se s USB 2.0 uređajima (primjerice USB miš, USB kamera).





Pogled s desne strane



#	Ikona	Stavka	Opis
1		Utičnica za slušalice/zvučnike/line-out	Povezuje se sa line-out audio uređajima (npr. zvučnicima, slušalicama).
		Utičnica za mikrofona	Prihvaća ulaze iz vanjskih mikrofona.
2		USB 2.0 priključak	Povezuje se s USB 2.0 uređajima (primjerice USB miš, USB kamera).
3		Optički pogon	Unutarnji optički pogon; prihvaća CD-e ili DVD-e.
4		Indikator pristupa optičkom disku	Svijetli kada je optički pogon aktivan.
5		Gumb za izbacivanje optičkog pogona	Izbacuje optički disk iz pogona.
6		Otvor za izbacivanje u slučaju nužde	Izbacuje ladicu optičkog pogona kada je računalo isključeno. Napomena: Umetnite spajalicu za papir u otvor za izbacivanje u slučaju nužde kako bi izbacili ladicu optičkog pogona kada je računalo isključeno.
7		Utor za Kensington bravu	Povezuje se s Kensington - kompatibilnom računalnom sigurnosnom bravom.

Pogled odozdo



#	Ikona	Stavka	Opis
1		Prostor za bateriju	Sadrži baterijski komplet računala.
2		Brava baterije	Zaključava bateriju u njen položaj.
3		Prostor za tvrdi disk	Sadrži čvrsti disk računala (učvršćen vijcima).
4		Odjeljak za memoriju	Sadrži glavnu memoriju računala.
5		Utori za provjetranje i ventilator za hlađenje	Omogućavaju rashlađivanje računala i prilikom dugotrajne uporabe. Napomena: Ne prekrivajte i ničim ne blokirajte otvor ventilatora.
6		Bravica za oslobađanje baterije	Oslobađa bateriju radi uklanjanja.

Okruženje

- Temperatura:
 - Radna: 5°C do 35°C
 - Pohrana: -20°C do 65°C
- Vlažnost (nekondenzirajuća):
 - Radna: 20% do 80%
 - Pohrana: 20% do 80%

Seria TravelMate 4740/ 4740Z/4340

Ghid rapid

© 2010 Toate drepturile rezervate.

Ghid rapid seria TravelMate 4740/4740Z/4340

Prima ediție: 03/2010

Notebook seria TravelMate 4740/4740Z/4340

Numărul modelului: _____

Numărul seriei: _____

Data achiziției: _____

Locul achiziției: _____

Înainte de toate

Dorim să vă mulțumim că ați ales un computer portabil Acer pentru a răspunde nevoilor dvs de procesare mobilă.

Ghidurile dumneavoastră

Pentru a vă ajuta să folosiți computerul portabil Acer, am conceput un set de ghiduri:

Mai întâi, afișul vă ajută să începeți configurarea computerului.

Ghidul general de utilizare pentru seria TravelMate conține informații utile, valabile pentru toate modelele din gama TravelMate. Acesta acoperă subiecte de bază, cum ar fi utilizarea tastaturii și a sistemului audio etc. Vă rugăm să rețineți că **Ghidul general de utilizare**, precum și **Ghidul utilizatorului AcerSystem** menționate mai jos au fost concepute de așa natură încât să se refere ocazional la funcții sau caracteristici care sunt incluse doar în anumite modele ale seriei și nu neapărat în modelul cumpărat de dumneavoastră. Astfel de cazuri sunt marcate în manuale prin texte cum ar fi „doar pentru anumite modele”.

Ghidul rapid tipărit vă prezintă caracteristicile și funcțiile de bază ale noului dvs. computer. Pentru mai multe informații privind modul în care computerul vă poate ajuta să fiți mai productiv, consultați **Ghidul utilizatorului AcerSystem**. Acest ghid conține informații detaliate despre astfel de subiecte, precum utilitățile de sistem, recuperarea datelor, opțiunile de extensie și depanarea. În plus, acesta conține informații despre garanție, reglementări generale și note de siguranță pentru computerul dvs portabil. Este disponibil în Format de document portabil (PDF) și vine preîncărcat pe computerul dvs. portabil. Urmați acești pași pentru a-l accesa:

- 1 Dați clic pe  **Start > Toate programele > AcerSystem**.
- 2 Faceți clic pe **Ghidul utilizatorului AcerSystem**.





Notă: Vizualizarea fișierului necesită Adobe Reader. Dacă Adobe Reader nu este instalat pe computerul dvs., faceți clic pe **Ghidul utilizatorului AcerSystem** și se va executa mai întâi programul de configurare Adobe Reader. Pentru a încheia instalarea, urmați instrucțiunile de pe ecran. Pentru instrucțiuni privind modul de utilizare a Adobe Reader, accesați meniul **Ajutor și asistență**.



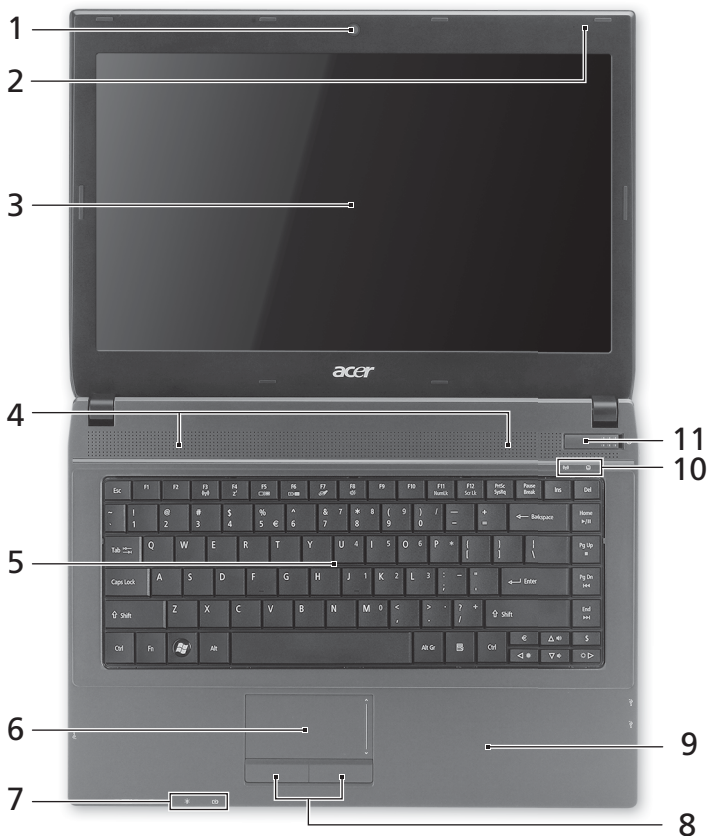

Turul computerului dvs Acer

După configurarea computerului, așa cum se arată în afișul, permiteți-ne să vă prezentăm computerul portabil Acer.

Vedere de sus



#	Pictogramă	Element	Descriere
1		Cameră web Acer Crystal Eye	Cameră Web pentru comunicație video (doar pentru anumite model).
2		Microfon	Microfon intern pentru înregistrarea sunetului.

#	Pictogramă	Element	Descriere
3		Ecran de afișaj	Mai este numit și Afișaj cu cristale lichide (LCD) și afișează activitatea computerului (configurația poate diferi în funcție de model).
4		Difuzoare	Difuzoarele din stânga și dreapta redau sunetul stereo.
5		Tastatură	Pentru introducerea datelor în computer.
6		Zona de atingere	Dispozitiv de indicare sensibil la atingere care funcționează ca un mouse de computer.
7		Indicator de alimentare ¹	Indică nivelul de alimentare al computerului.
		Indicator baterie ¹	Indică starea bateriei computerului. 1. Încărcare: Lumina este portocalie atunci când acumulatorul se încarcă. 2. Complet încărcat: Lumina este albastră în modul c.a.
8		Butoane clic (stânga și dreapta)	Butoanele stânga și dreapta funcționează ca butoanele stânga și dreapta ale mousei.
9		Placă pentru sprijinirea palmei	Zonă confortabilă de sprijin pentru mână atunci când folosiți computerul.
10		Indicator comunicare	Indică starea dispozitivului de conectare wireless.
		Indicator HDD	Indică atunci când unitatea de harddisc este activă.
11		Înterupător de pornire/oprire	Pornește și oprește computerul.

1. Indicatoarele de pe panoul frontal sunt vizibile chiar și când capacul computerului este închis.

















Notă: Configurația exactă a computerului depinde de modelul achiziționat.

Taste rapide

Computerul folosește tastele rapide sau combinațiile de taste pentru a accesa majoritatea comenzilor precum luminozitatea ecranului și volumul.

Pentru a activa tastele rapide, apăsați și mențineți tasta **<Fn>** înainte de a apăsa cealaltă tastă din combinația de tastă rapidă.

Tastă rapidă	Pictogramă	Funcție	Descriere
<Fn> + <F3>		Tastă pentru comunicații	Activează / dezactivează dispozitivele de comunicație ale computerului. (Dispozitivele de comunicație pot diferi în funcție de model).
<Fn> + <F4>		Repaus	Pune computerul în modul Repaus.
<Fn> + <F5>		Comutare afișaj	Comută afișajul între ecran de afișaj, monitor extern (dacă este conectat) și ambele.
<Fn> + <F6>		Oprire afișaj	Oprește lumina de fundal a ecranului pentru a economisi energie. Apăsați orice tastă pentru reveni.
<Fn> + <F7>		Comutare zonă de atingere	Activează și dezactivează zona de atingere.
<Fn> + <F8>		Comutare difuzor	Pornește și oprește difuzoarele.
<Fn> + <F11>	NumLk	NumLock	Pornește sau oprește tastatura numerică încorporată.
<Fn> + <F12>	Scr Lk	Scroll Lock	Când tasta Scroll Lock este activă, ecranul se deplasează cu un rând în sus sau în jos atunci când apăsați tastele săgeată sus sau săgeată jos. Scroll Lock nu funcționează cu anumite aplicații.
<Fn> + <▷>		Luminozitate mărită	Mărește luminozitatea afișajului.
<Fn> + <◁>		Luminozitate scăzută	Reduce luminozitatea afișajului.
<Fn> + <△>		Volum mărit	Mărește volumul sunetului.
<Fn> + <▽>		Volum scăzut	Reduce volumul sunetului.
<Fn> + <Home>		Redare/Pauză	Redă sau oprește temporar fișierul media selectat.
<Fn> + <Pg Up>		Oprire	Oprește redarea fișierului media selectat.
<Fn> + <Pg Dn>		Anterior	Revine la fișierul media anterior.
<Fn> + <End>		Următorul	Trece la următorul fișier media.





Vedere din față de aproape

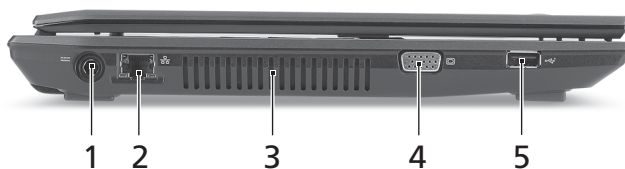

#	Pictogramă	Element	Descriere
1		Cititor de cartele multi-in-1	Acceptă carduri Secure Digital (SD), MultiMediaCard (MMC), Memory Stick (MS), Memory Stick PRO (MS PRO) și xD-Picture Card. Notă: Apăsați pentru a extrage/a instala cardul. Nu poate fi citit decât un singur card o dată.





Vedere din stânga



#	Pictogramă	Element	Descriere
1		Mufă c.c. intrare	Conectează la un adaptor de c.a.
2		Port Ethernet (RJ-45)	Conectează la o rețea Ethernet 10/100/1000.
3		Orificii de aerisire	Permit computerului să rămână rece, chiar și după utilizarea prelungită.
4		Port pentru afișaj extern (VGA)	Conectează la un dispozitiv de afișare (de ex. monitor extern, proiector LCD).
5		Port USB 2.0	Conexiune pentru dispozitivele USB 2.0 (de ex. maus USB, cameră USB).





Vedere din dreapta

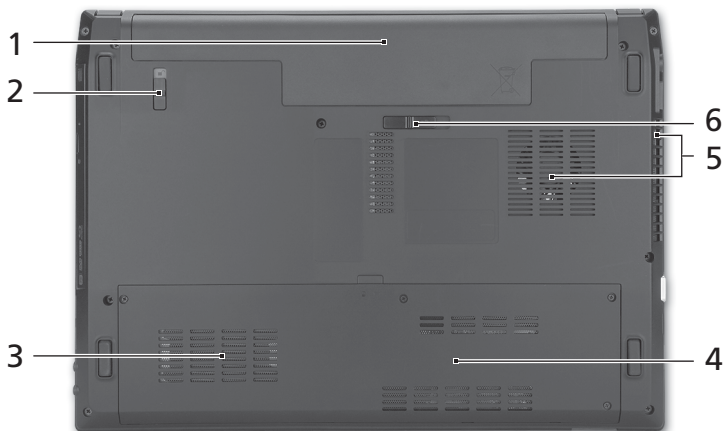

#	Pictogramă	Element	Descriere
1		Mufă de căști/ difuzor/ieșire	Conectează la dispozitivele audio de ieșire (de ex. difuzoare, căști).
		Mufă microfon	Acceptă intrări de la microfoane externe.
2		Port USB 2.0	Conexiune pentru dispozitivele USB 2.0 (de ex. mouse USB, cameră USB).
3		Unitate optică	Unitate optică internă, acceptă CD-uri sau DVD-uri.
4		Indicator de acces la discul optic	Se aprinde când unitatea optică este activă.
5		Buton de eliminarea unitate optică	Elimină discul optic din unitate.
6		Orificiu de eliminarea de urgență	Elimină tava unității optice când computerul este oprit. Notă: Introduceți o bucată de hârtie în orificiul de eliminarea de urgență pentru a elimina tava unității optice când computerul este oprit.
7		Slot de blocare Kensington	Conectează la un dispozitiv de securitate pentru computer compatibil Kensington.

Vedere bază



#	Pictogramă	Element	Descriere
1		Nișa pentru acumulator	Adăpostește setul de acumulatori ai computerului.
2		Blocaj acumulator	Blochează acumulatorul în poziție.
3		Nișa unitate de harddisc	Adăpostește unitatea de harddisc a computerului (fixată cu șuruburi).
4		Compartiment de memorie	Adăpostește memoria principală a computerului.
5		Orificii de ventilație și ventilator de răcire	Permit computerului să rămână rece, chiar și după utilizarea prelungită. Notă: Nu acoperiți și nu obstrucționați deschiderea ventilatorului.
6		Zăvor de eliberare a acumulatorului.	Eliberează acumulatorul pentru a fi scos.

Mediu

- Temperatură:
 - Funcționare: 5°C - 35°C
 - Nefuncționare: -20°C - 65°C
- Umiditate (fără condensare):
 - Funcționare: 20% - 80%
 - Nefuncționare: 20% - 80%

Серия TravelMate 4740/ 4740Z/4340

Кратко ръководство

© 2010 Всички права запазени.

Кратко ръководство за Серия TravelMate 4740/4740Z/4340

Първоначално издание: 03/2010

Серия TravelMate 4740/4740Z/4340 Персонален ноутбук

Модел номер: _____

Сериен номер: _____

Дата на закупуване: _____

Място на закупуване: _____

Преди всичко

Бихме желали да Ви благодарим, че сте избрали ноутбук на Acer за Вашите нужди в областта на мобилните компютри.

Вашите ръководства

За да Ви помогнем при употребата на Вашия ноутбук Acer, ние изготвихме следните ръководства:

Първо, постерът Ви помага с началните настройки на компютъра.

Общо ръководство на сериите TravelMate съдържа информация, която е валидна за всички модели в продуктите серии TravelMate product. Покрива основни теми като използване на клавиатура, аудио и др. Важно е да знаете, че поради обобщаващия си характер, **Универсалното потребителско ръководство**, както и упоменатото по-долу **Потребителско ръководство AcerSystem**, на места разглеждат функции и възможности, които са налични само за конкретни модели от сериите, без това да означава, че са налични за модела, който сте закупили. Тези случаи са отбелязани в текста със забележки като "само за някои модели".

Кратко ръководство представя основните функции и възможности на Вашия нов компютър. За повече информация как Вашият компютър може да Ви помогне да сте по-продуктивни, моля вижте **Потребителското ръководство AcerSystem**. То съдържа подробна информация за теми като системни инструменти, възстановяване на данни, опции за ъпгрейд и решаване на проблеми. В допълнение, то съдържа и гаранционна информация, както и основните наредби и бележки за безопасност, свързани с Вашия ноутбук. То е в PDF формат (Portable Document Format) и е предварително заредено на ноутбука Ви. За да го отворите, следвайте тези стъпки:

- 1 Щракнете върху  **Start (Старт) > All Programs (Всички програми) > AcerSystem.**
- 2 Щракнете на **AcerSystem User Guide** (Потребителско ръководство AcerSystem).





Забележка: За да отворите файла, Ви е нужен Adobe Reader. Ако Adobe Reader не е инсталиран на компютъра Ви, щракнете върху **Потребителското ръководство AcerSystem**. Първо ще се стартира инсталационната програма на Adobe Reader. Следвайте инструкциите на екрана, за да извършите инсталацията. За инструкции как се използва Adobe Reader, отворете менюто **Помощ и поддръжка**.



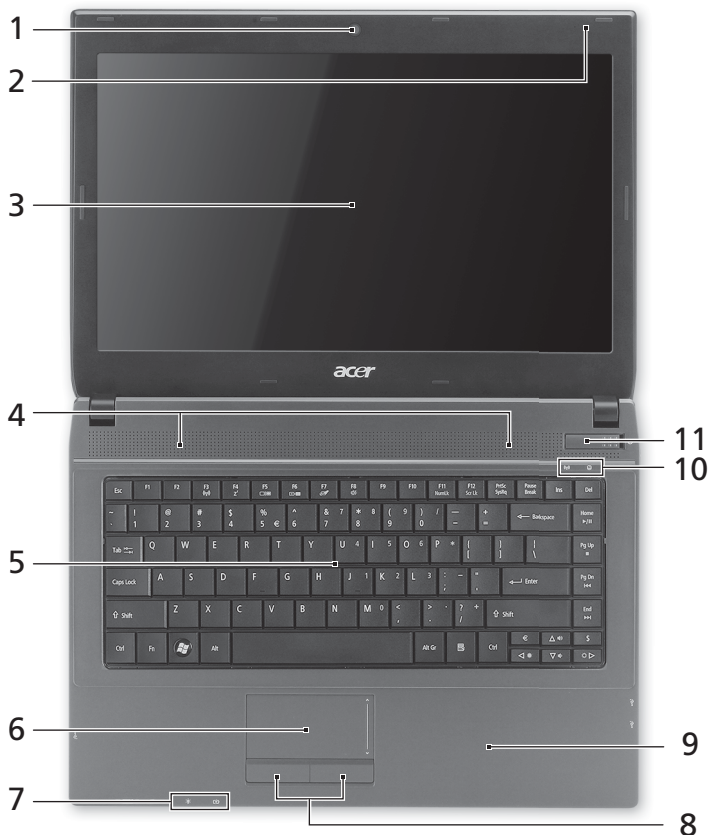

Преглед на Вашия ноутбук Асер

След като настроите компютъра си, както е показано в постера, ще ви покажем какво прави и какво има вашият нов ноутбук Асер.

Изглед отгоре



#	Икона	Обект	Описание
1		Уеб камера Acer Crystal Eye	Уеб камера за видео комуникация (само за определени модели).
2		Микрофон	Вграден микрофон за запис на звук.

#	Икона	Обект	Описание
3		Дисплей	Нарича се още "Течнокристален дисплей" (LCD) и е екранът на компютъра (конфигурацията може да се различава в зависимост от модела).
4		Високоговорители	Ляв и десен високоговорител за възпроизвеждане на стерео звук.
5		Клавиатура	Служи за въвеждане на данни в компютъра Ви.
6		Тъчпад	Чувствително на допир посочващо устройство, което функционира като компютърна мишка.
7		Индикатор на захранването ¹	Показва статуса на захранване на компютъра.
		Индикатор за нивото на батерията ¹	<p>Посочва статуса на батерията на компютъра.</p> <p>1. Зареждане: Индикаторът свети в жълто, докато батерията се зарежда.</p> <p>2. Напълно заредена: Индикаторът свети в синьо, когато сте в режим AC.</p>
8		Бутони за щракане (ляв и десен)	Левият и десният бутони функционират като ляв и десен бутон на мишка.
9		Подложка за длани	Удобно място, на което да поставите ръцете си, когато използвате компютъра.
10		Индикатор за комуникации	Посочва статуса на устройството за безжична връзка на компютъра.
		Индикатор на твърдия диск	Посочва дали твърдият диск е активен.
11		Бутон за включване и изключване	С него компютърът се включва и изключва.

1. Индикаторите на предния панел остават видими дори когато капакът на компютъра е затворен.



Забележка: Точната конфигурация на Вашия компютър зависи от това кой модел сте закупили.

Бързи клавиши

Компютърът има "бързи клавиши" - клавишни комбинации за бърз достъп до повечето от контролите му, като например яркост на дисплея и сила на звук.

За да активирате бързите клавиши, натиснете и задръжте клавиша **<Fn>** преди да натиснете другия клавиш от комбинацията.

Бърз клавиш	Икона	Функция	Описание
<Fn> + <F3>		Клавиш за комуникации	Включва/изключва устройствата за комуникация на компютъра. (Устройствата за комуникация може да варират според конфигурацията).
<Fn> + <F4>		Заспиване	Вкарва компютъра в режим Sleep (Заспиване).
<Fn> + <F5>		Превключване на дисплей	Превключва активния дисплей между екрана, външния монитор (ако е свързан такъв), или двете.
<Fn> + <F6>		Изкл. дисплей	Изключва задното осветление на екрана, за да пести енергия. Натиснете който и да е клавиш, за да го включите отново.
<Fn> + <F7>		Превключване на тъчада	Включва и изключва тъчада.
<Fn> + <F8>		Превключване на високоговорителите	Включва и изключва високоговорителите.
<Fn> + <F11>	NumLk	NumLock	Включва/изключва вградената цифрова клавиатура.
<Fn> + <F12>	Scr Lk	Scroll Lock	Когато включите Scroll Lock, екранът се мести с един ред нагоре или надолу, когато натиснете стрелката нагоре или надолу. Scroll Lock не работи във всички приложения.
<Fn> + <▷>		Засилване на яркостта	Увеличава яркостта на екрана.
<Fn> + <◁>		Намаляване на яркостта	Намалява яркостта на екрана.
<Fn> + <△>		Засилване на звука	Усилва силата на звука.
<Fn> + <▽>		Намаляване на звука	Намалява силата на звука.
<Fn> + <Home>		Възпроизвеждане/ Пауза	Възпроизвеждане или пауза за избрания мултимедиен файл.
<Fn> + <Pg Up>		Стоп	Спира възпроизвеждането на избрания мултимедиен файл.

Бърз клавиш	Икона	Функция	Описание
<Fn> + <Pg Dn>	⏪	Предишен	Връщане към предишен мултимедиен файл.
<Fn> + <End>	⏩	Напред	Прескачане до следващия мултимедиен файл.

Преден изглед при затворен лаптоп



#	Икона	Обект	Описание
1		Четец на карти Много-в-1	Чете Secure Digital (SD), MultiMediaCard (MMC), Memory Stick (MS), Memory Stick PRO (MS PRO) и xD Picture Card (xD). Забележка: Натиснете, за да извадите/деинсталирате картата. Само една карта може да работи едновременно.

Изглед отляво

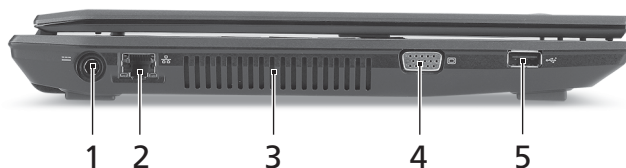

#	Икона	Обект	Описание
1		Жак за DC вход	За връзка с AC адаптер.
2		Порт за Ethernet (RJ-45)	За връзка с мрежа, базирана на Ethernet 10/100/1000.
3		Вентилационни отвори	Позволява на компютъра да се охлажда дори и при продължителна употреба.
4		Порт за външен дисплей (VGA)	За връзка с дисплейно устройство (напр. външен монитор, LCD проектор).
5		USB 2.0 порт	За свързване на USB 2.0 устройства (напр. USB мишки, USB камери).





Изглед отдясно



#	Икона	Обект	Описание
1		Жак за изход/ слушалки/колони	За връзка с изходни аудио устройства (напр. високоговорители, слушалки).
		Жак за микрофон	Приема входящ сигнал от външни микрофони.
2		USB 2.0 порт	За свързване на USB 2.0 устройства (напр. USB мишки, USB камери).
3		Оптично устройство	Вътрешно оптично устройство; чете CD или DVD.
4		Индикатор за достъп до оптичен диск	Светва, когато оптичното устройство е активно.
5		Бутон за отваряне на оптичното устройство	Изважда оптичния диск от устройството.
6		Дупка за спешно изваждане	Вади оптичния диск, когато компютърът е изключен. Забележка: Пъхнете кламер в отвора за спешно изваждане, за да извадите подноса на оптичното устройство, докато компютърът е изключен.
7		Слот за заключващ механизъм Kensington	За връзка с Kensington-съвместим компютърен заключващ механизъм.

Изглед отдолу



#	Икона	Обект	Описание
1		Отделение за батерии	Тук се поставя батерийният модул на компютъра.
2		Придържащ механизъм на батерията	Държи батерията на мястото ѝ.
3		Отделение за твърдия диск	Тук стои твърдият диск на компютъра (прикрепен с винтове).
4		Отделение за памет	Тук се поставя главната памет на компютъра.
5		Вентилационни слотове и охлаждащ вентилатор	Позволява на компютъра да се охлажда дори и при продължителна употреба. Забележка: Не покривайте и не блокирайте отвора на вентилатора.
6		Езиче за освобождаване на батерията	Освобождава батерията, за да можете да я извадите.

Работна среда

- Температура:
 - Работна: 5°C до 35°C
 - За съхранение: -20°C до 65°C
 - Влажност (без кондензация):
 - Работна: 20% до 80%
 - За съхранение: 20% до 80%
-

TravelMate 4740/4740Z/4340 seeria

Lühijuhend

© 2010 Kõik õigused kaitstud.

TravelMate 4740/4740Z/4340 seeria lühijuhend
Originaalväljaanne: 03/2010

TravelMate 4740/4740Z/4340 seeria sülearvuti

Mudeli number: _____

Seerianumber: _____

Ostukuupäev: _____

Ostukoht: _____

Tähtsamad asjad kõigepealt

Täname teid, et valisite oma kaasaskantavaks arvutiks Aceri sülearvuti.

Teie teejuhid

Et aidata Teil kasutada oma Acer'i sülearvutit, oleme loonud komplekti juhiseid:

Kõigepealt aitab poster teil alustada oma arvuti häälestamist.

TravelMate seeria üldkasutusjuhend sisaldab kõigile TravelMate tooteseeria mudelitele kohalduvat kasulikku teavet. See katab põhilisi teemasid nagu klaviatuuri kasutamine, heli jne. Palume mõista, et tulenevalt nende loomusest viitavad nii **Üldkasutusjuhend** kui ka allpool mainitud **AcerSystemi kasutusjuhend** aeg-ajalt funktsioonidele või omadustele, mis on ainult teatud seeria mudelitel, kuid mitte tingimata Teie ostetud mudelil. Sellised juhtumid on tekstis märgitud väljenditega nagu „ainult teatud mudelitel”.

Trükitud **Lühijuhend** tutvustab Teile uue arvuti põhilisi omadusi ja funktsioone. Kui soovite rohkem teada saada, kuidas arvuti aitab Teil produktiivsem olla, vaadake **AcerSystemi kasutusjuhendit**. Teatmik sisaldab täpsemat informatsiooni teemadel nagu süsteemiutiliidid, andmete taastamine, laiendusvõimalused ja probleemide lahendamine. Sellele lisaks sisaldab see garantiiteavet ning slearvuti kohta kehtivaid ldiseid regulatsioone ja ohutuseeskirju. See on saadaval PDF-formaadis (Portable Document Format) ning on laaditud teie slearvutisse. Juhised selle avamiseks:

- 1 Klõpsake  **Start > Kõik programmid > AcerSystem**.
- 2 Klõpsake suvandil **AcerSystemi kasutusjuhend**.



.....

Märkus: Faili vaatamiseks on vaja Adobe Reader'it. Kui Adobe Reader pole arvutisse installitud, käivitab **AcerSystemi kasutusjuhend** kõigepealt Adobe Readeri installimisprogrammi. Installimise lõpetamiseks järgige ekraanil olevaid juhiseid. Juhiseid Adobe Readeri kasutamiseks leiate menüüst **Spikker ja tugi**.





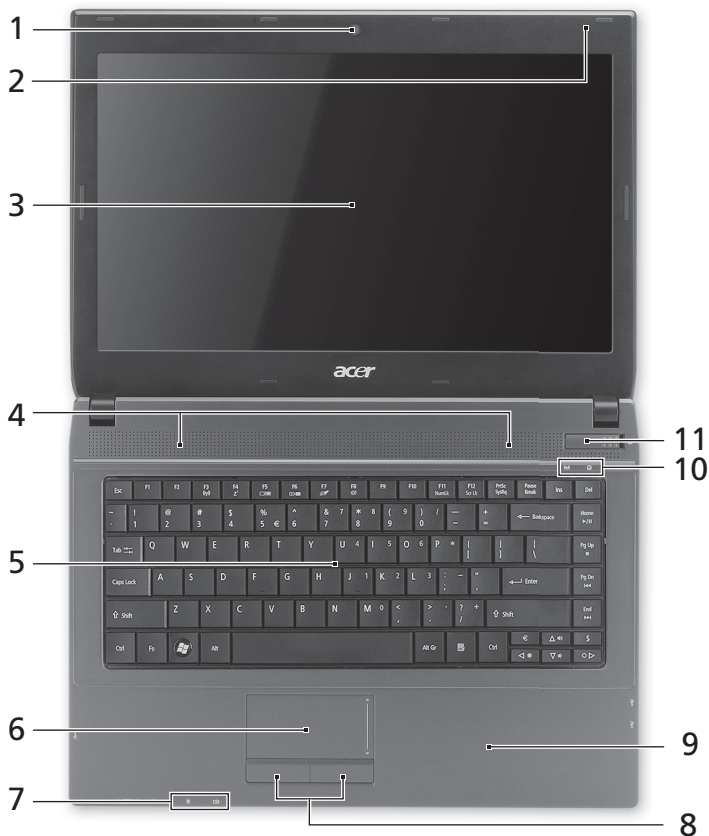

Teie Acer sülearvuti ülevaade

Kui olete oma arvuti häälestanud postlil kujutatud viisil, lubage meil teile tutvustada teie uut Acer sülearvutit.

Pealtvaade



#	Ikon	Objekt	Kirjeldus
1		Veebikaamera Acer Crystal Eye	Veebikaamera videosuhtluseks (ainult teatud mudelitel).

#	Icoon	Objekt	Kirjeldus
2		Mikrofon	Sisseehitatud mikrofon heli salvestamiseks.
3		Kuvariekraan	Teise nimega vedelkristallekraan (LCD), kuvab arvuti pilti (mudeli konfiguratsioon võib erineda).
4		Kõlarid	Vasak- ja parempoolne kõlar, toodavad stereoheli.
5		Klaviatuur	Andmete sisestamiseks arvutisse.
6		Puuteplaat	Puutetundlik osutusseadis, mis töötab arvutihiirena.
7		Vooluindikaator ¹	Näitab arvuti olekut.
		Akuindikaator ¹	Näitab arvuti aku olekut. 1. Laadimine: kui akut laetakse, on tuli kollakat värvi. 2. Täielikult laetud: kui arvuti on vooluvõrgus, on tuli sinist värvi.
8		Klõpsunupud (vasem ja parem)	Vasak ja parem nupp funktsioneerivad vasaku ja parema hiirenupuna.
9		Randmetugi	Mugav toetusala, kuhu saate arvutit kasutades toetada oma käsi.
10		Ühenduse indikaator	Näitab arvuti traadita ühenduse seadme olekut.
		Kõvakettaindikaator	Näitab kõvaketta aktiivsust.
11		Toitelüliti	Arvuti sisse- ja väljalülitamiseks.

1. Esipaneelil asuvad indikaatorid on nähtavad ka siis, kui arvuti kaas on suletud.

















.....
Märkus: Arvuti täpne konfiguratsioon sõltub ostetud mudelist.

Kiirklahvid

Arvutil on enamiku seadete jaoks (nt ekraani heledus, heliväljund) olemas kiirklahvid ja klahvikombinatsioonid.

Kiirklahvide aktiveerimiseks vajutage ning hoidke enne teise kombinatsiooni kuuluva klahvi vajutamist all klahvi **<Fn>**.

Kiirklahv	Ikon	Funktsioon	Kirjeldus
<Fn> + <F3>		Sideklahv	Aktiveerib/desaktiveerib arvuti sideseadmed. (Sideseadmed võivad vastavalt konfiguratsioonile erineda.)
<Fn> + <F4>		Unerežiim	Lülitab arvuti unerežiimi.
<Fn> + <F5>		Ekraani valik	Lülitab ekraanipildi kuvaekraanile, välisele ekraanile (kui see on ühendatud) või mõlemale.
<Fn> + <F6>		Ekraan välja	Lülitab ekraani tagantvalgustuse energia säästmiseks välja. Tagasipöördumiseks vajutage suvalisele klahvile.
<Fn> + <F7>		Puuteplaadi lülititi	Lülitab integreeritud puuteplaadi sisse või välja.
<Fn> + <F8>		Kõlarilülititi	Lülitab kõlarid sisse või välja.
<Fn> + <F11>	NumLk	NumLock	Lülitab sisseehitatud numbriklahvistiku sisse või välja.
<Fn> + <F12>	Scr Lk	Scroll Lock	Kui Scroll Lock (kerimislukk) on sees, liigub ekraan nool-üles või nool-alla klahvile vajutades rea võrra üles või alla. Mõnedes rakendusprogrammides kerimislukk ei tööta.
<Fn> + <▷>		Heledus üles	Suurendab ekraani heledust.
<Fn> + <◁>		Heledus alla	Vähendab ekraani heledust.
<Fn> + <△>		Helitugevus üles	Tõstab helitugevust.
<Fn> + <▽>		Helitugevus alla	Langetab helitugevust.
<Fn> + <Home>		Esita/paus	Esitab või peatab valitud meediumifaili.
<Fn> + <Pg Up>		Lõpeta	Lõpetab valitud meediumifaili esitamise.
<Fn> + <Pg Dn>		Eelmine	Pöördu tagasi eelmise meediumifaili juurde.
<Fn> + <End>		Järgmine	Liigub edasi järgmise meediumifaili juurde.





Suletud eestvaade

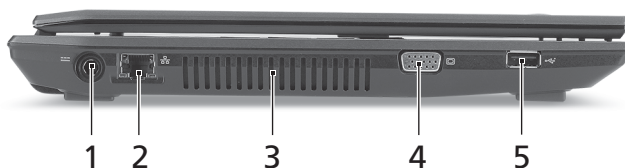

#	Ikoon	Objekt	Kirjeldus
1		Mitu-ühes kaardilugeja	Võtab vastu Secure Digital (SD), MultiMediaCard (MMC), Memory Stick (MS), Memory Stick PRO (MS PRO) ja xD-Picture kaarte (xD). Märkus: Kaardi eemaldamiseks/paigaldamiseks vajutage sellele. Korraga saab töötada ainult üks kaart.





Vaade vasakult



#	Ikoon	Objekt	Kirjeldus
1		Alalisvoolusisendi pistik	Vahelduvvooluadapteri (toiteploki) ühendamiseks.
2		Etherneti (RJ-45) port	Ethernet 10/100/1000-põhise võrguga ühendamiseks.
3		Ventilatsiooniavad	Võimaldavad arvutil püsida jahedana ka pärast pikaajalist kasutamist.
4		Välise kuvari (VGA) port	Kuvaseadme ühendamiseks (nt väline monitor, LCD-projektor).
5		USB 2.0 port	USB 2.0 seadmete ühendamiseks (nt USB-hiir või USB-kaamera).

Vaade paremalt



#	Ikoon	Objekt	Kirjeldus
1		Kõrvaklappide/ kõlarite/ heliväljundi pistik	Heliväljundseadmete ühendamiseks (nt kõlarid, kõrvaklapid).
		Mikrofonisisend	Võtab vastu sisendeheli välisest mikrofonist.
2		USB 2.0 port	USB 2.0 seadmete ühendamiseks (nt USB-hiir või USB-kaamera).
3		Optiline seade	Sisemine optiline seade; loeb CD-sid või DVD-sid.
4		Optilise ketta lugemise indikaator	Süttib, kui optiline seade on aktiivne.
5		Optilise seadme väljastusnupp	Väljastab optilise ketta seadmest.
6		Hädaväljastusava	Avab optilise seadme sahtli, kui arvuti on välja lülitatud. Märkus: Optilise seadme avamiseks siis, kui arvuti on välja lülitatud, lükake hädaväljastusavasse kirjaklamber.
7		Kensington-luku pesa	Kensington-tüüpi arvuti turvaluku ühendamiseks.

Põhjjavaade

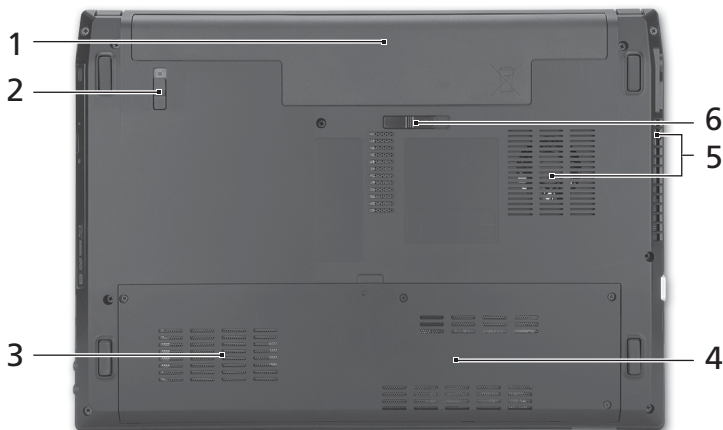

#	Ikoon	Objekt	Kirjeldus
1		Akusektsioon	Siin asuvad arvuti akud.
2		Akulukk	Lukustab aku kohale.
3		Kõvakettasektsioon	Siin asub arvuti kõvaketas (kinnitatud kruvidega).
4		Mälusahtel	Siin asub arvuti põhimälu.
5		Ventilatsioonivavad ning jahutusventilaator	Võimaldavad arvutil püsida jahedana ka pärast pikaajalist kasutamist. Märkus: Ärge katke või blokeerige ventilaatori avasid.
6		Aku vabastamise riiv	Vabastab aku, et seda saaks välja võtta.

Keskkond

- Temperatuur:
 - Töötamiseks sobiv: 5 kuni 35°C
 - Sobimatu: -20 kuni 65°C
- Niiskus (mittekondenseeruv):
 - Töötamiseks sobiv: 20 kuni 80%
 - Sobimatu: 20 kuni 80%

TravelMate 4740/4740Z/4340 sērija

Ātrais ceļvedis

© 2010 Visas tiesības aizsargātas.

TravelMate 4740/4740Z/4340 sērijas ātrais ceļvedis
Oriģinālizdevums: 03/2010

TravelMate 4740/4740Z/4340 sērijas piezīmjdators

Modeļa numurs: _____

Sērijas numurs: _____

Pirkuma datums: _____

Pirkuma vieta: _____

Galvenais vispirms

Mēs vēlamies jums pateikties, ka esat izvēlējies Acer piezīmjdatoru, lai nodrošinātu savas mobilās skaitļošanas vajadzības.

Jūsu rokasgrāmatas

Lai palīdzētu jums lietot Acer piezīmjdatoru, esam sagatavojuši rokasgrāmatu komplektu:

Pirmkārt, attēls jums palīdz sagatavot datoru darbam.

TravelMate vispārējais lietotāja ceļvedis satur noderīgu informāciju, kas attiecas uz visiem TravelMate produktu sērijas modeļiem. Tas aptver pamata tematiku, tādu kā tastatūras un audio izmantošana utt. Lūdzu, saprotiet, ka **vispārējais lietotāja ceļvedis**, kā arī **AcerSystem lietotāja ceļvedis**, kas pieminēts turpmāk, to būtības dēļ laiku pa laikam attiecas uz funkcijām vai līdzekļiem, kas piemīt tikai noteiktiem sērijas modeļiem, bet ne obligāti modelim, ko esat iegādājies. Šādi gadījumi tekstā ir apzīmēti ar vārdiem „tikai noteiktiem modeļiem”.

Ātrais ceļvedis sniedz ieskatu par jūsu jaunā datora galvenajiem līdzekļiem un funkcijām. Lai uzzinātu vairāk, kā jūsu dators jums var palīdzēt būt vēl produktīvākam, lūdzu, skatiet **AcerSystem lietotāja ceļvedi**. Šajā ceļvedī ir detalizēta informācija par tādām tēmām kā sistēmas utilitās, datu atkopšana, paplašināšanas opcijas un problēmu novēršana. Bez tam tajā ir iekļauta informācija par garantijām un piezīmjdatora lietošanas vispārīgas regulas un drošības paziņojumi. Tas ir pieejams PDF (Portable Document Format - portatīvā dokumenta formāts) formātā un ir iepriekš ielādēts jūsu piezīmjdatorā. Veiciet šīs darbības, lai tam piekļūtu:

1. Noklikšķiniet uz  **Start (Sākt) > All Programs (Visas programmas) > AcerSystem.**
2. Noklikšķiniet uz **AcerSystem User Guide (AcerSystem lietotāja ceļvedis).**



Piezīme: lai skatītu failu, nepieciešama programma Adobe Reader. Ja jūsu datorā nav instalēta programma Adobe Reader, pirmo reizi noklikšķinot uz **AcerSystem User Guide (AcerSystem lietotāja ceļvedis)**, , automātiski tiks palaista programmas Adobe Reader instalēšana. Lai pabeigtu instalēšanu, izpildiet ekrānā redzamos norādījumus. Lai iegūtu norādījumus, kā lietot programmu Adobe Reader, piekļūstiet izvēlnei **Help and Support (Palīdzība un atbalsts)**.

Acer piezīmjdatora pārskats

Ja esat sagatavojis datoru darbam kā redzams attēlā, ļaujiet mums jūs iepazīstināt ar jūsu jauno Acer piezīmjdatoru.

Skats no augšpuses

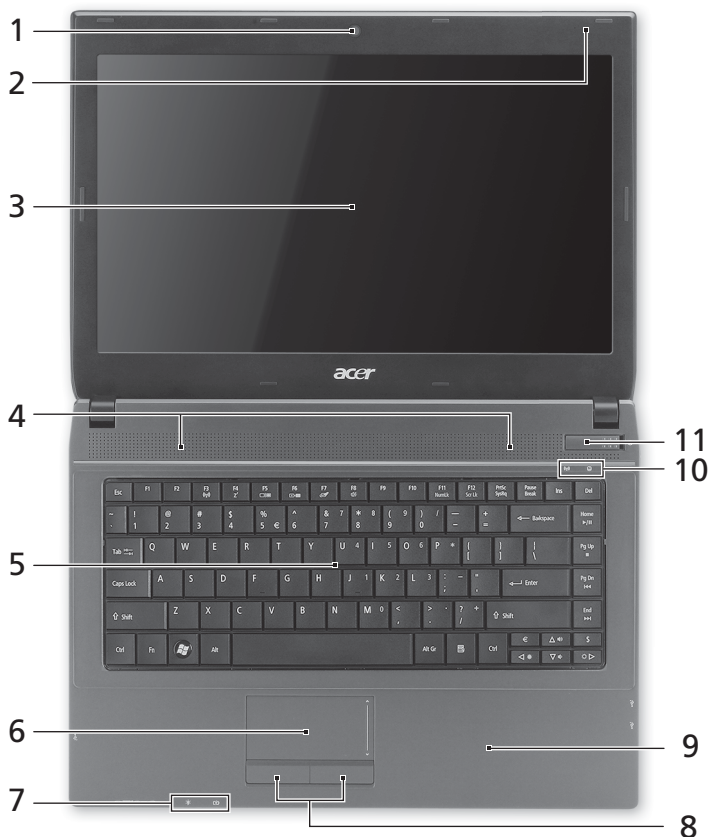

#	Ikona	Elements	Apraksts
1		Acer Crystal Eye tīmekļa kamera	Tīmekļa kamera videosakariem (tikai noteiktiem modeļiem).

#	Ikona	Elements	Apraksts
2		Mikrofons	Iekšējais mikrofons skaņas ierakstīšanai.
3		Displeja ekrāns	Saukts arī par šķidro kristālu displeju (LCD); rāda datora izvadi (modeļu konfigurācija var atšķirties).
4		Skaļruņi	Kreisais un labais skaļrunis nodrošina stereo audio izvadi.
5		Tastatūra	Datu ievadīšanai datorā.
6		Skārienpanelis	Skārienjutīga rādītājierīce, kas darbojas kā datora pele.
7		Jaudas indikators ¹	Norāda datora barošanas statusu.
		Akumulatora indikators ¹	Norāda datora akumulatora statusu. 1. Uzlāde: Indikators ir oranžā krāsā, akumulatoram uzlādējoties. 2. Pilnībā uzlādēts: Datoram darbojoties no maiņstrāvas, indikators ir zils.
8		Klikšķināmas pogas (kreisā un labā)	Kreisā un labā poga darbojas tāpat kā peles kreisā un labā poga.
9		Plaukstu atbalsta zona	Ērta atbalsta zona jūsu rokām, kad lietojat datoru.
10		Sakaru indikators	Norāda datora bezvadu savienojamās ierīces statusu.
		Cietā diska indikators	Norāda, ka cietais disks ir aktīvs.
11		Barošanas slēdzis	Ieslēdz un izslēdz datoru.

1. Priekšējā paneļa indikatori ir redzami pat tad, kad datora vāks ir aizvērts.

















Piezīme: Precīza jūsu datora konfigurācija ir atkarīga no iegādātā modeļa.

Ātrie taustiņi

Lai piekļūtu lielākajai daļai datora vadības funkciju, piemēram, ekrāna spilgtuma un skaļuma regulēšanai, tiek izmantoti datora ātrie taustiņi vai taustiņu kombinācijas.

Lai aktivizētu ātros taustiņus, nospiediet un turiet taustiņu **<Fn>**, tad nospiediet ātra taustiņa kombinācijas otru taustiņu.

Ātrais taustiņš	Ikona	Funkcija	Apraksts
<Fn> + <F3>		Sakaru taustiņš	Iespējo/atspējo datora sakaru ierīces. (Sakaru ierīces var atšķirties atkarībā no konfigurācijas.)
<Fn> + <F4>		Miega režīms	Pārslēdz datoru miega režīmā.
<Fn> + <F5>		Displeja pārslēgšana	Pārslēdz displeja izvadi starp displeja ekrāna un ārējo monitoru (ja tas ir pievienots), vai rāda izvadi abos.
<Fn> + <F6>		Izslēgt displeju	Enerģijas taupīšanas nolūkā izslēdz displeja ekrāna pretgaismu. Lai atjaunotu pretgaismu, nospiediet jebkuru taustiņu.
<Fn> + <F7>		Skārienpaneļa pārslēgšana	Ieslēdz un izslēdz iebūvēto skārienpaneli.
<Fn> + <F8>		Skaļruņu pārslēgšana	Ieslēdz un izslēdz skaļruņus.
<Fn> + <F11>	NumLk	NumLock (Ciparslēgs)	Ieslēdz un izslēdz iegulto cipartastatūru.
<Fn> + <F12>	Scr Lk	Scroll Lock (Ritslēgs)	Kad ir ieslēgts Scroll Lock (Ritslēgs), ekrāns pārvietojas pa vienu līniju augšup vai lejup, attiecīgi nospiežot augšup vai lejup vērsto bultiņu taustiņus. Dažās lietojumprogrammās Scroll Lock (ritslēgs) nedarbojas.
<Fn> + <▷>		Spilgtāk	Palielina ekrāna spilgtumu.
<Fn> + <◁>		Blāvāk	Samazina ekrāna spilgtumu.
<Fn> + <△>		Skaļāk	Palielina skaņas skaļumu.
<Fn> + <▽>		Klusāk	Samazina skaņas skaļumu.
<Fn> + <Home>		Atskaņot/ apturēt	Atskaņo vai aptur izvēlēto multivides failu.
<Fn> + <Pg Up>		Pārtraukt	Aptur izvēlētā multivides faila atskaņošanu.
<Fn> + <Pg Dn>		Atpakaļ	Atgriežas pie iepriekšējā multivides faila.
<Fn> + <End>		Tālāk	Pārlec uz nākamo multivides failu.

Skats no priekšpuses aizvērtā veidā



#	Ikona	Elements	Apraksts
1		Karšu lasītājs "Vairāki vienā"	Pieņem datu nesējus Secure Digital (SD), MultiMediaCard (MMC), Memory Stick (MS), Memory Stick PRO (MS PRO) un xD-Picture Card (xD). Piezīme: Nospiediet, lai izņemtu/instalētu karti. Vienlaikus var lietot tikai vienu karti.



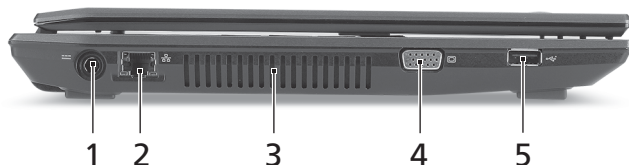

Skats no kreisās puses

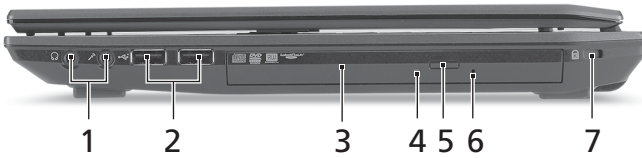

#	Ikona	Elements	Apraksts
1		Līdzstrāvas ieejas ligzda	Šeit pieslēdz maiņstrāvas adapteru.
2		Ethernet (RJ-45) ports	Šeit pieslēdz Ethernet 10/100/1000 tīkla vadu.
3		Ventilācijas atveres	Neļauj datoram sakarst pat pēc ilgstošas lietošanas.
4		Ārējā displeja (VGA) ports	Šeit pieslēdz displeja ierīci (piemēram, ārēju monitoru, LCD projektoru).
5		USB 2.0 ports	Šeit pieslēdz USB 2.0 ierīces (piemēram, USB peli vai USB kameru).





Skats no labās puses



#	Ikona	Elements	Apraksts
1		Austiņu/skaļruņu/ līnijas izejas ligzda	Šeit pieslēdz audio līnijas izejas ierīces (piemēram, skaļruņus, austiņas).
			Mikrofona ligzda
2		USB 2.0 ports	Šeit pieslēdz USB 2.0 ierīces (piemēram, USB peli vai USB kameru).
3		Optiskais diskdzinis	Iekšējais optiskais diskdzinis; pieņem CD vai DVD diskus.
4		Optiskā diska piekļuves indikators	Iedegas, kad optiskais diskdzinis ir aktīvs.
5		Optiskā diska izstumšanas poga	Izstumj no diskdziņa optisko disku.
6		Ārkārtas diska izņemšanas caurums	Izstumj optiskā diskdziņa paliktņi, kad dators ir izslēgts. Piezīme: Lai izstumtu optiskā diskdziņa paliktņi, kad dators ir izslēgts, iespiediet ārkārtas diska izņemšanas caurumā papīra saspraudi.
7		Kensingtona atslēgas slots	Šeit pieslēdz Kensingtona atslēgu datora drošībai.

Skats no apakšpuses



#	Ikona	Elements	Apraksts
1		Akumulatora nodalījums	Šeit ievieto datora akumulatoru.
2		Akumulatora fiksators	Nofiksē akumulatoru.
3		Cietā diska nodalījums	Šeit atrodas datora cietais disks. (nostiprināts ar skrūvēm).
4		Atmiņas nodalījums	Šeit atrodas datora pamatatmiņa.
5		Ventilācijas atveres un ventilators	Neļauj datoram sakarst pat pēc ilgstošas lietošanas. Piezīme: Neaizsedziet un nenosprostojiet ventilatora atveri.
6		Akumulatora atbrīvošanas slēdzis	Atbrīvo akumulatoru, lai to varētu izņemt.

Vide

- Temperatūra:
 - Ieslēgtā stāvoklī: No 5°C līdz 35°C
 - Izslēgtā stāvoklī: No -20°C līdz 65°C
- Mitrums (bez kondensācijas):
 - Ieslēgtā stāvoklī: No 20% līdz 80%
 - Izslēgtā stāvoklī: No 20% līdz 80%

TravelMate 4740/4740Z/4340 seriju

Trumpa instrukcija

© 2010 Visos teisės saugomos.

TravelMate 4740/4740Z/4340 serijų Trumpa instrukcija
Pirmasis leidimas: 03/2010

TravelMate 4740/4740Z/4340 serijų nešiojamasis kompiuteris

Modelio numeris: _____

Serijos numeris: _____

Pirkimo data: _____

Pirkimo vieta: _____

Dalykai, kuriuos reikia atlikti pirmiausia

Leiskite padėkoti, kad pasirinkote „Acer“ nešiojamąjį kompiuterį – tikimės Jūsų nenuvilti ir užtikrinti visus nešiojamojo kompiuterio teikiamus privalumus.

Instrukcijos Jums

Tam, kad palengvintume Jums naudojimąsi „Acer“ kompiuteriu, parengėme kelias instrukcijas:

Pirmiausia plakatas padės jums atlikti pradinį kompiuterio nustatymą.

„**TravelMate**“ serijos bendrojoje naudojimo instrukcijoje pateikiama naudinga informacija apie visų „TravelMate“ gaminių serijos modelių kompiuterius. Jis apima bendruosius klausimus, kaip, pvz. klaviatūros ir audio sistemos naudojimas ir t.t. Prašome atkreipti dėmesį į tai, jog dėl savo pobūdžio **Bendrojoje naudojimo instrukcijoje** bei **AcerSystem User Guide**, kuris bus minimas toliau, kartais bus aptariamoms funkcijoms ar ypatybėms, būdingoms tik konkrečioms šios serijos modeliams ir nebūtinai tam modeliui, kurį jūs įsigijote. Tokiais atvejais atitinkamose teksto vietose yra priedašais „tik tam tikruose modeliuose“.

Trumpoje instrukcijoje pateikiama informacija apie pagrindines Jūsų įsigyto kompiuterio savybes ir funkcijas. Išsamesnės informacijos apie tai, kaip padaryti kompiuterį produktyvesniu, rasite **AcerSystem User Guide**. Šioje instrukcijoje išsamiai aprašoma tokia informacija, kaip sisteminiai failai, duomenų atstatymas, kompiuterio galimybių aprėptimas ir gedimų diagnostika. Be to, šioje instrukcijoje yra ir garantinė informacija, bendrieji reikalavimai ir su sauga susiję įspėjimai. Ši instrukcija yra „Portable Document Format (PDF)“ formate ir ji jau bus kompiuteryje. Jei norite peržiūrėti šį gidą:

- 1 Spauskite  **Start (pradėti)**, > **All Programs (visos programos)** > **AcerSystem**.
- 2 Spauskite **AcerSystem User Guide**.



Pastaba: Failo peržiūrai reikės „Adobe Reader“. Jei kompiuteryje nėra „Adobe Reader“, paspaudus ant **AcerSystem User Guide** bus pirmiausiai paleistas „Adobe Reader“ įdiegimas. Vadovaukitės ekrane esančiomis instrukcijomis įdiegimo užbaigimui. Instrukcijų dėl „Adobe Reader“ naudojimosi ieškokite „**Help and Support**“ [**Žinynas ir pagalba**] meniu.



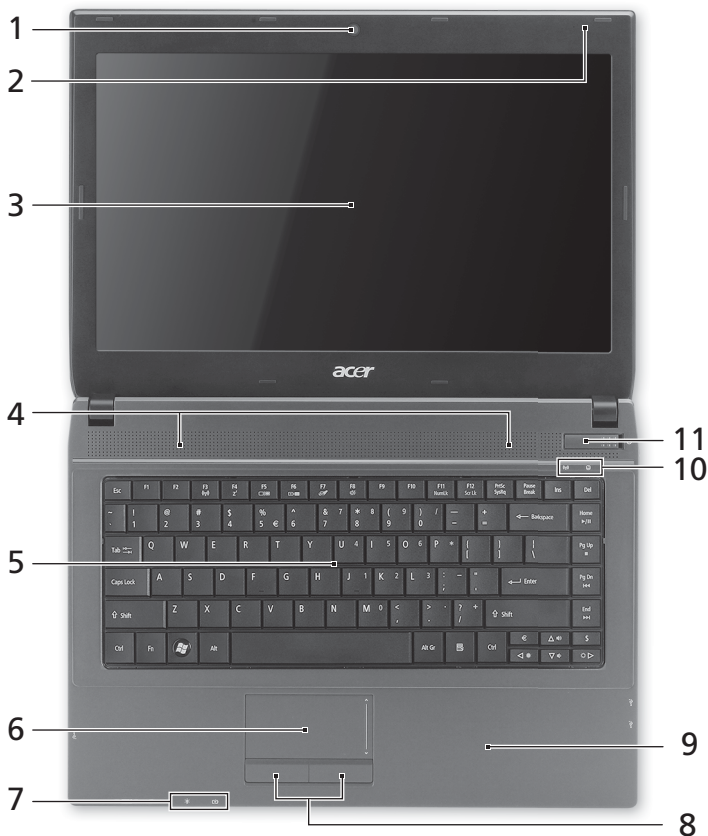

Ekskursija po jūsų Acer nešiojamąjį kompiuterį

Atlikus kompiuterio sąranką kaip parodyta plakate, leiskite jus supažindinti su jūsų naujuoju Acer nešiojamuoju kompiuteriu.

Vaizdas iš viršaus



#	Piktograma	Objektas	Aprašymas
1		Acer Crystal Eye interneto kamera	Interneto kamera vaizdinei komunikacijai (tik tam tikruose modeliuose).

#	Piktograma	Objektas	Aprašymas
2		Mikrofonas	Vidinis mikrofonas garso įrašymui.
3		Ekranas	Taip pat vadinamas skystųjų kristalų ekranu (angl. Liquid-Crystal Display (LCD)), jame pateikiamas kompiuterio rodomas vaizdas (konfigūravimo tvarka gali kisti priklausomai nuo modelio).
4		Garsiakalbiai	Kairysis ir dešinysis garsiakalbiai transliuoja stereo garsą.
5		Klaviatūra	Skirta duomenų įvedimui į kompiuterį.
6		Liečiamasis laukelis	Lietimui jautrus įrenginys, veikiantis kaip kompiuterio pelė.
7		Maitinimo indikatorius ¹	Nurodo kompiuterio energijos sistemos būklę.
		Baterijos indikatorius ¹	Nurodo kompiuterio baterijos būklę. 1. Kraunasi: Kraunantis baterijai lemputė dega gintaro spalva. 2. Pilnai pakrauta: Dirbant iš kintamos srovės (AC) tinklo lemputė dega mėlynai.
8		Pelės klavišai (kairysis ir dešinysis)	Kairysis ir dešinysis klavišai veikia kaip kairysis ir dešinysis pelės mygtukai.
9		Atrama delnui	Patogi atramos vieta jūsų rankoms naudojimosi kompiuteriu metu.
10		Komunikacijos indikatorius	Nurodo kompiuterio belaidžio ryšio įtaiso būklę.
		HDD indikatorius	Nurodo ar kietasis diskas yra naudojamas (į jį rašoma ar skaitoma).
11		Maitinimo jungiklis	Įjungia ir išjungia kompiuterį.

1. Priekinio pulto indikatoriai matomi ne tada, kai kompiuterio viršus yra uždarytas.













Pastaba: Tikslai jūsų kompiuterio konfigūracija priklauso nuo įsigyto modelio.

Greitieji klavišai

Kompiuteryje įrengti greitieji klavišai ar numatytos klavišų kombinacijos, leidžiančios valdyti daugelį kompiuterio funkcijų, tokių kaip ekrano ryškumas ar garsiakalbių garsas.

Norėdami pasinaudoti greitaisiais klavišais, prieš spausdami bet kokią greitųjų klavišų kombinaciją nuspauskite ir laikykite klavišus **<Fn>**.

Greitasis klavišas	Piktograma	Funkcija	Aprašymas
<Fn> + <F3>		Komunikacijos mygtukas	Ijungia/išjungia kompiuterio komunikacijos prietaisus. (Komunikacijos prietaisai gali skirtis priklausomai nuo konfigūracijos.)
<Fn> + <F4>		Sustabdyti	Ijungia hibernacijos (kompiuterio sustabdymo) režimą.
<Fn> + <F5>		Ekranų perjungimas	Perjungia kompiuterio rodomą vaizdą iš kompiuterio monitoriaus į išorinį monitorių (jei prijungtas) ir atvirkščiai.
<Fn> + <F6>		Ekrano išjungimas	Energijos taupymo tikslais išjungia ekraną. Norint vėl įjungti spauskite bet kurį klavišą.
<Fn> + <F7>		Lietimui jautraus ekrano jungiklis	Ijungia ir išjungia lietimui jautrų ekraną.
<Fn> + <F8>		Garsiakalbio jungiklis	Išjungia ir įjungia garsiakalbius.
<Fn> + <F11>	„NumLk“	NumLock	Ijungia ir išjungia integruotą skaičių klaviatūrą.
<Fn> + <F12>	Scr Lk	Scroll Lock	Ijungus „Scroll Lock“, vaizdas ekrane juda viena linija aukštyn arba žemyn spaudžiant, atitinkamai, klavišą su rodykle aukštyn arba su rodykle žemyn. „Scroll Lock“ su tam tikromis programomis neveikia.
<Fn> + <◀▶>		Padidinti ryškumą	Padidina ekrano ryškumą.
<Fn> + <◀◀>		Sumažinti ryškumą	Sumažina ekrano ryškumą.
<Fn> + <▲>		Padidinti garsą	Padidina kompiuterio audio sistemos garsą.
<Fn> + <▲▼>		Sumažinti garsą	Sumažina kompiuterio audio sistemos garsą.

Greitasis klavišas	Piktograma	Funkcija	Aprašymas
<Fn> + <Home>	▶/	Leisti/ pristabdyti	Leisti ar pristabdyti pasirinktą medijų failą.
<Fn> + <Pg Up>	■	Stabdyti	Sustabdyti pasirinktą medijų failą.
<Fn> + <Pg Dn>	◀◀	Ankstesnis	Grįžta prie ankstesnio medijų failo.
<Fn> + <End>	▶▶	Toliau	Pereina prie paskesnio medijų failo.





Uždaryto kompiuterio vaizdas iš priekio

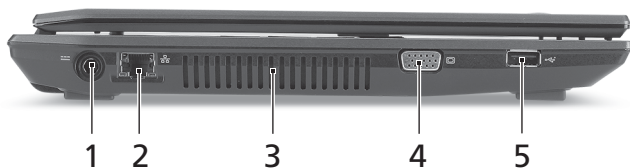

#	Piktograma	Objektas	Aprašymas
1		„Multi-in-1“ atminties kortelių skaitytuvas	<p>Skaito Secure Digital (SD), MultiMediaCard (MMC), Memory Stick (MS), Memory Stick PRO (MS PRO), xD-Picture Card (xD) tipų atminties korteles.</p> <p>Pastaba: Spauskite norėdami įdėti/išimti kortelę. Vienu metu galima naudotis tik viena kortele.</p>





Vaizdas iš kairės



#	Piktograma	Objektas	Aprašymas
1		Nuolatinės srovės (DC) kištuko lizdas	Skirtas prijungti kintamos srovės (AC) adapteriui.
2		Ethernet (RJ-45) lizdas	Skirtas prisijungti prie Ethernet 10/100/1000 tipo tinklo.
3		Ventiliacijos angos	Neleidžia kompiuteriui perkaisti net ir po ilgo naudojimo.
4		Išorinio ekrano (VGA) lizdas	Skirtas prijungti papildomą monitorių (pvz. išorinį monitorių, LCD projektorius).
5		USB 2.0 lizdas	Skirtas prijungti USB 2.0 tipo įrenginius (pvz. USB pelę, USB kamerą).





Vaizdas iš dešinės

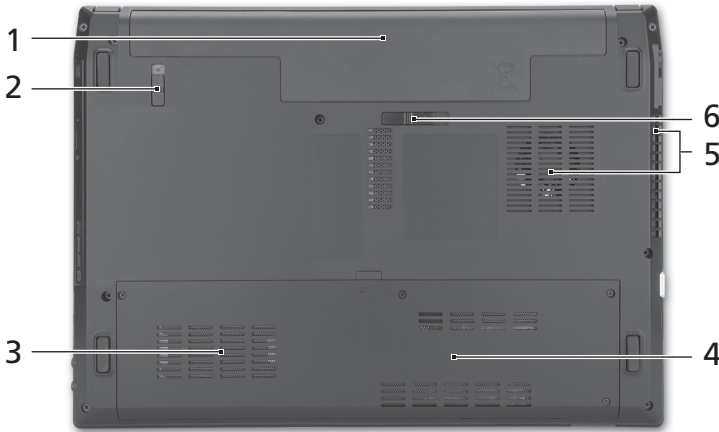

#	Piktograma	Objektas	Aprašymas
1		Ausinių/ garsiakalbio/ linijinio išėjimo kištukas	Skirtas išoriniams linijiniams audio prietaisams (pvz. garsiakalbiams, ausinėms) pajungti.
		Mikrofono prijungimo lizdas	Skirtas prijungti išorinį mikrofoną.
2		USB 2.0 lizdas	Skirtas prijungti USB 2.0 tipo įrenginius (pvz. USB pelę, USB kamerą).
3		Optinių diskų įrenginys	Vidinis optinių diskų įrenginys; skaito CD arba DVD.
4		Optinio disko darbo indikatorius	Dega kai optinių diskų įrenginys dirba.
5		Optinių diskų išstūmimo mygtukas	Atidaro optinių diskų įrenginio dureles.
6		Avarinio atidarymo anga	Atidaro optinių diskų įrenginio dureles kai kompiuteris yra išjungtas. Pastaba: Norėdami esant išjungtam kompiuteriui atidaryti optinių diskų įrenginio dureles, į avarinio atidarymo angą įkiškite sąvaržėlę.
7		Kensington spynos lizdas	Skirtas užfiksuoti Kensington tipo kompiuterio užraktui.

Vaizdas iš apačios



#	Piktograma	Objektas	Aprašymas
1		Baterijos lizdas	Skirtas montuoti kompiuterio baterijai.
2		Baterijos užraktas	Fiksuoja įdėtą bateriją darbinėje padėtyje.
3		Kietųjų diskų lizdas	Montuojamas kietasis diskas (įtvirtintas varžtais).
4		Operatyviosios atminties lizdas	Montuojama pagrindinė kompiuterio atmintis.
5		Ventiliacijos angos ir aušintuvas	Neleidžia kompiuteriui perkaisti net ir po ilgo naudojimo. Pastaba: Neuždenkite ir neužblokuokite ventiliatoriaus ertmės.
6		Baterijos fiksatorius	Atpalaiduoja baterijos fiksavimą, leidžia ją išimti.

Aplinka

- Temperatūra:
 - Darbinė: Nuo 5°C iki 35°C
 - Saugojimo: Nuo -20°C iki 65°C
- Drėgmė (be kondensacijos):
 - Darbinė: Nuo 20% iki 80%
 - Saugojimo: Nuo 20% iki 80%

Σειρά TravelMate 4740/4740Z/ 4340

Γρήγορος οδηγός

© 2010 Με την επιφύλαξη κάθε νόμιμου δικαιώματος.

Γρήγορος οδηγός σειράς TravelMate 4740/4740Z/4340
Αρχική Έκδοση: 03/2010

Φορητό PC σειράς TravelMate 4740/4740Z/4340

Αριθμός Μοντέλου: _____

Σειριακός Αριθμός: _____

Ημερομηνία Αγοράς: _____

Τόπος Αγοράς: _____

Πρώτα από όλα

Θα επιθυμούσαμε να σας ευχαριστήσουμε που επιλέξατε το φορητό υπολογιστή της Acer με σκοπό την αντιμετώπιση των αναγκών σας για φορητό υπολογιστή.

Οι οδηγοί σας

Για να σας βοηθήσουμε στη χρήση του φορητού υπολογιστή της Acer, έχουμε σχεδιάσει ένα σετ εγχειριδίων χρήσης:

Πρώτα απ' όλα, η αψίδα σας βοηθά να ξεκινήσετε με την εγκατάσταση του υπολογιστή σας.

Ο **Γενικός Οδηγός Χρήσης Σειράς TravelMate** περιέχει χρήσιμες πληροφορίες που ισχύουν για όλα τα μοντέλα της σειράς προϊόντων TravelMate. Καλύπτει βασικά θέματα όπως τη χρήση του πληκτρολογίου και τον ήχο κ.λ.π. Παρακαλούμε σημειώστε ότι λόγω της φύσης του, ο **Γενικός Οδηγός Χρήσης** καθώς και ο **Οδηγός Χρήσης AcerSystem** που αναφέρονται πιο κάτω, αναφέρονται περιστασιακά σε λειτουργίες ή δυνατότητες που αφορούν ορισμένα μόνο μοντέλα της σειράς, και όχι απαραίτητα στο μοντέλο που προμηθευτήκατε. Αυτές οι περιπτώσεις επισημαίνονται στο κείμενο με τη φράση "ορισμένα μοντέλα μόνο".

Ο **Γρήγορος οδηγός** παρουσιάζει τις βασικές δυνατότητες και λειτουργίες του νέου σας υπολογιστή. Για περισσότερες πληροφορίες όσον αφορά τον τρόπο με τον οποίο ο υπολογιστής μπορεί να σας βοηθήσει να αυξήσετε την παραγωγικότητά σας, ανατρέξτε στον **AcerSystem User's Guide**. Ο οδηγός αυτός περιλαμβάνει λεπτομερείς πληροφορίες σχετικά με θέματα όπως τα βοηθητικά προγράμματα του συστήματος, την επαναφορά δεδομένων, τις επιλογές επέκτασης και την αντιμετώπιση προβλημάτων. Επιπλέον, περιλαμβάνει πληροφορίες σχετικά με την εγγύηση καλής λειτουργίας και τους γενικούς κανονισμούς όπως και τις προειδοποιήσεις ασφαλείας για το φορητό υπολογιστή. Διατίθεται σε μορφή Portable Document Format (PDF) και έχει προ-εγκατασταθεί στο φορητό υπολογιστή σας. Ακολουθήστε τα επόμενα βήματα για την πρόσβαση σε αυτόν.

- 1 Κάντε κλικ στο  **Έναρξη > Όλα τα προγράμματα > AcerSystem**.
- 2 Κάντε κλικ στην επιλογή **AcerSystem User's Guide**.



Σημείωση: Για να δείτε το αρχείο θα πρέπει να έχετε εγκαταστήσει το πρόγραμμα Adobe Reader. Αν δεν είναι εγκατεστημένο το Adobe Reader στον υπολογιστή σας, κάνοντας κλικ στην επιλογή **AcerSystem User's Guide** θα πραγματοποιηθεί εκτέλεση του προγράμματος εγκατάστασης του Adobe Reader πρώτα. Ακολουθήστε τις οδηγίες στην οθόνη για να ολοκληρώσετε την εγκατάσταση. Για οδηγίες σχετικά με το πώς να χρησιμοποιήσετε το πρόγραμμα Adobe Reader, ανατρέξτε στο μενού **Βοήθεια και Υποστήριξη**.







Μια ξενάγηση του φορητού υπολογιστή Acer

Μετά από την εγκατάσταση του υπολογιστή όπως απεικονίζεται στην αφίσα, θα σας περιγράψουμε τα διάφορα μέρη του νέου σας φορητού υπολογιστή της Acer.

Κάτοψη



#	Εικονίδιο	Στοιχείο	Περιγραφή
1		Κάμερα διαδίκτυο Acer Crystal Eye	Κάμερα διαδίκτυο για επικοινωνία βίντεο (ορισμένα μοντέλα μόνο).

#	Εικονίδιο	Στοιχείο	Περιγραφή
2		Μικρόφωνο	Εσωτερικό μικρόφωνο για στερεοφωνικές εγγραφές.
3		Οθόνη απεικόνισης	Αποκαλούμενη επίσης Οθόνη Υγρών Κρυστάλλων (Liquid-Crystal Display; LCD), απεικονίζει την έξοδο του υπολογιστή (η σύνθεση ενδέχεται να ποικίλλει ανάλογα με το μοντέλο).
4		Ηχεία	Τα ηχεία αριστερά και δεξιά παρέχουν στερεοφωνικό ήχο.
5		Πληκτρολόγιο	Χρησιμοποιείται για την καταχώρηση δεδομένων στον υπολογιστή.
6		Ταμπλέτα αφής	Συσκευή κατάδειξης ευαίσθητη στην αφή που λειτουργεί ως ποντίκι υπολογιστή.
7		Ενδείκτης τροφοδοσίας ¹	Δηλώνει την κατάσταση τροφοδοσίας του υπολογιστή.
		Ενδείκτης μπαταρίας ¹	<p>Δηλώνει την κατάσταση της μπαταρίας του υπολογιστή.</p> <p>1. Φόρτιση: Η ενδεικτική λυχνία κατά τη φόρτιση της μπαταρίας γίνεται φαιοκίτρινη.</p> <p>2. Πλήρως φορτισμένη: Η ενδεικτική λυχνία γίνεται μπλε όταν βρίσκεται σε λειτουργία εναλλασσόμενου ρεύματος (AC).</p>
8		Κουμπιά κλικ (αριστερό και δεξιό)	Το κουμπιά, αριστερό και δεξιό, λειτουργούν σαν τα κουμπιά, αριστερό και δεξιό, του ποντικιού.
9		Στήριγμα παλάμης	Άνετος χώρος στήριξης των χεριών κατά τη χρήση του υπολογιστή.
10		Ενδεικτική λυχνία επικοινωνίας	Υποδεικνύει την κατάσταση της συσκευής ασύρματης σύνδεσης του υπολογιστή.
		Ενδεικτική λυχνία HDD	Δηλώνει πότε είναι ενεργοποιημένη η μονάδα του σκληρού δίσκου.
11		Διακόπτης τροφοδοσίας	Ενεργοποιεί και απενεργοποιεί τον υπολογιστή.

1. Οι ενδεικτικές λυχνίες της πρόσοψης είναι ορατές ακόμη και όταν το καπάκι του υπολογιστή είναι τελείως κλειστό.











Σημείωση: Η ακριβής σύνθεση του PC εξαρτάται από το μοντέλο που αγοράσατε.

Πλήκτρα συντόμευσης

Ο υπολογιστής χρησιμοποιεί πλήκτρα συντόμευσης ή συνδυασμούς πλήκτρων για πρόσβαση στα περισσότερα από τα στοιχεία ελέγχου του υπολογιστή όπως η φωτεινότητα οθόνης και η ένταση ήχου.

Για να ενεργοποιήσετε τα πλήκτρα συντόμευσης, πιάστε παρατεταμένα το πλήκτρο **<Fn>** πριν πιάσετε το άλλο πλήκτρο του συνδυασμού πλήκτρων συντόμευσης.

Πλήκτρο συντόμευσης	Εικονίδιο	Λειτουργία	Περιγραφή
<Fn> + <F3>		Πλήκτρο επικοινωνίας	Ενεργοποιεί / απενεργοποιεί τις συσκευές επικοινωνίας του υπολογιστή. (Οι συσκευές επικοινωνίας ενδέχεται να διαφέρουν ανάλογα με τη σύνθεση.)
<Fn> + <F4>		Αναμονή	Θέτει τον υπολογιστή σε λειτουργία αναμονής.
<Fn> + <F5>		Εναλλαγή οθόνης	Μεταγωγή της εξόδου οθόνης μεταξύ οθόνης απεικόνισης, εξωτερικού μόνιτορ (εάν υπάρχει) ή και των δύο.
<Fn> + <F6>		Οθόνη απενεργοποιημένη	Απενεργοποιεί τον πίσθιο φωτισμό της οθόνης απεικόνισης για εξοικονόμηση ενέργειας. Πιάστε οποιοδήποτε πλήκτρο για επιστροφή.
<Fn> + <F7>		Εναλλαγή επιφάνειας αφής	Ενεργοποιεί και απενεργοποιεί την εσωτερική επιφάνεια αφής.
<Fn> + <F8>		Εναλλαγή ηχείων	Ενεργοποιεί και απενεργοποιεί τα ηχεία.
<Fn> + <F11>	NumLk	NumLock	Ενεργοποιεί ή απενεργοποιεί το ενσωματωμένο αριθμητικό πληκτρολόγιο.
<Fn> + <F12>	Scr Lk	Scroll Lock	Όταν είναι ενεργοποιημένο το Scroll Lock, η οθόνη μετακινείται μια γραμμή πάνω ή κάτω όταν πατάτε τα πλήκτρα με τα βελάκια πάνω ή κάτω αντίστοιχα. Το Scroll Lock δε λειτουργεί με μερικές εφαρμογές.
<Fn> + <▷>		Αύξηση φωτεινότητας	Αυξάνει τη φωτεινότητα της οθόνης.
<Fn> + <◁>		Μείωση φωτεινότητας	Μειώνει τη φωτεινότητα της οθόνης.

Πλήκτρο συντόμευσης	Εικονίδιο	Λειτουργία	Περιγραφή
<Fn> + <Δ>		Αύξηση έντασης	Αυξάνει την ένταση του ήχου.
<Fn> + <▽>		Μείωση έντασης	Μειώνει την ένταση του ήχου.
<Fn> + <Αρχική>		Αναπαραγωγή/ Παύση	Αναπαραγωγή ή παύση ενός επιλεγμένου αρχείου μέσων.
<Fn> + <Pg Up>		Διακοπή	Διακοπή αναπαραγωγής του επιλεγμένου αρχείου μέσων.
<Fn> + <Pg Dn>		Προηγούμενο	Επιστροφή στο προηγούμενο αρχείο μέσων.
<Fn> + <End>		Επόμενο	Πηδήξτε στο επόμενο αρχείο μέσων.





Πρόσοψη με το καπάκι κλειστό

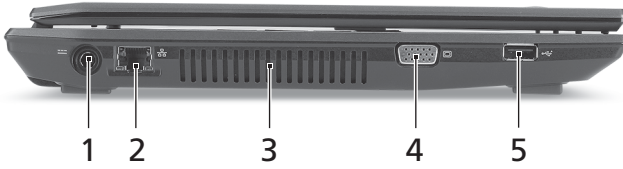

#	Εικονίδιο	Στοιχείο	Περιγραφή
1		Αναγνώστης καρτών πολλών-σε-1	Δέχεται Secure Digital (SD), MultiMediaCard (MMC), Memory Stick (MS), Memory Stick PRO (MS PRO), και xD-Picture Card (xD). Σημείωση: Πιέστε για αφαίρεση/ τοποθέτηση της κάρτας. Δυνατότητα λειτουργίας μόνο μιας κάρτας κάθε φορά.





Αριστερή πλευρά



#	Εικονίδιο	Στοιχείο	Περιγραφή
1		Τζακ εισόδου συνεχούς ρεύματος (DC)	Συνδέεται σε προσαρμογέα εναλλασσόμενου ρεύματος (AC).
2		Θύρα Ethernet (RJ-45)	Συνδέεται σε δίκτυο Ethernet 10/100/1000.
3		Θυρίδες εξαερισμού	Διατηρούν τον υπολογιστή σε χαμηλή θερμοκρασία, ακόμη και ύστερα από παρατεταμένη χρήση.
4		Θύρα εξωτερικής οθόνης απεικόνισης (VGA)	Συνδέεται σε συσκευή απεικόνισης (π.χ. εξωτερικό μόνιτορ, προβολέας LCD).
5		Θύρα USB 2.0	Συνδέεται σε συσκευές USB 2.0 (π.χ. ποντίκι USB, κάμερα USB).





Δεξιά πλευρά

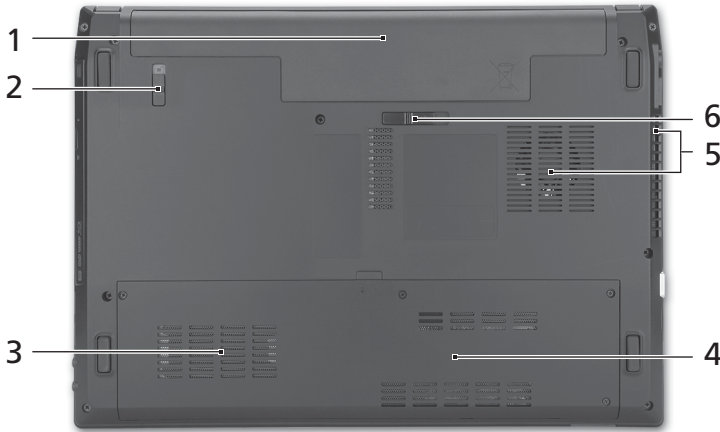

#	Εικονίδιο	Στοιχείο	Περιγραφή
1		Τζακ ακουστικών/ηχείου/γραμμής εξόδου	Συνδέεται σε συσκευές με γραμμή εξόδου ακουστικού σήματος (π.χ. ηχεία, ακουστικά).
		Τζακ μικροφώνου	Δέχεται εισόδους από εξωτερικά μικρόφωνα.
2		Θύρα USB 2.0	Συνδέεται σε συσκευές USB 2.0 (π.χ. ποντίκι USB, κάμερα USB).
3		Μονάδα οπτικού δίσκου	Εσωτερική μονάδα οπτικού δίσκου, δέχεται CD ή DVD.
4		Φωτεινή ένδειξη πρόσβασης οπτικού δίσκου	Ανάβει κατά την ενεργοποίηση της μονάδας οπτικού δίσκου.
5		Κουμπί εκτίναξης της μονάδας οπτικού δίσκου	Χρησιμοποιείται για την εκτίναξη του συρταριού της μονάδας οπτικού δίσκου από τη μονάδα.
6		Οπή έκτακτης εκτίναξης	Χρησιμοποιείται για την εκτίναξη του συρταριού της μονάδας οπτικού δίσκου όταν ο υπολογιστής είναι απενεργοποιημένος. Σημείωση: Τοποθετήστε ένα μεταλλικό συνδετήρα μέσα στην οπή έκτακτης εκτίναξης για εκτίναξη του συρταριού της μονάδας οπτικού δίσκου όταν ο υπολογιστής είναι απενεργοποιημένος.
7		Υποδοχή λουκέτου τύπου Kensington	Συνδέεται σε λουκέτο ασφαλείας υπολογιστή συμβατό με Kensington.

Άποψη βάσεως



#	Εικονίδιο	Στοιχείο	Περιγραφή
1		Φατνίο μπαταρίας	Περιέχει το πακέτο μπαταρίας του υπολογιστή.
2		Λουκέτο μπαταρίας	Ασφαλίζει τη μπαταρία στη θέση της.
3		Φατνίο σκληρού δίσκου	Περιέχει το σκληρό δίσκο του υπολογιστή (ασφαλίζεται με βίδες).
4		Διαμέρισμα μνήμης	Περιέχει την κύρια μνήμη του υπολογιστή.
5		Θυρίδες εξαερισμού και ανεμιστήρας ψύξης	Διατηρούν τον υπολογιστή σε χαμηλή θερμοκρασία, ακόμη και ύστερα από παρατεταμένη χρήση. Σημείωση: Μην καλύπτετε ή φράζετε το άνοιγμα του ανεμιστήρα.
6		Μάνδαλο απασφάλισης μπαταρίας	Απασφαλίζει τη μπαταρία για αφαίρεση.

Περιβάλλον

- Θερμοκρασία:
 - Λειτουργίας: 5°C έως 35°C
 - Μη λειτουργίας: -20°C έως 65°C
- Υγρασία (μη συμπυκνούμενη):
 - Λειτουργίας: 20% έως 80%
 - Μη λειτουργίας: 20% έως 80%

TravelMate 4740/4740Z/4340 Serisi

Hızlı Başlama Kılavuzu

© 2010 Tüm Hakları Saklıdır.

TravelMate 4740/4740Z/4340 Serisi Hızlı Başlama Kılavuzu
Orijinal İhraç: 03/2010

TravelMate 4740/4740Z/4340 Serisi Dizüstü Bilgisayarı

Model numarası: _____

Seri numarası: _____

Satın alma tarihi: _____

Satın alma yeri: _____

İlk Yapılacaklar

Taşınabilir bilgisayar ihtiyacınızı karşılamak için Acer dizüstü bilgisayarını tercih ettiğiniz için teşekkür ederiz.

Kılavuzlarınız

Acer dizüstü bilgisayarını kullanırken size yardımcı olması için bir dizi rehber tasarladık:

İlk olarak poster bilgisayarınızı ayarlamanıza yardımcı olur.

TravelMate Serisi Orjijinal Kullanım Kılavuzu TravelMate ürün serisindeki tüm modellere uygulanan faydalı bilgiler içermektedir. Klavyeyi kullanma, Ses vs. gibi temel konular içermektedir. Lütfen aşağıda bahsedilen **Genel Kullanım Kılavuzu** ve **AcerSystem Kullanım Kılavuzu**'nun doğası gereği zaman zaman serinin sadece belirli modellerinde bulunan işlev ve özelliklere başvurduğunu ancak satın aldığınız modelde gerekli olmayabileceğini unutmayın. Bu tarz örnekler (sadece belli modellerde) ibaresi ile belirtilmektedir.

Hızlı Başlama Kılavuzu size bilgisayarınızın temel özelliklerini ve işlevlerini tanıtır. Bilgisayarınızın üretkenliğiniz üzerindeki etkisini arttırmak için lütfen **AcerSystem User Guide göz gezdirin**. Bu rehber; sistem işlevleri, veri kurtarma, genişletme seçenekleri ve sorun giderme gibi konular üzerine detaylı bilgi içerir. Buna ek olarak bilgisayarınızla ilgili garanti bilgileri, genel kuralları ve güvenlik uyarılarını içerir. Bu, bilgisayarınıza önceden yüklenmiş şekilde PDF dosya formatında gelmektedir. Ulaşmak için şu adımları izleyin:

- 1  **Başlat > Tüm Programlar > AcerSystem**'e tıklayın.
- 2 **AcerSystem Kullanım Kılavuzu**'na tıklayın.



Not: Adobe Reader gerektiren dosyayı inceleme. Bilgisayarınızda Adobe Reader yüklü değilse **AcerSystem Kullanım Kılavuzu**'na tıklayarak Adobe Reader kurulum programını çalıştırabilirsiniz. Yükleme tamamlandıktan sonra ekrandaki talimatları izleyin. Adobe Reader'ın nasıl kullanıldığını öğrenmek için, **Yardım ve Destek** menüsüne girin.

Acer dizüstü bilgisayarınızda bir gezinti

Bilgisayarınızı posterde gösterildiği gibi ayarladıktan sonra yeni Acer dizüstü bilgisayarınızı tanıtmamıza izin verin.

Üstten görünüş



#	Simge	Öğe	Tanım
1		Acer Crystal Eye video kamera	Görüntülü iletişim için web kamerası (sadece bazı modeller için).

#	Simge	Öge	Tanım
2		Mikrofon	Ses kaydı için dahili mikrofon.
3		Görüntü ekranı	Sıvı Kristalli Görüntü (LCD) olarak da bilinir ve bilgisayar çıktılarını gösterir (yapılandırma modele göre farklı olabilir).
4		Hoparlörler	Sol ve sağ hoparlörler stereo ses çıkışı verir.
5		Klavye	Bilgisayarınıza veri girebilmek için.
6		Dokunmatik yüzey	Bilgisayar faresi gibi fonksiyonu olan, dokunmaya duyarlı işaret aygıtı.
7		Güç göstergesi ¹	Bilgisayarın güç durumunu gösterir.
		Batarya göstergesi ¹	Bilgisayarın pil durumunu gösterir. 1. Şarj: Pil şarj olurken ışık kehribar renginde yanar. 2. Tamamen şarj oldu: AC modundayken ışık mavi yanar.
8		Tuşlar (sol ve sağ)	Sol ve sağ tuşlar, bilgisayar faresinin sağ ve sol tuşları ile aynı fonksiyondadır.
9		Palmrest	Bilgisayarı kullanırken ellerinizi destekleyen rahat bir alan.
10		İletişim göstergesi	Bilgisayarın kablosuz bağlanabilirlik aygıt durumunu gösterir.
		HDD göstergesi	Sabit diskin etkin olduğunu gösterir.
11		Güç anahtarı	Bilgisayarı açar ve kapatır.

1. Ön panel göstergeleri bilgisayar kapağı kapalı olsa bile görülebilir.

















Not: Bilgisayarınızın gerçek konfigürasyonu satın aldığınız modele bağlıdır.

Kısayol Tuşları

Bilgisayarda, ekran parlaklığı ve ses çıkışı gibi bilgisayarın birçok kontrolüne erişimin sağlanması için faydalı tuşlar yer almaktadır.

Faydalı tuşları etkinleştirmek için, faydalı tuş kombinasyonundaki diğer tuşa basmadan önce **<Fn>** tuşuna basılı tutun.

Faydalı tuş	Simge	İşlev	Tanım
<Fn> + <F3>		İletişim anahtarı	Bilgisayarın iletişim aygıtlarını etkinleştirir/engeller. (İletişim aygıtları yapılandırmaya göre farklılık gösterebilir.)
<Fn> + <F4>		Uyku	Bilgisayarı Uyku moduna sokar.
<Fn> + <F5>		Ekran değişikliği	Görüntü ekranı, harici monitör (eğer bağlıysa) ve ikisi arasında ekran çıktısını değiştirir.
<Fn> + <F6>		Ekran kapalı	Görüntü ekran arka ışığını, güçten kazanmak için kapatır. Geriye dönmek için herhangi bir tuşa basın.
<Fn> + <F7>		Dokunmatik yüzey değişikliği	Dahili dokunmatik yüzeyi açar ve kapatır.
<Fn> + <F8>		Hoparlör değişikliği	Hoparlörleri açar ve kapatır.
<Fn> + <F11>	NumLk	NumLock	Gömülü sayısal tuş takımı açık veya kapalı.
<Fn> + <F12>	Scr Lk	Scroll Lock	Scroll Lock açıkken, yukarı ya da aşağı ok tuşlarına bastığınızda ekran bir satır yukarı ya da aşağı hareket eder. Scroll Lock bazı uygulamalarda çalışmaz.
<Fn> + <▶>		Parlaklığı artır	Ekran parlaklığını artırır.
<Fn> + <◀>		Parlaklığı azalt	Ekran parlaklığını azaltır.
<Fn> + <▲>		Ses aç	Sesi artırır.
<Fn> + <▼>		Ses kapat	Sesi azaltır.
<Fn> + <Giriş>		Yürüt/Duraklat	Seçilen ortam dosyasını oynatın veya duraklatın.
<Fn> + <Pg Up>		Durdur	Seçilen ortam dosyasının oynatılmasını durdurur.
<Fn> + <Pg Dn>		Önceki	Önceki ortam dosyasına döner.
<Fn> + <Bitir>		İleri	Sonraki ortam dosyasına geçer.





Kapalı ön görünüm

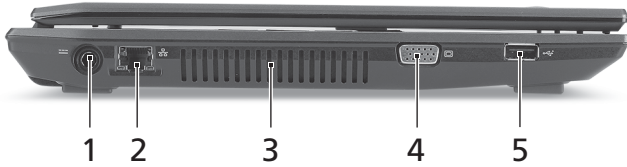

#	Simge	Öge	Tanım
1		Çoklu kart okuyucu	Güvenli Dijital (SD), Çoklu Ortam Kartı(MMC), Bellek Çubuğu (MS), Bellek Çubuğu PRO (MS PRO), xD-Görüntü Kartı (xD)'ni kabul eder. Not: Kartı çıkartmak/takmak için itin. Her hangi bir zamanda sadece bir kart çalışabilir.





Sol görünüm

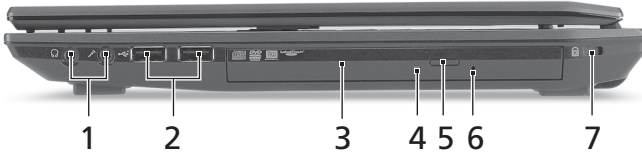

#	Simge	Öge	Tanım
1		DC-in jakı	AC adaptöre bağlanır.
2		Ethernet (RJ-45) portu	Ethernet 10/100/1000-temelli ağa bağlar.
3		Havalandırma yuvaları	Bilgisayarınızın uzun kullanımlar sonrası bile ısınmamasını sağlarlar.
4		Harici görüntü (VGA) portu	Bir görüntü aygıtına bağlar (örneğin, harici monitör, LCD projektör).
5		USB 2.0 portu	USB 2.0 cihazlarına bağlantıyı sağlar (örneğin USB fare, USB kamera).





Sağ görünüm



#	Simge	Öge	Tanım
1		Kulaklık/hoparlör/ hat çıkışı jakı	Sesli line-out cihazlarına bağlantıyı sağlar (örneğin hoparlör, kulaklık).
		Mikrofon jakı	Harici mikrofon girişlerini kabul eder.
2		USB 2.0 portu	USB 2.0 cihazlarına bağlantıyı sağlar (örneğin USB fare, USB kamera).
3		Optik sürücü	Dahili optik sürücü; CD'leri veya DVD'leri kabul eder.
4		Optik sürücü erişim göstergesi	Optik sürücü etkinken yanar.
5		Optik sürücü çıkarma tuşu	Optik diski sürücüden çıkarır.
6		Acil durum çıkarma yuvası	Bilgisayara kapandığında optik sürücü yatağını çıkarır. Not: Bilgisayar kapatıldığında optik sürücü tepsisini çıkarmak için acil durum çıkarma yuvasına bir kağıt atacı takın.
7		Kensington kilit yuvası	Kensington-uyumlu bilgisayar güvenlik kilidine bağlar.

Alt görünüm



#	Simge	Öge	Tanım
1		Pil bölmesi	Bilgisayar pil takımının yeridir.
2		Pil kilidi	Pil yerine oturduğunda kilitlet.
3		Sabit disk bölmesi	Bilgisayarın sabit diskini barındırır (vidalarla sabitlenmiştir).
4		Bellek bölmesi	Bilgisayarın ana hafızasını barındırır.
5		Havalandırma delikleri ve soğutma fanı	Bilgisayarınızın uzun kullanımlar sonrası bile ısınmamasını sağlarlar. Not: Fanın girişini tıkamayın.
6		Pil çıkarma mandalı	Eskiyen pilleri çıkarmanız içindir.

Ortam

- Sıcaklık:
 - Çalışma: 5°C ila 35°C arasında
 - Çalışmadığı durumda: -20°C ila 65°C arasında
- Nem (yoğunlaşmayan):
 - Çalışma: %20 ila %80 arasında
 - Çalışmadığı durumda: %20 ila %80 arasında

TravelMate 4740/4740Z/ 4340 シリーズ

クイックガイド

© 2010 All Rights Reserved.

TravelMate 4740/4740Z/4340 シリーズクイックガイド
初版：2010年3月

TravelMate 4740/4740Z/4340 シリーズノートブックコンピューター

モデル番号： _____

シリアル番号： _____

購入日： _____

購入場所： _____

はじめに

Acer ノートブックをお買い上げいただきありがとうございます。

各種ガイドについて

本製品を快適にご使用いただくために、次のガイドが提供されています。

初めての方は、ポスターの解説に従ってコンピュータを設定してください。

TravelMate シリーズ汎用ガイドには、TravelMate シリーズの全モデルに共通の情報が記載されています。本書にはキーボードやオーディオの使い方など、基本的な情報が含まれています。**汎用ユーザーガイド**および以下に紹介する **AcerSystem User Guide (ユーザーズマニュアル)**に記載される説明の中には、特定モデルのみ適用されるものがあり、お客様が購入されたモデルには該当しない場合があります。このような場合には、「特定モデルのみ」という注意書きが記載されています。

クイックガイドは、本 PC を生産的に使用するための方法を説明します。

AcerSystem User Guide (ユーザーズマニュアル)は、本 PC についてわかりやすく説明しておりますので、**良くお読み頂き、指示に従ってください**。このガイドには、システムユーティリティ、データ復元、拡張オプション、トラブルシューティングなどの詳細情報を記載しております。その他、保証情報および一般的な規制、安全のためのご注意なども記載されています。これは PDF (Portable Document Format) フォーマットでもお読みいただけるよう、ノートブックにあらかじめプリロードされています。このガイドをご覧になるには、以下の手順に従ってください。

- 1  **スタート > すべてのプログラム > AcerSystem** をクリックします。
- 2 **AcerSystem User Guide (ユーザーズマニュアル)** をクリックしてください。



.....

注意：ファイルを表示するには、Adobe Reader が必要となります。Adobe Reader がセットアップされていない場合、**AcerSystem User Guide (ユーザーガイド)** をクリックすると Adobe Reader セットアッププログラムを実行します。画面の指示にしたがってインストールを完了してください。Adobe Reader の使い方については、**ヘルプとサポート**メニューにアクセスしてください。





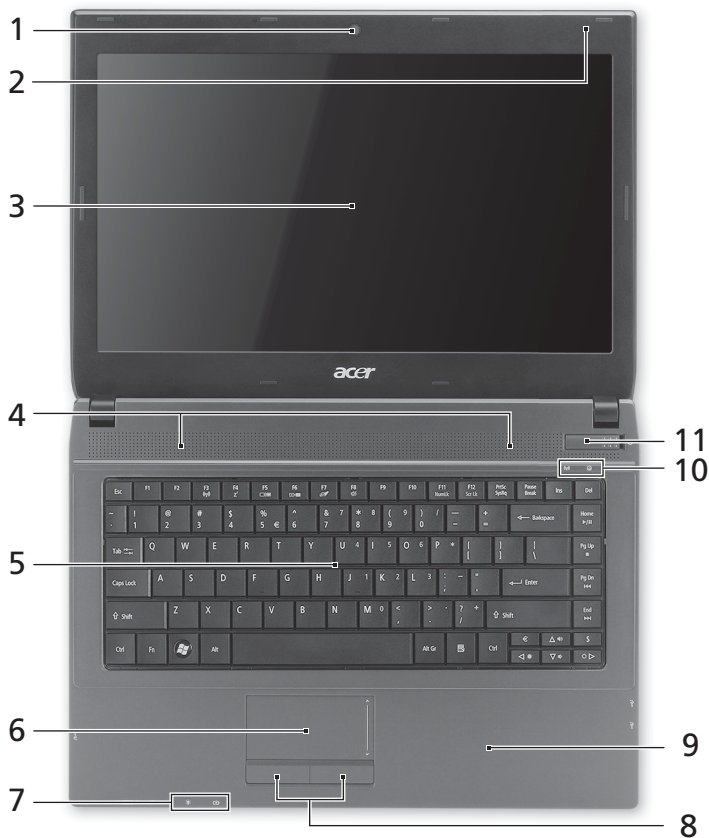

Acer ノートブックツアー

ポスターの解説に従ってコンピューターを設定が完了したら、Acer ノートブックの各パーツについて慣れてください。

上面



#	アイコン	アイテム	説明
1		Acer Crystal Eye ウェブカメラ	ビデオ通信用のウェブカメラ (特定モデルのみ)。

#	アイコン	アイテム	説明
2		マイクロフォン	録音用の内部マイクロフォンです。
3		ディスプレイスクリーン	液晶ディスプレイ (LCD) とも呼びます。コンピューター出力を表示します (構成はモデルによって異なります)。
4		スピーカー	左右スピーカーから、ステレオオーディオが出力されます。
5		キーボード	コンピューターにデータを入力します。
6		タッチパッド	コンピューターマウスと同じように機能し、指を触れることで反応するポインティングデバイスです。
7		電源インジケータ ¹	PCの電源がオンのときに点灯します。
		バッテリーインジケータ ¹	<p>バッテリーパックが充電されているときに点灯します。</p> <p>1. 充電中 : バッテリーを充電している間、ランプは琥珀色に点灯します。</p> <p>2. 完全に充電 : AC モードでは、ライトが青くなります。</p>
8		クリックボタン (左、右)	左右のボタンはマウスの左右のボタンと同じように機能します。
9		パームレスト	コンピューター操作時に手を置く場所です。
10		通信インジケータ	PC ワイヤレス接続装置がオンのときに点灯します。
		HDD インジケータ	ハードディスクドライブがアクティブになると点灯します。
11		電源スイッチ	コンピューターの電源をオン/オフにします。

1. フロントパネルのインジケータは、コンピューターカバーが閉じた状態でも見えるようになっています。



注意 : PC の正確な構成は、お客様が購入されたモデルにより異なります。

ホットキー

このコンピュータでは、ホットキーや2つ以上のキーを組み合わせることで、画面の輝度や出力音量など、コンピュータのほとんどのコントロールを調整することができます。

ホットキーを利用するときは、<Fn> キーを押しながら、ホットキーの組み合わせとなる、もう1つのキーを押してください。

ホットキー	アイコン	機能	説明
<Fn> + <F3>		通信キー	コンピュータの通信機器を有効/無効にします(通信機器は、構成内容によって異なります)。
<Fn> + <F4>		スリープ	PCをスリープモードに切り替えます。
<Fn> + <F5>		ディスプレイ切り替え	ディスプレイ出力を、ディスプレイスクリーン、外付けモニター(接続されている場合)、またはその両方に切り替えます。
<Fn> + <F6>		ディスプレイオフ	ディスプレイのバックライトをオフにして、電源を節約します。キーをどれか押すと、バックライトはオンになります。
<Fn> + <F7>		タッチパッド ON / OFF	内蔵タッチパッドをオン/オフにします。
<Fn> + <F8>		スピーカー ON / OFF	スピーカーをオン/オフにします。
<Fn> + <F11>	NumLk	NumLock	キーボードの埋め込みテンキーパッドをオン/オフにします。
<Fn> + <F12>	Scr Lk	Scroll Lock	Scroll Lock が ON のとき上または下カーソルキーを押すと、画面はそれぞれ1行上または1行下に移動します。Scroll Lock は、特定のアプリケーションでは機能しません。
<Fn> + <◀>		輝度を上げる	画面輝度が上がります。
<Fn> + <◀◀>		輝度を下げる	画面輝度が下がります。
<Fn> + <▲>		ボリュームアップ	スピーカーのボリュームを上げます。
<Fn> + <▼>		ボリュームダウン	スピーカーのボリュームを下げます。
<Fn> + <Home>		再生 / 一時停止	選択したメディアファイルを再生または一時停止します。
<Fn> + <Pg Up>		中止	選択したメディアファイルの再生を中止します。
<Fn> + <Pg Dn>		戻る	前のメディアファイルに戻ります。
<Fn> + <End>		次へ	次のメディアファイルに移動します。

正面（閉じた場合）



#	アイコン	アイテム	説明
1		1台多機能のカードリーダー	Secure Digital (SD)、MultiMediaCard (MMC)、Memory Stick (MS)、Memory Stick PRO (MS PRO)、xD-Picture Card (xD) に対応しています。 注意： 押すと、カードの取り出し / 挿入ができます。一度に1枚のカードしか操作できません。



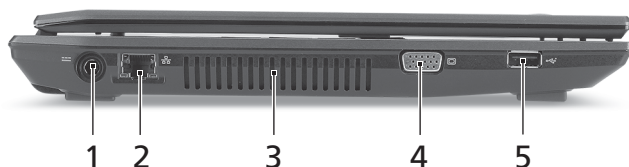

左面



#	アイコン	アイテム	説明
1		DC 入力ジャック	AC アダプタに接続します。
2		Ethernet (RJ-45) ポート	Ethernet 10/100/1000 ベースのネットワークに接続します。
3		通気孔	長時間使用してもコンピューターが過熱しないよう冷却します。
4		外部ディスプレイ (VGA) ポート	ディスプレイデバイスに接続します (外付けモニター、LCD プロジェクタなど)。
5		USB 2.0 ポート	USB 2.0 デバイスを接続します (USB マウス、USB カメラなど)。





右面



#	アイコン	アイテム	説明
1		ヘッドフォン/ スピーカー/ 出力ジャック	オーディオ出力デバイスを接続します (スピーカー、ヘッドフォンなど)。
		マイクロフォン ジャック	外部マイクロフォンを接続します。
2		USB 2.0 ポート	USB 2.0 デバイスを接続します (USB マウス、USB カメラなど)。
3		光学ドライブ	内部光学ドライブ (CD および DVD に対応)。
4		光学ディスクアク セスインジケータ	光学ドライブが使用中のときには点灯します。
5		光学ドライブイ ジェクトボタン	ドライブから光学ディスクを取り出します。
6		緊急用イジェクト ホール	コンピューターがオフになっているときに、 光学ドライブトレイを引き出します。 注意： コンピューターがオフの状態の場合は、 緊急用イジェクトホールにペーパークリップ を差し込むと光学ドライブトレイが出てき ます。
7		Kensington ロッ クスロット	Kensington 対応コンピューターセキュリテ ィロックに接続します。

底面



#	アイコン	アイテム	説明
1		バッテリーベイ	コンピューターのバッテリーパックを装着します。
2		バッテリーロック	バッテリーを定位置にロックします。
3		ハードディスクベイ	コンピューターのハードディスクを装着します(ネジで固定)。
4		メモリコンパートメント	コンピューターのメインメモリを装着します。
5		通気孔スロットと冷却ファン	長時間使用してもコンピューターが過熱しないよう冷却します。 注意: ファンの通気穴を塞いだり、異物を詰め込んだりしないでください。
6		バッテリー取り外しつまみ	バッテリーを取り出します。

環境

- 温度：
 - 操作時：5°C ~ 35°C
 - 非操作時：-20°C ~ 65°C
- 湿度（結露しないこと）：
 - 操作時：20% ~ 80%
 - 非操作時：20% ~ 80%

TravelMate 4740/4740Z/4340 시리즈

빠른 시작 설명서

© 2010 All Rights Reserved.

TravelMate 4740/4740Z/4340 시리즈 빠른 시작 설명서
최초 발행일 : 03/2010

TravelMate 4740/4740Z/4340 시리즈 노트북 PC

모델 번호 : _____

일련 번호 : _____

구입 날짜 : _____

구입 장소 : _____

사용 전 유의 사항

Acer 노트북을 선택해주셔서 감사합니다. 이 노트북이 귀하의 모바일 컴퓨팅 요구를 충족시켜 드릴 것입니다.

제공되는 설명서

Acer 노트북을 사용하는 데 도움을 줄 수 있는 여러 설명서가 제공됩니다.

우선 포스터는 컴퓨터 설정을 시작하는 데 유용합니다.

TravelMate 시리즈 일반 사용 설명서에는 TravelMate 제품 시리즈의 모든 모델에 적용되는 유용한 정보가 포함되어 있습니다. 이 설명서에서는 키보드 사용, 오디오 등과 같은 기본적인 주제를 다룹니다. 설명서의 특성상, 아래 언급된 **AcerSystem 사용 설명서** 및 **일반 사용 설명서**에는 이 시리즈의 특정 모델에만 있고 귀하가 구입한 모델에는 없는 기능 또는 특징에 대한 설명이 포함되어 있을 수 있음을 양지하십시오. 그러한 부분에는 "특정 모델에만 해당"과 같은 텍스트가 표시되어 있습니다.

빠른 시작 설명서에서는 새 컴퓨터의 기본 특징 및 기능을 소개합니다. 컴퓨터를 좀 더 생산적으로 활용하는 방법에 대한 자세한 내용은 **AcerSystem 사용 설명서**를 참조하십시오. 이 설명서에서는 시스템 유틸리티, 데이터 복구, 확장 옵션 및 문제 해결과 같은 주제를 자세하게 설명합니다. 또한 노트북에 대한 일반 규정과 안전 주의 사항 및 보증 정보가 포함되어 있습니다. 이 설명서는 PDF (Portable Document Format) 파일로 제공되며 노트북에 이미 설치되어 있습니다. 다음 단계에 따라 설명서에 액세스할 수 있습니다.

- 1  시작 > 모든 프로그램 > **AcerSystem** 을 클릭합니다.
- 2 **AcerSystem 사용 설명서**를 클릭합니다.



.....

참고: 이 파일을 보려면 Adobe Reader가 필요합니다. 컴퓨터에 Adobe Reader가 설치되어 있지 않은 경우 **AcerSystem 사용 설명서**를 클릭하면 자동으로 Adobe Reader 설치 프로그램이 실행됩니다. 화면의 지시에 따라 나머지 설치 과정을 완료합니다. Adobe Reader 사용 방법에 대한 지침을 보려면 **Help and Support** (도움말 및 지원) 메뉴에 액세스하십시오.





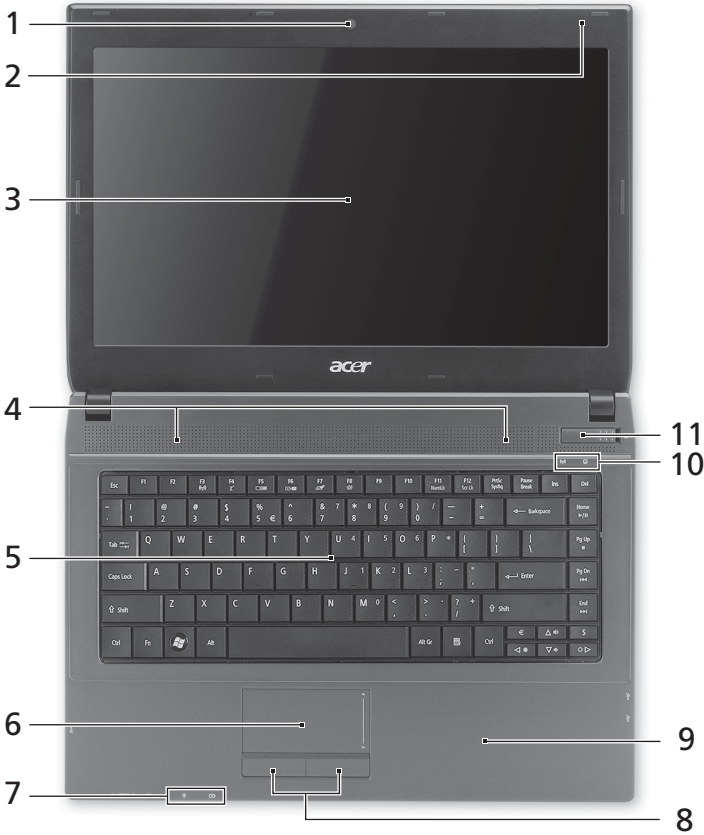

Acer 노트북 둘러보기

포스터에 설명된 대로 컴퓨터를 설정했다면 이제 새 Acer 노트북을 살펴볼 차례입니다.

위에서 본 모습



#	아이콘	항목	설명
1		Acer Crystal Eye 웹캠	비디오 통신용 웹 카메라입니다 (일부 모델에만 해당).

#	아이콘	항목	설명
2		마이크	소리를 녹음할 수 있는 내부 마이크입니다.
3		디스플레이 화면	LCD (액정 디스플레이) 라고도 하며, 컴퓨터 출력을 표시합니다 (구성은 모델에 따라 다릅니다).
4		스피커	왼쪽 스피커와 오른쪽 스피커로 스테레오 오디오를 출력합니다.
5		키보드	컴퓨터에 데이터를 입력하는 데 사용됩니다.
6		터치패드	컴퓨터 마우스와 같은 역할을 하는 접촉식 포인팅 장치입니다.
7		전원 표시등 ¹	컴퓨터의 전원 상태를 표시합니다.
		배터리 표시등 ¹	컴퓨터의 배터리 상태를 표시합니다. 1. 충전 중 : 배터리가 충전 중이면 황색 불이 켜집니다. 2. 충전 완료 : AC 모드일 때 파란 불이 켜집니다.
8		누름 단추들	왼쪽과 오른쪽의 단추는 마우스의 왼쪽 및 오른쪽 (왼쪽 및 오른쪽) 쪽 단추와 같은 역할을 합니다.
9		손목 받침대	컴퓨터를 사용할 때 편안하게 손을 올려 놓는 영역입니다.
10		통신 표시등	컴퓨터의 무선 연결 장치 상태를 표시합니다.
		HDD 표시등	하드 디스크 드라이브가 동작 중이면 불이 켜집니다.
11		전원 스위치	컴퓨터를 켜고 끕니다.

1. 전면 패널 표시등은 컴퓨터 덮개를 닫은 상태에서도 볼 수 있습니다.



참고 : PC의 정확한 구성 내용은 구입한 모델에 따라 다릅니다.

바로 가기 키

컴퓨터에서는 화면 밝기와 볼륨 출력 같은 대부분의 컴퓨터 컨트롤에 액세스하기 위해 바로 가기 키 또는 키 조합이 사용됩니다.

바로 가기 키를 활성화하려면 바로 가기 키 조합의 다른 키를 누르기 전에 <Fn> 키를 누릅니다.

바로 가기 키	아이콘	기능	설명
<Fn> + <F3>		통신 키	컴퓨터의 통신 장치를 활성화 / 비활성화합니다. (통신 장치는 구성에 따라 다를 수 있습니다.)
<Fn> + <F4>		절전	컴퓨터를 절전 모드로 설정합니다.
<Fn> + <F5>		디스플레이 전환	디스플레이 출력을 디스플레이 화면, 외부 모니터 (연결된 경우) 또는 둘 다에 보내도록 선택합니다.
<Fn> + <F6>		디스플레이 끄기	전원을 절약하기 위해 디스플레이 화면의 백라이트를 끕니다. 화면을 다시 켜려면 임의의 키를 누릅니다.
<Fn> + <F7>		터치패드 전환	내부 터치패드를 켜고 끕니다.
<Fn> + <F8>		스피커 전환	스피커를 켜고 끕니다.
<Fn> + <F11>	NumLk	NumLock	내장 숫자 키패드를 켜거나 끕니다.
<Fn> + <F12>	Scr Lk	Scroll Lock	Scroll Lock 이 설정되어 있을 때 위쪽 또는 아래쪽 화살표 키를 누르면 화면에서 한 줄씩 위 또는 아래로 이동됩니다. 일부 응용 프로그램에서는 Scroll Lock 이 작동하지 않습니다.
<Fn> + <D>		밝게	화면 밝기를 증가시킵니다.
<Fn> + <L>		어둡게	화면 밝기를 감소시킵니다.
<Fn> + <A>		볼륨 크게	소리를 높입니다.
<Fn> + <V>		볼륨 작게	소리를 낮춥니다.
<Fn> + <Home>		재생 / 일시 중지	선택된 미디어 파일을 재생 또는 일시 중지합니다.
<Fn> + <Pg Up>		중지	선택된 미디어 파일 재생을 중지합니다.
<Fn> + <Pg Dn>		이전	이전 미디어 파일로 돌아갑니다.
<Fn> + <End>		다음	다음 미디어 파일로 이동합니다.





닫힌 상태의 앞 모습

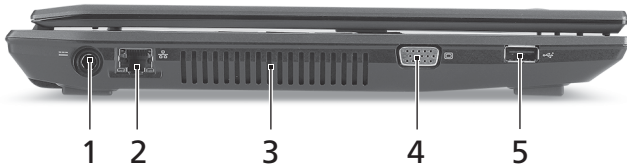

#	아이콘	항목	설명
1		멀티 카드 판독기	Secure Digital (SD), MultiMediaCard (MMC), Memory Stick (MS), Memory Stick PRO (MS PRO) 및 xD-Picture Card (xD) 를 사용할 수 있습니다. 참고 : 카드를 눌러 제거 또는 설치합니다 . 카드를 한 번에 하나만 사용할 수 있습니다 .





왼쪽 모습

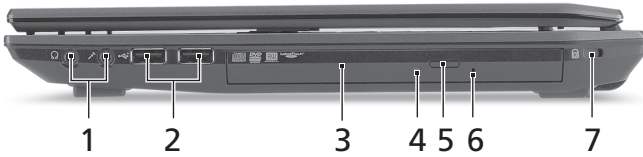

#	아이콘	항목	설명
1		DC 입력 잭	AC 어댑터에 연결합니다 .
2		이더넷 (RJ-45) 포트	10/100/1000 이더넷 네트워크에 연결합니다 .
3		통풍용 슬롯	장시간 사용한 후에도 컴퓨터를 차갑게 유지할 수 있습니다 .
4		외부 디스플레이 (VGA) 포트	디스플레이 장치에 연결합니다 (예 : 외부 모니터 , LCD 프로젝터) .
5		USB 2.0 포트	USB 2.0 장치에 연결합니다 . (예 : USB 마우스 , USB 카메라) .





오른쪽 모습

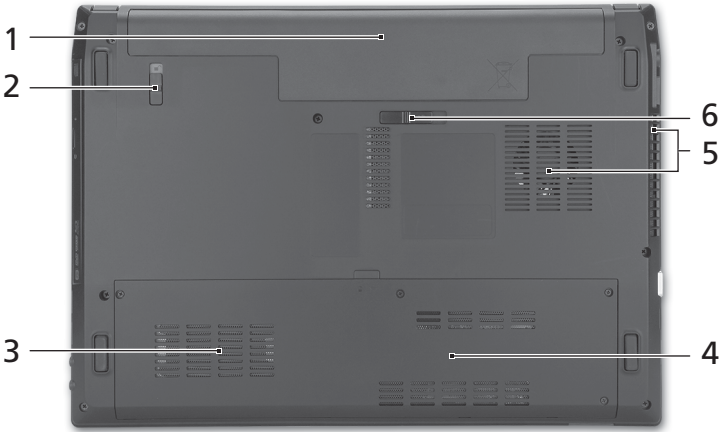

#	아이콘	항목	설명
1		헤드폰 / 스피커 / 출력 잭	오디오 출력 장치에 연결합니다 (예 : 스피커 , 헤드폰).
		마이크 잭	외부 마이크로 소리를 입력할 때 사용합니다 .
2		USB 2.0 포트	USB 2.0 장치에 연결합니다 (예 : USB 마우스 , USB 카메라).
3		광드라이브	내부 광드라이브 .CD 또는 DVD 를 넣습니다 .
4		광디스크 액세스 표시등	광드라이브가 작동 중이면 불이 켜집니다 .
5		광드라이브 꺼내기 단추	드라이브에서 광디스크를 꺼냅니다 .
6		비상용 꺼내기 구멍	컴퓨터가 꺼졌을 때 광드라이브 트레이를 꺼낼 수 있습니다 . 참고 : 컴퓨터가 꺼졌을 때 클립을 비상용 꺼내기 구멍에 삽입하여 광드라이브 트레이를 꺼내십시오 .
7		Kensington 잠금 장치 슬롯	Kensington 호환 컴퓨터 보호용 잠금 장치를 연결합니다 .

바닥 모습



#	아이콘	항목	설명
1		배터리 장착부	컴퓨터의 배터리 팩을 넣습니다 .
2		배터리 잠금	장착된 배터리를 빠지지 않도록 잠급니다 .
3		하드 디스크 장착부	컴퓨터의 하드 디스크를 넣습니다 (나사로 고정).
4		메모리 장착부	컴퓨터의 주 메모리를 넣습니다 .
5		통풍용 슬롯 및 냉각 팬	장시간 사용한 후에도 컴퓨터를 차갑게 유지할 수 있습니다 . 참고 : 팬의 입구를 막거나 차단하지 마십시오 .
6		배터리 제거용 래치	제거를 위해 배터리를 뺄 때 사용합니다 .

환경

- 온도 :
 - 작동 : 5°C - 35°C
 - 비작동 : -20°C - 65°C
- 습도 (비응축) :
 - 작동 : 20% - 80%
 - 비작동 : 20% - 80%

TravelMate 4740/4740Z/4340 系列

快速使用指南

© 2010 版權所有

TravelMate 4740/4740Z/4340 系列快速使用指南
初版：2010 年 3 月

TravelMate 4740/4740Z/4340 系列筆記型電腦

產品型號： _____

產品序號： _____

購買日期： _____

購買地點： _____

初步設定

首先，感謝您選擇 Acer 筆記型電腦，其會是滿足您行動運算需求的最佳首選。

使用指南

為協助您順利使用 Acer 筆記型電腦，我們特地設計了以下的使用指南：

首先，海報可協助您開始設定您的電腦。

印刷版的 **TravelMate 系列一般使用指南**內含一些實用的資訊，適用於 TravelMate 產品系列的所有型號。其中包括基本主題，例如使用鍵盤、音訊等。請注意，由於其性質不同，下列所提及之「**一般使用指南**」及「**AcerSystem User Guide**」將會不定時請您參照只有特定型號所包含的功能或特點，而您所購買的機型不一定會包含這些功能。此類情形將以「僅適用於特定機型」等文字標示。

本「**快速指南**」介紹本電腦的基本特性和功能。有關本電腦如何幫助您提高效率的更多資訊，請參閱「**AcerSystem User Guide**」。本使用手冊包含系統公用程式、資料復原、擴充配備和疑難排解等詳細資訊。此外，本指南也包含筆記型電腦的保固資訊、AA 一般規範及安全注意事項。該文件以 Au 可攜式文件格式 Av(PDF) 提供，並已預載在您的筆記型電腦上。請遵循下列步驟存取手冊：

- 1 按一下  「開始」 > 「所有程式」 > 「AcerSystem」。
- 2 按一下「AcerSystem 使用手冊」。





注意：若要閱讀 PDF 檔案，必須先安裝 Adobe Reader 程式。若系統未安裝 Adobe Reader 程式，請先按一下「**AcerSystem User Guide**」並執行 Adobe Reader 安裝程式。請遵循畫面上的指示完成安裝程序。如需 Adobe Reader 使用說明，請點選「**說明和支援**」功能表以獲得更詳細資訊。





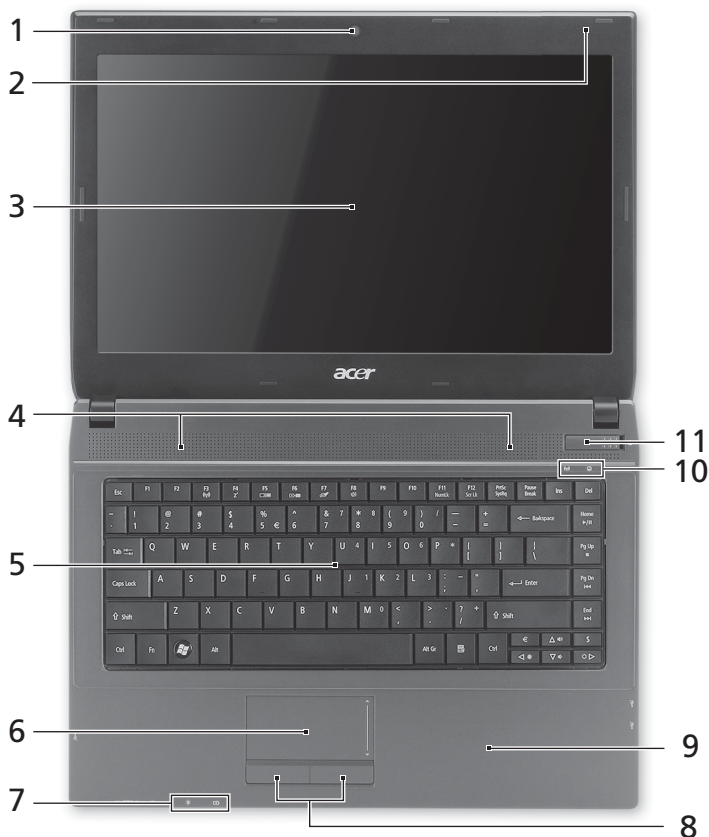

Acer 筆記型電腦導覽

在依照海報中所提及的說明完成電腦的設定之後，就讓我們為您展示一下全新 Acer 筆記型電腦的各項功能吧！

上視圖



#	圖示	項目	說明
1		Acer Crystal Eye 網路攝影機	網路攝影機，可用於視訊通訊 (僅適用於特定機型)。

#	圖示	項目	說明
2		麥克風	用於錄音的內建麥克風。
3		顯示螢幕	亦稱為液晶顯示器 (Liquid-Crystal Display ; LCD)，用於顯示電腦資料的輸出 (設定將依型號而有所不同)。
4		喇叭	左右兩個喇叭提供立體音效的輸出。
5		鍵盤	可用來將資料輸入電腦。
6		觸控板	觸控感應式移動游標裝置，功能等同於電腦的滑鼠。
7		電源指示燈 ¹	表示電腦的電源狀態。
		電池指示燈 ¹	表示電腦的電池狀態。 1. 充電中： 當電池充電時，指示燈會亮琥珀色。 2. 充電完畢： 當使用 AC 電源模式時，指示燈會亮藍色。
8		點選鍵 (左和右)	左鍵和右鍵的功能等同於滑鼠的左鍵和右鍵。
9		腕靠	讓您在使用電腦時，可舒適擺放手腕的位置。
10		通訊指示燈	表示電腦無線連線能力的狀態。
		硬碟指示燈	當存取硬碟時，指示燈會亮起。
11		電源開關	開啓和關閉電腦。

1. 即使在電腦螢幕關上時，您依然可看見位於前面板的狀態指示燈。



注意：實際 PC 的規格會視購買的機型而定。

快速鍵

利用此電腦的快捷鍵或組合鍵可存取大部分的控制指令，例如：螢幕亮度和音量輸出。

若要使用快速鍵，請先按住 **<Fn>** 鍵，再按下組合鍵的另一按鍵。

快速鍵	圖示	功能	說明
<Fn> + <F3>		通訊鍵	啓用 / 停用電腦的通訊裝置。 (通訊裝置可能根據組態而有所不同。)
<Fn> + <F4>		睡眠	讓電腦進入睡眠模式。
<Fn> + <F5>		螢幕顯示切換	在螢幕及外接顯示器 (如有連接) 之間切換，或同時顯示。
<Fn> + <F6>		關閉顯示螢幕	關閉顯示螢幕背光，以節省電力。 按下任意鍵即可返回。
<Fn> + <F7>		觸控板切換鈕	開啓和關閉內建的觸控板。
<Fn> + <F8>		喇叭切換鈕	開啓和關閉喇叭。
<Fn> + <F11>	NumLk	NumLock	開啓或關閉內嵌數字鍵台。
<Fn> + <F12>	Scr Lk	Scroll Lock	啓用 Scroll Lock 功能時，螢幕會在您按 ↑ 或 ↓ 鍵時往上或往下移動一行。但 Scroll Lock 功能對某些應用軟體是不會發生效用的。
<Fn> + <▷>		調高亮度	調高螢幕亮度。
<Fn> + <◁>		調低亮度	調低螢幕亮度。
<Fn> + <△>		提高音量	提高喇叭音量。
<Fn> + <▽>		降低音量	降低喇叭音量。
<Fn> + <Home>		播放 / 暫停	播放或暫停選取的媒體檔。
<Fn> + <Pg Up>		停止	停止播放選取的媒體檔。
<Fn> + <Pg Dn>		上一個	返回上一個媒體檔。
<Fn> + <End>		下一個	跳到下一個媒體檔。





上蓋闔起的前視圖

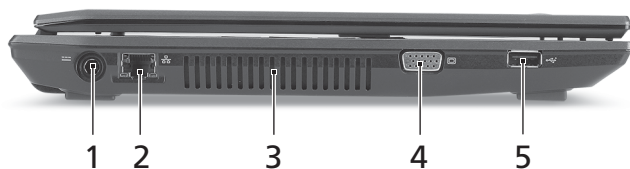

#	圖示	項目	說明
1		多合一讀卡機	可支援 Secure Digital (SD)、MultiMediaCard (MMC)、Memory Stick (MS)、Memory Stick PRO (MS PRO)、xD-Picture Card (xD)。 注意： 輕壓即可移除 / 安裝卡片。無論何時皆只能使用一張卡片。





左視圖



#	圖示	項目	說明
1		DC 輸入插孔	連接到 AC 變壓器。
2		乙太網路 (RJ-45) 連接埠	連接到以 10/100/1000 為基礎的乙太網路。
3		散熱孔	可讓電腦在長時間使用後仍然能夠保持冷卻狀態。
4		外接顯示螢幕 (VGA) 連接埠	連接到顯示螢幕 (例如：外接顯示器、LCD 投影機)。
5		USB 2.0 埠	連接到 USB 2.0 裝置 (例如：USB 滑鼠、USB 網路攝影機)。





右視圖

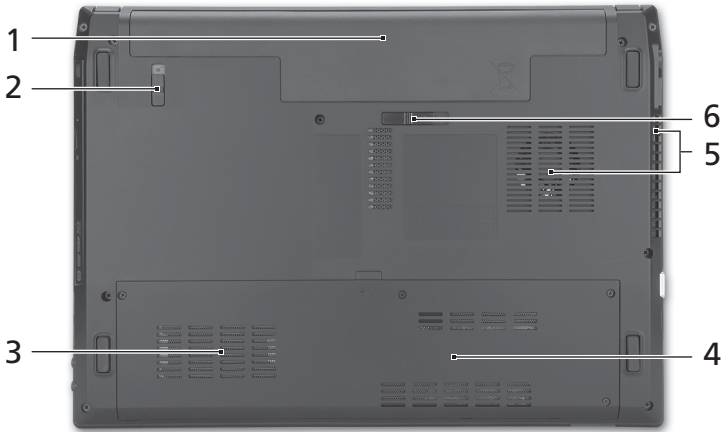

#	圖示	項目	說明
1		耳機 / 喇叭 / 線路輸出插孔	連接到外接音訊裝置 (例如：喇叭、耳機)。
		麥克風插孔	接受從外接麥克風所輸入的聲音。
2		USB 2.0 埠	連接到 USB 2.0 裝置 (例如：USB 滑鼠、USB 網路攝影機)。
3		光碟機	內部光碟機，可放入 CD 或 DVD。
4		光碟存取指示燈	當正在存取光碟時，指示燈會亮起。
5		光碟退出鍵	可將光碟從光碟機中退出。
6		緊急退出孔	可在電腦關機狀態下退出光碟機托盤。 注意： 在電腦關機時將迴紋針插入緊急退出孔，即可退出光碟機托盤。
7		Kensington 安全鎖插槽	連接到與 Kensington 相容的電腦安全鎖。

底視圖



#	圖示	項目	說明
1		電池槽	用於安裝電腦的電池組。
2		電池組固定鎖	可將電池鎖到定位。
3		硬碟槽	安裝電腦硬碟的位置 (以螺絲鎖定)。
4		記憶體槽	用於安裝電腦的主記憶體。
5		散熱孔和冷卻風扇	可讓電腦在長時間使用後仍然能夠保持冷卻狀態。 注意： 請勿阻塞或擋住風扇開口。
6		電池卸除卡榫	用於卸下電池組。

環境

- 溫度：
 - 操作中：5°C 到 35°C
 - 非操作中：-20°C 到 65°C
- 溼度 (非冷凝狀態)：
 - 操作中：20% 到 80%
 - 非操作中：20% 到 80%

TravelMate 4740/4740Z/4340 系列

快速指南

© 2010 保留所有权利

TravelMate 4740/4740Z/4340 系列快速指南
初版发行日期：2010 年 3 月

TravelMate 4740/4740Z/4340 系列笔记本电脑

产品型号： _____

产品序号： _____

购买日期： _____

购买地点： _____

使用入门

感谢您选购 Acer 笔记本电脑，让它满足您随时随地使用计算机的需要。

用户指南

为帮助您设置和使用 Acer 笔记本电脑，我们为您设计了以下用户指南：

首先请按照电脑所附带的彩图来安装电脑。

TravelMate 系列普通用户指南包含了关于 TravelMate 产品系列所有型号的有用信息。该手册介绍了键盘和音频的使用方法等基本内容。请注意，鉴于手册的性质，**普通用户指南**和下文中提到的 **AcerSystem 用户指南**偶尔也会提及本系列产品中部分型号专有的功能或特性，但您购买的型号不一定具有这些功能或特性。以上情况会以“仅限部分型号”等字样在文中注明。

本**快速指南**介绍了您新购电脑的基本特性和功能。要了解您的电脑如何能够帮助您更加具有效益详情，请参见 **AcerSystem 用户指南**。本指南包含了诸如系统实用程序、数据恢复、扩展选项和疑难解答等信息。此外，它还包含了保修信息和笔记本电脑的一般规则和安全注意事项。我们也提供了 PDF 格式的用户指南并已预先安装在本电脑中供用户参考。按这些步骤访问：

1 单击  **开始** > **所有程序** > **AcerSystem**。

2 单击 **AcerSystem 用户指南**。



注：查看 PDF 文件需要预先安装 Adobe Reader。如果您的电脑没有预先安装 Adobe Reader，单击 **AcerSystem 用户指南** 后将会先启动 Adobe Reader 安装程序。依屏幕上指导完成安装程序。要获得如何使用 Adobe Reader 的指导，请使用“**帮助和支持**”菜单。

熟悉 Acer 笔记本电脑

当您按照彩图中的示例安装完电脑后，就让我们一起来熟悉您的 Acer 笔记本电脑吧。

俯视图

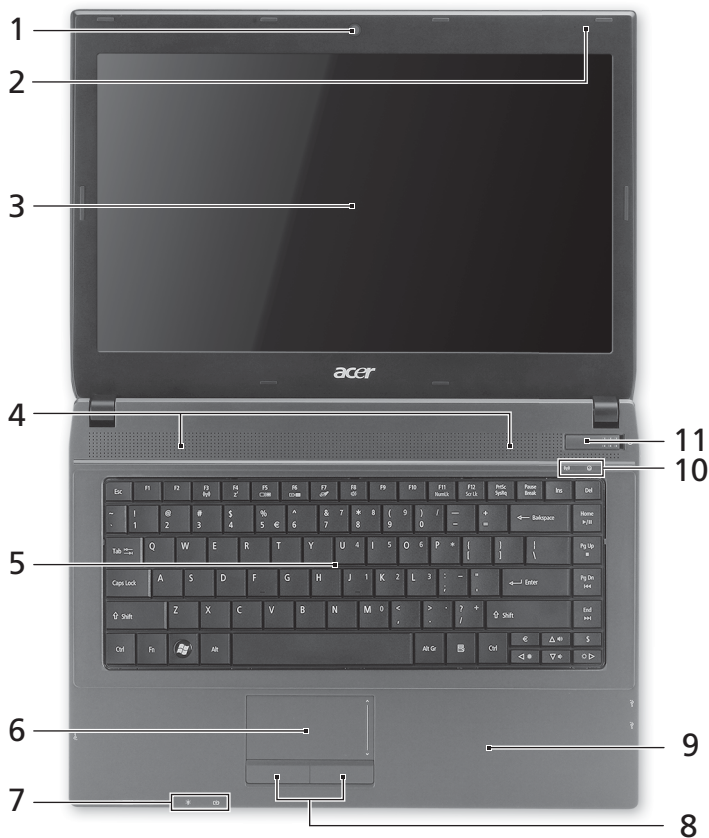

#	图标	项目	描述
1		Acer Crystal Eye 摄像头	用于视频通信的摄像头（仅限部分型号）。

#	图标	项目	描述
2		麦克风	用于录音的内置麦克风。
3		显示屏	也称液晶显示屏 (Liquid-Crystal Display : LCD), 用于显示电脑的输出内容 (不同型号配置可能有所不同)。
4		扬声器	左右扬声器可提供立体声输出。
5		键盘	将数据输入到电脑中。
6		触控板	触摸式定位设备, 功能和电脑鼠标相同。
7		电源指示灯 ¹	表示计算机的电源状态。
		电池指示灯 ¹	表示计算机的电池状态。 1. 正在充电: 电池充电时, 指示灯亮橘色。 2. 完全充电: 处在 AC 模式时, 指示灯亮蓝色。
8		单击按钮 (左和右)	左右按钮的功能与鼠标的左右键相同。
9		掌垫板	当您使用电脑时, 可舒适支撑手部的区域。
10		通信指示灯	根据亮灯情况可检视目前电脑无线连接设备的状态。
		硬盘指示灯	硬盘活动时, 该指示灯亮。
11		电源开关	用于打开和关闭计算机电源。

1. 即使在 LCD 显示屏关闩上也能看到前面板处的状态指示灯。



注: 实际规格将视用户实际购买的电脑型号而定。

热键

本款电脑提供热键或组合键来实现许多操控，例如：调节屏幕亮度以及音量输出。

要激活热键，先按住 <Fn> 键，然后再按热键组合中的另一个键。

热键	图标	功能	描述
<Fn> + <F3>		通信键	启用 / 禁用计算机的通信设备。 (通信设备根据配置可能有所不同。)
<Fn> + <F4>		睡眠	让电脑进入睡眠模式。
<Fn> + <F5>		显示屏幕切换	可以在以下三种显示方式间切换：只使用显示屏、只使用已连接的外部显示器、同时使用显示屏和外部显示器。
<Fn> + <F6>		显示屏关闭	关闭显示屏背光以节省电量。 按任意键将恢复正常显示。
<Fn> + <F7>		触摸板切换	打开或关闭内置触控板。
<Fn> + <F8>		扬声器切换	打开或关闭扬声器。
<Fn> + <F11>	NumLk	NumLock	打开或关闭嵌入式数字键盘。
<Fn> + <F12>	Scr Lk	Scroll Lock	当 Scroll Lock 键锁定时，您可分别按向上或向下键，屏幕即向上或向下移动一行。 Scroll Lock 键可能在某些应用程序中不起作用。
<Fn> + <▷>		调高亮度	提高屏幕亮度。
<Fn> + <◁>		调低亮度	调低屏幕亮度。
<Fn> + <△>		调高音量	调高扬声器音量。
<Fn> + <▽>		调低音量	调低扬声器音量。
<Fn> + <Home>		播放 / 暂停	播放或暂停选定媒体文件。
<Fn> + <Pg Up>		停止	停止播放选定媒体文件。
<Fn> + <Pg Dn>		上一步	返回上一个媒体文件。
<Fn> + <End>		下一个	跳至下一个媒体文件。





前视图

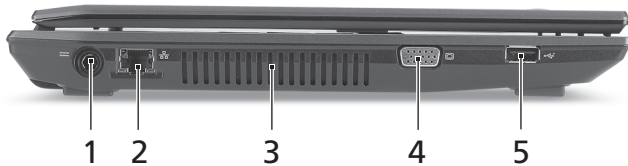

#	图标	项目	描述
1		多合 1 读卡器	<p>可支持 Secure Digital (SD)、MultiMediaCard (MMC)、Memory Stick (MS)、Memory Stick PRO (MS PRO)、xD-Picture Card (xD)。</p> <p>注：轻推取下 / 安装卡。任何时候，仅支持读取一张卡。</p>





左视图

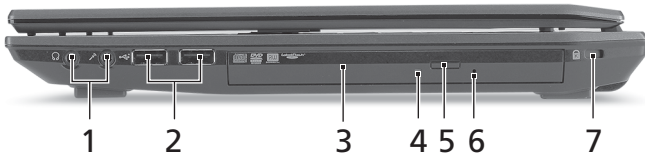

#	图标	项目	描述
1		直流电源输入插孔	连接交流适配器。
2		以太网 (RJ-45) 端口	连接 10/100/1000 以太网。
3		通风槽	可使电脑在长时间使用后仍保持低温。
4		外部显示器 (VGA) 端口	连接显示设备 (例如：外接显示器、LCD 投影机)。
5		USB 2.0 端口	连接 USB 2.0 装置 (例如：USB 鼠标、USB 相机)。





右视图



#	图标	项目	描述
1		耳机 / 扬声器 / 音频输出插孔	连接音频输出设备 (例如: 扬声器、耳机)。
		麦克风插孔	连接外接麦克风。
2		USB 2.0 端口	连接 USB 2.0 装置 (例如: USB 鼠标、USB 相机)。
3		光驱	内置光驱, 可支持读取 CD 或 DVD。
4		光驱访问指示灯	当光驱被激活时指示灯会亮起。
5		光驱弹出按钮	按下此按钮可弹出光驱。
6		紧急弹出孔	当电脑关闭时, 可弹出光驱托盘。 注: 如果计算机关闭, 请将回形针插入紧急弹出孔, 使光驱弹出。
7		Kensington 安全锁插槽	连接 Kensington 兼容电脑安全锁。

底视图



#	图标	项目	描述
1		电池槽	安装电池组。
2		电池锁	可固定锁紧电池组。
3		硬盘槽	安装电脑硬盘的位置（用螺丝紧固）。
4		内存槽	安装电脑主内存的位置。
5		通风槽和冷却风扇	可使电脑在长时间使用后仍保持低温。 注： 请勿遮挡风扇口。
6		电池释放门锁	释放电池门锁可取下电池组。

环境

- 温度：
 - 操作时：5°C 至 35°C
 - 不操作时：-20°C 至 65°C
- 湿度（非冷凝）：
 - 操作时：20% 至 80%
 - 不操作时：20% 至 80%

Seri TravelMate 4740/ 4740Z/4340

Panduan cepat

© 2010 Hak Cipta Dilindungi Undang-Undang.

Panduan Cepat Seri TravelMate 4740/4740Z/4340

Edisi Pertama: 03/2010

PC Notebook Seri TravelMate 4740/4740Z/4340

Nomor model: _____

Nomor seri: _____

Tanggal pembelian: _____

Alamat pembelian: _____

Informasi penting

Kami mengucapkan terima kasih kepada Anda yang telah memilih notebook Acer untuk memenuhi kebutuhan Anda akan komputer.

Panduan Anda

Kami telah mendesain serangkaian panduan guna membantu Anda menggunakan notebook Acer Anda:

Pertama-tama, poster ini membantu Anda mulai melakukan setup pada komputer Anda.

Panduan Pengguna Generik Seri TravelMate berisi informasi berguna yang berlaku untuk semua model dalam seri produk TravelMate. Panduan ini mencakup topik-topik dasar seperti menggunakan keyboard dan audio, dsb. Mohon dimengerti bahwa karena sifatnya, baik **Panduan Generik** maupun **AcerSystem User Guide** yang disebutkan di bawah ini kadang-kadang mengacu pada fungsi atau fitur yang hanya terdapat dalam model tertentu dalam seri ini, tetapi tidak terdapat dalam model yang telah Anda beli. Hal-hal seperti itu dalam teks ditandai dengan kata-kata seperti "hanya untuk model-model tertentu".

Panduan cepat ini akan menjelaskan fitur dan fungsi dasar komputer baru Anda. Untuk informasi lebih lanjut tentang cara komputer ini membantu Anda agar lebih produktif, lihat **AcerSystem User Guide**. Petunjuk ini berisi informasi rinci tentang topik, seperti utilitas sistem, pemulihan data, opsi-opsi ekspansi, dan pemecahan masalah. Di samping itu, panduan ini berisi informasi jaminan dan peraturan umum serta peringatan keselamatan untuk notebook Anda. Panduan tersebut tersedia dalam format PDF dan sudah tersedia dalam notebook Anda. Ikuti langkah ini untuk mengaksesnya:

- 1 Klik pada  **Mulai > Semua Program > AcerSystem**.
- 2 Klik **AcerSystem User Guide**.



.....

Catatan: Adobe Reader diperlukan untuk melihat file tersebut. Jika Adobe Reader belum diinstal dalam komputer Anda, klik **AcerSystem User Guide** untuk menjalankan program konfigurasi Adobe Reader terlebih dulu. Ikuti petunjuk pada layar untuk melakukan instalasi tersebut. Untuk petunjuk tentang cara menggunakan Adobe Reader, akses menu **Bantuan dan Dukungan**.

Tur Acer notebook Anda

Setelah melakukan setup pada komputer Anda sesuai dengan ilustrasi poster, mari kita lihat apa saja yang ada di laptop Acer baru Anda.

Pandangan atas

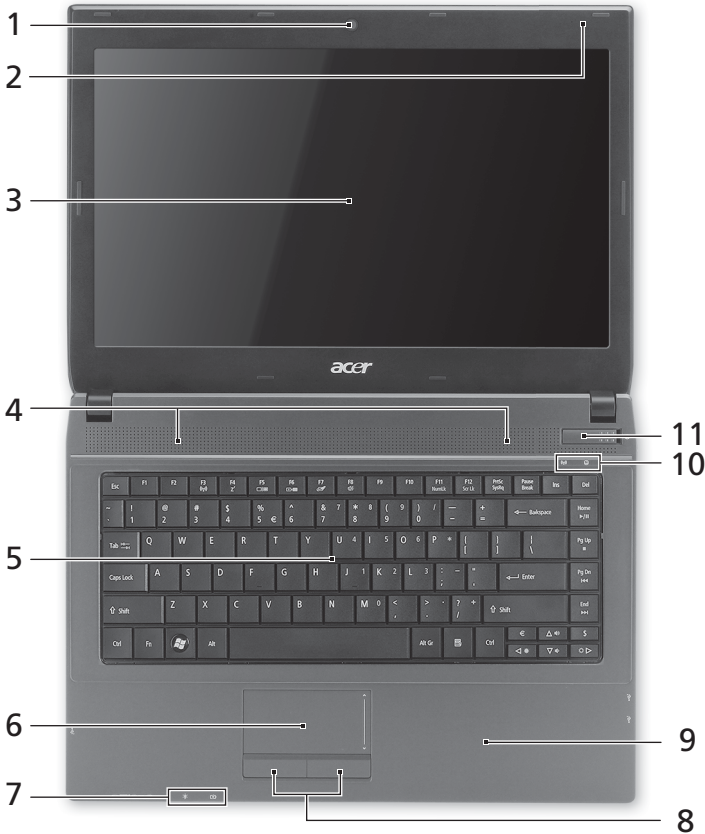

#	Ikon	Item	Keterangan
1		Webcam Acer Crystal Eye	Kamera web untuk komunikasi video (hanya untuk model tertentu).

#	Ikon	Item	Keterangan
2		Mikrofon	Mikrofon internal untuk perekaman suara.
3		Layar tampilan	Disebut juga sebagai LCD (Liquid-Crystal Display), akan menampilkan output komputer (konfigurasi mungkin berbeda tergantung model).
4		Pengeras suara	Pengeras suara kiri dan kanan menghadirkan keluaran audio stereo.
5		Keyboard	Untuk memasukkan data ke komputer.
6		Panel sentuh	Perangkat penunjuk sensitif sentuhan yang berfungsi seperti mouse komputer.
7		Indikator daya ¹	Menunjukkan status daya komputer.
		Indikator baterai ¹	Menunjukkan status baterai komputer. 1. Mengisi daya: Lampu akan menyala kuning kecokelatan bila daya baterai sedang diisi. 2. Daya terisi penuh: Lampu menyala biru bila dalam mode AC.
8		Tombol klik (kiri dan kanan)	Tombol kiri dan kanan berfungsi seperti tombol mouse kiri dan kanan.
9		Tempat tangan	Tempat nyaman untuk meletakkan tangan Anda sewaktu menggunakan komputer.
10		Indikator komunikasi	Menunjukkan status perangkat konektivitas nirkabel komputer.
		Indikator HDD	Menunjukkan bila drive hard disk aktif.
11		Tombol daya	Menghidupkan/mematikan komputer.

1. Indikator panel depan akan terlihat meskipun penutup komputer dalam keadaan tertutup.















Catatan: Konfigurasi yang pasti untuk PC Anda bergantung pada model yang Anda beli.

Tombol pintas

Komputer menggunakan tombol pintas atau kombinasi tombol untuk mengakses sebagian besar kontrol komputer, misalnya kecerahan layar dan output volume suara.

Untuk mengaktifkan tombol pintas, tekan terus tombol **<Fn>** sebelum menekan tombol lain pada kombinasi tombol pintas.

Tombol pintas	Ikon	Fungsi	Keterangan
<Fn> + <F3>		Tombol komunikasi	Mengaktifkan/menonaktifkan perangkat komunikasi komputer. (Perangkat komunikasi mungkin berbeda-beda berdasarkan konfigurasinya.)
<Fn> + <F4>		Sleep	Mengaktifkan komputer dalam mode Sleep.
<Fn> + <F5>		Toggle layar	Mengalihkan output tampilan antara layar tampilan, monitor eksternal (jika dipasang), dan keduanya.
<Fn> + <F6>		Tampilan mati	Menonaktifkan cahaya latar layar tampilan untuk menghemat daya. Tekan tombol apa saja untuk kembali.
<Fn> + <F7>		Tombol panel sentuh	Mengaktifkan dan menonaktifkan panel sentuh internal.
<Fn> + <F8>		Tombol speaker	Mengaktifkan dan menonaktifkan speaker.
<Fn> + <F11>	NumLk	NumLock	Mengaktifkan dan menonaktifkan keypad numerik tertanam.
<Fn> + <F12>	Scr Lk	Scroll Lock	Bila Scroll Lock diaktifkan, layar akan bergerak satu baris ke atas dan bawah saat menekan tombol tanda panah atas atau bawah. Scroll Lock tidak berfungsi pada aplikasi tertentu.
<Fn> + <◀>		Kecerahan meningkat	Meningkatkan kecerahan layar.
<Fn> + <◀◀>		Kecerahan berkurang	Mengurangi kecerahan layar.
<Fn> + <▲>		Volume naik	Menaikkan volume.
<Fn> + <▼>		Volume turun	Menurunkan volume.
<Fn> + <Home>		Putar/Jeda	Memutar atau menjeda file media yang dipilih.
<Fn> + <Pg Up>		Berhenti	Menghentikan pemutaran file media yang dipilih.

Tombol pintas	Ikon	Fungsi	Keterangan
<Fn> + <Pg Dn>	⏪	Sebelumnya	Kembali ke file media sebelumnya.
<Fn> + <End>	⏩	Berikutnya	Lompat ke file media berikutnya.

Pandangan depan tertutup



#	Ikon	Item	Keterangan
1		Pembaca kartu Multi-in-1	Menerima Secure Digital (SD), MultiMediaCard (MMC), Memory Stick (MS), Memory Stick PRO (MS PRO), xD-Picture Card (xD). Catatan: Tekan untuk melepas/memasang kartu. Hanya satu kartu yang bisa beroperasi saat Anda menggunakannya.



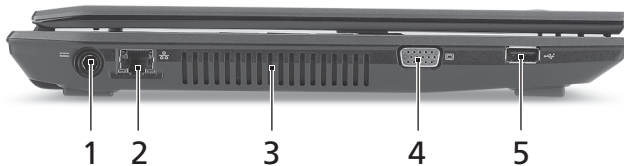

Pandangan kiri

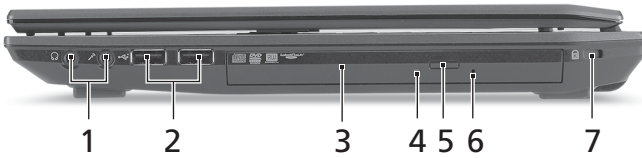

#	Ikon	Item	Keterangan
1		Jack DC-in	Menghubungkan ke Adaptor AC.
2		Port ethernet (RJ-45)	Menghubungkan ke jaringan berbasis ethernet 10/100/1000.
3		Slot ventilasi	Membuat komputer tetap dingin, bahkan setelah pemakaian yang lama.
4		Port tampilan (VGA) eksternal	Menghubungkan perangkat tampilan (mis., monitor eksternal, proyektor LCD).
5		Port USB 2.0	Menyambung ke perangkat USB 2.0 (misalnya, mouse USB, kamera USB).





Pandangan kanan

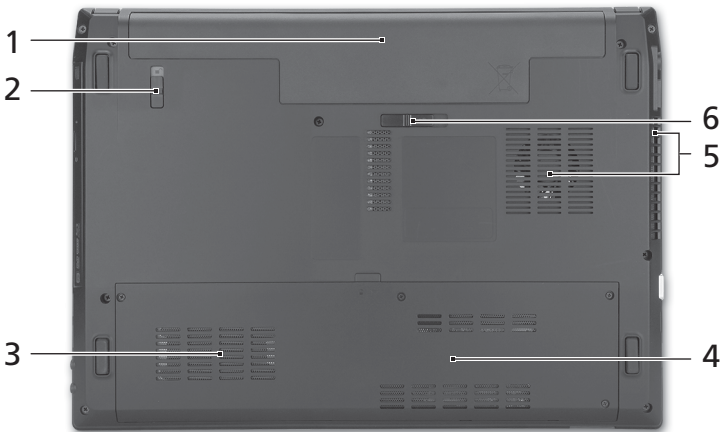

#	Ikon	Item	Keterangan
1		Jack headphone/ pengeras suara/ line-out	Menghubungkan ke perangkat sambungan keluar audio (misalnya, speaker, headphone).
		Jack mikrofon	Menerima input dari mikrofon eksternal.
2		Port USB 2.0	Menyambung ke perangkat USB 2.0 (misalnya, mouse USB, kamera USB).
3		Drive optik	Drive optik internal; menerima CD atau DVD.
4		Indikator akses disket optik	Menyala saat drive optik aktif.
5		Tombol pelepas drive optik	Mengeluarkan disk optik dari drive.
6		Lubang pelepas darurat	Melepas tempat drive optik saat komputer mati. Catatan: Masukkan klip kertas ke lubang pengeluaran darurat untuk mengeluarkan tray drive optik bila komputer mati.
7		Slot kunci Kensington	Menghubungkan ke kunci keamanan komputer yang kompatibel dengan kunci Kensington.

Tampilan bawah



#	Ikon	Item	Keterangan
1		Tempat baterai	Tempat kemasan baterai komputer.
2		Kunci baterai	Mengunci baterai pada tempatnya.
3		Bay hard disk	Untuk memasang hard disk komputer (dipasang dengan sekrup).
4		Kompartemen memori	Untuk memasang memori utama komputer.
5		Slot ventilasi dan kipas pendingin	Membuat komputer tetap dingin, bahkan setelah pemakaian yang lama. Catatan: Lubang kipas jangan sampai tertutup atau terhalang.
6		Penutup pelepas baterai	Untuk melepaskan baterai.

Lingkungan

- Suhu:
 - Beroperasi: 5°C hingga 35°C
 - Tidak beroperasi: -20° C hingga 65° C
- Kelembaban (non-kondensasi):
 - Beroperasi: 20% hingga 80%
 - Tidak beroperasi: 20% hingga 80%

ซีรีส์ TravelMate 4740/
4740Z/4340

คู่มืออย่างย่อ

© 2010 สงวนลิขสิทธิ์

คู่มืออย่างย่อ ซีรีส์ TravelMate 4740/4740Z/4340
คนฉบับ: 03/2010

โน้ตบุ๊กพีซี ซีรีส์ TravelMate 4740/4740Z/4340

หมายเลขรุ่น: _____

ซีเรียลนัมเบอร์: _____

วันที่ซื้อ: _____

สถานที่ซื้อ: _____

ก่อนอื่น

ขอขอบคุณที่คุณเลือกโน้ตบุ๊กจาก Acer เพื่อรองรับการใช้งานแบบพกพาของคุณ

คู่มือ

เพื่อช่วยสอนการใช้โน้ตบุ๊ก Acer เราจึงได้จัดทำคู่มือชุดนี้ขึ้น

โดยส่วนแรกในโปสเตอร์จะช่วยให้คุณสามารถเริ่มตั้งค่าต่าง ๆ ของคอมพิวเตอร์ของคุณได้

คู่มือผู้ใช้ทั่วไปเกี่ยวกับ TravelMate ซีรีส์ ประกอบไปด้วยข้อมูลที่เป็นประโยชน์สำหรับผลิตภัณฑ์ตระกูล

TravelMate ทุกรุ่น โดยระบุรายการทำงานเบื้องต้นต่าง ๆ เช่น การใช้คีย์บอร์ด ระบบเสียง ฯลฯ

เนื่องจากการจัดทำคู่มือแบบครอบคลุมรวม **Generic User Guide** และ **AcerSystem User Guide**

ซึ่งจะกล่าวถึงต่อไปนี้อาจมีฟังก์ชันหรือคุณสมบัติต่าง ๆ ที่มีอยู่เฉพาะในผลิตภัณฑ์บางรุ่นเท่านั้น

ซึ่งอาจไม่รวมถึงผลิตภัณฑ์รุ่นที่คุณจัดซื้อ

ตัวอย่างเช่นมีการแจ้งให้ทราบเป็นข้อความที่ระบุเฉพาะเจาะจงอย่าง "สำหรับบางรุ่น"

คู่มืออย่างย่อ เป็นข้อมูลคุณสมบัติและฟังก์ชันเบื้องต้นในคอมพิวเตอร์เครื่องใหม่ของคุณ

สอบถามข้อมูลการใช้งานคอมพิวเตอร์เพื่อให้เกิดประสิทธิภาพสูงสุดได้จาก **AcerSystem User Guide**

คู่มือนี้ประกอบไปด้วยข้อมูลโดยละเอียดเกี่ยวกับหัวข้อต่าง ๆ เช่นโปรแกรมรูดรหัสผ่านต่าง ๆ ของระบบ,

การกู้คืนข้อมูล, ทางเลือกในการเพิ่มขยาย และวิธีการแก้ไขปัญหา

นอกจากนี้ยังประกอบด้วยข้อมูลการรับประกัน ข้อบังคับทั่วไป

และการแจ้งเตือนด้านความปลอดภัยสำหรับโน้ตบุ๊กของคุณ ซึ่งมีให้ในรูปแบบ Portable Document Format

(PDF) และมาพร้อมกับโน้ตบุ๊กของคุณ ทำตามขั้นตอนดังต่อไปนี้เพื่อเรียกดู

- 1 คลิกที่  **Start (เริ่ม) > All Programs (โปรแกรมทั้งหมด) > AcerSystem**
- 2 คลิกที่ **AcerSystem User Guide**



หมายเหตุ: การดูไฟล์นี้จำเป็นต้องใช้ Adobe Reader ในกรณีที่ไม่ได้ติดตั้ง Adobe Reader ไว้ในคอมพิวเตอร์ กรุณาคลิกที่ **AcerSystem User Guide** จากนั้นโปรแกรมติดตั้ง Adobe Reader จะเปิดขึ้น ทำตามคำแนะนำบนจอแสดงผลเพื่อติดตั้งให้เสร็จสมบูรณ์ สำหรับขั้นตอนวิธีการใช้ Adobe Reader ให้เรียกดูได้จากเมนู **Help and Support (วิธีใช้และการสนับสนุน)**







แนะนำเกี่ยวกับโน้ตบุ๊ก Acer ของคุณ

หลังจากติดตั้งคอมพิวเตอร์ตามภาพในโปสเตอร์ ต่อไปนี้เป็นวิธีการใช้งานโน้ตบุ๊ก Acer ใหม่ของคุณ

มุมมองด้านบน



#	ไอคอน	รายการ	คำอธิบาย
1		เว็บแคม Acer Crystal Eye	กล่องเว็บแคมสำหรับการสื่อสารผ่านทางวิดีโอ (เฉพาะบางรุ่นเท่านั้น)

#	ไอคอน	รายการ	คำอธิบาย
2		ไมโครโฟน	ไมโครโฟนในตัวสำหรับบันทึกเสียง
3		จอแสดงผล	หรือ Liquid Crystal Display (LCD) ใช้แสดงข้อมูลต่าง ๆ ของคอมพิวเตอร์ (การกำหนดค่าอาจแตกต่างกันไปในแต่ละรุ่น)
4		ลำโพง	ลำโพงซ้ายและขวาเพื่อจ่ายสัญญาณเสียงระบบสเตอริโอ
5		คีย์บอร์ด	เพื่อป้อนข้อมูลเข้าสู่คอมพิวเตอร์ของคุณ
6		ทัชแพด	อุปกรณ์ชี้ตำแหน่งแบบสัมผัส ซึ่งทำงานแบบเดียวกับเมาส์คอมพิวเตอร์
7		ไฟแสดงสถานะพลังงาน ¹	ระบุสถานะการเปิดใช้งานคอมพิวเตอร์
		ไฟแสดงสถานะแบตเตอรี่ ¹	แสดงถึงสถานะแบตเตอรี่ของคอมพิวเตอร์ 1. กำลังชาร์จ: ไฟสว่างเป็นสีเหลืองอำพันเมื่อทำการชาร์จแบตเตอรี่ 2. ชาร์จไฟเต็ม: ไฟสีน้ำเงินติดสว่างขณะอยู่ในโหมด AC
8		ปุ่มคลิก (ซ้ายและขวา)	ปุ่มซ้ายและขวาทำงานเหมือนกับปุ่มเมาส์ซ้ายและขวา
9		ที่วางมือ	พื้นที่รองรับมือเพื่อให้รู้สึกสบายขณะใช้คอมพิวเตอร์
10		ไฟแสดงสถานะการสื่อสาร	แสดงถึงสถานะอุปกรณ์เชื่อมต่อแบบไร้สายของคอมพิวเตอร์
		ตัวแสดงสถานะ HDD	แสดงเมื่อฮาร์ดดิสก์ไดรฟ์มีการทำงาน
11		สวิตช์เปิดปิด	เปิดและปิดคอมพิวเตอร์

1. สัญลักษณ์ที่แผงด้านหน้าสามารถมองเห็นได้แม้ขณะปิดฝาพับคอมพิวเตอร์



หมายเหตุ: ส่วนประกอบที่แน่นชัดของเครื่องพีซีของคุณจะขึ้นอยู่กับรุ่นที่จัดซื้อ

ปุ่มลัด

คอมพิวเตอร์จะมีคีย์ลัดหรือชุดแป้นกดเพื่อเข้าใช้งานส่วนควบคุมต่าง ๆ ของคอมพิวเตอร์ เช่น ความสว่างของหน้าจอและระดับเสียง

เพื่อเปิดใช้งานฮอตคีย์ ให้กดปุ่ม <Fn> ค้างเอาไว้ก่อนที่จะกดปุ่มอื่นในชุดฮอตคีย์

ฮอตคีย์	ไอคอน	ฟังก์ชัน	คำอธิบาย
<Fn> + <F3>		ปุ่มการสื่อสาร	เปิด/ปิดอุปกรณ์สื่อสารของคอมพิวเตอร์ (อุปกรณ์สื่อสารอาจแตกต่างกันในแต่ละรุ่น)
<Fn> + <F4>		สลีป	ตั้งคอมพิวเตอร์ให้อยู่ในโหมดสลีป
<Fn> + <F5>		สลีบจอแสดงผล	สลีบเอาที่พู่ทจอแสดงผลระหว่างหน้าจอแสดงผล, จอแสดงผลภายนอก (หากเชื่อมต่ออยู่) และทั้งสองชนิด
<Fn> + <F6>		ปิดการแสดงผล	ปิดไฟพื้นหลังจอแสดงผลเพื่อประหยัดพลังงาน กดปุ่มใดก็ได้เพื่อเปิดหน้าจอกลับมาอีกครั้ง
<Fn> + <F7>		สวิทช์เปิดปิดแป้นสัมผัส	เปิดและปิดทัชแพดบนเครื่อง
<Fn> + <F8>		เปิดปิดลำโพง	เปิดและปิดลำโพง
<Fn> + <F11>	NumLk	NumLock	เปิดหรือปิดคีย์ตัวเลข
<Fn> + <F12>	Scr Lk	Scroll Lock	เมื่อเปิด Scroll Lock หน้าจอจะเลื่อนขึ้นหรือลงครั้งละหนึ่งบรรทัดเมื่อคุณกดปุ่มลูกศรขึ้นหรือลง Scroll Lock ไม่สามารถทำงานได้กับแอปพลิเคชันบางตัว
<Fn> + <+>		เพิ่มความสว่าง	เพิ่มความสว่างของหน้าจอ
<Fn> + <->		ลดความสว่าง	ลดความสว่างของหน้าจอ
<Fn> + <+Δ>		เพิ่มเสียง	เพิ่มระดับเสียง
<Fn> + <-Δ>		ลดเสียง	ลดระดับเสียง
<Fn> + <+Home>		เล่น/หยุดเล่น	เล่นหรือหยุดเล่นไฟล์มีเดียชั่วคราว
<Fn> + <+Pg Up>		หยุด	หยุดการเล่นไฟล์มีเดีย
<Fn> + <+Pg Dn>		ก่อนหน้า	กลับสู่ไฟล์มีเดียก่อนหน้า
<Fn> + <+End>		ถัดไป	ไปสู่อไฟล์มีเดียถัดไป





ปิดมุมมองด้านบน

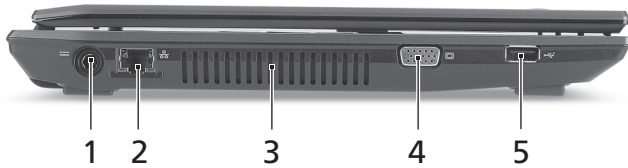

#	ไอคอน	รายการ	คำอธิบาย
1		การรีดเดอร์มัลติมีเดีย	สามารถใช้งานร่วมกับ Secure Digital (SD), MultiMediaCard (MMC), Memory Stick (MS), Memory Stick PRO (MS PRO), xD-Picture Card (xD) หมายเหตุ: กดเพื่อถอด/ใส่การ์ด ใช้งานการรีดได้ครั้งละหนึ่งชุดเท่านั้น





มุมมองด้านซ้าย

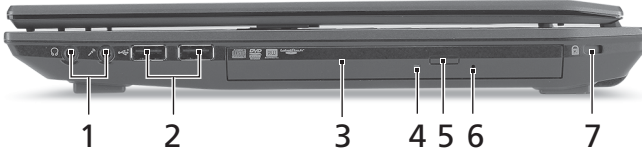

#	ไอคอน	รายการ	คำอธิบาย
1		ช่องเสียบ DC-in	เชื่อมต่อกับอะแดปเตอร์ AC
2		พอร์ต Ethernet (RJ-45)	เชื่อมต่อเครือข่าย Ethernet 10/100/1000
3		ช่องระบายอากาศ	ช่วยให้คอมพิวเตอร์เย็น แม้อหลังจากใช้งานเป็นเวลานาน
4		พอร์ตจอแสดงผลต่อพ่วง (VGA)	เชื่อมต่อกับจอแสดงผล (เช่น จอภาพภายนอก, โปรเจคเตอร์ LCD)
5		พอร์ต USB 2.0	เชื่อมต่อกับอุปกรณ์ USB 2.0 (เช่น เม้าส์หรือกล้อง USB)



มุมมองด้านขวา

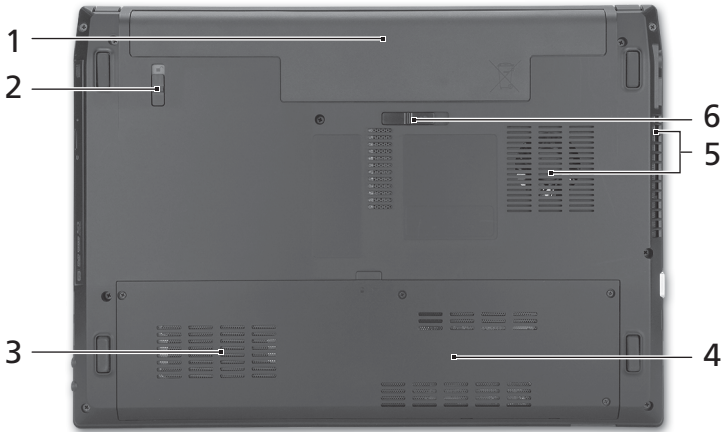

#	ไอคอน	รายการ	คำอธิบาย
1		ช่องเสียบหูฟัง/ลำโพง/line-out	ใช้สำหรับต่ออุปกรณ์เสียงขาออก (เช่น ลำโพง ชุดหูฟัง)
		ช่องเสียบไมโครโฟน	ใช้สำหรับต่อไมโครโฟน
2		พอร์ต USB 2.0	เชื่อมต่อกับอุปกรณ์ USB 2.0 (เช่น เม้าส์หรือกล้อง USB)
3		ไดรฟ์ออปติคัล	ไดรฟ์ออปติคัลภายใน สำหรับใส่ CD หรือ DVD
4		ไฟแสดงการอ่านออปติคัลดิสก์	ติดสว่างเมื่อมีการอ่านแผ่นออปติคัล
5		ปุ่มคีตแผ่นออปติคัลออก	นำแผ่นออปติคัลออกจากไดรฟ์
6		ปุ่มนำแผ่นออกฉุกเฉิน	ใช้เปิดถาดใส่แผ่นออปติคัลขณะปิดคอมพิวเตอร์ หมายเหตุ: สอดคลิปหนีบกระดาษเข้าในช่องนำแผ่นออกฉุกเฉิน เพื่อเปิดถาดใส่แผ่นออปติคัลขณะปิดคอมพิวเตอร์อยู่
7		สล๊อตล็อก Kensington	พ่วงต่อกับระบบล็อกความปลอดภัยสำหรับคอมพิวเตอร์ที่ใช้งานร่วมกับ Kensington

มุมมองด้านล่าง



#	ไอคอน	รายการ	คำอธิบาย
1		ช่องใส่แบตเตอรี่	ใช้สำหรับเก็บแพ็คแบตเตอรี่ของคอมพิวเตอร์
2		ล็อกแบตเตอรี่	ล็อกแบตเตอรี่ให้อยู่ในตำแหน่ง
3		ช่องใส่ฮาร์ดดิสก์	ใช้ติดตั้งฮาร์ดดิสก์ของคอมพิวเตอร์ (ยึดด้วยสกรู)
4		ช่องหน่วยความจำ	ที่อยู่ของหน่วยความจำของคอมพิวเตอร์
5		สลัสดูอุปกรณ์ระบายอากาศและพัดลมระบายความร้อน	ช่วยให้คอมพิวเตอร์เย็น แม้หลังจากใช้งานเป็นเวลานาน หมายเหตุ: ห้ามปิดทางช่องเปิดสำหรับพัดลม
6		สลักปลดล็อกแบตเตอรี่	ปลดล็อกเพื่อนำแบตเตอรี่ออก

สิ่งแวดล้อม

- อุณหภูมิ:
 - ขณะทำงาน: 5°C ถึง 35°C
 - ขณะไม่ได้ใช้งาน: -20°C ถึง 65°C
- ความชื้น (ไม่ควบนั่นเป็นไอน้ำ):
 - ขณะทำงาน: 20% ถึง 80%
 - ขณะไม่ได้ใช้งาน: 20% ถึง 80%

