

English  
Français  
Deutsch  
Italiano  
Español  
Português  
Nederlands  
Norsk  
Dansk  
Svenska  
Suomi  
Русский  
Polski  
Magyar  
Čeština  
Slovenčina  
Slovenski  
Hrvatski  
Română  
Български  
Eesti  
Latviski  
Lietuviškai  
Ελληνικά  
Türkçe  
日本語  
한국어  
繁體中文  
简体中文  
Bahasa Indonesia  
ไทย

# Contents



# Acer Notebook

## Quick Guide

© 2010 All Rights Reserved.

Acer Notebook Quick Guide  
Original Issue: 03/2010

Model number: \_\_\_\_\_

Serial number: \_\_\_\_\_

Date of purchase: \_\_\_\_\_

Place of purchase: \_\_\_\_\_

# First things first

We would like to thank you for making an Acer notebook your choice for meeting your mobile computing needs.

## Your guides

To help you use your Acer notebook, we have designed a set of guides:

First off, the **Just for Starters...** poster helps you get started with setting up your computer.

The **Aspire Series Generic User Guide** contains useful information applying to all models in the Aspire product series. It covers basic topics such as using the keyboard and audio, etc. Please understand that due to its nature, the **Generic User Guide** as well as the **AcerSystem User Guide** mentioned below will occasionally refer to functions or features which are only contained in certain models of the series, but not necessarily in the model you purchased. Such instances are marked in the text with language such as "only for certain models".

The **Quick Guide** introduces you to the basic features and functions of your new computer. For more on how your computer can help you to be more productive, please refer to the **AcerSystem User Guide**. This guide contains detailed information on such subjects as system utilities, data recovery, expansion options and troubleshooting. In addition it contains warranty information and the general regulations and safety notices for your notebook. It is available in Portable Document Format (PDF) and comes preloaded on your notebook. Follow these steps to access it:

- 1 Click on  **Start > All Programs > AcerSystem.**
- 2 Click on **AcerSystem User Guide.**



.....

**Note:** Viewing the file requires Adobe Reader. If Adobe Reader is not installed on your computer, clicking on **AcerSystem User Guide** will run the Adobe Reader setup program first. Follow the instructions on the screen to complete the installation. For instructions on how to use Adobe Reader, access the **Help and Support** menu.







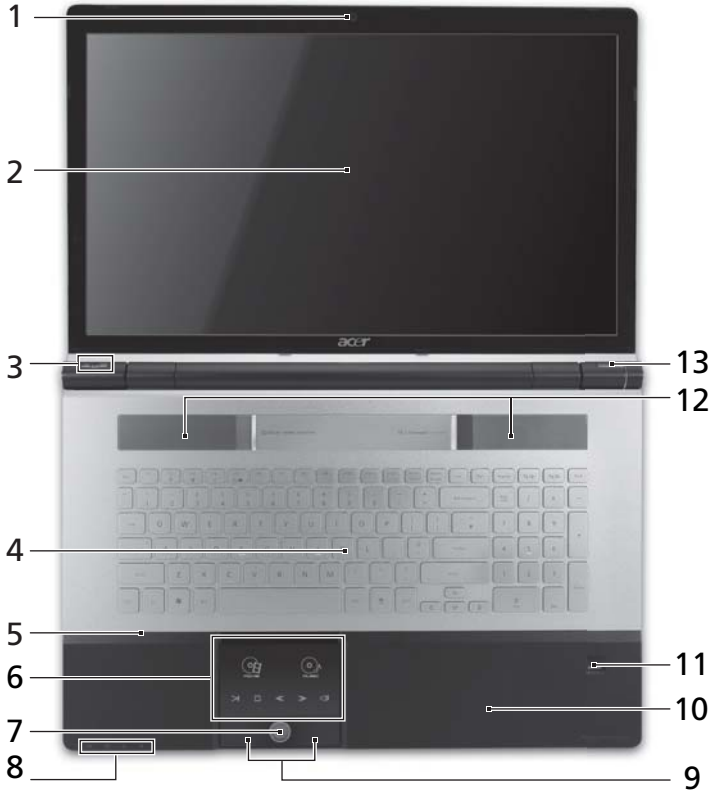





# Your Acer notebook tour

After setting up your computer as illustrated in the **Just for Starters...** poster, let us show you around your new Acer notebook.

## Top view



#	Icon	Item	Description
1		Acer Crystal Eye webcam	Web camera for video communication. (only for certain models)
2		Display screen	Also called Liquid-Crystal Display (LCD), displays computer output (configuration may vary by models).

#	Icon	Item	Description
3		Arcade key	Launches InstantOn Arcade.
	P	P key / Acer PowerSmart key	Programmable key (configuration may vary by model). / Puts your computer into power-saving mode (configuration may vary by model).
4		Keyboard	For entering data into your computer.
5		Microphone	Internal microphone for sound recording.
6		Touchpad / Media Console	Touch-sensitive pointing device which functions like a computer mouse*. / Touch sensitive controls for Acer Arcade, volume (up/down) and media (play/pause, stop, previous, next); with mute.
		Movie	Launch movie playback software.
		Music	Launch music playback software.
		Play/pause	Play or pause a selected media file.
		Stop	Stop playing the selected media file.
		Previous	Return to the previous media file.
		Next	Jump to the next media file.
		Mute	Turn the volume on or off.
			* Touchpad becomes inactive when Media Console is active.
7		Media Console controller	Turns Media Console on or off.
8		Communication key	Enables/disables the computer's communication devices. (Communication devices may vary by configuration.)
		Backup key	Launches Acer Backup Management for three-step data backup.
		HDD indicator <sup>1</sup>	Indicates when the hard disk drive is active.
		Power indicator <sup>1</sup>	Indicates the computer's power status.







#	Icon	Item	Description
9		Click buttons (left and right)	The left and right buttons function like the left and right mouse buttons.
10		Palmrest	Comfortable support area for your hands when you use the computer.
11		Acer Bio-Protection fingerprint reader	Supports Acer FingerNav 4-way control function (only for certain models).
12		Speakers	Deliver stereo audio output.
13		Power button	Turns the computer on and off.

1. The front panel indicators are visible even when the computer cover is closed up.





## Hotkeys

The computer employs hotkeys or key combinations to access most of the computer's controls like screen brightness and volume output.

To activate hotkeys, press and hold the <Fn> key before pressing the other key in the hotkey combination.

Hotkey	Icon	Function	Description
<Fn> + <F3>		Communication key	Enables/disables the computer's communication devices. (Communication devices may vary by configuration.)
<Fn> + <F4>		Sleep	Puts the computer in Sleep mode.
<Fn> + <F5>		Display toggle	Switches display output between the display screen, external monitor (if connected) and both.
<Fn> + <F6>		Screen blank	Turns the display screen backlight off to save power. Press any key to return.
<Fn> + <F7>		Touchpad toggle	Turns the internal touchpad on and off.
<Fn> + <F8>		Speaker toggle	Turns the speakers on and off.
<Fn> + <D>		Brightness up	Increases the screen brightness.



Hotkey	Icon	Function	Description
<Fn> + <⇐>		Brightness down	Decreases the screen brightness.
<Fn> + <Home>		Play/Pause	Play or pause a selected media file.
<Fn> + <Pg Up>		Stop	Stop playing the selected media file.
<Fn> + <Pg Dn>		Previous	Return to the previous media file.
<Fn> + <End>		Next	Jump to the next media file.

## Closed front view



#	Icon	Item	Description
1		Thumbwheel	Turn the volume up or down.
2		Multi-in-1 card reader	Accepts Secure Digital (SD), MultiMediaCard (MMC), Memory Stick (MS), Memory Stick PRO (MS PRO), xD-Picture Card (xD). <b>Note:</b> Push to remove/install the card. Only one card can operate at any given time.
3		CIR receiver	Receives signals from a remote control.

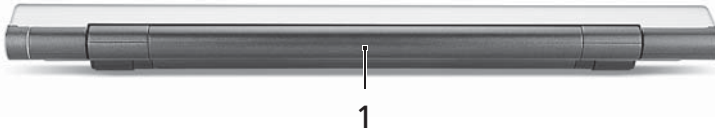

## Rear view





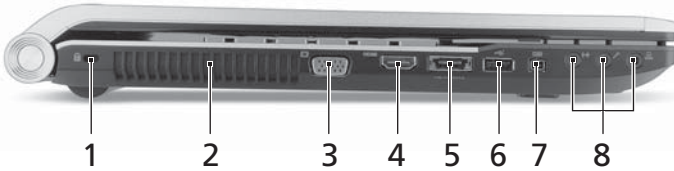

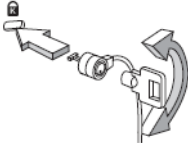
#	Icon	Item	Description
1		Battery bay	Houses the computer's battery pack.

## Left view





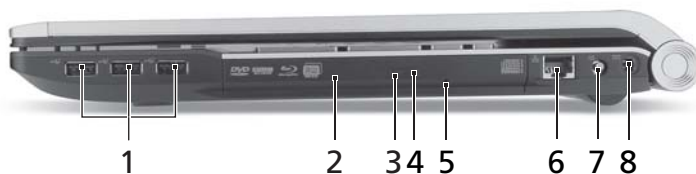

#	Icon	Item	Description
1		Kensington lock slot 	Connects to a Kensington-compatible computer security lock. <b>Note:</b> Wrap the computer security lock cable around an immovable object such as a table or handle of a locked drawer. Insert the lock into the notch and turn the key to secure the lock. Some keyless models are also available.
2		Ventilation slots	Enable the computer to stay cool, even after prolonged use.
3		External display (VGA) port	Connects to a display device (e.g., external monitor, LCD projector).
4	HDMI	HDMI port	Supports high definition digital video connections.
5		USB 2.0 / e SATA port	Connects to USB 2.0 or eSATA devices (only for certain models). <b>Note:</b> If you plug an eSATA device you will have three USB ports available in the meantime.

#	Icon	Item	Description
6		USB 2.0 port	Connects to USB 2.0 devices (e.g., USB mouse, USB camera).
7		4-pin IEEE 1394 port	Connects to IEEE 1394 devices.
8		Line-in jack	Accepts audio line-in devices (e.g., audio CD player, stereo walkman, mp3 player)
		Microphone-in jack	Accepts inputs from external microphones.
		Headphones/speaker/line-out jack with SPDIF support	Connects to audio line-out devices (e.g., speakers, headphones).

## Right view







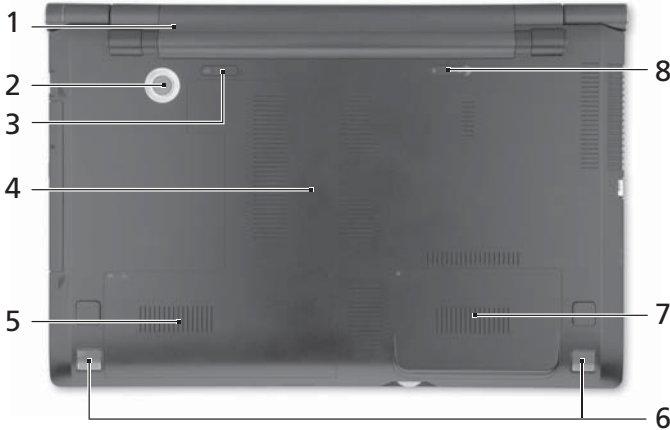

#	Icon	Item	Description
1		USB 2.0 ports	Connect to USB 2.0 devices (e.g., USB mouse, USB camera).
2		Optical drive	Internal optical drive; accepts CDs or DVDs.
3		Optical disk access indicator	Lights up when the optical drive is active.
4		Optical drive eject button	Ejects the optical disk from the drive.
5		Emergency eject hole	Ejects the optical drive tray when the computer is turned off. <b>Note:</b> Insert a paper clip to the emergency eject hole to eject the optical drive tray when the computer is off.
6		Ethernet (RJ-45) port	Connects to an Ethernet 10/100/1000-based network.

#	Icon	Item	Description
7		RF-in port	Accepts input signals from digital TV-tuner devices. (only for certain models)
8		DC-in jack	Connects to an AC adapter.

## Base view



#	Icon	Item	Description
1		Battery bay	Houses the computer's battery pack.
2		Sub woofer	Emits low frequency sound output.
3		Battery release latch	Releases the battery for removal.
4		Memory compartment	Houses the computer's main memory.
5		Hard disk bay-Main	Houses the computer's hard disk (secured with screws).
6		Speakers	Deliver stereo audio output.
7		Hard disk bay-Secondary	Houses the computer's hard disk (secured with screws) (for certain models only).
8		Battery lock	Locks the battery in position.

## Environment

---

- Temperature:
    - Operating: 5 °C to 35 °C
    - Non-operating: -20 °C to 65 °C
  - Humidity (non-condensing):
    - Operating: 20% to 80%
    - Non-operating: 20% to 80%
-



# Notebook Acer

Guide rapide

© 2010 Tous droits réservés.

Guide rapide du notebook Acer  
Première publication : 03/2010

Modèle : \_\_\_\_\_

No. de série : \_\_\_\_\_

Date d'achat : \_\_\_\_\_

Lieu d'achat : \_\_\_\_\_



# Pour commencer

Nous désirons vous remercier d'avoir fait d'un notebook Acer votre choix pour répondre à vos besoins informatiques mobiles.

## Vos guides

Pour vous aider à utiliser votre notebook Acer, nous avons conçu plusieurs guides :

Tout d'abord, le poster **Pour partir du bon pied...** vous aide à configurer votre ordinateur.

Le **Guide utilisateur générique de la gamme Aspire** contient des informations utiles qui s'appliquent à tous les modèles de la gamme des produits Aspire. Il couvre les sujets de base, telles que l'utilisation du clavier, du son, etc. Il faut comprendre que du fait de sa nature, le **Guide utilisateur générique** ainsi que le **AcerSystem User Guide** mentionné ci-dessous fera référence parfois à des fonctions ou des caractéristiques qui ne sont contenues que dans certains modèles de la gamme, mais pas nécessaire dans le modèle que vous avez acheté. Ces cas sont marqués dans le texte avec des mentions telles que « seulement pour certains modèles ».

Le **Guide rapide** présente les fonctionnalités et fonctions de base de votre ordinateur. Pour plus d'information sur l'aide que peut vous apporter pour être plus productif, veuillez vous reporter à **AcerSystem User Guide**. Ce guide contient des informations détaillées sur des sujets tels que les utilitaires systèmes, la récupération des données, les options d'extension et le dépannage. De plus, il contient des informations de garantie et les réglementations générales et les avis de sécurité pour votre notebook. Il est disponible au format PDF (Portable Document Format) et est préchargé sur votre notebook. Procédez comme suit pour y accéder :

- 1 Cliquez sur  **Démarrer** > **Tous les programmes** > puis **AcerSystem**.
- 2 Cliquez sur **AcerSystem User Guide**.



.....

**Remarque :** L'affichage du fichier nécessite Adobe Reader. Si Adobe Reader n'est pas installé dans votre ordinateur, le clic sur **AcerSystem User Guide** va exécuter le programme d'installation d'Adobe Reader. Suivez les instructions à l'écran pour terminer l'installation. Pour des instructions sur l'utilisation de Adobe Reader, accédez au menu **Aide et Support**.







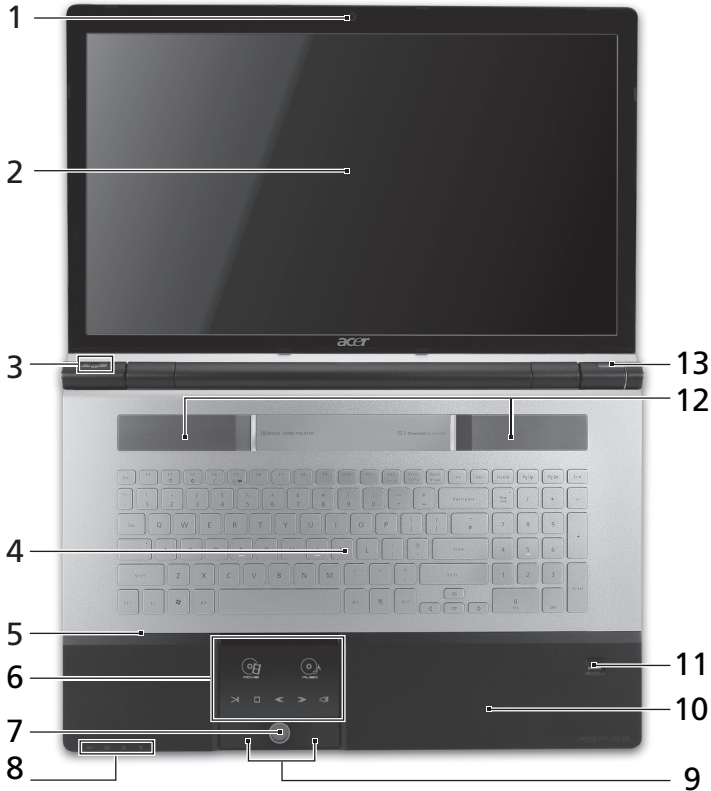

# Votre visite guidée du notebook Acer

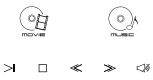



Après avoir configuré votre ordinateur comme illustré dans le poster **Pour partir du bon pied...**, nous allons vous faire explorer votre nouveau notebook Acer.

## Vue supérieure



#	Icône	Élément	Description
1		Webcam Acer Crystal Eye	Webcam pour communication video (seulement pour certains modèles).

#	Icône	Élément	Description
2		Écran d'affichage	Également appelé écran LCD (Liquid Crystal Display), affiche les données de l'ordinateur (la configuration peut varier en fonction des modèles).
3		Touche Arcade	Lance InstantOn Arcade.
	P	Touche P/Touche Acer PowerSmart	Touche programmable (la configuration peut varier en fonction du modèle)./ Place votre ordinateur en mode d'économie d'énergie (la configuration peut varier en fonction du modèle).
4		Clavier	Pour l'entrée des informations dans votre ordinateur.
5		Microphone	Microphone interne pour l'enregistrement sonore.
6		Touchpad/ Console média	Périphérique de pointage sensible au touché qui fonctionne comme une souris*./ Contrôles tactiles pour Acer Arcade, volume (+/-) et média (lecture/pause, arrêt, précédent, suivant) ; avec muet.
		Film	Lancez le logiciel de lecture de film.
		Musique	Lancez le logiciel de lecture de musique.
		Lecture/ Pause	Lisez ou effectuez une pause d'un fichier multimédia sélectionné.
		Arrêter	Arrêtez la lecture du fichier multimédia sélectionné.
		Précédent	Retournez au fichier multimédia précédent.
		Suiv	Passer au fichier multimédia suivant.
		Muet	Activer ou désactiver le volume.
			* Le touchpad devient inactif quand la Console média est active.
7		Contrôleur de la Console média	Active ou désactive la Console média.













#	Icône	Élément	Description
8		Touche Communication	Active/désactive les périphériques de communication de l'ordinateur. (Les périphériques de communication peuvent varier en fonction de la configuration.)
		Touche de sauvegarde	Lance Acer Backup Management pour une sauvegarde des données en trois étapes.
		Indicateur du disque dur <sup>1</sup>	Indique l'activité du disque dur.
		Indicateur d'alimentation <sup>1</sup>	Indique l'état d'alimentation de l'ordinateur.
9		Boutons (gauche et droit)	Le bouton gauche et le bouton droit fonctionnent comme le bouton gauche et le bouton droit d'une souris.
10		Repose mains	Zone de support confortable pour vos mains lorsque vous utilisez l'ordinateur.
11		Lecteur d'empreinte digitale Acer Bio-Protection	Prend en charge la fonction de contrôle quadridirectionnel Acer FingerNav (seulement pour certains modèles).
12		Haut-parleurs	Produit le son stéréo.
13		Bouton Marche/Arrêt	Met l'ordinateur sous tension et hors tension.

1. Les indicateurs du panneau avant sont visibles même lorsque l'écran LCD est fermé.

## Touches spéciales

L'ordinateur emploie des touches spéciales (combinaisons de touches) pour accéder à la plupart des contrôles de l'ordinateur comme la luminosité de l'écran et le volume sonore.

Pour activer les touches spéciales, appuyez et maintenez la touche <Fn> avant d'appuyer sur l'autre touche dans la combinaison de la touche spéciale.

Touche spéciale	Icône	Fonction	Description
<Fn> + <F3>		Touche Communication	Active/désactive les périphériques de communication de l'ordinateur. (Les périphériques de communication peuvent varier en fonction de la configuration.)
<Fn> + <F4>		Sommeil	Place l'ordinateur en mode de Sommeil.
<Fn> + <F5>		Choix de l'affichage	Permet de permuter l'affichage entre l'écran d'affichage, le moniteur externe (s'il est connecté) et les deux.
<Fn> + <F6>		Écran noir	Désactive le rétro éclairage de l'écran pour économiser l'énergie. Appuyez sur une touche pour le rallumer.
<Fn> + <F7>		Touchpad	Active et désactive le touchpad.
<Fn> + <F8>		Haut-parleur	Active et désactive les haut-parleurs.
<Fn> + <D>>		Accroissement de la luminosité	Augmente la luminosité de l'écran.
<Fn> + <D<		Décroissement de la luminosité	Diminue la luminosité de l'écran.
<Fn> + <Origine>		Lecture/Pause	Lisez ou effectuez une pause d'un fichier multimédia sélectionné.
<Fn> + <Pg préc.>		Arrêter	Arrêtez la lecture du fichier multimédia sélectionné.
<Fn> + <Pg suiv.>		Précédent	Retournez au fichier multimédia précédent.
<Fn> + <Fin>		Suiv	Passez au fichier multimédia suivant.

## Vue frontale fermée



#	Icône	Élément	Description
1		Molette	Augmentez ou diminuez le volume.
2		Lecteur de cartes multiples en un	Accepte une carte mémoire Secure Digital (SD), MultiMediaCard (MMC), Memory Stick (MS), Memory Stick Pro (MS PRO), et xD-Picture (xD). <b>Remarque</b> : Poussez pour retirer/installer la carte. Seule une carte peut fonctionner à un moment donné.
3		Récepteur CIR	Reçoit les signaux de la télécommande.



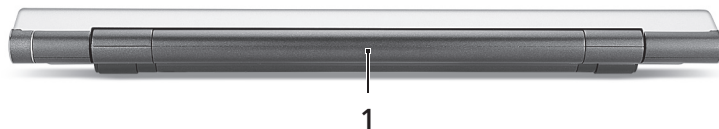

## Vue arrière



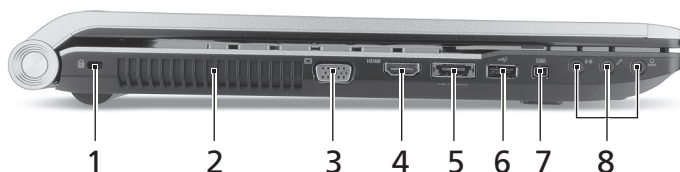

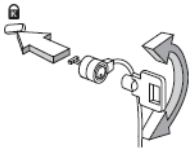
#	Icône	Élément	Description
1		Baie de la batterie	Contient la batterie de l'ordinateur.

## Vue gauche





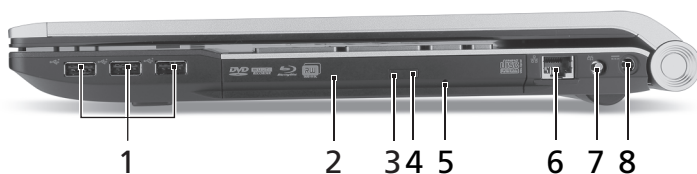

#	Icône	Élément	Description
1		Fente pour cadenas Kensington 	Se connecte à un cadenas de sécurité pour ordinateur Kensington. <b>Remarque :</b> Enroulez le câble du cadenas de sécurité pour ordinateur autour d'une table, de la poignée d'un tiroir verrouillé, ou de tout autre objet fixe. Insérez le cadenas dans l'encoche et tournez la clef pour verrouiller le cadenas. Certains modèles ne possèdent pas de clef.
2		Fentes de ventilation	Permettent à l'ordinateur de rester froid, même après une longue utilisation.
3		Port d'affichage (VGA) externe	Se connecte à un périphérique d'affichage (p.ex. un moniteur externe, un projecteur LCD).
4	HDMI	Port HDMI	Prend en charge les connexions vidéo numériques à haute définition.
5		Port USB 2.0/eSATA	Se connecte à des périphériques USB 2.0 ou eSATA (seulement pour certains modèles). <b>Remarque :</b> Si vous connectez un périphérique eSATA, vous aurez trois ports USB également disponibles.
6		Port USB 2.0	Se connecte à des périphériques USB 2.0 (p.ex. une souris USB, une caméra USB).
7		Port IEEE 1394 à 4 broches	Se connecte à des périphériques IEEE 1394.

#	Icône	Élément	Description
8		Prise d'entrée audio	Accepte des périphériques audio en entrée (p.ex. un lecteur de CD audio, un baladeur stéréo ou lecteur MP3).
		Prise d'entrée microphone	Accepte les entrées de microphones externes.
		Prise de sortie audio/haut-parleur/casque avec prise en charge de S/PDIF	Se connecte à des périphériques audio en sortie (p.ex. haut-parleurs ou un casque stéréo).

## Vue droite







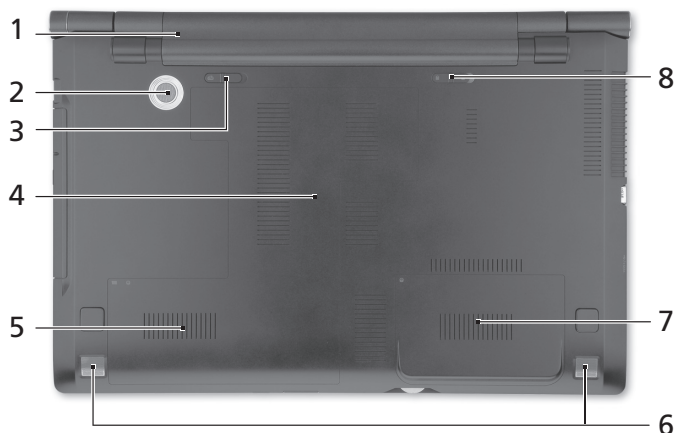

#	Icône	Élément	Description
1		Ports USB 2.0	Se connectent à des périphériques USB 2.0 (p.ex. une souris USB, une caméra USB).
2		Lecteur optique	Lecteur optique interne, accepte les CD ou les DVD.
3		Indicateur d'accès du disque optique	S'allume lorsque le lecteur optique est actif.
4		Bouton d'éjection du lecteur optique	Éjecte le disque optique du lecteur.
5		Trou d'éjection d'urgence	Éjecte le plateau du lecteur optique lorsque l'ordinateur est hors tension. <b>Remarque :</b> Insérez un trombone dans le trou d'éjection d'urgence pour éjecter le plateau du lecteur optique même quand l'ordinateur est éteint.
6		Port Ethernet RJ-45	Se connecte à un réseau Ethernet 10/100/1000 Base.
7		Port d'entrée RF	Accepte les signaux d'entrée des périphériques tuner TV numérique (seulement pour certains modèles).
8		Prise d'alimentation	Se connecte à l'adaptateur secteur.



## Vue de la base



#	Icône	Élément	Description
1		Baie de la batterie	Contient la batterie de l'ordinateur.
2		Caisson de basse	Émet la sortie sonore basse fréquence.
3		Loquet de libération de la batterie	Libère la batterie pour le retrait.
4		Compartiment mémoire	Contient la mémoire principale de l'ordinateur.
5		Baie du disque dur principal	Contient le disque dur de l'ordinateur (fixé avec des vis).
6		Haut-parleurs	Produit le son stéréo.
7		Baie du disque dur secondaire	Contient le disque dur de l'ordinateur (fixé avec des vis) (seulement pour certains modèles).
8		Verrou de la batterie	Verrouille la batterie en position.

## Environnement

---

- Température :
    - En marche : 5°C à 35°C
    - À l'arrêt : -20°C à 65°C
  - Humidité (sans condensation) :
    - En marche : 20% à 80%
    - À l'arrêt : 20% à 80%
-

# Acer-Notebook

Kurzanleitung

© 2010 Alle Rechte vorbehalten.

Acer-Notebook-Kurzanleitung  
Originalausgabe: 03/2010

Modellnummer: \_\_\_\_\_

Seriennummer: \_\_\_\_\_

Kaufdatum: \_\_\_\_\_

Kaufort: \_\_\_\_\_

# Das Wichtigste zuerst

Wir möchten uns bei Ihnen dafür bedanken, dass Sie sich in Bezug auf mobilen Computerbedarf für ein Acer-Notebook entschieden haben.

## Ihre Anweisungen

Als Hilfe für Sie beim Benutzen Ihres Acer-Notebooks haben wir einen Satz von Richtlinien aufgestellt:

Zuallererst hilft Ihnen das Übersichtsblättchen **Für den Anfang...**, Ihren Computer das erste Mal in Betrieb zu nehmen.

Die **Allgemeine Bedienungsanleitung für die Aspire Serie** enthält hilfreiche Informationen, die sich auf alle Modelle der Aspire-Produktserien beziehen. Es werden Themen wie z. B. die Verwendung der Tastatur, Audio usw. behandelt. Die **Allgemeine Bedienungsanleitung** und die **AcerSystem User Guide** können sich z. T. auf Funktionen oder Eigenschaften beziehen, die es nur in bestimmten Modellen der Serien und nicht unbedingt in dem von Ihnen erworbenen Modell gibt. Solche Stellen sind im Text als "Nur für bestimmte Modelle" gekennzeichnet.

Das **Kurzanleitung** stellt Ihnen die grundlegenden Features und Funktionen Ihres neuen Computers vor. Für weitere Informationen dazu, wie Ihnen Ihr Computer helfen kann, noch produktiver zu arbeiten, lesen Sie bitte den **AcerSystem User Guide**. Dieses Benutzerhandbuch enthält detaillierte Informationen zu Themen wie z. B. System-Programmen, Datenwiederherstellung, Erweiterungsoptionen und Problembhebung. Darüber hinaus enthält es Informationen zur Garantie und allgemeine Bestimmungen und Sicherheitshinweise zu Ihrem Notebook. Das Benutzerhandbuch steht in PDF (Portable Document Format) zur Verfügung und ist bereits in Ihrem Notebook installiert. Folgen Sie den folgenden Schritten, um auf das Benutzerhandbuch zuzugreifen:

- 1 Klicken Sie auf  **Start > Alle Programme > AcerSystem**.
- 2 Klicken Sie auf **AcerSystem User Guide**.



.....

**Hinweis:** Zum Betrachten der Datei muß Adobe Reader installiert sein. Wenn Adobe Reader nicht auf Ihrem Computer installiert ist, wird durch Klicken auf **AcerSystem User Guide** zuerst das Setup-Programm von Adobe Reader ausgeführt. Folgen Sie zum Durchführen der Installation den Anweisungen auf dem Bildschirm. Hinweise über die Verwendung von Adobe Reader finden Sie im Menü **Hilfe und Support**.







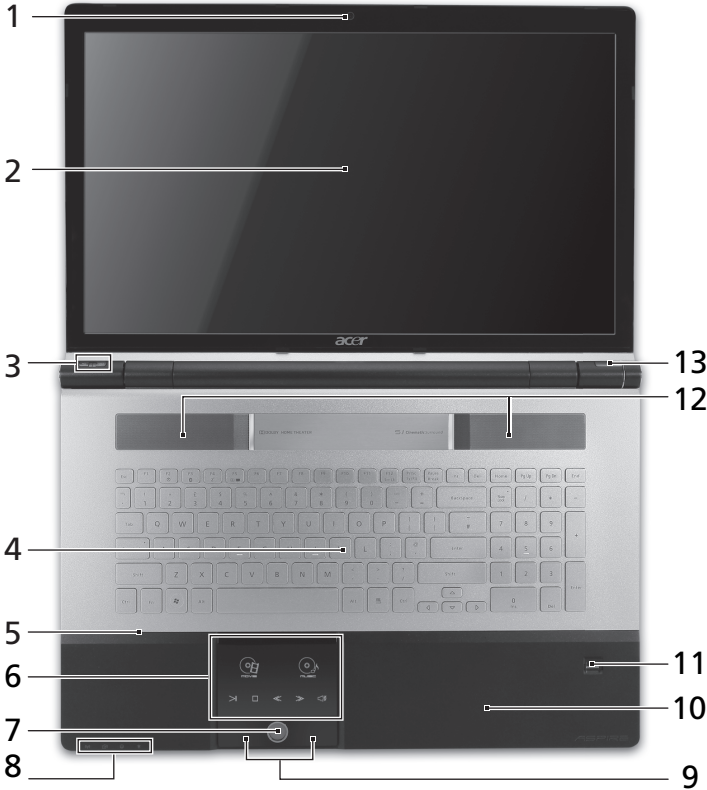

# Ihre Acer-Notebook-Tour

Nachdem Sie Ihren Computer wie in Poster **Für den Anfang...** gezeigt aufgestellt haben, sehen Sie nun eine Übersicht über Ihr neues Acer-Notebook.





## Ansicht von oben



#	Symbol	Element	Beschreibung
1		Acer Crystal Eye Webcam	Web-Kamera für Videokommunikation (Nur für bestimmte Modelle).
2		Anzeigebildschirm	Wird auch als LCD (Liquid-Crystal-Display) bezeichnet. Zeigt die Ausgabe des Computers an (Konfiguration kann sich von Modell zu Modell unterscheiden).

#	Symbol	Element	Beschreibung
3		Arcade-Taste	Startet InstantOn Arcade.
P		P-Taste/ Acer PowerSmart- Taste	Programmierbare Taste (Konfiguration kann sich von Modell zu Modell unterscheiden)./ Aktiviert den Energiesparmodus des Computers (Konfiguration kann sich von Modell zu Modell unterscheiden).
4		Tastatur	Dient der Eingabe von Daten in den Computer.
5		Mikrofon	Internes Mikrofon für die Tonaufnahme.
6		Touchpad/ Medienkonsole	Berührungssensibles Zeigegerät, das die gleichen Funktionen besitzt wie eine Computer-Maus*./ Berührungssensible Steuerelemente für Acer Arcade, Lautstärke (lauter/leiser) und Medien (Wiedergabe/Pause, Stopp, Weiter, Zurück); mit Taste für Ton aus.
		Film	Starten Sie die Filmwiedergabe-Software.
		Musik	Starten Sie die Musikwiedergabe-Software.
		Wiedergabe/ Pause	Geben Sie hiermit die ausgewählte Mediendatei wieder und halten Sie die Wiedergabe an.
		Stopp	Beenden Sie hiermit die Wiedergabe der ausgewählten Mediendatei.
		Zurück	Hiermit gelangen Sie zur vorherigen Mediendatei zurück.
		Weiter	Hiermit springen Sie zur nächsten Mediendatei.
		Ton aus	Schalten Sie den Ton ein oder aus.

\* Das Touchpad wird inaktiv, wenn die Medienkonsole aktiviert wird.

#	Symbol	Element	Beschreibung
7		Medienkonsolen-Steuerung	Hiermit wird die Medienkonsole ein- und ausgeschaltet.
8		Kommunikationstaste	Aktiviert/Deaktiviert die Kommunikationsgeräte des Computers. (Kommunikationsgeräte können sich je nach Konfiguration unterscheiden.)
		Sicherungsschlüssel	Startet Acer Backup Management für eine Datensicherung in drei Schritten.
		HDD-Anzeige <sup>1</sup>	Leuchtet auf, wenn die Festplatte aktiv ist.
		Stromanzeige <sup>1</sup>	Zeigt den Ein/Aus-Status des Computers an.
9		Anklicktasten (links und rechts)	Die linken und rechten Tasten funktionieren wie die linken und rechten Tasten einer Maus.
10		Handablage	Bequemer Ablagebereich für Ihre Hände während der Bedienung des Computers.
11		Acer Bio-Protection-Fingerabdruckleser	Unterstützt die Acer FingerNav 4-Wege-Steuerungsfunktion (Nur für bestimmte Modelle).
12		Lautsprecher	Geben Sie Ton in Stereo aus.
13		Ein/Aus-Taste	Schaltet den Computer ein und aus.









1. Die Statusanzeigen auf der Vorderseite sind selbst dann zu sehen, wenn die Computerklappe geschlossen ist.



## Tastenkombinationen

Der Computer besitzt Direkttasten oder Tastenkombinationen für den Zugriff auf Computersteuerungen wie z. B. Bildschirmhelligkeit und Ausgangslautstärke.

Zum Aktivieren von Hotkeys müssen Sie zuerst die <Fn>-Taste drücken und halten und dann die andere Taste der Hotkey-Kombination drücken.

Tastenkombination	Symbol	Funktion	Beschreibung
<Fn> + <F3>		Kommunikationstaste	Aktiviert/Deaktiviert die Kommunikationsgeräte des Computers. (Kommunikationsgeräte können sich je nach Konfiguration unterscheiden.)
<Fn> + <F4>		Energiesparmodus	Schaltet den Computer in den Energiesparmodus.
<Fn> + <F5>		Display-Schalter	Wechselt die Anzeigerausgabe zwischen Anzeigebildschirm, externem Monitor (falls angeschlossen) und gleichzeitig beiden Anzeigen.
<Fn> + <F6>		Bildschirm leer	Schaltet die Hintergrundbeleuchtung des Bildschirms aus, um Energie zu sparen. Drücken Sie zum Einschalten eine beliebige Taste.
<Fn> + <F7>		Touchpad-Schalter	Schaltet das interne Touchpad ein oder aus.
<Fn> + <F8>		Lautsprecher-Schalter	Schaltet die Lautsprecher ein und aus.
<Fn> + <⇨>		Heller	Erhöht die Bildschirmhelligkeit.
<Fn> + <⇩>		Dunkler	Verringert die Bildschirmhelligkeit.
<Fn> + <+Pos1>		Wiedergabe/Pause	Geben Sie hiermit die ausgewählte Mediendatei wieder und halten Sie die Wiedergabe an.
<Fn> + <Seite nach oben>		Stopp	Beenden Sie hiermit die Wiedergabe der ausgewählten Mediendatei.
<Fn> + <Seite nach unten>		Zurück	Hiermit gelangen Sie zur vorherigen Mediendatei zurück.
<Fn> + <+Ende>		Weiter	Hiermit springen Sie zur nächsten Mediendatei.

## Geschlossene Vorderseite



#	Symbol	Element	Beschreibung
1		Daumenrad	Erhöhen oder verringern Sie die Lautstärke.
2		Mehrere-in-1-Kartenleser	Eignet sich für Secure Digital (SD), MultiMediaCard (MMC), Memory Stick (MS), Memory Stick PRO (MS PRO) und xD-Picture Card (xD). <b>Hinweis:</b> Drücken Sie hier, um die Karte zu entfernen/einzusetzen. Es kann nicht mehr als eine Karte gleichzeitig verwendet werden.
3		CIR-Empfänger	Empfängt Signale von einer Fernbedienung.



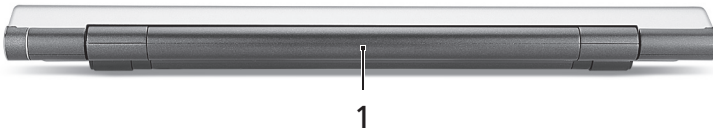

## Ansicht von hinten



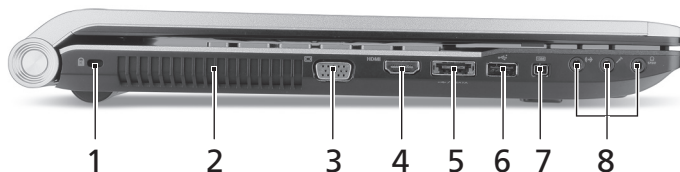

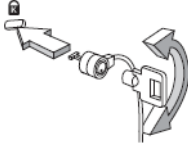
#	Symbol	Element	Beschreibung
1		Akkufach	Enthält den Akku des Computers.

## Linke Seite





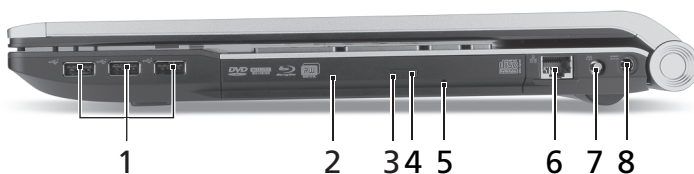

#	Symbol	Element	Beschreibung
1		Steckplatz für Kensington-Schloss 	Hier können Sie ein Kensington-kompatibles Sicherheitsschloss für den Computer anbringen. <b>Hinweis:</b> Binden Sie ein Diebstahlsicherungskabel an ein unbewegliches Objekt wie einen Tisch oder einen Griff einer abgeschlossenen Schublade. Stecken Sie das Schloss in den Anschluss für die Diebstahlsicherung, und schließen Sie dieses ab. Es gibt auch Modelle ohne Schlüssel.
2		Belüftungsschlitze	Schützt den Computer vor Überhitzung, selbst bei längerem Einsatz.
3		Anschluss für externe Anzeige (VGA)	Dient dem Anschluss eines Anzeigegerätes (z. B. einem externen Monitor oder LCD-Projektor).
4	HDMI	HDMI-Anschluss	Unterstützt digitale High-Definition-Video-Verbindungen.
5	 /e SATA	USB 2.0/eSATA - Anschluss	Schließen Sie hier USB 2.0- oder eSATA-Geräte an (Nur für bestimmte Modelle). <b>Hinweis:</b> Wenn Sie ein eSATA-Gerät anschließen, stehen Ihnen drei USB-Schnittstellen zur Verfügung.
6		USB 2.0-Anschluss	Hier schließen Sie USB 2.0-Geräte (z. B. USB-Maus oder USB-Kamera).
7		4-poliger IEEE 1394-Anschluss	Dient dem Anschluss von IEEE 1394-Geräten.

#	Symbol	Element	Beschreibung
8		Leitungseingangs-Buchse	Zum Anschluss von Audioeingabe-Geräten (z. B. Audio-CD-Player, Stereo-Walkman, mp3-Player).
		Mikrofon-Eingangs-Buchse	Eignet sich für Eingaben aus externen Mikrofonen.
		Buchse für Kopfhörer/Lautsprecher/Ausgang mit S/PDIF-Unterstützung	Zum Anschluss von Audioausgabe-Geräten (z. B. Lautsprecher, Kopfhörer).

## Rechte Seite









#	Symbol	Element	Beschreibung
1		USB 2.0-Anschlüsse	Hier schließen Sie USB 2.0-Geräte (z. B. USB-Maus oder USB-Kamera).
2		Optisches Laufwerk	Internes optisches Laufwerk; eignet sich für CDs oder DVDs.
3		Optische Disk Anzeige	Leuchtet auf, wenn optisches Laufwerk aktiv ist.
4		Auswurfaste für optisches Laufwerk	Fährt das optische Laufwerk heraus.
5		Mechanisches Auswurfloch	Schiebt den Träger des optischen Laufwerks aus, wenn der Computer ausgeschaltet ist. <b>Hinweis:</b> Stecken Sie eine Büroklammer in das Auswurfloch, um den Träger des optischen Laufwerkes herauszufahren, wenn der Computer nicht eingeschaltet ist.
6		Ethernet (RJ-45)-Anschluss	Hier schließen Sie ein auf Ethernet 10/100/1000-basiertes Netzwerk an.

#	Symbol	Element	Beschreibung
7		RF-Eingangsanschluss	Akzeptiert Eingangssignale von digitalen TV-Tuner-Geräten (Nur für bestimmte Modelle).
8		DC-Eingangsbuchse	Hier schließen Sie das Netzteil an.

## Unterseite



#	Symbol	Element	Beschreibung
1		Akkufach	Enthält den Akku des Computers.
2		Sub-Woofer	Gibt Ton mit niedriger Frequenz aus.
3		Verriegelung des Akkus	Entsperrt den Akku für die Herausnahme.
4		Speicherfach	Enthält den Hauptspeicher des Computers.
5		Hauptfach für Festplatte	Enthält die Computer-Festplatte (durch Schrauben gesichert).
6		Lautsprecher	Geben Sie Ton in Stereo aus.
7		Nebenfach für Festplatte	Enthält die Computer-Festplatte (durch Schrauben gesichert) (Nur für bestimmte Modelle).
8		Akkuerschluss	Sichert den Akku an seiner Position.

## Umgebung

---

- Temperatur:
    - Betrieb: 5°C bis 35°C
    - Nichtbetrieb: -20°C bis 65°C
  - Luftfeuchtigkeit (nicht kondensierend):
    - Betrieb: 20% bis 80%
    - Nichtbetrieb: 20% bis 80%
-

# Notebook Acer

Guida rapida

© 2010 Tutti i diritti riservati.

Guida rapida per Notebook Acer

Prima edizione: 03/2010

Numero di modello: \_\_\_\_\_

Numero di serie: \_\_\_\_\_

Data di acquisto: \_\_\_\_\_

Luogo d'acquisto: \_\_\_\_\_



# Avvertenze preliminari

Grazie per aver scelto il notebook Acer, la scelta ideale per poter lavorare in piena libertà anche in movimento.

## Le guide disponibili

Sono state realizzate delle guide per assistere l'utente nell'uso del notebook Acer:

Innanzitutto, il documento **Per i principianti...** per semplificare la configurazione del computer.

La **Manale utente generale a Aspire Series** contiene informazioni utili per tutti i modelli della serie Aspire. Copre gli argomenti base come ad esempio l'uso della tastiera, audio, ecc. A causa della sua natura, la **Manale utente generale** così come il **AcerSystem User Guide** menzionata in precedenza a volte fa riferimento a funzioni o caratteristiche presenti solamente in alcuni modelli della serie, ma non necessariamente del modello acquistato. Per questo motivo alcuni elementi nel testo sono indicati con "solo per alcuni modelli".

**Guida rapida** vi presenta le caratteristiche e le funzioni principali del vostro nuovo computer. Per altre nozioni su come il vostro computer può aiutarvi a diventare ancora più produttivi, consultate la **AcerSystem User Guide**. Questa guida contiene informazioni dettagliate su argomenti come utilità del sistema, ripristino dei dati, opzioni di espansione e ricerca guasti. In aggiunta contiene le informazioni sulla garanzia e i regolamenti generali e le avvertenze per la sicurezza del vostro notebook. È disponibile nel formato PDF (Portable Document Format) e viene fornita già caricata nel notebook. Per accedervi seguite questi passaggi:

- 1 Fare clic su  **Start > Programmi > AcerSystem**.
- 2 Fare clic su **AcerSystem User Guide**.



.....

**Nota:** Per visualizzare il file, è necessario che sul computer sia installato Adobe Reader. Se Adobe Acrobat Reader non è installato sul computer, fare clic su **AcerSystem User Guide** per eseguire il programma di installazione di Adobe Reader. Per completare l'installazione, attenersi alle istruzioni visualizzate sullo schermo. Per istruzioni sull'uso di Adobe Reader, consultare il menu **Guida in linea e supporto tecnico**.

# Presentazione del notebook Acer







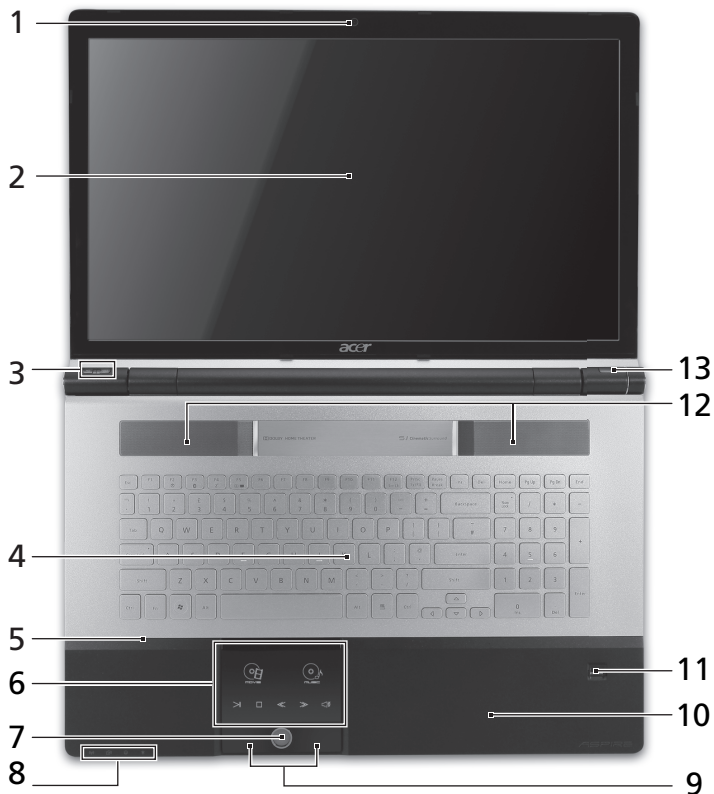

















Dopo aver configurato il computer come illustrato nel manifesto





**Per i principianti...**, far riferimento alla presente documentazione per la presentazione del nuovo notebook Acer.

## Vista dall'alto



#	Icona	Elemento	Descrizione
1		Webcam Acer Crystal Eye	Web camera per la comunicazione video (solo per alcuni modelli).

#	Icona	Elemento	Descrizione																					
2		Display	Grande display a cristalli liquidi (Liquid-Crystal Display; LCD), per una visualizzazione confortevole (La configurazione può variare in relazione al modello).																					
3		Tasto Arcade	Avvia InstantOn Arcade.																					
	P	Tasto P/Tasto Acer PowerSmart	Tasto programmabile (la configurazione può variare in relazione al modello)./ Per attivare la modalità di risparmio energetico (la configurazione può variare in relazione al modello).																					
4		Tastiera	Per l'immissione di dati sul computer.																					
5		Microfono	Microfono interno per la registrazione di audio.																					
6	  	Touchpad/ Console multimediale	<p>Dispositivo di puntamento sensibile al tocco con funzioni simili a quelle di un comune mouse*./ Controlli sensibili al tocco per Acer Arcade, volume (su/giù) e media (play/pausa, stop, precedente, successivo); con tasto disattiva audio.</p> <table border="1"> <tbody> <tr> <td></td> <td>Film</td> <td>Avvia il software per la riproduzione del film.</td> </tr> <tr> <td></td> <td>Musica</td> <td>Avvia il software per la riproduzione di musica.</td> </tr> <tr> <td></td> <td>Play/Pausa</td> <td>Riproduce o sospende la riproduzione del file multimediale selezionato.</td> </tr> <tr> <td></td> <td>Interrompi</td> <td>Interrompe la riproduzione del file multimediale selezionato.</td> </tr> <tr> <td></td> <td>Precedente</td> <td>Per passare al file multimediale precedente.</td> </tr> <tr> <td></td> <td>Avanti</td> <td>Per passare al file multimediale successivo.</td> </tr> <tr> <td></td> <td>Disattiva l'audio</td> <td>Attva o disattiva il volume.</td> </tr> </tbody> </table> <p>* Il touchpad diventa inattivo quando è attiva la Console multimediale.</p>		Film	Avvia il software per la riproduzione del film.		Musica	Avvia il software per la riproduzione di musica.		Play/Pausa	Riproduce o sospende la riproduzione del file multimediale selezionato.		Interrompi	Interrompe la riproduzione del file multimediale selezionato.		Precedente	Per passare al file multimediale precedente.		Avanti	Per passare al file multimediale successivo.		Disattiva l'audio	Attva o disattiva il volume.
	Film	Avvia il software per la riproduzione del film.																						
	Musica	Avvia il software per la riproduzione di musica.																						
	Play/Pausa	Riproduce o sospende la riproduzione del file multimediale selezionato.																						
	Interrompi	Interrompe la riproduzione del file multimediale selezionato.																						
	Precedente	Per passare al file multimediale precedente.																						
	Avanti	Per passare al file multimediale successivo.																						
	Disattiva l'audio	Attva o disattiva il volume.																						













#	Icona	Elemento	Descrizione
7		Controller Console multimediale	Attiva o disattiva la console multimediale.
8		Tasto comunicazioni	Attiva/disattiva i dispositivi di comunicazione del computer. (i dispositivi di comunicazione possono variare in relazione alla configurazione.)
		Tasto Backup	Avvia Acer Backup Management per eseguire il backup dei dati in tre semplici passi.
		Indicatore disco rigido <sup>1</sup>	Si accende quando l'hard disk è attivo.
		Indicatore di alimentazione <sup>1</sup>	Indicano lo stato di accensione/alimentazione del computer.
9		Tasti clic (sinistra e destra)	I tasti destra e sinistra hanno le stesse funzioni dei tasti destra e sinistra del mouse.
10		Poggiapolsi	Comoda area su cui poggiare i polsi durante l'utilizzo del computer.
11		Letto di impronte digitali Acer Bio-Protection	Supporta la funzione di controllo multidirezionale Acer FingerNav (solo per alcuni modelli).
12		Altoparlanti	Emette l'uscita audio stereo.
13		Tasto di accensione	Accende/spegne il computer.

1. Gli indicatori del pannello frontale sono visibili anche quando il coperchio del computer è chiuso.

## Tasti di scelta rapida

Il computer utilizza i tasti di scelta o le combinazioni di tasti per l'accesso a molti controlli del computer come luminosità dello schermo e uscita volume.

Per attivare i tasti di scelta rapida, tenere premuto <Fn> e premere l'altro tasto della combinazione.

Tasti di scelta rapida	Icona	Funzione	Descrizione
<Fn> + <F3>		Tasto comunicazioni	Attiva/disattiva i dispositivi di comunicazione del computer. (i dispositivi di comunicazione possono variare in relazione alla configurazione.)
<Fn> + <F4>		Sospensione	Attiva la modalità sospensione del computer.
<Fn> + <F5>		Passaggio da uno schermo all'altro	Consente la commutazione in uscita display tra video del display o monitor esterno (se collegato) e entrambi.
<Fn> + <F6>		Avvio di screen saver	Disattiva la retroilluminazione dello schermo per risparmiare energia. Premere un tasto qualsiasi per tornare allo stato precedente.
<Fn> + <F7>		Attivazione e disattivazione del touchpad	Attiva e disattiva il touchpad interno.
<Fn> + <F8>		Attivazione e disattivazione degli altoparlanti	Attiva e disattiva gli altoparlanti.
<Fn> + <⇨>		Aumento della luminosità	Consente di aumentare la luminosità dello schermo.
<Fn> + <⇩>		Riduzione della luminosità	Riduce la luminosità dello schermo.
<Fn> + <Home>		Play/Pausa	Riproduce o sospende la riproduzione del file multimediale selezionato.
<Fn> + <Pag su>		Interrompi	Interrompe la riproduzione del file multimediale selezionato.
<Fn> + <Pag giù>		Precedente	Per passare al file multimediale precedente.
<Fn> + <Fine>		Avanti	Per passare al file multimediale successivo.

## Vista frontale in dettaglio



#	Icona	Elemento	Descrizione
1		Controllo	Aumenta o riduce il volume.
2		Letto di schede multiplo	Supporta Secure Digital (SD), MultiMediaCard (MMC), Memory Stick (MS), Memory Stick Pro (MS PRO), e xD-Picture Card (xD). <b>Nota:</b> Premere per rimuovere/installare la scheda. È possibile utilizzare una sola scheda di memoria alla volta.
3		Ricevitore CIR	Riceve i segnali da un telecomando.



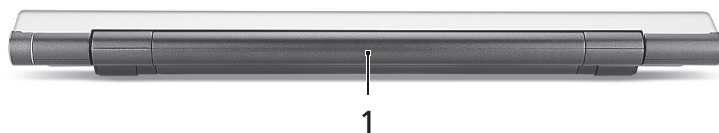

## Vista posteriore

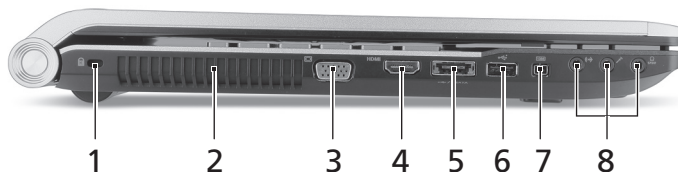

#	Icona	Elemento	Descrizione
1		Alloggiamento della batteria	Contiene il pacco batteria del computer.

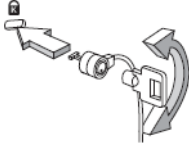
## Vista da sinistra



#	Icona	Elemento	Descrizione
1		Slot blocco Kensington 	Per il collegamento al blocco di sicurezza dei computer Kensington-compatibili. <b>Nota:</b> Avvolgere un cavo di sicurezza per computer intorno ad un oggetto fisso, ad esempio un tavolo o la maniglia di un cassetto chiuso a chiave. Inserire la serratura nel foro e girare la chiave per fissare il blocco. Sono disponibili anche modelli senza chiave.
2		Aperture per la ventilazione	Permettono il raffreddamento del computer, anche dopo un uso prolungato.
3		Porta display esterno (VGA)	Effettua il collegamento a un dispositivo di visualizzazione (ad es., monitor esterno, proiettore LCD).
4	HDMI	Porta HDMI	Supporta collegamento per video digitali ad alta definizione.
5		Porta USB 2.0/ eSATA	Per collegamento a dispositivi USB 2.0 o eSATA (solo per alcuni modelli). <b>Nota:</b> Se viene collegato un dispositivo eSATA, saranno contemporaneamente disponibili tre porte USB.
6		Porta USB 2.0	Effettua il collegamento ai dispositivi USB 2.0 (ad es., mouse USB, fotocamera USB).
7		Porta a 4-pin IEEE 1394	Effettua il collegamento ai dispositivi IEEE 1394.

#	Icona	Elemento	Descrizione
8		Jack line-in	Accetta dispositivi audio line-in (ad es., lettore CD audio, walkman stereo, lettore MP3).
		Jack ingresso microfono	Accetta ingressi provenienti da microfoni esterni.
		Jack auricolari/ altoparlante/ line-out con supporto S/PDIF	Effettua il collegamento ai dispositivi audio line-out (ad es., altoparlanti, auricolari).

## Vista da destra

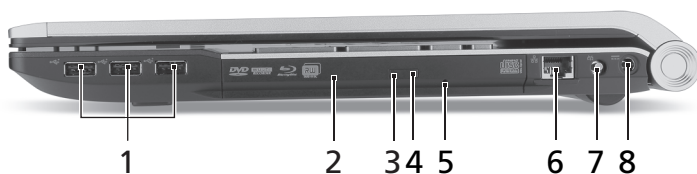





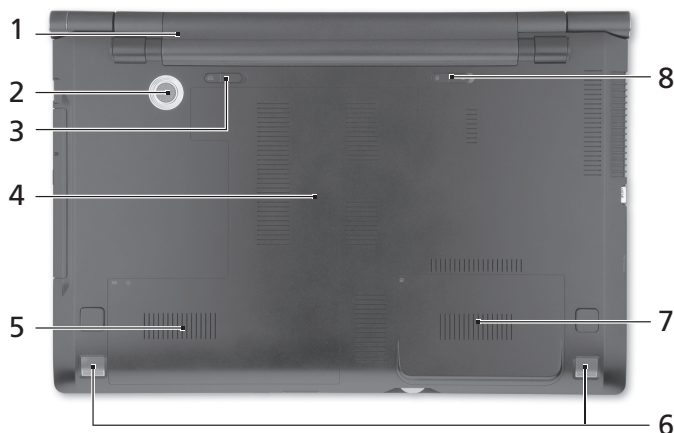

#	Icona	Elemento	Descrizione
1		Porte USB 2.0	Effettua il collegamento ai dispositivi USB 2.0 (ad es., mouse USB, fotocamera USB).
2		Lettore ottico	Unità ottica interna, accetta CD o DVD.
3		Indicatore accesso disco ottico	Si accende quando il disco ottico è attivo.
4		Tasto di espulsione del disco ottico	Espelle il disco ottico dall'unità.
5		Foro di espulsione di emergenza	Espelle il vassoio del disco ottico se il computer è spento. <b>Nota:</b> Inserire la punta di un fermaglio nel foro di apertura di emergenza per espellere il vassoio dell'unità ottica quando il computer è spento.
6		Porta Ethernet (RJ-45)	Effettua il collegamento a una rete con Ethernet 10/100/1000.
7		Porta RF-in	Accetta segnali in ingresso dai dispositivi di sintonizzazione di TV digitale (solo per alcuni modelli).
8		Jack CC-in	Per il collegamento all'adattatore CA.



## Vista base



#	Icona	Elemento	Descrizione
1		Alloggiamento della batteria	Contiene il pacco batteria del computer.
2		Sub woofer	Altoparlante per le basse frequenze.
3		Gancio di rilascio della batteria	Per togliere la batteria.
4		Vano per la memoria	Contiene la memoria principale del computer.
5		Alloggiamento principale disco rigido	Alloggia il disco rigido del computer (fissato con viti).
6		Altoparlanti	Emette l'uscita audio stereo.
7		Alloggiamento secondario disco rigido	Alloggia il disco rigido del computer (fissato con viti) (solo per alcuni modelli).
8		Blocco batteria	Blocca la batteria al suo posto.

## Condizioni operative

---

- Temperatura:
    - Di esercizio: Da 5°C a 35°C
    - Non di esercizio: Da -20°C a 65°C
  - Umidità (senza condensa):
    - Di esercizio: Da 20% a 80%
    - Non di esercizio: Da 20% a 80%
-

# Portátil de Acer

Guía rápida

© 2010 Reservados todos los derechos.

Guía rápida del portátil de Acer  
Versión original: 03/2010

Número de modelo: \_\_\_\_\_

Número de serie: \_\_\_\_\_

Fecha de compra: \_\_\_\_\_

Lugar de compra: \_\_\_\_\_

# Primero lo más importante

Le agradecemos que haya elegido el ordenador portátil Acer para satisfacer sus necesidades de informática móvil.

## Las guías

Para ayudarle a utilizar el ordenador portátil Acer, hemos elaborado un conjunto de guías:

En primer lugar, el póster **Para principiantes...** contiene información de ayuda para configurar el ordenador.

La **Guía genérica del usuario de la serie Aspire** contiene información útil aplicable a todos los modelos de productos de la serie Aspire. Contempla aspectos básicos como el uso del teclado, el audio, etc. No obstante, no se olvide que debido a su carácter, la **Guía genérica del usuario** además de la **AcerSystem User Guide** mencionada a continuación se referirá ocasionalmente a las funciones o características incluidas sólo en ciertos modelos de la serie, pero no necesariamente al modelo que haya adquirido usted. Dichos ejemplos se marcará en el texto con indicaciones como "sólo en ciertos modelos".

La **Guía rápida** presenta las características y funciones básicas de su nuevo ordenador. Para obtener más información sobre cómo el ordenador puede ayudarle a ser más productivo, consulte la **AcerSystem User Guide**. Esa guía contiene información detallada sobre temas como utilidades del sistema, recuperación de datos, opciones de expansión y resolución de problemas. También contiene información sobre la garantía, así como reglamentos generales y avisos de seguridad para el ordenador portátil. Está disponible en formato PDF (Portable Document Format) y viene instalada en el ordenador portátil. Siga el procedimiento siguiente para acceder a la misma:

- 1 Haga clic en  **Inicio > Todos los programas > AcerSystem.**
- 2 Haga clic en **AcerSystem User Guide.**



-----

**Nota:** Para poder ver el archivo, debe tener instalado Adobe Reader. Si no lo tiene instalado, haga clic en **AcerSystem User Guide** para que se ejecute el programa de instalación de Adobe Reader. Siga las instrucciones en pantalla para completar la instalación. Para obtener información sobre cómo utilizar Adobe Reader, acceda al menú **Ayuda y soporte técnico.**







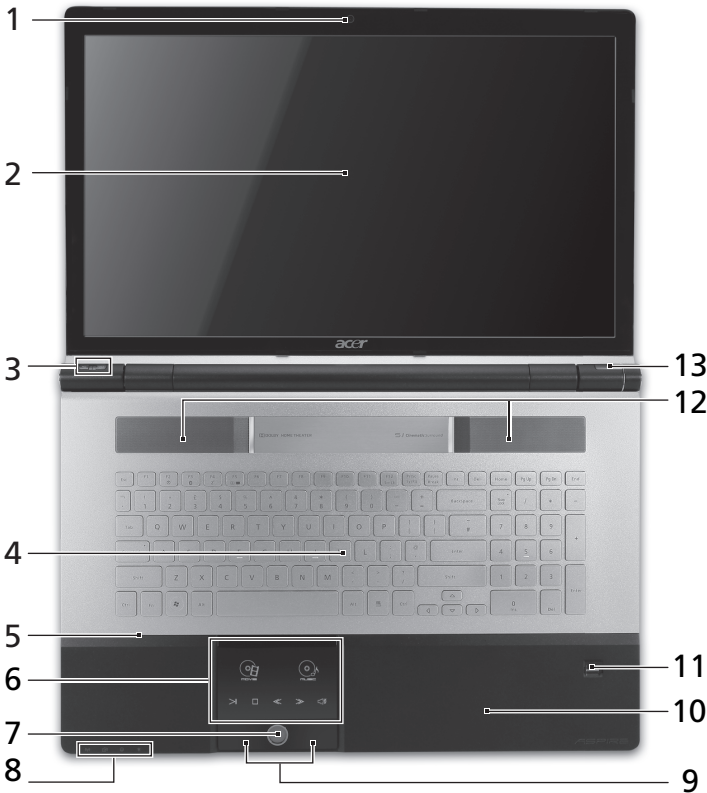

# Un paseo por el ordenador portátil Acer

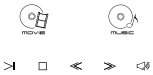
Una vez configurado el ordenador del modo indicado en el póster **Para principiantes...**, iniciaremos un paseo por su nuevo ordenador portátil Acer.





## Vista superior



#	Icono	Elemento	Descripción
1		Webcam Acer Crystal Eye	Cámara Web para comunicación de vídeo (sólo en ciertos modelos).

#	Icono	Elemento	Descripción
2		Visualización en pantalla	También denominada pantalla de cristal líquido (LCD) es el dispositivo de salida visual del ordenador (la configuración puede variar según el modelo).
3		Tecla Arcade	Inicia InstantOn Arcade.
	P	Tecla P/Teclas de Acer PowerSmart	Tecla programable (la configuración puede variar según el modelo)./ Activa el modo de ahorro de energía del ordenador (la configuración puede variar según el modelo).
4		Teclado	Para introducir datos en su ordenador.
5		Micrófono	Micrófono interno para la grabación del sonido.
6		Panel táctil/ Administrador de medios	Dispositivo apuntador táctil que funciona como un ratón de ordenador*./ Controles táctiles para Acer Arcade, volumen (arriba/abajo) y medios (reproducir/pausa, detener, anterior, siguiente); con silencio.
		Película	Inicia software de reproducción de películas.
		Música	Inicia software de reproducción de música.
		Reproducir/ Pausa	Reproduce o hace una pausa en un archivo multimedia seleccionado.
		Detener	Detiene la reproducción del archivo multimedia seleccionado.
		Anterior	Regresa al archivo multimedia anterior.
		Siguiente	Salta al siguiente archivo multimedia.
		Silenciar	Activa o desactiva el volumen.

\* El panel táctil se vuelve inactivo cuando el Administrador de medios está activo.

#	Icono	Elemento	Descripción
7		Controlador del Administrador de medios	Activa o desactiva el Administrador de medios.
8		Tecla de comunicación	Activa/desactiva los dispositivos de comunicación del ordenador. (Los dispositivos de comunicación pueden variar según la configuración.)
		Tecla de copia de seguridad	Inicia Acer Backup Management para realizar una copia de seguridad de los datos en tres pasos.
		Indicador de disco duro <sup>1</sup>	Indica si la unidad de disco duro está activa.
		Indicador de encendido <sup>1</sup>	Proporciona información sobre el estado de energía del ordenador.
9		Botones de clic (izquierdo y derecho)	Los botones izquierdo y derecho funcionan como los botones izquierdo y derecho del ratón.
10		Soporte para las palmas	Área de soporte que permite reposar cómodamente las palmas de las manos cuando se utiliza el ordenador.
11		Lector de huellas digitales Acer Bio-Protection	Compatible con la función de control Acer FingerNav de 4 direcciones (sólo en determinados modelos).
12		Altavoces	Proporcionan una salida de audio.
13		Botón de encendido	Enciende o apaga el ordenador.

1. Los indicadores del panel frontal son visibles aunque se cierre la tapa del ordenador.



## Teclas de acceso directo

El ordenador utiliza teclas de acceso directo o combinaciones de teclas para acceder a la mayoría de controles del ordenador como el brillo de la pantalla o la salida de volumen.

Para activar las teclas de acceso directo, mantenga pulsada la tecla <Fn> y pulse la siguiente tecla de la combinación.

Tecla de acceso directo	Icono	Función	Descripción
<Fn> + <F3>		Tecla de comunicación	Activa/desactiva los dispositivos de comunicación del ordenador. (Los dispositivos de comunicación pueden variar según la configuración.)
<Fn> + <F4>		Suspensión	Pone el ordenador en modo de suspensión.
<Fn> + <F5>		Selector de pantalla	Cambia la salida entre la pantalla y el monitor externo (si está conectado) o ambos.
<Fn> + <F6>		Pantalla en blanco	Apaga la luz de fondo de la pantalla para ahorrar energía. Pulse cualquier tecla para encenderla.
<Fn> + <F7>		Panel táctil	Activa o desactiva el panel táctil interno.
<Fn> + <F8>		Alternar altavoces	Activa o desactiva los altavoces.
<Fn> + <◀▶>		Aumentar brillo	Aumenta el brillo de la pantalla.
<Fn> + <◀◀>		Disminuir brillo	Disminuye el brillo de la pantalla.
<Fn> + <Inicio>		Reproducir/Pausa	Reproduce o hace una pausa en un archivo multimedia seleccionado.
<Fn> + <Re Pág>		Detener	Detiene la reproducción del archivo multimedia seleccionado.
<Fn> + <Av Pág>		Anterior	Regresa al archivo multimedia anterior.
<Fn> + <Fin>		Siguiente	Salta al siguiente archivo multimedia.

## Vista frontal cerrada



#	Icono	Elemento	Descripción
1		Rueda del pulgar	Sube o baja el volumen.
2		Lector de tarjetas multifunción	Admite la tarjeta Secure Digital (SD), MultiMedia (MMC), Memory Stick (MS), Memory Stick PRO (MS PRO), xD-Picture (xD). <b>Nota:</b> Presionar para extraer/instalar la tarjeta. Sólo puede funcionar una tarjeta en un momento dado.
3		Receptor de infrarrojos (CIR)	Recibe señales de un control remoto.

## Vista trasera

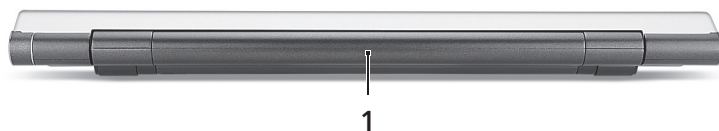

#	Icono	Elemento	Descripción
1		Compartimento de la batería	Aloja la batería del ordenador.

## Vista izquierda

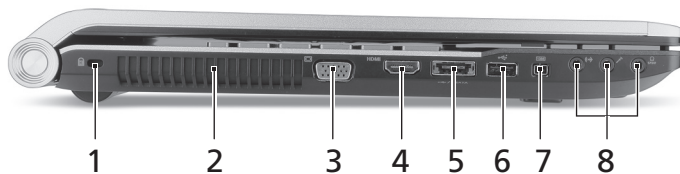

#	Icono	Elemento	Descripción
1		Ranura de bloqueo Kensington	Permite conectar a un candado de seguridad para ordenador compatible con Kensington. <b>Nota:</b> Coloque un cable de seguridad para ordenadores alrededor de un objeto fijo como una mesa o el tirador de un cajón cerrado con llave. Introduzca el candado en la ranura y gire la llave. También hay modelos sin llave.
2		Ranuras de ventilación	Permite que el ordenador esté frío, incluso tras un uso prolongado.
3		Puerto de visualización externo (VGA)	Conexión para pantallas (p.ej., monitor externo o proyector LCD).
4	HDMI	Puerto HDMI	Compatible con conexiones de vídeo digital de alta definición.
5		Puerto USB 2.0/eSATA	Conexión para dispositivos USB 2.0 o eSATA (sólo en ciertos modelos). <b>Nota:</b> Si conecta un dispositivo eSATA, contará con tres puertos USB disponibles a la vez.
6		Puerto USB 2.0	Conexión para dispositivos USB 2.0 (p.ej., ratón USB, cámara USB).
7		Puerto IEEE 1394 de 4 pines	Conexión para dispositivos IEEE 1394.
8		Conector de entrada	Conexión para dispositivos de entrada de audio (p.ej., reproductor de CD de audio, walkman estéreo, reproductor de MP3).
		Conector de entrada para micrófono	Permite la entrada de audio de micrófonos externos.
		Conector de salida/auriculares/altavoz compatible con SPDIF	Conexión para dispositivos de salida de audio (p.ej., altavoces, auriculares).



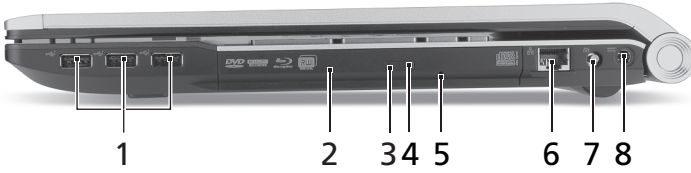



## Vista derecha

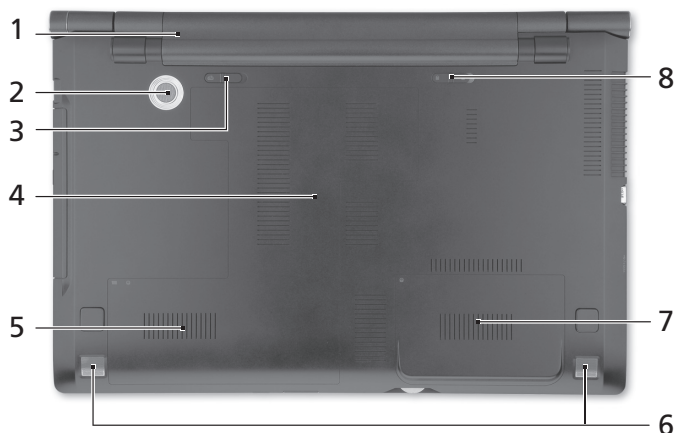

#	Icono	Elemento	Descripción
1		Puertos USB 2.0	Conexión para dispositivos USB 2.0 (p.ej., ratón USB, cámara USB).
2		Unidad óptica	Dispositivo óptico interno; acepta CD y DVD.
3		Indicador de acceso del disco óptico	Se enciende cuando la unidad óptica está activa.
4		Botón de expulsión de la unidad óptica	Expulsa el disco óptico de la unidad.
5		Orificio de expulsión de emergencia	Expulsa la bandeja de la unidad óptica cuando el ordenador está apagado. <b>Nota:</b> Introduzca un clip sujetapapeles en el orificio de expulsión para expulsar la bandeja de la unidad óptica cuando el ordenador esté apagado.
6		Puerto Ethernet (RJ-45)	Conexión para una red basada en Ethernet 10/100/1000.
7		Puerto de entrada de RF	Aceptar señales de dispositivos sintonizadores de TV digital (sólo en ciertos modelos).
8		Conector de entrada de CA	Permite conectar a un adaptador de CA.

## Vista de la base



#	Icono	Elemento	Descripción
1		Compartimiento de la batería	Aloja la batería del ordenador.
2		Altavoz de subgraves	Emite sonido de baja frecuencia.
3		Pestillo de liberación de la batería	Libera la batería para poder sacarla.
4		Compartimiento de memoria	Contiene la memoria principal de ordenador.
5		Bahía de disco duro: Principal	Contiene el disco duro del ordenador (fijado con tornillos).
6		Altavoces	Proporcionan una salida de audio.
7		Bahía de disco duro: Secundaria	Contiene el disco duro del ordenador (fijado con tornillos) (sólo en ciertos modelos).
8		Bloqueo de la batería	Permite que la batería quede trabada.

## Medio ambiente

---

- Temperatura:
    - Encendido: Entre 5°C y 35°C
    - Apagado: Entre -20°C y 65°C
  - Humedad (sin condensación):
    - Encendido: Entre 20% y 80%
    - Apagado: Entre 20% y 80%
-

# Notebook Acer

Guia rápido

© 2010 Todos os Direitos Reservados.

Guia rápido do Notebook Acer

Edição Original: 03/2010

Número de Modelo: \_\_\_\_\_

Número de Série: \_\_\_\_\_

Data de Compra: \_\_\_\_\_

Local de Aquisição: \_\_\_\_\_



# Comecemos pelo princípio

Gostaríamos de lhe agradecer por ter escolhido um computador portátil Acer para preencher as suas necessidades de computador móvel.

## Os seus manuais

Para o ajudar a usar o seu computador portátil Acer, preparámos uma série de manuais:

Antes de mais, o cartaz **Para principiantes...** ajuda-o a iniciar e a configurar o seu computador.

O **Manual Genérico do utilizador da Série Aspire** contém informações úteis que se aplicam a todos os modelos da série de produtos Aspire. Abrange tópicos básicos como utilização do teclado, áudio, etc. Pedimos a sua compreensão para o facto de, pela sua natureza, o **Manual Genérico do utilizador** e o **AcerSystem User Guide** abaixo mencionados referem-se ocasionalmente a funções ou funcionalidades apenas aplicáveis a determinados modelos da série, mas não necessariamente ao modelo específico que adquiriu. Estas situações aparecem marcadas no texto com referências como "apenas para determinados modelos".

O **Guia rápido** apresenta as características e funções básicas do seu novo computador. Para mais detalhes sobre como o seu computador o pode ajudar a ser mais produtivo, consulte o **AcerSystem User Guide**. Esse manual contém informações pormenorizadas sobre temas como utilitários do sistema, recuperação de dados, opções de expansão e solução de problemas. Além disso, contém a informação da garantia e as regulamentações gerais e notas de segurança para o seu computador portátil. Está disponível no formato PDF (Portable Document Format) e vem já instalado no seu computador. Siga estes passos para o aceder:

- 1 Clique em  **Iniciar > Todos os programas > AcerSystem**.
- 2 Clique em **AcerSystem User Guide**.



-----

**Nota:** É necessário instalar o Adobe Reader para visualizar o ficheiro. Se o Adobe Reader não estiver instalado no seu computador, ao clicar em **AcerSystem User Guide** é executado o programa de instalação do Acrobat Reader. Siga as instruções do ecrã para finalizar a instalação. Para obter instruções sobre como utilizar o Adobe Reader, vá ao menu **Ajuda e Suporte**.







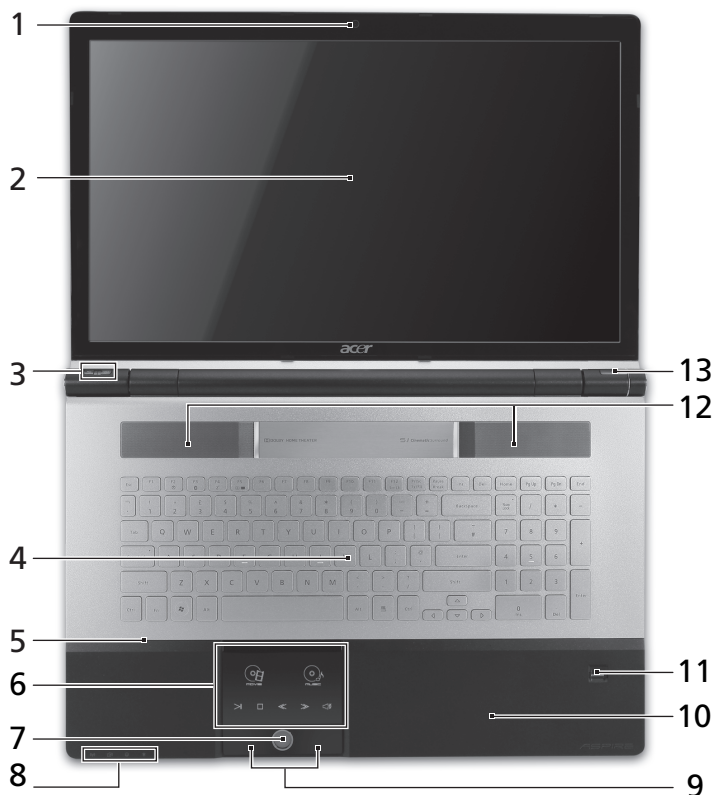

# Visita guiada ao seu computador portátil Acer





Após montar o computador tal como indicado na ilustração do cartaz **Para principiantes...**, deixe-nos mostrar-lhe o seu novo computador portátil Acer.

## Vista de cima



#	Ícone	Item	Descrição
1		Webcam Acer Crystal Eye	Webcam para comunicação por vídeo (apenas para determinados modelos).

#	Ícone	Item	Descrição
2		Ecrã	Também chamado ecrã de cristais líquidos (LCD), permite visualizar a informação do computador (A configuração pode variar consoante o modelo).
3		Tecla Arcade	Abre o InstantOn Arcade.
	P	Tecla P/Tecla Acer PowerSmart	Tecla programável (a configuração pode variar consoante o modelo)./ Coloca o seu computador em modo de poupança de energia (a configuração poderá variar consoante o modelo).
4		Teclado	Para introduzir informações no seu computador.
5		Microfone	Microfone interno para gravação de som.
6		Painel Táctil/ Consola Multimédia	Dispositivo apontador sensível ao toque, que funciona como um rato de computador*./ Controlos sensíveis ao toque para o Acer Arcade, volume (aumentar/diminuir) e multimédia (reproduzir/pausar, parar, anterior, seguinte); com opção de silêncio.
		Filme	Abrir software de reprodução de filmes.
		Música	Abrir software de reprodução de música.
		Reproduzir/ Pausa	Reproduz ou pausa um ficheiro multimédia seleccionado.
		Parar	Para a reprodução do ficheiro multimédia seleccionado.
		Anterior	Retorna ao ficheiro multimédia anterior.
		Seguinte	Avança até ao ficheiro multimédia seguinte.
		Silenciar	Liga ou desliga o volume.
			* O painel táctil fica inactivo quando a Consola Multimédia está activa.
7		Controlador da Consola Multimédia	Liga ou desliga a Consola Multimédia.

#	Ícone	Item	Descrição
8		Tecla de comunicações	Activa/desactiva os dispositivos de comunicação do computador. (Os dispositivos de comunicação podem variar consoante a configuração.)
		Tecla de cópia de segurança	Abre o Acer Backup Management para efectuar cópia de segurança em três passos.
		HDD indicador <sup>1</sup>	Indica quando o disco rígido está activo.
		Indicador de alimentação <sup>1</sup>	Indica o estado da alimentação do computador.
9		Botões de clique (esquerdo e direito)	Os botões esquerdo e direito funcionam como os botões esquerdo e direito de um rato.
10		Descanso de mãos	Área confortável de apoio para as suas mãos enquanto utiliza o computador.
11		Leitor de impressões digitais Acer Bio-Protection	Suporta a função de controlo de 4 vias Acer FIngerNav (apenas para determinados modelos).
12		Altifalantes	Obtenha saída de áudio em estéreo.
13		Botão de alimentação	Liga e desliga o computador.

1. Os indicadores no painel dianteiro são visíveis mesmo com a tampa do monitor fechada.

## Teclas de atalho

O computador utiliza teclas de atalho ou combinações de teclas para aceder à maior parte dos seus comandos, tais como a luminosidade do ecrã e o volume de saída.

Para activar as teclas de atalho, prima e mantenha premida a tecla <Fn> antes de premir a outra tecla na combinação de teclas de atalho.

Tecla de atalho	Ícone	Função	Descrição
<Fn> + <F3>		Tecla de comunicações	Activa/desactiva os dispositivos de comunicação do computador. (Os dispositivos de comunicação podem variar consoante a configuração.)
<Fn> + <F4>		Suspensão	Coloca o computador no modo de Suspensão.
<Fn> + <F5>		Comutação de visualização	Alterna a saída entre o ecrã de visualização, o monitor externo (se está ligado) e ambos.
<Fn> + <F6>		Ecrã em branco	Desliga a luz de fundo do ecrã de visualização para economizar energia. Prima qualquer tecla para retomar a actividade.
<Fn> + <F7>		Comutação de touchpad (teclado táctil)	Liga e desliga o teclado táctil interno.
<Fn> + <F8>		Comutação de altifalante	Liga e desliga os altifalantes.
<Fn> + <▶>		Aumentar luminosidade	Aumenta a luminosidade do ecrã.
<Fn> + <◀<		Reduzir luminosidade	Reduz a luminosidade do ecrã.
<Fn> + <Home>		Reproduzir/Pausa	Reproduz ou pausa um ficheiro multimédia seleccionado.
<Fn> + <Pg Up>		Parar	Para a reprodução do ficheiro multimédia seleccionado.
<Fn> + <Pg Dn>		Anterior	Retorna ao ficheiro multimédia anterior.
<Fn> + <End>		Seguinte	Avança até ao ficheiro multimédia seguinte.

## Vista frontal, fechado



#	Ícone	Item	Descrição
1		Roda de navegação	Aumenta ou diminui o volume.
2		Leitor de cartões vários-em-um	Aceita cartões Secure Digital (SD), MultiMediaCard (MMC), Memory Stick (MS), Memory Stick PRO (MS PRO), xD-Picture Card (xD). <b>Nota:</b> Empurre para remover/instalar o cartão. Apenas pode ser utilizado um cartão de cada vez.
3		Receptor CIR	Recebe sinais de um comando à distância.

## Visão traseira

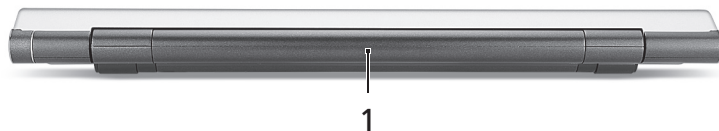

#	Ícone	Item	Descrição
1		Baía da bateria	Contém a bateria do computador.

## Vista esquerda

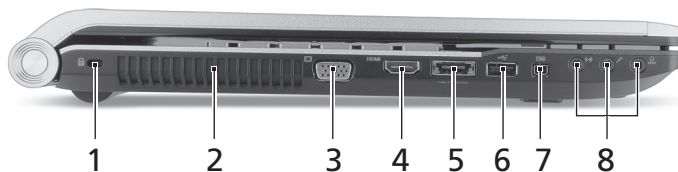

#	Ícone	Item	Descrição
1		Ranhura para fecho Kensington	Liga a um cadeado de segurança Kensington (ou compatível). <b>Nota:</b> Enrole o cabo de bloqueio de segurança do computador em torno de um objecto imóvel, como por exemplo uma mesa ou o puxador de uma gaveta fechada. Introduza o cabo de segurança na ranhura e rode a chave para proteger o bloqueio. Também estão disponíveis modelos sem chave.
2		Ranhas de ventilação	Permite ao computador manter-se fresco, mesmo após uso prolongado.
3		Ligação a ecrã externo (VGA)	Liga a um dispositivo de visualização (por exemplo, monitor externo, projector LCD).
4	HDMI	Porta HDMI	Suporta ligações de vídeo digital de alta definição.
5		Porta USB 2.0/eSATA	Liga a dispositivos USB 2.0 ou eSATA (apenas para determinados modelos). <b>Nota:</b> Se ligar um dispositivo eSATA, ficará com três portas USB disponíveis entretanto.
6		Entrada USB 2.0	Liga a dispositivos USB 2.0 (por ex. rato USB, câmara USB).
7		Porta IEEE 1394 de 4 pinos	Liga a dispositivos IEEE 1394.
8		Tomada de entrada	Aceita dispositivos de entrada de som (por exemplo, leitor de CD de áudio, walkman estéreo, leitor mp3).
		Conector de entrada do microfone	Aceita entradas de microfones externos.
		Tomada de auscultadores/altifalante/saída compatível com S/PDIF	Liga a dispositivos de saída de áudio (por exemplo, altifalantes, auscultadores).

## Vista direita

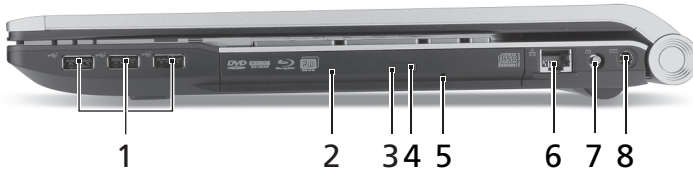





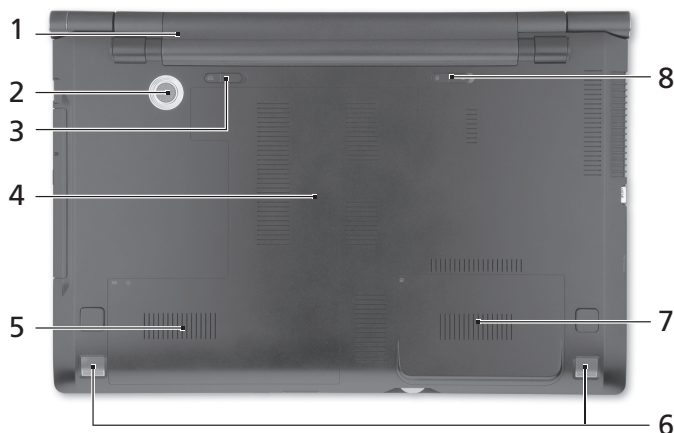

#	Ícone	Item	Descrição
1		Portas USB 2.0	Liga a dispositivos USB 2.0 (por ex. rato USB, câmara USB).
2		Unidade óptica	Unidade óptica interna; aceita CD ou DVD.
3		Indicador de acesso do disco óptico	Acende quando a unidade óptica está activa.
4		Botão de ejeção da unidade óptica	Ejecta o disco óptico da unidade.
5		Furo de ejeção de emergência	Ejecta o tabuleiro da unidade óptica quando o computador está desligado. <b>Nota:</b> Introduza um clipe no orifício de ejeção de emergência, para a unidade óptica ejectar o tabuleiro quando desligado o computador.
6		Entrada Ethernet (RJ-45)	Liga a uma rede Ethernet de base 10/100/1000.
7		Porta de entrada RF	Aceita sinais de entrada de dispositivos de sintonização de TV digital (apenas para determinados modelos).
8		Tomada de entrada CC	Liga a um adaptador CA.



## Visão da base



#	Ícone	Item	Descrição
1		Baía da bateria	Contém a bateria do computador.
2		Atifalante de graves	Emite som de baixa frequência.
3		Patilha de libertação da bateria	Liberta a bateria para remoção.
4		Compartimento da memória	Aloja a memória principal do computador.
5		Compartimento do disco rígido-Primário	Aloja o disco rígido do computador (seguro por parafusos).
6		Altifalantes	Obtenha saída de áudio em estéreo.
7		Compartimento do disco rígido-Secundário	Aloja o disco rígido do computador (seguro por parafusos) (apenas para determinados modelos).
8		Bloqueio da bateria	Bloqueia a bateria, mantendo-a no sítio.

## Ambiente

---

- Temperatura:
    - Funcionamento: 5°C a 35°C
    - Não em funcionamento: -20°C a 65°C
  - Humidade (não condensação):
    - Funcionamento: 20% a 80%
    - Não em funcionamento: 20% a 80%
-

# Acer laptop

Snelgids

© 2010 Alle rechten voorbehouden.

Acer laptop Snelgids

Oorspronkelijke uitgave: 03/2010

Modelnummer: \_\_\_\_\_

Serienummer: \_\_\_\_\_

Aankoopdatum: \_\_\_\_\_

Plaats van aankoop: \_\_\_\_\_

# Voordat u aan de slag gaat

Bedankt dat u hebt gekozen voor een notebook van Acer als oplossing voor uw mobiele computereisen.

## Uw gidsen

Om u te helpen met het werken op het Acer notebook hebben we een aantal gidsen ontworpen:

Allereerst helpt de kaart **Aan de slag...** u bij het instellen van uw computer.

De **Algemene gebruikershandleiding van de Aspire Series** bevat handige informatie die van toepassing zijn op alle modellen uit de Aspire productreeks. De handleiding behandelt basale onderwerpen, zoals de het gebruik van het toetsenbord, geluid, enz. Vandaar dat zowel de **Algemene gebruikershandleiding** als de hieronder genoemde **AcerSystem User Guide** af en toe naar functies of kenmerken verwijzen die slechts voor enkele modellen in de reeks gelden, en dus niet noodzakelijk voor het model dat u heeft aangeschaft. Dit wordt in de tekst aangegeven met opmerkingen in de trand van "alleen voor bepaalde modellen".

Met de **Snelgids** krijgt u een introductie in de basiseigenschappen en functies van uw nieuwe computer. Als u meer wilt weten over hoe uw computer u kan helpen productiever te werken, raadpleeg dan de **AcerSystem User Guide**. Deze Gebruikershandleiding bevat gedetailleerde informatie over onderwerpen zoals systeemfuncties, gegevensherstel, uitbreidingsopties en probleem oplossen. Daarnaast bevat het informatie over garantie en de algemene voorwaarden en veiligheid voor uw notebook. Het is als Portable Document Format (PDF) beschikbaar en is al van te voren op uw notebook gezet. Volg deze stappen voor toegang tot dit document:

- 1 Klik op  **Start > Alle Programma's > AcerSystem**.
- 2 Klik vervolgens op **AcerSystem User Guide**.



-----









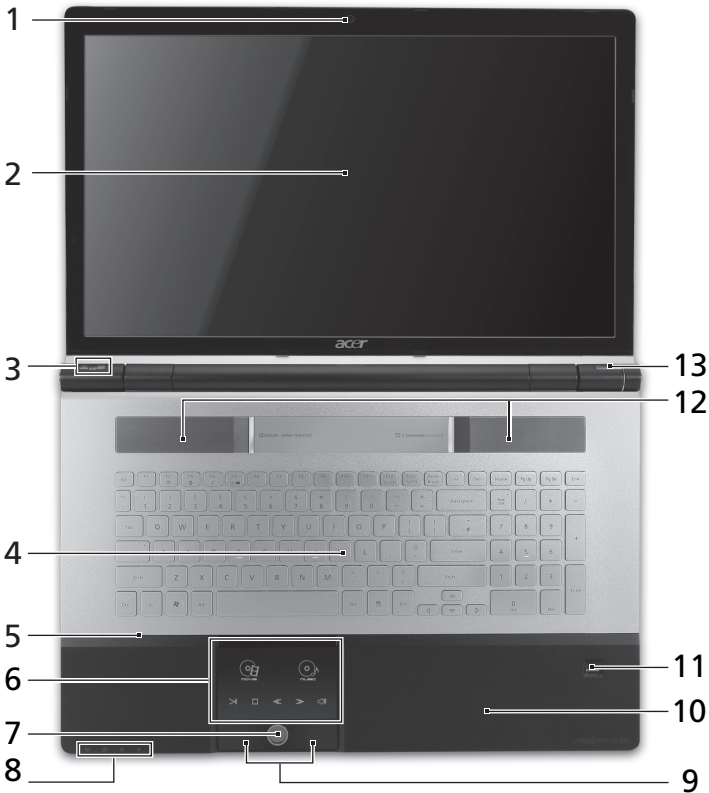

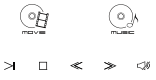











**Opmerking:** Als u het bestand wilt inzien, dient Adobe Reader te zijn geïnstalleerd. Als Adobe Reader nog niet op uw computer is geïnstalleerd, wordt, als u op **AcerSystem User Guide** klikt, eerst het installatieprogramma van Adobe Reader gestart. Volg de instructies op het scherm om het programma te installeren. Gebruiksaanwijzingen bij Adobe Reader vindt u in het menu **Help en Ondersteuning**.





# Rondleiding door uw Acer notebook

Nadat u de computer hebt ingesteld zoals is beschreven op de poster **Aan de slag...**, bent u nu klaar voor een rondleiding door de nieuwe Acer notebook.

## Bovenkant



#	Pictogram	Item	Beschrijving																					
1		Acer Crystal Eye webcam	Webcam voor videocommunicatie (alleen voor bepaalde modellen).																					
2		Beeldscherm	Ook wel Liquid-Crystal Display (LCD) genoemd, geeft de output van de computer weer (Configuratie kan per model verschillen).																					
3		Arcade-toets	Start InstantOn Arcade.																					
	P	P-toets/ Acer PowerSmart-toets	Programmeerbare toets (configuratie kan per model verschillen)./ Plaatst de computer in de energie besparende modus (configuratie kan per model verschillen).																					
4		Toetsenbord	Om gegevens in te voeren in de computer.																					
5		Microfoon	Interne microfoon voor geluidsopname.																					
6		Touchpad/ Media Console	<p>Tastgevoelig aanwijsapparaat dat functioneert als een computermuis*/ Aanraakgevoelige bediening voor Acer Arcade, volume (omhoog/omlaag) en media (afspelen/pauze, stoppen, vorige, volgende); met dempen.</p> <table border="1"> <tbody> <tr> <td></td> <td>Film</td> <td>Start afspeelsoftware voor films.</td> </tr> <tr> <td></td> <td>Muziek</td> <td>Start afspeelsoftware voor muziek.</td> </tr> <tr> <td></td> <td>Afspelen/ Pauze</td> <td>Een geselecteerd mediabestand afspelen of pauzeren.</td> </tr> <tr> <td></td> <td>Stoppen</td> <td>Het afspelen stoppen van het geselecteerde mediabestand.</td> </tr> <tr> <td></td> <td>Vorige</td> <td>Terugkeren naar het vorige mediabestand.</td> </tr> <tr> <td></td> <td>Volgende</td> <td>Naar het volgende mediabestand springen.</td> </tr> <tr> <td></td> <td>Dempen</td> <td>Het geluidsvolume in- of uitschakelen.</td> </tr> </tbody> </table> <p>* Touchpad wordt inactief als Media Console wordt geactiveerd.</p>		Film	Start afspeelsoftware voor films.		Muziek	Start afspeelsoftware voor muziek.		Afspelen/ Pauze	Een geselecteerd mediabestand afspelen of pauzeren.		Stoppen	Het afspelen stoppen van het geselecteerde mediabestand.		Vorige	Terugkeren naar het vorige mediabestand.		Volgende	Naar het volgende mediabestand springen.		Dempen	Het geluidsvolume in- of uitschakelen.
	Film	Start afspeelsoftware voor films.																						
	Muziek	Start afspeelsoftware voor muziek.																						
	Afspelen/ Pauze	Een geselecteerd mediabestand afspelen of pauzeren.																						
	Stoppen	Het afspelen stoppen van het geselecteerde mediabestand.																						
	Vorige	Terugkeren naar het vorige mediabestand.																						
	Volgende	Naar het volgende mediabestand springen.																						
	Dempen	Het geluidsvolume in- of uitschakelen.																						
7		Bediening van Media Console	Schakelt Media Console in of uit.																					

#	Pictogram	Item	Beschrijving
8		Communicatie-toets	Schakelt de communicatieapparaten van de computer in/uit. (Communicatieapparaten kunnen verschillen per configuratie.)
		Back-up-toets	Start Acer Backup Management voor databack-up in drie stappen.
		HDD-indicator <sup>1</sup>	Licht op wanneer de harde schijf actief is.
		Stroomindicator <sup>1</sup>	Geeft de vermogenstatus van de computer aan.
9		Kliktoetsen (links en rechts)	De toetsen links en rechts functioneren als de linker en rechter muistoetsen.
10		Polssteun	Comfortabele ondersteuning voor uw handen wanneer u de computer gebruikt.
11		Acer Bio-Protection vingerafdruklezer	Ondersteunt de Acer FingerNav 4-richtingen bedieningsfunctie (alleen voor bepaalde modellen).
12		Luidsprekers	Stereo geluidswaergave.
13		Aan/uit knop	Schakelt de computer aan en uit.













1. De statusindicatoren aan de voorkant zijn zelfs zichtbaar als het scherm gesloten is.



## Sneltoetsen

De computer gebruikt sneltoetsen of toetscombinaties voor toegang tot de meeste besturingselementen, zoals helderheid en geluidsvolume.

Om een sneltoets te gebruiken drukt u de <Fn> -toets in voordat u de andere toets van de combinatie indrukt.

Sneltoets	Pictogram	Functie	Beschrijving
<Fn> + <F3>		Communicatie-toets	Schakelt de communicatieapparaten van de computer in/uit. (Communicatieapparaten kunnen verschillen per configuratie.)
<Fn> + <F4>		Standby	Hiermee plaatst u de computer in de Standby-stand.
<Fn> + <F5>		Schakeltoets voor beeldscherm	Schakelt de weergave-uitvoer tussen het scherm, externe monitor (indien aangesloten) en beide.
<Fn> + <F6>		Leeg scherm	Hiermee schakelt u de lamp van het beeldscherm uit om stroom te besparen. Druk op een willekeurige toets om het beeldscherm weer te activeren.
<Fn> + <F7>		Schakeltoets voor touchpad	Hiermee schakelt u het interne touchpad in en uit.
<Fn> + <F8>		Schakeltoets voor luidspreker	Hiermee schakelt u de luidsprekers in en uit.
<Fn> + <◀▶>		Helderheid verhogen	Hiermee verhoogt u de helderheid van het beeldscherm.
<Fn> + <◀◀>		Helderheid verlagen	Hiermee verlaagt u de helderheid van het beeldscherm.
<Fn> + <Home>		Afspelen/Pauze	Een geselecteerd mediabestand afspelen of pauzeren.
<Fn> + <Pg Up>		Stoppen	Het afspelen stoppen van het geselecteerde mediabestand.
<Fn> + <Pg Dn>		Vorige	Terugkeren naar het vorige mediabestand.
<Fn> + <End>		Volgende	Naar het volgende mediabestand springen.

## Voorkant gesloten



#	Pictogram	Item	Beschrijving
1		Duimwiel	Zet het volume hoger of lager.
2		Meer-in-één-kaartlezer	Accepteert Secure Digital (SD), MultiMediaCard (MMC), Memory Stick (MS), Memory Stick PRO (MS PRO) en xD-Picture Card (xD). <b>Opmerking:</b> Duwen om de kaart te verwijderen/plaatsen. Slechts één kaart tegelijk mag gebruikt worden.
3		CIR-ontvanger	Ontvangt signalen van een afstandsbediening.



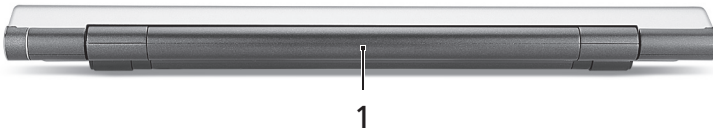



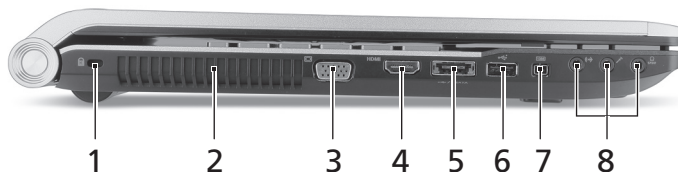

## Achterkant



#	Pictogram	Item	Beschrijving
1		Batterijnis	Bevat de batterij van de computer.





## Linkerkant

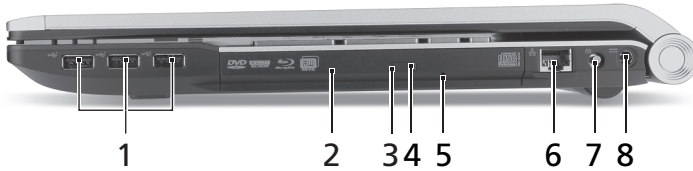

#	Pictogram	Item	Beschrijving
1		Kensington-slot sleuf	Aansluiting voor een Kensington-compatibel computerbeveiligingslot. <b>Opmerking:</b> Wikkel een kabel rond een vast, onwrikbaar object, zoals een tafel of een handgreep van een lade. Plaats het slot in de uitsparing en draai de sleutel om zodat het slot is vergrendeld. Er zijn ook modellen beschikbaar zonder Kensington-slot.
2		Ventilatie-sleuven	Zorgen dat de computer koel blijft, zelfs na langdurig gebruik.
3		Externe weergavepoort (VGA)	Aansluiting voor een beeldscherm (bijv. een externe monitor, LCD-projector).
4	HDMI	HDMI-poort	Ondersteunt high-definition digitale videosignalen.
5		USB 2.0/eSATA poort	Aansluiting voor USB 2.0- of eSATA-apparaten (alleen voor bepaalde modellen). <b>Opmerking:</b> Als u een eSATA-apparaat aansluit, zijn er tegelijkertijd drie USB-poorten beschikbaar.
6		USB 2.0-poort	Aansluiting voor USB 2.0-apparaten (bijv. USB-muis, USB-camera).
7		4-pins IEEE 1394 poort	Aansluiting voor IEEE 1394 apparaten.
8		Lijn-in aansluiting	Aansluiting voor lijn-in audioapparaten (zoals cd-speler, stereo walkman, mp3-speler).
		Aansluiting voor Microfoon-in	Aansluitingen voor externe microfoon.
		S/PDIF-ondersteuning voor hoofdtelefoon/luidspreker/lijn-uit	Aansluiting voor lijn-uit audioapparaten (bijv. luidsprekers, hoofdtelefoon).







## Rechterkant

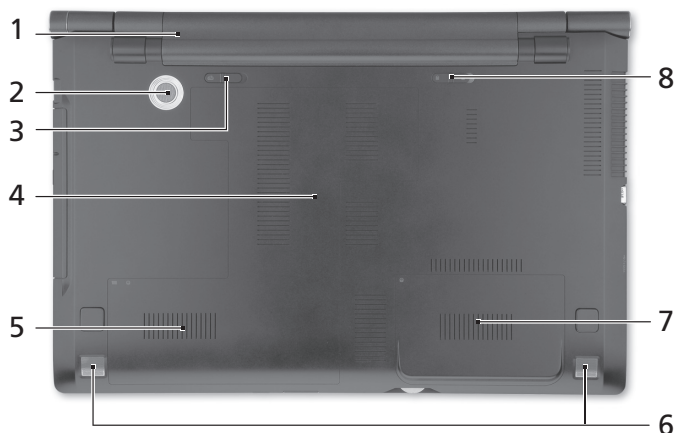

#	Pictogram	Item	Beschrijving
1		USB 2.0 poorten	Aansluiting voor USB 2.0-apparaten (bijv. USB-muis, USB-camera).
2		Optisch station	Intern optisch station; accepteert CDs of DVDs.
3		Toegangsindicator optische schijf	Brandt wanneer het optisch station actief is.
4		Uitwerpknop optisch station	Werpt de optische schijf uit het station.
5		Nood-uitwerpopening	Opent de lade van het optisch station wanneer de computer is uitgeschakeld. <b>Opmerking:</b> Steek een paperclip in de nooduitwerpopening om de lade van het optisch station uit te werpen als de computer is uitgeschakeld.
6		Ethernetpoort (RJ-45)	Aansluiting voor een Ethernet 10/100/1000-gebaseerd netwerk.
7		RF-in poort	Accepteert ingangsignalen van digitale TV-tuners (alleen voor bepaalde modellen).
8		Gelijk-stroomaansluiting	Aansluiting voor een adapter.

## Onderkant



#	Pictogram	Item	Beschrijving
1		Batterijnis	Bevat de batterij van de computer.
2		Subwoofer	Geeft geluid met lage frequentie weer.
3		Batterijvergrendeling	Maakt de batterij los.
4		Geheugenvak	Bevat het hoofdgeheugen van de computer.
5		Harde schijf nis-Primair	Bevat de harde schijf van de computer (vastgeschroefd).
6		Luidsprekers	Stereo geluidsweergave.
7		Harde schijf nis-Secundair	Bevat de harde schijf van de computer (vastgeschroefd) (alleen voor bepaalde modellen).
8		Batterijgrendel	Vergrendelt de accu op z'n plaats.

## Omgeving

---

- **Temperatuur:**
    - In gebruik: 5°C tot 35°C
    - Niet in gebruik: -20°C tot 65°C
  - **Vochtigheidsgraad (geen condensvorming):**
    - In gebruik: 20% tot 80%
    - Niet in gebruik: 20% tot 80%
-

# Acer Notisbok

Hurtigguide

© 2010 Med enerett.

Hurtigguide for Acer Notisbok  
Opprinnelig utgave: 03/2010

Modellnummer: \_\_\_\_\_

Serienummer: \_\_\_\_\_

Innkjøpsdato: \_\_\_\_\_

Innkjøpssted: \_\_\_\_\_



# Begynne med begynnelsen

Vi vil gjerne takke deg for at du har valgt en Acer-notebook til dine mobile databehandlingsbehov.

## Dine veiledere

Som hjelp til bruk av Acer-notebooken har vi utformet et sett av veiledere:

Til å begynne med vil plakaten **Før vi begynner...** hjelpe deg med å komme i gang med oppsettet av datamaskinen.

Den **generiske håndboken for Aspire-serien** inneholder nyttig informasjon om alle modeller i Aspire-produktserien. Den dekker grunnleggende emner som bruk av tastaturet, lyd, osv. Vennligst merk at både den **generiske håndboken** og **AcerSystem User Guide** som er nevnt nedenfor, fra tid til annen vil referere til funksjoner eller egenskaper som bare finnes på visse modeller, men ikke nødvendigvis på modellen du kjøpte. Slike forekomster er markert i teksten med kommentarer som "bare for visse modeller".

I den **Hurtigguide** får du en innføring i de grunnleggende egenskapene og funksjonene til den nye datamaskinen. Hvis du vil vite mer om hvordan datamaskinen kan gjøre deg mer produktiv, kan du slå opp i **AcerSystem User Guide**. Denne håndboken inneholder detaljert informasjon om emner som systemverktøy, datagjenvinning, utvidelsesalternativer og feilsøking/problemløsning. I tillegg finner du garantiopplysninger, generell informasjon og sikkerhetsmerknader for notisbokmaskinen din. Boken er tilgjengelig som PDF-fil (Portable Document Format) og leveres forhåndslastet på maskinen. Følg disse trinnene for å åpne den:

- 1 Klikk på  **Start > Alle Programmer > AcerSystem**.
- 2 Klikk på **AcerSystem User Guide**.



.....

**Merk:** Visning av filen krever at du har Adobe Reader installert. Hvis Adobe Reader ikke er installert på datamaskinen din, vil klikking på **AcerSystem User Guide** føre til at installeringsprogrammet for Adobe Reader kjøres i stedet. Følg instruksjonene på skjermen for å fullføre installeringen. Hvis du vil vite hvordan du bruker Adobe Reader, åpner du menyen **Hjelp og Støtte**.







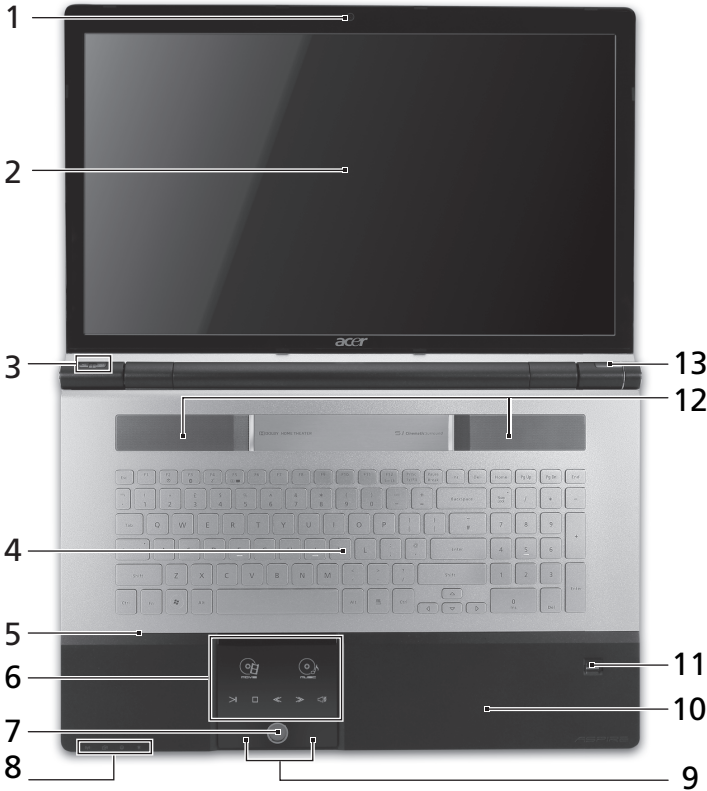



















# En omvisning i Acer-notebooken

Når du har satt opp datamaskinen som vist på plakaten **Før vi begynner...**, la oss ta en omvisning i din nye Acer-datamaskin.

## Visning ovenfra



#	Ikon	Element	Beskrivelse
1		Acer Crystal Eye-webkamera	Webkamera til videokommunikasjon (bare for visse modeller).
2		Skjerm	Kalles også LCD-skjerm (Liquid-Crystal Display; LCD), viser utdata fra datamaskinen (Konfigurasjonen kan variere mellom modellene).

#	Ikonelement	Element	Beskrivelse																					
3		Arcade-tast	Starter InstantOn Arcade.																					
P		P-tast/ Acer PowerSmart-tast	Programmerbar tast (Konfigurasjonen kan variere mellom modellene)./ Setter datamaskinen i strømsparingsmodus (Konfigurasjonen kan variere mellom modellene).																					
4		Tastatur	Legger inn data i datamaskinen.																					
5		Mikrofon	Intern mikrofon for lydinnspilling.																					
6		Pekeplate/ mediekonsoll	<p>Pekeenhet som reagerer på berøring og fungerer som en mus*./ Berøringskontroller for Acer Arcade, volum (opp/ned) og medier (spill av/pause, stopp, forrige, neste); med demping.</p> <table border="1"> <tbody> <tr> <td></td> <td>Film</td> <td>Åpner programvare for filmavspilling.</td> </tr> <tr> <td></td> <td>Musikk</td> <td>Åpner programvare for musikkspilling.</td> </tr> <tr> <td></td> <td>Play/Pause</td> <td>Spill av eller pause en valgt mediefil.</td> </tr> <tr> <td></td> <td>Stopp</td> <td>Stopp avspilling av den valgte mediefilen.</td> </tr> <tr> <td></td> <td>Forrige</td> <td>Returner til forrige mediefil.</td> </tr> <tr> <td></td> <td>Neste</td> <td>Hopp til neste mediefil.</td> </tr> <tr> <td></td> <td>Lyd av</td> <td>Slå volum av eller på.</td> </tr> </tbody> </table> <p>* Pepeplaten blir inaktiv når mediekonsollen er aktiv.</p>		Film	Åpner programvare for filmavspilling.		Musikk	Åpner programvare for musikkspilling.		Play/Pause	Spill av eller pause en valgt mediefil.		Stopp	Stopp avspilling av den valgte mediefilen.		Forrige	Returner til forrige mediefil.		Neste	Hopp til neste mediefil.		Lyd av	Slå volum av eller på.
	Film	Åpner programvare for filmavspilling.																						
	Musikk	Åpner programvare for musikkspilling.																						
	Play/Pause	Spill av eller pause en valgt mediefil.																						
	Stopp	Stopp avspilling av den valgte mediefilen.																						
	Forrige	Returner til forrige mediefil.																						
	Neste	Hopp til neste mediefil.																						
	Lyd av	Slå volum av eller på.																						
7		Mediekonsollkontroller	Slår mediekonsoll av eller på.																					
8		Kommunikasjons-tast	Aktiverer/deaktiverer datamaskinens kommunikasjonsenheter. (Kommunikasjonsenheter kan variere i konfigurasjon.)																					
		Sikkerhetskopiering-tast	Starter Acer Backup Management for sikkerhetskopiering av data i tre trinn.																					
		Harddiskindikator <sup>1</sup>	Lyser når harddisken er aktiv.																					
		Strømindikator <sup>1</sup>	Angir datamaskinens strømstatus.																					







#	Ikon	Element	Beskrivelse
9		Klikkeknapper (venstre og høyre)	Venstre og høyre knapp fungerer på samme måte som venstre og høyre museknapp.
10		Håndleddshviler	Komfortabelt støtteområde for hendene når du bruker datamaskinen.
11		Acer Bio-Protection fingeravtrykksleser	Støtter Acer FingerNav 4-veis kontrollfunksjon (bare for visse modeller).
12		Høytalere	Lever lydutdata i stereo.
13		Av/på-knapp	Slår datamaskinen av og på.







1. Frontpanelindikatorerne er synlige selv når skjermen er lukket.

## Hurtigtaster

Datamaskinen bruker hurtigtaster eller tastekombinasjoner for tilgang til de fleste av maskinens funksjoner, f.eks. skjermens lysstyrke og lydvolument.





Når du skal aktivere hurtigtaster, trykker du holder inne <Fn>-tasten før du trykker på den andre tasten i en hurtigtastkombinasjon.

Hurtigtast	Ikon	Funksjon	Beskrivelse
<Fn> + <F3>		Kommunikasjons-tast	Aktiverer/deaktiverer datamaskinens kommunikasjonsenheter. (Kommunikasjonsenheter kan variere i konfigurasjon.)
<Fn> + <F4>		Dvale	Setter datamaskinen i dvalemodus.
<Fn> + <F5>		Skjermbytte	Bytter mellom visning på vanlig skjerm, ekstern skjerm (hvis tilkoblet) eller begge deler.
<Fn> + <F6>		Blank skjerm	Slå av skjermens bakgrunnsbelysning for å spare strøm. Trykk på en hvilken som helst tast for å gå tilbake.
<Fn> + <F7>		Berøringsplate av/på	Slår den interne berøringsplaten av og på.
<Fn> + <F8>		Høytaler av/på	Slår høytalerne av og på.

Hurtigtast	Ikon	Funksjon	Beskrivelse
<Fn> + <D>		Lysstyrke opp	Øker skjermens lysstyrke.
<Fn> + <C>		Lysstyrke ned	Reduserer skjermens lysstyrke.
<Fn> + <Home>		Play/Pause	Spill av eller pause en valgt mediefil.
<Fn> + <Pg Up>		Stopp	Stopp avspilling av den valgte mediefilen.
<Fn> + <Pg Dn>		Forrige	Returner til forrige mediefil.
<Fn> + <End>		Neste	Hopp til neste mediefil.

## Lukket frontvisning



#	Ikon	Element	Beskrivelse
1		Tommelhjul	Slå volum opp eller ned.
2	    	Multi-i-1-kortleser	Godtar Secure Digital (SD), MultiMediaCard (MMC), Memory Stick (MS), Memory Stick Pro (MS PRO), og xD-Picture Card (xD). <b>Merk:</b> Skyv inn for å fjerne/installere kortet. Bare ett kort kan operere til enhver tid.
3		CIR-mottaker	Mottar signaler fra en ekstern kontroll.

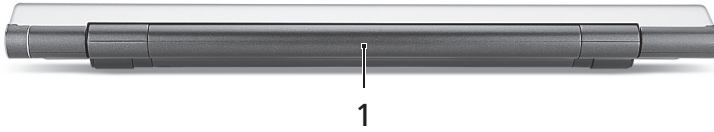

## Bakre visning





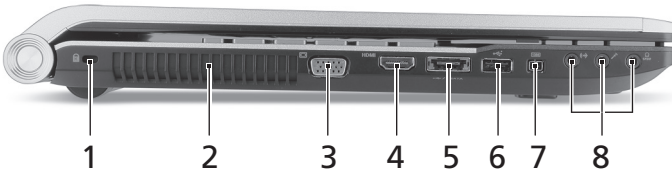



#	Ikonelement	Beskrivelse
1	 Batterierom	Huser datamaskinens batterier.

## Venstre visning





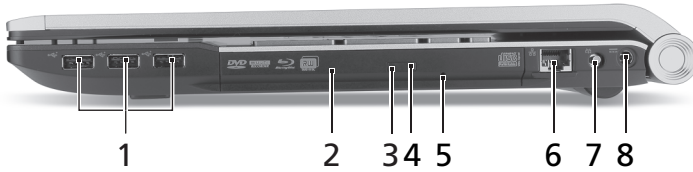

#	Ikonelement	Beskrivelse
1	 Spor for Kensington-lås	Kobler til en Kensington-kompatibel sikkerhetslås for datamaskinen. <b>Merk:</b> Koble en sikkerhetslåskabel rundt et ubevegelig objekt som et bord eller håndtaket på en låst skuff. Sett inn låsen i sporet og vri om nøkkelen for å låse. Noen nøkkelløse modeller er også tilgjengelige.
2	Ventilasjonsåpninger	Gir datamaskinen mulighet til å holde seg kjølig, selv etter lang tids bruk.
3	 Port for ekstern skjerm (VGA)	Kobler til en skjermenhet (f.eks. ekstern skjerm, LCD-projektor).
4	HDMI	HDMI-port
		Støtter høydefinisjons digitale videoforbindelser.

#	Ikon	Element	Beskrivelse
5	 /e SATA	USB 2.0/eSATA-port	Kobler til USB 2.0- eller eSATA-enheter (bare for visse modeller). <b>Merk:</b> Hvis du plugger inn en eSATA-enhet, vil du ha tre tilgjengelige USB-porter samtidig.
6		USB 2.0-port	Kobler til USB 2.0-enheter (f.eks. USB-mus, USB-kamera).
7		4-pinners IEEE 1394-port	Kobler til IEEE 1394-enheter.
8		Line-in-port	Mottar data fra lydinndataenheter (f.eks. lyd fra CD-spiller, stereowalkman, mp3-spiller).
		Mikrofonplugg	Mottar inndata fra eksterne mikrofoner.
	 SPDIF	Hodetelefon/høyttalere/line-out-port med S/PDIF-støtte	Kobles til utdataenheter for lyd (f.eks. høyttalere, hodetelefon).

## Høyre visning







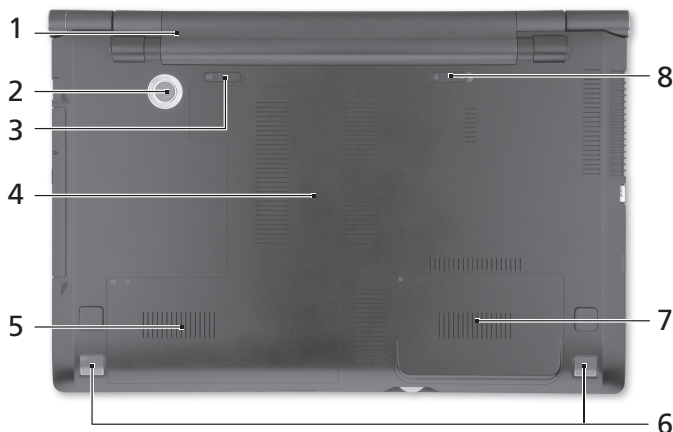

#	Ikone	Element	Beskrivelse
1		USB 2.0-porter	Kobler til USB 2.0-enheter (f.eks. USB-mus, USB-kamera).
2		Optisk stasjon	Intern optisk stasjon. Godtar CDer og DVDer.
3		Tilgangsindikator for optisk disk	Lyser når den optiske stasjonen er aktiv.
4		Utløserknapp for optisk stasjon	Løser ut den optiske disken fra stasjonen.
5		Nødutløserhull	Løser ut platen i den optiske stasjonen når datamaskinen er slått av. <b>Merk:</b> Sett en binders i nødutløserhullet hvis du må løse ut den optiske stasjonen når datamaskinen er av.
6		Ethernet-port (RJ-45)	Kobler til et Ethernet 10/100/1000-basert nettverk.
7		RF-in-port	Godtar inndatasignaler fra digitale TV-tunere (bare for visse modeller).
8		Strømtilkobling	Kobler til en batterieliminatør.



## Bunnvisning



#	Ikonelement	Element	Beskrivelse
1		Batterirom	Huser datamaskinens batterier.
2		Basshøytaler	Lavfrekvent utgående lyd.
3		Batterifrigivelsesbolt	Frigir batteriet for fjerning.
4		Minnerom	Huser datamaskinens hovedminne.
5		Harddiskplass-hoved	Huser datamaskinens harddisk (sikret med skruer).
6		Høytalere	Lever lydutdata i stereo.
7		Harddiskplass-sekundær	Huser datamaskinens harddisk (sikret med skruer) (bare for visse modeller).
8		Batterilås	Låser batteriet på plass.

## Miljø

- Temperatur:
  - Drift: 5°C til 35°C
  - Ikke i bruk: -20°C til 65°C
- Luftfuktighet (ikke-kondenserende):
  - Drift: 20% til 80%
  - Ikke i bruk: 20% til 80%



# Acer Notebook

Hurtig-guide

© 2010 Alle Rettigheder Forbeholdes.

Acer Notebook - Hurtig-guide  
Oprindeligt udgivet: 03/2010

Modelnummer: \_\_\_\_\_

Serienummer: \_\_\_\_\_

Købsdato: \_\_\_\_\_

Købt hos: \_\_\_\_\_

# Generelle oplysninger

Tak, fordi du har valgt en Acer notebook som din mobile computer.

## Vejledninger

Vi har udarbejdet et sæt vejledninger til at hjælpe dig med at anvende din Acer notebook.

Først og fremmest bogen **Sådan kommer du i gang...**, som hjælper dig med opsætning af computeren.

Den **Aspire seriens Fælles brugervejledning** indeholder nyttige oplysninger, der gælder alle modellerne i Aspire produktserien. Den dækker grundlæggende emner som f. eks. brug af tastatur, lyd etc. Husk venligst, at **Fælles brugervejledning** såvel som **AcerSystem User Guide** nævnt nedenfor henviser nogle gange til funktioner eller kapaciteter, der kun findes i udvalgte modeller, og ikke nødvendigvis i den model du købte. I disse tilfælde er teksten markeret med f. eks. "kun for udvalgte modeller".

Den **Hurtig-guide** beskriver de grundlæggende egenskaber og funktioner ved din nye computer. Du kan finde flere oplysninger om, hvordan computeren kan hjælpe dig til at blive mere produktiv, i **AcerSystem User Guide**. Denne vejledning indeholder detaljerede oplysninger om emner som systemprogrammer, datagendannelse, udvidelsesmuligheder og fejlfinding. Den indeholder desuden garantioplysninger samt generelle bestemmelser og sikkerhedsbemærkninger til notebook-computeren. Den er tilgængelig i PDF-format (Portable Document Format) og er forudinstalleret på notebook-pc. Følg disse trin for at få adgang til den:

- 1 Klik på  **Start > Alle programmer > AcerSystem**.
- 2 Klik på **AcerSystem User Guide**.



.....

**Bemærk:** For at få vist filen skal du have Adobe Reader installeret. Hvis Adobe Reader ikke er installeret på din computer, kører installationsprogrammet til Adobe Reader automatisk, når du klikker på **AcerSystem User Guide**. Følg vejledningen på skærmen for at afslutte installationen. Yderligere oplysninger om, hvordan du bruger Adobe Reader, finder du i menuen **Hjælp og Support**.







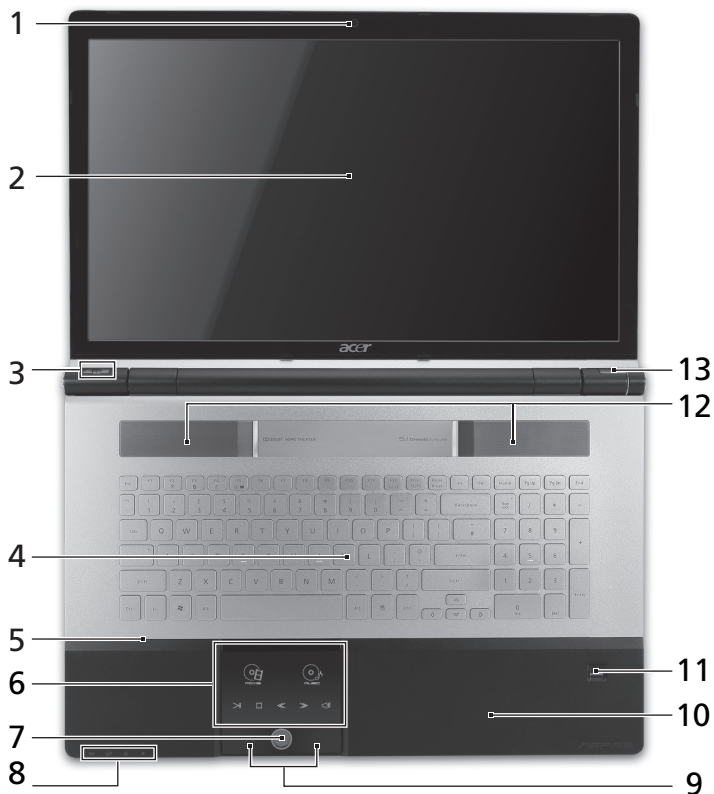



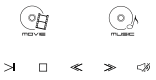











# En præsentation af din Acer notebook





Når du har sat computeren op som vist på illustrationerne på plakaten **Sådan kommer du i gang...**, bør du bruge et par minutter på at lære din nye Acer notebook at kende.

## Fra oven



#	Ikon	Emne	Beskrivelse
1		Acer Crystal Eye webcam	Webkamera til videokommunikation (kun for udvalgte modeller).

#	Ikon	Emne	Beskrivelse																					
2		Skærm	Det kaldes også for et LCD (Liquid-Crystal Display - flydende krystaldisplay), og det viser computerens output (konfiguration kan variere fra model til model).																					
3		Arcade-taste	Starter InstantOn Arcade.																					
	P	P-taste/ Acer PowerSmart-tast	Programmerbar taste (Konfiguration kan variere fra model til model). / Sætter din computer i strømbesparelsestilstand (Konfiguration kan variere fra model til model).																					
4		Tastatur	Til indtastning af data på computeren.																					
5		Mikrofon	Intern mikrofon til optagelse af lyd.																					
6		Pegefelt/ mediekonsol	<p>Et berøringfølsomt pegegedskab, der fungerer ligesom en computermus*./ Berøringfølsomme funktioner for Acer Arcade, lydstyrke (op/med) og medier (afspil/pause, stop, forrige, næste). Med Slå lyd fra.</p> <table border="1"> <tbody> <tr> <td></td> <td>Film</td> <td>Start software til afspilning af film.</td> </tr> <tr> <td></td> <td>Musik</td> <td>Start software til afspilning af musik.</td> </tr> <tr> <td></td> <td>Afspil/ Pause</td> <td>Afspil eller stands midlertidigt en udvalgt mediefil.</td> </tr> <tr> <td></td> <td>Stop</td> <td>Standser afspilningen af den valgte mediefil.</td> </tr> <tr> <td></td> <td>Forrige</td> <td>Går tilbage til forrige mediefil.</td> </tr> <tr> <td></td> <td>Næste</td> <td>Springer til den næste mediefil.</td> </tr> <tr> <td></td> <td>Lydløs</td> <td>Tænd eller sluk for lydstyrken.</td> </tr> </tbody> </table> <p>* Pegefelt bliver inaktivt, når mediekonsollen er aktiv.</p>		Film	Start software til afspilning af film.		Musik	Start software til afspilning af musik.		Afspil/ Pause	Afspil eller stands midlertidigt en udvalgt mediefil.		Stop	Standser afspilningen af den valgte mediefil.		Forrige	Går tilbage til forrige mediefil.		Næste	Springer til den næste mediefil.		Lydløs	Tænd eller sluk for lydstyrken.
	Film	Start software til afspilning af film.																						
	Musik	Start software til afspilning af musik.																						
	Afspil/ Pause	Afspil eller stands midlertidigt en udvalgt mediefil.																						
	Stop	Standser afspilningen af den valgte mediefil.																						
	Forrige	Går tilbage til forrige mediefil.																						
	Næste	Springer til den næste mediefil.																						
	Lydløs	Tænd eller sluk for lydstyrken.																						
7		Mediekonsolkon-troller	Tænder eller slukker for mediekonsollen.																					

#	Ikon	Emne	Beskrivelse
8		Kommunikations-taste	Aktiverer/deaktiverer computerens kommunikationsenheder. (Kommunikationsenheder kan variere efter konfiguration).
		Sikkerhedskopierings-taste	Starter Acer Backup Management til en tre-trins sikkerhedskopiering af data.
		Harddiskindikator <sup>1</sup>	Lyser, når harddisken er aktiv.
		Strømindikator <sup>1</sup>	Angiver computerens strømstatus.
9		Klik-knapper (til venstre og til højre)	Knapperne til højre og venstre fungerer på samme måde som musens højre og venstre knapper.
10		Håndfladestøtte	Et komfortabelt støtteområde for dine hænder, når du bruger computeren.
11		Acer Bio-Protection-fingeraftryklæser	Understøtter Acer FingerNav 4-vejskontroloffunktion (kun for udvalgte modeller).
12		Højtalere	Leverer stereolydoutput.
13		Afbryderknop	Tænder/slukker for computeren.













1. Frontpanelets indikatorer er synlige, selvom computerens låg er lukket.



## Hurtigtaster

Computeren bruger hurtigtaster eller tastkombinationer til at få adgang til de fleste af computerens kontroller som skærmens lysstyrke og lydstyrke.

Hvis du vil aktivere hurtigtaster, skal du holde <Fn> -tasten nede og derefter trykke på den anden tast i hurtigtastkombinationen.

Hurtigtast	Ikon	Funktion	Beskrivelse
<Fn> + <F3>		Kommunikations taste	Aktiverer/deaktiverer computerens kommunikationsenheder. (Kommunikationsenheder kan variere efter konfiguration).
<Fn> + <F4>		Dvale	Sætter computeren i dvaletilstand.
<Fn> + <F5>		Skærm til/fra	Skifter skærmoutputtet mellem skærmen, en ekstern skærm (hvis den er tilsluttet) og begge to.
<Fn> + <F6>		Tom skærm	Slukker for skærmens baggrundslys for at spare strøm. Tryk på en vilkårlig tast for at fortsætte.
<Fn> + <F7>		Pegefelt til/fra	Tænder og slukker for det interne pegefelt.
<Fn> + <F8>		Højtaler til/fra	Tænder og slukker for højttalerne.
<Fn> + <▷>		Lysstyrke op	Forøger skærmens lysstyrke.
<Fn> + <◁>		Lysstyrke ned	Formindsker skærmens lysstyrke.
<Fn> + <Home>		Afspil/Afbryd	Afspil eller stands midlertidigt en udvalgt mediefil.
<Fn> + <Pg Up>		Stop	Standser afspilningen af den valgte mediefil.
<Fn> + <Pg Dn>		Forrige	Går tilbage til forrige mediefil.
<Fn> + <End>		Næste	Springer til den næste mediefil.

## Forfra - Lukket



#	Ikon	Emne	Beskrivelse
1		Tommelhjul	Øger eller sænker lydstyrken.
2		Flere-i-en-kortlæser	Accepterer Secure Digital (SD), MultiMediaCard (MMC), Memory Stick (MS), Memory Stick PRO (MS PRO), og xD-Picture Card (xD). <b>Bemærk:</b> Skub for at fjerne/installere kortet. Der kan kun være et kort aktivt ad gangen.
3		CIR-modtager	Modtager signaler fra en fjernstyring.



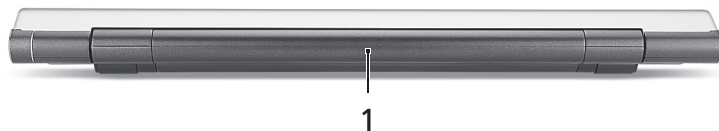



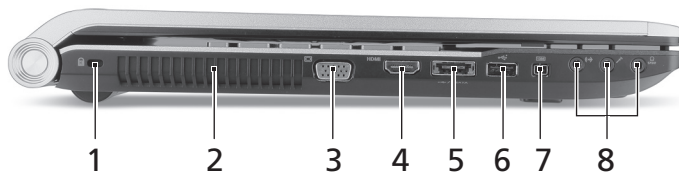

## Set bagfra



#	Ikon	Emne	Beskrivelse
1		Batterirum	Indeholder computerens batteri.





## Fra venstre

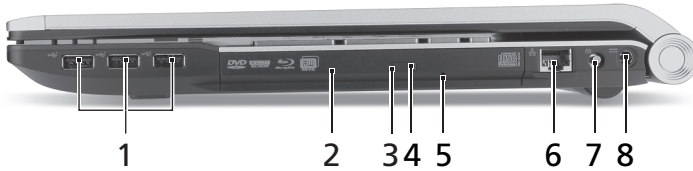

#	Ikón	Emne	Beskrivelse
1		Åbning til en Kensington-lås	Tilslutter til en Kensington-kompatibel computers sikkerheds-lås. <b>Bemærk:</b> Sno kablet til computersikkerhedslåsen rundt om en fast genstand, f.eks. et bord eller et håndtag på en låst skuffe. Sæt låsen i indhakked, og drej nøglen, så låsen sættes fast. Der findes også modeller uden nøgle.
2		Ventilationsåbninger	Lader computeren være kølig selv efter lang tids brug.
3		Stik til ekstern skærm (VGA)	Tilslutter til en skærm (f.eks. ekstern skærm, LCD-projektor).
4	HDMI	HDMI-port	Understøtter high-definition digitale netværksforbindelser.
5	 /e SATA	USB 2.0/eSATA-port	De er beregnet til tilslutning af to USB 2.0 eller eSATA-enheder (kun på visse modeller). <b>Bemærk:</b> Hvis du tilslutter en eSATA-enhed, har du tre ledige USB-porte tilgængelige.
6		USB 2.0-port	Tilslutter til USB 2.0-enheder (f.eks. USB-mus, USB-kamera).
7		IEEE 1394 port m. 4 ben	Beregnet til tilslutning af IEEE 1394-enheder.
8		Indgangsstik	Indgang for lydudstyr (f. eks. CD-afspiller, stereo-walkman, MP3-afspiller).
		Mikrofonstik	Accepterer input fra eksterne mikrofoner.
		Hovedtelefoner/højtaler/udgangsstik med S/PDIF understøttelse	Der kan tilsluttes ekstraudstyr (f. eks. højttalere, hovedtelefoner).







## Fra højre

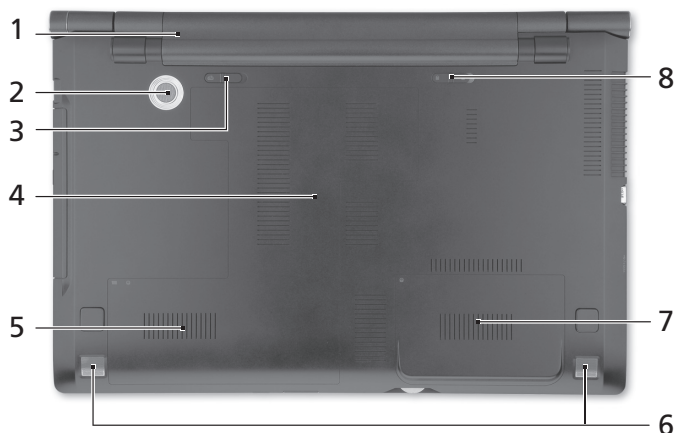

#	Ikon	Emne	Beskrivelse
1		USB 2.0-porte	Tilslutter til USB 2.0-enheder (f.eks. USB-mus, USB-kamera).
2		Optisk drev	Internt optisk drev; accepterer CD'er og DVD'er.
3		Optisk disk - adgangsimpikator	Lyser når det optiske drev er aktivt.
4		Udløserknop for det optiske drev	Skubber den optiske disk ud ad drevet.
5		Mekanisk udløserhul	Det åbner skuffen til det optiske drev, når computeren er slukket. <b>Bemærk:</b> Indsæt en papirklips i hullet til nødudskubning for at skubbe den optiske drevbakke ud, når computeren er slukket.
6		Netværksport (RJ-45)	Til tilslutning af et Ethernet 10/100/1000-baseret netværk.
7		RF-indgangsport	Accepterer inputsignaler fra digitale TV-tunere (kun for udvalgte modeller).
8		Jævnstrøm ind-stik	Tilslutter til en AC-adapter.

## Set fra bunden



#	Ikon	Emne	Beskrivelse
1		Batterirum	Indeholder computerens batteri.
2		Subwoofer	Udsender lavfrekvens lyd.
3		Frigørelsesarm til batteri	Frigør batteriet til udtagning.
4		Hukommelsesrum	Her sidder computerens centrale hukommelse.
5		Harddiskbås-hoved	Indeholder computerens harddisk (fastsat med skruer).
6		Højtalere	Leverer stereolydoutput.
7		Harddiskbås-sekundær	Indeholder computerens harddisk (fastsat med skruer) (kun for udvalgte modeller).
8		Batterilås	Låser batteriet på plads.

## Omgivelser

---

- Temperatur:
    - Under brug: 5°C til 35°C
    - Ikke i brug: -20°C til 65°C
  - Fugtighed (ikke-kondenserende):
    - Under brug: 20% til 80%
    - Ikke i brug: 20% til 80%
-

# Acer bärbar dator

## Snabbguide

© 2010 Med ensamrätt.

Snabbguide för Acer bärbar dator  
Ursprunglig utgåva: 03/2010

Modellnummer: \_\_\_\_\_

Serienummer: \_\_\_\_\_

Inköpsdatum: \_\_\_\_\_

Inköpsställe: \_\_\_\_\_



# Välkommen!

Vi vill tacka för att du har valt en bärbar Acer-dator som kommer att uppfylla dina krav på bärbar datorbehandling.

## Dina handböcker

Vi har tagit fram en uppsättning guider som hjälper vid användning av din bärbara Acer-dator:

Till att börja med finns instruktionsfoldern **Börja med att läsa detta...** som hjälper dig komma igång med installationen av datorn.

Den **Allmän användarguide för Aspire-serien** innehåller användbar information som gäller alla modeller i Aspire-produktserien. Den omfattar grundläggande ämnen som användning av tangentbordet, ljud, osv. Var medveten om att **Allmän användarguide** samt **AcerSystem User Guide** som nämns nedan till följd av sin natur då och då hänvisar till funktioner som bara finns i vissa av seriens modeller men inte nödvändigtvis i den modell som du har köpt. Sådana exempel markeras i texten med fraser som "endast för vissa modeller".

I den **Snabbguide** presenteras de grundläggande funktionerna i din nya dator. Mer information om hur datorn kan hjälpa dig att bli mer produktiv finns i **AcerSystem User Guide**. Denna handbok innehåller detaljerad information om ämnen som systemverktyg, dataåterhämtning, expansionsalternativ och felsökning. Dessutom innehåller den garantiinformation och allmänna regler, samt säkerhetsnoteringar om din bärbara dator. Den är tillgänglig i Portable Document Format (PDF) och levereras förinstallerad i den bärbara datorn. Följ dessa steg för att få tillgång till den:

- 1 Välj  **Start > Alla program > AcerSystem.**
- 2 Dubbelklicka på **AcerSystem User Guide.**



.....

**Obs:** Du måste ha Adobe Reader installerat för att kunna visa filen. Om Adobe Reader inte är installerat på datorn kommer det att installeras när du dubbelklickar på **AcerSystem User Guide**. Utför installationen genom att följa instruktionerna på bildskärmen. Instruktioner för hur du använder Adobe Reader finns på menyn **Hjälp och Support**.







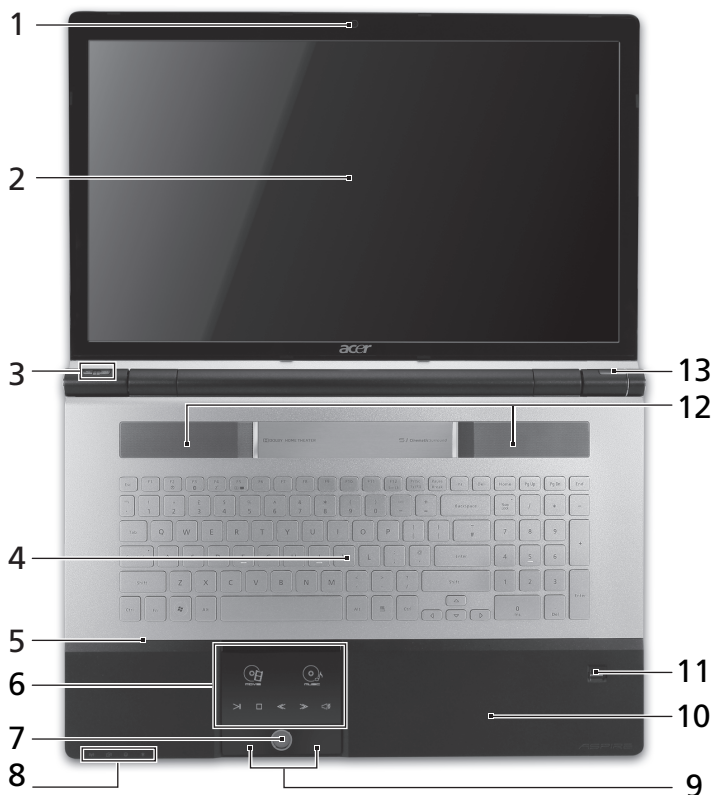

# Beskrivning av din bärbara Acer-dator





När du har installerat datorn enligt illustration på instruktionsfolder **Börja med att läsa detta...** vill vi beskriva din nya bärbara Acer-dator.

## Vy över ovasidan



#	Ikön	Objekt	Beskrivning
1		Acer Crystal Eye webbkamera	Webbkamera för videokommunikation (endast för vissa modeller).

#	Ikon	Objekt	Beskrivning
2		Bildskärm	Kallas även Liquid-Crystal Display (LCD), visar utdata från datorn (konfigurationen kan variera med olika modeller).
3		Arcade-knapp	Startar Acer InstantOn Arcade.
	P	P-knapp/ Acer PowerSmart-tangent	Programmerbar knapp (konfigurationen kan variera från modell till modell)./ Försätter datorn i energisparläge (konfigurationen kan skilja sig från en modell till en annan).
4		Tangentbord	För inmatning av data i datorn.
5		Mikrofon	Inbyggd mikrofon för ljudinspelning.
6		Pekplatta/ Mediakonsol	Beröringskänslig pekenhet som fungerar som en datormus*./ Beröringskänsliga kontroller till Acer Arcade, volym (höja/sänka) och media (spela upp/pausa, stoppa, föregående, nästa); med tyst-knapp.
		Film	Starta program för filmuppspelning.
		Musik	Starta program för musikuppspelning.
		Spela upp/ pausa	Spelar upp eller pausar en vald mediefil.
		Stopp	Stoppar uppspelning av vald mediefil.
		Föregående	Återgår till föregående mediefil.
		Nästa	Hoppar till nästa mediefil.
		Ljud av	Slår på och av ljudet.
			* Pekplattan inaktiveras när Mediakonsolen är aktiv.
7		Kontroll för Mediakonsol	Slår på och av Mediakonsolen.











#	Ikon	Objekt	Beskrivning
8		Kommunikationstangent	Aktiverar/avaktiverar datorns kommunikationsenheter. (Kommunikationsenheterna kan variera beroende på konfiguration.)
		Säkerhetskopieringsknapp	Startar Acer Backup Management för säkerhetskopiering av data i tre steg.
		Hårddiskindikator <sup>1</sup>	Tänds när hårddisken arbetar.
		På-indikator <sup>1</sup>	Anger om datorn är av eller på.
9		Klickknappar (vänster och höger)	Vänster och höger knapp fungerar som vänster och höger musknapp.
10		Handlovsstöd	Handlovsstödet ger bekvämt stöd för händerna när du använder datorn.
11		Acer Bio-Protection fingeravtrycksläsare	Stöder funktionen Acer FingerNav 4-vägs kontroll (endast för vissa modeller).
12		Högtalare	Avger utgående stereoljud.
13		Av/på-knapp	Slår på och stänger av datorn.

1. Indikatorerna på frontpanelen syns även när datorhöljet är stängt.

## Snabbtangenter

Datorn använder snabbtangenter eller tangentkombinationer för att komma åt de flesta av datorns kontroller som t.ex. skärmens ljusstyrka och volym.

Du aktiverar snabbtangenter genom att hålla ned <Fn> innan du trycker på den andra tangenten i snabbtangentskombinationen.

Snabbtangent	Ikon	Funktion	Beskrivning
<Fn> + <F3>		Kommunikationstangent	Aktiverar/avaktiverar datorns kommunikationsenheter. (Kommunikationsenheterna kan variera beroende på konfiguration.)
<Fn> + <F4>		Sleep	Placera datorn i vänteläge.
<Fn> + <F5>		Växla bildskärm	Växlar visning mellan datorns bildskärm och en extern monitor (om ansluten) och båda.
<Fn> + <F6>		Skärmsläckare	Stänger av bildskärmens bakgrundsbelysning för att spara ström. Återgå genom att trycka på en valfri tangent.
<Fn> + <F7>		Aktivera pekplatta	Aktivera/inaktivera den interna pekplattan.
<Fn> + <F8>		Aktivera högtalare	Sätt på/stäng av högtalarna.
<Fn> + <D>		Öka ljusstyrkan	Ökar bildskärmens ljusstyrka.
<Fn> + <D>		Minska ljusstyrkan	Minskar bildskärmens ljusstyrka.
<Fn> + <Home>		Spela upp/pausa	Spelar upp eller pausar en vald mediefil.
<Fn> + <Pg Up>		Stopp	Stoppas uppspelning av vald mediefil.
<Fn> + <Pg Dn>		Föregående	Återgår till föregående mediefil.
<Fn> + <End>		Nästa	Hoppar till nästa mediefil.

## Vy över stängd framsida



#	Ikon	Objekt	Beskrivning
1		Tumhjul	Höjer och sänker ljudet.
2		Flera-i-1-kortläsare	Avsedd för Secure Digital (SD), MultiMediaCard (MMC), Memory Stick (MS), Memory Stick PRO (MS PRO), xD-Picture Card (xD). <b>Obs!</b> Tryck för att ta bort/sätta i kortet. Endast ett enda kort kan vara aktivt åt gången.
3		CIR-mottagare	Tar emot signaler från en fjärrkontroll.



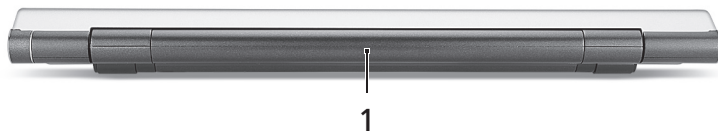



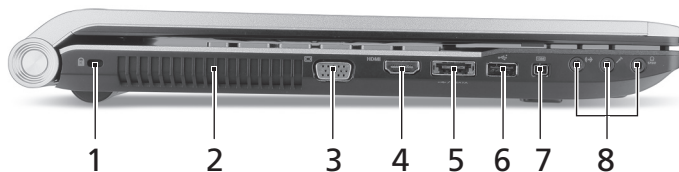

## Vy bakifrån



#	Ikon	Objekt	Beskrivning
1		Batterifack	Avsett för datorns batteripack.





## Vy från vänster

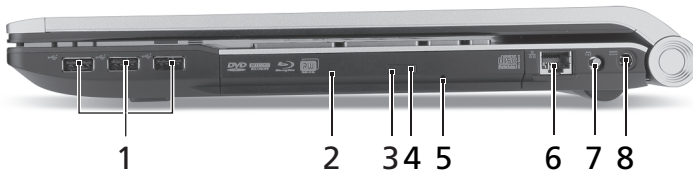

#	Ikön	Objekt	Beskrivning
1		Skåra för Kensingtonlås	Ansluts till ett Kensington-kompatibelt datorskyddslås. <b>Obs!</b> Lägg en låsvajer runt ett fast föremål, t.ex. ett bord eller handtaget till en låst skrivbordslåda. Sätt in låset i uttaget och lås det sedan genom att vrida om nyckeln. Vissa modeller är dock nyckellösa.
2		Ventilationsöppningar	Möjliggör att datorn håller sig sval, även efter långvarig användning.
3		Port för extern bildskärm (VGA)	Anslutning till en visningsenhet (t.ex. extern bildskärm, LCD-projektor).
4	HDMI	HDMI-port	Har stöd för digitala videoanslutningar av högdefinitionstyp.
5	 /e SATA	USB 2.0/eSATA-port	Anslutning för USB 2.0- eller eSATA-enheter (endast för vissa modeller). <b>Obs!</b> Om du ansluter en eSATA-enhet har du tre tillgängliga USB-portar under tiden.
6		USB 2.0-port	Ansluts till USB 2.0-enheter (t.ex. USB-mus, USB-kamera).
7		4-stifts IEEE 1394-port	Anslutning till IEEE 1394-enheter.
8		Ingång för linje-in	Ingång för externa ljudenheter (t.ex. cd-spelare, freestyle, mp3-spelare).
		Ingång för mikrofon	Anslutning för externa mikrofoner.
		Utgång för hörlurar/högtalar/ linje ut med S/PDIF-stöd	Ansluts till ljud ut-enheter (t.ex. högtalare, hörlurar).

## Vy från höger







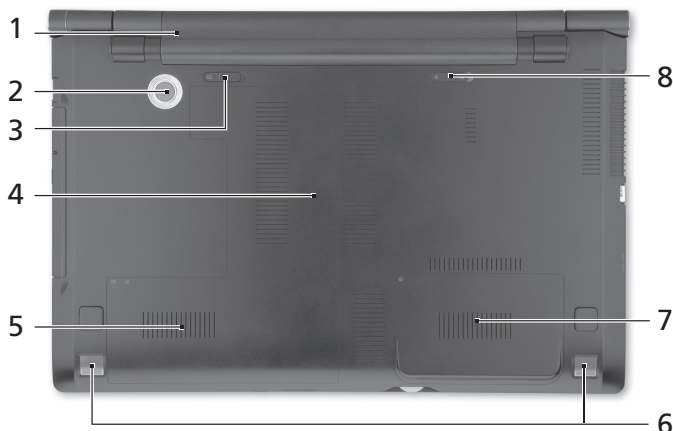

#	Ikön	Objekt	Beskrivning
1		USB 2.0-portar	Ansluts till USB 2.0-enheter (t.ex. USB-mus, USB-kamera).
2		Optisk läsenhet	Inbyggd optisk läsenhet för CD- eller DVD-skivor.
3		Åtkomstindikator för optisk läsenhet	Tänds när den optiska läsenheten arbetar.
4		Utmatningsknapp för optisk läsenhet	Matar ut skivan från den optiska läsenheten.
5		Hål för mekanisk utmatning	Matar ut skivluckan från den optiska läsenheten när datorn är avstängd. <b>Obs!</b> För in spetsen på ett gem i det mekaniska utmatningshålet för att mata ut det optiska enhetsfacket när datorn är avslagen.
6		Ethernet-port (RJ-45)	Ansluts till ett Ethernet 10/100/1000-baserat nätverk.
7		RF-in-port	Accepterer inputsignaler fra digitale TV-tunere (endast för vissa modeller).
8		DC in-anlutning	Ansluts till en växelströmsadapter.



## Vy underifrån



#	Ikön	Objekt	Beskrivning
1		Batterifack	Avsett för datorns batteripack.
2		Subwoofer	Högtalare för lågfrekventa ljud.
3		Hake för frigöring av batteriet	Frigör batteriet före borttagning.
4		Minnesfack	Här finns datorns huvudminne.
5		Huvudhårddiskfack	Utrymme för datorns hårddisk (fastskruvad).
6		Högtalare	Avger utgående stereoljud.
7		Sekundärt hårddiskfack	Utrymme för datorns hårddisk (fastskruvad) (endast för vissa modeller).
8		Batterilås	Låser batteriet på plats.

## Miljö

- Temperatur:
  - Vid drift: 5°C till 35°C
  - Utom drift: -20°C till 65°C
- Luftfuktighet (icke-kondenserande):
  - Vid drift: 20% till 80%
  - Utom drift: 20% till 80%



# Acerin kannettava tietokone

Pikaohje

© 2010 Kaikki oikeudet pidätetään.

Acerin kannettavan tietokoneen pikaopas  
Ensimmäinen julkistus: 03/2010

Mallinumero: \_\_\_\_\_

Sarjanumero: \_\_\_\_\_

Ostopäivämäärä: \_\_\_\_\_

Ostopaikka: \_\_\_\_\_

# Aloitetaan perusasioista

Haluamme kiittää sinua Acerin kannettavan tietokoneen valitsemisesta liikkuvien tietokonetarpeitesi täyttämässä.

## Ohjeet

Helpottaaksesi sinua Acer-tietokoneen käyttämisessä olemme suunnitelleet sarjan ohjekirjoja:

Ensiksikin, juliste **Aloittelijoille...** auttaa sinua tietokoneen käyttöönotossa.

**Aspire-sarjan Peruskäyttäjän opas** sisältää hyödyllisiä tietoja, jotka käyvät Aspire -tuotesarjan kaikille malleille. Se kattaa perusaiheet kuten joka käyttää näppäistöä, ääntä, jne. On ymmärrettävä, että luonteestaan johtuen, **Peruskäyttäjän opas** sekä alla mainittu **AcerSystem User Guide** viittaavat ajoittain toimintoihin tai ominaisuuksiin, jotka on sisällytetty vain tiettyihin sarjan malleihin, mutta ei välttämättä ostamaasi malliin. Sellaiset tapaukset on merkitty tekstissä kyseisellä kielellä "vain tietyille malleille".

**Pikaohje** esittelee uuden tietokoneesi perusominaisuudet ja -toiminnot. Lisätietoja siitä, miten tietokoneesi auttaa sinua lisäämään tuottavuutta, on annettu ohjeessa **AcerSystem User Guide**. Tässä ohjeessa on yksityiskohtaiset ohjeet järjestelmätoiminnoista, tietojen palauttamisesta, tietokoneen laajentamisesta ja ongelmanratkaisusta. Siinä on myös annettu yleisiä ohjeita, tietoja takuusta sekä turvallisuusohjeita. Se on saatavana Portable Document Format (PDF) -muodossa ja se on jo asennettu tietokoneellesi. Voit avata sen noudattamalla seuraavia ohjeita:

- 1 Napsauta  **Käynnistä > Kaikki ohjelmat > AcerSystem.**
- 2 Napsauta **AcerSystem User Guide.**



-----

**Ohje:** Jotta voit katsella käyttöohjekirjaa, Adobe Readerin on oltava asennettu. Jos Adobe Reader ei ole asennettu, sen asennus käynnistyy ennen **AcerSystem User Guide** avaamista. Noudata näytölle tulevia ohjeita, kunnes asennus on valmis. Saat lisätietoja Adobe Readerin asennuksesta ja käytöstä valikosta **Ohje ja tukikeskus**.







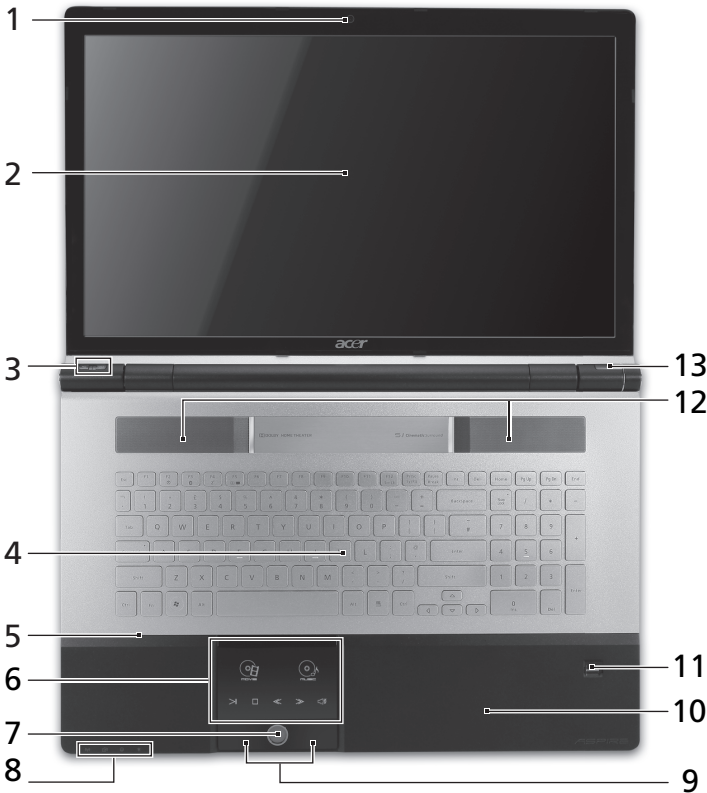

# Tutustuminen Acerin kannettavaan tietokoneeseen

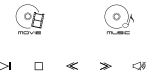



Kun olet asentanut tietokoneesi kuten **Alottelijoille...** -tiedotteessa on kerrottu, anna meidän esitellä uusi kannettava Acer-tietokoneesi.

## Näkymä ylhäältä



#	Kuvake	Osio	Kuvaus
1		Acer Crystal Eye - webkamera	Web-kamera video-tietoliikenteeseen (vain tietyille malleille).

#	Kuvake	Osio	Kuvaus
2		Näyttöruutu	Nimeltään myös nestekidenäyttö (Liquid-Crystal Display; LCD), näyttää tietokoneen ulostulon (Konfiguraatio voi vaihdella malleista riippuen).
3		Arcade-pelihallin näppäin	Arcade-pelihallin pikakäynnistys.
	P	P-näppäin/ Acer PowerSmart-näppäin	Ohjelmoitava näppäin (konfiguraatio voi vaihdella malleista riippuen)./ Laittaa tietokoneesi virransäätötilaan (konfiguraatio voi vaihdella malleista riippuen).
4		Näppäimistö	Tiedon syöttämiseen tietokoneelle.
5		Mikrofoni	Sisäinen mikrofoni äänen tallentamista varten.
6		Kosketuslevy/ mediakonsoli	Kosketusherkkä osoitinlaite, joka toimii kuten tietokoneen hiiri*./ Acer Arcade -pelihallin, äänenvoimakkuuden (lisääminen/vähentäminen) ja median (toisto/keskeytys, pysäytys, edellinen, seuraava) sekä mykistyksen kosketushallinta.
		Elokuva	Käynnistä elokuvien toisto-ohjelma.
		Musiikki	Käynnistä musiikin toisto-ohjelma.
		Toista/ tauko	Toista tai pysäytä valittu mediatiedosto.
		Pysäytä	Pysäytä valitun mediatiedoston toistaminen.
		Edellinen	Palaa edelliseen mediatiedostoon.
		Seuraava	Hyppää seuraavaan mediatiedostoon.
		Mykistä	Laita äänet päälle tai mykistä äänet.
			* Kosketuslevy poistetaan käytöstä silloin, kun mediakonsoli on aktiivinen.

#	Kuvake	Oso	Kuvaus
7		Mediakonsolin hallinta	Käynnistää tai sulkee mediakonsolin.
8		Tietoliikenne-näppäin	Ottaa käyttöön/poistaa käytöstä tietokoneen tietoliikennelaitteet. (Tietoliikennelaitteet voivat vaihdella konfiguroinnilla.)
		Varmistus-näppäin	Käynnistää Acer Backup Management:in kolmevaiheista datan varmistusta varten.
		Kiintolevyn merkkivalo <sup>1</sup>	Palaa, kun kiintolevy on aktiivinen.
		Virranilmais <sup>1</sup>	Osoittaa tietokoneen virran tilan.
9		Napsauta painikkeita (vasen ja oikea)	Vasen ja oikea painike toimivat kuten hiiren vasen ja oikea painike.
10		Rannetuki	Mukava tuki käsillesi konetta käyttäessäsi.
11		Acer Bio-Protection - sormenjälkilukija	Tukee nelisuuntaista Acer FingerNav - hallintatoimintoa (vain tietyille malleille).
12		Kaiuttimet	Toimittaa stereoäänen ulostulon.
13		Virtapainike	Käynnistää ja sulkee koneen.











1. Etupaneelin tilailmaisimet näkyvät, vaikka tietokoneen kansi olisi suljettu.



## Pikavalintanäppäimet

Tietokoneessa on pikavalintanäppäimet tai näppäinyhdistelmät sen useimpia säätöjä, kuten näyttöruudun kirkkautta, äänenvoimakkuutta varten.

Aktivoidaksesi pikavalintanäppäimet paina ja pidä painettuna <Fn> -näppäintä ja paina sitten pikavalintanäppäinyhdistelmän toista näppäintä.

Pikanäppäin	Kuvake	Toiminto	Kuvaus
<Fn> + <F3>		Tietoliikenne-näppäin	Ottaa käyttöön/poistaa käytöstä tietokoneen tietoliikennelaitteet. (Tietoliikennelaitteet voivat vaihdella konfiguroinnilla.)
<Fn> + <F4>		Lepotila	Siirtää tietokoneen lepotilaan.
<Fn> + <F5>		Näytön vaihto	Kytkee näytön ulostulon näyttöruudun, ulkoisen monitorin (jos kytketty) ja molempien välillä.
<Fn> + <F6>		Taustavalaistus	Sammuttaa näytön taustavalon virran säästämiseksi. Paina mitä tahansa näppäintä palataksesi normaalitilaan.
<Fn> + <F7>		Kosketusalustan vaihtokytkin	Kytkee kosketusalustan käyttöön ja pois käytöstä.
<Fn> + <F8>		Kaiuttimien vaihtokytkin	Kytkee kaiuttimet käyttöön ja pois käytöstä.
<Fn> + <▷>		Kirkkauden lisäys	Lisää näytön kirkkautta.
<Fn> + <◁>		Kirkkauden vähennys	Vähentää näytön kirkkautta.
<Fn> + <Koti>		Toista/Tauko	Toista tai pysäytä valittu mediatiedosto.
<Fn> + <Sivu ylös>		Pysäytä	Pysäytä valitun mediatiedoston toistaminen.
<Fn> + <Sivu alas>		Edellinen	Palaa edelliseen mediatiedostoon.
<Fn> + <Loppu>		Seuraava	Hyppää seuraavaan mediatiedostoon.

## Etunäkymä suljettuna



#	Kuvake	Osio	Kuvaus
1		Sormipyörä	Lisää tai vähennä äänenoimakkuutta.
2		Monta yhdessä - kortinlukija	Hyväksyy seuraavat muistikortit: Secure Digital (SD), MultiMediaCard (MMC), Memory Stick (MS), Memory Stick PRO (MS PRO) ja xD-Picture Card (xD). <b>Huomautus:</b> Poista/Asenna kortti työntämällä. Vain yksi kortti voi toimia mihin aikaan hyvänsä.
3		CIR-vastaanotin	Vastaanottaa kaukosäätimen signaaleja.



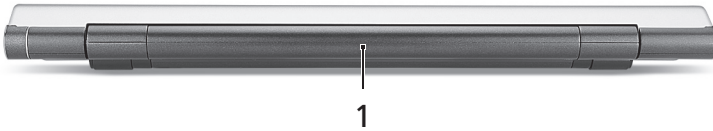



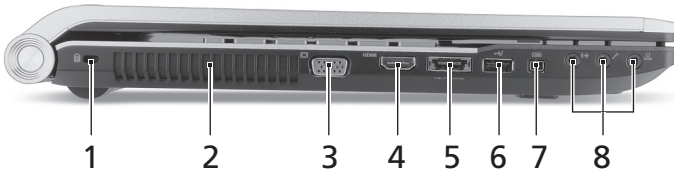

## Taustanäkymä

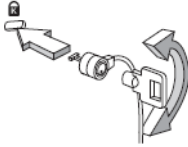

#	Kuvake	Osio	Kuvaus
1		Akkutila	Sisältää tietokoneen akkuyksikön.





## Vasen näkymä

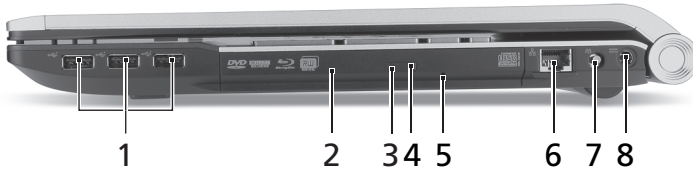

#	Kuvake	Osio	Kuvaus
1		Kensington-lukon paikka 	Yhdistää Kensington-yhteensopivaan tietokoneen turvalukkoon. <b>Huomautus:</b> Kierrä tietokoneen turvalukon kaapeli kiinteän esineen, kuten pöydän tai lukitun laatikon kahvan ympärille. Paina lukko paikalleen ja lukitse se kiertämällä avainta. Saatavana on myös joitakin avaimettomia lukkoja.
2		Tuuletuspaikat	Mahdollistaa tietokoneen pysymisen viileänä jopa pitkitetyn käytön jälkeen.
3		Ulkoinen näyttöportti (VGA)	Yhdistää näyttölaitteeseen (esim. ulkoinen monitori, LCD-projektori).
4	HDMI	HDMI-portti	Tukee korkealaatuisia digitaalisia videoliitäntöjä.
5	 /e SATA	USB 2.0/eSATA -portti	Liitäntä USB 2.0- tai eSATA-laitteisiin (vain tietyille malleille). <b>Huomautus:</b> Jos liität eSATA-laitteen, sinulla on sillä aikaa käytössäsi kolme USB-porttia.
6		USB 2.0 -portti	Yhdistää USB 2.0 -laitteisiin (esim. USB-hiiri, USB-kamera).
7		4-nastainen IEEE 1394 -portti	Yhdistää IEEE 1394 -laitteisiin.
8		Jakki-tulolinja	Hyväksyy audioliitäntälaitteita (esim. CD-soitin, korvalappustereot, mp3-soitin).
		Mikrofonin tulolinja	Hyväksyy syötteen ulkoisilta mikrofoneilta.
		Kuulokkeet/kaiutin/line-out -jakkiliitin S/PDIF-tuella	Yhdistää audioliitäntälaitteisiin (esim. kaiuttimet, kuulokkeet).







## Oikea näkymä



#	Kuvake	Osoite	Kuvaus
1		USB 2.0 -portit	Yhdistää USB 2.0 -laitteisiin (esim. USB-hiiri, USB-kamera).
2		Optinen asema	Sisäinen optinen levyasema, hyväksyy CD:t ja DVD:t.
3		Optisen levyn tilan osoitin	Syttyy, kun optinen asema on aktiivinen.
4		Optisen aseman ulostyöntöpainike	Työntää optisen levykkeen ulos asemasta.
5		Hätäulostyöntöaukko	Työntää ulos optisen aseman kelkan, kun tietokone on sammutettu. <b>Huomautus:</b> Pane paperiliitin hätäpoistoreikään optisen aseman tarjottimen poistamiseksi asemasta, kun tietokone on pois päältä.
6		Ethernet (RJ-45)-portti	Yhdistää Ethernet 10/100/1000 -pohjaiseen verkkoon.
7		RF-in-portti	Hyväksyy tulosignaalit digitaali-TV-viritinlaitteista (vain tietyille malleille).
8		DC-tulolinja	Yhdistää AC-sovittimeen.

## Pohjanäkymä



#	Kuvake	Osio	Kuvaus
1		Akkutila	Sisältää tietokoneen akkuyksikön.
2		Alibassokaiutin	Lähetää matalataajuisia ääntä.
3		Akun vapautussalpa	Vapauttaa akun poistamista varten.
4		Muistilokero	Sisältää tietokoneen päämuisti.
5		Kovalevytila- Pääasiallinen	Sisältää koneen kovalevyn (varmistettu ruuveilla).
6		Kaiuttimet	Toimittaa stereoäänen ulostulon.
7		Kovalevytila- Toissijainen	Sisältää koneen kovalevyn (varmistettu ruuveilla) (vain tietyille malleille).
8		Akun lukko	Lukitsee akun paikoilleen.

## Ympäristö

- Lämpötila:
  - Käyttö: 5°C - 35°C
  - Ei käytössä: -20°C - 65°C
- Kosteus (ei kondensoitunut):
  - Käyttö: 20% - 80%
  - Ei käytössä: 20% - 80%



# Ноутбук Асер

Краткое руководство

© 2010 Все права сохранены.

Краткое руководство пользователя ноутбука Acer  
Первый выпуск: 03/2010

Номер модели: \_\_\_\_\_

Серийный номер: \_\_\_\_\_

Дата покупки: \_\_\_\_\_

Место покупки: \_\_\_\_\_



# Вначале о главном

Благодарим вас за то, что для решения своих мобильных вычислительных задач вы выбрали ноутбук Acer.

## Ваши руководства

Мы разработали ряд руководств, которые помогут вам в использовании ноутбука Acer:

Прежде всего, плакат **Для начинающих...** поможет Вам познакомиться с тем, как настраивать компьютер.

**Типовое руководство пользователя для серии Aspire** содержит полезную информацию, применимую ко всем моделям серии Aspire. В нем описываются основные темы, такие как работа с клавиатурой, звуком и т.д. Пожалуйста, имейте в виду, что **Типовое руководство пользователя** и упомянутое ниже **AcerSystem User Guide** являются обобщенными, поэтому в них иногда будут описываться функции или свойства, реализованные не в купленной вами модели, а лишь в определенных моделях этой серии. В таких случаях в тексте имеется пометка "только для определенных моделей".

**Краткое руководство** в виде знакомит вас с основными характеристиками и функциями вашего нового компьютера. Чтобы узнать больше о том, как повысить продуктивность вашей работы с помощью компьютера, вы можете обратиться к **AcerSystem User Guide**. Это руководство содержит подробную информацию о системных функциях, восстановлении данных, возможностях расширения и устранении неисправностей. Кроме того, оно содержит гарантийную информацию, а также общие предписания и правила безопасности при работе с вашим ноутбуком. Руководство поставляется вместе с компьютером, предварительно загруженное в него в формате PDF. Чтобы обратиться к нему, вам надо сделать следующее:

- 1 Щелкните кнопку  **Пуск > Все программы > AcerSystem**.
- 2 Щелкните **AcerSystem User Guide**.



.....

**Примечание:** Для просмотр файла необходимо установить программу Adobe Acrobat Reader. Если программа Adobe Acrobat Reader не установлена на Вашем компьютере, щелчок мышью по **AcerSystem User Guide** запустит сперва установку програмы Acrobat Reader. Следуйте инструкциям на экране, чтобы завершить процесс установки. За инструкциями о том, как пользоваться программой Adobe Acrobat Reader, обратитесь к меню **Справка и поддержка**.







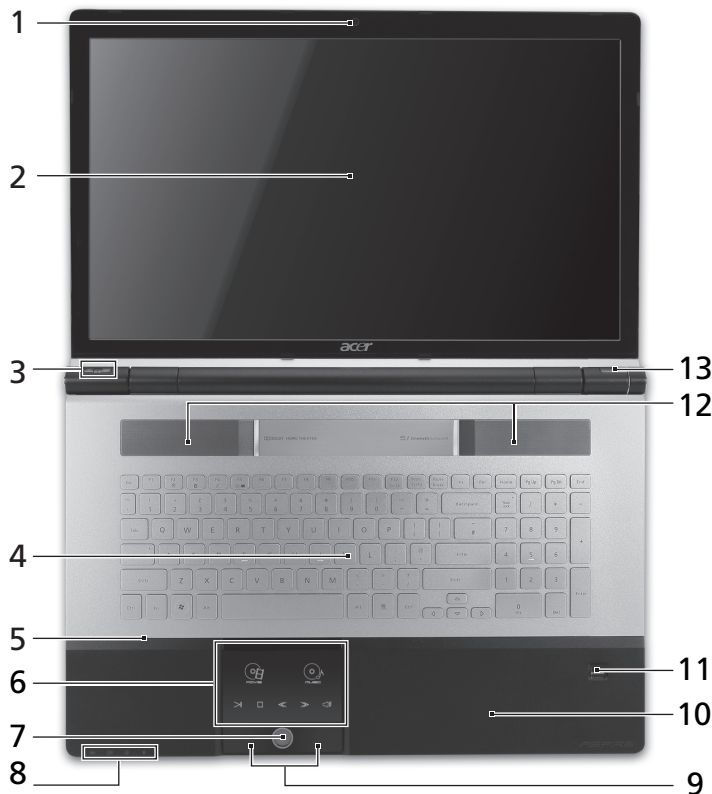

# Знакомство с ноутбуком Acer

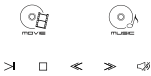



Теперь, когда вы выполнили настройки, как показано на плакате **Для пользователей-новичков...**, давайте поближе познакомимся с вашим новым ноутбуком Acer.

## Вид сверху



#	Значок	Элемент	Описание
1		Веб-камера Acer Crystal Eye	Веб-камера для видеосвязи (только для определенных моделей).
2		Экран дисплея	Другое название - жидкокристаллический дисплей (ЖК-дисплей); служит для вывода изображения, формируемого компьютером (конфигурация может отличаться в зависимости от модели).

#	Значок	Элемент	Описание
3		Клавиша Arcade	Запуск InstantOn Arcade.
	P	Клавиша P/ Клавиша Acer PowerSmart	Программируемая клавиша (конфигурация может отличаться в зависимости от модели)./ Перевод компьютера в режим энергосбережения (конфигурация может отличаться в зависимости от модели).
4		Клавиатура	Служит для ввода данных в компьютер.
5		Микрофон	Внутренний микрофон для записи звука.
6		Сенсорная панель/ Медиа-консоль	Чувствительное к прикосновениям указательное устройство, позволяющее управлять курсором на экране так же, как и мышью*./ Сенсорные органы управления в Acer Arcade для увеличения/уменьшения громкости, управления воспроизведением мультимедийных файлов (воспроизведение/пауза, останов, пред./след.) и отключения звука.
		Фильм	Запуск программы воспроизведения фильмов.
		Музыка	Запуск программы воспроизведения музыки.
		Воспроизвести/ Приостановить	Воспроизведение или приостановка воспроизведения выбранного медиафайла.
		Остановить	Останов воспроизведения выбранного медиафайла.
		Пред.	Возврат к предыдущему медиафайлу.
		След.	Переход к следующему медиафайлу.
		Отключить звук	Включение и выключение звука.
* Сенсорная панель отключается, когда активна Медиа-консоль.			

#	Значок	Элемент	Описание
7		Контроллер Медиа-консоли	Включение или выключение Медиа-консоли.
8		Клавиша "Связь"	Включение/выключение модулей связи в компьютере. (Тип модуля связи зависит от конфигурации системы.)
		Клавиша резервного копирования	Запуск программы Acer Backup Management для создания резервной копии данных за три шага.
		Индикатор работы жесткого диска <sup>1</sup>	Горит при обращении к жесткому диску.
		Индикатор питания <sup>1</sup>	Отображает состояние питания компьютера.
9		Кнопки управления (левая и правая)	Эти левая и правая кнопки действуют так же, как левая и правая кнопки мыши.
10		Подставка для запястий	Упорная площадка, на которую удобно положить руки при работе на компьютере.
11		Дактилоскопический считыватель Acer Bio-Protection	Поддержка функции Acer FingerNav для управления перемещением в 4 направлениях (только для определенных моделей).
12		Динамики	Используются для вывода стереозвuka.
13		Кнопка питания	Служит для включения/выключения компьютера.

1. Индикаторы на передней панели видны даже при закрытой крышке компьютера.

## "Горячие" клавиши

В компьютере используются "горячие" клавиши (комбинации клавиш) для быстрого вызова большинства функций управления компьютером, таких как яркость экрана и громкость.

Для использования клавишной комбинации сначала нажмите клавишу <Fn> и затем, не отпуская ее, нажмите вторую клавишу этой комбинации.

"Горячая" клавиша	Значок	Функция	Описание
<Fn> + <F3>		Клавиша "Связь"	Включение/выключение модуля связи в компьютере. (Тип модуля связи зависит от конфигурации системы.)
<Fn> + <F4>		Режим сна	Переводит компьютер в режим Сон.
<Fn> + <F5>		Переключение видеовыхода	Переключает вывод изображения либо на дисплей, либо на внешний монитор (если он подключен), либо одновременно и на дисплей, и на внешний монитор.
<Fn> + <F6>		Гашение экрана	Выключает экран дисплея для экономии заряда аккумулятора. Для включения экрана нажмите любую клавишу.
<Fn> + <F7>		Переключение сенсорной панели	Включает и выключает встроенную сенсорную панель.
<Fn> + <F8>		Выключатель динамиков	Попеременно включает и выключает динамики.
<Fn> + <↑>		Повышение яркости	Увеличение яркости экрана.
<Fn> + <↓>		Понижение яркости	Уменьшает яркость экрана.
<Fn> + <Home>		Воспроизвести/Приостановить	Воспроизведение или приостановка воспроизведения выбранного медиафайла.
<Fn> + <Pg Up>		Остановить	Останов воспроизведения выбранного медиафайла.
<Fn> + <Pg Dn>		Пред.	Возврат к предыдущему медиафайлу.
<Fn> + <End>		След.	Переход к следующему медиафайлу.

## Вид спереди с закрытой крышкой



#	Значок	Элемент	Описание
1		Колесико	Увеличение или уменьшение громкости.
2		Комбинированное устройство считывания карт памяти различных форматов	Поддерживает форматы Secure Digital (SD), MultiMediaCard (MMC), Memory Stick (MS), Memory Stick PRO (MS PRO) и xD-Picture Card (xD). <b>Примечание:</b> Надавите, чтобы извлечь/вставить карту. Одновременно можно использовать только одну карту памяти.
3		CiR-приемник	Принимает сигналы от пульта дистанционного управления.

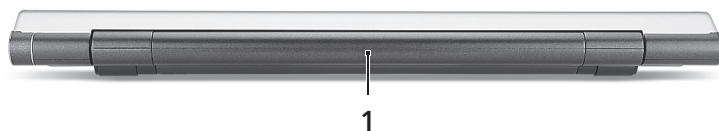

## Вид сзади



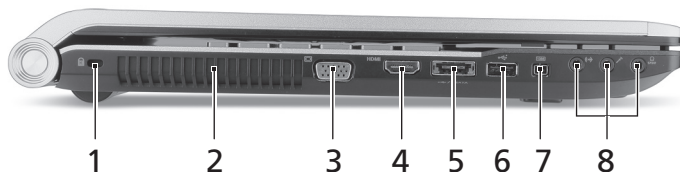

#	Значок	Элемент	Описание
1		Отсек аккумулятора	В этот отсек устанавливается аккумулятор компьютера.

## Вид слева



#	Значок	Элемент	Описание
1		Замок типа Kensington 	Служит для подсоединения защитного тросика с замком типа Kensington для предотвращения кражи компьютера. <b>Примечание:</b> Этим защитным тросиком обвяжите какой-нибудь неподвижный предмет, например, стол или ручку запертого ящика. Вставьте замок тросика в гнездо и поверните ключ, чтобы запереть замок. Бывают модели замков и без ключей.
2		Вентиляционные отверстия	Позволяют компьютеру не перегреваться даже при длительной работе.
3		Разъем внешнего дисплея (VGA)	Служит для подключения устройства отображения (например, внешнего монитора, ЖК-проектора).
4	HDMI	Разъем HDMI	Служит для подключения к источникам цифрового видео высокой четкости.
5		Порт USB 2.0/ eSATA	Служит для подключения устройств с интерфейсом USB 2.0 или eSATA (только для определенных моделей). <b>Примечание:</b> При подключении устройства eSATA вы одновременно получаете три свободных разъема USB.
6		Разъем USB 2.0	Служит для подключения устройств с интерфейсом USB 2.0 (например, мыши или камеры).
7		4-контактный порт IEEE 1394	Служит для подключения устройств с интерфейсом IEEE 1394.

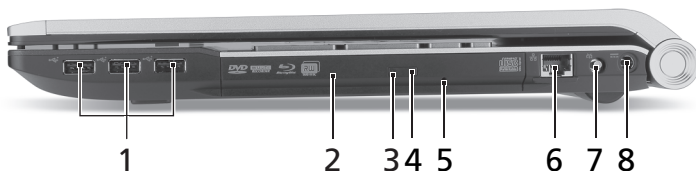

#	Значок	Элемент	Описание
8		Гнездо линейного входа	Служит для подключения звуковых устройств к линейному входу (например, плеера звуковых компакт-дисков, аудиоплееров и проигрывателей файлов mp3).
		Гнездо микрофонного входа	Служит для подключения внешнего микрофона.
		Гнездо наушников/динамика/линейный выход с поддержкой цифрового интерфейса S/PDIF	Служит для подключения звуковых устройств к линейному выходу (например, динамиков, наушников).

## Вид справа





#	Значок	Элемент	Описание
1		Порты USB 2.0	Служит для подключения устройств с интерфейсом USB 2.0 (например, мыши или камеры).
2		Привод оптических дисков	Внутренний привод оптических дисков рассчитан на использование компакт-дисков или DVD-дисков.
3		Индикатор обращения к оптическому диску	Горит во время работы привода оптических дисков.
4		Кнопка извлечения диска из привода	Служит для извлечения оптического диска из привода.
5		Отверстие аварийного извлечения	Служит для открытия лотка привода оптических дисков, когда питание компьютера отключено. <b>Примечание:</b> Чтобы открыть лоток привода оптических дисков, когда компьютер выключен, вставьте скрепку в это отверстие аварийного извлечения.



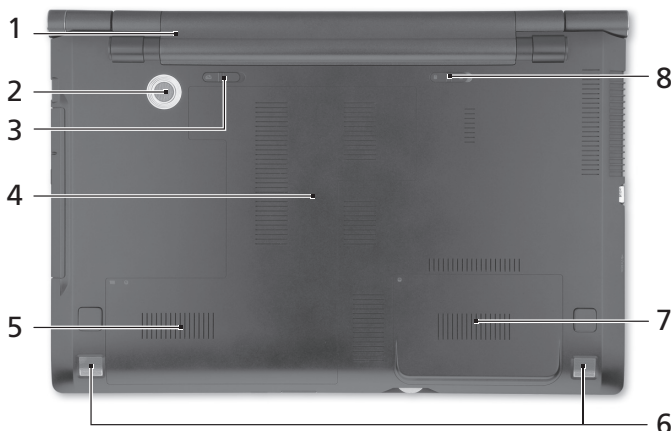

#	Значок	Элемент	Описание
6		Разъем Ethernet (RJ-45)	Служит для подключения к сети Ethernet 10/100/1000 Мбит/с.
7		Разъем для подключения входного ВЧ-сигнала	Служит для подключения входных сигналов от цифровых ТВ-тюнеров (только для определенных моделей).
8		Разъем для подключения питания постоянного тока	Служит для подключения адаптера переменного тока.

## Вид снизу



#	Значок	Элемент	Описание
1		Отсек аккумулятора	В этот отсек устанавливается аккумулятор компьютера.
2		Низкочастотный динамик	Излучает звуковые сигналы низкой частоты.
3		Защелка извлечения аккумулятора	Разблокирует аккумулятор для его извлечения.
4		Отсек модулей оперативной памяти	В этот отсек устанавливаются модули оперативной памяти компьютера.
5		Отсек жесткого диска-Основной	Здесь размещается жесткий диск компьютера (крепится винтами).
6		Динамики	Используются для вывода стереозвука.

#	Значок	Элемент	Описание
7		Отсек жесткого диска-Второй	Служит для установки жесткого диска компьютера (крепление винтами) (только для определенных моделей).
8		Защелка аккумулятора	Служит для фиксации аккумулятора в отсеке.

## Условия эксплуатации

- Температура:
  - Рабочая: От 5°C до 35°C
  - Нерабочая: От -20°C до 65°C
- Влажность (без конденсации):
  - Рабочая: От 20% до 80%
  - Нерабочая: От 20% до 80%

# Notebook Acer

Skrócony poradnik

© 2010 Wszelkie prawa zastrzeżone.

Skrócony poradnik notebooka Acer

Wydanie oryginalne: 03/2010

Oznaczenie modelu: \_\_\_\_\_

Numer seryjny: \_\_\_\_\_

Data zakupu: \_\_\_\_\_

Miejsce zakupu: \_\_\_\_\_

# Na początek

Dziękujemy za wybranie notebooka PC serii Acer dla celów realizacji potrzeb w zakresie mobilnego przetwarzania.

## Instrukcje

Aby pomóc w korzystaniu z komputera Acer, opracowaliśmy zestaw instrukcji:

Jako pierwszy można wymienić poster **Dla początkujących...**, który pomoże użytkownikom rozpocząć ustawianie komputera.

**Ogólno podręcznika użytkownika urządzenia serii Aspire** zawiera przydatne informacje dotyczące wszystkich modeli serii Aspire. Obejmuje podstawowe zagadnienia, takie jak używanie klawiatury, dźwięki itd. Należy pamiętać, że **Ogólny podręcznik użytkownika** oraz **AcerSystem User Guide**, o którym mowa poniżej, odnoszą się czasami do funkcji lub elementów tylko niektórych modeli serii, które nie muszą występować w zakupionym modelu. W takich przypadkach użyto oznaczenia „tylko w niektórych modelach”.

**Skrócony poradnik** przedstawia podstawowe właściwości i funkcje nowego komputera. Aby uzyskać więcej informacji o tym, w jaki sposób nowy komputer może pomóc Ci być bardziej produktywnym, zapoznaj się z **AcerSystem User Guide**. Przewodnik ten zawiera szczegółowe informacje dotyczące takich tematów, jak narzędzia systemowe, odzyskiwanie danych, opcje rozszerzeń oraz rozwiązywanie problemów. Oprócz nich, zawiera także informacje na temat gwarancji oraz informacje dotyczące bezpieczeństwa pracy z komputerem przenośnym. Jest on dostępny w formie elektronicznej jako dokument w formacie Portable Document Format (PDF) i jest dostarczany jako zapisany w Twoim notebooku. Wykonaj poniższe czynności, aby uzyskać do niego dostęp:

- 1 Kliknij  **Start > Wszystkie programy > AcerSystem**.
- 2 Kliknij **AcerSystem User Guide**.



.....



**Uwaga:** Aby można było przeglądać ten plik, konieczne jest zainstalowanie programu Adobe Reader. Jeżeli w komputerze nie zainstalowano programu Adobe Reader, kliknięcie **AcerSystem User Guide** spowoduje uruchomienie instalatora programu Adobe Reader. W celu dokończenia instalacji należy wykonać instrukcje wyświetlane na ekranie. Instrukcje dotyczące używania programu Adobe Reader, znajdują się w menu **Pomocy i obsługi technicznej**.





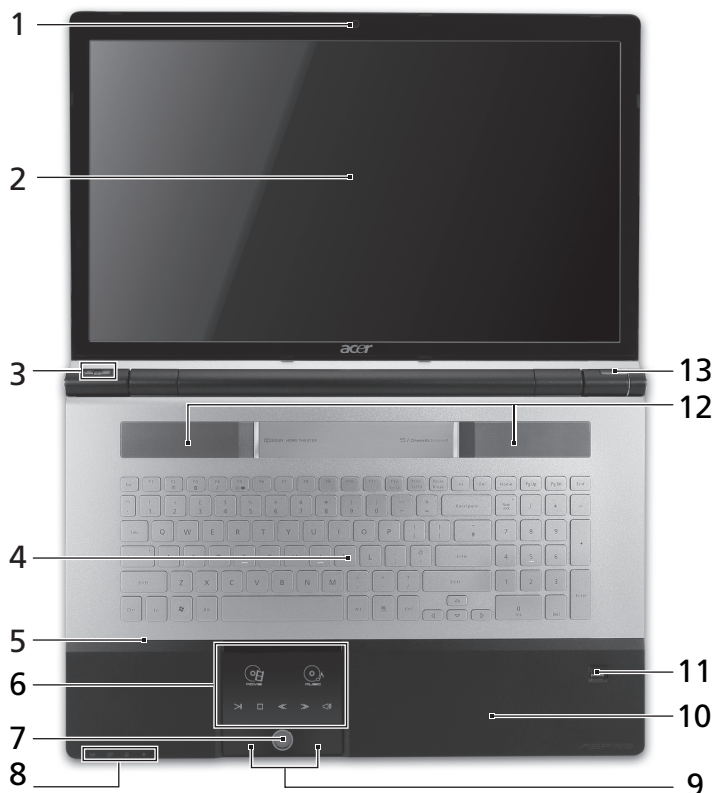



















# Zapoznanie z notebookiem Acer



Po ustawieniu komputera jak to przedstawiono na ilustracji w posterce **Dla początkujących...**, przyjrzyjmy się nowemu komputerowi Acer.

## Widok z góry



#	Ikona	Element	Opis
1		Kamera Acer Crystal Eye	Kamera internetowa do komunikacji wideo (tylko w niektórych modelach).
2		Ekran wyświetlacza	Nazywany jest także wyświetlaczem ciekłokrystalicznym (Liquid-Crystal Display; LCD), wyświetla informacje wyjściowe komputera (Konfiguracja może być różna w zależności od modelu).

#	Ikona	Element	Opis																					
3		Przycisk Arcade	Uruchamia aplikację InstantOn Arcade																					
	P	Klawisz P/Klawisz Acer PowerSmart	Klawisz programowalny (konfiguracja może być różna w zależności od modelu)./ Przełącza komputer na tryb oszczędności energii (konfiguracja może być różna w zależności od modelu).																					
4		Klawiatura	Umożliwia wprowadzanie danych do komputera.																					
5		Mikrofon	Wewnętrzny mikrofon do rejestrowania dźwięku.																					
6	  	Touchpad/ konsola multimedialna	<p>Dotykowe urządzenie wskazujące, które działa jak myszka komputerowa*/ Sterowanie dotykowe dla Acer Arcade, głośność (wyższa/niższa) oraz multimedia (odtwarzanie/pauza, zatrzymanie, poprzedni, następny); z przyciskiem wyciszenia.</p> <table border="1"> <tbody> <tr> <td></td> <td>Film</td> <td>Uruchamia oprogramowanie do odtwarzania filmów.</td> </tr> <tr> <td></td> <td>Muzyka</td> <td>Uruchamia oprogramowanie do odtwarzania muzyki.</td> </tr> <tr> <td></td> <td>Odtwórz/ wstrzymaj</td> <td>Odtwarzanie lub wstrzymanie wybranego pliku multimedialnego.</td> </tr> <tr> <td></td> <td>Zatrzymaj</td> <td>Zatrzymanie odtwarzania wybranego pliku multimedialnego.</td> </tr> <tr> <td></td> <td>Wstecz</td> <td>Powrót do wcześniejszego pliku multimedialnego.</td> </tr> <tr> <td></td> <td>Dalej</td> <td>Przeskoczenie do następnego pliku multimedialnego.</td> </tr> <tr> <td></td> <td>Wyciszenie</td> <td>Włączanie lub wyłączanie dźwięku.</td> </tr> </tbody> </table> <p>* Gdy aktywna jest konsola multimedialna wyłączany jest touchpad.</p>		Film	Uruchamia oprogramowanie do odtwarzania filmów.		Muzyka	Uruchamia oprogramowanie do odtwarzania muzyki.		Odtwórz/ wstrzymaj	Odtwarzanie lub wstrzymanie wybranego pliku multimedialnego.		Zatrzymaj	Zatrzymanie odtwarzania wybranego pliku multimedialnego.		Wstecz	Powrót do wcześniejszego pliku multimedialnego.		Dalej	Przeskoczenie do następnego pliku multimedialnego.		Wyciszenie	Włączanie lub wyłączanie dźwięku.
	Film	Uruchamia oprogramowanie do odtwarzania filmów.																						
	Muzyka	Uruchamia oprogramowanie do odtwarzania muzyki.																						
	Odtwórz/ wstrzymaj	Odtwarzanie lub wstrzymanie wybranego pliku multimedialnego.																						
	Zatrzymaj	Zatrzymanie odtwarzania wybranego pliku multimedialnego.																						
	Wstecz	Powrót do wcześniejszego pliku multimedialnego.																						
	Dalej	Przeskoczenie do następnego pliku multimedialnego.																						
	Wyciszenie	Włączanie lub wyłączanie dźwięku.																						

#	Ikona	Element	Opis
7		Przycisk włączania konsoli multimedialnej	Włączanie lub wyłączenie konsoli multimedialnej.
8		Klawisz komunikacji	Włącza/wyłącza urządzenia komunikacyjne komputera. (urządzenia komunikacyjne mogą być różne w zależności od konfiguracji.)
		Klawisz kopii zapasowej	Uruchamia program Acer Backup Management pozwalający na wykonywanie kopii zapasowych w trzech krokach.
		Wskaźnik dysku twardego <sup>1</sup>	Świeci, gdy działa dysk twardy.
		Wskaźnik zasilania <sup>1</sup>	Wskazuje stan zasilania komputera.
9		Przyciski kliknięć (lewy i prawy)	Działanie lewego i prawego przycisku jest podobne do działania lewego i prawego przycisku myszki.
10		Podparcie nadgarstków	Wygodne podparcie dłoni podczas używania komputera.
11		Czytnik odcisków palców Acer Bio-Protection	Obsługuje funkcję 4-kierunkowego przycisku sterowania Acer FingerNav (tylko w niektórych modelach).
12		Głośniki	Zapewniają możliwość odtwarzania dźwięku.
13		Przycisk zasilania	Służy do włączania i wyłączenia komputera.

1. Wskaźniki panelu czołowego są widoczne nawet po zamknięciu pokrywy komputera.



## Klawisze skrótów

Komputer umożliwia używanie klawiszy skrótów lub kombinacji klawiszy w celu uzyskania dostępu do większości kontrolowanych parametrów, takich jak jasność ekranu czy ustawienia głośności.

Aby uaktywnić klawisze skrótów, naciśnij i przytrzymaj klawisz <Fn> przed naciśnięciem innego klawisza w kombinacji klawisza skrótu.

Klawisz skrótu	Ikona	Funkcja	Opis
<Fn> + <F3>		Klawisz komunikacji	Włącza/wyłącza urządzenia komunikacyjne komputera. (urządzenia komunikacyjne mogą być różne w zależności od konfiguracji.)
<Fn> + <F4>		Wstrzymanie	Powoduje przejście komputera do trybu Wstrzymanie.
<Fn> + <F5>		Przełączenie wyświetlania	Umożliwia przełączanie sygnału wyjściowego wyświetlacza na ekran wyświetlacza lub na zewnętrzny monitor (jeśli jest przyłączony) lub na oba.
<Fn> + <F6>		Pusty ekran	Wyłącza podświetlenie ekranu wyświetlacza w celu oszczędzania energii. Naciśnij dowolny klawisz w celu przywrócenia wyświetlania.
<Fn> + <F7>		Przełączenie touchpada	Umożliwia włączanie i wyłączenie wewnętrznego touchpada.
<Fn> + <F8>		Przełączenie głośnika	Umożliwia włączanie i wyłączenie głośników.
<Fn> + <◀▶>		Zwiększenie jasności	Zwiększa jasność ekranu.
<Fn> + <◀◀>		Zmniejszenie jasności	Zmniejsza jasność ekranu.
<Fn> + <Home>		Odtwórz/ Wstrzymaj	Odtwarzanie lub wstrzymanie wybranego pliku multimedialnego.
<Fn> + <Pg Up>		Zatrzymaj	Zatrzymanie odtwarzania wybranego pliku multimedialnego.
<Fn> + <Pg Dn>		Wstecz	Powrót do wcześniejszego pliku multimedialnego.
<Fn> + <End>		Dalej	Przeskoczenie do następnego pliku multimedialnego.

## Widok z przodu (pokrywa zamknięta)



#	Ikona	Element	Opis
1		Pokrętko	Zgłaśnianie lub ściszenie dźwięku.
2		Wielofunkcyjny czytnik kart pamięci	Obsługuje następujące typy kart: Secure Digital (SD), MultiMediaCard (MMC), Memory Stick (MS), Memory Stick PRO (MS PRO) oraz xD-Picture Card (xD). <b>Uwaga:</b> Aby wyjąć/zainstalować kartę, wciśnij ją delikatnie. Jednocześnie można obsługiwać tylko jedną kartę.
3		Odbiornik CIR	Odbiera sygnały z pilota zdalnego sterowania.



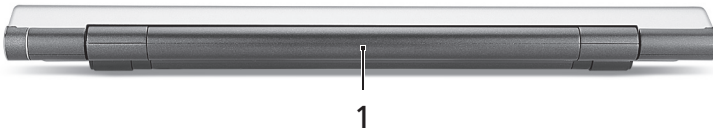



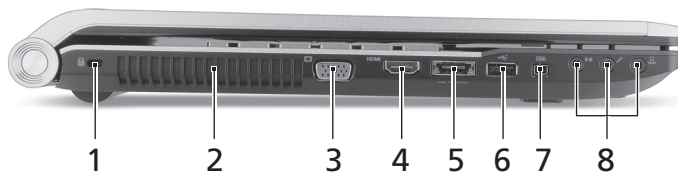

## Widok z tyłu



#	Ikona	Element	Opis
1		Wnęka na baterię	Przechowuje baterię komputera.





## Widok z lewej

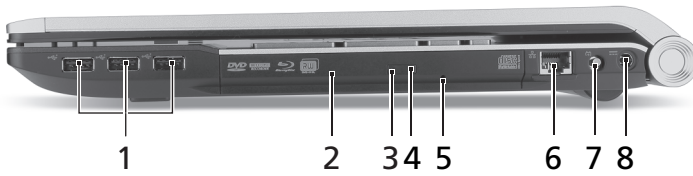

#	Ikona	Element	Opis
1		Gniazdo blokady Kensington	Służy do podłączania blokady zgodnej ze standardem firmy Kensington. <b>Uwaga:</b> Kabel zabezpieczenia komputera należy owinąć wokół ciężkiego nieruchomego obiektu, takiego jak stół lub uchwyt zabloкованej szuflady. Wstaw zamek blokady do gniazda i przekręć klucz w celu zamknięcia blokady. Dostępne są także modele bez kluczy.
2		Szczeliny wentylacyjne	Umożliwiają chłodzenie komputera nawet podczas długotrwałego użytkowania.
3		Port zewnętrznego wyświetlacza (VGA)	Służy do przyłączenia urządzenia wyświetlającego (np. zewnętrzny monitor, projektor LCD).
4	HDMI	Port HDMI	Obsługuje połączenia cyfrowego wideo o wysokiej rozdzielczości.
5	 /e SATA	Port USB 2.0/eSATA	Służy do przyłączenia urządzeń USB 2.0 lub eSATA (tylko w niektórych modelach). <b>Uwaga:</b> W czasie podłączenia urządzenia eSATA będą dostępne trzy porty USB.
6		Port USB 2.0	Służą do przyłączenia urządzeń USB 2.0 (np. mysz USB, aparat cyfrowy USB).
7		4-stykowy port IEEE 1394	Służy do przyłączenia urządzeń pracujących w standardzie transmisji IEEE 1394.
8		Gniazdo wejścia liniowego	Służy do przyłączenia urządzeń liniowego wejścia audio (np. odtwarzacz audio CD, walkman stereo, odtwarzacz mp3).
		Gniazdo mikrofonowe	Służy do przyłączenia sygnału z zewnętrznych mikrofonów.
		Gniazdo słuchawkowe/głośnikowe/wyjścia liniowego z obsługą S/PDIF	Służy do przyłączenia urządzeń liniowego wyjścia audio (np. głośniki, słuchawki).







## Widok z prawej

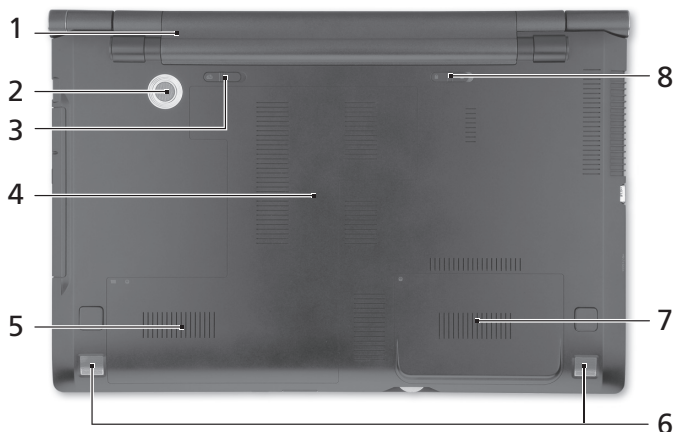

#	Ikona	Element	Opis
1		Porty USB 2.0	Służą do przyłączania urządzeń USB 2.0 (np. mysz USB, aparat cyfrowy USB).
2		Napęd optyczny	Wewnętrzny napęd optyczny; obsługuje dyski CD lub DVD.
3		Wskaźnik dostępu do dysku optycznego	Świeci, kiedy napęd optyczny jest aktywny.
4		Przycisk wysuwania napędu optycznego	Wyrzuca dysk optyczny z napędu.
5		Otwór wysuwania awaryjnego	Umożliwia wysunięcie tacy napędu optycznego, kiedy komputer jest wyłączony. <b>Uwaga:</b> Wsuń spinacz do otworu wysuwania awaryjnego w celu wysunięcia tacy napędu optycznego, kiedy komputer jest wyłączony.
6		Port Ethernet (RJ-45)	Służy do przyłączania do sieci komputerowej typu Ethernet 10/100/1000.
7		Port wejścia RF	Obsługuje sygnał z cyfrowych tunerów TV (tylko w niektórych modelach).
8		Gniazdo zasilania	Gniazdo zasilacza.

## Widok od strony podstawy



#	Ikona	Element	Opis
1		Wnęka na baterię	Przechowuje baterię komputera.
2		Głośnik niskotonowy (subwoofer)	Emituje wyjściowy sygnał dźwiękowy o niskiej częstotliwości.
3		Blokada baterii	Umożliwia zwolnienie i wyjęcie baterii.
4		Przegroda na pamięć	Mieści główną pamięć komputera.
5		Kieszzeń na dysk twardy – główny	Mieści dysk twardy komputera (zabezpieczona śrubami).
6		Głośniki	Zapewniają możliwość odtwarzania dźwięku.
7		Kieszzeń na dysk twardy – podrzędny	Mieści dysk twardy komputera (zabezpieczona śrubami) (tylko dla wybranych modeli).
8		Zatrask baterii	Pozwala zabezpieczyć baterię w prawidłowej pozycji.

## Warunki środowiska

---

- Temperatura:
    - Podczas pracy: Od 5°C do 35°C
    - Podczas przechowywania: Od -20°C do 65°C
  - Wilgotność (bez kondensacji pary):
    - Podczas pracy: Od 20% do 80%
    - Podczas przechowywania: Od 20% do 80%
-

# Acer notebook

Rövid útmutató

© 2010 Minden jog fenntartva.

Acer notebook – Rövid útmutató  
Eredeti kiadás: 03/2010

Modellszám: \_\_\_\_\_

Sorozatszám: \_\_\_\_\_

Vásárlás időpontja: \_\_\_\_\_

Vásárlás helye: \_\_\_\_\_



# Az első lépések

Köszönjük, hogy mobil számítástechnikai feladatai elvégzéséhez egy Acer sorozatú hordozható számítógépet választott!

## Útmutatók

Minden segítséget szeretnénk megadni Önnek új Acer gépének használatához, ezért a következő útmutatókat dolgoztuk ki:

Az első a **Kezdők számára...** poszter, amely segítségére lesz a számítógép üzembe helyezésénél.

A **Aspire** sorozat elérhető **Általános felhasználói útmutató** a Aspire terméksorozat összes tagjára vonatkozó hasznos tudnivalókat tartalmaz. Olyan általános témaköröket tárgyal, mint a billentyűzet használata, a hangok stb. Felhívjuk a figyelmét arra, hogy jellegénél fogva az **Általános felhasználói útmutató** és az alábbiakban említett **AcerSystem User Guide** egyes esetekben olyan funkciókra vagy szolgáltatásokra is hivatkozhat, amelyeket csak bizonyos típusok támogatnak, de az Ön által megvásárolt típus esetében nem feltétlenül érhetők el. Az ilyen eseteket a szövegben a „csak bizonyos típusok esetében” vagy hasonló megjegyzés jelöli.

A **Rövid útmutató** ismerteti új számítógépének alapvető jellemzőit és funkciót. A számítógép még hatékonyabb használatával kapcsolatban az **AcerSystem User Guide**. Ez a kézikönyv részletes információkat tartalmaz például az előre telepített segédprogramokról, az adat-helyreállításról, a bővítési lehetőségekről és a hibaelhárításról. Emellett ismerteti a garanciával kapcsolatos tudnivalókat, valamint a számítógépre vonatkozó általános szabályokat és biztonsági előírásokat. A kézikönyv Portable Document Format (PDF) formátumú, és gyárilag telepítve van a számítógépre. Megnyitásához kövesse az alábbi lépéseket:

- 1 Kattintson a következő elemekre:  **Start > Minden program > AcerSystem.**
- 2 Kattintson a következő elemre: **AcerSystem User Guide.**



-----

**Megjegyzés:** A fájl megtekintéséhez szükség van az Adobe Reader alkalmazásra. Ha az Adobe Reader nincs telepítve a számítógépre, akkor az **AcerSystem User Guide** elemre kattintva először az Adobe Reader telepítőprogramja jelenik meg. A telepítés elvégzéséhez kövesse a képernyőn megjelenő utasításokat. Az Adobe Reader használatával kapcsolatban a **Súgó és támogatás** menüben talál útmutatást.







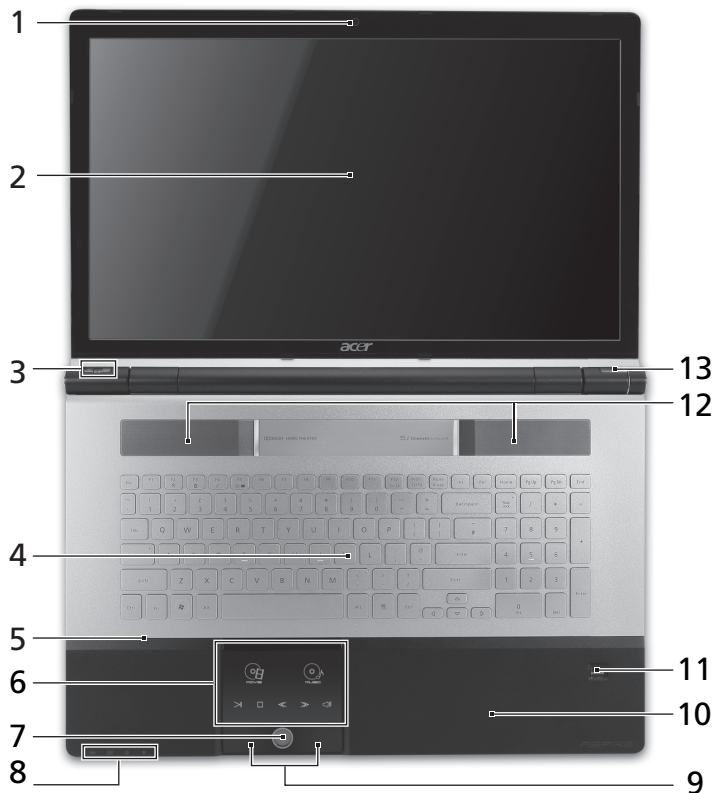

# Ismerkedjen meg új Acer gépével!





Miután a **Kezdők számára...** poszter alapján üzembe helyezte a számítógépet, ismerkedjen meg új Acer gépével!

## Felülnézet



#	Ikon	Elem	Leírás
1		Acer Crystal Eye webkamera	Webkamera videokommunikációs célokra (csak bizonyos típusok esetében).

#	Ikon	Elem	Leírás
2		Kijelző	Más néven folyadékkristályos kijelző (Liquid-Crystal Display, LCD), a számítógép kimenetét jeleníti meg. (A konfiguráció típustól függően változhat.)
3		Arcade billentyű	Az InstantOn Arcade elindítására használható.
	P	P billentyű/ Acer PowerSmart gomb	Programozható billentyű (a konfiguráció típustól függően változhat)./ Segítségével energiatakarékos módba állítható a számítógép (a konfiguráció típustól függően eltérő lehet).
4		Billentyűzet	Az adatbevitel eszköze.
5		Mikrofon	Belső mikrofon hangfelvételek készítéséhez.
6		Érintőpad/ Médiakonzol	Érintésérzékeny mutatóeszköz, a számítógépek egeréhez hasonlóan működik*/. Acer Arcade érintésérzékeny vezérlő, hangerő (fel/le), média (lejátszás/szünet, leállítás, előző, következő) és elnémítás gombbal.
		Film	A filMLEJÁTSZÓ szoftver indítása.
		Zene	A zeneLEJÁTSZÓ szoftver indítása.
		Lejátszás/ szünet	A kijelölt médiafájl lejátszása vagy lejátszásának szüneteltetése.
		Leállítás	A kijelölt médiafájl lejátszásának leállítása.
		Előző	Visszalépés az előző médiafájlra.
		Tovább	Ugrás a következő médiafájlra.
		Elnémítás	A hang be- vagy kikapcsolása.
			* Az érintőpad a Médiakonzol aktiválásakor kikapcsol.













#	Ikon	Elem	Leírás
7		Médiakonzol-vezérlő	A Médiakonzol be- és kikapcsolására használható.
8		Kommunikációs billentyű	A számítógép kommunikációs moduljainak be- és kikapcsolására használható. (A kommunikációs modulok konfigurációtól függően eltérők lehetnek.)
		Mentés gomb	Segítségével az Acer Backup Management indítható el, amellyel mindössze három lépéssel mentés készíthető az adatokról.
		Merevlemez jelzőfénye <sup>1</sup>	Jelzi, ha a merevlemez használatban van.
		Üzemállapot jelzőfénye <sup>1</sup>	A számítógép üzemállapotát jelzi.
9		Kattintógombok (bal és jobb)	A bal és a jobb gomb az egér bal és jobb gombjához hasonlóan működik.
10		Csuklótámasz	Kényelmes támaszkodási felület a számítógép használatának idejére.
11		Acer Bio-Protection ujjlenyomat-olvasó	Támogatja az Acer FingerNav négyirányú vezérlést (csak bizonyos típusok esetében).
12		Hangszórók	A sztereó hangkimenetet biztosítja.
13		Bekapcsoló gomb	A számítógép be- és kikapcsolására szolgál.

1. Az előlap jelzői akkor is láthatók, ha a számítógép fedele le van hajtva.

## Gyorsbillentyűk

A számítógép a beállítások jelentős részének elérését gyorsbillentyűkkel vagy billentyűkombinációkkal teszi lehetővé; ilyen például a képernyő fényereje és a hangerő.

Gyorsbillentyű használatához nyomja le és tartsa lenyomva az <Fn> billentyűt, a billentyűkombináció másik billentyűjét csak ezt követően nyomja le.

Gyorsbillentyű	Ikon	Funkció	Leírás
<Fn> + <F3>		Kommunikációs billentyű	A számítógép kommunikációs moduljainak be- és kikapcsolására használható. (A kommunikációs modulok konfigurációtól függően eltérők lehetnek.)
<Fn> + <F4>		Alvás	A számítógép alvó üzemmódba helyezése.
<Fn> + <F5>		A kijelző be- és kikapcsolása	Váltás a következő megjelenítési módok között: kijelző, külső monitor (ha csatlakoztatva van), illetve mindkettő.
<Fn> + <F6>		Kijelző kikapcsolása	A kijelző háttérvilágításának kikapcsolása energiamegtakarítás céljából. A háttérvilágítás bármely billentyű megnyomására visszakapcsol.
<Fn> + <F7>		Az érintőpad be- és kikapcsolása	A beépített érintőpad be- és kikapcsolása.
<Fn> + <F8>		Hangszóró be- és kikapcsolása	A hangszórók be- és kikapcsolását teszi lehetővé.
<Fn> + <▷>		Fényerő növelése	A kijelző fényerejének növelése.
<Fn> + <◁>		Fényerő csökkentése	A kijelző fényerejének csökkentése.
<Fn> + <Home>		Lejátszás/szünet	A kijelölt médiafájl lejátszása vagy lejátszásának szüneteltetése.
<Fn> + <Pg Up>		Leállítás	A kijelölt médiafájl lejátszásának leállítása.
<Fn> + <Pg Dn>		Előző	Visszalépés az előző médiafájltra.
<Fn> + <End>		Tovább	Ugrás a következő médiafájltra.

## Előnézet lehajtott kijelzővel



#	Ikon	Elem	Leírás
1		Görgő	A hangerő növelése és csökkentése.
2		Multifunkciós kártyaolvasó	Secure Digital (SD), MultiMediaCard (MMC), Memory Stick (MS), Memory Stick PRO (MS PRO) és xD-Picture Card (xD) kártyák fogadására képes. <b>Megjegyzés:</b> A kártyák finoman benyomva helyezhetők be és vehetők ki. Egyszerre csak egyféle kártya használatára van lehetőség.
3		CIR vevő	Távvezérlő jeleinek fogadására alkalmas.



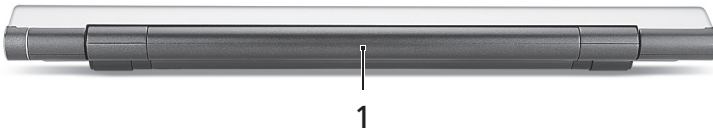



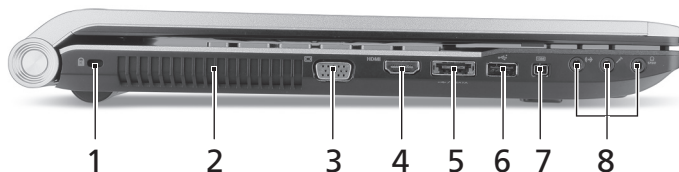

## Hátulnézet



#	Ikon	Elem	Leírás
1		Akkumulátorfoglalat	A számítógép akkumulátorát fogadja be.





## Bal oldali nézet

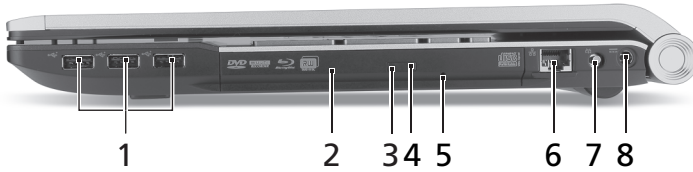

#	Ikón	Elem	Leírás
1		Kensington záraljzat	Kensington számítógépes biztonsági zár alkalmazását teszi lehetővé. <b>Megjegyzés:</b> Hurkolja a számítógépes biztonsági zárhoz tartozó drótkötelet egy mozdíthatatlan tárgy, például asztal vagy zárt fiók fogantyúja köré. Illessze be a horonyba a zárat, majd a kulcsot elfordítva rögzítse. Kaphatók kulcs nélküli modellek is.
2		Szellőzőnyílások	Segítségükkel még hosszab használat esetén is fenntartható a számítógép megfelelő üzemi hőmérséklete.
3		Külső kijelző (VGA) port	Megjelenítő eszköz (pl. külső monitor vagy LCD kivetítő) csatlakoztatását teszi lehetővé.
4	HDMI	HDMI port	A nagy felbontású, digitális videokapcsolatokat támogatja.
5	 /eSATA	USB 2.0/eSATA port	USB 2.0 eszközök és eSATA eszközök csatlakoztatására használható (vagy hasonló megjegyzés jelöli). <b>Megjegyzés:</b> Ha eSATA eszközt csatlakoztat, akkor időközben három USB port áll a rendelkezésére.
6		USB 2.0 port	USB 2.0 eszközök (pl. USB-s egér vagy kamera) csatlakoztatását teszi lehetővé.
7		4 érintkezős IEEE 1394 port	IEEE 1394 eszközök csatlakoztatását teszi lehetővé.
8		Vonali bemeneti aljzat	Hangbemeneti eszközök (pl. CD-lejátszó, sztereó sétálómagnó, mp3-lejátszó) csatlakoztatását teszi lehetővé.
		Mikrofonbemeneti aljzat	Külső mikrofon csatlakoztatását teszi lehetővé.
		Fejhallgató/hangszóró/vonali kimenet, S/PDIF-támogatással	Hangkimeneti eszközök (pl. hangszóró, fejhallgató) csatlakoztatására alkalmas.

## Jobb oldali nézet







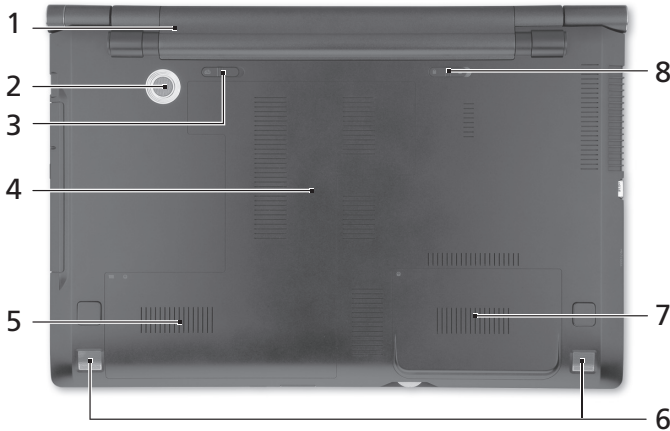

#	Ikon	Elem	Leírás
1		USB 2.0 port	USB 2.0 eszközök (pl. USB-s egér vagy kamera) csatlakoztatását teszi lehetővé.
2		Optikai meghajtó	Belső optikai meghajtó, CD- és DVD-lemezek kezelésére képes.
3		Az optikai lemez elérését jelző fény	Akkor világít, amikor az optikai meghajtó aktív.
4		Optikai meghajtó kiadógombja	Kiadatja a lemezt az optikai meghajtóból.
5		Vészkiadó furat	Lehetővé teszi az optikai meghajtó tálcájának a számítógép kikapcsolt állapotában történő kinyitását. <b>Megjegyzés:</b> Az optikai meghajtó lemeztálcájának kinyitásához helyezzen egy papírkapcsot a vészkiadó nyílásba, miközben a számítógép ki van kapcsolva.
6		Ethernet (RJ-45) port	Ethernet 10/100/1000 típusú hálózattal képes biztosítani a kapcsolatot.
7		RF-bemeneti port	Analóg/digitális TV-tuner készülékek jeleit fogadja (csak bizonyos típusok esetében).
8		Egyenáramú bemeneti aljzat	A váltakozó áramú hálózati adapter csatlakoztatását teszi lehetővé.



## Alulnézet



#	Ikön	Elem	Leírás
1		Akkumulátorfoglalat	A számítógép akkumulátorát fogadja be.
2		Mélynyomó	Az alacsony frekvenciájú hangokat szólaltatja meg.
3		Akkumulátor kioldógombja	Az akkumulátor eltávolítását teszi lehetővé.
4		Memóriarekesz	A számítógép memóriáját fogadja be.
5		Merevlemez-foglalat (elsődleges)	A számítógép merevlemezét fogadja be (csavaros rögzítésű).
6		Hangszórók	A sztereó hangkimenetet biztosítja.
7		Merevlemez-foglalat (másodlagos)	A számítógép merevlemezét fogadja be (csavaros rögzítésű) (csak bizonyos típusok esetében).
8		Akkumulátor retesze	Az akkumulátor rögzítését biztosítja.

## Környezet

---

- Hőmérséklet:
    - Üzemeltetés: 5°C – 35°C
    - Kikapcsolt állapotban: -20°C – 65°C
  - Páratartalom (kicsapódás nélkül):
    - Üzemeltetés: 20% – 80%
    - Kikapcsolt állapotban: 20% – 80%
-

# Notebook Acer

Stručné pokyny

© 2010 Všechna práva vyhrazena.

Stručné pokyny k notebooku Acer  
Původní vydání: 03/2010

Číslo modelu: \_\_\_\_\_

Sériové číslo: \_\_\_\_\_

Datum zakoupení: \_\_\_\_\_

Místo zakoupení: \_\_\_\_\_

# Stručné pokyny

Děkujeme vám, že jste si k uspokojení svých potřeb v oblasti přenosných počítačů vybrali řadu notebooků Acer.

## Uživatelské příručky

Abychom vám při používání notebooku Acer pomohli, vytvořili jsme pro vás sadu příruček:

První leták **První kroky...** vám pomůže při úvodním nastavení počítače.

**Obecná uživatelská příručka pro počítače řady Aspire** obsahuje užitečné informace pro všechny modely řady Aspire. Obsahuje základní témata, např. používání klávesnice, zvuk atd. Berte laskavě na vědomí, že **Obecná uživatelská příručka**, jak již její název předesílá, stejně jako níže zmíněná **AcerSystem User Guide**, může popisovat funkce nebo vlastnosti, kterými jsou vybaveny pouze určité modely dané řady, a kterými nemusí být nutně vybaven vámi zakoupený model. V takových případech je text označen frází „pouze u vybraných modelů“.

**Stručné pokyny** vás seznámí se základními schopnostmi a funkcemi nového počítače. Další informace o tom, jak můžete pomocí počítače zvýšit svou produktivitu, naleznete v příručce **AcerSystem User Guide**. Tato příručka obsahuje podrobné informace týkající se například systémových nástrojů, obnovování dat, možností rozšíření a odstraňování potíží. Dále obsahuje záruční informace, informace týkající se všeobecných předpisů a bezpečnostní upozornění k notebooku. Příručka je k dispozici ve formátu PDF (Portable Document Format) a je již uložena do notebooku. Zobrazíte ji následujícím postupem:

- 1 Klepněte na tlačítko  **Start > Všechny programy > AcerSystem**.
- 2 Klepněte na položku **AcerSystem User Guide**.



.....

**Poznámka:** K zobrazení tohoto souboru je vyžadován program Adobe Reader. Pokud v počítači není program Adobe Reader nainstalován, klepnutím na položku **AcerSystem User Guide** nejprve spustíte instalační program. Dokončete instalaci podle pokynů na obrazovce. Pokyny týkající se používání programu Adobe Reader jsou k dispozici v nabídce **Nápověda a odborná pomoc**.







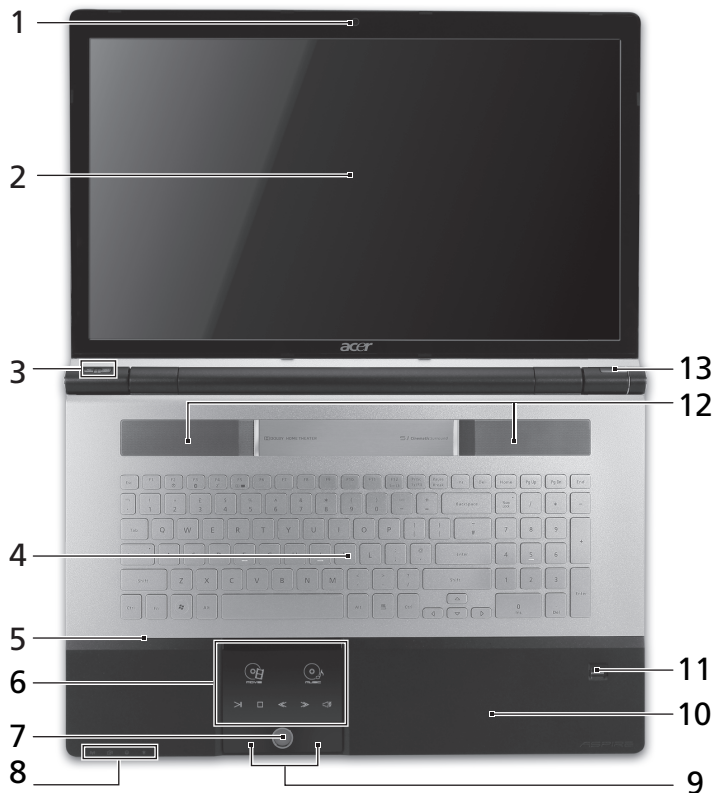





















# Seznámení s notebookem Acer

Po nastavení počítače podle pokynů znázorněných na letáku **První kroky...** vás seznámíme s vaším novým notebookem Acer.

## Pohled shora



#	Ikona	Položka	Popis
1		Webová kamera Acer Crystal Eye	Webová kamera pro obrazovou komunikaci (pouze u vybraných modelů).
2		Displej	Na displeji, označovaném také displej z tekutých krystalů (Liquid-Crystal Display; LCD), se zobrazuje grafický výstup počítače (Konfigurace se může lišit podle modelů).

#	Ikona	Položka	Popis																					
3		Klávesa Arcade	Spuštění InstantOn Arcade.																					
	P	Klávesa P/Klávesa Acer PowerSmart	Programovatelná klávesa (konfigurace se může lišit podle modelu)./ Počítač přejde do úsporného režimu (konfigurace se může lišit podle modelu).																					
4		Klávesnice	Slouží k zadávání údajů do počítače.																					
5		Mikrofon	Interní mikrofon pro nahrávání zvuku.																					
6	  	Touchpad/ Mediální konzola	<p>Polohovací zařízení citlivé na dotek, které má podobnou funkci jako počítačová myš*./ Dotykově citlivé ovládací prvky pro Acer Arcade, hlasitost (nahoru/dolů) a média (přehrát/pozastavit, zastavit, předchozí, další); s klávesou ztlumit.</p> <table border="1"> <tbody> <tr> <td></td> <td>Film</td> <td>Spuštění softwaru pro přehrávání filmu.</td> </tr> <tr> <td></td> <td>Hudba</td> <td>Spuštění softwaru pro přehrávání hudby.</td> </tr> <tr> <td></td> <td>Přehrát/ pozastavit</td> <td>Přehrát nebo pozastavit vybraný mediální soubor.</td> </tr> <tr> <td></td> <td>Zastavit</td> <td>Zastavit přehrávání vybraného mediálního souboru.</td> </tr> <tr> <td></td> <td>Předchozí</td> <td>Návrat na předchozí mediální soubor.</td> </tr> <tr> <td></td> <td>Další</td> <td>Přeskočit na další mediální soubor.</td> </tr> <tr> <td></td> <td>Ztlumit</td> <td>Zapnutí nebo vypnutí hlasitosti.</td> </tr> </tbody> </table> <p>* Je-li mediální konzola aktivní, je touchpad neaktivní.</p>		Film	Spuštění softwaru pro přehrávání filmu.		Hudba	Spuštění softwaru pro přehrávání hudby.		Přehrát/ pozastavit	Přehrát nebo pozastavit vybraný mediální soubor.		Zastavit	Zastavit přehrávání vybraného mediálního souboru.		Předchozí	Návrat na předchozí mediální soubor.		Další	Přeskočit na další mediální soubor.		Ztlumit	Zapnutí nebo vypnutí hlasitosti.
	Film	Spuštění softwaru pro přehrávání filmu.																						
	Hudba	Spuštění softwaru pro přehrávání hudby.																						
	Přehrát/ pozastavit	Přehrát nebo pozastavit vybraný mediální soubor.																						
	Zastavit	Zastavit přehrávání vybraného mediálního souboru.																						
	Předchozí	Návrat na předchozí mediální soubor.																						
	Další	Přeskočit na další mediální soubor.																						
	Ztlumit	Zapnutí nebo vypnutí hlasitosti.																						
7		Ovladač mediální konzoly	Zapnutí nebo vypnutí mediální konzoly.																					
8		Komunikační klávesa	Povoluje/zakazuje komunikační zařízení počítače. (Komunikační zařízení mohou mít různou konfiguraci.)																					
		Klávesa zálohování	Slouží ke spuštění aplikace Acer Backup Management pro vytvoření zálohy ve třech krocích.																					
		Indikátor HDD <sup>1</sup>	Svítí, pokud je aktivní pevný disk.																					
		Indikátor napájení <sup>1</sup>	Indikuje stav napájení počítače.																					







#	Ikona	Položka	Popis
9		Tlačítka (levé a pravé)	Levé a pravé tlačítko funguje jako levé a pravé tlačítko myši.
10		Podložka ruky	Oblast k pohodlnému opření rukou při používání počítače.
11		Čtečka otisků prstů Acer Bio-Protection	Podporuje funkci čtyřsměrného ovládání Acer FingerNav (pouze u vybraných modelů).
12		Reproduktory	Zajišťují stereofonní zvukový výstup.
13		Tlačítko napájení	Slouží k zapnutí a vypnutí počítače.

1. Stavové indikátory na předním panelu jsou viditelné i po zavření víka počítače.







## Klávesové zkratky

Tento počítač využívá klávesové zkratky nebo kombinace kláves ke zpřístupnění většiny ovládacích prvků počítače, jako je jas zobrazení a hlasitost výstupu.

Klávesovou zkratku aktivujete stisknutím a podržením klávesy <Fn> dříve, než stisknete druhou klávesu této kombinace.

Klávesová zkratka	Ikona	Funkce	Popis
<Fn> + <F3>		Komunikační klávesa	Povoluje/zakazuje komunikační zařízení počítače. (Komunikační zařízení mohou mít různou konfiguraci.)
<Fn> + <F4>		Režim spánku	Slouží k přepnutí počítače do režimu spánku.
<Fn> + <F5>		Přepnutí displeje	Přepíná výstup zobrazení mezi displejem, externím monitorem (pokud je připojen) a oběma zařízeními.
<Fn> + <F6>		Prázdná obrazovka	Slouží k vypnutí podsvícení obrazovky displeje, čímž se ušetří energie. Podsvícení obnovíte stisknutím libovolné klávesy.
<Fn> + <F7>		Přepnutí zařízení touchpad	Slouží k zapnutí a vypnutí interního zařízení touchpad.
<Fn> + <F8>		Přepnutí reproduktoru	Slouží k zapnutí a vypnutí reproduktorů.



Klávesová zkratka	Ikona	Funkce	Popis
<Fn> + <▶>		Zvýšení jasu	Slouží ke zvýšení jasu obrazovky.
<Fn> + <◀>		Snížení jasu	Slouží ke snížení jasu obrazovky.
<Fn> + <Home>		Přehrávat/ Pozastavit	Přehrát nebo pozastavit vybraný mediální soubor.
<Fn> + <Pg Up>		Zastavit	Zastavit přehrávání vybraného mediálního souboru.
<Fn> + <Pg Dn>		Předchozí	Návrat na předchozí mediální soubor.
<Fn> + <End>		Další	Přeskočit na další mediální soubor.

## Pohled na zavřenou přední stranu



#	Ikona	Položka	Popis
1		Ovládací kolečko	Zvýšení nebo snížení hlasitosti.
2		Čtečka karet Více v 1	Podporuje karty Secure Digital (SD), MultiMediaCard (MMC), Memory Stick (MS), Memory Stick PRO (MS PRO) a xD-Picture Card (xD). <b>Poznámka:</b> Stisknutím vyjměte nebo vložte kartu. V jednom okamžiku lze použít jen jednu kartu.
3		Přijímač CIR	Přijímá signály z dálkového ovládání.

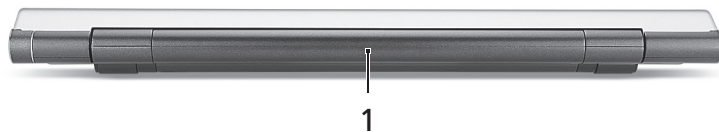

## Pohled zezadu





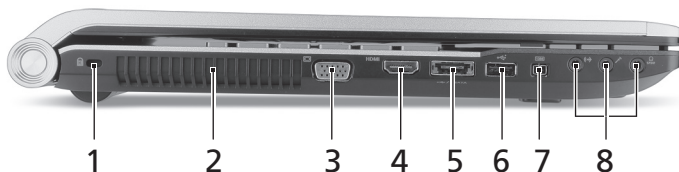

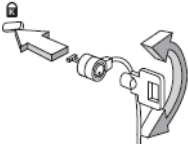

#	Ikona	Položka	Popis
1		Pozice pro baterii	Zde je uložena baterie počítače.

## Pohled zleva





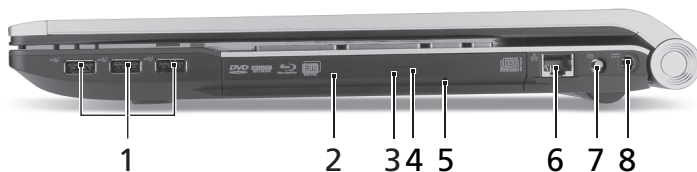

#	Ikona	Položka	Popis
1		Drážka pro zámek Kensington 	Umožňuje připojení počítačového bezpečnostního zámku kompatibilního s typem Kensington. <b>Poznámka:</b> Připevněte bezpečnostní kabel k nehybnému předmětu, například ke stolu nebo rukojeti uzamčené zásuvky. Vložte zámek do drážky a otočením klíče zámek zamkněte. K dispozici jsou rovněž modely bez klíče.
2		Ventilační otvory	Umožňují chlazení počítače i při dlouhodobém používání.
3		Port externího zobrazovacího zařízení (VGA)	Umožňuje připojení zobrazovacího zařízení (například externího monitoru nebo projektoru LCD).
4	HDMI	Port HDMI	Podporuje připojení digitálního videa ve vysokém rozlišení.

#	Ikona	Položka	Popis
5	 /e SATA	Port USB 2.0/ eSATA	Umožňuje připojení zařízení s rozhraním USB 2.0 nebo eSATA (pouze u vybraných modelů). <b>Poznámka:</b> Když připojíte zařízení eSATA, budete mít mezitím dostupné tři USB porty.
6		Port USB 2.0	Umožňuje připojení zařízení s rozhraním USB 2.0 (například myš nebo fotoaparát USB).
7		4 pinový port IEEE 1394	Umožňuje připojení zařízení IEEE 1394.
8		Konektor pro vstup vnějšího zdroje	Slouží k připojení vnějších zdrojů zvuku (například stereofonního přehrávače CD nebo kazet, přehrávače mp3).
		Konektor pro vstup mikrofonu	Slouží k připojení vstupů z externího mikrofonu.
		Konektor pro připojení sluchátek, reproduktorů nebo zvukového výstupu s podporou rozhraní S/PDIF	Slouží k připojení vnějších výstupních zvukových zařízení (například reproduktorů nebo sluchátek).







## Pohled zprava

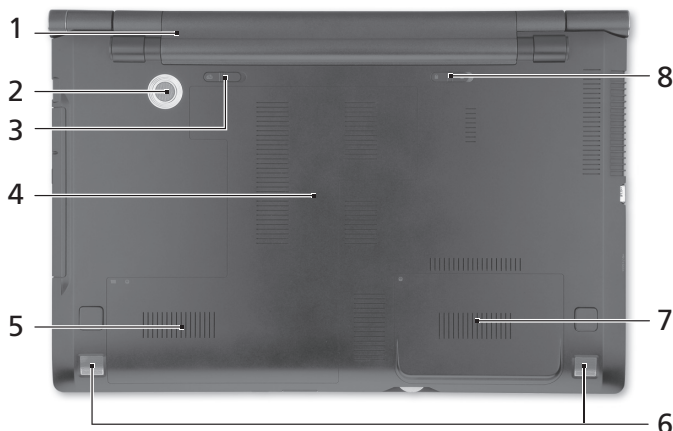

#	Ikona	Položka	Popis
1		Porty USB 2.0	Umožňuje připojení zařízení s rozhraním USB 2.0 (například myš nebo fotoaparát USB).
2		Optická jednotka	Interní optická jednotka, používá disky CD a DVD.
3		Indikátor přístupu k optickému disku	Svítlí, pokud je optická jednotka aktivní.
4		Tlačítko vysunutí optické jednotky	Vysouvá optický disk z jednotky.
5		Otvor pro nouzové vysunutí	Umožňuje vysunutí přihrádky optické jednotky, pokud je počítač vypnutý. <b>Poznámka:</b> Chcete-li vysunout přihrádku optické jednotky, jestliže je počítač vypnutý, vložte do otvoru pro nouzové vysunutí kancelářskou sponku.
6		Port Ethernet (RJ-45)	Slouží k připojení počítače k síti Ethernet 10/100/1000.
7		Port RF-in	Umožňuje připojení vstupního signálu z digitálních televizních tunerů (pouze u vybraných modelů).
8		Napájecí konektor	Zajišťuje připojení k síťovému adaptéru.

## Pohled zespodu



#	Ikona	Položka	Popis
1		Pozice pro baterii	Zde je uložena baterie počítače.
2		Basový reproduktor	Vydává nízkofrekvenční zvukový výstup.
3		Uvolňovací západka baterie	Uvolňuje baterii k vyjmutí.
4		Pozice pro paměť	Zde je uložena hlavní paměť počítače.
5		Hlavní pozice pro pevný disk	Zde je uložen pevný disk počítače (zajištěný šroubem).
6		Reproduktory	Zajišťují stereofonní zvukový výstup.
7		Vedlejší pozice pro pevný disk	Zde je uložen pevný disk počítače (zajištěný šrouby) (pouze u vybraných modelů).
8		Zámek baterie	Zamkne baterii na místě.

## Prostředí

- Teplota:
  - Provozní: 5°C až 35°C
  - Neprovozní: -20°C až 65°C
- Vlhkost (nekondenzující):
  - Provozní: 20% až 80%
  - Neprovozní: 20% až 80%



# Prenosný počítač Acer

Stručná príručka

© 2010 Všetky práva vyhradené.

Stručná príručka pre prenosný počítač Acer  
Pôvodné vydanie: 03/2010

Číslo modelu: \_\_\_\_\_

Sériové číslo: \_\_\_\_\_

Dátum zakúpenia: \_\_\_\_\_

Miesto zakúpenia: \_\_\_\_\_



# Hneď na úvod

Radi by sme vám poďakovali za rozvoj prenosných počítačov série Acer - vašej voľby pre vaše mobilné počítačové potreby.

## Vaše príručky

Aby sme vám pomohli s používaním Acer, vytvorili sme pre vás sadu príručiek:

V prvom rade plagát **Práve začíname...**, ktorý vám pomôže začať s nastavením vášho počítača.

**Všeobecná používateľská príručka pre sériu Aspire** obsahuje užitočné informácie týkajúce sa všetkých modelov v produktovom rade Aspire. Obsahuje základné témy, ako napríklad informácie o používaní klávesnice, zvuku atď. Majte teda na pamäti, že **Všeobecná používateľská príručka** ako aj **AcerSystem User Guide**, ktorá je spomenutá ďalej, občas obsahujú informácie o funkciách a vlastnostiach, ktorými sú vybavené iba určité modely produktovej série a model, ktorý si zakúpili, nimi nemusí byť vybavený. Opis takýchto funkcií je v texte označený poznámkou v zmysle „len pre určité modely“.

**Stručná príručka** sú základné funkcie a vlastnosti vášho nového počítača. Informácie o tom, ako vám počítač pomôže byť produktívnejší, nájdete v **AcerSystem User Guide**. Táto príručka obsahuje podrobné informácie o systémových programoch, obnove dát, možnostiach rozšírenia a riešenie problémov. Okrem toho obsahuje informácie o záruke a všeobecné vyhlásenia k predpisom a bezpečnosti. Je dostupná vo formáte PDF a je umiestnená vo vašom prenosnom počítači. Ak si chcete pozrieť jej obsah, postupujte podľa nasledovných krokov:

- 1 Kliknite na  **Štart > Všetky programy > AcerSystem**.
- 2 Kliknite na **AcerSystem User Guide**.



.....







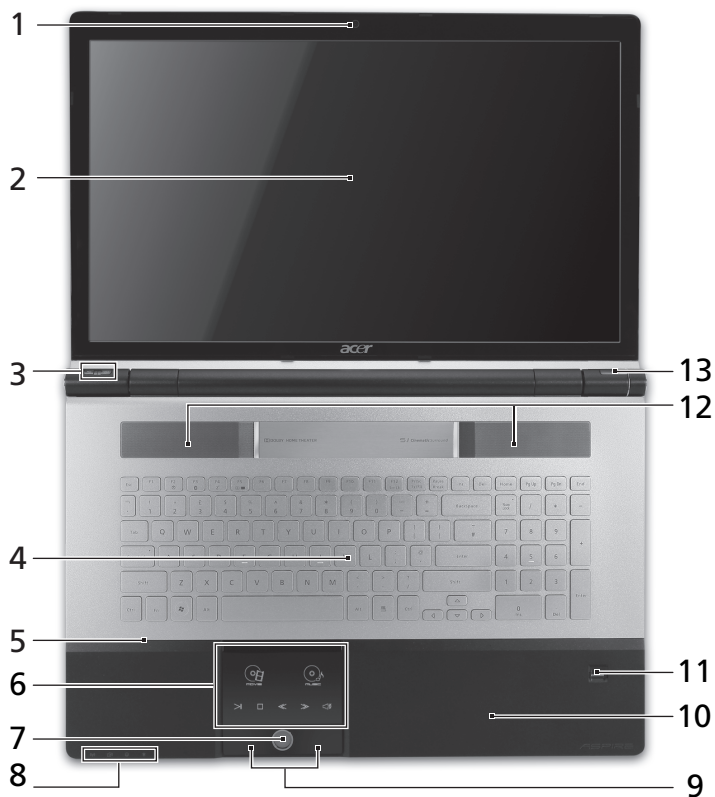

**Poznámka:** Prezeranie súboru vyžaduje Adobe Reader. Ak na vašom počítači nie je Adobe Reader nainštalovaný, kliknutím na **AcerSystem User Guide** sa najprv spustí inštalácia programu Adobe Reader. Inštaláciu dokončíte podľa inštrukcií, ktoré uvidíte na obrazovke. Inštrukcie ako používať Adobe Reader nájdete v menu **Pomocník a Podpora**.





# Zoznámte sa so svojím prenosným počítačom Acer

Po nastavení vášho počítača podľa **Práve začíname...** nám dovoľte, aby sme vás zoznámili s vaším novým prenosným počítačom Acer.

## Pohľad zhora



#	Ikona	Položka	Popis
1		Webkamera Acer Crystal Eye	Webová kamera na video komunikáciu (len pre určité modely).
2		Obrazovka	Nazýva sa tiež Liquid-Crystal Display (LCD), zobrazuje výstup z počítača (Konfigurácia sa môže v závislosti od modelu líšiť).
3		Kláves Arcade	Spúšťa aplikáciu InstantOn Arcade.
	P	Kláves P/Kláves Acer PowerSmart	Programovateľný kláves (konfigurácia sa môže v závislosti od modelu líšiť)./ Uvedie počítač do režimu úspory energie (konfigurácia sa môže v závislosti od modelu líšiť).
4		Klávesnica	Služí na zadávanie údajov do počítača.
5		Mikrofón	Interný mikrofón na nahrávanie zvuku.
6		Dotyková plocha/ Konzola médií	Zariadenie s citlivosťou na dotyk, ktoré funguje ako počítačová myš*. / Dotykové ovládacie prvky pre Acer Arcade, hlasitosť (nahor/nadol) a médiá (prehrať/pozastaviť, zastaviť, predch., nasled.) so stlmením zvuku.
		Film	Spúšťa softvér na prehrávanie filmov.
		Hudba	Spúšťa softvér na prehrávanie hudby.
		Prehrať/ pauza	Prehrávanie alebo pozastavenie vybraného súboru média.
		Zastaviť	Zastavenie prehrávania vybraného súboru média.
		Predch.	Návrat na predchádzajúci súbor média.
		Ďalej	Preskočenie na nasledujúci súbor média.
		Stlmiť	Zapína a vypína hlasitosť.
			* Dotyková plocha sa stane neaktívna, keď sa aktivuje Konzola médií.

#	Ikona	Položka	Popis
7		Ovládanie Konzoly médií	Zapína alebo vypína Konzolu médií.
8		Kláves komunikácie	Zapína a vypína komunikačné zariadenia počítača. (Komunikačné zariadenia sa môžu líšiť v závislosti od konfigurácie.)
		Kláves Zálohovať	Spúšťa aplikáciu Acer Backup Management pre zálohovanie údajov v troch krokoch.
		Indikátor HDD <sup>1</sup>	Svieti, keď je jednotka pevného disku aktívna.
		Kontrolka napájania <sup>1</sup>	Signalizuje stav napájania počítača.
9		Tlačidlá na klikanie (ľavé a pravé)	Funkcia ľavého a pravého tlačidla je podobná ako funkcia ľavého a pravého tlačidla myši.
10		Podložka rúk	Pohodlná opora rúk pri práci s počítačom.
11		Čítačka odtlačkov prstov Acer Bio-Protection	Podporuje funkciu 4-smerového ovládania Acer FingerNav (len pre určité modely).
12		Reproduktory	Poskytuje výstup stereo zvuku.
13		Tlačidlo Power (Zapnúť)	Zapína a vypína počítač.

1. Kontrolky na prednom paneli sú viditeľné, aj keď je veko počítača zatvorené.

## Klávesové skratky





Počítač využíva klávesové skratky alebo kombinácie klávesov na prístup k väčšine nastavení počítača, ako je napríklad jas obrazovky a hlasitosť výstupu.

Ak chcete aktivovať klávesové skratky, stlačte a podržte kláves <Fn> pred stlačením ďalšieho klávesu v klávesovej skratke.

Klávesová skratka	Ikona	Funkcia	Popis
<Fn> + <F3>		Kláves komunikácie	Zapína a vypína komunikačné zariadenia počítača. (Komunikačné zariadenia sa môžu líšiť v závislosti od konfigurácie.)
<Fn> + <F4>		Režim spánku	Prepne počítač do režimu spánku.
<Fn> + <F5>		Prepínanie zobrazenia	Prepína výstup zobrazenia – obrazovka, externý monitor (ak je pripojený) a obidva súčasne.
<Fn> + <F6>		Prázdna obrazovka	Vypína podsvietenie obrazovky kvôli úspore energie. Pre návrat stlačte akýkoľvek kláves.
<Fn> + <F7>		Prepínanie dotykovej plochy	Zapína a vypína internú dotykovú plochu.
<Fn> + <F8>		Prepínanie reproduktora	Zapína a vypína reproduktory.
<Fn> + <D>		Zvýšenie jasu	Zvyšuje jas obrazovky.
<Fn> + <D>		Zníženie jasu	Znižuje jas obrazovky.
<Fn> + <Home>		Prehrať/pauza	Prehrávanie alebo pozastavenie vybraného súboru média.
<Fn> + <Pg Up>		Zastaviť	Zastavenie prehrávania vybraného súboru média.
<Fn> + <Pg Dn>		Predch.	Návrat na predchádzajúci súbor média.
<Fn> + <End>		Ďalej	Preskočenie na nasledujúci súbor média.

## Pohľad spredu (zatvorený)



#	Ikona	Položka	Popis
1		Ovládacie koliesko	Zvyšuje alebo znižuje hlasitosť.
2	    	Čítačka kariet Multi-in-1	Podporuje karty Secure Digital (SD), MultiMediaCard (MMC), Memory Stick (MS), Memory Stick PRO (MS PRO) a xD-Picture Card (xD). <b>Poznámka:</b> Stlačením vytiahnete/vložíte kartu. Nie je možné pracovať s viacerými kartami naraz.
3		Prijímač CIR	Prijíma signály z diaľkového ovládania.



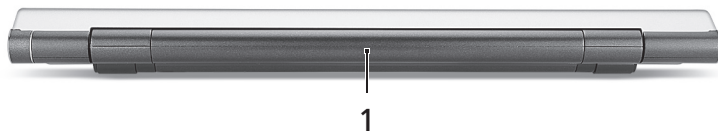



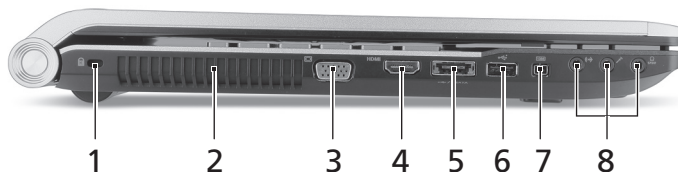

## Pohľad zozadu

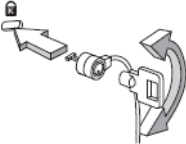

#	Ikona	Položka	Popis
1		Jednotka batérie	Slúži na uloženie batérie počítača.





## Pohľad zľava

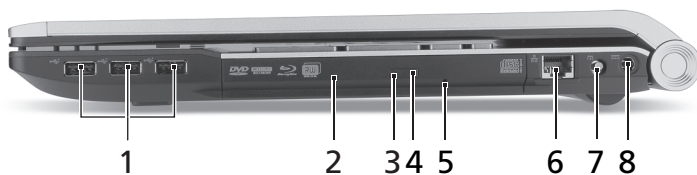

#	Ikona	Položka	Popis
1		Zásuvka na zámok Kensington 	Pripojenie počítačového bezpečnostného kľúča Kensington. <b>Poznámka:</b> Pripojte kábel bezpečnostného zámku počítača k nepohyblivému predmetu, napríklad stolu alebo držadlu zaistenej zásuvky. Vložte zámok do otvoru a otočte kľúčom kvôli zaisteniu zámku. Niektoré modely sú dostupné aj bez zámku.
2		Otvory na ventiláciu	Pomáha udržať pri dlhom používaní počítač chladný.
3		Port externej obrazovky (VGA)	Pripojenie zobrazovacieho zariadenia (napr. externého monitora, LCD projektora).
4	HDMI	Port HDMI	Podporuje pripojenie digitálneho videa s vysokým rozlíšením.
5	 /e SATA	Port USB 2.0/eSATA	Pripojenie zariadení cez rozhranie USB 2.0 alebo eSATA (len pre určité modely). <b>Poznámka:</b> Ak pripojíte zariadenie eSATA, budete mať k dispozícii tri porty rozhrania USB.
6		Port USB 2.0	Pripojenie zariadení cez rozhranie USB 2.0 (napr. USB myš, USB fotoaparát).
7		4-pinový port IEEE 1394	Pripojenie zariadení IEEE 1394.
8		Konektor vstupu zvuku	Vstup zvukových zariadení (napr. prehrávač zvukových CD, stereo walkman, mp3 prehrávač).
		Konektor vstupu mikrofónu	Slúži na vstup zvuku z externých mikrofónov.
		Výstup s podporou S/PDIF na slúchadlá/reproduktor/externé zvukové zariadenie	Výstup zvuku do zvukových zariadení (napr. reproduktorov, slúchadiel).

## Pohľad sprava







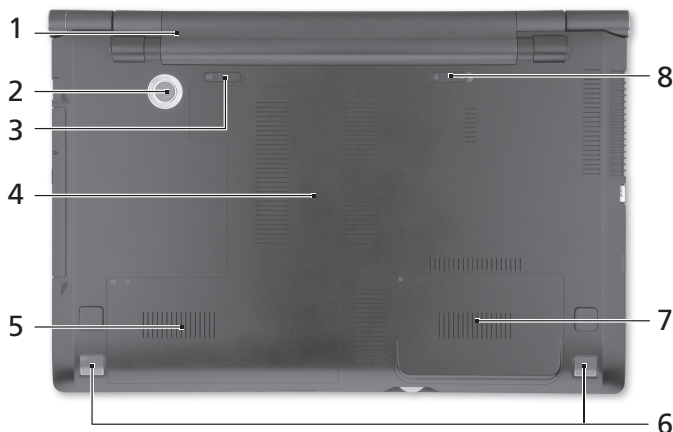

#	Ikona	Položka	Popis
1		Porty USB 2.0	Pripojenie zariadení cez rozhranie USB 2.0 (napr. USB myš, USB fotoaparát).
2		Optická mechanika	Interná optická mechanika na CD alebo DVD disky.
3		Indikátor prístupu na optický disk	Svieti, keď je optická mechanika aktívna.
4		Tlačidlo vysúvania optickej mechaniky	Vysúva optický disk z jednotky.
5		Otvor núdzového vysúvania	Vysúva optickú mechaniku pri vypnutom počítači. <b>Poznámka:</b> Keď je počítač vypnutý, optickú jednotku vysuniete zasunutím kancelárskej sponky do núdzového otvoru.
6		Port siete Ethernet (RJ-45)	Pripojenie k sieti Ethernet 10/100/1000.
7		Port vstupu RF	Pre vstup signálu zo zariadení digitálneho TV tunera (len pre určité modely).
8		Konektor vstupu jednosmerného napätia	Pripojenie adaptéra striedavého napätia.



## Pohľad zdola



#	Ikona	Položka	Popis
1		Jednotka batérie	Slúži na uloženie batérie počítača.
2		Subwoofer	Vydáva nízkočfrekvenčný zvukový výstup.
3		Západka uvoľnenia batérie	Slúži na uvoľnenie batérie pri jej vyberaní.
4		Pozícia pre pamäť	Tu je uložená hlavná pamäť počítača.
5		Jednotka pevného disku – hlavná	Slúži na uchytenie pevného disku počítača (zaistené skrutkou).
6		Reproduktory	Poskytuje výstup stereo zvuku.
7		Jednotka pevného disku – druhá	Slúži na uchytenie pevného disku počítača (zaistené skrutkami) (len pre určité modely).
8		Zámok batérie	Uzamyká batériu na jej mieste.

## Prostredie

- Teplota:
  - Prevádzková: 5°C až 35°C
  - Mimoprevádzková: -20°C až 65°C
- Vlhkosť (nekondenzačná):
  - Prevádzková: 20% až 80%
  - Mimoprevádzková: 20% až 80%



# Prenosnik Acer

Hitri vodič

© 2010 Vse pravice pridržane.

Hitri vodnik za prenosnik Acer  
Originalna izdaja: 03/2010

Številka modela: \_\_\_\_\_

Serijska številka: \_\_\_\_\_

Datum nakupa: \_\_\_\_\_

Mesto nakupa: \_\_\_\_\_

# Najprej začetek

Želimo se vam zahvaliti, ker ste za zadovoljevanje prenosnih računalniških potreb izbrali prenosnik Acer.

## Vaša navodila

Za pomoč pri uporabi vašega prenosnika Acer, smo izdelali paket navodil:

Za začetek vam plakat **Za začetek...** pomaga pri nastavljanju vašega računalnika.

**Splošni uporabniški priročnik serije Aspire** vsebuje uporabne informacije, ki veljajo za vse modele serije izdelkov Aspire. Pokriva osnovne teme, kot so uporaba tipkovnice in nastavitve zvoka itd. Prosimo, da upoštevate, da bosta se **Splošni uporabniški priročnik** kot tudi **uporabniški priročnik AcerSystem (AcerSystem User Guide)** omenjen spodaj, zaradi svoje splošne narave včasih nanašala na funkcije ali lastnosti, ki jih imajo le nekateri modeli iz serije, ne pa nujno tudi model, ki ste ga kupili. Takšni primeri so označeni z napisom „le na določenih modelih“.

**Hitri vodič** vsebuje osnovne funkcije vašega novega računalnika. Za več informacije o tem kako vam lahko računalnik pomaga do večje produktivnosti, prosimo glejte **uporabniški priročnik AcerSystem (AcerSystem User Guide)**. Ta navodila vsebujejo podrobne informacije o sistemskih pripomočkih, obnovi podatkov, možnostih razširitve in odpravljanju težav. Poleg tega vsebuje garancijske informacije in splošne uredbe in varnostna obvestila za vaš prenosnik. Navodila so na voljo v obliki prenosnega dokumenta (PDF) in so naložena na vaš prenosnik. Za navodila sledite tem korakom:

- 1 Kliknite  **Start > Vsi programi > AcerSystem.**
- 2 Kliknite na **uporabniški priročnik AcerSystem (AcerSystem User Guide).**



-----







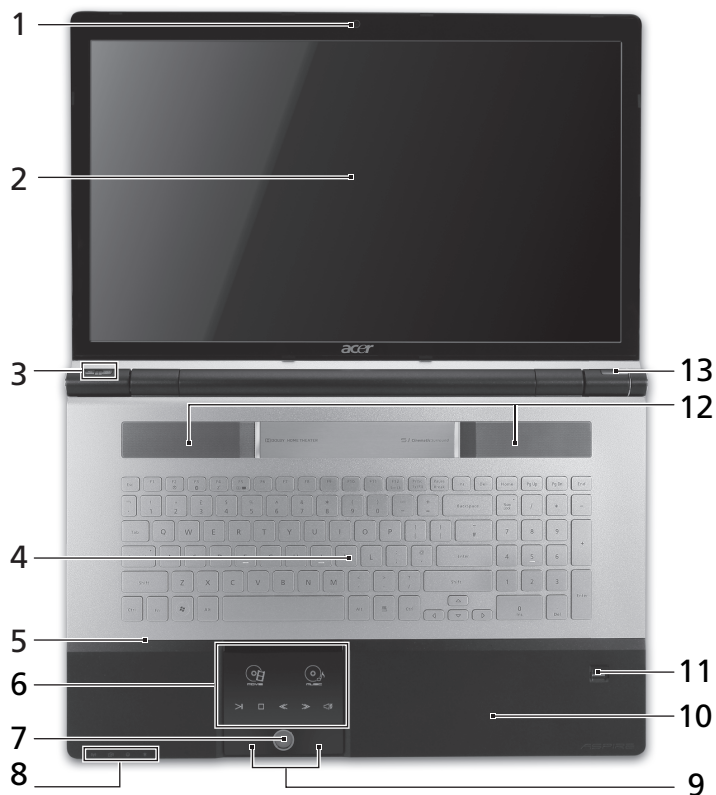

**Opomba:** Za pregledovanje datoteke potrebujete Adobe Reader. Če Adobe Reader ni nameščen na računalnik se bo zagnal namestitveni program Adobe Reader, ko kliknete na **uporabniški priročnik AcerSystem (AcerSystem User Guide)**. Za zaključek postopka sledite navodilom na zaslonu. Za navodila o uporabi Adobe Reader, odprite meni **Help and Support**.

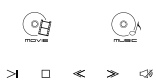



# Vodič po vašem prenosniku Acer

Ko ste nastavili računalnik, kot je prikazano v oddelku **Za začetek**, naj vam predstavimo vaš prenosnik Acer.

## Pogled od zgoraj



#	Ikona	Predmet	Opis
1		Integrirana spletna kamera Acer Crystal Eye	Spletna kamera za video komunikacijo (le na določenih modelih).
2		Zaslon	Takoimenovani zaslon s tekoimi kristali (LCD), prikazuje izhod vašega računalnika (konfiguracija je za različne modele razlina).
3		Tipka Arcade	Zagon InstantOn Arcade.
	P	Tipka P/Tipka Acer PowerSmart	Programljiva tipka (konfiguracija se lahko pri posameznih modelih razlikuje)./ Preklopi računalnik v stanje varčevanja z energijo (konfiguracija se lahko pri posameznih modelih razlikuje).
4		Tipkovnica	Za vnos podatkov v računalnik.
5		Mikrofon	Notranji mikrofon za snemanje zvoka.
6		Sledilna plošča/ Medijska konzola	Na dotik občutljiva naprava, ki deluje kot računalniška miška*./ Na dotik občutljive kontrole za Acer Arcade, glasnost (zvišaj/ znižaj) in za predvajanje medijev (predvajanje/ premor, zaustavitev, predhodni, naslednji) in možnost nemega predvajanja.
		Film	Zagon programske opreme za predvajanje filmov.
		Glasba	Zagon programske opreme za predvajanje glasbe.
		Predvajaj/ premor	Predvaja ali zaustavi izbrano medijski datoteko.
		Ustavi	Zaustavi predvajanje izbrane medijske datoteke.
		Predhodni	Vrnitev na predhodno medijsko datoteko.
		Naslednji	Skok na naslednjo medijsko datoteko.
		Nemo	Vklop ali izklop medijske konzole.
			* Sledilna plošča se aktivira, ko je aktivna medijska konzola.
7		Krmilnik medijske konzole	Vklop ali izklop medijske konzole.

#	Ikona	Predmet	Opis
8		Komunikacijska tipka	Omogoči/onemogoči komunikacijske naprave računalnika. (Komunikacijske naprave se lahko razlikujejo po konfiguraciji.)
		Tipka za varnostno kopiranje	Zagon programa Acer Backup Management za varnostno kopiranje podatkov v treh korakih.
		Indikator trdega diska <sup>1</sup>	Označuje, ko je trdi disk aktiven.
		Indikator stanja napajanja <sup>1</sup>	Označuje stanje napajanja računalnika.
9		Tipke (levo in desno)	Leva in desna tipka delujejo kot leva in desni tipka na miški.
10		Podpora za dlan	Udobna podpora za vaše roke, ko uporabljate računalnik.
11		Čitalec prstnih odtisov Acer Bio-Protection	Podpira Acerjevo funkcijo 4-smernega nadzora FingerNav (le na določenih modelih).
12		Zvočniki	Na voljo je izhod avdio stereo.
13		Tipka za vklop/izklop	Vklop in izklop računalnika.













1. Indikatorji na sprednji plošči so vidni tudi, ko je pokrov računalnika zaprt.



## Vročne tipke

Računalnik uporablja vroče tipke ali kombinacijo tipk za dostop do računalniških nastavitev kot sta svetlost zaslona in glasnost.

Za aktiviranje vročih tipk pritisnite in držite tipko <Fn> preden pritisnete drugo tipko v kombinaciji.

Bližnjica	Ikona	Funkcija	Opis
<Fn> + <F3>		Komunikacijska tipka	Omogoči/onemogoči komunikacijske naprave računalnika. (Komunikacijske naprave se lahko razlikujejo po konfiguraciji.)
<Fn> + <F4>		Mirovanje	Preklopi računalnik v stanje mirovanja.
<Fn> + <F5>		Preklop zaslona	Preklopi izhod zaslona med zaslonom, zunanjim monitorjem (če je priključen) in obema.
<Fn> + <F6>		Prazen zaslon	Izključi luč zaslona za varčevanje z energijo. Pritisnite poljubno tipko za vrnitev.
<Fn> + <F7>		Preklop sledilne plošče	Vključi in izključi notranjo sledilno ploščo.
<Fn> + <F8>		Preklop zvočnikov	Vklop in izklop zvočnikov.
<Fn> + <▷>		Poveča svetlost	Poveča svetlost zaslona.
<Fn> + <◁>		Zmanjša svetlost	Zmanjša svetlost zaslona.
<Fn> + <Home>		Predvajaj/ Premor	Predvaja ali zaustavi izbrano medijski datoteko.
<Fn> + <Pg Up>		Ustavi	Zaustavi predvajanje izbrane medijske datoteke.
<Fn> + <Pg Dn>		Predhodni	Vrnitev na predhodno medijsko datoteko.
<Fn> + <End>		Naslednji	Skok na naslednjo medijsko datoteko.

## Zaprto pogled od spredaj



#	Ikona	Predmet	Opis
1		Kontrola za palec	Povečanje ali zmanjšanje glasnosti zvoka.
2		Čitalec kartic več-v-1	Sprejema Secure Digital (SD), MultiMediaCard (MMC), Memory Stick (MS), Memory Stick Pro (MS PRO), in xD-kartico za fotografije. <b>Opomba:</b> Pritisnite, da bi odstranili/vstavili kartico. Naenkrat lahko uporabljate le eno kartico.
3		Sprejemnik CIR	Sprejema signal daljinskega upravljalnika.



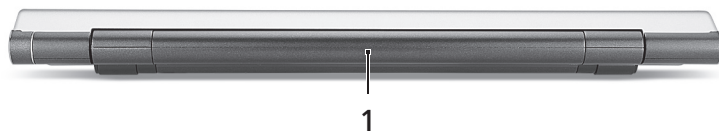



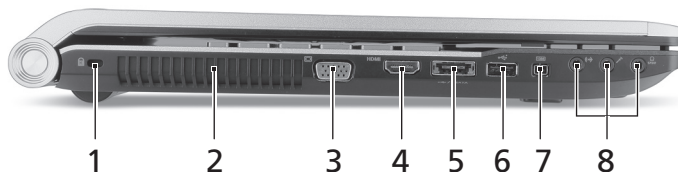

## Pogled od zadaj

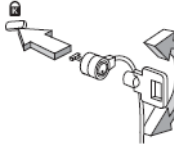

#	Ikona	Predmet	Opis
1		Nosilec za baterijo	Hrani baterijo računalnika.





## Pogled iz leve strani

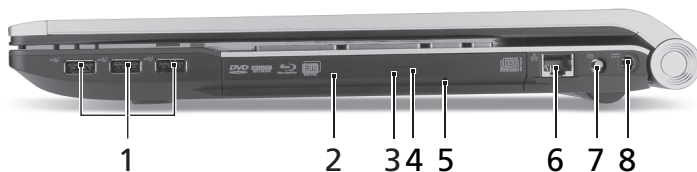

#	Ikona	Predmet	Opis
1		Reža za zaklep Kensington 	Priključek za Kensington združljivo računalniško ključavnico. <b>Opomba:</b> Ovijete varnostni kabel okoli nepremičnega predmeta, kot je miza ali ročaj zaklenjenega predala. Vstavite zaklep v zarezo in obrnite ključ, da ga zaklenete. Na voljo so tudi nekateri modeli brez ključev.
2		Reže za prezračevanje	Omogočajo, da računalnik ostane hladen tudi po dolgotrajni uporabi.
3		Priključek za zunanji zaslon (VGA)	Priključitev na prikazovalno napravo (npr. zunanji monitor, projektor LCD).
4	HDMI	Vhod HDMI	Podpira priključke za visokoločljivostni digitalni video.
5	 /e SATA	Vrata USB 2.0/ eSATA	Priključek za naprave USB 2.0 ali eSATA (le na določenih modelih). <b>Opomba:</b> Če priključite napravo na vhod eSATA, boste imeli na razpolago tri proste vhode USB.
6		Vrata USB 2.0	Priključek za naprave USB 2.0 (npr., USB miška, USB fotoaparati).
7		4-pinski vhod IEEE 1394	Mogoče je priključiti naprave IEEE 1394.
8		Vtičnica za avdio naprave	Sprejema avdio naprave (npr. avdio CD predvajalnik, stereo walkman, predvajalnik mp3).
		Vtičnica za mikrofoni	Sprejema vhode iz zunanjih mikrofonov.
		Vhod za slušalke/ zvočnike/naprave s podporo S/PDIF	Priključek za avdio naprave (npr. zvočniki, slušalke).







## Pogled iz desne strani

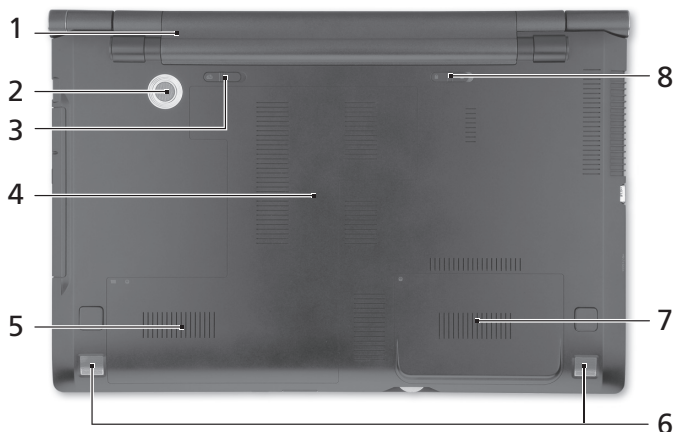

#	Ikona	Predmet	Opis
1		Vrata USB 2.0	Priključek za naprave USB 2.0 (npr., USB miška, USB fotoaparata).
2		Optični pogon	Notranji optični pogon; sprejema CD-je ali DVD-je.
3		Pokazatelj dostopa do optičnega diska	Zasveti, ko je optični pogon aktiven.
4		Tipka za izvržiti optični pogon	Izvrže optični disk iz pogona.
5		Luknja za izvržbo v nujnem primeru	Izvrže pladenj optičnega pogona, ko je računalnik izključen. <b>Opomba:</b> Vstavite sponko v luknjo za izvržbo v nujnem primeru, da izvržete pladenj optičnega pogona, ko je računalnik izključen.
6		Priključek Ethernet (RJ-45)	Priključek na omrežja Ethernet 10/100/1000.
7		Vrata za vhod RF	Sprejema vhodne signale iz digitalnih TV naprav (le na določenih modelih).
8		Priključek napajalnika	Priključek na AC napajalnik.

## Pogled od spodaj



#	Ikona	Predmet	Opis
1		Nosilec za baterijo	Hrani baterijo računalnika.
2		Nizkotonec	Oddaja zvoke nizke frekvence.
3		Zapah za sprostitev baterije	Sprostitev baterije za odstranjevanje.
4		Razdelek za pomnilnik	Hrani glavni spomin računalnika.
5		Predal za trdi disk – glavni	Hrani trdi disk računalnika (pričvrščeno z vijaki).
6		Zvočniki	Na voljo je izhod avdio stereo.
7		Predal za trdi disk – sekundarni	Hrani trdi disk računalnika (pričvrščeno z vijaki) (le na določenih modelih).
8		Zaklep za baterijo	Zaklene baterijo na mesto.

## Okolje

- Temperatura:
  - Delovanje: 5°C do 35°C
  - Mirovanje: -20°C do 65°C
- Vlažnost (brez kondenza):
  - Delovanje: 20 % do 80 %
  - Mirovanje: 20 % do 80 %



# Acer prijenosno računalo

Kratki vodič

© 2010 Sva prava pridržana.

Kratki vodič za Acer prijenosno računalo  
Izvorno izdanje: 03/2010

Broj modela: \_\_\_\_\_

Serijski broj: \_\_\_\_\_

Datum kupovine: \_\_\_\_\_

Mjesto kupovine: \_\_\_\_\_



# Prvo osnovne stvari

Željeli bismo zahvaliti na izboru Acer prijenosnog računala koje će vam poslužiti kamo god krenuli.

## Vaši vodiči

Kako bismo pomogli pri uporabi vašeg Acer prijenosnog računala, za vas smo pripremili sljedeće vodiče:

Na prvom mjestu, poster **Tek za početak...** pomaže pri početnim postupcima i postavljanju vašeg računala.

**Opći priručnik za korisnike Aspire serije** sadrži korisne informacije koje se odnose na sve modele Aspire serije proizvođača. Priručnik obuhvaća osnovne teme poput uporabe tipkovnice, audia, i sl. Obratite pažnju na činjenicu kako zbog načina izdanja **Opći priručnik za korisnike** kao i **AcerSystem korisnički vodič (AcerSystem User Guide)** koji su navedeni dolje, ponekad navodite obilježja ili funkcije koje su dostupne samo s određenim modelima serije, ali ne nužno i na vašem modelu. U takvim slučajevima bit će naveden tekst poput "samo za određene modele".

**Kratki vodič** upoznaje vas s osnovnim obilježjima i funkcijama vašeg novog računala. Za više informacija o tome kako vam vaše računalo može pomoći da budete produktivniji, molimo, pogledajte **AcerSystem korisnički vodič (AcerSystem User Guide)**. Priručnik sadrži detaljne informacije o temama kao što su uslužni programi sustava, vraćanje podataka, opcije za proširivanje i rješavanje problema. Nadalje, sadrži informacije o jamstvima i osnovne obavijesti o propisima i sigurnosti za vaš prijenosnik. On je dostupan u Portable Document Formatu (PDF) i dolazi prethodno učitani u vaš prijenosnik. Slijedite ove korake da biste mu pristupili:

- 1 Kliknite na  **Start > Svi programi > AcerSystem.**
- 2 Kliknite na **AcerSystem korisnički vodič (AcerSystem User Guide).**



.....









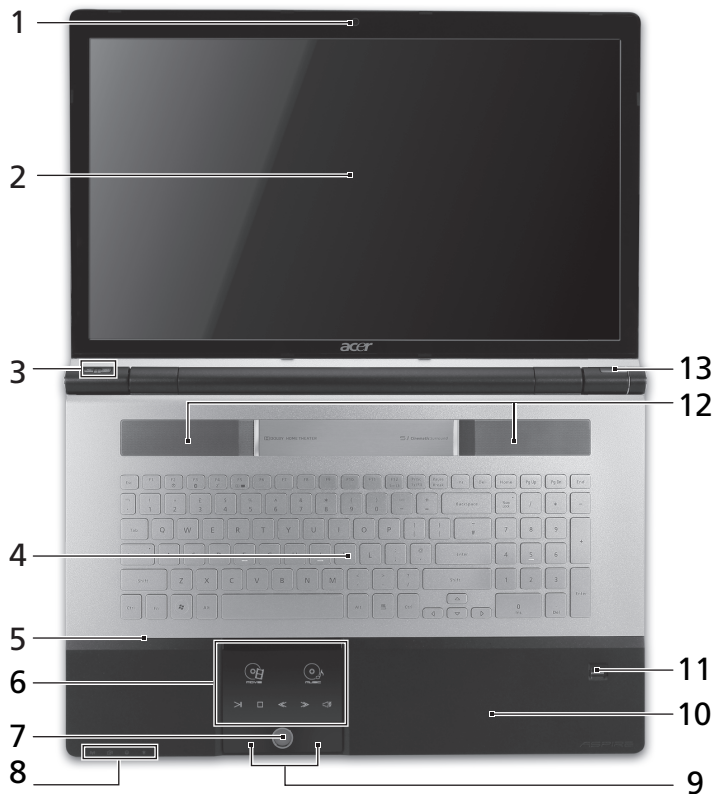













**Napomena:** Pregled dokumenta zahtijeva Adobe Reader. Ako Adobe Reader nije instaliran na vaše računalo, klik na **AcerSystem korisnički vodič (AcerSystem User Guide)** prvo će pokrenuti program za instalaciju Adobe Readera. Slijedite upute na zaslonu da biste završili instalaciju. Za upute kako koristiti Adobe Reader, pristupite izborniku **Pomoć i podrška.**





# Upoznajte Acer prijenosnik

Nakon postavljanja Vašeg računala kao što je ilustrirano na posteru **Za početak...**, upoznat ćemo vas s vašim novim Acer prijenosnikom.

## Pogled odozgo



#	Ikona	Stavka	Opis																					
1		Acer Crystal Eye web kamera	Web kamera za video komunikaciju (samo za određene modele).																					
2		Zaslon prikaza	Također nazivan i Liquid-Crystal Display (LCD), prikazuje izlaz računala (Konfiguracija se može razlikovati ovisno o modelu).																					
3		Arcade tipka	Pokreće uslužni program InstantOn Arcade.																					
	P	P tipka/Acer PowerSmart ključ	Programabilna tipka (konfiguracija se može razlikovati ovisno o modelu)./ Računalo pokreće rad s uštedom energije (konfiguracija se može razlikovati ovisno o modelu).																					
4		Tipkovnica	Za unos podataka u vaše računalo.																					
5		Mikrofon	Unutarnji mikrofon za snimanje zvuka.																					
6		Dodirna ploča/ medijska konzola	<p>Pokazivački uređaj osjetljiv na dodir koji funkcionira kao računalni miš*./ Tipke osjetljive na dodir za Acer Arcade, glasnoću (veća/manja) i medije (izvođenje/stanka, zaustavi, prethodni, sljedeći), s tipkom za utišavanje.</p> <table border="1"> <tbody> <tr> <td></td> <td>Film</td> <td>Pokreće softver za izvođenje filmova.</td> </tr> <tr> <td></td> <td>Glazba</td> <td>Pokreće softver za izvođenje glazbe.</td> </tr> <tr> <td></td> <td>Reprodukcija/ pauza</td> <td>Reproducira ili zaustavlja reprodukciju odabrane medijske datoteke.</td> </tr> <tr> <td></td> <td>Zaustavi</td> <td>Zaustavlja reprodukciju odabrane medijske datoteke.</td> </tr> <tr> <td></td> <td>Prethodno</td> <td>Povrat na prethodnu medijsku datoteku.</td> </tr> <tr> <td></td> <td>Sljedeća</td> <td>Skok na sljedeću medijsku datoteku.</td> </tr> <tr> <td></td> <td>Utišaj</td> <td>Uključuje ili isključuje zvuk.</td> </tr> </tbody> </table>		Film	Pokreće softver za izvođenje filmova.		Glazba	Pokreće softver za izvođenje glazbe.		Reprodukcija/ pauza	Reproducira ili zaustavlja reprodukciju odabrane medijske datoteke.		Zaustavi	Zaustavlja reprodukciju odabrane medijske datoteke.		Prethodno	Povrat na prethodnu medijsku datoteku.		Sljedeća	Skok na sljedeću medijsku datoteku.		Utišaj	Uključuje ili isključuje zvuk.
	Film	Pokreće softver za izvođenje filmova.																						
	Glazba	Pokreće softver za izvođenje glazbe.																						
	Reprodukcija/ pauza	Reproducira ili zaustavlja reprodukciju odabrane medijske datoteke.																						
	Zaustavi	Zaustavlja reprodukciju odabrane medijske datoteke.																						
	Prethodno	Povrat na prethodnu medijsku datoteku.																						
	Sljedeća	Skok na sljedeću medijsku datoteku.																						
	Utišaj	Uključuje ili isključuje zvuk.																						
* Kad je medijska konzola aktivna, dodirna ploča postaje neaktivna.																								









#	Ikona	Stavka	Opis
7		Upravljanje medijskom konzolom	Uključuje ili isključuje medijsku konzolu.
8		Tipka za komunikaciju	Omogućava/onemogućava komunikacijske uređaje računala. (Komunikacijski uređaji razlikuju se prema konfiguraciji.)
		Tipka za sigurnosnu kopiju	Pokreće Acer Backup Management za sigurnosno snimanje podataka u tri koraka.
		Indikator HDD <sup>1</sup>	Pokazuje kada je pogon tvrdog diska aktivan.
		Indikator napajanja <sup>1</sup>	Pokazuje stanje napajanja računala.
9		Tipke za klikanje (lijeva i desna)	Lijeva i desna tipka funkcionira kao lijeva i desna tipka miša.
10		Oslonac za dlanove	Udobno područje koje pruža potporu rukama dok koristite računalo.
11		Acer Bio-Protection čitač otiska prsta	Podržava Acer FingerNav 4-smjerne kontrolne funkcije (samo za određene modele).
12		Zvučnici	Omogućuju stereo audio izlaz.
13		Tipka napajanja	Uključuje i isključuje računalo.

1. Indikatori na prednjoj ploči su vidljivi čak i kada je poklopac računala zatvoren.

## Vruće tipke

Računalo koristi "vruće" tipke ili kombinacije tipki za pristup većini upravljačkih tipki računala, kao što je osvjetljenost zaslona i izlazna glasnoća.

Za aktiviranje „vruće“ tipke, pritisnite i držite <Fn> tipku prije pritiskanja druge tipke u kombinaciji "vrućih" tipki.

„Vruća“ tipka	Ikona	Funkcija	Opis
<Fn> + <F3>		Tipka za komunikaciju	Omogućava/onemogućava komunikacijske uređaje računala. (Komunikacijski uređaji razlikuju se prema konfiguraciji.)
<Fn> + <F4>		Stanje mirovanja	Stavlja računalo u stanja mirovanja.
<Fn> + <F5>		Prekidač prikaza	Prebacuje izlaz prikaza između zaslona prikaza, vanjskog monitora (ako je priključen) i oba.
<Fn> + <F6>		Prazan zaslon	Isključuje pozadinsko osvjetljenje zaslona prikaza radi uštede energije. Pritisnite bilo koju tipku za povrat.
<Fn> + <F7>		Prekidač touchpada	Uključuje i isključuje unutarnju dodirnu ploču.
<Fn> + <F8>		Prekidač zvučnika	Uključuje i isključuje zvučnike.
<Fn> + <▷>		Povećanje osvjetljenosti	Povećava osvjetljenost zaslona.
<Fn> + <◁>		Smanjivanje osvjetljenosti	Smanjuje osvjetljenost zaslona.
<Fn> + <Home>		Reprodukcija/pauza	Reproducira ili zaustavlja reprodukciju odabrane medijske datoteke.
<Fn> + <Pg Up>		Zaustavi	Zaustavlja reprodukciju odabrane medijske datoteke.
<Fn> + <Pg Dn>		Prethodno	Povrat na prethodnu medijsku datoteku.
<Fn> + <End>		Sljedeća	Skok na sljedeću medijsku datoteku.

## Pogled sprijeda izbliza



#	Ikona	Stavka	Opis
1		Kotačić za upravljanje glasnoćom	Pojačava ili stišava glasnoću zvuka.
2		Više-u-1 čitač kartica	Prihvaća Secure Digital (SD), MultiMediaCard (MMC), Memory Stick (MS), Memory Stick PRO (MS PRO), xD-Picture Card (xD) kartice. <b>Napomena:</b> Gurnite za uklanjanje/postavljanje kartice. Istodobno u pogonu možete koristiti samo jednu karticu.
3		CIR prijemnik	Prima signale iz daljinskog upravljača.



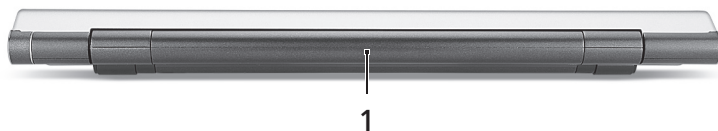



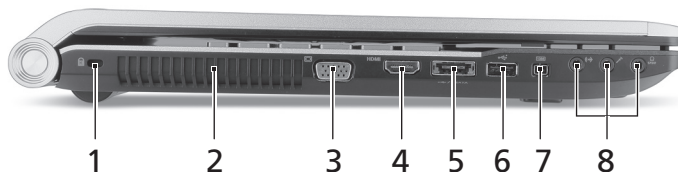

## Pogled straga

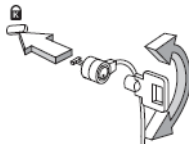

#	Ikona	Stavka	Opis
1		Prostor za bateriju	Sadrži baterijski komplet računala.





## Pogled s lijeve strane

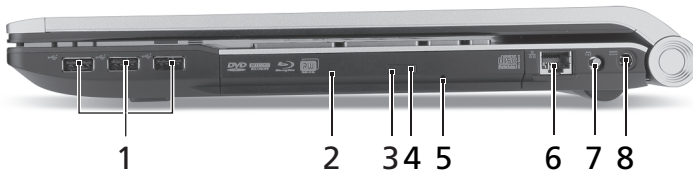

#	Ikona	Stavka	Opis
1		Utor za Kensington bravu 	Povezuje se s Kensington - kompatibilnom računalnom sigurnosnom bravom. <b>Napomena:</b> Omotajte kabel sigurnosne brave računala oko nepokretnog objekta kao što je stol ili ručka zaključane ladice. Umetnite bravu u utor i okrenite ključ kako bi osigurali bravu. Dostupni su i neki modeli bez ključa.
2		Utori za prozračivanje	Omogućavaju rashlađivanje računala i prilikom dugotrajne uporabe.
3		Priključak vanjskog ekrana (VGA)	Povezuje se s uređajem za prikaz (primjerice vanjskim monitorom, LCD projektorom).
4	HDMI	HDMI ulaz	Podržava veze digitalnog videa visoke definicije.
5		USB 2.0/eSATA priključak	Povezuje se s USB 2.0 ili eSATA uređajima (samo za određene modele). <b>Napomena:</b> Ukoliko priključite eSATA uređaj, imat ćete dostupna tri USB priključka.
6		USB 2.0 priključak	Povezuju se s USB 2.0 uređajima (npr. USB miš, USB kamera).
7		4-pinski IEEE 1394 priključak	Povezuje se sa IEEE 1394 uređajima.
8		Line-in utičnica	Prihvaća line-in audio uređaje (npr. audio CD svirač, stereo walkman, mp3 svirač).
		Utičnica ulaza za mikrofon	Prihvaća ulaze iz vanjskih mikrofona.
		Utičnica za slušalice/zvučnike/line-out sa S/PDIF podrškom	Povezuje se sa line-out audio uređajima (npr. zvučnicima, slušalicama).

## Pogled s desne strane







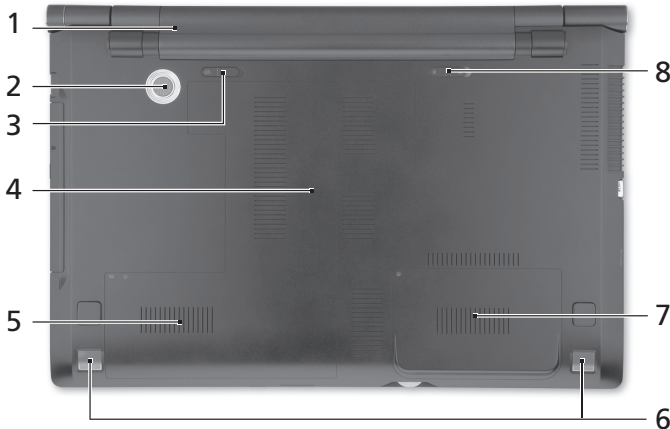

#	Ikona	Stavka	Opis
1		USB 2.0 priključci	Povezuje se s USB 2.0 uređajima (npr. USB miš, USB kamera).
2		Optički pogon	Unutarnji optički pogon; prihvaća CD-e ili DVD-e.
3		Indikator pristupa optičkom disku	Svijetli kada je optički pogon aktivan.
4		Gumb za izbacivanje optičkog pogona	Izbacuje optički disk iz pogona.
5		Otvor za izbacivanje u slučaju nužde	Izbacuje ladicu optičkog pogona kada je računalo isključeno. <b>Napomena:</b> Umetnite spajalicu za papir u otvor za izbacivanje u slučaju nužde kako bi izbacili ladicu optičkog pogona kada je računalo isključeno.
6		Ethernet (RJ-45) priključak	Povezuje se na Ethernet 10/100/1000-baziranu mrežu.
7		RF-in priključak	Prima ulazne signale s digitalnih TV prijemnika (samo za određene modele).
8		DC-in utičnica	Povezuje se s AC adapterom.



## Pogled odozdo



#	Ikona	Stavka	Opis
1		Prostor za bateriju	Sadrži baterijski komplet računala.
2		Sub woofer	Emitira izlaz zvuka niske frekvencije.
3		Bravica za oslobađanje baterije	Oslobađa bateriju radi uklanjanja.
4		Odjeljak za memoriju	Sadrži glavnu memoriju računala.
5		Prostor za čvrsti disk-glavni	Sadrži tvrdi disk računala (učvršćen vijcima).
6		Zvučnici	Omogućuju stereo audio izlaz.
7		Prostor za čvrsti disk-sekundarni	Sadrži tvrdi disk računala (učvršćen vijcima) (samo za određene modele).
8		Brava baterije	Zaključava bateriju u njen položaj.

## Okruženje

- Temperatura:
  - Radna: 5°C do 35°C
  - Pohrana: -20°C do 65°C
- Vlažnost (nekondenzirajuća):
  - Radna: 20% do 80%
  - Pohrana: 20% do 80%



# Computer portabil Acer

Ghid rapid

© 2010 Toate drepturile rezervate.

Ghid rapid al computerului portabil Acer

Prima ediție: 03/2010

Numărul modelului: \_\_\_\_\_

Numărul seriei: \_\_\_\_\_

Data achiziției: \_\_\_\_\_

Locul achiziției: \_\_\_\_\_

# Înainte de toate

Dorim să vă mulțumim pentru că ați ales un computer portabil Acer pentru a răspunde nevoilor dvs privind un computer mobil.

## Ghidurile dumneavoastră

Pentru a vă ajuta să folosiți computerul portabil Acer, am conceput un set de ghiduri:

Primul dintre acestea, posterul **Doar pentru începători...** vă ajută să porniți cu configurarea computerului.

**Ghidul general de utilizare pentru seria Aspire** conține informații utile valabile pentru toate modelele din gama Aspire. Acoperă subiecte cum ar fi folosirea tastaturii, a sistemului audio etc. Vă rugăm să rețineți că **Ghidul general de utilizare**, precum și **Ghidul utilizatorului AcerSystem (AcerSystem User Guide)** menționat mai jos au fost concepute de așa natură încât să se refere ocazional la funcții sau caracteristici care sunt incluse doar în anumite modele ale seriei și nu neapărat în modelul cumpărat de dumneavoastră. Astfel de cazuri sunt marcate în manuale prin texte cum ar fi "doar pentru anumite modele".

**Ghid rapid** vă prezintă caracteristicile și funcțiile de bază ale noului dvs. computer. Pentru mai multe informații privind modul în care computerul vă poate ajuta să fiți mai productiv, consultați **Ghidul utilizatorului AcerSystem (AcerSystem User Guide)**. Acest ghid conține informații detaliate despre astfel de subiecte, precum utilizările de sistem, recuperarea datelor, opțiunile de extensie și depanarea. În plus, acesta conține informații despre garanție, reglementări generale și note de siguranță pentru computerul dvs portabil. Este disponibil în Format de document portabil (PDF) și vine preîncărcat pe computerul dvs. portabil. Urmați acești pași pentru a-l accesa:

- 1 Faceți clic pe  **Pornire > Toate programele > AcerSystem.**
- 2 Faceți clic pe **Ghidul utilizatorului AcerSystem (AcerSystem User Guide).**



.....









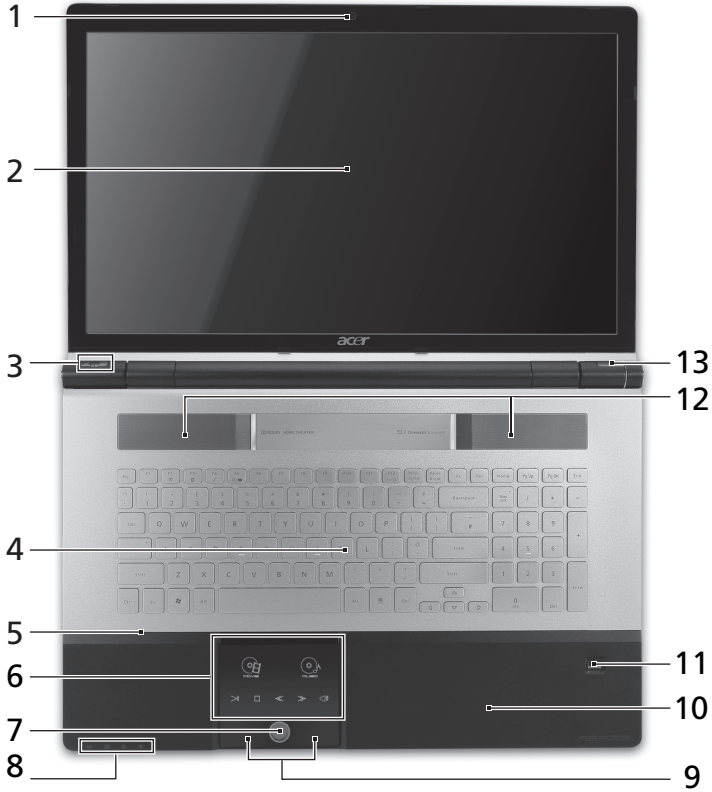

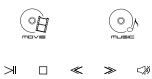











**Notă:** Vizualizarea fișierului necesită Adobe Reader. Dacă Adobe Reader nu este instalat pe computerul dvs., faceți clic pe **Ghidul utilizatorului AcerSystem (AcerSystem User Guide)** și se va executa mai întâi programul de configurare Adobe Reader. Urmați instrucțiunile de pe ecran pentru a încheia instalarea. Pentru instrucțiuni privind modul de utilizare a Adobe Reader, accesați meniul **Ajutor și asistență**.





# Turul computerului dvs Acer

După configurarea computerului așa cum se arată în afișul **Numai pentru începători...**, permiteți-ne să vă prezentăm noul dvs. computer portabil Acer.

## Vedere de sus



#	Pictogramă	Element	Descriere																					
1		Cameră web Acer Crystal Eye	Cameră Web pentru comunicație video (doar pentru anumite modele).																					
2		Ecraan de afișaj	Mai este numit și Afișaj cu cristale lichide (LCD) și afișează activitatea computerului (Configurația poate diferi în funcție de model).																					
3		Tastă Arcade	Lansează InstantOn Arcade.																					
	P	Tastă p/Tasta Acer PowerSmart	Tastă programabilă (configurația poate diferi în funcție de model)./ Activează modul de economisire a energiei (configurația poate diferi în funcție de model).																					
4		Tastatură	Pentru introducerea datelor în computer.																					
5		Microfon	Microfon intern pentru înregistrarea sunetului.																					
6		Zonă de atingere/ consolă media	<p>Dispozitiv de indicare sensibil la atingere care funcționează ca un maus de computer*/ Comenzi tactile pentru Acer Arcade, volum (sus/jos) și multimedia (redare/pauză, stop, anterior, următor), cu tastă de oprire a sunetului.</p> <table border="1"> <tbody> <tr> <td></td> <td>Film</td> <td>Lansați software-ul de redare a filmelor.</td> </tr> <tr> <td></td> <td>Muzică</td> <td>Lansați software-ul de redare a fișierelor audio.</td> </tr> <tr> <td></td> <td>Redare/ pauză</td> <td>Redă sau oprește temporar fișierul media selectat.</td> </tr> <tr> <td></td> <td>Oprire</td> <td>Oprește redarea fișierului media selectat.</td> </tr> <tr> <td></td> <td>Anterior</td> <td>Revine la fișierul media anterior.</td> </tr> <tr> <td></td> <td>Următorul</td> <td>Trece la următorul fișier media.</td> </tr> <tr> <td></td> <td>Fără sunet</td> <td>Activează sau dezactivează sonorul.</td> </tr> </tbody> </table> <p>* Zona de atingere se inactivează în momentul activării Consolei media.</p>		Film	Lansați software-ul de redare a filmelor.		Muzică	Lansați software-ul de redare a fișierelor audio.		Redare/ pauză	Redă sau oprește temporar fișierul media selectat.		Oprire	Oprește redarea fișierului media selectat.		Anterior	Revine la fișierul media anterior.		Următorul	Trece la următorul fișier media.		Fără sunet	Activează sau dezactivează sonorul.
	Film	Lansați software-ul de redare a filmelor.																						
	Muzică	Lansați software-ul de redare a fișierelor audio.																						
	Redare/ pauză	Redă sau oprește temporar fișierul media selectat.																						
	Oprire	Oprește redarea fișierului media selectat.																						
	Anterior	Revine la fișierul media anterior.																						
	Următorul	Trece la următorul fișier media.																						
	Fără sunet	Activează sau dezactivează sonorul.																						
7		Controler Consolă media	Activează sau dezactivează Consola media.																					

#	Pictogramă	Element	Descriere
8		Tastă pentru comunicații	Activează/dezactivează dispozitivele de comunicație ale computerului. (Dispozitivele de comunicație pot diferi în funcție de model).
		Tastă pentru copie de siguranță	Lansează aplicația Acer Backup Management pentru efectuarea în trei etape a unei copii de siguranță a datelor.
		Indicator HDD <sup>1</sup>	Indică atunci când unitatea de harddisc este activă.
		Indicator de alimentare <sup>1</sup>	Indică nivelul de alimentare al computerului.
9		Butoane clic (stânga și dreapta)	Butoanele stânga și dreapta funcționează ca butoanele stânga și dreapta ale mousei.
10		Placă pentru sprijinirea palmei	Zonă confortabilă de sprijin pentru mână atunci când folosiți computerul.
11		Cititor de amprente Acer Bio-Protection	Acceptă funcția de control cu 4 căi Acer FingerNav (doar pentru anumite modele).
12		Difuzoare	Oferă ieșire audio stereo.
13		Buton Pornire	Pornește și oprește computerul.













1. Indicatoarele de pe panoul frontal sunt vizibile chiar și când capacul computerului este închis.



## Taste rapide

Computerul folosește tastele rapide sau combinațiile de taste pentru a accesa majoritatea comenzilor precum luminozitatea ecranului și volumul.

Pentru a activa tastele rapide, apăsați și mențineți tasta <Fn> înainte de a apăsa cealaltă tastă din combinația de tastă rapidă.

Tastă rapidă	Pictogramă	Funcție	Descriere
<Fn> + <F3>		Tastă pentru comunicații	Activează/dezactivează dispozitivele de comunicație ale computerului. (Dispozitivele de comunicație pot diferi în funcție de model.)
<Fn> + <F4>		Repaus	Pune computerul în modul Repaus.
<Fn> + <F5>		Comutare afișaj	Comută afișajul între ecran de afișaj, monitor extern (dacă este conectat) și ambele.
<Fn> + <F6>		Ecran gol	Oprește lumina de fundal a ecranului pentru a economisi energie. Apăsați orice tastă pentru reveni.
<Fn> + <F7>		Comutare zonă de atingere	Activează și dezactivează zona de atingere.
<Fn> + <F8>		Comutare difuzor	Pornește și oprește difuzoarele.
<Fn> + <▷>		Luminozitate mărită	Mărește luminozitatea afișajului.
<Fn> + <◁>		Luminozitate scăzută	Reduce luminozitatea afișajului.
<Fn> + <Home>		Redare/Pauză	Redă sau oprește temporar fișierul media selectat.
<Fn> + <Pg Up>		Oprire	Oprește redarea fișierului media selectat.
<Fn> + <Pg Dn>		Anterior	Revine la fișierul media anterior.
<Fn> + <End>		Următorul	Trece la următorul fișier media.

## Vedere din față de aproape



#	Pictogramă	Element	Descriere
1		Rotiță thumbwheel	Mărește sau micșorează volumul.
2		Cititor de cartele multi-in-1	Acceptă carduri Secure Digital (SD), MultiMediaCard (MMC), Memory Stick (MS), Memory Stick PRO (MS PRO) și xD-Picture Card. <b>Notă:</b> Apăsați pentru a extrage/a instala cardul. Nu poate fi citit decât un singur card o dată.
3		Receptor CIR	Primește semnale de la o telecomandă.



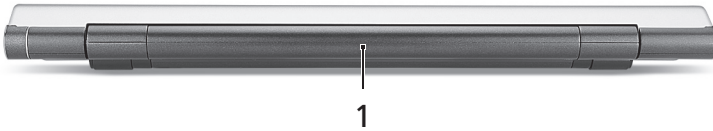



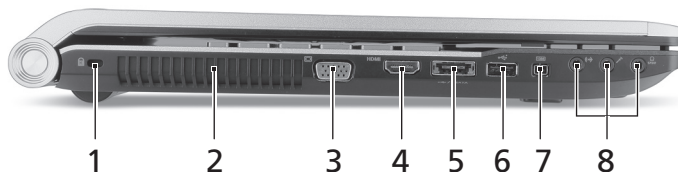

## Vedere din spate



#	Pictogramă	Element	Descriere
1		Nișa pentru acumulator	Adăpostește setul de acumulatori ai computerului.





## Vedere din stânga

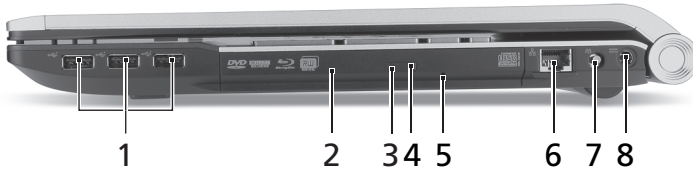

#	Pictogramă	Element	Descriere
1		Slot de blocare Kensington	Conectează la un dispozitiv de securitate pentru computer compatibil Kensington. <b>Notă:</b> Înfășurați cablul blocajului de securitate al computerului în jurul unui obiect fix precum o masă sau un mâner al unui sertar încuiat. Introduceți blocajul în zăvor și răsuciți cheia pentru a fixa blocajul. Sunt disponibile și unele modele fără chei.
2		Orificii de aerisire	Permit computerului să rămână rece, chiar și după utilizarea prelungită.
3		Port pentru afișaj extern (VGA)	Conectează la un dispozitiv de afișare (de ex. monitor extern sau proiector LCD).
4	HDMI	Port HDMI	Acceptă conexiuni video digitale de înaltă definiție.
5		Port USB 2.0/eSATA	Conectează la dispozitivele USB 2.0 sau eSATA (doar pentru anumite modele). <b>Notă:</b> În cazul în care conectați un dispozitiv eSATA, veți avea la dispoziție în același timp și trei porturi USB.
6		Port USB 2.0	Conectează la dispozitivele USB 2.0 (de ex. mouse USB, cameră USB).
7		Port IEEE 1394 cu 4 pini	Permite conectarea la dispozitive IEEE 1394.
8		Conector de linie	Acceptă dispozitive audio în linie (de ex. unitate de redare CD, walkman stereo, unitate de redare mp3).
		Mufă intrare microfon	Acceptă intrări de la microfoane externe.
		Port de căști/difuzor/mufă de ieșire cu suport S/PDIF	Conectează la dispozitivele audio de ieșire (de ex. difuzoare, căști).







## Vedere din dreapta



#	Pictogramă	Element	Descriere
1		Porturi USB 2.0	Conectează la dispozitivele USB 2.0 (de ex. mouse USB, cameră USB).
2		Unitate optică	Unitate optică internă, acceptă CD-uri sau DVD-uri.
3		Indicator de acces la discul optic	Se aprinde când unitatea optică este activă.
4		Buton de eliminare unitate optică	Elimină discul optic din unitate.
5		Orificiu de eliminare de urgență	Elimină tava unității optice când computerul este oprit. <b>Notă:</b> Introduceți o bucată de hârtie în orificiul de eliminare de urgență pentru a elimina tava unității optice când computerul este oprit.
6		Port Ethernet (RJ-45)	Conectează la o rețea Ethernet 10/100/1000.
7		Port intrare RF	Acceptă semnale de intrare de la dispozitivele digitale tuner TV (doar pentru anumite modele).
8		Mufă c.c. intrare	Conectează la un adaptor de c.a.

## Vedere bază



#	Pictogramă	Element	Descriere
1		Nișă pentru acumulator	Adăpostește setul de acumulatori ai computerului.
2		Difuzor de frecvențe joase	Emite ieșire de sunet de frecvență joasă.
3		Zăvor de eliberare a acumulatorului	Eliberează acumulatorul pentru a fi scos.
4		Compartiment de memorie	Adăpostește memoria principală a computerului.
5		Bay principal harddisc	Adăpostește unitatea harddisc a computerului (fixată cu șuruburi).
6		Difuzoare	Oferă ieșire audio stereo.
7		Bay secundar harddisc	Adăpostește unitatea de harddisc a computerului (fixată cu șuruburi) (doar pentru anumite modele).
8		Blocaj acumulator	Blochează acumulatorul în poziție.

## Mediu

---

- Temperatură:
    - Funcționare: 5°C - 35°C
    - Nefuncționare: -20°C - 65°C
  - Umiditate (fără condensare):
    - Funcționare: 20% - 80%
    - Nefuncționare: 20% - 80%
-

# Асер ноутбук

Кратко ръководство

© 2010 Всички права запазени.

Ръководство за бърз старт за Асег ноутбук  
Първоначално издание: 03/2010

Модел номер: \_\_\_\_\_

Сериен номер: \_\_\_\_\_

Дата на закупуване: \_\_\_\_\_

Място на закупуване: \_\_\_\_\_



# Преди всичко

Бихме желали да ви благодарим, че сте избрали ноутбук на Асер за вашите нужди в областта на мобилните компютри.

## Вашите ръководства

За да ви помогнем при употребата на вашия ноутбук Асер, ние изготвихме следните ръководства:

Първо, постерът **Като за начало...** ви помага с началните настройки на компютъра ви.

**Универсалното потребителско ръководство за серията *Aspire*** съдържа полезна информация, валидна за всички модели от продуктовата серия *Aspire*. Покрива основни теми като използване на клавиатурата, аудио и др. Важно е да знаете, че поради обожаващия си характер, **Универсалното потребителско ръководство**, както и упоменатото по-долу **Потребителско ръководство *AcerSystem* (*AcerSystem User Guide*)**, на места разглеждат функции и възможности, които са налични само за конкретни модели от сериите, без това да означава, че са налични за модела, който сте закупили. Тези случаи са отбелязани в текста със забележки като „само за някои модели“.

**Кратко ръководство** ви представя основните функции и възможности на новия ви компютър. За повече информация как вашият компютър може да ви помогне да сте по-продуктивни, моля вижте **Потребителското ръководство *AcerSystem* (*AcerSystem User Guide*)**. То съдържа подробна информация за теми като системни инструменти, възстановяване на данни, опции за ъпгрейд и решаване на проблеми. В допълнение, то съдържа и гаранционна информация, както и основните регулации и бележки за безопасност, свързани с вашия ноутбук. То е в PDF формат (Portable Document Format) и е предварително заредено на ноутбука ви. За да го отворите, следвайте тези стъпки:

- 1 Кликнете  **Старт > Всички програми > *AcerSystem***.
- 2 Кликнете **Потребителско ръководство *AcerSystem* (*AcerSystem User Guide*)**.



-----

**Бележка:** За да отворите файла ви е нужен Adobe Reader. Ако Adobe Reader не е инсталиран на компютъра ви, когато кликнете върху **Потребителско ръководство *AcerSystem* (*AcerSystem User Guide*)**, ще се стартира инсталационната програма на Adobe Reader. Следвайте инструкциите на екрана, за да извършите инсталацията. За инструкции как се използва Adobe Reader, отворете менюто **Help and Support**.





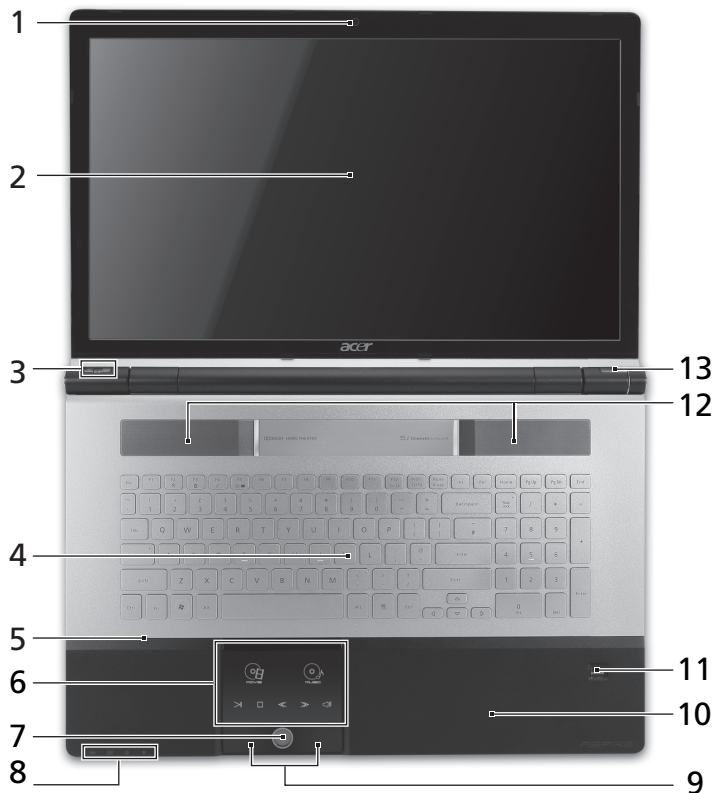

# Преглед на Вашия ноутбук Асер





След като настроите компютъра си, както е показано в постера **Като за начало...**, ще Ви запознаем с Вашия нов ноутбук Асер.

## Изглед отгоре



#	Икона	Обект	Описание
1		Уеб камера Acer Crystal Eye	Уеб камера за видео комуникация (само за някои модели).
2		Дисплей	Нарича се още "Течнокристален дисплей" (LCD) и е екранът на компютъра (конфигурацията може да се различава в зависимост от моделите).

#	Икона	Обект	Описание
3		Бутон "Arcade"	Стартира InstantOn Arcade.
	P	P клавиш/ Acer PowerSmart бутон	Програмируем клавиш (конфигурацията може да се различава в зависимост от модела)./ Включва икономичен режим за компютъра (конфигурацията може да се различава в зависимост от модела).
4		Клавиатура	Служи за въвеждане на данни в компютъра Ви.
5		Микрофон	Вътрешен микрофон за запис на звук.
6	  K □ < > << >>	Тъчпад/ мултимедийна конзола	Чувствително на допир посочващо устройство, което функционира като компютърна мишка*. / Чувствителни на допир бутони за Acer Arcade, сила на звука (увеличаване/намаляване) и мултимедия (възпроизвеждане/пауза, стоп, назад, напред); функция без звук.
		Филм	Стартира софтуер за възпроизвеждане на филми.
		Музика	Стартира софтуер за възпроизвеждане на музика.
	>	Възпроизвеждане/ Пауза	Възпроизвеждане или пауза за избрания мултимедийен файл.
	□	Стой	Спира възпроизвеждането на избрания мултимедийен файл.
	<<	Предишен	Връщане към предишен мултимедийен файл.
	>>	Напред	Прескачане до следващия мултимедийен файл.
		Без звук	Включва или изключва звука.
* Тъчпадът става неактивен когато мултимедийната конзола е активна.			

#	Икона	Обект	Описание
7		Контроли на мултимедийната конзола	Включване или изключване на мултимедийната конзола.
8		Клавиш за комуникации	Включва/изключва комуникационните устройства на компютъра. (Устройствата за комуникация може да варират според конфигурацията.)
		Бутон за архивиране	Стартира Acer Backup Management за архивиране на данни в три стъпки.
		Индикатор на твърдия диск <sup>1</sup>	Посочва дали твърдият диск е активен.
		Индикатор на захранването <sup>1</sup>	Показва статуса на захранване на компютъра.
9		Бутони за щракане (ляв и десен)	Левият и десният бутони функционират като ляв и десен бутон на мишка.
10		Подложка за длани	Удобно място, на което да поставите ръцете си, когато използвате компютъра.
11		Асер Bio-Protection четец на пръстов отпечатък	Поддържа четирипосочна функция за управление Acer FingerNav (само за някои модели).
12		Високоговорители	За изходен стерео аудио сигнал.
13		Бутон за вкл./изкл.	С него компютърът се включва и изключва.

1. Индикаторите на предния панел остават видими дори когато капакът на компютъра е затворен.

## Бързи клавиши

Компютърът има "бързи клавиши" - клавишни комбинации за бърз достъп до повечето от контролите му, като например яркост на дисплея и сила на звук.

За да активирате бързите клавиши, натиснете и задръжте клавиша <Fn> преди да натиснете другия клавиш от комбинацията.

Бърз клавиш	Икона	Функция	Описание
<Fn> + <F3>		Клавиш за комуникации	Включва/изключва комуникационните устройства на компютъра. (Устройствата за комуникация може да варират според конфигурацията.)
<Fn> + <F4>		Заспиване	Вкарва компютъра в режим Sleep (Заспиване).
<Fn> + <F5>		Превключване на дисплей	Превключва активния дисплей между екрана, външния монитор (ако е свързан такъв), или и двете.
<Fn> + <F6>		Затъмняване на екрана	Изключва задното осветление на екрана, за да пести енергия. Натиснете който и да е клавиш, за да го включите отново.
<Fn> + <F7>		Превключване на тъчпада	Включва и изключва вътрешния тъчпад.
<Fn> + <F8>		Превключване на високоговорителите	Включва и изключва високоговорителите.
<Fn> + <D>		Засилване на яркостта	Увеличава яркостта на екрана.
<Fn> + <D>		Намаляване на яркостта	Намалява яркостта на екрана.
<Fn> + <Home>		Възпроизвеждане/ Пауза	Възпроизвеждане или пауза за избрания мултимедиен файл.
<Fn> + <Pg Up>		Стой	Спира възпроизвеждането на избрания мултимедиен файл.
<Fn> + <Pg Dn>		Предишен	Връщане към предишен мултимедиен файл.
<Fn> + <End>		Напред	Прескачане до следващия мултимедиен файл.

## Преден изглед при затворен лаптоп



#	Икона	Обект	Описание
1		Колелце	За увеличаване или намаляване на силата на звука.
2		Четец на карти Много-в-1	Чете Secure Digital (SD), MultiMediaCard (MMC), Memory Stick (MS), Memory Stick PRO (MS PRO) и xD Picture Card (xD). <b>Забележка:</b> Натиснете, за да извадите/ деинсталирате картата. Само една карта може да работи едновременно.
3		CIR приемник	Получава сигналите от дистанционно управление.



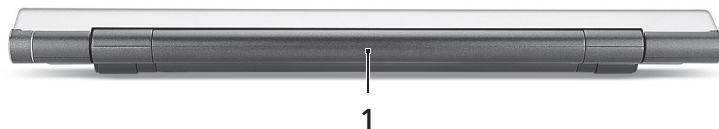



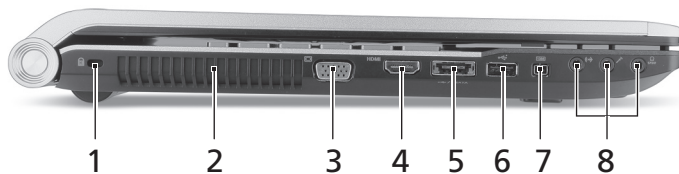

## Изглед отзад



#	Икона	Обект	Описание
1		Отделение за батерии	Тук се поставя батерийният модул на компютъра.





## Изглед отляво

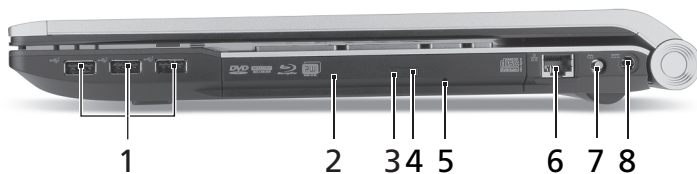

#	Икона	Обект	Описание
1		Слот за заключващ механизъм Kensington	За връзка с Kensington-съвместим компютърен заключващ механизъм. <b>Забележка:</b> Увийте осигурителния кабел около неподвижен обект като закрепена за пода маса или дръжката на заключено чекмедже. Поставете ключалката в жлеба и завъртете ключа, за да я заключите. Има и някои модели без ключове.
2		Вентилационни отвори	Позволява на компютъра да се охлажда дори и при продължителна употреба.
3		Порт за външен дисплей (VGA)	За връзка с дисплейно устройство (напр. външен монитор, LCD проектор).
4	HDMI	HDMI порт	Поддържа цифрови видео връзки с висока разделителна способност.
5	 /e SATA	USB 2.0/eSATA порт	За свързване на USB 2.0 или eSATA устройства (само за някои модели). <b>Забележка:</b> Ако свържете устройство eSATA, едновременно с това ще имате налични три USB порта.
6		USB 2.0 порт	За връзка с USB 2.0 устройства (напр. USB мишки, USB камери).
7		4-пинов IEEE 1394 порт	За свързване на IEEE 1394 устройства.
8		Жак за звуков вход	Приема вход от звукови устройства (напр. аудио CD плейър, стерео уокмен, mp3 плейър).
		Жак за вход за микрофон	Приема входящ сигнал от външни микрофони.
		Жак за слушалки/колони/изход с поддръжка на S/PDIF	За връзка с изходни аудио устройства (напр. високоговорители, слушалки).

## Изглед отдясно









#	Икона	Обект	Описание
1		USB 2.0 портове	За връзка с USB 2.0 устройства (напр. USB мишки, USB камери).
2		Оптично устройство	Вътрешно оптично устройство; чете CD или DVD.
3		Индикатор за достъп до оптичен диск	Светва, когато оптичното устройство е активно.
4		Бутон за отваряне на оптичното устройство	Изважда оптичния диск от устройството.
5		Дупка за спешно изваждане	Вади оптичния диск, когато компютърът е изключен. <b>Забележка:</b> Пъхнете кламер в отвора за спешно изваждане, за да извадите подноса на оптичното устройство, докато компютърът е изключен.
6		Порт за Ethernet (RJ-45)	За връзка с мрежа, базирана на Ethernet 10/100/1000.
7		RF-in порт	Приема входни сигнали от цифрови ТВ тунер устройства (само за някои модели).
8		Жак за DC вход	За връзка с AC адаптер.



## Изглед отдолу



#	Икона	Обект	Описание
1		Отделение за батерии	Тук се поставя батерийният модул на компютъра.
2		Събуфер	Излъчва нискочестотни звукове.
3		Езиче за освобождаване на батерията	Освобождава батерията, за да можете да я извадите.
4		Отделение за памет	Тук се поставя главната памет на компютъра.
5		Отделение за твърдия диск - главно	Тук се намира твърдият диск на компютъра (прикрепен с винтове).
6		Високоговорители	За изходен стерео аудио сигнал.
7		Отделение за твърдия диск - второстепенно	Тук стои твърдият диск на компютъра (прикрепен с винтове) (само за някои модели).
8		Придържач механизъм на батерията	Държа батерията на мястото ѝ.

## Работна среда

---

- Температура:
    - Работна: От 5°C до 35°C
    - За съхранение: От -20°C до 65°C
  - Влажност (без кондензация):
    - Работна: От 20% до 80%
    - За съхранение: От 20% до 80%
-

# Aceri sülearvuti

Lühijuhend

© 2010 Kõik õigused kaitstud.

Aceri sülearvuti lühijuhend  
Originaalväljaanne: 03/2010

Mudeli number: \_\_\_\_\_

Seerianumber: \_\_\_\_\_

Ostukuupäev: \_\_\_\_\_

Ostukoht: \_\_\_\_\_

# Kõigepealt tähtsamad asjad

Täname Teid selle eest, et valisite oma kaasaskantavaks arvutiks Acer'i sülearvuti.

## Teie teejuhid

Et aidata Teil kasutada oma Acer'i sülearvutit, oleme loonud komplekti juhiseid:

Kõigepealt aitab poster **Alustuseks...** Teil alustada oma arvuti häälestamist.

**Aspire seeria üldkasutusjuhend** sisaldab kõigile Aspire tooteseeria mudelitele kohalduvat kasulikku teavet. See katab põhilisi teemasid nagu klaviatuuri kasutamine, heli jne. Palume mõista, et tulenevalt nende loomusest viitavad nii **Üldkasutusjuhend** kui ka allpool mainitud **AcerSystemi kasutaja teatmik (AcerSystem User Guide)** aeg-ajalt funktsioonidele või omadustele, mis on ainult teatud seeria mudelitel, kuid mitte tingimata teie ostetud mudelil. Sellised juhtumid on tekstis märgitud väljenditega nagu „ainult teatud mudelitel“.

**Lühijuhend** tutvustab Teile uue arvuti põhilisi omadusi ja funktsioone. Kui soovite saada rohkem teada sellest, kuidas arvuti Teil aitab produktiivsem olla, vaadake **AcerSystemi kasutaja teatmik (AcerSystem User Guide)**. Teatmik sisaldab täpsemat informatsiooni teemadel nagu süsteemiütiilidid, andmete taastamine, laiendusvõimalused ja probleemide lahendamine. Sellele lisaks sisaldab see garantiinformatsiooni ning sülearvuti kohta kehtivaid üldiseid regulatsioone ja ohutuseeskirju. See on saadaval PDF-formaadis (Portable Document Format) ning on laetud Teie sülearvutisse. Juhised selle avamiseks:

- 1 Klõpsake ja avage  **Start > Kõik programmid > AcerSystem.**
- 2 Klõpsake real **AcerSystemi kasutaja teatmik (AcerSystem User Guide)**.



-----









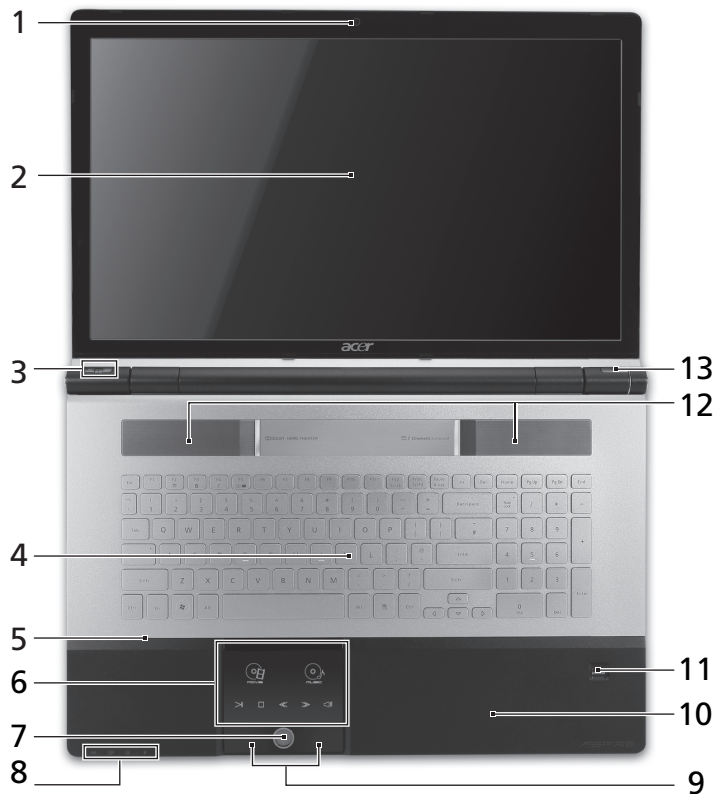

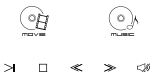











**Märkus:** Faili vaatamiseks on vaja Adobe Reader'it. Kui Adobe Reader pole arvutisse installeeritud, käivitab **AcerSystemi kasutaja teatmik (AcerSystem User Guide)** 'ile kõigepealt Adobe Reader'i installeerimisprogrammi. Installeerimise lõpetamiseks järgige ekraanil olevaid juhiseid. Juhiseid Adobe Reader'i kasutamiseks leiate menüüst **Spikker ja tugi**.





# Teie Acer sülearvuti ülevaade

Kui olete oma arvuti häälestanud postril **Alustuseks...** kujutatud viisil, lubage meil teile tutvustada teie uut Acer sülearvutit.

## Pealtvaade



#	Ikoon	Objekt	Kirjeldus																					
1		Acer Crystal Eye veebikaamera	Veebikaamera videosuhtluseks (ainult teatud mudelitel).																					
2		Kuvariekraan	Seda nimetatakse ka vedelkristallekraaniks (LCD) ning see kuvab arvuti pilti (mudelite konfiguratsioon võib olla erinev).																					
3		Arcade'i klahv	Käivitab rakenduse InstantOn Arcade.																					
	P	Klahv P/Acer'i PowerSmart-klahv	Seadistatav klahv (mudeli konfiguratsioon võib erineda)./ Lülitab arvuti energiasäästurežiimile (mudeli konfiguratsioon võib erineda).																					
4		Klaviatuur	Andmete sisestamiseks arvutisse.																					
5		Mikrofon	Sisseehitatud mikrofon heli salvestamiseks.																					
6		Puuteplaat/ meediumikonsool	<p>Puutetundlik osutusseadis, mis töötab arvutihiirena*/ Puutetundlikud Acer Arcade'i juhtnupud, helitugevus (üles/all) ja meediumid (esita/paus, stopp, eelmine, järgmine); vaigistusklahv.</p> <table border="1"> <tbody> <tr> <td></td> <td>Movie (Filmid)</td> <td>Filmide taasesitamise tarkvara käivitamine.</td> </tr> <tr> <td></td> <td>Music (Muusika)</td> <td>Muusika taasesitamise tarkvara käivitamine.</td> </tr> <tr> <td></td> <td>Esita/paus</td> <td>Esitab või peatab valitud meediumifaili.</td> </tr> <tr> <td></td> <td>Lõpeta</td> <td>Lõpetab valitud meediumifaili esitamise.</td> </tr> <tr> <td></td> <td>Eelmine</td> <td>Pöördu tagasi eelmise meediumifaili juurde.</td> </tr> <tr> <td></td> <td>Järgmine</td> <td>Liigub edasi järgmise meediumifaili juurde.</td> </tr> <tr> <td></td> <td>Vaigista</td> <td>Heli sisse või väljalülitamine.</td> </tr> </tbody> </table> <p>* Kui meediumikonsool on aktiivne, muutub puuteplaat inaktiivseks.</p>		Movie (Filmid)	Filmide taasesitamise tarkvara käivitamine.		Music (Muusika)	Muusika taasesitamise tarkvara käivitamine.		Esita/paus	Esitab või peatab valitud meediumifaili.		Lõpeta	Lõpetab valitud meediumifaili esitamise.		Eelmine	Pöördu tagasi eelmise meediumifaili juurde.		Järgmine	Liigub edasi järgmise meediumifaili juurde.		Vaigista	Heli sisse või väljalülitamine.
	Movie (Filmid)	Filmide taasesitamise tarkvara käivitamine.																						
	Music (Muusika)	Muusika taasesitamise tarkvara käivitamine.																						
	Esita/paus	Esitab või peatab valitud meediumifaili.																						
	Lõpeta	Lõpetab valitud meediumifaili esitamise.																						
	Eelmine	Pöördu tagasi eelmise meediumifaili juurde.																						
	Järgmine	Liigub edasi järgmise meediumifaili juurde.																						
	Vaigista	Heli sisse või väljalülitamine.																						
7		Meediumikonsooli kontrollid	Lülitab meediumikonsooli sisse või välja.																					

#	Icoon	Objekt	Kirjeldus
8		Sideklahv	Aktiveerib/desaktiveerib arvuti sideseadmed. (Sideseadmed võivad vastavalt konfiguratsioonile erineda.)
		Varuvõti	Käivitatakse Acer Backup Management andmete varundamiseks kolmes etapis.
		Kõvakettaindikaator <sup>1</sup>	Näitab kõvaketta aktiivsust.
		Vooluindikaator <sup>1</sup>	Näitab arvuti olekut.
9		Klõpsunupud (vasak ja parem)	Vasak ja parem nupp funktsioneerivad vasaku ja parema hiirenupuna.
10		Randmetugi	Mugav toetusala, kuhu saate arvutit kasutades toetada oma käsi.
11		Acer Bio-Protection sõrmejäljelugeja	Toetab Aceri neljasuunalist FingerNav juhtfunktsiooni (ainult teatud mudelitel).
12		Kõlarid	Toodavad stereoheli.
13		Voolunupp	Arvuti sisse- ja väljalülitamiseks.













1. Esipaneelil asuvad indikaatorid on nähtavad ka siis, kui arvuti kaas on suletud.



## Kiirklahvid





Arvutil on enamiku seadete jaoks (nt ekraani heledus, heliväljund) olemas kiirklahvid ja klahvikombinatsioonid.

Kiirklahvide aktiveerimiseks vajutage ning hoidke enne teise kombinatsiooni kuuluva klahvi vajutamist all klahvi <Fn>.

Kiirklahv	Icoon	Funktsioon	Kirjeldus
<Fn> + <F3>		Sideklahv	Aktiveerib/desaktiveerib arvuti sideseadmed. (Sideseadmed võivad vastavalt konfiguratsioonile erineda.)
<Fn> + <F4>		Unerežiim	Lülitab arvuti unerežiimi.
<Fn> + <F5>		Ekraani valik	Lülitab ekraanipildi kuvaekraanile, välisele ekraanile (kui see on ühendatud) või mõlemale.
<Fn> + <F6>		Tühi ekraan	Lülitab ekraani tagantvalgustuse energia säästmiseks välja. Tagasipöördumiseks vajutage suvalisele klahvile.
<Fn> + <F7>		Puuteplaadi lüliti	Lülitab integreeritud puuteplaadi sisse või välja.
<Fn> + <F8>		Kõlarilüliti	Lülitab kõlarid sisse või välja.
<Fn> + <▷>		Heledus üles	Suurendab ekraani heledust.
<Fn> + <◁>		Heledus alla	Vähendab ekraani heledust.
<Fn> + <Home>		Esita/paus	Esitab või peatab valitud meediumifaili.
<Fn> + <Pg Up>		Lõpeta	Lõpetab valitud meediumifaili esitamise.
<Fn> + <Pg Dn>		Eelmine	Pöördub tagasi eelmise meediumifaili juurde.
<Fn> + <End>		Järgmine	Liigub edasi järgmise meediumifaili juurde.

## Suletud eestvaade



#	Ikoon	Objekt	Kirjeldus
1		Ketasnupp	Helitugevuse suurendamine ja vähendamine.
2	    	Mitu-ühes kaardilugeja	Võtab vastu Secure Digital (SD), MultiMediaCard (MMC), Memory Stick (MS), Memory Stick PRO (MS PRO) ja xD-Picture kaarte (xD). <b>Märkus:</b> Kaardi eemaldamiseks/ paigaldamiseks vajutage sellele. Korraga saab töötada ainult üks kaart.
3		CIR-vastuvõtja	Võtab vastu kaugjuhtimispuldi signaali.



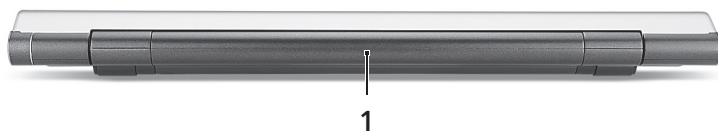



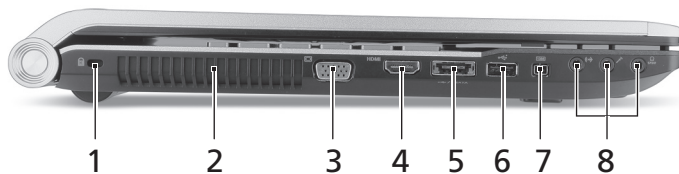

## Tagantvaade



#	Ikoon	Objekt	Kirjeldus
1		Akuseksioon	Siin asuvad arvuti akud.





## Vaade vasakult

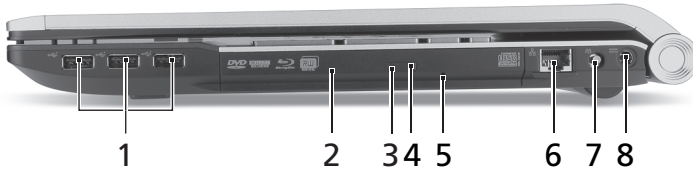

#	Ikoon	Objekt	Kirjeldus
1		Kensington-luku pesa	Kensington-tüüpi arvuti turvaluku ühendamiseks. <b>Märkus:</b> Vedage arvuti turvaluku kaabel ümber liikumatu objekti, näiteks laua või lukustatud sahtli käepideme. Lükake lukk avasse ning keerake luku sulgemiseks võtit. Saadaval on ka võtmeta mudelid.
2		Ventilatsiooniavad	Võimaldavad arvutil püsida jahedana ka pärast pikaajalist kasutamist.
3		Välise kuvari (VGA) port	Kuvaseadme (nt välise kuvari või LCD-projektori) ühendamiseks.
4	HDMI	HDMI-port	Toetab kõrglahutusega digitaalvideoühendusi.
5		USB 2.0/eSATA port	USB 2.0 või eSATA seadmetega ühendamiseks (ainult teatud mudelitel). <b>Märkus:</b> Kui ühendate külge eSATA seadme, on teil üheaegselt võimalik kasutada kolme USB-porti.
6		USB 2.0 port	USB 2.0 seadmete ühendamiseks (nt USB-hiir või USB-kaamera).
7		4 kontaktiga IEEE 1394 port	IEEE 1394 seadmete ühendamiseks.
8		Helisend	Helisendseadmete ühendamiseks (nt audio-CD mängija, stereo-pleier, MP3-mängija).
		Mikrofonipesa	Võtab vastu sisendheli välisest mikrofonist.
		Kõrvaklappide/kõlarite/heliväljundi pistik S/PDIF toega	Heliväljundseadmete ühendamiseks (nt kõlarid, kõrvaklapid).







## Vaade paremalt



#	Ikoon	Objekt	Kirjeldus
1		USB 2.0 porti	USB 2.0 seadmete ühendamiseks (nt USB-hiir või USB-kaamera).
2		Optiline seade	Sisemine optiline seade; loeb CD-sid või DVD-sid.
3		Optilise ketta lugemise indikaator	Süttib, kui optiline seade on aktiivne.
4		Optilise seadme väljastusnupp	Väljastab optilise ketta seadmest.
5		Hädaväljastusava	Avab optilise seadme sahtli, kui arvuti on välja lülitatud. <b>Märkus:</b> Optilise seadme avamiseks siis, kui arvuti on välja lülitatud, lükake hädaväljastusavasse kirjaklamber.
6		Etherneti (RJ-45) port	Ethernet 10/100/1000-põhise võrguga ühendamiseks.
7		RF-port	Võtab vastu sisendsignaali digitaal-TV tuuneritest (ainult teatud mudelitel).
8		Alalisvoolusisendi pistik	Vahelduvvooluadapteri (toiteploki) ühendamiseks.

## Põhjavaade



#	Ikon	Objekt	Kirjeldus
1		Akuseksioon	Siin asuvad arvuti akud.
2		Subwoofer	Toob kuuldavale madala sagedusega väljundheli.
3		Aku vabastamise riiv	Vabastab aku, et seda saaks välja võtta.
4		Mälusahtel	Siin asub arvuti põhimälu.
5		Kõvakettaseksioon - peamine	Siin asub arvuti kõvaketas (kinnitatud kruvidega).
6		Kõlarid	Toodavad stereoheli.
7		Kõvakettaseksioon - teisene	Siin asub arvuti kõvaketas (kinnitatud kruvidega) (ainult teatud mudelitel).
8		Akulukk	Lukustab aku kohale.

## Keskkond

---

- Temperatuur:
    - Töötamiseks sobiv: 5°C kuni 35°C
    - Sobimatu: -20°C kuni 65°C
  - Niiskus (mittekondenseeruv):
    - Töötamiseks sobiv: 20% kuni 80%
    - Sobimatu: 20% kuni 80%
-

# Acer piezīmjdators

Ātrais ceļvedis

© 2010 Visas tiesības aizsargātas.

Acer piezīmjdatora ātrais ceļvedis

Oriģinālizdevums: 03/2010

Modeļa numurs: \_\_\_\_\_

Sērijas numurs: \_\_\_\_\_

Pirkuma datums: \_\_\_\_\_

Pirkuma vieta: \_\_\_\_\_



# Galvenais vispirms

Mēs vēlamies jums pateikties, ka esat izvēlējies Acer piezīmjdatoru, lai nodrošinātu savas mobilās skaitļošanas vajadzības.

## Jūsu rokasgrāmatas

Lai palīdzētu jums lietot Acer piezīmjdatoru, esam sagatavojuši rokasgrāmatu komplektu:

Pirmkārt, plakāts **Tikko sākušajiem...** jums palīdz uzsākt datora iestatīšanu.

**Aspire sērija vispārējais lietotāja ceļvedis** satur noderīgu informāciju, kas attiecas uz visiem Aspire produktu sērijas modeļiem. Tas aptver pamata tematiku, tādu kā tastatūras un audio izmantošana utt. Lūdzu, saprotiet, ka **vispārējais lietotāja ceļvedis**, kā arī **AcerSystem lietotāja ceļvedis (AcerSystem User Guide)**, kas pieminēts turpmāk, to būtības dēļ laiku pa laikam attiecas uz funkcijām vai līdzekļiem, kas piemīt tikai noteiktiem sērijas modeļiem, bet ne obligāti modelim, ko esat iegādājies. Šādi gadījumi tekstā ir apzīmēti ar vārdiem „tikai noteiktiem modeļiem”.

**Ātrais ceļvedis** sniedz ieskatu par jūsu jaunā datora galvenajiem līdzekļiem un funkcijām. Lai uzzinātu vairāk, kā jūsu dators jums var palīdzēt būt vēl produktīvākam, lūdzu, skatiet **AcerSystem lietotāja ceļvedis (AcerSystem User Guide)**. Šajā ceļvedī ir detalizēta informācija par tādām tēmām kā sistēmas utilitās, datu atkopšana, paplašināšanas opcijas un problēmu novēršana. Bez tam tajā ir iekļauta informācija par garantijām un piezīmjdatora lietošanas vispārīgas regulas un drošības paziņojumi. Tas ir pieejams PDF (Portable Document Format - portatīvā dokumenta formāts) formātā un ir iepriekš ielādēts jūsu piezīmjdatorā. Veiciet šīs darbības, lai tam piekļūtu:

- 1 Noklikšķiniet uz  **Start (Sākt) > All Programs (Visas programmas) > AcerSystem.**
- 2 Noklikšķiniet uz **AcerSystem lietotāja ceļvedis (AcerSystem User Guide).**



**Piezīme:** Lai skatītu failu, nepieciešama programma Adobe Reader. Ja jūsu datorā nav instalēta programma Adobe Reader, pirmo reizi noklikšķinot uz **AcerSystem lietotāja ceļvedis (AcerSystem User Guide)**, automātiski tiks palaista programmas Adobe Reader instalēšana. Lai pabeigtu instalēšanu, izpildiet ekrānā redzamos norādījumus. Lai iegūtu norādījumus, kā lietot programmu Adobe Reader, piekļūstiet izvēlei **Help and Support (Palīdzība un atbalsts)**.







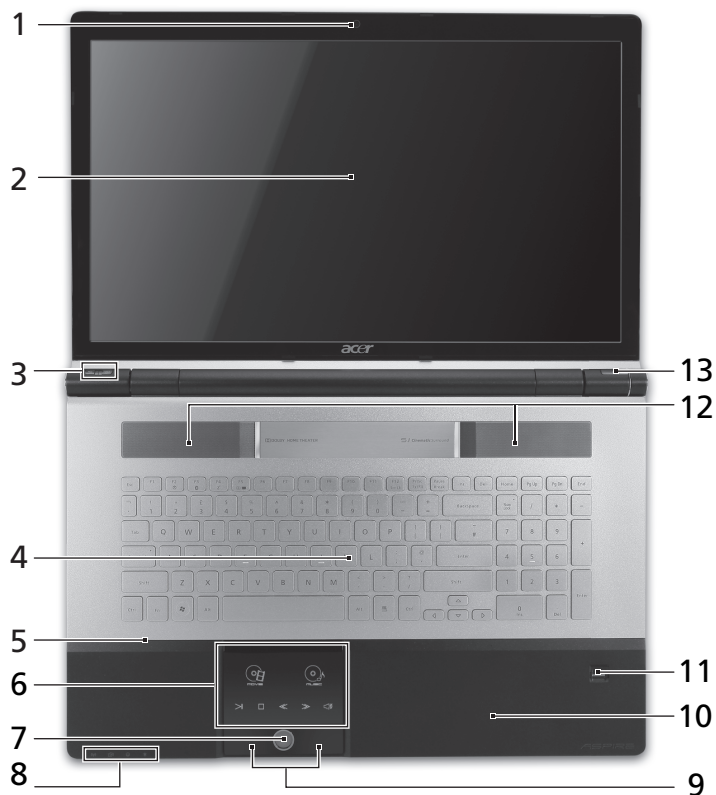

# Acer piezīmjdatora pārskats





Pēc datora iestatīšanas, kā parādīts attēlā **Tikko sākušajiem...**, ļaujiet mums iepazīstināt jūs ar jauno Acer piezīmjdatoru.

## Skats no augšpuses



#	Ikona	Elements	Apraksts
1		Acer Crystal Eye tīmekļa kamera	Tīmekļa kamera videosakariem (tikai noteiktiem modeļiem).
2		Displeja ekrāns	Saukts arī par šķidro kristālu displeju (LCD); rāda datora izvadi (modeļu konfigurācija var atšķirties).

#	Ikona	Elements	Apraksts
3		Arcade taustiņš	Palaiž InstantOn Arcade.
	P	P taustiņš/ Acer PowerSmart taustiņš	Programmējams taustiņš (modeļu konfigurācija var atšķirties)./ Pārslēdz datoru enerģijas taupīšanas režīmā (modeļu konfigurācija var atšķirties).
4		Tastatūra	Datu ievadīšanai datorā.
5		Mikrofons	Iekšējais mikrofons skaņas ierakstīšanai.
6		Skārienpanelis/ Multivides konsole	Skārienjutīga rādītājierīce, kas darbojas kā datora pele*./ Skārienjutīgi vadības taustiņi Acer Arcade izmantošanai, skaļumam (palielināšana/samazināšana) un multividei (atskaņošana/pauzēšana, apturēšana, iepriekšējais viens, nākamais viens); ar skaņas izslēgšanu.
		Filma	Palaiž filmas atskaņošanas programmatūru.
		Mūzika	Palaiž mūzikas atskaņošanas programmatūru.
		Atskaņot/ pauze	Atskaņo vai aptur izvēlēto multivides failu.
		Pārtraukt	Pārtrauc izvēlēto multivides faila atskaņošanu.
		Atpakaļ	Atgriežas pie iepriekšējā multivides faila.
		Tālāk	Pārlec uz nākamo multivides failu.
		Izslēgt skaņu	Ieslēdz vai izslēdz skaņu.
			* Skārienpanelis kļūst neaktīvs, ja multivides konsole ir aktīva.
7		Multivides konsoles kontrolleris	Ieslēdz vai izslēdz multivides konsoli.













#	Ikona	Elements	Apraksts
8		Sakaru taustiņš	Iespējo/atspējo datora sakaru ierīces. (Sakaru ierīces var atšķirties atkarībā no konfigurācijas.)
		Dublēšanas taustiņš	Palaiž Acer Backup Management trīs soļu datu dublēšanai.
		Cietā diska indikators <sup>1</sup>	Norāda, ka cietais disks ir aktīvs.
		Jaudas indikators <sup>1</sup>	Norāda datora barošanas statusu.
9		Klikšķināmas pogas (kreisā un labā)	Kreisā un labā poga darbojas tāpat kā peles kreisā un labā poga.
10		Plaukstu atbalsta zona	Ērta atbalsta zona jūsu rokām, kad lietojat datoru.
11		Acer Bio-Protection pirkstu nospiedumu lasītājs	Atbalsta Acer FingerNav četrvirzienu vadības funkciju (tikai noteiktiem modeļiem).
12		Skaļruņi	Nodrošina stereo audio izvadi.
13		Barošanas poga	Ieslēdz un izslēdz datoru.

1. Priekšējā paneļa indikatori ir redzami pat tad, kad datora vāks ir aizvērts.

## Ātrie taustiņi





Lai piekļūtu lielākajai daļai datora vadības funkciju, piemēram, ekrāna spilgtuma un skaļuma regulēšanai, tiek izmantoti datora ātrie taustiņi vai taustiņu kombinācijas.

Lai aktivizētu ātros taustiņus, nospiediet un turiet taustiņu <Fn>, tad nospiediet ātrā taustiņa kombinācijas otru taustiņu.

Ātrais taustiņš	Ikona	Funkcija	Apraksts
<Fn> + <F3>		Sakaru taustiņš	Iespējo/atspējo datora sakaru ierīces. (Sakaru ierīces var atšķirties atkarībā no konfigurācijas.)
<Fn> + <F4>		Miega režīms	Pārslēdz datoru miega režīmā.
<Fn> + <F5>		Displeja pārslēgšana	Pārslēdz displeja izvadi starp displeja ekrāna un ārējo monitoru (ja tas ir pievienots), vai rāda izvadi abos.
<Fn> + <F6>		Tukšs ekrāns	Enerģijas taupīšanas nolūkā izslēdz displeja ekrāna pretgaismu. Lai atjaunotu pretgaismu, nospiediet jebkuru taustiņu.
<Fn> + <F7>		Skārienpaneļa pārslēgšana	Ieslēdz un izslēdz iebūvēto skārienpaneli.
<Fn> + <F8>		Skaļruņu pārslēgšana	Ieslēdz un izslēdz skaļruņus.
<Fn> + <D>		Spilgtāk	Palielina ekrāna spilgtumu.
<Fn> + <C>		Blāvāk	Samazina ekrāna spilgtumu.
<Fn> + <Home>		Atskaņot/pauze	Atskaņo vai aptur izvēlēto multivides failu.
<Fn> + <Pg Up>		Pārtraukt	Pārtrauc izvēlēta multivides faila atskaņošanu.
<Fn> + <Pg Dn>		Atpakaļ	Atgriežas pie iepriekšējā multivides faila.
<Fn> + <End>		Tālāk	Pārlec uz nākamo multivides failu.

## Skats no priekšpuses aizvērtā veidā



#	Ikona	Elements	Apraksts
1		Īkšķrats	Palielina vai samazina skaļumu.
2	    	Karšu lasītājs "Vairāki vienā"	Pieņem datu nesējus Secure Digital (SD), MultiMediaCard (MMC), Memory Stick (MS), Memory Stick PRO (MS PRO) un xD-Picture Card (xD).  <b>Piezīme:</b> Nospiediet, lai izņemtu/instalētu karti. Vienlaikus var lietot tikai vienu karti.
3		CIR uztvērējs	Uztver tālvadības ierīces signālus.



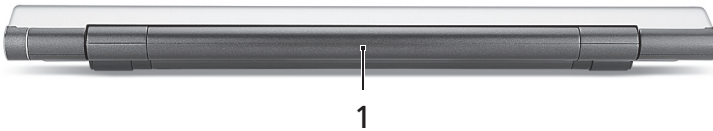



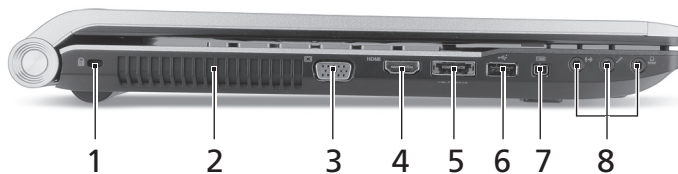

## Skats no aizmugures

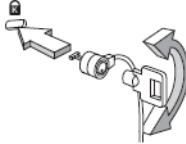

#	Ikona	Elements	Apraksts
1		Akumulatora nodalījums	Šeit ievieto datora akumulatoru.





## Skats no kreisās puses

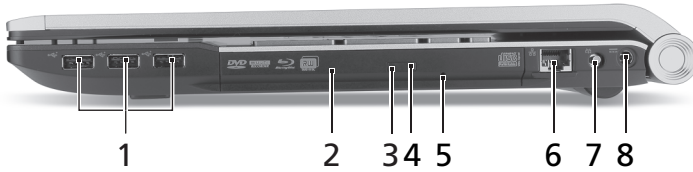

#	Ikona	Elements	Apraksts
1		Kensingtona atslēgas slots 	Šeit pieslēdz Kensingtona atslēgu datora drošībai. <b>Piezīme:</b> Aplieciet datora drošības slēdzenes vadu ap nekustīgu priekšmetu, piemēram, galdu vai aizslēgtas atvilktnes rokturi. Ielieciet aizslēgu ierobā un pagrieziet atslēgu, lai nofiksētu slēdzeni. Pieejami arī daži modeļi bez atslēgas.
2		Ventilācijas atveres	Neļauj datoram sakarst pat pēc ilgstošas lietošanas.
3		Ārējā displeja (VGA) ports	Šeit pieslēdz displeja ierīci (piemēram, ārēju monitoru, LCD projektoru).
4	HDMI	HDMI ports	Atbalsta augstas kvalitātes ciparu video savienojumus.
5		USB 2.0/e SATA ports	Pievieno USB 2.0 vai eSATA ierīcēm (tikai noteiktiem modeļiem). <b>Piezīme:</b> Ja pievienosiet eSATA ierīci, jums būs pieejami trīs USB porti attiecīgajā laikā.
6		USB 2.0 ports	Šeit pieslēdz USB 2.0 ierīces (piemēram, USB peli, USB kameru).
7		Četrkontakta IEEE 1394 ports	Šeit pieslēdz IEEE 1394 ierīces.
8		Līnijas ieejas ligzda	Paredzēta audio līnijas ieejas ierīcēm (piemēram, audio CD disku atskaņotājam, stereo atskaņotājam, mp3 atskaņotājam).
		Mikrofona ieejas ligzda	Pieņem ievadi no ārējiem mikrofoniem.
		Austiņu/skaļruņu/līnijas izejas ligzda ar S/PDIF atbalstu	Šeit pieslēdz audio līnijas izejas ierīces (piemēram, skaļruņus, austiņas).

## Skats no labās puses







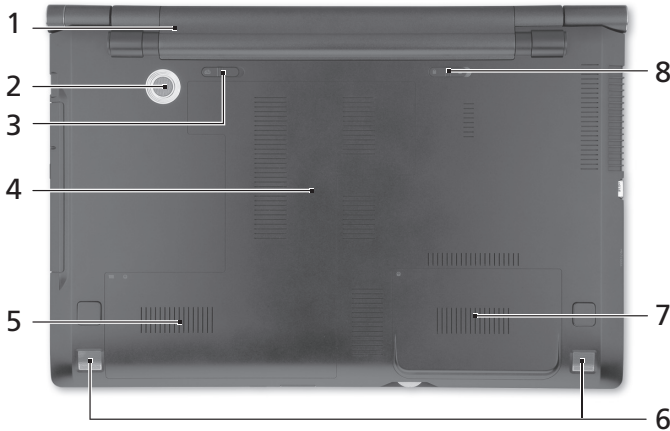

#	Ikona	Elements	Apraksts
1		USB 2.0 porti	Šeit pieslēdz USB 2.0 ierīces (piemēram, USB peli, USB kameru).
2		Optiskais diskdzinis	Iekšējais optiskais diskdzinis; pieņem CD vai DVD diskus.
3		Optiskā diska piekļuves indikators	Iedegas, kad optiskais diskdzinis ir aktīvs.
4		Optiskā diska izstumšanas poga	Izstumj no diskdziņa optisko disku.
5		Ārkārtas diska izņemšanas caurums	Izstumj optiskā diskdziņa paliktni, kad dators ir izslēgts. <b>Piezīme:</b> Lai izstumtu optiskā diskdziņa paliktni, kad dators ir izslēgts, iespiediet ārkārtas diska izņemšanas caurumā papīra saspraudi.
6		Ethernet (RJ-45) ports	Šeit pieslēdz Ethernet 10/100/1000 tīkla vadu.
7		RF ieejas ports	Pieņem ieejas signālus no digitālās TV skaņotājiem (tikai noteiktiem modeļiem).
8		Līdzstrāvas ieejas ligzda	Šeit pieslēdz maiņstrāvas adapteru.



## Skats no apakšpusēs



#	Ikona	Elements	Apraksts
1		Akumulatora nodalījums	Šeit ievieto datora akumulatoru.
2		Zemfrekvenču skaļrunis	Izvada zemfrekvenču skaņu.
3		Akumulatora atbrīvošanas slēdzis	Atbrīvo akumulatoru, lai to varētu izņemt.
4		Atmiņas nodalījums	Šeit atrodas datora pamatatmiņa.
5		Cietā diska nodalījums- galvenais	Šeit atrodas datora cietais disks (nostiprināts ar skrūvēm).
6		Skaļruņi	Nodrošina stereo audio izvadi.
7		Cietā diska nodalījums- sekundārs	Šeit atrodas datora cietais disks (nostiprināts ar skrūvēm) (tikai noteiktiem modeļiem).
8		Akumulatora fiksators	Nofiksē akumulatoru.

## Vide

---

- Temperatūra:
    - Ieslēgtā stāvoklī: No 5°C līdz 35°C
    - Izslēgtā stāvoklī: No -20°C līdz 65°C
  - Mitrums (bez kondensācijas):
    - Ieslēgtā stāvoklī: No 20% līdz 80%
    - Izslēgtā stāvoklī: No 20% līdz 80%
-

# Acer nešiojamasis kompiuteris

Trumpa instrukcija

© 2010 Visos teisės saugomos.

Acer nešiojamojo kompiuterio trumpa instrukcija  
Pirmasis leidimas: 03/2010

Modelio numeris: \_\_\_\_\_

Serijos numeris: \_\_\_\_\_

Pirkimo data: \_\_\_\_\_

Pirkimo vieta: \_\_\_\_\_

# Dalykai, kuriuos reikia atlikti pirmiausia

Leiskite padėkoti, kad pasirinkote „Acer“ nešiojamąjį kompiuterį – tikimės Jūsų nenuvilti ir užtikrinti visus nešiojamojo kompiuterio teikiamus privalumus.

## Instrukcijos Jums

Tam, kad palengvintume Jums naudojimąsi „Acer“ kompiuteriu, parengėme kelias instrukcijas:

Pirmoji vadinasi **Pradedantiesiems...** - ši informacija padės pirmosiomis kompiuterio naudojimo minutėmis.

„Aspire“ serijos bendrojoje naudojimo instrukcijoje pateikiama naudinga informacija apie visų Aspire gaminių serijos modelių kompiuterius. Jis apima bendruosius klausimus, kaip, pvz. klaviatūros ir audio sistemos naudojimas ir t.t. Prašome atkreipti dėmesį į tai, jog dėl savo pobūdžio **Bendrojoje naudojimo instrukcijoje** bei **AcerSystem User Guide**, kuris bus minimas toliau, kartais bus aptariamoms funkcijoms ar ypatybėms, būdingoms tik konkrečioms šios serijos modeliams ir nebūtinai tam modeliui, kurį jūs įsigijote. Tokiais atvejais atitinkamose teksto vietose yra priedašais „tik tam tikruose modeliuose“.

**Trumpa instrukcija** pateikiama informacija apie pagrindines Jūsų įsigyto kompiuterio savybes ir funkcijas. Išsamesnės informacijos apie tai, kaip padaryti kompiuterį produktyvesniu, rasite **AcerSystem User Guide**. Šioje instrukcijoje išsamiai aprašoma tokia informacija, kaip sisteminiai failai, duomenų atstatymas, kompiuterio galimybių praplėtimas ir gedimų diagnostika. Be to, šioje instrukcijoje yra ir garantinė informacija, bendrieji reikalavimai ir su sauga susiję įspėjimai. Ši instrukcija yra „Portable Document Format (PDF)“ formate ir ji jau bus kompiuteryje. Jei norite peržiūrėti šią instrukciją:

- 1 Spauskite  **Start (pradėti) > All Programs (visos programos) > AcerSystem.**
- 2 Spauskite **AcerSystem User Guide.**



.....









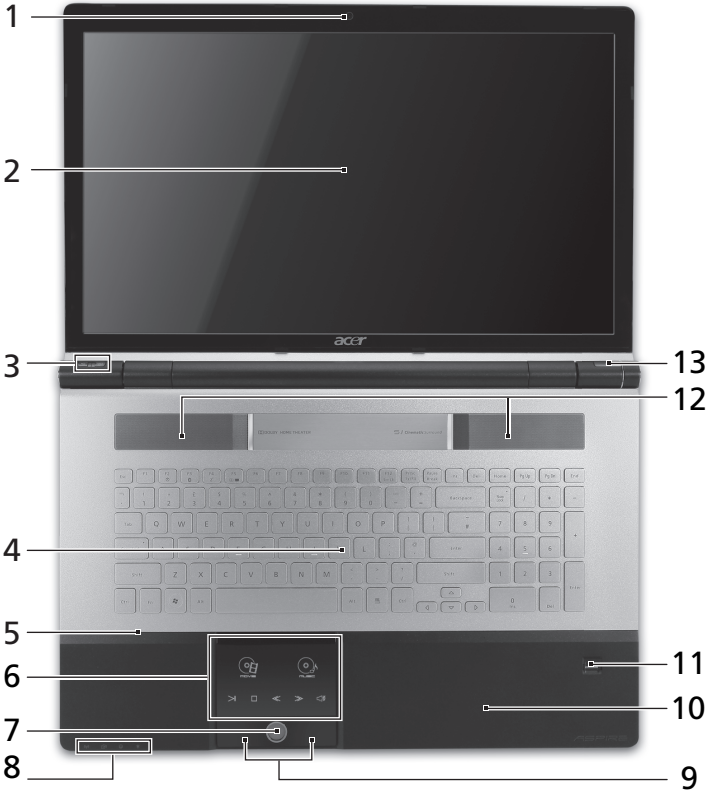













**Pastaba:** Failo peržiūrai reikės „Adobe Reader“. Jei kompiuteryje nėra „Adobe Reader“, paspaudus ant **AcerSystem User Guide** bus pirmiausiai paleistas „Adobe Reader“ įdiegimas. Vadovaukitės ekrane esančiomis instrukcijomis įdiegimo užbaigimui. Instrukcijų dėl „Adobe Reader“ naudojimosi ieškokite „**Help and Support**“ (**Žinynas ir pagalba**) meniu.





# Ekskursija po jūsų Acer nešiojamąjį kompiuterį

Atlikus kompiuterio sąranką kaip parodyta plakate **Pradedantiesiems...**, leiskite jus supažindinti su jūsų naujuoju Acer nešiojamuoju kompiuteriu.

## Vaizdas iš viršaus



#	Piktograma	Objektas	Aprašymas																					
1		Acer Crystal Eye interneto kamera	Interneto kamera vaizdinei komunikacijai (tik tam tikruose modeliuose).																					
2		Ekranas	Taip pat vadinamas skystųjų kristalų ekranu (angl. Liquid-Crystal Display (LCD)), jame pateikiamas kompiuterio rodomas vaizdas (konfigūravimo tvarka gali kisti priklausomai nuo modelio).																					
3		„Arcade“ klavišas	Paleidžia „InstantOn Arcade“.																					
	P	„P“ klavišas/ „Acer PowerSmart“ klavišas	Programuojamasis klavišas (konfigūravimo tvarka gali kisti priklausomai nuo modelio)./ Ijungia jūsų kompiuterio energijos taupymo režimą (konfigūravimo tvarka gali kisti priklausomai nuo modelio).																					
4		Klaviatūra	Skirta duomenų įvedimui į kompiuterį.																					
5		Mikrofonas	Vidinis mikrofonas garso įrašymui.																					
6		Liečiamasis laukelis/medijų valdymo skydelis	<p>Lietimui jautrus įrenginys, veikiantis kaip kompiuterio pelė*. / Lietimui jautrus valdikliai, skirti „Acer Arcade“, garsui (padidinti/sumažinti) ir medijoms (leisti/pauzė, sustabdyti, ankstesnis, paskesnis); su garso išjungimo klavišu.</p> <table border="1"> <tbody> <tr> <td></td> <td>Movie (Filmas)</td> <td>Paleisti filmo rodymo programą.</td> </tr> <tr> <td></td> <td>Music (Muzika)</td> <td>Paleisti muzikos grojimo programą.</td> </tr> <tr> <td></td> <td>Leisti/ pristabdyti</td> <td>Leisti ar pristabdyti pasirinktą medijų failą.</td> </tr> <tr> <td></td> <td>Stabdyti</td> <td>Sustabdyti pasirinktą medijų failą.</td> </tr> <tr> <td></td> <td>Ankstesnis</td> <td>Grįžta prie ankstesnio medijų failo.</td> </tr> <tr> <td></td> <td>Toliau</td> <td>Pereina prie paskesnio medijų failo.</td> </tr> <tr> <td></td> <td>Nutildyti</td> <td>Ijungti arba išjungti garsą.</td> </tr> </tbody> </table> <p>* Liečiamasis laukelis tampa neaktyvus, kai yra aktyvus medijų valdymo skydelis.</p>		Movie (Filmas)	Paleisti filmo rodymo programą.		Music (Muzika)	Paleisti muzikos grojimo programą.		Leisti/ pristabdyti	Leisti ar pristabdyti pasirinktą medijų failą.		Stabdyti	Sustabdyti pasirinktą medijų failą.		Ankstesnis	Grįžta prie ankstesnio medijų failo.		Toliau	Pereina prie paskesnio medijų failo.		Nutildyti	Ijungti arba išjungti garsą.
	Movie (Filmas)	Paleisti filmo rodymo programą.																						
	Music (Muzika)	Paleisti muzikos grojimo programą.																						
	Leisti/ pristabdyti	Leisti ar pristabdyti pasirinktą medijų failą.																						
	Stabdyti	Sustabdyti pasirinktą medijų failą.																						
	Ankstesnis	Grįžta prie ankstesnio medijų failo.																						
	Toliau	Pereina prie paskesnio medijų failo.																						
	Nutildyti	Ijungti arba išjungti garsą.																						
7		Medijų valdymo skydelio valdiklis	Ijungia arba išjungia medijų valdymo skydelį.																					

#	Piktograma	Objektas	Aprašymas
8		Komunikacijos mygtukas	Ijungia/išjungia kompiuterio komunikacijos prietaisus. (Komunikacijos prietaisai gali skirtis priklausomai nuo konfigūracijos.)
		Atsarginės kopijos mygtukas	Paleidžia Acer Backup Management programą, trimis etapais darančią atsarginę duomenų kopiją.
		Kietojo disko (HDD) indikatorius <sup>1</sup>	Nurodo ar kietasis diskas yra naudojamas (į jį rašoma ar skaitoma).
		Maitinimo indikatorius <sup>1</sup>	Nurodo kompiuterio energijos sistemos būklę.
9		Pelės klavišai (kairysis ir dešinysis)	Kairysis ir dešinysis klavišai veikia kaip kairysis ir dešinysis pelės mygtukai.
10		Atrama delnui	Patogi atramos vieta jūsų rankoms naudojimosi kompiuteriu metu.
11		Acer Bio-Protection pirštų atspaudų skaitytuvas	Palaiko „Acer FingerNav 4-way“ valdymo funkciją (tik tam tikruose modeliuose).
12		Garsiakalbiai	Transliuoja stereo garsą.
13		Energijos mygtukas	Ijungia ir išjungia kompiuterį.













1. Priekinio pulto indikatoriai matomi ne tada, kai kompiuterio viršus yra uždarytas.



## Greitieji klavišai





Kompiuteryje įrengti greitieji klavišai ar numatytos klavišų kombinacijos, leidžiančios valdyti daugelį kompiuterio funkcijų, tokių kaip ekrano ryškumas ar garsiakalbių garsas.

Norėdami pasinaudoti greitaisiais klavišais, prieš spausdami bet kokią greitųjų klavišų kombinaciją nuspauskite ir laikykite klavišus <Fn>.

Greitasis klavišas	Piktograma	Funkcija	Aprašymas
<Fn> + <F3>		Komunikacijos mygtukas	Ijungia/išjungia kompiuterio komunikacijos prietaisus. (Komunikacijos prietaisai gali skirtis priklausomai nuo konfigūracijos.)
<Fn> + <F4>		Sustabdyti	Ijungia hibernacijos (kompiuterio sustabdymo) režimą.
<Fn> + <F5>		Ekranų perjungimas	Perjungia kompiuterio rodomą vaizdą iš kompiuterio monitoriaus į išorinį monitorių (jei prijungtas) ir atvirkščiai.
<Fn> + <F6>		Tuščias ekranas	Energijos taupymo tikslais išjungia ekraną. Norint vėl įjungti spauskite bet kurį klavišą.
<Fn> + <F7>		Lietimui jautraus ekrano jungiklis	Ijungia ir išjungia lietimui jautrų ekraną.
<Fn> + <F8>		Garsiakalbio jungiklis	Išjungia ir įjungia garsiakalbius.
<Fn> + <D>		Padidinti ryškumą	Padidina ekrano ryškumą.
<Fn> + <C>		Sumažinti ryškumą	Sumažina ekrano ryškumą.
<Fn> + <Home>		Leisti/ pristabdyti	Leisti ar pristabdyti pasirinktą medijų failą.
<Fn> + <Pg Up>		Stabdyti	Sustabdyti pasirinktą medijų failą.
<Fn> + <Pg Dn>		Ankstesnis	Grįžta prie ankstesnio medijų failo.
<Fn> + <End>		Toliau	Pereina prie paskesnio medijų failo.

## Uždaryto kompiuterio vaizdas iš priekio



#	Piktograma	Objektas	Aprašymas
1		Diskinis reguliatorius	Padidinti arba sumažinti garsą.
2	   	„Multi-in-1“ atminties kortelių skaitytuvas	Skaito Secure Digital (SD), MultiMediaCard (MMC), Memory Stick (MS), Memory Stick PRO (MS PRO), xD-Picture Card (xD) tipų atminties korteles.  <b>Pastaba:</b> Spauskite norėdami įdėti/išimti kortelę. Vienu metu galima naudotis tik viena kortele.
3		CIR imtuvas	Priima signalus iš nuotolinio valdymo pultelių.



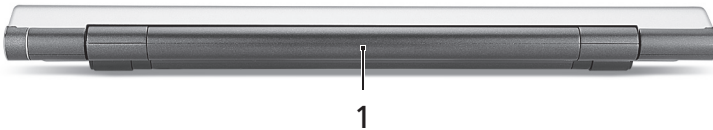



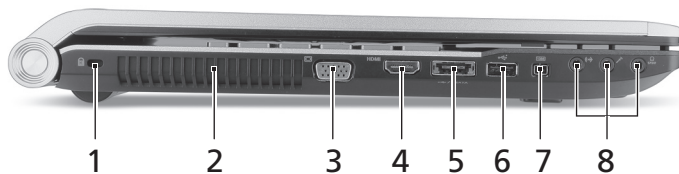

## Vaizdas iš užpakalio



#	Piktograma	Objektas	Aprašymas
1		Baterijos lizdas	Skirtas montuoti kompiuterio baterijai.





## Vaizdas iš kairės

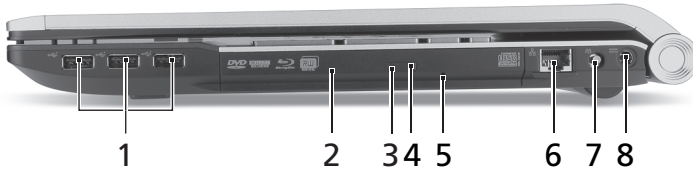

#	Piktograma	Objektas	Aprašymas
1		Kensington spynos lizdas 	Skirtas užfiksuoti Kensington tipo kompiuterio užraktui. <b>Pastaba:</b> Kompiuterio užrakto kabelį apvyniokite aplink nejudamą objektą, pvz. stalą arba užrakinto stalčiaus rankeną. Įkiškite užraktą į įpjovą ir pasukite raktelį, kad užsirakintų. Siūloma ir modelių be raktelių.
2		Ventiliacijos angos	Neleidžia kompiuteriui perkaisti net ir po ilgo naudojimo.
3		Išorinio ekrano (VGA) lizdas	Skirtas prijungti papildomą monitorių (pvz. išorinį monitorių, LCD projektorių).
4	HDMI	HDMI lizdas	Skirtas pajungti didelės raiškos skaitmeniniams vaizdo prietaisams.
5	 /e SATA	USB 2.0/e SATA lizdas	Prijungia USB 2.0 arba eSATA įrenginius (tik tam tikruose modeliuose). <b>Pastaba:</b> Jei prijungsite eSATA įrenginį, tada galėsite naudotis trimis USB lizdais.
6		USB 2.0 lizdas	Skirtas USB 2.0 įrenginiams (pvz., USB pelė, USB kamera) prijungti.
7		4 kištukų IEEE 1394 lizdas	Skirtas prijungti IEEE 1394 tipo įrenginius.
8		Garso įvesties (line-in) kištuko lizdas	Leidžia prijungti įrenginius su garso išvedimu (pvz., kompaktinių diskų leistuvą, stereo ausinuką, mp3 grotuvą).
		Mikrofono kištuko lizdas	Skirtas prijungti išorinį mikrofoną.
		Ausinių/garsiakalbio/linijinio išėjimo kištukas su palaikantis S/PDIF	Skirtas išoriniams linijiniams audio prietaisams (pvz. garsiakalbiams, ausinėms) pajungti.







## Vaizdas iš dešinės

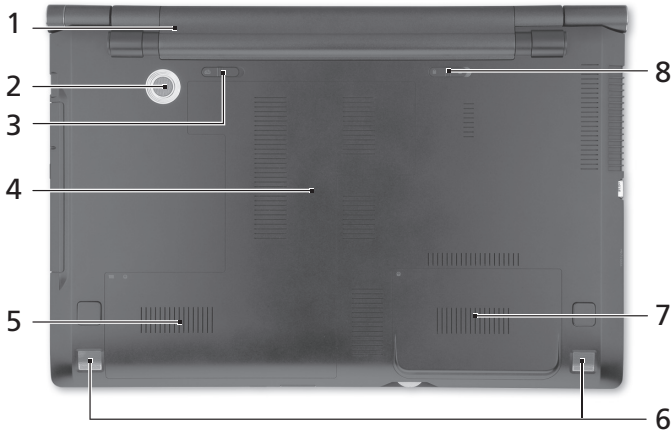

#	Piktograma	Objektas	Aprašymas
1		USB 2.0 lizdai	Skirtas USB 2.0 įrenginiams (pvz., USB pelė, USB kamera) prijungti.
2		Optinių diskų įrenginys	Vidinis optinių diskų įrenginys; skaito CD arba DVD.
3		Optinio disko darbo indikatorius	Dega kai optinių diskų įrenginys dirba.
4		Optinių diskų išstūmimo mygtukas	Atidaro optinių diskų įrenginio dureles.
5		Avarinio atidarymo anga	Atidaro optinių diskų įrenginio dureles kai kompiuteris yra išjungtas. <b>Pastaba:</b> Noredami esant išjungtam kompiuteriui atidaryti optinių diskų įrenginio dureles, į avarinio atidarymo angą įkiškite sąvaržėlę.
6		Ethernet (RJ-45) lizdas	Skirtas prisijungti prie Ethernet 10/100/1000 tipo tinklo.
7		RF įvesties lizdas	Skirtas prijungti skaitmeninio TV imtuvo įrenginius (tik tam tikruose modeliuose).
8		Nuolatinės srovės (DC) kištuko lizdas	Skirtas prijungti kintamos srovės (AC) adapteriui.

## Vaizdas iš apačios



#	Piktograma	Objektas	Aprašymas
1		Baterijos lizdas	Skirtas montuoti kompiuterio baterijai.
2		Žemųjų dažnių garsiakalbis	Skleidžia žemo dažnio garsus.
3		Baterijos fiksatorius	Atpalaiduoja baterijos fiksavimą, leidžia ją išimti.
4		Operatyviosios atminties lizdas	Montuojama pagrindinė kompiuterio atmintis.
5		Kietųjų diskų lizdas-pagrindinis	Montuojamas kietasis diskas (įtvirtintas varžtais).
6		Garsiakalbiai	Transliuoja stereo garsą.
7		Kietųjų diskų lizdas-antrinis	Montuojamas kietasis diskas (įtvirtintas varžtais) (tik tam tikruose modeliuose).
8		Baterijos užraktas	Fiksuoja įdėtą bateriją darbinėje padėtyje.

## Aplinka

---

- Temperatūra:
    - Darbinē: Nuo 5°C iki 35°C
    - Saugojimo: Nuo -20°C iki 65°C
  - Drēgmē (be kondensācijas):
    - Darbinē: Nuo 20% iki 80%
    - Saugojimo: Nuo 20% iki 80%
-

Φορητός υπολογιστής Acer

Γρήγορος οδηγός

© 2010 Με την επιφύλαξη κάθε νόμιμου δικαιώματος.

Σύντομος οδηγός φορητού υπολογιστή Acer  
Αρχική Έκδοση: 03/2010

Αριθμός Μοντέλου: \_\_\_\_\_

Σειριακός Αριθμός: \_\_\_\_\_

Ημερομηνία Αγοράς: \_\_\_\_\_

Τόπος Αγοράς: \_\_\_\_\_



# Όλα με τη σειρά τους

Θα επιθυμούσαμε να σας ευχαριστήσουμε που επιλέξατε το φορητό υπολογιστή της Acer με σκοπό την αντιμετώπιση των αναγκών σας για φορητό υπολογιστή.

## Οι οδηγοί σας

Για να σας βοηθήσουμε στη χρήση του φορητού υπολογιστή της Acer, έχουμε σχεδιάσει ένα σετ εγχειριδίων χρήσης:

Πρώτα απ' όλα, η αφίσα **Μόνο για αρχάριους**... σας βοηθάει να ξεκινήσετε τη ρύθμιση του υπολογιστή σας.

Το έντυπο **Γενικός Οδηγός Χρήσης Σειράς *Aspire*** περιέχει χρήσιμες πληροφορίες που ισχύουν για όλα τα μοντέλα της σειράς προϊόντων *Aspire*. Καλύπτει βασικά θέματα, όπως χρήση πληκτρολογίου, Ήχος κ.λ.π. Παρακαλούμε σημειώστε ότι λόγω της φύσης του, ο **Γενικός Οδηγός Χρήσης** καθώς και ο **AcerSystem User Guide** που αναγράφεται πιο κάτω, αναφέρονται περιστασιακά σε λειτουργίες ή δυνατότητες που αφορούν ορισμένα μόνο μοντέλα της σειράς, αλλά όχι αναγκαία το μοντέλο που προμηθευτήκατε. Αυτές οι περιπτώσεις σημειώνονται στο κείμενο με τη φράση "ορισμένα μοντέλα μόνο".

Ο **Γρήγορος οδηγός** παρουσιάζει τις βασικές δυνατότητες και λειτουργίες του νέου σας υπολογιστή. Για περισσότερες πληροφορίες όσον αφορά τον τρόπο με τον οποίο ο υπολογιστής μπορεί να σας βοηθήσει να αυξήσετε την παραγωγικότητά σας, ανατρέξτε στον **AcerSystem User Guide**. Ο οδηγός αυτός περιλαμβάνει λεπτομερείς πληροφορίες σχετικά με θέματα όπως τα βοηθητικά προγράμματα του συστήματος, την επαναφορά δεδομένων, τις επιλογές επέκτασης και την αντιμετώπιση προβλημάτων. Επιπλέον, περιλαμβάνει πληροφορίες σχετικά με την εγγύηση καλής λειτουργίας και τους γενικούς κανονισμούς όπως και τις προειδοποιήσεις ασφάλειας για το φορητό υπολογιστή. Διατίθεται σε μορφή Portable Document Format (PDF) και έχει προ-εγκατασταθεί στον υπολογιστή σας. Ακολουθήστε τα επόμενα βήματα για την πρόσβαση σε αυτόν.

- 1 Κάντε κλικ στο κουμπί  **Έναρξη > Όλα τα προγράμματα > AcerSystem**.
- 2 Κάντε κλικ στην επιλογή **AcerSystem User Guide**.





**Σημείωση:** Για να δείτε το αρχείο πρέπει να είναι εγκαταστημένο το πρόγραμμα Adobe Acrobat Reader. Αν δεν είναι εγκατεστημένο το Adobe Acrobat Reader στον υπολογιστή σας, η επιλογή του **AcerSystem User Guide** θα εκτελέσει πρώτα το πρόγραμμα εγκατάστασης του Acrobat Reader. Ακολουθήστε τις οδηγίες στην οθόνη για να ολοκληρώσετε την εγκατάσταση. Για οδηγίες σχετικά με το πώς να χρησιμοποιήσετε το πρόγραμμα Adobe Acrobat Reader, προσπελάστε το μενού **Βοήθεια και Υποστήριξη**.





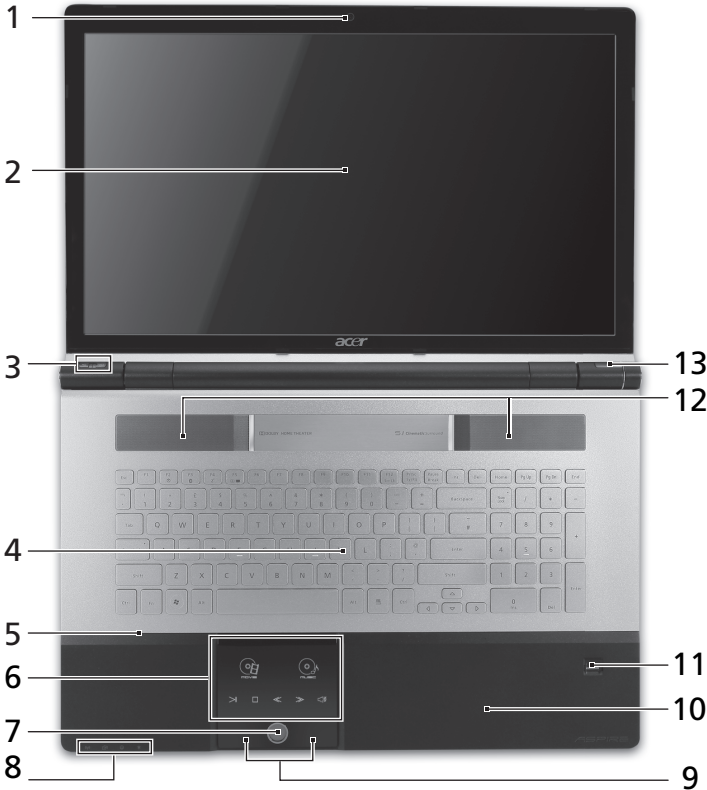





# Μια ξενάγηση του φορητού υπολογιστή Acer





Μετά από την εγκατάσταση του υπολογιστή όπως απεικονίζεται στην αφίσα **Μόνο για αρχάριους...**, θα σας περιγράψουμε τα διάφορα μέρη του νέου σας φορητού υπολογιστή της Acer.

## Κάτοψη



#	Εικονίδιο	Στοιχείο	Περιγραφή
1		Κάμερα διαδίκτυου Acer Crystal Eye	Κάμερα διαδικτύου για επικοινωνία βίντεο (ορισμένα μοντέλα μόνο).

#	Εικονίδιο	Στοιχείο	Περιγραφή																					
2		Οθόνη απεικόνισης	Αποκαλούμενη επίσης Οθόνη Υγρών Κρυστάλλων (Liquid-Crystal Display; LCD), απεικονίζει την έξοδο του υπολογιστή (Η σύνθεση ενδέχεται να ποικίλλει ανάλογα με το μοντέλο).																					
3		Πλήκτρο Arcade	Εκκινεί το InstantOn Arcade.																					
	P	Πλήκτρο P/ Πλήκτρο Acer PowerSmart	Προγραμματιζόμενο πλήκτρο (η σύνθεση ενδέχεται να ποικίλλει ανάλογα με το μοντέλο)./ Θέτει τον υπολογιστή σας σε λειτουργία εξοικονόμησης ενέργειας (η σύνθεση ενδέχεται να ποικίλλει ανάλογα με το μοντέλο).																					
4		Πληκτρολόγιο	Χρησιμοποιείται για την καταχώρηση δεδομένων στον υπολογιστή.																					
5		Μικρόφωνο	Εσωτερικό μικρόφωνο για στερεοφωνικές ηχογραφήσεις.																					
6	 ➤ □ ◀ ▶ ⏪ ⏩	Επιφάνεια αφής/ Κονσόλα πολυμέσων	<p>Συσκευή κατάδειξης ευαίσθητη στην αφή που λειτουργεί ως ποντίκι υπολογιστή*. / Στοιχεία ελέγχου ευαίσθητα στην αφή για το Acer Arcade, ένταση ήχου (αύξηση/μείωση) και πολυμέσων (αναπαραγωγή/παύση, διακοπή, προηγούμενο, επόμενο), με σίγαση.</p> <table border="1"> <tbody> <tr> <td></td> <td>Ταινία</td> <td>Εκκίνηση λογισμικού αναπαραγωγής ταινιών.</td> </tr> <tr> <td></td> <td>Μουσική</td> <td>Εκκίνηση λογισμικού αναπαραγωγής μουσικής.</td> </tr> <tr> <td>⏪</td> <td>Αναπαραγωγή/ Παύση</td> <td>Αναπαραγωγή ή παύση ενός επιλεγμένου αρχείου μέσων.</td> </tr> <tr> <td>□</td> <td>Διακοπή</td> <td>Διακοπή αναπαραγωγής του επιλεγμένου αρχείου μέσων.</td> </tr> <tr> <td>⏪</td> <td>Προηγούμενο</td> <td>Επιστροφή στο προηγούμενο αρχείο μέσων.</td> </tr> <tr> <td>⏩</td> <td>Επόμενο</td> <td>Πηδήξτε στο επόμενο αρχείο μέσων.</td> </tr> <tr> <td></td> <td>Σίγαση</td> <td>Ενεργοποίηση ή απενεργοποίηση της έντασης ήχου.</td> </tr> </tbody> </table> <p>* Η επιφάνεια αφής απενεργοποιείται όταν ενεργοποιείται η Κονσόλα πολυμέσων.</p>		Ταινία	Εκκίνηση λογισμικού αναπαραγωγής ταινιών.		Μουσική	Εκκίνηση λογισμικού αναπαραγωγής μουσικής.	⏪	Αναπαραγωγή/ Παύση	Αναπαραγωγή ή παύση ενός επιλεγμένου αρχείου μέσων.	□	Διακοπή	Διακοπή αναπαραγωγής του επιλεγμένου αρχείου μέσων.	⏪	Προηγούμενο	Επιστροφή στο προηγούμενο αρχείο μέσων.	⏩	Επόμενο	Πηδήξτε στο επόμενο αρχείο μέσων.		Σίγαση	Ενεργοποίηση ή απενεργοποίηση της έντασης ήχου.
	Ταινία	Εκκίνηση λογισμικού αναπαραγωγής ταινιών.																						
	Μουσική	Εκκίνηση λογισμικού αναπαραγωγής μουσικής.																						
⏪	Αναπαραγωγή/ Παύση	Αναπαραγωγή ή παύση ενός επιλεγμένου αρχείου μέσων.																						
□	Διακοπή	Διακοπή αναπαραγωγής του επιλεγμένου αρχείου μέσων.																						
⏪	Προηγούμενο	Επιστροφή στο προηγούμενο αρχείο μέσων.																						
⏩	Επόμενο	Πηδήξτε στο επόμενο αρχείο μέσων.																						
	Σίγαση	Ενεργοποίηση ή απενεργοποίηση της έντασης ήχου.																						
7		Χειριστήριο Κονσόλας πολυμέσων	Ενεργοποιεί ή απενεργοποιεί την Κονσόλα πολυμέσων.																					

#	Εικονίδιο	Στοιχείο	Περιγραφή
8		Πλήκτρο επικοινωνίας	Ενεργοποιεί/απενεργοποιεί τις συσκευές επικοινωνίας του υπολογιστή. (Οι συσκευές επικοινωνίας ενδέχεται να διαφέρουν ανάλογα με τη σύνθεση.)
		Εφεδρικό κλειδί	Εκτελεί το Acer Backup Management για διαδικασία εφεδρείας δεδομένων σε τρία βήματα.
		Ενδείκτης HDD <sup>1</sup>	Δηλώνει πότε είναι ενεργοποιημένη η μονάδα του σκληρού δίσκου.
		Ενδείκτης τροφοδοσίας <sup>1</sup>	Δηλώνει την κατάσταση τροφοδοσίας του υπολογιστή.
9		Κουμπιά κλικ (αριστερό και δεξιό)	Το κουμπιά, αριστερό και δεξιό, λειτουργούν σαν τα κουμπιά, αριστερό και δεξιό, του ποντικιού.
10		Στήριγμα παλάμης	Άνετος χώρος στήριξης των χεριών κατά τη χρήση του υπολογιστή.
11		Συσκευή ανάγνωσης αποτυπωμάτων Acer Bio-Protection	Υποστηρίζει τη λειτουργία ελέγχου 4 κατευθύνσεων Acer FingerNav (ορισμένα μοντέλα μόνο).
12		Ηχεία	Παρέχει έξοδο στερεοφωνικού ήχου.
13		Κουμπί τροφοδοσίας	Ενεργοποιεί και απενεργοποιεί τον υπολογιστή.

1. Οι ενδεικτικές λυχνίες της πρόσοψης είναι ορατές ακόμη και όταν το καπάκι του υπολογιστή είναι τελείως κλειστό.

## Πλήκτρα συντόμευσης

Ο υπολογιστής χρησιμοποιεί πλήκτρα συντόμευσης ή συνδυασμούς πλήκτρων για πρόσβαση στα περισσότερα από τα στοιχεία ελέγχου του υπολογιστή όπως η φωτεινότητα οθόνης και η ένταση ήχου.

Για να ενεργοποιήσετε τα πλήκτρα συντόμευσης, πιέστε παρατεταμένα το πλήκτρο <Fn> πριν πιέσετε το άλλο πλήκτρο του συνδυασμού πλήκτρων συντόμευσης.

Πλήκτρο συντόμευσης	Εικονίδιο	Λειτουργία	Περιγραφή
<Fn> + <F3>		Πλήκτρο επικοινωνίας	Ενεργοποιεί/απενεργοποιεί τις συσκευές επικοινωνίας του υπολογιστή. (Οι συσκευές επικοινωνίας ενδέχεται να διαφέρουν ανάλογα με τη σύνθεση.)
<Fn> + <F4>		Αναμονή	Θέτει τον υπολογιστή σε λειτουργία αναμονής.
<Fn> + <F5>		Εναλλαγή οθόνης	Μεταγωγή της εξόδου οθόνης μεταξύ οθόνης απεικόνισης, εξωτερικού μονίτορ (εάν υπάρχει) ή και των δύο.
<Fn> + <F6>		Κενή οθόνη	Απενεργοποιεί τον οπίσθιο φωτισμό της οθόνης απεικόνισης για εξοικονόμηση ενέργειας. Πιέστε οποιοδήποτε πλήκτρο για επιστροφή.
<Fn> + <F7>		Εναλλαγή Επιφάνειας Αφής	Ενεργοποιεί και απενεργοποιεί την εσωτερική επιφάνεια αφής.
<Fn> + <F8>		Εναλλαγή ηχείων	Ενεργοποιεί και απενεργοποιεί τα ηχεία.
<Fn> + <D>		Αύξηση φωτεινότητας	Αυξάνει τη φωτεινότητα της οθόνης.
<Fn> + <L>		Μείωση φωτεινότητας	Μειώνει τη φωτεινότητα της οθόνης.
<Fn> + <Αρχική>		Αναπαραγωγή/ Παύση	Αναπαραγωγή ή παύση ενός επιλεγμένου αρχείου μέσων.
<Fn> + <Pg Up>		Διακοπή	Διακοπή αναπαραγωγής του επιλεγμένου αρχείου μέσων.
<Fn> + <Pg Dn>		Προηγούμενο	Επιστροφή στο προηγούμενο αρχείο μέσων.
<Fn> + <End>		Επόμενο	Πηδήξτε στο επόμενο αρχείο μέσων.

## Πρόσοψη με το καπάκι κλειστό



#	Εικονίδιο	Στοιχείο	Περιγραφή
1		Περιστροφικός διακόπτης	Αύξηση ή μείωση της έντασης ήχου.
2		Αναγνώστης καρτών πολλών-σε-1	Δέχεται Secure Digital (SD), MultiMediaCard (MMC), Memory Stick (MS), Memory Stick PRO (MS PRO), και xD-Picture Card (xD). <b>Σημείωση:</b> Πίστετε για αφαίρεση/ τοποθέτηση της κάρτας. Δυνατότητα λειτουργίας μόνο μιας κάρτας κάθε φορά.
3		Δέκτης CIR	Λαμβάνει σήματα από τηλεχειριστήριο.



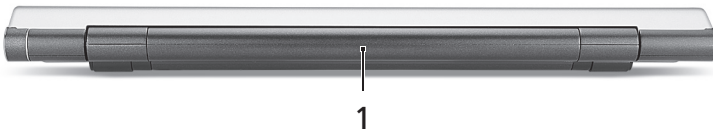

## Πίσω πλευρά



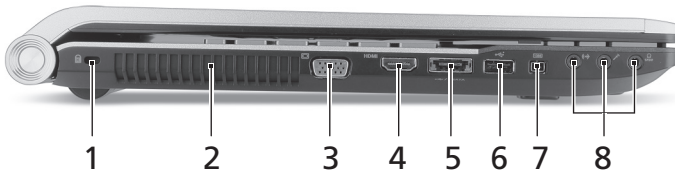

#	Εικονίδιο	Στοιχείο	Περιγραφή
1		Φατνίο μπαταρίας	Περιέχει το πακέτο μπαταρίας του υπολογιστή.

## Αριστερή πλευρά





#	Εικονίδιο	Στοιχείο	Περιγραφή
1		Υποδοχή λουκέτου τύπου Kensington	Συνδέεται σε λουκέτο ασφαλείας υπολογιστή συμβατό με Kensington. <b>Σημείωση:</b> Τυλίξτε το καλώδιο της κλειδαριάς ασφαλείας γύρω από ένα αμετακίνητο αντικείμενο όπως ένα τραπέζι ή το χερούλι ενός κλειδωμένου συρταριού. Εισάγετε την κλειδαριά στην εγκοπή και γυρίστε το κλειδί για να ασφαλίσετε την κλειδαριά. Διατίθενται επίσης μερικά μοντέλα χωρίς κλειδί.
2		Θυρίδες εξαερισμού	Διατηρούν τον υπολογιστή σε χαμηλή θερμοκρασία, ακόμη και ύστερα από παρατεταμένη χρήση.
3		Θύρα εξωτερικής οθόνης απεικόνισης (VGA)	Συνδέεται σε συσκευή απεικόνισης (π.χ. εξωτερικό μόνιτορ, προβολέα LCD).
4	HDMI	Θύρα HDMI	Υποστηρίζει συνδέσεις ψηφιακού βίντεο υψηλής ανάλυσης.
5	 /e SATA	Θύρα USB 2.0/ eSATA	Συνδέεται σε συσκευές USB 2.0 ή eSATA (ορισμένα μοντέλα μόνο). <b>Σημείωση:</b> Εάν συνδέσετε μια συσκευή eSATA, θα έχετε τρεις διαθέσιμες θύρες USB εντωμεταξύ.
6		Θύρα USB 2.0	Συνδέεται σε συσκευές USB 2.0 (π.χ. ποντίκι USB, κάμερα USB).
7		Θύρα IEEE 1394, 4 ακίδων	Συνδέεται σε συσκευές IEEE 1394.

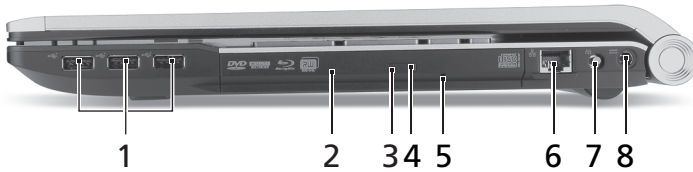

#	Εικονίδιο	Στοιχείο	Περιγραφή
8		Τζακ γραμμής εισόδου	Δέχεται συσκευές με γραμμή εισόδου ακουστικού σήματος (π.χ. συσκευή αναπαραγωγής ήχου από CD, στερεοφωνικό γουόκμαν, αναπαραγωγή MP3).
		Τζακ εισόδου μικροφώνου	Δέχεται εισόδους από εξωτερικά μικρόφωνα.
		Τζακ ακουστικών/ηχείων/γραμμής εξόδου με υποστήριξη S/PDIF	Συνδέεται σε συσκευές με γραμμή εξόδου ακουστικού σήματος (π.χ. ηχεία, ακουστικά).

## Δεξιά πλευρά









#	Εικονίδιο	Στοιχείο	Περιγραφή
1		Θύρες USB 2.0	Συνδέεται σε συσκευές USB 2.0 (π.χ. ποντίκι USB, κάμερα USB).
2		Μονάδα οπτικού δίσκου	Εσωτερική μονάδα οπτικού δίσκου, δέχεται CD ή DVD.
3		Φωτεινή ένδειξη πρόσβασης οπτικού δίσκου	Ανάβει κατά την ενεργοποίηση της μονάδας οπτικού δίσκου.
4		Κουμπί εκτίναξης της μονάδας οπτικού δίσκου	Χρησιμοποιείται για την εκτίναξη του συρταριού της μονάδας οπτικού δίσκου από τη μονάδα.
5		Οπή έκτακτης εκτίναξης	Χρησιμοποιείται για την εκτίναξη του συρταριού της μονάδας οπτικού δίσκου όταν ο υπολογιστής είναι απενεργοποιημένος. <b>Σημείωση:</b> Τοποθετήστε ένα μεταλλικό συνδετήρα μέσα στην οπή έκτακτης εκτίναξης για εκτίναξη του συρταριού της μονάδας οπτικού δίσκου όταν ο υπολογιστής είναι απενεργοποιημένος.
6		Θύρα Ethernet (RJ-45)	Συνδέεται σε δίκτυο Ethernet 10/100/1000.



#	Εικονίδιο	Στοιχείο	Περιγραφή
7		Θύρα εισόδου RF	Δέχεται σήματα εισόδου από ψηφιακούς δέκτες TV (ορισμένα μοντέλα μόνο).
8		Τζακ εισόδου συνεχούς ρεύματος (DC)	Συνδέεται σε προσαρμογέα εναλλασσόμενου ρεύματος (AC).

## Άποψη βάσεως



#	Εικονίδιο	Στοιχείο	Περιγραφή
1		Φατνίο μπαταρίας	Περιέχει το πακέτο μπαταρίας του υπολογιστή.
2		Sub woofer	Εκπέμπει ήχους χαμηλών συχνοτήτων.
3		Μάνδαλο απασφάλισης μπαταρίας	Απασφαλίζει τη μπαταρία για αφαίρεση.
4		Διαμέρισμα μνήμης	Περιέχει την κύρια μνήμη του υπολογιστή.
5		Φατνίο σκληρού δίσκου - Κύριο	Περιέχει το σκληρό δίσκο του υπολογιστή (ασφαλιζεται με βίδες).
6		Ηχεία	Παρέχει έξοδο στερεοφωνικού ήχου.
7		Φατνίο σκληρού δίσκου - ευτερεύον	Περιέχει το σκληρό δίσκο του υπολογιστή (ασφαλιζεται με βίδες) (ορισμένα μοντέλα μόνο).
8		Λουκέτο μπαταρίας	Ασφαλιζει τη μπαταρία στη θέση της.

## Περιβάλλον

---

- Θερμοκρασία:
    - Λειτουργίας: 5°C έως 35°C
    - Μη λειτουργίας: -20°C έως 65°C
  - Υγρασία (μη συμπυκνούμενη):
    - Λειτουργίας: 20% έως 80%
    - Μη λειτουργίας: 20% έως 80%
-

# Acer Dizüstü

Hızlı Başlama Kılavuzu

© 2010 Tüm Hakları Saklıdır.

Acer Dizüstü Hızlı Kılavuzu  
Orijinal İhraç: 03/2010

Model numarası: \_\_\_\_\_

Seri numarası: \_\_\_\_\_

Satın alma tarihi: \_\_\_\_\_

Satın alma yeri: \_\_\_\_\_

# İlk şeyler ilk

Mobil bilgisayar ihtiyaçlarınızı karşılamak için tercihinizi Acer dizüstü bilgisayardan yana yaptığınız için teşekkür ederiz.

## Rehberleriniz

Acer dizüstü bilgisayarı kullanırken size yardımcı olması için bir dizi rehber tasarladık:

İlk önce, **Sadece Başlayanlar için...** poster bilgisayarınızı başlatmanıza yardım eder.

Bazılı **Aspire Serisi Gelen Kılavuzu** Aspire ürün serisindeki tüm modellere uygulanan faydalı bilgiler içermektedir. Klavyeyi kullanma, Ses vs. gibi temel konular içermektedir. Lütfen aşağıda bahsedilen **Acer Sistem Kullanıcı Kılavuzu**'nun yanı sıra **Genel Kılavuz**'un doğası gereği zaman zaman serinin sadece belirli modellerinde bulunan işlev ve özelliklere başvurduğunu ancak satın aldığınız modelde gerekli olmayabileceğini unutmayın. Bu durumda metin "sadece belirli modeller" yazısıyla işaretlenmiştir.

Yazılı **Hızlı Başlama Kılavuzu** size bilgisayarınızın temel özelliklerini ve işlevlerini tanıtır. Daha verimli olmak için bilgisayarınızın size nasıl yardım ettiğini görmek için lütfen **AcerSistem Kullanıcı Kılavuzu**'na bakın. Bu rehber; sistem işlevleri, veri kurtarma, genişletme seçenekleri ve sorun giderme gibi konular üzerine detaylı bilgi içerir. Ayrıca; garanti bilgisi ve dizüstü bilgisayarınız için genel kurallar ve güvenlik önlemleri içerir. PDF dosyası içinde mevcuttur ve dizüstü bilgisayarınızda önceden yüküdür. Ona ulaşmak için bu adımları takip edin:

- 1  **Başlat > Tüm Programlar'a > AcerSistemi**'ni tıklayın.
- 2 **AcerSistemi Kullanıcı Kılavuzu**'nu tıklayın.



-----

**Not:** Adobe Reader gerektiren dosyayı inceleme. Adobe Reader bilgisayarınızda yüklü değilse **AcerSistemi Kullanıcı Kılavuzu**'nu tıklamak Adobe Reader ayarlama programını çalıştıracaktır. Bu yüklemeyi tamamlamak için ekrandaki yönergeleri takip edin. Adobe Reader'ın nasıl kullanıldığını öğrenmek için, **Yardım ve Destek** menüsüne girin.







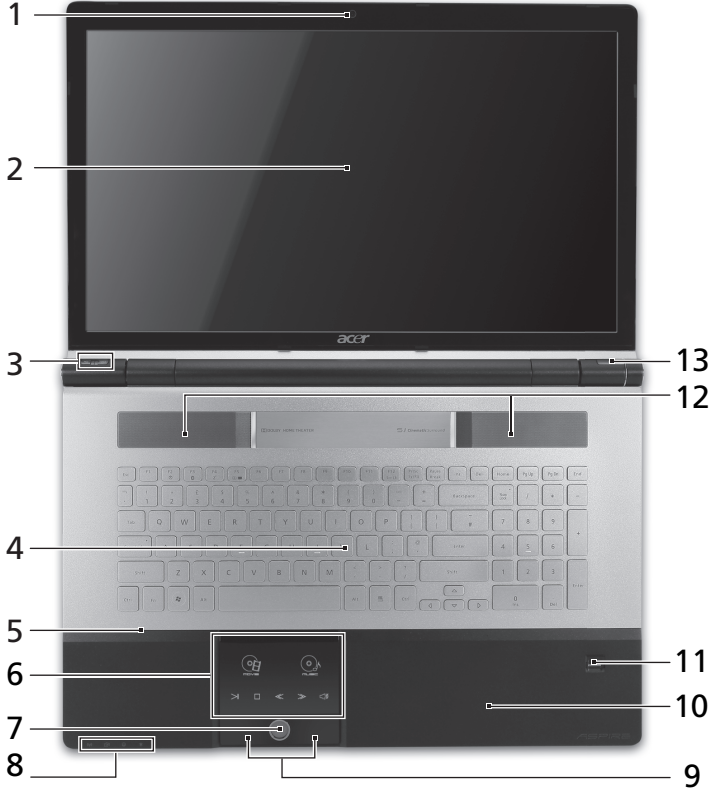

# Acer dizüstü bilgisayarınızda bir gezinti

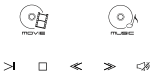

**Başlangıç seviyesindekiler için...** posterinde gösterildiği şekilde bilgisayarınızı kurduktan sonra, yeni Acer dizüstü bilgisayarınızı daha yakından tanıtalım

## Üstten görünüş



#	Simge	Öge	Tanım
1		Acer Crystal Eye video kamera	Görüntülü iletişim için web kamerası (sadece belirli modeller).

#	Simge	Öge	Tanım
2		Görüntü ekranı	Sıvı Kristalli Görüntü (LCD) olarak da bilinir ve bilgisayar çıktılarını gösterir (yapılandırma modellere göre farklı olabilir).
3		Arcade tuşu	InstantOn Arcade'i başlatır.
	P	P tuşu/ Acer PowerSmart tuşu	Programlanabilir tuşlar (yapılandırma modele göre farklı olabilir)/ Bilgisayarınızı güç tasarrufu moduna çevirir (yapılandırma modele göre farklı olabilir).
4		Klavye	Bilgisayarınıza veri girebilmek için.
5		Mikrofon	Ses kaydı için dahili mikrofon.
6		Dokunmatik ped/ Ortam Konsolu	Bilgisayar faresi gibi fonksiyonu olan, dokunmaya duyarlı işaret aygıtı*./ Acer Arcade için olan ses (artır/düşür) ve medya (oynat/duraklat, durdur, önceki, sonraki) hassas kumandalara dokunur; sessiz tuşu ile.
		Film	Film oynatma yazılımını başlatır.
		Müzik	Müzik oynatma yazılımını başlatır.
		Yürüt/ Duraklat	Seçilen ortam dosyasını oynatın veya duraklatın.
		Durdur	Seçilen ortam dosyasının oynatılmasını durdurur.
		Önceki	Önceki ortam dosyasına döner.
		İleri	Sonraki ortam dosyasına geçer.
		Sessiz	Sesi açın veya kapatın.
			* Ortam Konsolu etkinleştirildiğinde dokunmatik yüzey engellenir.
7		Ortam Konsolu kontrolörü	Ortam Konsolunu açar veya kapatır.

#	Simge	Öge	Tanım
8		İletişim anahtarı	Bilgisayarın iletişim aygıtlarını etkinleştirir/engeller. (İletişim aygıtları yapılandırmaya göre farklılık gösterebilir.)
		Yedekleme Tuşu	Üç adımlı veri yedekleme için Acer Backup Management'ı başlatır.
		HDD göstergesi <sup>1</sup>	Sabit diskin etkin olduğunu gösterir.
		Güç göstergesi <sup>1</sup>	Bilgisayarın güç durumunu gösterir.
9		Tuşlar (sol ve sağ)	Sol ve sağ tuşlar, bilgisayar faresinin sağ ve sol tuşları ile aynı fonksiyondadır.
10		Palmrest	Bilgisayarı kullanırken ellerinizi destekleyen rahat bir alan.
11		Acer Bio-Protection parmak izi okuyucusu	Acer FingerNav 4 yönlü kontrol özelliğini destekler (sadece belirli modeller).
12		Hoparlörler	Stereo ses çıkışı sağlar.
13		Güç düğmesi	Bilgisayarı açar ve kapatır.













1. Ön panel göstergeleri bilgisayar kapağı kapalı olsa bile görülebilir.



## Kısayol Tuşları





Bilgisayarda, ekran parlaklığı ve ses çıkışı gibi bilgisayarın birçok kontrolüne erişimin sağlanması için faydalı tuşlar yer almaktadır.

Faydalı tuşları etkinleştirmek için, faydalı tuş kombinasyonundaki diğer tuşa basmadan önce <Fn> tuşuna basılı tutun.

Faydalı tuş	Simge	İşlev	Tanım
<Fn> + <F3>		İletişim anahtarı	Bilgisayarın iletişim aygıtlarını etkinleştirir/engeller. (İletişim aygıtları yapılandırılmaya göre farklılık gösterebilir.)
<Fn> + <F4>		Uyku	Bilgisayarı Uyku moduna sokar.
<Fn> + <F5>		Ekran değişikliği	Görüntü ekranı, harici monitör (eğer bağlıysa) ve ikisi arasında ekran çıktısını değiştirir.
<Fn> + <F6>		Ekran boş	Görüntü ekran arka ışığını, güçten kazanmak için kapatır. Geriye dönmek için herhangi bir tuşa basın.
<Fn> + <F7>		Dokunmatik yüzey değişikliği	Dahili dokunmatik yüzeyi açar ve kapatır.
<Fn> + <F8>		Hoparlör değişikliği	Hoparlörleri açar ve kapatır.
<Fn> + <▶>		Parlaklığı artır	Ekran parlaklığını artırır.
<Fn> + <◀<		Parlaklığı azalt	Ekran parlaklığını azaltır.
<Fn> + <Giriş>		Yürüt/Duraklat	Seçilen ortam dosyasını oynatın veya duraklatın.
<Fn> + <Pg Up>		Durdur	Seçilen ortam dosyasının oynatılmasını durdurur.
<Fn> + <Pg Dn>		Önceki	Önceki ortam dosyasına döner.
<Fn> + <Bitir>		İleri	Sonraki ortam dosyasına geçer.

## Kapalı ön görünüm



#	Simge	Öge	Tanım
1		Parmak teker	Sesi yükseltin veya kısın.
2	    	Çoklu kart okuyucu	Güvenli Dijital (SD), Çoklu Ortam Kartı(MMC), Bellek Çubuğu (MS), Bellek Çubuğu PRO (MS PRO), xD-Görüntü Kartı (xD)'ni kabul eder. <b>Not:</b> Kartı çıkartmak/takmak için itin. Her hangi bir zamanda sadece bir kart çalışabilir.
3		CIR alıcısı	Sinyalleri uzaktan kumandadan alır.



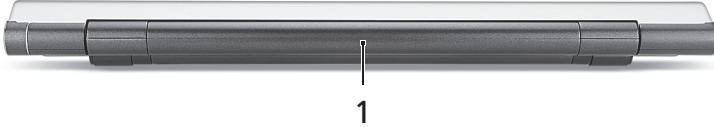



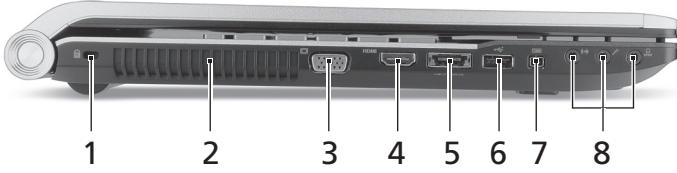

## Arka görünüm



#	Simge	Öge	Tanım
1		Pil bölmesi	Bilgisayar pil takımının yeridir.





## Sol görünüm

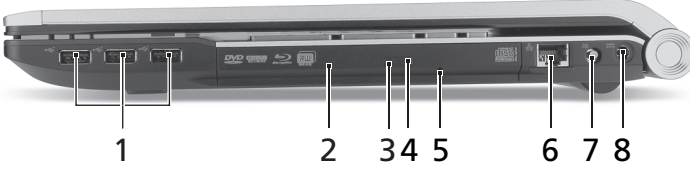

#	Simge	Öge	Tanım
1		Kensington kilit yuvası	Kensington-uyumlu bilgisayar güvenlik kilidine bağlar. <b>Not:</b> Bilgisayar güvenlik kilidi kablosunu, masa ya da kilitle bir dolabın tutacağı gibi hareket etmeyen bir nesnenin etrafına dolayın. Kilidi çentiğe sokun ve kilidi kapamak için anahtarı çevirin. Anahtarsız modeller de mevcuttur.
2		Havalandırma yuvaları	Bilgisayarınızın uzun kullanımlar sonrası bile ısınmamasını sağlarlar.
3		Harici görüntü (VGA) portu	Bir görüntü aygıtına bağlar (örneğin, harici monitör, LCD projektör).
4	HDMI	HDMI portu	Yüksek çözünürlüklü dijital video bağlantılarını destekler.
5	 /e SATA	USB 2.0/ eSATA portu	USB 2.0 veya eSATA aygıtlarına bağlanır (sadece belli modellerde). <b>Not:</b> ESATA aygıtı bağlarsanız aynı anda üç USB portu kullanabilirsiniz.
6		USB 2.0 portu	USB 2.0 cihazlara bağlar (örneğin, USB mouse, USB kamera).
7		4-pimli IEEE 1394 portu	IEEE 1394 aygıtlarına bağlanır.
8		Hat girişi jakı	Ses giriş cihazlarını (örneğin, ses CD çalar, stereo walkman, mp3 çalar) kabul eder.
		Mikrofon-in jakı	Harici mikrofon girişlerini kabul eder.
		S/PDIF desteği ile kulaklıklar/hoparlör/hat çıkışı jakı	Sesli line-out cihazlarına bağlantıyı sağlar (örneğin hoparlör, kulaklık).







## Sağ görünüm



#	Simge	Öge	Tanım
1		USB 2.0 portu	USB 2.0 cihazlarına bağlantıyı sağlar (örneğin USB fare, USB kamera).
2		Optik sürücü	Dahili optik sürücü; CD'leri veya DVD'leri kabul eder.
3		Optik sürücü erişim göstergesi	Optik sürücü etkinken yanar.
4		Optik sürücü çıkarma tuşu	Optik diski sürücüden çıkarır.
5		Acil durum çıkarma yuvası	Bilgisayara kapandığında optik sürücü yatağını çıkarır. <b>Not:</b> Bilgisayar kapatıldığında optik sürücü tepsisini çıkarmak için acil durum çıkarma yuvasına bir kağıt atacaktır.
6		Ethernet (RJ-45) portu	Ethernet 10/100/1000-temelli ağa bağlar.
7		RF-giriş portu	Dijital TV tuner cihazlarından giriş sinyallerini kabul eder (sadece belirli modeller).
8		DC-in jakı	AC adaptöre bağlanır.

## Alt görünüm



#	Simge	Öge	Tanım
1		Pil bölmesi	Bilgisayar pil takımının yeridir.
2		Subwoofer	Düşük frekansta ses çıkışı çıkarır.
3		Pil çıkarma mandalı	Eskiyen pilleri çıkarmanız içindir.
4		Bellek bölmesi	Bilgisayarın ana hafızasını barındırır.
5		Sabit disket Ana-yuvası	Bilgisayarın sabit diskini barındırır (vidalarla sabitlenmiştir).
6		Hoparlörler	Stereo ses çıkışı sağlar.
7		Sabit disket İkinci-yuvası	Bilgisayarın sabit diskini barındırır (vidalarla sabitlenmiştir) (sadece belirli modeller).
8		Pil kilidi	Pil yerine oturduğunda kilitler.

## Ortam

---

- Sıcaklık:
    - Çalışma: 5°C ila 35°C arasında
    - Çalışmadığı durumda: -20°C ila 65°C arasında
  - Nem (yoğunlaşmayan):
    - Çalışma: %20 ila %80 arasında
    - Çalışmadığı durumda: %20 ila %80 arasında
-

# Acer ノートブック

## クイックガイド

© 2010 All Rights Reserved.

Acer ノートブック クイックガイド  
初版：2010 年 3 月

モデル番号： \_\_\_\_\_

シリアル番号： \_\_\_\_\_

購入日： \_\_\_\_\_

購入場所： \_\_\_\_\_



# はじめに

この度は、Acer ノートブック PC をお買い上げいただき、誠にありがとうございます。

## ガイド

本製品を快適にご使用いただくために、次のガイドが提供されています。

**Aspire シリーズユーザーガイド**には、Aspire シリーズの全モデルに共通の情報が記載されています。本書にはキーパッド、オーディオの使い方など、基本的な情報が含まれています。**ユーザーガイド**および以下に紹介する **AcerSystem User Guide** (ユーザーガイド) に記載される説明の中には、特定モデルにのみ適用されるものがあり、お客様が購入されたモデルには該当しない場合があります。そのような場合には、「特定モデルのみ」などのように注記が付けられています。

**クイックガイド**は、本 PC を生産的に使用するための方法を説明します。

**AcerSystem User Guide** (ユーザーガイド) は、本 PC についてわかりやすく説明しておりますので、良くお読み頂き、指示に従ってください。このガイドには、システムユーティリティ、データ復元、拡張オプション、トラブルシューティングなどの詳細情報を記載しております。また、このノート PC の保証、一般規制、安全規定についても記載しています。マニュアルを印刷する必要がある場合、ユーザーズマニュアルは PDF (Portable Document Format) ファイルで提供されています。以下の手順に従ってください。

1.  **スタート > すべてのプログラム > Acer System** をクリックしてください。
2. **AcerSystem User Guide** (ユーザーガイド) をクリックしてください。





.....





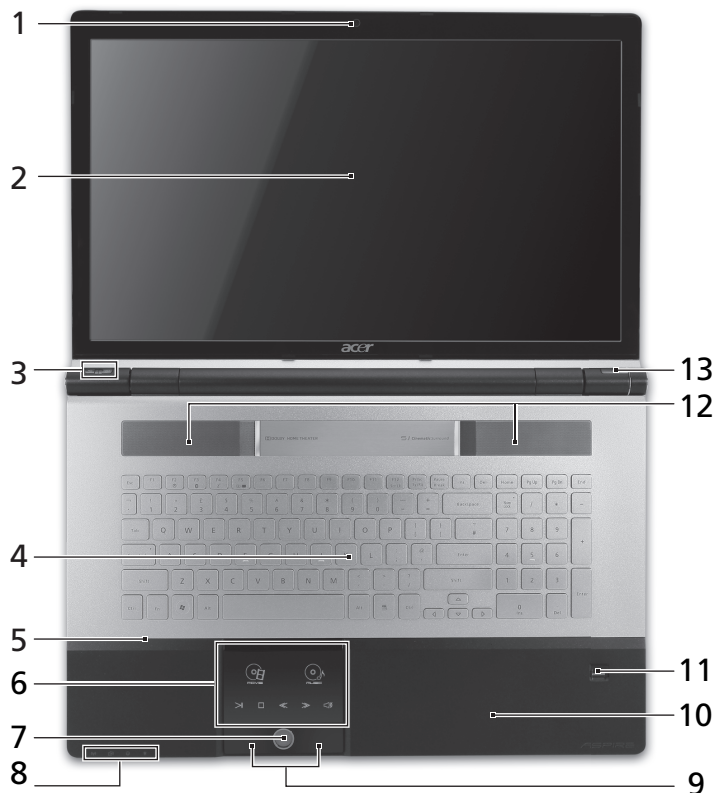





**注意:** ファイルを表示するには、Adobe Reader が必要となります。Adobe Reader の使い方については、「**Adobe Reader ヘルプ**」にアクセスしてください。





## Acer ノートブックツアー

## 上面



#	アイコン	アイテム	説明
1		Acer Crystal Eye ウェブカメラ	ビデオ通信用のウェブカメラ (特定モデルのみ)。
2		ディスプレイ スクリーン	液晶ディスプレイ (LCD) と呼びます。 コンピューター出力を表示します (構成はモデルによって異なります)。

#	アイコン	アイテム	説明
3		Arcade キー	InstantOn Arcade を起動します。
P		P キー / Acer PowerSmart キー	プログラム可能なキー（構成はモデルによ て異なります）。/ コンピューターを省電力 モードにします（構成はモデルにより異なり ます）。
4		キーボード	コンピューターにデータを入力します。
5		マイクروفオン	録音用の内部マイクروفオンです。
6	  	タッチパッド / メディア コンソール	コンピューターマウスと同じように機能し、 指を触れることで反応するポインティング デバイスです*。/ タッチ操作による、 ミュート機能を備えた音量（上げる / 下げる）およびメディア（再生 / 一時停止、 中止、戻る、次へ）コントロール。
		ムービー	ムービー再生ソフトを 起動。
		ミュージック	ミュージック再生ソフト を起動。
		再生 / 一時停止	選択したメディアファイ ルを再生または一時停止 します。
		中止	選択したメディアファイ ルの再生を中止します。
		戻る	前のメディアファイルに 戻ります。
		次へ	次のメディアファイルに 移動します。
		オーディオを ミュート	ボリュームをオン / オフにします。
			* メディア コンソールをアクティブにする と、タッチパッドは無効になります。
7		メディア コンソール コントローラ	メディア コンソールをオン / オフにします。













#	アイコン	アイテム	説明
8		通信キー	コンピューターの通信機器を有効/無効にします (通信機器は、構成内容によって異なります)。
		バックアップキー	わずか3ステップでデータをバックアップできる、Acer Backup Management を起動します。
		HDD インジケータ <sup>1</sup>	ハードディスクドライブがアクティブになると点灯します。
		電源インジケータ <sup>1</sup>	PCの電源がオンのときに点灯します。
9		クリックボタン (左、右)	左右のボタンはマウスの左右のボタンと同じように機能します。
10		パームレスト	コンピューター操作時に手を置く場所です。
11		Acer Bio-Protection 指紋読み取り装置	Acer FingerNav 4 方向操作機能に対応しています (特定モデルのみ)。
12		スピーカー	ステレオオーディオを出力します。
13		電源ボタン	コンピューターの電源をオン/オフにします。

1. フロントパネルのインジケータは、コンピューターカバーが閉じた状態でも見えるようになっています。

## ホットキー

このコンピューターでは、ホットキーや2つ以上のキーを組み合わせることで、画面の輝度や出力音量など、コンピューターのほとんどのコントロールを調整することができます。

ホットキーを利用するときは、<Fn> キーを押しながら、ホットキーの組み合わせとなる、もう1つのキーを押してください。

ホットキー	アイコン	機能	説明
<Fn> + <F3>		通信キー	コンピューターの通信機器を有効/無効にします(通信機器は、構成内容によって異なります)。
<Fn> + <F4>		スリープ	PCをスリープモードに切り替えます。
<Fn> + <F5>		ディスプレイ切り替え	ディスプレイ出力を、ディスプレイスクリーン、外付けモニター(接続されている場合)、またはその両方に切り替えます。
<Fn> + <F6>		画面空白	ディスプレイのバックライトをオフにして、電源を節約します。キーをどれか押すと、バックライトはオンになります。
<Fn> + <F7>		タッチパッドON/OFF	内蔵タッチパッドをオン/オフにします。
<Fn> + <F8>		スピーカーON/OFF	スピーカーをオン/オフにします。
<Fn> + <D>		輝度を上げる	画面輝度が上がります。
<Fn> + <C>		輝度を下げる	画面輝度が下がります。
<Fn> + <Home>		再生/一時停止	選択したメディアファイルを再生または一時停止します。
<Fn> + <Pg Up>		中止	選択したメディアファイルの再生を中止します。
<Fn> + <Pg Dn>		戻る	前のメディアファイルに戻ります。
<Fn> + <End>		次へ	次のメディアファイルに移動します。

## 正面（閉じた場合）



#	アイコン	アイテム	説明
1		サムホイール	ボリュームを調整します。
2		1 台多機能の カードリーダー	Secure Digital (SD)、MultiMediaCard (MMC)、Memory Stick (MS)、Memory Stick PRO (MS PRO)、xD-Picture Card (xD) に対応しています。 <b>注意：</b> 押すと、カードの取り出し / 挿入ができません。一度に 1 枚のカードしか操作できません。
3		CIR 受信装置	リモコンから信号を受信します。



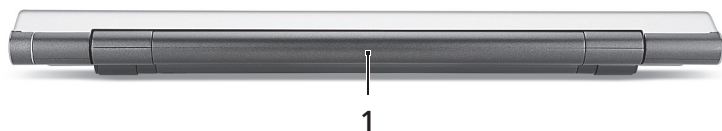



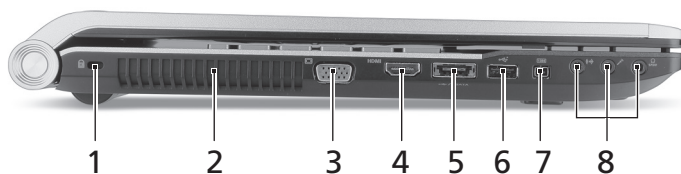

## 背面

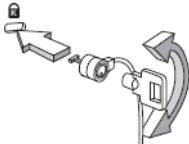

#	アイコン	アイテム	説明
1		バッテリーベイ	コンピューターのバッテリーパックを装着します。





## 左面

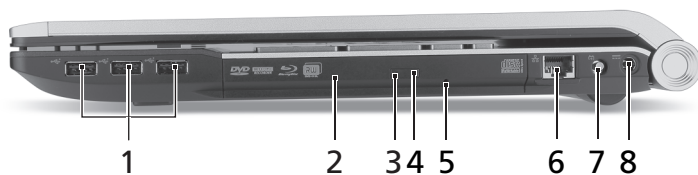

#	アイコン	アイテム	説明
1		Kensington ロックスロット 	Kensington 対応コンピューターセキュリ ティロックに接続します。 <b>注意：</b> コンピューター用安全ロックの ケーブルを机やロックした引き出しの 取っ手などの動かないものにつなぎます。 ロックをセキュリティキーロックノッチ に挿入し、キーをまわしてロックを固定 してください。キーを使用しないモデルも あります。
2		通気孔	長時間使用してもコンピューターが過熱 しないよう冷却します。
3		外部ディスプレイ (VGA) ポート	ディスプレイデバイスに接続します (外付けモニター、LCD プロジェクタなど)。
4	HDMI	HDMI ポート	高性能デジタルビデオ接続対応します。
5	 /e SATA	USB 2.0/eSATA ポート	USB 2.0/eSATA デバイスを接続します (特定モデルのみ)。 <b>注意：</b> eSATA デバイスを接続すると、 同時に 3 つの USB ポートが有効になり ます。
6		USB 2.0 ポート	USB 2.0 デバイスに接続します (USB マウス、USB カメラなど)。
7		4-pin IEEE 1394 ポート	IEEE 1394 デバイスを接続します。
8		入力ジャック	オーディオ入力デバイスを接続します (オーディオ CD プレーヤー、ステレオ ウォークマン、mp3 プレーヤーなど)。
		マイクロフォン 入力ジャック	外部マイクロフォンを接続します。
		ヘッドフォン/ スピーカー/ S/PDIF 対応出力 ジャック	オーディオ出力デバイスを接続します (スピーカー、ヘッドフォンなど)。

## 右面









#	アイコン	アイテム	説明
1		USB 2.0 ポート	USB 2.0 デバイスを接続します (USB マウス、USB カメラなど)。
2		光学ドライブ	内部光学ドライブ (CD および DVD に対応)。
3		光学ディスクアクセスインジケータ	光学ドライブが使用中のときには点灯します。
4		光学ドライブイジェクトボタン	ドライブから光学ディスクを取り出します。
5		緊急用イジェクトホール	コンピューターがオフになっているときに、光学ドライブトレイを引き出します。 <b>注意：</b> コンピューターがオフの状態の場合は、緊急用イジェクトホールにペーパーリップを差し込むと光学ドライブトレイが出てきます。
6		Ethernet (RJ-45) ポート	Ethernet 10/100/1000 ベースのネットワークに接続します。
7		RF 入力ポート	デジタル TV チューナーから入力信号を受信します (特定モデルのみ)。
8		DC 入力ジャック	AC アダプタに接続します。



## 底面



#	アイコン	アイテム	説明
1		バッテリーベイ	コンピューターのバッテリーパックを装着します。
2		サブウーファー	低周波音を出力します。
3		バッテリー取り外しつまみ	バッテリーを取り出します。
4		メモリコンパートメント	コンピューターのメインメモリを装着します。
5		ハードディスクベイ - メイン	コンピューターのハードディスクを装着します (ネジで固定)。
6		スピーカー	ステレオオーディオを出力します。
7		ハードディスクベイ - セカンダリ	コンピューターのハードディスクを装着します (ネジで固定) (特定モデルのみ)。
8		バッテリーロック	バッテリーを定位置にロックします。

## 環境

---

- 温度：
    - 操作時：5°C ~ 35°C
    - 非操作時：-20°C ~ 65°C
  - 湿度（結露しないこと）：
    - 操作時：20% ~ 80%
    - 非操作時：20% ~ 80%
-

# Acer 노트북

빠른 시작 설명서

© 2010 All Rights Reserved.

Acer 노트북 빠른 시작 설명서  
최초 발행일 : 03/2010

모델 번호 : \_\_\_\_\_

일련 번호 : \_\_\_\_\_

구입 날짜 : \_\_\_\_\_

구입 장소 : \_\_\_\_\_

# 사용 전 유의 사항

Acer 노트북을 선택해주셔서 감사합니다. 이 노트북이 귀하의 모바일 컴퓨팅 요구를 충족시켜 드릴 것입니다.

## 제공되는 설명서

Acer 노트북을 사용하는 데 도움을 줄 수 있는 여러 설명서가 제공됩니다:

우선 **사용을 위한 준비** 포스터는 컴퓨터 설정을 시작하는 데 유용합니다.

**Aspire 시리즈 일반 사용 설명서**에는 Aspire 제품 시리즈의 모든 모델에 적용되는 유용한 정보가 포함되어 있습니다. 이 설명서에서는 키보드 사용, 오디오 등과 같은 기본적인 주제를 다룹니다. 설명서의 특성상, 아래 언급된 **AcerSystem 사용 설명서 및 일반 사용 설명서**에는 이 시리즈의 특정 모델에만 있고 귀하가 구입한 모델에는 없는 기능 또는 특징에 대한 설명이 포함되어 있을 수 있음을 양지하십시오. 그러한 부분에는 "특정 모델에만 해당"과 같은 텍스트가 표시되어 있습니다.

**빠른 시작 설명서**에서는 새 컴퓨터의 기본 특징 및 기능을 소개합니다. 컴퓨터를 좀 더 생산적으로 활용하는 방법에 대한 자세한 내용은 **AcerSystem 사용 설명서**를 참조하십시오. 이 설명서에서는 시스템 유틸리티, 데이터 복구, 확장 옵션 및 문제 해결과 같은 주제를 자세하게 설명합니다. 또한 노트북에 대한 일반 규정과 안전 주의 사항 및 보증 정보가 포함되어 있습니다. 이 설명서는 PDF (Portable Document Format) 파일로 제공되며 노트북에 이미 설치되어 있습니다. 이 설명서에 액세스하려면 다음 단계를 수행하십시오.

- 1  **Start (시작) > All Programs (모든 프로그램) > AcerSystem** 을 클릭합니다.
- 2 **AcerSystem 사용 설명서**를 클릭합니다.



.....

**참고:** 이 파일을 보려면 Adobe Reader 가 필요합니다. 컴퓨터에 Adobe Reader 가 설치되어 있지 않은 경우 **AcerSystem 사용 설명서**를 클릭하면 자동으로 Adobe Reader 설치 프로그램이 실행됩니다. 화면의 지시에 따라 나머지 설치 과정을 완료합니다. Adobe Reader 사용 방법에 대한 지침을 보려면 **Help and Support** (도움말 및 지원) 메뉴에 액세스하십시오.







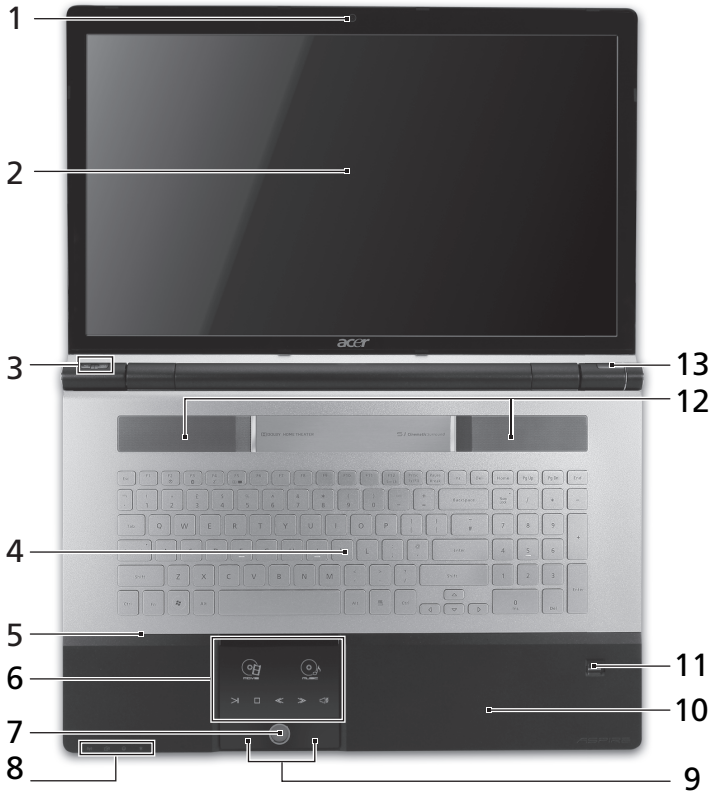



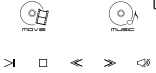















# Acer 노트북 둘러보기

사용을 위한 준비 포스터에 설명된 대로 컴퓨터를 설치했으면 이제 새 Acer 노트북을 살펴볼 차례입니다.

## 위에서 본 모습



#	아이콘	항목	설명
1		Acer Crystal Eye 웹캠	비디오 통신용 웹 카메라입니다 (특정 모델에만 해당).
2		디스플레이 화면	LCD (액정 디스플레이) 라고도 하며, 컴퓨터 출력을 표시합니다 (구성은 모델에 따라 다를 수 있습니다).

#	아이콘	항목	설명																					
3		Arcade 키	InstantOn Arcade 를 실행합니다 .																					
		P 키 /Acer PowerSmart 키	프로그램 가능 키 ( 구성은 모델에 따라 다릅니다 )/ 컴퓨터를 절전 모드로 전환합니다 ( 구성은 모델에 따라 다릅니다 ).																					
4		키보드	컴퓨터에 데이터를 입력하는 데 사용됩니다 .																					
5		마이크	소리를 녹음할 수 있는 내부 마이크입니다 .																					
6		터치패드 / 미디어 콘솔	<p>컴퓨터의 마우스와 같은 기능을 하는 터치 감지 포인팅 장치 */ <b>Acer Arcade</b>, 볼륨 ( 올림 / 내림 ) 및 미디어 ( 재생 / 일시 중지, 중지, 이전, 다음 ); 음소거를 위한 터치 감지 제어 기능 .</p> <table border="1"> <tr> <td></td> <td>동영상</td> <td>동영상 재생 소프트웨어를 실행합니다 .</td> </tr> <tr> <td></td> <td>음악</td> <td>음악 재생 소프트웨어를 실행합니다 .</td> </tr> <tr> <td></td> <td>재생 / 일시 중지</td> <td>선택된 미디어 파일을 재생 또는 일시 중지합니다 .</td> </tr> <tr> <td></td> <td>중지</td> <td>선택된 미디어 파일 재생을 중지합니다 .</td> </tr> <tr> <td></td> <td>이전</td> <td>이전 미디어 파일로 돌아갑니다 .</td> </tr> <tr> <td></td> <td>다음</td> <td>다음 미디어 파일로 이동합니다 .</td> </tr> <tr> <td></td> <td>음소거</td> <td>볼륨을 켜거나 끕니다 .</td> </tr> </table> <p>* 미디어 콘솔을 활성화하면 터치패드는 비활성화됩니다 .</p>		동영상	동영상 재생 소프트웨어를 실행합니다 .		음악	음악 재생 소프트웨어를 실행합니다 .		재생 / 일시 중지	선택된 미디어 파일을 재생 또는 일시 중지합니다 .		중지	선택된 미디어 파일 재생을 중지합니다 .		이전	이전 미디어 파일로 돌아갑니다 .		다음	다음 미디어 파일로 이동합니다 .		음소거	볼륨을 켜거나 끕니다 .
	동영상	동영상 재생 소프트웨어를 실행합니다 .																						
	음악	음악 재생 소프트웨어를 실행합니다 .																						
	재생 / 일시 중지	선택된 미디어 파일을 재생 또는 일시 중지합니다 .																						
	중지	선택된 미디어 파일 재생을 중지합니다 .																						
	이전	이전 미디어 파일로 돌아갑니다 .																						
	다음	다음 미디어 파일로 이동합니다 .																						
	음소거	볼륨을 켜거나 끕니다 .																						
7		미디어 콘솔 컨트롤러	미디어 콘솔을 켜거나 끕니다 .																					
8		통신 키	컴퓨터의 통신 장치를 활성화/비활성화합니다 . ( 통신 장치는 구성에 따라 다를 수 있습니다 . )																					
		백업 키	<b>Acer Backup Management</b> 를 실행하여 3 단계로 데이터를 백업합니다 .																					
		HDD 표시등 <sup>1</sup>	하드 디스크 드라이브가 동작 중이면 불이 켜집니다 .																					
		전원 표시등 <sup>1</sup>	컴퓨터의 전원 상태를 표시합니다 .																					
9		누름 단추들 ( 왼쪽 및 오른쪽 )	왼쪽과 오른쪽의 단추는 마우스의 왼쪽 및 오른쪽 단추와 같은 역할을 합니다 .																					

#	아이콘	항목	설명
10		손목 받침대	컴퓨터를 사용할 때 편안하게 손을 올려 놓는 영역입니다.
11		Acer Bio-Protection 지문 판독기	Acer FingerNav 4 방향 제어 기능을 지원합니다 (특정 모델에만 해당).
12		스피커	스테레오 오디오 출력을 제공합니다.
13		전원 단추	컴퓨터를 켜고 끕니다.

1. 전면 패널 표시등은 컴퓨터 덮개를 닫은 상태에서도 볼 수 있습니다.





## 바로 가기 키

컴퓨터에서는 화면 밝기와 볼륨 출력 같은 대부분의 컴퓨터 컨트롤에 액세스하기 위해 바로 가기 키 또는 키 조합이 사용됩니다.

바로 가기 키를 활성화하려면 바로 가기 키 조합의 다른 키를 누르기 전에 <Fn> 키를 누릅니다.

바로 가기 키	아이콘	기능	설명
<Fn> + <F3>		통신 키	컴퓨터의 통신 장치를 활성화 / 비활성화합니다. (통신 장치는 구성에 따라 다를 수 있습니다.)
<Fn> + <F4>		절전	컴퓨터를 절전 모드로 설정합니다.
<Fn> + <F5>		디스플레이 전환	디스플레이 출력을 디스플레이 화면, 외부 모니터 (연결된 경우) 또는 둘다에 보내도록 선택합니다.
<Fn> + <F6>		화면 끄기	전원을 절약하기 위해 디스플레이 화면의 백라이트를 끕니다. 화면을 다시 켜려면 임의의 키를 누릅니다.
<Fn> + <F7>		터치패드 전환	내부 터치패드를 켜고 끕니다.
<Fn> + <F8>		스피커 전환	스피커를 켜고 끕니다.
<Fn> + <↵>		밝게	화면 밝기를 증가시킵니다.
<Fn> + <⇐>		어둡게	화면 밝기를 감소시킵니다.



바로 가기 키	아이콘	기능	설명
<Fn> + <Home>		재생 / 일시 중지	선택된 미디어 파일을 재생 또는 일시 중지합니다.
<Fn> + <Pg Up>		중지	선택된 미디어 파일 재생을 중지합니다.
<Fn> + <Pg Dn>		이전	이전 미디어 파일로 돌아갑니다.
<Fn> + <End>		다음	다음 미디어 파일로 이동합니다.

## 닫힌 상태의 앞 모습



#	아이콘	항목	설명
1		썬힐	볼륨을 높이거나 낮춥니다.
2		멀티 카드 판독기	Secure Digital (SD), MultiMediaCard (MMC), Memory Stick (MS), Memory Stick PRO (MS PRO) 및 xD-Picture Card (xD) 를 사용할 수 있습니다. <b>참고 :</b> 카드를 눌러 제거 또는 설치합니다. 카드를 한 번에 하나만 사용할 수 있습니다.
3		CIR 수신기	리모컨에서 보내는 신호를 수신합니다.



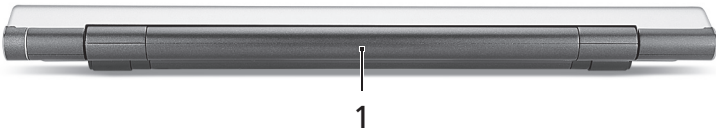



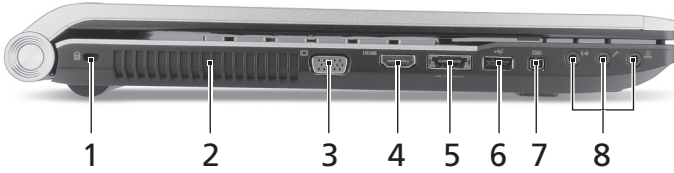

## 뒤쪽 모습



#	아이콘	항목	설명
1		배터리 장착부	컴퓨터의 배터리 팩을 넣습니다.





## 왼쪽 모습

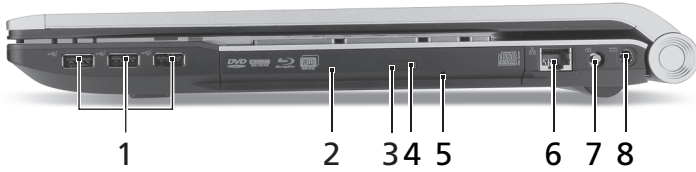

#	아이콘	항목	설명
1		Kensington 잠금 장치 슬롯	Kensington 호환 컴퓨터 보호용 잠금 장치를 연결합니다. <b>참고</b> : 테이블이나 잠긴 서랍의 손잡이 같은 고정된 물체에 컴퓨터 보호용 케이블을 맵니다. 노치에 자물쇠를 걸고 열쇠를 돌려 잠급니다. 열쇠가 없는 모델을 사용할 수도 있습니다.
2		통용용 슬롯	장시간 사용한 후에도 컴퓨터를 차갑게 유지할 수 있습니다.
3		외부 디스플레이 (VGA) 포트	디스플레이 장치 (예 : 외부 모니터 , LCD 프로젝터 ) 를 연결합니다 .
4	HDMI	HDMI 포트	고선명 디지털 비디오 연결을 지원합니다 .
5		USB 2.0/e SATA 포트	USB 2.0 또는 eSATA 장치에 연결합니다 ( 특정 모델에만 해당 ). <b>참고</b> : eSATA 장치를 연결하는 경우 세 개의 USB 포트를 사용할 수 있습니다 .
6		USB 2.0 포트	USB 2.0 장치 ( 예 : USB 마우스 , USB 카메라 ) 에 연결합니다 .
7		4 핀 IEEE 1394 포트	IEEE 1394 장치에 연결합니다 .
8		입력 잭	오디오 입력 장치 ( 예 : 오디오 CD 플레이어 , 스테레오 워크맨 , mp3 플레이어 ) 를 연결합니다 .
		마이크 입력 잭	외부 마이크로 소리를 입력할 때 사용합니다 .
		헤드폰 / 스피커 / 출력 잭 (SPDIF 지원)	오디오 출력 장치에 연결합니다 ( 예 : 스피커 , 헤드폰 ) .







## 오른쪽 모습

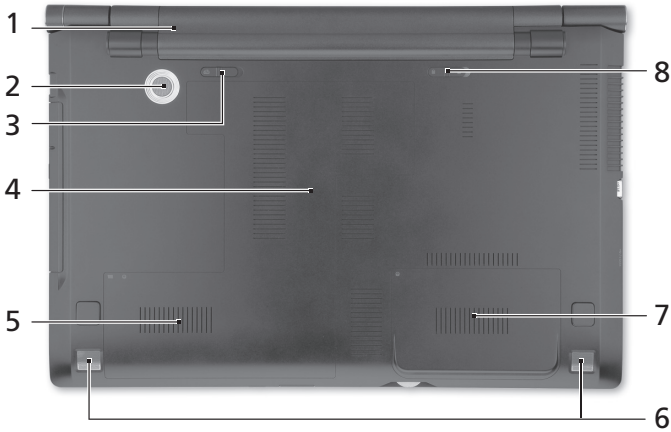

#	아이콘	항목	설명
1		USB 2.0 포트	USB 2.0 장치 ( 예 : USB 마우스 , USB 카메라 ) 에 연결합니다 .
2		광드라이브	내부 광드라이브 . CD 또는 DVD 를 넣습니다 .
3		광디스크 액세스 표시등	광드라이브가 작동 중이면 불이 켜집니다 .
4		광드라이브 꺼내기 단추	드라이브에서 광디스크를 꺼냅니다 .
5		비상용 꺼내기 구멍	컴퓨터가 꺼졌을 때 광드라이브 트레이를 꺼낼 수 있습니다 . <b>참고 :</b> 컴퓨터가 꺼졌을 때 클립을 비상용 꺼내 기 구멍에 삽입하여 광드라이브 트레이를 꺼내 십시오 .
6		이더넷 (RJ-45) 포트	10/100/1000 이더넷 네트워크에 연결합니다 .
7		RF 입력 포트	디지털 TV 튜너 장치에서 나오는 신호를 수신 합니다 ( 특정 모델에만 해당 ) .
8		DC 입력 잭	AC 어댑터에 연결합니다 .

## 바닥 모습



#	아이콘	항목	설명
1		배터리 장착부	컴퓨터의 배터리 팩을 넣습니다.
2		서브우퍼	저주파 사운드를 출력합니다.
3		배터리 제거용 래치	제거를 위해 배터리를 뺄 때 사용합니다.
4		메모리 장착부	컴퓨터의 주 메모리를 넣습니다.
5		하드 디스크 장착부 - 주	컴퓨터의 하드 디스크를 넣습니다 (나사로 고정).
6		스피커	스테레오 오디오 출력을 제공합니다.
7		하드 디스크 장착부 - 보조	컴퓨터의 하드 디스크를 넣습니다 (나사로 고정) (특정 모델에만 해당).
8		배터리 잠금	장착된 배터리를 빠지지 않도록 잠급니다.

## 환경

---

- 온도 :
    - 작동 : 5°C - 35°C
    - 비작동 : -20°C - 65°C
  - 습도 (비응축):
    - 작동 : 20% - 80%
    - 비작동 : 20% - 80%
-



# Acer 筆記型電腦

快速使用指南

© 2010 版權所有

Acer 筆記型電腦快速指南  
初版：2010 年 3 月

產品型號： \_\_\_\_\_

產品序號： \_\_\_\_\_

購買日期： \_\_\_\_\_

購買地點： \_\_\_\_\_



# 首要之務

首先，非常感謝您選擇 Acer 筆記型電腦，成為您行動運算生活的最佳夥伴。

## 使用指南

為協助您順利使用 Acer 筆記型電腦，我們特地設計了以下的使用指南：

首先，**入門者專用 ...** 海報可以協助您開始設定您的電腦。

**Aspire 系列一般使用指南**內含有用的資訊，適用於 Aspire 產品系列的所有機型。其中涵蓋基本主題，例如使用鍵盤、音訊等。請注意，由於其性質不同，以下提及的**一般使用指南**和 **AcerSystem User Guide** 可能會參考到只有特定系列機型所含的功能或特點，而您所購買的機型不一定會包含這些功能。這些情況會以如「僅適用於特定機型」的文字加以標註。

本**快速使用指南**介紹了本電腦的基本特性和功能。有關本電腦如何幫助您提高效率的資訊，請參閱 **AcerSystem User Guide**。本手冊包含系統公用程式、資料復原、擴充選項和疑難排解等詳細資訊。此外，本手冊也提供保固資訊和本電腦的一般規格和安全注意事項。另外，本電腦也預先載入了本使用手冊的 PDF (Portable Document Format) 格式檔案。若要開啓此 PDF 檔案，請依下列步驟操作：

- 1 按一下  **開始 > 所有程式 > AcerSystem**。
- 2 按一下 **AcerSystem User Guide**。



.....



**注意：**要閱讀 PDF 檔案時，必須先安裝 Adobe Reader。如果您的系統沒有安裝 Adobe Reader，按一下 **AcerSystem User Guide** 會先執行 Adobe Reader 設定程式。請依畫面指示說明完成安裝。如需使用 Adobe Reader 的指示，請點選 **說明和支援**功能表以獲得更詳細的使用說明。





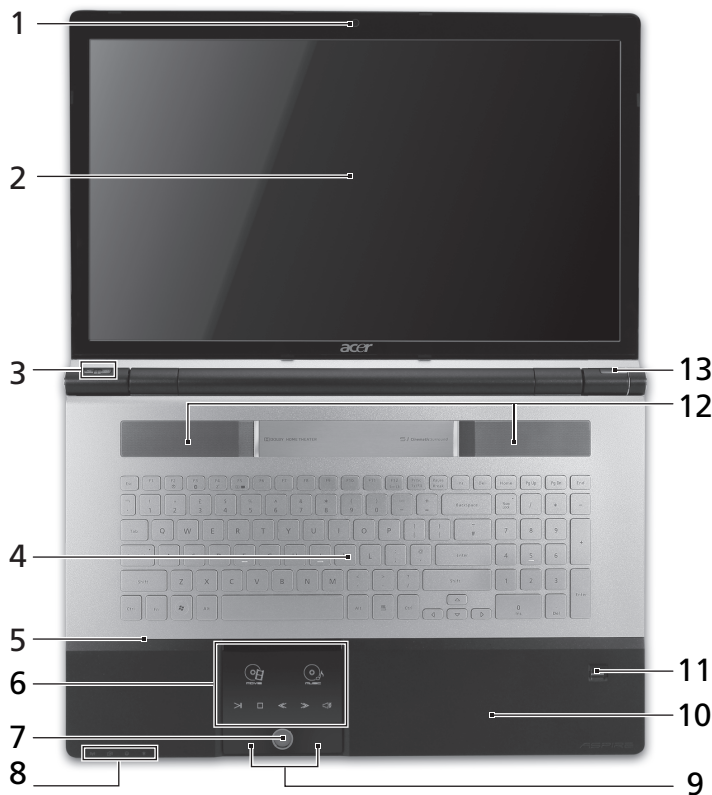









# Acer 筆記型電腦導覽

依據「入門者專用...」海報的圖解設置好電腦後，現在就讓我們帶您好認識您全新的 Acer 筆記型電腦。

## 上視圖



#	圖示	項目	說明
1		Acer Crystal Eye 網路攝影機	網路攝影機，可用於視訊通訊 (僅適用於特定機型)。
2		顯示螢幕	亦稱為液晶顯示器 (Liquid-Crystal Display : LCD)，用於顯示電腦資料的輸出 (設定將依機 型而有所不同)。









#	圖示	項目	說明
3		Arcade 鍵	啓動 InstantOn Arcade。
	P	P 鍵 /Acer PowerSmart 鍵	自訂功能鍵 (設定將依機型而有所不同)。/讓電腦進入省電模式 (設定將依機型而有所不同)。
4		鍵盤	可用來將資料輸入電腦。
5		麥克風	內建的麥克風,用於錄音。
6		觸控板 / 媒體主控台	觸控感應式移動游標裝置,功能等同於電腦的滑鼠*。/Acer Arcade 感應觸碰式控制按鍵,有 (提高 / 降低) 音量和媒體 (播放 / 暫停、停止、上一首、下一首) 功能,以及靜音鍵。
		電影	啓動電影播放軟體。
		音樂	啓動音樂播放軟體。
		播放 / 暫停	播放或暫停選取的媒體檔。
		停止	停止播放選取的媒體檔。
		上一個	返回上一個媒體檔。
		下一個	跳到下一個媒體檔。
		靜音	開啓或關閉音量。
			* 觸控板無法在啓動媒體主控台時使用。
7		媒體主控台控制器	開啓或關閉媒體主控台。
8		通訊鍵	啓用 / 停用電腦的通訊裝置。 (通訊裝置可能根據組態而有所不同。)
		備份鍵	啓動 Acer Backup Management, 以執行三步驟的資料備份程序。
		硬碟指示燈 <sup>1</sup>	當存取硬碟時,指示燈會亮起。
		電源指示燈 <sup>1</sup>	表示電腦的電源狀態。
9		點選鍵 (左和右)	左鍵和右鍵的功能等同於滑鼠的左鍵和右鍵。
10		腕靠	讓您在 使用電腦時,可舒適擺放手腕的位置。
11		Acer Bio-Protection 指紋辨識器	支援 Acer FingerNav 四向控制功能 (僅適用於特定機型)。
12		喇叭	傳送立體聲音效輸出。
13		電源鍵	開啓和關閉電腦。

1. 即使在電腦螢幕關上時,您依然可看見位於前面板的狀態指示燈。

## 快速鍵

利用此電腦的快捷鍵或組合鍵可存取大部分的控制指令，例如：螢幕亮度和音量輸出。

若要使用快速鍵，請先按住 <Fn> 鍵，再按下組合鍵的另一按鍵。

快速鍵	圖示	功能	說明
<Fn> + <F3>		通訊鍵	啓用 / 停用電腦的通訊裝置。 (通訊裝置可能根據組態而有所不同。)
<Fn> + <F4>		睡眠	讓電腦進入睡眠模式。
<Fn> + <F5>		螢幕顯示切換	在螢幕及外接顯示器 (如有連接) 之間切換，或同時顯示。
<Fn> + <F6>		螢幕空白	關閉顯示螢幕背光，以節省電力。 按下任意鍵即可返回。
<Fn> + <F7>		觸控板切換鈕	開啓和關閉內建的觸控板。
<Fn> + <F8>		喇叭切換鈕	開啓和關閉喇叭。
<Fn> + <↑>		調高亮度	調高螢幕亮度。
<Fn> + <↓>		調低亮度	調低螢幕亮度。
<Fn> + <Home>		播放 / 暫停	播放或暫停選取的媒體檔。
<Fn> + <Pg Up>		停止	停止播放選取的媒體檔。
<Fn> + <Pg Dn>		上一個	返回上一個媒體檔。
<Fn> + <End>		下一個	跳到下一個媒體檔。

## 上蓋闔起的前視圖



#	圖示	項目	說明
1		滾輪	提高或降低音量。
2		多合一讀卡機	可支援 Secure Digital (SD)、MultiMediaCard (MMC)、Memory Stick (MS)、Memory Stick PRO (MS PRO)、xD-Picture Card (xD)。 <b>注意：</b> 輕壓即可移除 / 安裝卡片。無論何時皆只能使用一張卡片。
3		CIR 接收器	接收從遠端控制裝置所輸入的訊號。



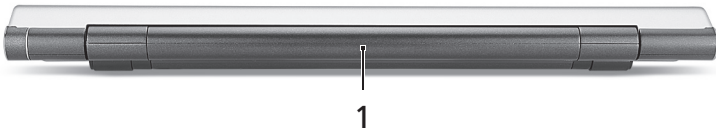



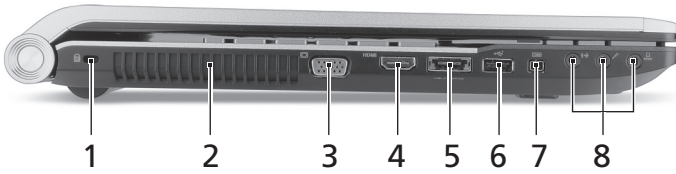

## 後視圖

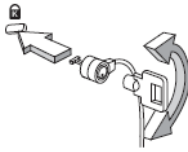

#	圖示	項目	說明
1		電池槽	用於安裝電腦的電池組。





## 左視圖

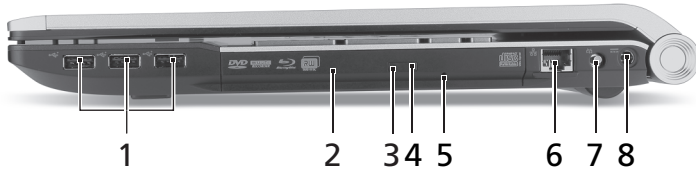

#	圖示	項目	說明
1		Kensington 安全鎖插槽 	連接到與 Kensington 相容的電腦安全鎖。 <b>注意：</b> 將電腦安全鎖電纜線繞著無法移動的物品打個圈；例如：桌子或鎖住的抽屜把手。再將鎖插入鎖孔中，並轉動鑰匙以便上鎖。此外，還有些無鑰匙安全鎖的型號可供使用者選擇。
2		散熱孔	可讓電腦在長時間使用後仍然能夠保持冷卻狀態。
3		外接顯示螢幕 (VGA) 連接埠	連接到顯示器裝置 (例如：外接式顯示器、LCD 投影機)。
4	HDMI	HDMI 埠	支援高清晰度數位視訊連線。
5		USB 2.0/eSATA 埠	連接到 eSATA 裝置 (僅適用於特定機型)。 <b>注意：</b> 若將 eSATA 裝置插入，則同時擁有二個 USB 埠可供使用。
6		USB 2.0 埠	連接至 USB 2.0 裝置 (例如：USB 滑鼠、USB 網路攝影機)。
7		IEEE 1394 埠 (4-pin)	連接 IEEE 1394 裝置。
8		音訊輸入插孔	連接外接音訊輸入裝置的插孔 (例如：CD 音樂播放器、立體隨身聽、MP3 播放器)。
		麥克風輸入插孔	接受從外接麥克風所輸入的聲音。
		耳機 / 喇叭 / 音訊輸出插孔 (支援 S/PDIF)	連接到外接音訊裝置 (例如：喇叭、耳機)。







## 右視圖

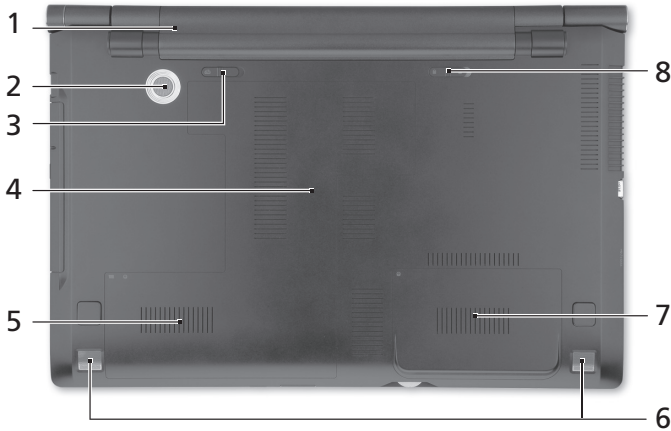

#	圖示	項目	說明
1		USB 2.0 埠	連接至 USB 2.0 裝置 (例如：USB 滑鼠、USB 網路攝影機)。
2		光碟機	內部光碟機，可放入 CD 或 DVD。
3		光碟存取指示燈	當正在存取光碟時，指示燈會亮起。
4		光碟退出鍵	可將光碟從光碟機中退出。
5		緊急退出孔	可在電腦關機狀態下退出光碟機托盤。 <b>注意：</b> 在電腦關機時將迴紋針插入緊急退出孔，即可退出光碟機托盤。
6		乙太網路 (RJ-45) 連接埠	連接到以 10/100/1000 為基礎的乙太網路。
7		RF 輸入埠	可接收來自數位電視卡裝置的輸入訊號 (僅適用於特定機型)。
8		DC 輸入插孔	連接到 AC 變壓器。

## 底視圖



#	圖示	項目	說明
1		電池槽	用於安裝電腦的電池組。
2		重低音	重低音音效輸出。
3		電池卸除卡榫	用於卸下電池組。
4		記憶體槽	用於安裝電腦的主記憶體。
5		主要硬碟槽	用於安裝電腦的硬碟 (以螺絲鎖定)。
6		喇叭	傳送立體聲音效輸出。
7		次要硬碟槽	安裝電腦硬碟的位置 (以螺絲鎖定) (僅適用於特定機型)。
8		電池組固定鎖	可將電池鎖到定位。

## 環境

- 溫度：
  - 操作中：5°C 到 35°C
  - 非操作中：-20°C 到 65°C
- 溼度 (非凝滯狀態)：
  - 操作中：20% 到 80%
  - 非操作中：20% 到 80%



# Acer 笔记本电脑

快速指南

© 2010 保留所有权利

Acer 笔记本电脑快速指南  
初版发行日期：2010 年 3 月

产品型号： \_\_\_\_\_

产品序号： \_\_\_\_\_

购买日期： \_\_\_\_\_

购买地点： \_\_\_\_\_

# 使用入门

感谢您选购 Acer 笔记本电脑，让它成为您行动运算生活的最得力助手。

## 用户指南

为帮助您设置和使用 Acer 笔记本电脑，我们为您设计了以下用户指南：  
首先请按照电脑所附带的**入门指南 ... 彩图**来安装电脑。

**Aspire 系列普通用户指南**包含了关于 Aspire 产品系列所有型号的有用信息。该手册包括键盘和音频的使用方法等基本内容。请注意，鉴于手册的性质，**普通用户指南**和下文中提到的 **AcerSystem User Guide** 偶尔也会提及本系列产品中部分型号专有的功能或特性，但您购买的型号不一定具有这些功能或特性。以上情况会以“仅限部分型号”等字样在文中注明。

这份**快速指南**向您介绍新电脑的基本特性和功能。要了解您的电脑如何能够帮助您更加具有效益详情，请参见 **AcerSystem User Guide**。本指南包含了诸如系统实用程序、数据恢复、扩展选项和疑难解答等信息。此外，它还包含了保修信息和笔记本电脑的一般规则和安全注意事项。我们也提供了 PDF 格式的用户指南并已预先安装在本电脑中供用户参考，请按下列步骤操作来查看该 PDF：

- 1 单击  **开始 > 所有程序 > AcerSystem**。
- 2 单击 **AcerSystem User Guide**。



.....



**注：**查看 PDF 文件需要预先安装 Adobe Reader。如果您的电脑没有预先安装 Adobe Reader 单击 **AcerSystem User Guide** 后将会先启动 Adobe Reader 安装程序。依屏幕上指导完成安装程序。要获得如何使用 Adobe Reader 的指导，请使用**帮助和支持**菜单。





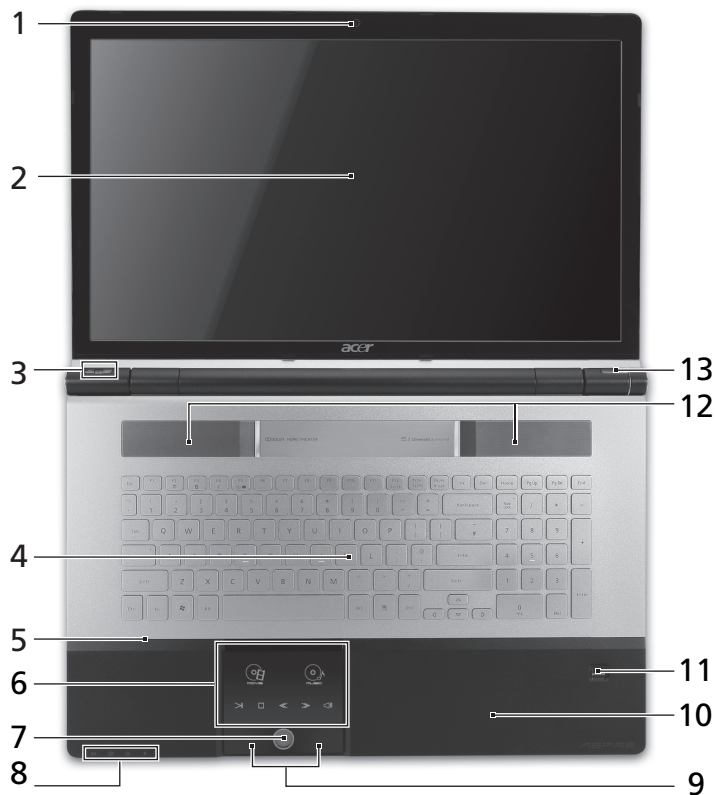











# 熟悉 Acer 笔记本电脑

当您根据“入门指南...”海报页中的图例安装完电脑后，接着就让我们一起来熟悉您的 Acer 笔记本电脑。

## 俯视图



#	图标	项目	描述
1		Acer Crystal Eye 摄像头	用于视频通信的摄像头 (仅限部分型号)。
2		显示屏	也称液晶显示屏 (Liquid-Crystal Display : LCD)，用于显示电脑的输出内容 (不同型号配置可能有所不同)。













#	图标	项目	描述
3		Arcade 键	启动 InstantOn Arcade。
		P 键 /Acer PowerSmart 键	编程键 (不同型号配置可能有所不同)。/ 让计算机进入省电模式 (不同型号配置可能有所不同)。
4		键盘	将数据输入到电脑中。
5		麦克风	用于录音的内置麦克风。
6	 	触控板 / 媒体控制台	<p>触摸式定位设备, 功能和电脑鼠标相同 *。/ Acer Arcade、音量 (高/低) 和媒体 (播放 / 暂停、停止、上一个、下一个) 的触摸式控制按钮, 并具有静音功能。</p> <p> 电影 启动电影播放软件。</p> <p> 音乐 启动音乐播放软件。</p> <p> 播放 / 暂停 播放或暂停选定媒体文件。</p> <p> 停止 停止播放选定媒体文件。</p> <p> 上一个 返回上一个媒体文件。</p> <p> 下一个 跳至下一个媒体文件。</p> <p> 静音 打开或关闭音量。</p>
			
			* “媒体控制台”启用时不可使用触控板。
7		“媒体控制台” 控制器	打开或关闭“媒体控制台”。
8		通信键	启用 / 禁用计算机的通信设备。 (通信设备根据配置可能有所不同。)
		备份键	启动 Acer Backup Management 进行三个步骤的数据备份。
		硬盘指示灯 <sup>1</sup>	硬盘活动时, 该指示灯亮。
		电源指示灯 <sup>1</sup>	根据亮灯情况可检视目前电脑电源的状态。
9		单击按钮 (左和右)	左右按钮的功能与鼠标的左右键相同。
10		掌垫板	当您使用电脑时, 可舒适支撑手部的区域。
11		Acer Bio-Protection 指纹读取器	支持 Acer FingerNav 四向控制功能 (仅限部分型号)。
12		扬声器	提供立体声音频输出。
13		电源键	用于打开和关闭计算机电源。

1. 即使在 LCD 显示屏关闩上也能看到前面板处的状态指示灯。

## 热键





本款电脑提供热键或组合键来实现许多操控，例如：调节屏幕亮度以及音量输出。

要激活热键，先按住 <Fn> 键，然后再按热键组合中的另一个键。

热键	图标	功能	描述
<Fn> + <F3>		通信键	启用 / 禁用计算机的通信设备。 (通信设备根据配置可能有所不同。)
<Fn> + <F4>		睡眠	让电脑进入睡眠模式。
<Fn> + <F5>		显示屏幕切换	可以在以下三种显示方式间切换： 只使用显示屏、只使用已连接的外部显示器、同时使用显示屏和外部显示器。
<Fn> + <F6>		屏幕空白	关闭显示屏背光以节省电量。 按任意键将恢复正常显示。
<Fn> + <F7>		触摸板切换	打开或关闭内置触控板。
<Fn> + <F8>		扬声器切换	打开或关闭扬声器。
<Fn> + <↵>		调高亮度	调高屏幕亮度。
<Fn> + <⇩>		调低亮度	调低屏幕亮度。
<Fn> + <Home>		播放 / 暂停	播放或暂停选定媒体文件。
<Fn> + <Pg Up>		停止	停止播放选定媒体文件。
<Fn> + <Pg Dn>		上一个	返回上一个媒体文件。
<Fn> + <End>		下一个	跳至下一个媒体文件。

## 前视图



#	图标	项目	描述
1		滚轮	调高或调低音量。
2	    	多合 1 读卡器	可支持 Secure Digital (SD)、MultiMediaCard (MMC)、Memory Stick (MS)、Memory Stick PRO (MS PRO)、xD-Picture Card (xD)。 <b>注：</b> 轻推取下 / 安装卡。任何时候，仅支持读取一张卡。
3		CIR 接收器	接收从远端控制来的信号。



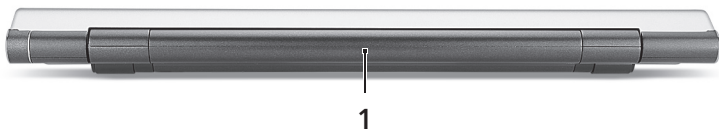



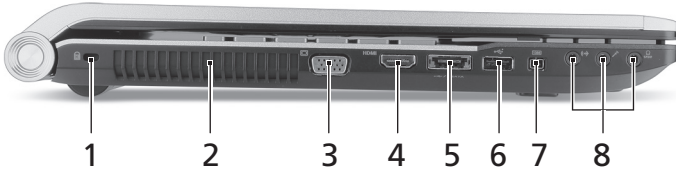

## 后视图



#	图标	项目	描述
1		电池槽	安装电池组。

## 左视图







#	图标	项目	描述
1		Kensington 安全锁插槽	连接 Kensington 兼容电脑安全锁。 <b>注：</b> 您可以将电脑锁链与不可移动的物体相连，例如：桌子或上锁的抽屉手柄。将锁插入锁孔中然后旋转钥匙便可上锁。您也可以选购不带安全锁的型号。
2		通风槽	可使电脑在长时间使用后仍保持低温。
3		外部显示器 (VGA) 端口	连接显示设备 (例如：外接显示器、LCD 投影机)。
4	HDMI	HDMI 端口	支持高清晰数字视频连接。
5		USB 2.0/eSATA 端口	连接 USB 2.0 或 eSATA 设备 (仅限部分型号)。 <b>注：</b> 如果插上 eSATA 设备，您就同时拥有三个 USB 端口。
6		USB 2.0 端口	连接 USB 2.0 设备 (例如：USB 鼠标、USB 相机)。
7		4 针 IEEE 1394 端口	连接 IEEE 1394 设备。
8		音频输入接口	连接音频输入设备 (例如：音乐 CD 播放机、立体声随身听、MP3 播放机)。
		麦克风输入插孔	连接外接麦克风。
		支持 S/PDIF 的耳机 / 扬声器 / 音频输出插孔	连接音频输出设备 (例如：扬声器、耳机)。

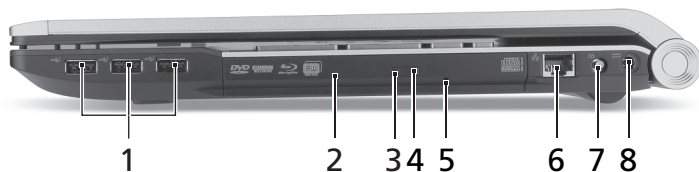





## 右视图



#	图标	项目	描述
1		USB 2.0 端口	连接 USB 2.0 设备 (例如: USB 鼠标、USB 相机)。
2		光驱	内置光驱, 可支持读取 CD 或 DVD。
3		光驱访问指示灯	当光驱被激活时指示灯会亮起。
4		光驱弹出按钮	按下此按钮可弹出光驱。
5		紧急弹出孔	当电脑关闭时, 可弹出光驱托盘。 <b>注:</b> 如果计算机关闭, 请将回形针插入紧急弹出孔, 使光驱弹出。
6		以太网 (RJ-45) 端口	连接 10/100/1000 以太网。
7		RF 输入端口	接受从数字 TV 调谐器设备送来的输入信号 (仅限部分型号)。
8		直流电源输入插孔	连接交流适配器。

## 底视图



#	图标	项目	描述
1		电池槽	安装电池组。
2		重低音	用于重低音效果输出。
3		电池释放门锁	释放电池门锁可取下电池组。
4		内存槽	安装电脑主内存的位置。
5		主硬盘槽	安装电脑硬盘的位置（用螺丝紧固）。
6		扬声器	提供立体声音频输出。
7		第二硬盘槽	安装电脑硬盘的位置（用螺丝紧固） （仅限部分型号）。
8		电池锁	可固定锁紧电池组。

## 环境

- 温度：
  - 操作时：5°C 至 35°C
  - 不操作时：-20°C 至 65°C
- 湿度（非冷凝）：
  - 操作时：20% 至 80%
  - 不操作时：20% 至 80%

# Notebook Acer

Panduan cepat

© 2010 Hak Cipta Dilindungi Undang-Undang.

Panduan Cepat Notebook Acer  
Edisi Pertama: 03/2010

Nomor model: \_\_\_\_\_

Nomor seri: \_\_\_\_\_

Tanggal pembelian: \_\_\_\_\_

Alamat pembelian: \_\_\_\_\_

# Informasi penting

Terima kasih telah memilih notebook Acer untuk memenuhi kebutuhan Anda atas komputer mobile.

## Panduan Anda

Untuk membantu Anda menggunakan notebook Acer, kami menyediakan kumpulan panduan sebagai berikut:

Pertama-tama, brosur **Untuk Pemula...** akan membantu Anda mempersiapkan konfigurasi komputer.

Buku **Panduan Pengguna Generik Seri Aspire** berisi informasi berguna yang berlaku untuk semua model dalam seri produk Aspire. Panduan ini mencakup topik-topik dasar seperti menggunakan keyboard dan, audio, dsb. Mohon dimengerti bahwa karena sifatnya, baik **Panduan Pengguna Generik** maupun **AcerSystem User Guide** yang disebutkan di bawah ini kadang-kadang mengacu pada fungsi-fungsi atau fitur-fitur yang hanya terdapat dalam model-model tertentu dalam seri ini, tetapi tidak terdapat dalam model yang telah Anda beli. Dalam panduan ini, kasus-kasus seperti itu ditandai dengan kalimat seperti "hanya untuk model-model tertentu".

**Panduan cepat** akan menjelaskan fitur dan fungsi dasar komputer baru Anda. Untuk informasi lebih lanjut tentang cara komputer ini membantu Anda agar lebih produktif, lihat **AcerSystem User Guide**. Buku Petunjuk ini berisi informasi rinci tentang topik, seperti utilitas sistem, pemulihan data, berbagai pilihan, dan cara mengatasi masalah. Buku Petunjuk ini juga berisi informasi jaminan serta peraturan umum dan informasi keselamatan untuk notebook Anda. Tersedia dalam PDF (Portable Document Format) dan diberikan sebagai kelengkapan notebook Anda. Ikuti langkah-langkah berikut ini untuk mengaksesnya:

- 1 Klik  **Start > All Programs > AcerSystem.**
- 2 Klik **AcerSystem User Guide.**



.....

**Catatan:** Adobe Reader diperlukan untuk melihat file tersebut. Jika Adobe Reader belum diinstal dalam komputer Anda, klik **AcerSystem User Guide** untuk terlebih dulu menjalankan program konfigurasi Adobe Reader. Untuk menyelesaikan penginstalan, ikuti petunjuk pada layar. Untuk petunjuk tentang cara menggunakan Adobe Reader, akses menu **Help dan Support.**







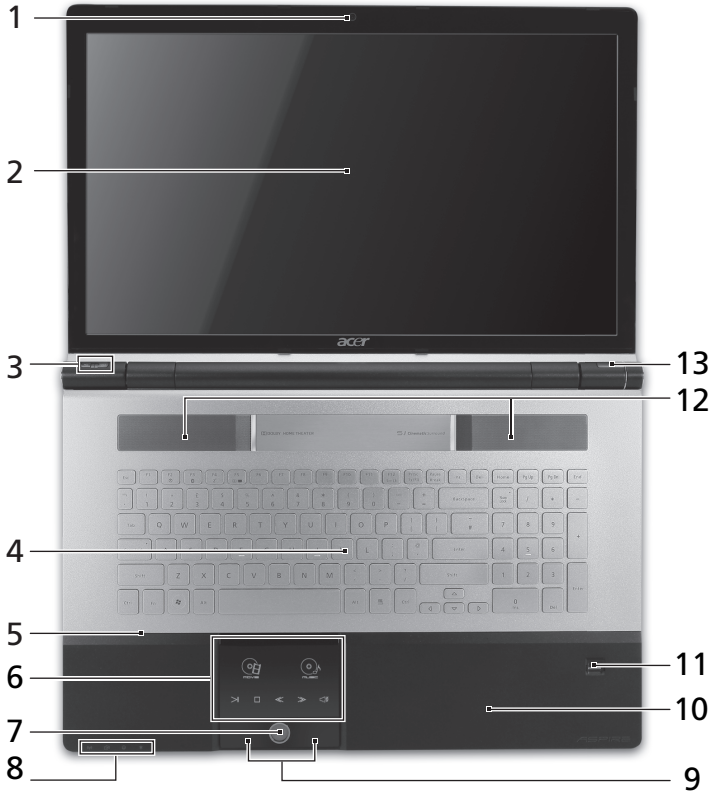



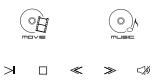











# Tur Acer notebook Anda





Setelah mempersiapkan komputer seperti pada gambar dalam brosur **Untuk Permulaan...** kami akan menunjukkan bagian-bagian notebook Acer baru Anda.

## Pandangan atas



#	Ikon	Item	Keterangan
1		Webcam Acer Crystal Eye	Kamera web untuk komunikasi video (hanya untuk model-model tertentu).
2		Layar tampilan	Disebut juga sebagai LCD (Liquid-Crystal Display), akan menampilkan output komputer (konfigurasi mungkin berbeda tergantung model).

#	Ikon	Item	Keterangan																					
3		Tombol Arcade	Luncurkan InstantOn Arcade.																					
P		Tombol P/Tombol Acer PowerSmart	Kamera web untuk komunikasi video (konfigurasi mungkin berbeda tergantung model)./ Memasukkan komputer Anda ke mode hemat daya (konfigurasi mungkin berbeda tergantung model).																					
4		Keyboard	Untuk memasukkan data ke komputer.																					
5		Mikrofon	Mikrofon internal untuk perekaman suara.																					
6		Tombol sentuh/ Konsol Media	<p>Perangkat penunjuk sensitif sentuhan yang berfungsi seperti mouse komputer*./ Kontrol yang sensitif sentuhan untuk Acer Arcade, volume (naik/turun) dan media (mainkan/jeda, berhenti, sebelumnya, berikutnya); dengan tombol senyap.</p> <table border="1"> <tbody> <tr> <td></td> <td>Film</td> <td>Luncurkan perangkat lunak pemutaran film.</td> </tr> <tr> <td></td> <td>Musik</td> <td>Luncurkan perangkat lunak pemutaran musik.</td> </tr> <tr> <td></td> <td>Putar/Jeda</td> <td>Memutar atau menjeda file media yang dipilih.</td> </tr> <tr> <td></td> <td>Berhenti</td> <td>Menghentikan pemutaran file media yang dipilih.</td> </tr> <tr> <td></td> <td>Sebelumnya</td> <td>Kembali ke file media sebelumnya.</td> </tr> <tr> <td></td> <td>Berikutnya</td> <td>Lompat ke file media berikutnya.</td> </tr> <tr> <td></td> <td>Senyap</td> <td>Mengaktifkan atau menonaktifkan volume.</td> </tr> </tbody> </table> <p>* Tombol sentuh jadi tidak aktif bila Konsol Media aktif.</p>		Film	Luncurkan perangkat lunak pemutaran film.		Musik	Luncurkan perangkat lunak pemutaran musik.		Putar/Jeda	Memutar atau menjeda file media yang dipilih.		Berhenti	Menghentikan pemutaran file media yang dipilih.		Sebelumnya	Kembali ke file media sebelumnya.		Berikutnya	Lompat ke file media berikutnya.		Senyap	Mengaktifkan atau menonaktifkan volume.
	Film	Luncurkan perangkat lunak pemutaran film.																						
	Musik	Luncurkan perangkat lunak pemutaran musik.																						
	Putar/Jeda	Memutar atau menjeda file media yang dipilih.																						
	Berhenti	Menghentikan pemutaran file media yang dipilih.																						
	Sebelumnya	Kembali ke file media sebelumnya.																						
	Berikutnya	Lompat ke file media berikutnya.																						
	Senyap	Mengaktifkan atau menonaktifkan volume.																						
7		Pengendali Konsol Media	Mengaktifkan atau menonaktifkan Konsol Media.																					



#	Ikon	Item	Keterangan
8		Tombol komunikasi	Mengaktifkan/menonaktifkan perangkat komunikasi komputer. (Perangkat komunikasi mungkin berbeda-beda berdasarkan konfigurasi.)
		Kunci cadangan	Menjalankan Acer Backup Management untuk tiga langkah pembuatan data cadangan.
		Indikator HDD <sup>1</sup>	Menunjukkan bila drive hard disk aktif.
		Indikator daya <sup>1</sup>	Menunjukkan status daya komputer.
9		Tombol klik (kiri dan kanan)	Tombol kiri dan kanan berfungsi seperti tombol mouse kiri dan kanan.
10		Tempat tangan	Tempat nyaman untuk meletakkan tangan Anda sewaktu menggunakan komputer.
11		Pembaca sidik jari Acer Bio-Protection	Mendukung fungsi kontrol 4 arah Acer FingerNav (hanya untuk model-model tertentu).
12		Pengeras suara	Menghasilkan keluaran audio stereo.
13		Tombol daya	Menghidupkan/mematikan komputer.

1. Indikator panel depan akan terlihat meskipun penutup komputer dalam keadaan tertutup.











## Tombol pintas

Komputer menggunakan tombol pintas atau kombinasi tombol untuk mengakses sebagian besar kontrol komputer, misalnya kecerahan layar dan output volume suara.

Untuk mengaktifkan tombol pintas, tekan terus tombol <Fn> sebelum menekan tombol lain pada kombinasi tombol pintas.

Tombol pintas	Ikon	Fungsi	Keterangan
<Fn> + <F3>		Tombol komunikasi	Mengaktifkan/menonaktifkan perangkat komunikasi komputer. (Perangkat komunikasi mungkin berbeda-beda berdasarkan konfigurasi.)
<Fn> + <F4>		Sleep	Mengaktifkan komputer dalam mode Sleep.



Tombol pintas	Ikon	Fungsi	Keterangan
<Fn> + <F5>		Toggle layar	Mengalihkan output tampilan antara layar tampilan, monitor eksternal (jika dipasang), dan keduanya.
<Fn> + <F6>		Layar kosong	Menonaktifkan cahaya latar layar tampilan untuk menghemat daya. Tekan tombol apa saja untuk kembali.
<Fn> + <F7>		Tombol panel sentuh	Mengaktifkan dan menonaktifkan panel sentuh internal.
<Fn> + <F8>		Tombol speaker	Mengaktifkan dan menonaktifkan speaker.
<Fn> + <D>		Kecerahan meningkat	Meningkatkan kecerahan layar.
<Fn> + <C>		Kecerahan berkurang	Mengurangi kecerahan layar.
<Fn> + <Home>		Putar/Jeda	Memutar atau menjeda file media yang dipilih.
<Fn> + <Pg Up>		Berhenti	Menghentikan pemutaran file media yang dipilih.
<Fn> + <Pg Dn>		Sebelumnya	Kembali ke file media sebelumnya.
<Fn> + <End>		Berikutnya	Lompat ke file media berikutnya.

## Pandangan depan tertutup



#	Ikon	Item	Keterangan
1		Roda kelucu	Naik atau turunkan volume.
2		Pembaca kartu Multi-in-1	Menerima Secure Digital (SD), MultiMediaCard (MMC), Memory Stick (MS), Memory Stick PRO (MS PRO), xD-Picture Card (xD). <b>Catatan:</b> Tekan untuk melepas/memasang kartu. Hanya satu kartu yang bisa beroperasi saat Anda menggunakannya.
3		Penerima CIR	Menerima sinyal dari remote control.

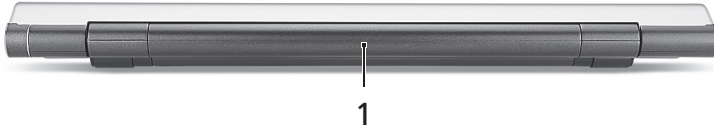

## Tampilan belakang





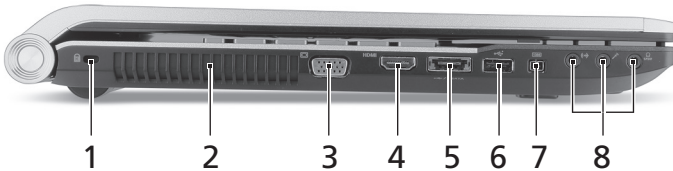

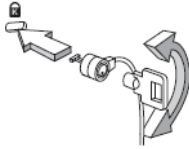

#	Ikon	Item	Keterangan
1		Tempat baterai	Tempat kemasan baterai komputer.

## Pandangan kiri





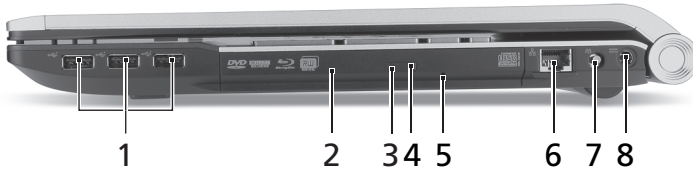

#	Ikon	Item	Keterangan
1		Slot kunci Kensington 	Menghubungkan ke kunci keamanan komputer yang kompatibel dengan kunci Kensington. <b>Catatan:</b> Lilitkan kabel kunci keamanan komputer ke benda sekitar yang tidak dapat bergerak, misalnya, meja atau gagang laci yang terkunci. Masukkan kunci ke dalam lubang, kemudian putar kunci untuk menguncinya. Beberapa model tanpa kunci juga tersedia.
2		Slot ventilasi	Membuat komputer tetap dingin, bahkan setelah pemakaian yang lama.
3		Port tampilan (VGA) eksternal	Menghubungkan perangkat tampilan (mis., monitor eksternal, proyektor LCD).
4	HDMI	Port HDMI	Mendukung koneksi video digital definisi tinggi.

#	Ikon	Item	Keterangan
5	 /e SATA	Port USB 2.0/ eSATA	Menyambung ke perangkat USB 2.0 atau eSATA (hanya untuk model-model tertentu). <b>Catatan:</b> Sementara itu jika Anda menghubungkan perangkat eSATA, Anda akan mempunyai 3 USB port yang tersedia.
6		Port USB 2.0	Menghubungkan ke perangkat USB 2.0 (mis., mouse USB, kamera USB).
7		Port IEEE 1394 4 pin	Menghubungkan ke perangkat IEEE 1394.
8		Soket sambungan masuk	Menerima perangkat sambungan masuk audio (misalnya, Pemutar CD, walkman stereo, pemutar mp3).
		Jack mikrofon-in	Menerima input dari mikrofon eksternal.
		Port headphone/ speaker/saluran output dengan dukungan S/PDIF	Menghubungkan ke perangkat sambungan keluar audio (misalnya, speaker, headphone).







## Pandangan kanan



#	Ikona	Item	Keterangan
1		Port USB 2.0	Menghubungkan ke perangkat USB 2.0 (mis., mouse USB, kamera USB).
2		Drive optik	Drive optik internal; menerima CD atau DVD.
3		Indikator akses disket optik	Menyala saat drive optik aktif.
4		Tombol pelepas drive optik	Mengeluarkan disk optik dari drive.
5		Lubang pelepas darurat	Melepas tempat drive optik saat komputer mati. <b>Catatan:</b> Masukkan klip kertas ke lubang pengeluaran darurat untuk mengeluarkan tray drive optik bila komputer mati.
6		Port Ethernet (RJ-45)	Menghubungkan ke jaringan berbasis Ethernet 10/100/1000.
7		Port RF-in	Menerima sinyal input dari perangkat TV-tuner digital (hanya untuk model-model tertentu).
8		Jack DC-in	Menghubungkan ke Adaptor AC.

## Tampilan bawah



#	Ikun	Item	Keterangan
1		Tempat baterai	Tempat kemasan baterai komputer.
2		Subwoofer	Mengeluarkan output bunyi dengan frekuensi rendah.
3		Penutup pelepas baterai	Untuk melepaskan baterai.
4		Kompartemen memori	Untuk memasang memori utama komputer.
5		Bay hard disk-Utama	Untuk memasang hard disk komputer (dipasang dengan sekrup).
6		Pengeras suara	Menghasilkan keluaran audio stereo.
7		Bay hard disk-Sekunder	Untuk memasang hard disk komputer (dipasang dengan sekrup) (hanya untuk model-model tertentu).
8		Kunci baterai	Mengunci baterai pada tempatnya.

## Lingkungan

---

- Suhu:
    - Beroperasi: 5°C hingga 35°C
    - Tidak beroperasi: -20°C hingga 65°C
  - Kelembaban (non-kondensasi):
    - Beroperasi: 20% hingga 80%
    - Tidak beroperasi: 20% hingga 80%
-

โน้ตบุ๊ก Acer

คู่มืออย่างย่อ

© 2010 สงวนลิขสิทธิ์

คู่มือฉบับย่อโน้ตบุ๊ก Acer  
คนฉบับ: 03/2010

หมายเลขรุ่น: \_\_\_\_\_

ซีรียลนัมเบอร์: \_\_\_\_\_

วันที่ซื้อ: \_\_\_\_\_

สถานที่ซื้อ: \_\_\_\_\_



# สิ่งสำคัญอันดับแรก

ขอขอบคุณที่คุณเลือกโน้ตบุ๊กจาก Acer เพื่อรองรับการใช้งานแบบพกพาของคุณ

## คู่มือสำหรับคุณ

เพื่อช่วยสอนการใช้โน้ตบุ๊ก Acer เราจึงได้จัดทำคู่มือชุดนี้ขึ้น

เริ่มจากไปเสเตอร์ **ข้อมูลสำหรับผู้เริ่มต้นใช้งาน** เพื่อแนะนำเกี่ยวกับการติดตั้งคอมพิวเตอร์เบื้องต้น

**คู่มือผู้ใช้ทั่วไปสำหรับโน้ตบุ๊กรุ่น Aspire** ประกอบไปด้วยข้อมูลที่เป็นประโยชน์สำหรับผลิตภัณฑ์ตระกูล Aspire ทุกรุ่น โดยระบุรายการทำงานเบื้องต้นต่าง ๆ เช่น การใช้คีย์บอร์ด ระบบเสียง ฯลฯ

เนื่องจากการจัดทำคู่มือแบบครอบคลุมรวม **คู่มือผู้ใช้ทั่วไป** และ **AcerSystem User Guide** ซึ่งจะกล่าวถึงต่อไปนี้อาจมีฟังก์ชันหรือคุณสมบัติต่าง ๆ ที่มีอยู่เฉพาะในผลิตภัณฑ์บางรุ่นเท่านั้น ซึ่งอาจไม่รวมถึงผลิตภัณฑ์รุ่นที่คุณจัดซื้อ กรณีเช่นนี้จะมีแจ้งให้ทราบโดยระบุเป็นข้อความต่าง ๆ เช่น “เฉพาะบางรุ่นเท่านั้น”

**คู่มืออย่างย่อ** เป็นข้อมูลคุณสมบัติและฟังก์ชันเบื้องต้นในคอมพิวเตอร์เครื่องใหม่ของคุณ สอบถามข้อมูลการใช้งานคอมพิวเตอร์เพื่อให้เกิดประสิทธิภาพสูงสุดได้จาก **AcerSystem User Guide** คู่มือชุดนี้ประกอบไปด้วยข้อมูลโดยละเอียดในเรื่องต่าง ๆ เช่น ยูทิลิตี้ การเรียกคืนข้อมูล การติดตั้งส่วนประกอบเพิ่มเติมและการแก้ไขปัญหา นอกจากนี้ยังมีข้อมูลการรับประกัน หลักเกณฑ์ทั่วไปและข้อมูลด้านความปลอดภัยสำหรับโน้ตบุ๊กของคุณ แฟ้มข้อมูลจัดทำเป็นไฟล์ Portable Document Format (PDF) ซึ่งติดตั้งสำเร็จในโน้ตบุ๊กของคุณ เรียกค้นได้โดยทำตามขั้นตอนต่อไปนี้

- 1 คลิกที่  **Start > All Programs > AcerSystem**
- 2 คลิกที่ **AcerSystem User Guide**











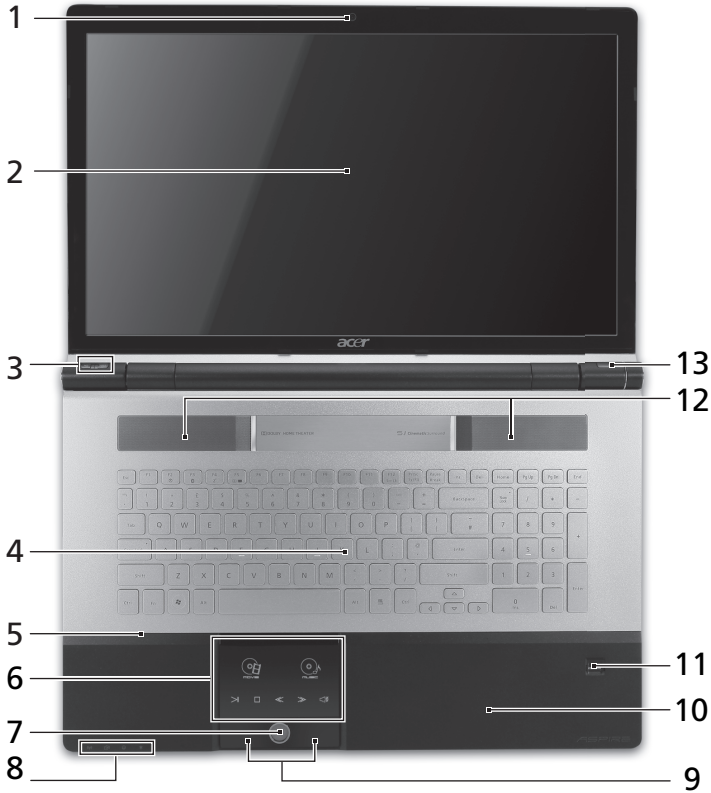

**หมายเหตุ:** คุณต้องมี Adobe Reader เพื่อเปิดดูไฟล์ ในกรณีที่ไม่มีได้ติดตั้ง Adobe Reader ไว้ในคอมพิวเตอร์ กรุณาคลิกที่ **AcerSystem User Guide** จากนั้นโปรแกรมติดตั้ง Adobe Reader จะเปิดขึ้น ทำตามคำแนะนำบนหน้าจอเพื่อดำเนินการติดตั้งให้เสร็จสิ้น ดูคำแนะนำในการใช้ Adobe Reader ได้จากเมนู **Help and Support**

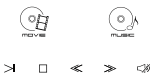



## แนะนำเกี่ยวกับโน้ตบุ๊ก Acer ของคุณ

หลังจากตั้งค่าคอมพิวเตอร์ของคุณตามภาพประกอบในโปสเตอร์ สำหรับผู้เริ่มใช้ ขอให้เราได้พาคคุณชมโน้ตบุ๊ก Acer ของคุณอย่างทั่วถึง

### มุมมองด้านบน



#	ไอคอน	รายการ	คำอธิบาย
1		เว็บแคม Acer Crystal Eye	กล้องเว็บแคมสำหรับการสื่อสารผ่านทางวิดีโอ (เฉพาะบางรุ่นเท่านั้น)
2		จอแสดงผล	หรือที่เรียกว่า Liquid-Crystal Display (LCD) ซึ่งใช้แสดงข้อมูลต่างๆ ของคอมพิวเตอร์ (ส่วนประกอบอาจแตกต่างกันไปตามรุ่น)
3		ปุ่ม Arcade	เรียกใช้ InstantOn Arcade
	P	ปุ่ม P/ ปุ่ม Acer PowerSmart	ปุ่มแบบกำหนดการทำงานเองได้ (การกำหนดค่าอาจแตกต่างกันไปในแต่ละรุ่น)/ สั่งการคอมพิวเตอร์เข้าสู่โหมดประหยัดพลังงาน (การกำหนดค่าอาจแตกต่างกันไปในแต่ละรุ่น)
4		คีย์บอร์ด	เพื่อป้อนข้อมูลเข้าสู่คอมพิวเตอร์ของคุณ
5		ไมโครโฟน	ไมโครโฟนในตัวสำหรับการบันทึกเสียง
6		ทัชแพด/ มีเดียคอนโซล	อุปกรณ์เข้าตำแหน่งแบบสัมผัส ซึ่งทำงานแบบเดียวกับเมาส์คอมพิวเตอร์* / ควบคุมการสัมผัสสำหรับ Acer Arcade, ระดับเสียง (ขึ้น/ลง) และมีเดีย (เล่น/หยุดชั่วคราว, หยุด, ก่อนหน้า, ถัดไป); ด้วยปุ่มปิดเสียง
		Movie	เรียกซอฟต์แวร์เล่นภาพยนตร์ (ภาพยนตร์)
		Music (เพลง)	เรียกซอฟต์แวร์เล่นเพลง
		เล่น/หยุดเล่น	เล่นหรือหยุดเล่น ไฟล์มีเดียชั่วคราว
		หยุด	หยุดการเล่นไฟล์มีเดีย
		ก่อนหน้า	กลับสู่ไฟล์มีเดียก่อนหน้า
		ถัดไป	ไปสู่ไฟล์มีเดียถัดไป
		ปิดเสียง	เปิดหรือปิดระดับเสียง
			* ทัชแพดจะไม่สามารถใช้งานได้เมื่อใช้งานมีเดียคอนโซล
7		ตัวควบคุมมีเดียคอนโซล	เปิดหรือปิดมีเดียคอนโซล

#	ไอคอน	รายการ	คำอธิบาย
8		ปุ่มการสื่อสาร	เปิด/ปิด อุปกรณ์สื่อสารของคอมพิวเตอร์ (อุปกรณ์สื่อสารอาจแตกต่างกันในแต่ละรุ่น)
		ปุ่มสำรองข้อมูล	เรียกใช้ Acer Backup Management เพื่อสำรองข้อมูลแบบสามขั้นตอน
		ตัวแสดงสถานะ HDD <sup>1</sup>	แสดงเมื่อฮาร์ดดิสก์ไดรฟ์มีการทำงาน
		ไฟแสดงสถานะพลังงาน <sup>1</sup>	ระบุสถานะการเปิดใช้งานคอมพิวเตอร์
9		ปุ่มคลิก (ซ้ายและขวา)	ปุ่มซ้ายและขวาทำงานเหมือนกับปุ่มเมาส์ซ้ายและขวา
10		ที่วางมือ	พื้นที่รองรับมือเพื่อให้รู้สึกสบายขณะใช้คอมพิวเตอร์
11		ระบบอ่านลายนิ้วมือ Acer Bio-Protection	สนับสนุนฟังก์ชันการควบคุมด้วย Acer FingerNav 4-way (เฉพาะบางรุ่นเท่านั้น)
12		ลำโพง	เอาท์พุทสเตอริโอ
13		ปุ่มเปิดปิด	เปิดและปิดคอมพิวเตอร์

1. สัญลักษณ์ที่แผงด้านหน้าสามารถมองเห็นได้แม้ขณะปิดฝาพับคอมพิวเตอร์

## ปุ่มลัด

คอมพิวเตอร์จะมีคีย์ลัดหรือชุดแป้นกดเพื่อเข้าใช้งานส่วนควบคุมต่าง ๆ ของคอมพิวเตอร์ เช่น ความสว่างของหน้าจอและระดับเสียง

เพื่อเปิดใช้งานฮอตคีย์ ให้กดปุ่ม <Fn> ค้างเอาไว้ก่อนที่จะกดปุ่มอื่นในชุดฮอตคีย์

ฮอตคีย์	ไอคอน	ฟังก์ชัน	คำอธิบาย
<Fn> + <F3>		ปุ่มการสื่อสาร	เปิด/ปิด อุปกรณ์สื่อสารของคอมพิวเตอร์ (อุปกรณ์สื่อสารอาจแตกต่างกันในแต่ละรุ่น)
<Fn> + <F4>		สลีป	ตั้งคอมพิวเตอร์ให้อยู่ในโหมดสลีป
<Fn> + <F5>		สลัจอแสดงผล	สลัเอาที่พู่จอแสดงผลระหว่างหน้าจอแสดงผล, จอแสดงผลภายนอก (หากเชื่อมต่ออยู่) และทั้งสองชนิด
<Fn> + <F6>		หน้าจอว่าง	ปิดไฟพื้นหลังจอแสดงผลเพื่อประหยัดพลังงาน กดปุ่มใดก็ได้เพื่อเปิดหน้าจอกลับมาอีกครั้ง
<Fn> + <F7>		เปิดปิดการใช้งานทัชแพด	เปิดและปิดทัชแพดบนเครื่อง
<Fn> + <F8>		เปิดปิดลำโพง	เปิดและปิดลำโพง
<Fn> + <▷>		เพิ่มความสว่าง	เพิ่มความสว่างของหน้าจอ
<Fn> + <◁<		ลดความสว่าง	ลดความสว่างของหน้าจอ
<Fn> + <Home>		เล่น/หยุดเล่น	เล่นหรือหยุดเล่นไฟล์มีเดียชั่วคราว
<Fn> + <Pg Up>		หยุด	หยุดการเล่นไฟล์มีเดีย
<Fn> + <Pg Dn>		ก่อนหน้า	กลับสู่ไฟล์มีเดียก่อนหน้า
<Fn> + <End>		ถัดไป	ไปสู่อไฟล์มีเดียถัดไป

## ปิดมุมมองด้านบน



#	ไอคอน	รายการ	คำอธิบาย
1		ทัมป์รีล	เพิ่มหรือลดระดับเสียง
2	    	การติดตั้งมัลติมีเดีย	สามารถใช้งานร่วมกับ Secure Digital (SD), MultiMediaCard (MMC), Memory Stick (MS), Memory Stick PRO (MS PRO), xD-Picture Card (xD) <b>หมายเหตุ:</b> กดเพื่อกด/ใส่การ์ด ใช้งานการ์ดได้ครั้งละหนึ่งชุดเท่านั้น
3		อุปกรณ์รับสัญญาณ CIR	ใช้รับสัญญาณจากรีโมทคอนโทรล



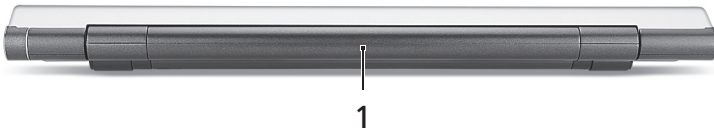

## มุมมองด้านหลัง

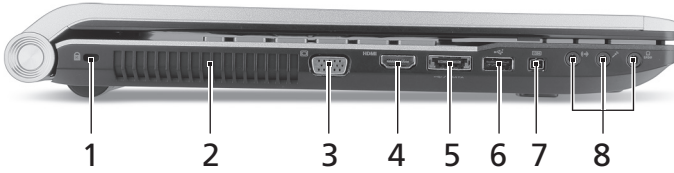

#	ไอคอน	รายการ	คำอธิบาย
1		ช่องใส่แบตเตอรี่	ใช้สำหรับเก็บแพ็คแบตเตอรี่ของคอมพิวเตอร์

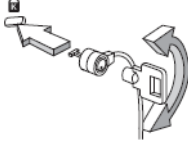



## มุมมองด้านหลัง

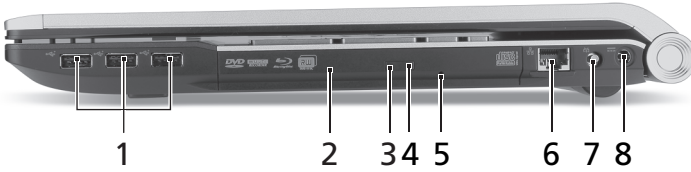

#	ไอคอน	รายการ	คำอธิบาย
1		สล๊อตล็อก Kensington 	พ่วงต่อกับระบบล็อกความปลอดภัยสำหรับคอมพิวเตอร์ที่ใช้งานได้กับ Kensington <b>หมายเหตุ:</b> คล่องสายล็อกป้องกันคอมพิวเตอร์กับส่วนประกอบที่ยึดตาย เช่น โตะ มือจับหรือลิ้นชักที่ล็อกอยู่ ใส่ตัวล็อกลงในร่องบากและหมุนตัวล็อกไปยังตำแหน่งล็อก ในบางรุ่นอาจไม่มีระบบล็อกนี้
2		ช่องระบายอากาศ	ช่วยให้คอมพิวเตอร์เย็น แม้อหลังจากใช้งานเป็นเวลานาน
3		พอร์ตจอแสดงผลต่อพ่วง (VGA)	เชื่อมต่อกับจอแสดงผล (เช่น จอภาพภายนอก, โปรเจคเตอร์ LCD)
4	HDMI	พอร์ต HDMI	รองรับการเชื่อมต่อระบบวิดีโอดิจิทัลความละเอียดสูง
5	 /e SATA	พอร์ต USB 2.0/eSATA	ใช้เชื่อมต่อกับอุปกรณ์ USB 2.0 หรือ eSATA (สำหรับบางรุ่น) <b>หมายเหตุ:</b> หากคุณเสียบอุปกรณ์ eSATA คุณจะเหลือพอร์ต USB สามพอร์ตให้ใช้งาน
6		พอร์ต USB 2.0	ต่ออุปกรณ์ USB 2.0 (เช่น เมาส์หรือกล้อง USB)
7		พอร์ต IEEE 1394 4 พิน	เชื่อมต่ออุปกรณ์ IEEE 1394
8		ช่องต่อ line-in	ใช้สำหรับต่ออุปกรณ์ line-in (เช่น เครื่องเล่นซีดีเพลง สเตอริโอวอล์คแมน เครื่องเล่น MP3)
		แจ๊คเสียบไมโครโฟน	ใช้สำหรับต่อไมโครโฟน
		ช่องเสียบหูฟัง/ลำโพง/line-out รองรับ S/PDIF	ใช้สำหรับต่ออุปกรณ์เสียงขาออก (เช่น ลำโพง ชุดหูฟัง)

## มุมมองด้านขวา







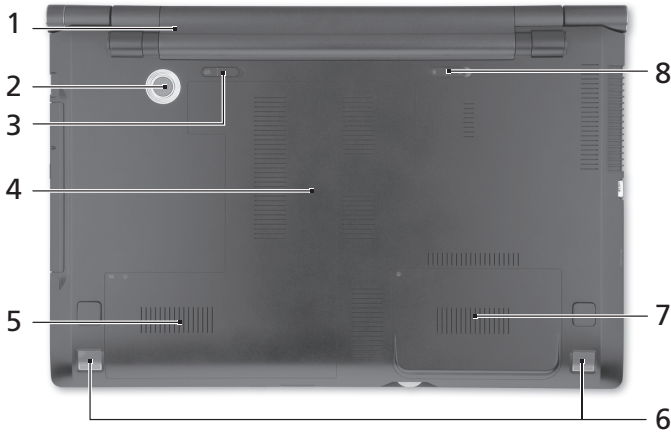

#	ไอคอน	รายการ	คำอธิบาย
1		พอร์ต USB 2.0	ต่ออุปกรณ์ USB 2.0 (เช่น เม้าส์หรือคีย์บอร์ด USB)
2		ไดรฟ์ออปติคัล	ไดรฟ์ออปติคัลภายใน สำหรับใส่ CD หรือ DVD
3		ไฟแสดงการอ่านออปติคัลดิสก์	ติดสว่างเมื่อมีการอ่านแผ่นออปติคัล
4		ปุ่มกดแผ่นออปติคัลออก	นำแผ่นออปติคัลออกจากไดรฟ์
5		ปุ่มนำแผ่นออกจุกเงิน	ใช้เปิดถาดใส่แผ่นออปติคัลขณะปิดคอมพิวเตอร์ <b>หมายเหตุ:</b> สอดคีย์ปิ่นมีกระดากเข้าไปในช่องนำแผ่นออกจุกเงิน เพื่อเปิดถาดใส่แผ่นออปติคัลขณะปิดคอมพิวเตอร์อยู่
6		พอร์ต Ethernet (RJ-45)	เชื่อมต่อเครือข่าย Ethernet 10/100/1000
7		พอร์ต RF-in	รองรับสัญญาณจากอุปกรณ์ทีวีจูนเนอร์ดิจิทัล (เฉพาะบางรุ่นเท่านั้น)
8		ช่องเสียบ DC-in	เชื่อมต่อกับอะแดปเตอร์ AC



## มุมมองด้านล่าง



#	ไอคอน	รายการ	คำอธิบาย
1		ช่องใส่แบตเตอรี่	ใช้สำหรับเก็บแป๊ตเตอรี่ของคอมพิวเตอร์
2		ขั้วพุ่มเฟอร์	ใส่กระจายเสียงความถี่ต่ำ
3		สลักปลดล๊อคแบตเตอรี่	ปลดล๊อคเพื่อนำแบตเตอรี่ออก
4		ช่องหน่วยความจำ	ที่อยู่ของหน่วยความจำของคอมพิวเตอร์
5		ช่องติดตั้งฮาร์ดดิสก์ยูนิตตัวหลัก	ที่อยู่ของฮาร์ดดิสก์ของคอมพิวเตอร์ (ยึดติดแน่นด้วยน๊อต)
6		ลำโพง	เอาท์พุทสเตอริโอ
7		ช่องติดตั้งฮาร์ดดิสก์ยูนิตที่สอง	ใส่ฮาร์ดดิสก์คอมพิวเตอร์ (ยึดโดยใช้สกรู) (เฉพาะบางรุ่นเท่านั้น)
8		ล๊อคแบตเตอรี่	ล๊อคแบตเตอรี่ให้อยู่ในตำแหน่ง

## สิ่งแวดล้อม

---

- อุณหภูมิ:
    - ขยะทำงาน: 5°C ถึง 35°C
    - ขยะไม่ได้ใช้งาน: -20°C ถึง 65°C
  - ความชื้น (ไม่ควบนั่นเป็นไอน้ำ):
    - ขยะทำงาน: 20% ถึง 80%
    - ขยะไม่ได้ใช้งาน: 20% ถึง 80%
-